



# GEN-2 POWERCODE INSTALLATION & TECHNICAL REFERENCE MANUAL



LINCOLN  
Mercury

**WARNING! REMOTE START SYSTEMS ARE ONLY APPLICABLE TO VEHICLES WITH AUTOMATIC TRANSMISSION!**

**BOTH ORIGINAL KEYS ARE REQUIRED FOR ALL REMOTE START SYSTEMS ON VEHICLES EQUIPPED WITH SECURILOCK!**

EXPERT FITMENT REQUIRED

Subject to Change Without Notice

**ALL MODELS 2007** 



**Technical Support  
(800) FORD-KEY  
For French Technical Support  
Rock Hebert (514) 973-2846**



Use Caution -  
Personal Injury



Use Caution -  
Vehicle Damage



See shop manual



Important note

## TOOLS REQUIRED

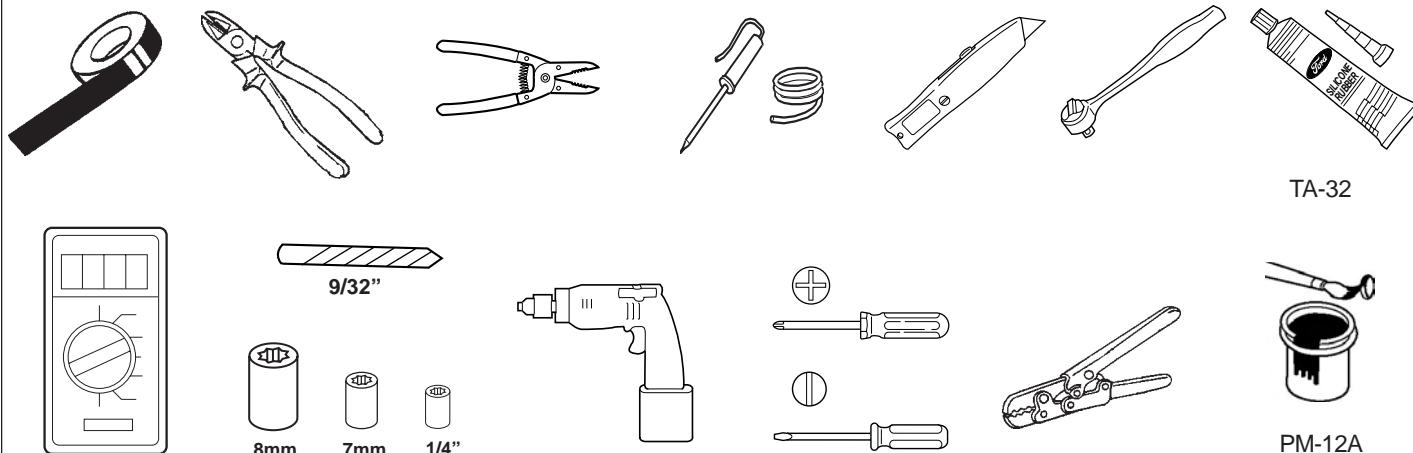

# TABLE OF CONTENTS

READ ME FIRST .....	3
VEHICLE SPECIFIC WIRING DIAGRAMS INFORMATION .....	4
KIT CONTENTS .....	5
PARTS BAG CONTENTS .....	6
KIT BILL OF MATERIALS LISTS .....	7
MODULE PREPARATION .....	9
VEHICLE PREPARATION .....	11
DIPOLE ANTENNA MOUNTING .....	12
STATUS LED .....	13
SECURILOCK INTERFACE KIT - 7L2Z-19G365-AA .....	14
HOOD TILT SWITCH INSTALLATION .....	15
MOUNTING THE CONTROL MODULE .....	16
SYSTEM WIRING CONNECTIONS .....	17
WARNING LABEL INSTALLATION .....	17
SYSTEM PROGRAMMING INSTRUCTIONS .....	18
OPTION PROGRAMMING (VSS) .....	18
OPTION CHART (VSS) .....	19
SHOCK SENSOR SETTING (VSS) .....	20
TRANSMITTER PROGRAMMING (RMST & RKE/VSS/RMST) .....	21
OPTION PROGRAMMING (RKE/VSS/RMST) .....	22
OPTION CHART (RKE/VSS/RMST) .....	23
SHOCK SENSOR SETTING (RKE/VSS/RMST) .....	25
TACH (IDLE SPEED) PROGRAMMING (RKE/VSS/RMST) .....	26
PROGRAMMING THE PIK (RKE/VSS/RMST) .....	27
OPTION PROGRAMMING (RMST) .....	28
OPTION CHART (RMST) .....	29
TACH (IDLE SPEED) PROGRAMMING (RMST) .....	30
PROGRAMMING THE PIK (RMST) .....	31
FUNCTIONAL TEST .....	32
PC-14 WIRING HARNESS LEGEND .....	33
PC-34 WIRING HARNESS LEGEND .....	34
CIRCUIT TESTING - IDENTIFYING CIRCUIT POLARITY .....	35
WIRE CONNECTION PROCEDURES .....	36

# READ ME FIRST

For convenience this document uses short names when referring to a particular system or kit. The list below identifies the short names used herein:

Remote Start System with Deluxe Vehicle Security and Keyless Entry → **RKE/VSS/RMST** (GOLD)

Remote Start System → **RMST** (BRONZE)

Vehicle Security System for Vehicles Equipped with Factory Keyless Entry → **VSS** (ROGUE)

Navigating this document can be accomplished by: 1) using the ◀ ▶ buttons in the Acrobat toolbar, or 2) clicking on the bookmark links in the bookmark pane to the left. (Clicking on the (+) symbols next to a bookmark will expand that bookmark, revealing additional selections).

The most current version of this document can be accessed at <http://accessories.mcdistributor.dealerconnection.com>, [www.inford.com](http://www.inford.com), and/or [www.fmcdealer.com](http://www.fmcdealer.com). As new/updated material becomes available, this document will be updated and posted on those sites.

This installation instruction covers the installation of all PowerCode based Convenience/Security and Remote start kits, therefore follow only the steps that apply to the kit that you are installing. For example, the Securilock interface kits are only used on systems that include remote start (RMST). Therefore, if you are installing a security only kit (VSS), skip the steps pertaining to the Securilock interface kit.

Vehicle wiring is subject to change. All possible efforts have been taken to ensure that the information contained herein is accurate as of the revision dates indicated. As such, it is critical that vehicle circuits are tested prior to making any connections, to ensure that the proper vehicle circuit has been located.



Prior to beginning this installation it is recommended that you lower the drivers door window to prevent locking the keys in the vehicle.

The installation instructions are presented in three sections. The first section (which begins immediately following this page) contains installation instructions for the systems various components and tips for prepping the systems wiring harnesses. These steps are presented in a generic format. The procedures for these installation steps are basically the same regardless of the model vehicle or system that you are working on. The drawings depicted in this section are for reference only and may not reflect the vehicle on which you may be working.

The second (reference) section contains the system option programming charts and various other reference type information. The last section represents vehicle specific wiring diagrams for each application. Within the wiring section for each vehicle, there are separate wiring diagrams for each different system. The vehicle specific wiring drawings are arranged in the following order:

1. Fuse placement and vehicle specific programming requirements - 1 page;
2. RKE/VSS/RMST - Typically 5 pages;
3. RMST - Typically 3 pages;
4. VSS - Typically 2 pages;

Prior to beginning your first installation of this product it is recommended that you:

1. Thoroughly review and print out the first section;
2. Skim through the reference section to become acquainted with the additional information that is available.

Then, go through the installation print out in the vehicle specific wiring sections and use as a reference during the installation.

**NOTE: The wiring sections for all vehicles are located in two separate files (Cars and Trucks), which is also found on the same websites as this Base instruction.**

# VEHICLE SPECIFIC WIRING DIAGRAM INFORMATION

1

Vehicle/Product specific wiring diagrams are provided for all systems in two additional documents/files on the Ford websites, Cars and Trucks. The diagrams are organized by vehicle (Year/Model) and by Product. For example, to find a specific wiring diagram for installing a RKE/VSS/RMST system in a 2007 F-150:







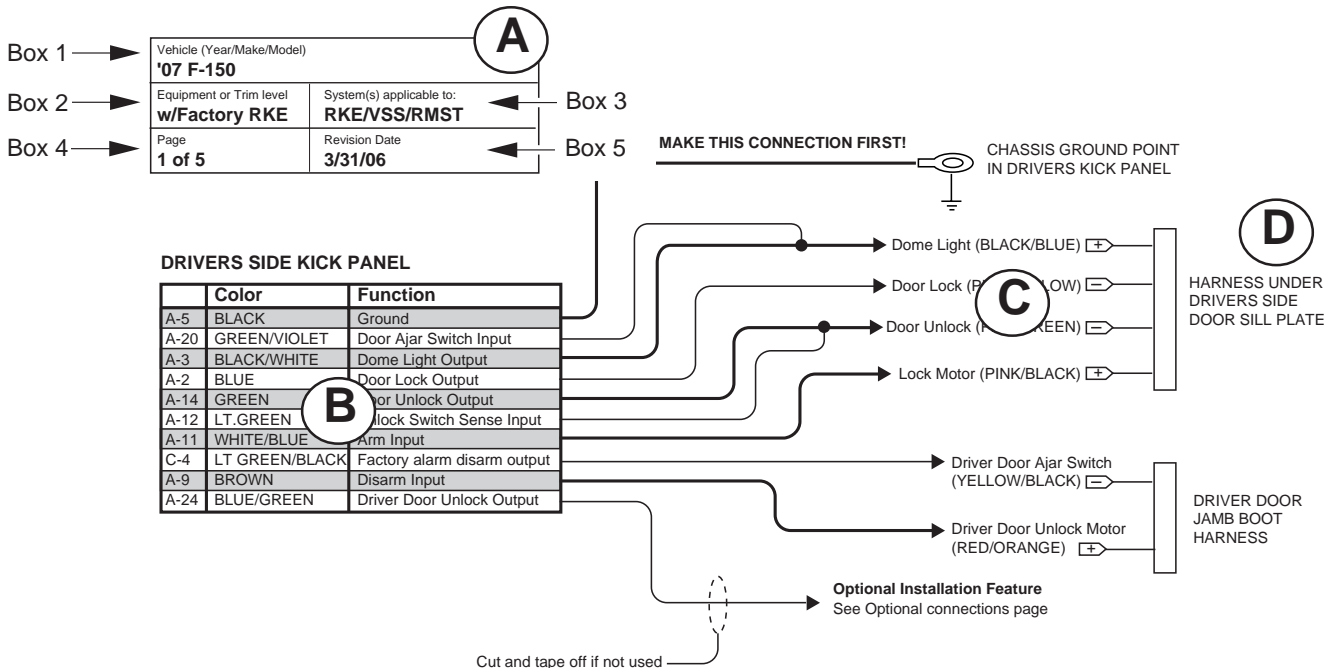

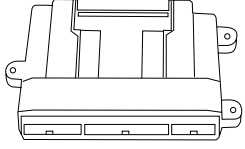
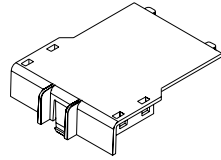
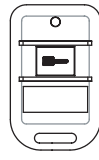

1. In the Bookmarks pane, click on the "+" symbol to the left of the bookmark for "2007MY".
2. Click on the "+" symbol to the left of the bookmark for "F-150".
3. Select the system that you are installing in the links revealed under F-150.
4. Then using the ◀ ▶ buttons in the Acrobat toolbar, you can view the individual pages in the drawing.

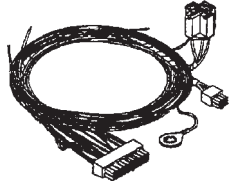
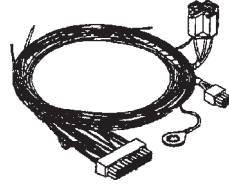
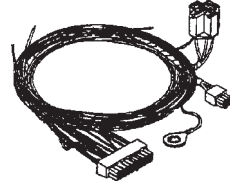
2

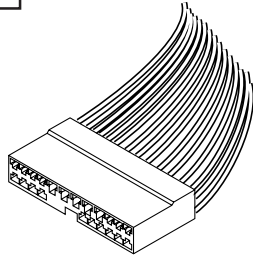
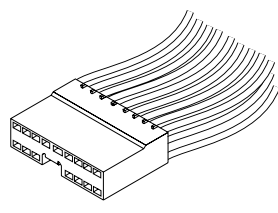
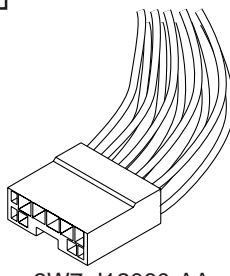

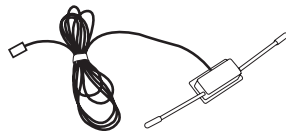
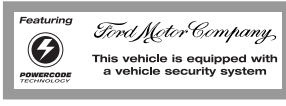

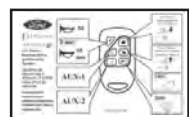

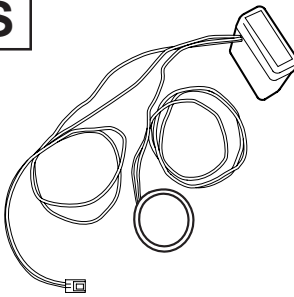

- (A) Title block:
- Box 1: Lists applicable vehicle(s) by year/make/model;
- Box 2: Lists any vehicle trim level or special equipment required on the vehicle. This will generally be: ALL, w/Factory RKE or w/o Factory RKE. Note: If you are working on a vehicle with factory RKE, a drawing that lists "w/o RKE" in this box does not apply to this installation. Conversely, if you are working on a vehicle without factory RKE, disregard the drawings listing "w/Factory RKE" in this box.;
- Box 3: Lists the system or systems covered by this drawing (System name --> Short name used in title block);
- Remote Start System with Deluxe Vehicle Security and Keyless Entry —> RKE/VSS/RMST
  - Remote Start System —> RMST
  - Vehicle Security System for Vehicles Equipped with Factory Keyless Entry —> VSS
- Box 4: Page number and total number of pages which make up the complete drawing;
- Box 5: Revision date of drawing.
- (B) Lists the systems wires by Connector/Terminal, Wire color, and function.
- (C) Lists the vehicle circuit by the vehicle wire color and circuit polarity - Circuit name (wire color) ⊕ or ⊖ (indicates vehicle's circuit polarity).
- (D) List the circuit location in the vehicle. Clicking on the text will open another window showing a color photograph of the circuit location in the vehicle (internet connection required).

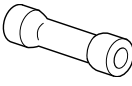

# KIT CONTENTS

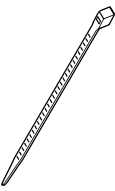
<p><b>A</b></p>  <p>PC-14 - 7L2J-19G367-AA PC-34 - 7L3J-19G367-AA</p>	<p><b>B</b></p>  <p>RKE/VSS/RMST - 7L3J-19A498-AA RMST - 7L2J-19A498-AA VSS - 7L3J-19A498-BA</p>	<p><b>C</b></p>  <p>7L2J-15K601-AA</p>	<p><b>D</b></p>  <p>7L3J-15K601-AA</p>
<p><b>E</b></p>  <p>TYPE "A" 7L2J-14B504-AA</p>	<p><b>F</b></p>  <p>TYPE "B" 7L5J-14B504-AA</p>	<p><b>G</b></p>  <p>TYPE "C" 7W3J-14B504-AA</p>	<p><b>H</b></p> 
<p><b>I</b></p>  <p>2W7J-19A205-AA</p>	<p><b>J</b></p>  <p>2W7J-19A206-AA</p>	<p><b>K</b></p>  <p>2W7-J12060-AA</p>	<p><b>L</b></p> 
<p><b>M</b></p>  <p>2W7J-19G366-AA</p>	<p><b>N</b></p>  <p>2W7J15603-AA</p>	<p><b>O</b></p>  <p>Featuring <i>Ford Motor Company</i> POWERCODE TECHNOLOGY This vehicle is equipped with a vehicle security system</p>	<p><b>P</b></p>  <p><b>WARNING / AVERTISSEMENT</b> This vehicle is equipped with a remote controlled engine starter. To reduce the risk of serious injury or death, switch engine starter system into service mode and disconnect the vehicle battery before performing any service on the vehicle. Ce véhicule est doté d'un démarreur à distance. Pour réduire les risques de blessure grave ou mortelles, mettre le démarreur à distance en mode service et débrancher la batterie du véhicule avant d'effectuer des travaux d'entretien sur celui-ci.</p>
<p><b>Q</b></p> 	<p><b>R</b></p>  <p>Owner's Manual Manual del propietario Guide de l'utilisateur</p>	<p><b>S</b></p>  <p>7L2Z-19G365-AA</p>	

# PARTS BAG CONTENTS

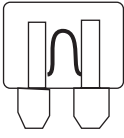
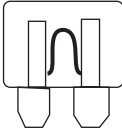
<b>T</b>  750 OHM   1X	<b>U</b>  1800 OHM   1X	<b>V</b>    2X	<b>W</b>    6X
<b>X</b>    2X	<b>Y</b>    5X	<b>Z</b>    10X	<b>AA</b>    1X
<b>BB</b>    2X	<b>CC</b>    7X	<b>DD</b> FUSE BAG CONTENTS  5A   1X	<b>EE</b>  15A   PC-14 - 4X PC-34 - 7X

NOTE: Part bag contents are not available as service items

**7L2Z-19G364-AA****Remote Start System Kit (RMST) - TYPE "A"**

REF	DESCRIPTION	QTY
A	PC-14 MODULE ASSEMBLY	1
B	RMST DNAASSEMBLY	1
C	1 BUTTON POWERCODE TRANSMITTER	2
E	TYPE "A" CUSTOM WIRING HARNESS	1
N	DIPOLE ANTENNA	1
M	HOOD SAFETY SWITCH ASSEMBLY	1
T - CC	INSTALLATION PARTS BAG	1
DD, EE	FUSE PARTS BAG	1
R	OPERATORS INSTRUCTION	1
Q	OPERATORS QUICK REFERENCE WALLET CARD	1
P	UNDERHOOD WARNING LABEL	1
S	PIK-4 PATS INTERFACE KIT	1

**7L5Z-19G364-AA****Remote Start System Kit (RMST) - TYPE "B"**

REF	DESCRIPTION	QTY
A	PC-34 MODULE ASSEMBLY	1
B	RMST DNAASSEMBLY	1
C	1 BUTTON POWERCODE TRANSMITTER	2
F	TYPE "B" CUSTOM WIRING HARNESS	1
N	DIPOLE ANTENNA	1
M	HOOD SAFETY SWITCH ASSEMBLY	1
T - CC	INSTALLATION PARTS BAG	1
DD, EE	FUSE PARTS BAG	1
R	OPERATORS INSTRUCTION	1
Q	OPERATORS QUICK REFERENCE WALLET CARD	1
P	UNDERHOOD WARNING LABEL	1

**7W3Z-19G364-AA****Remote Start System Kit (RMST) - TYPE "C"**

REF	DESCRIPTION	QTY
A	PC-34 MODULE ASSEMBLY	1
B	RMST DNAASSEMBLY	1
C	1 BUTTON POWERCODE TRANSMITTER	2
G	TYPE "C" CUSTOM WIRING HARNESS	1
N	DIPOLE ANTENNA	1
M	HOOD SAFETY SWITCH ASSEMBLY	1
T - CC	INSTALLATION PARTS BAG	1
DD, EE	FUSE PARTS BAG	1
R	OPERATORS INSTRUCTION	1
Q	OPERATORS QUICK REFERENCE WALLET CARD	1
P	UNDERHOOD WARNING LABEL	1

## KIT BILL OF MATERIALS LISTS

### 7L3Z-19G364-AA

#### Remote Start w/Deluxe Vehicle Security & Keyless Entry Kit (RKE/VSS/RMST)

REF	DESCRIPTION	QTY
A	PC-34 MODULE ASSEMBLY	1
B	RKE/VSS/RMST DNA ASSEMBLY	1
D	6 BUTTON POWERCODE TRANSMITTER	2
I	24-WAY WIRING HARNESS (BASE)	1
J	16-WAY WIRING HARNESS (ADVANCE FUNCTIONS)	1
K	10-WAY WIRING HARNESS (CAR START FUNCTIONS)	1
L	STATUS INDICATOR ASSEMBLY	1
N	DIPOLE ANTENNA	1
M	HOOD SAFETY SWITCH ASSEMBLY	1
T - CC	INSTALLATION PARTS BAG	1
DD, EE	FUSE PARTS BAG	1
R	OPERATORS INSTRUCTION	1
Q	OPERATORS QUICK REFERENCE WALLET CARD	1
O	VSS WINDOW WARNING DECAL	2
P	UNDERHOOD WARNING LABEL	1

### 7L3Z-19A361-AA

#### Vehicle Security Kit (VSS)

REF	DESCRIPTION	QTY
A	PC-14 MODULE ASSEMBLY	1
B	VSS DNA ASSEMBLY	1
I	24-WAY WIRING HARNESS (BASE)	1
L	STATUS INDICATOR ASSEMBLY	1
H	WHIP ANTENNA	1
T - CC	INSTALLATION PARTS BAG	1
DD, EE	FUSE PARTS BAG	1
R	OPERATORS INSTRUCTION	1
Q	OPERATORS QUICK REFERENCE WALLET CARD	1
O	VSS WINDOW WARNING DECAL	2



# MODULE PREPARATION

1

Place the supplied fuses into the power distribution block on the control module. See the wiring sections of the I-sheets for vehicle specific fuse placement.

In this diagram, the parking light fuse is shown in the **positive** polarity position and the Dome light fuse is shown in the **negative** polarity position.

Note: The HVAC1, HVAC2 and IGNITION fuses are only used on systems including remote car start (requires PC-34 module).

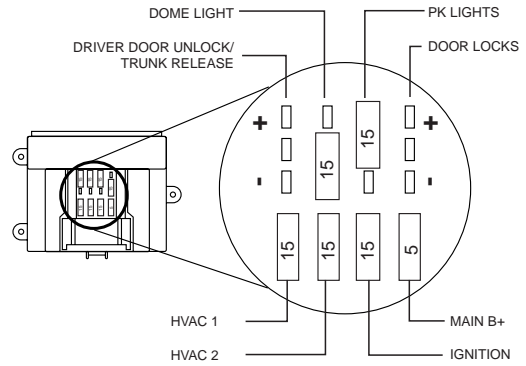

2

Move the polarity jumpers into their correct locations on the control module. See the wiring sections of the I-sheets for vehicle specific jumper placements.

NOTE: In this diagram, the unlock sense jumper is shown in the negative polarity position as an example only. **The positions shown as “positive” and “negative” will always be function accordingly unless the inputs “polarity inverter” option is changed.**

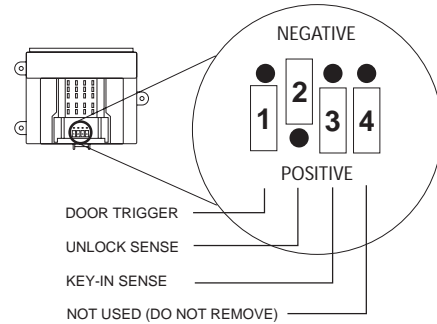

3

Place the software cartridge (DNA) onto the control module as shown.

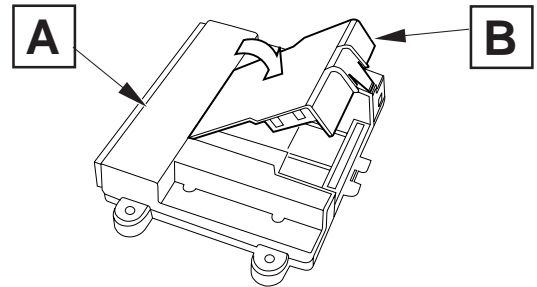

4

Plug the wiring harness(es) into the module.

I-Harness: 24-way, used on all systems;

J-Harness: 10-way, used on all systems with RMST;

K-Harness: 16-way, used on systems with convenience features (i.e. Headlight control, memory seat control) along with some preload system installations in vehicles without factory equipped RKE.

If you are installing a system that uses the whip antenna (VSS or Preload), plug the whip antenna (H) into the module at this time.

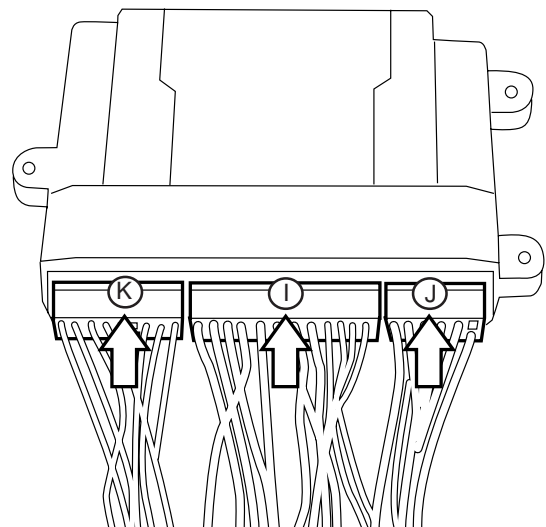

## MODULE PREPARATION (Cont't)

5

Referring to the vehicle specific wiring section for the system being installed, gather all individual wires that will be routed to the same areas of the vehicle into groups. Cover each wire group with tape for approximately 18". Depending upon the vehicle, there will be 2 - 5 different wire groups.

Trim the unused wires approximately 6 - 8" from the module. **Do not cut** the override/programming button off of the harness, it is used for all installations.

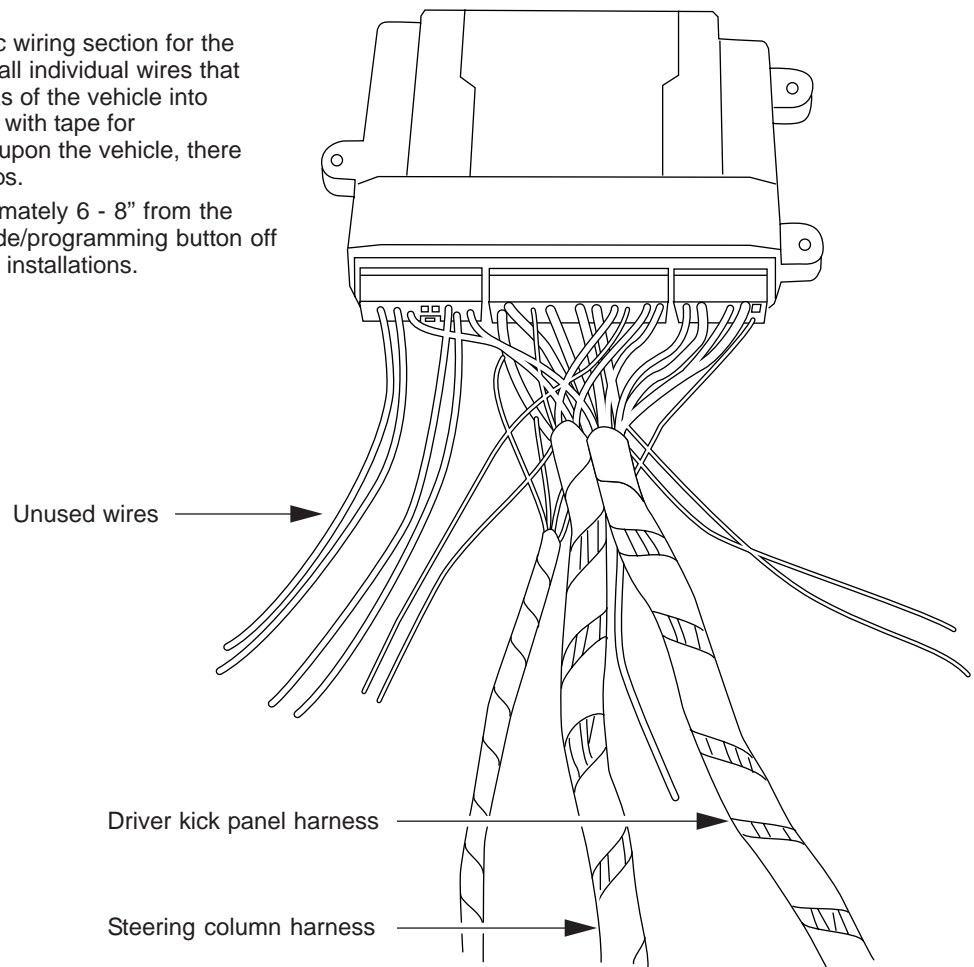

6

Tape the harness sections together, making sure to cover all of the unused wires.

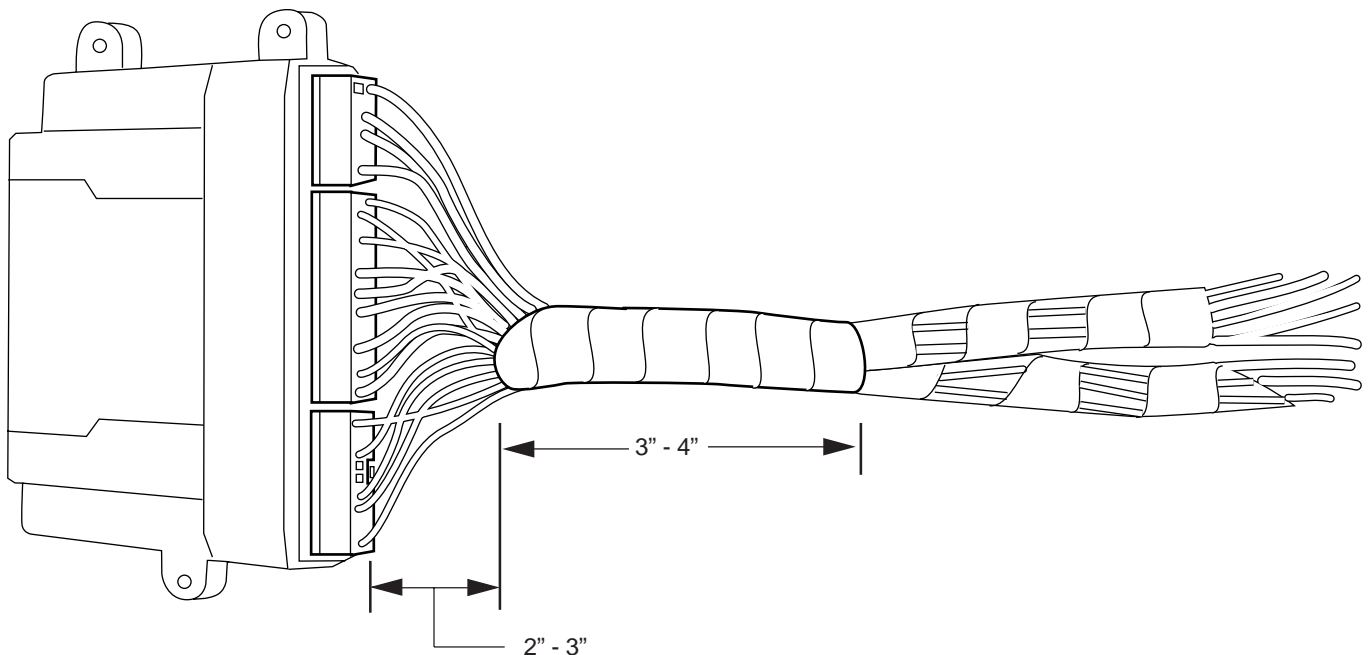

# VEHICLE PREPARATION

1

- A. To allow access to the necessary vehicle circuits, remove the interior panels as required.
- B. Identify the control module mounting location and appropriate vehicle circuit connection points by referring to the vehicle specific I-sheets. Plan wire harness routings that will be free and clear of all moving underdash components (i.e. accelerator pedal, adjustable position brake pedal assembly and parking brake mechanism).

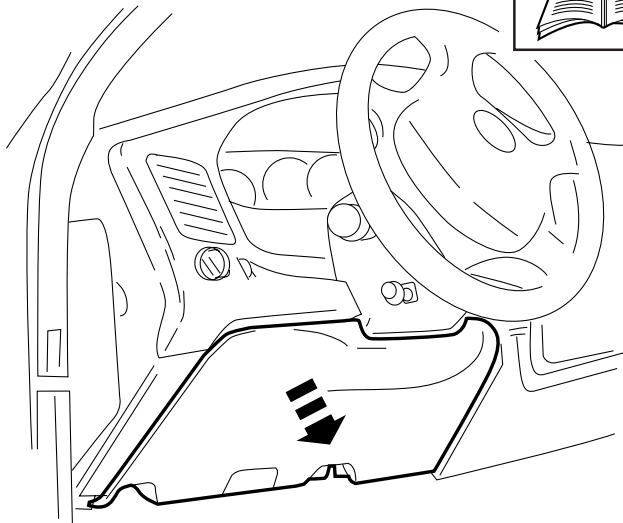

2

- All models except some Econoline, Ranger and Super-Duty Pickups, remove the steering column shroud to allow access to the PATS transceiver antenna ring around the ignition switch lock cylinder.

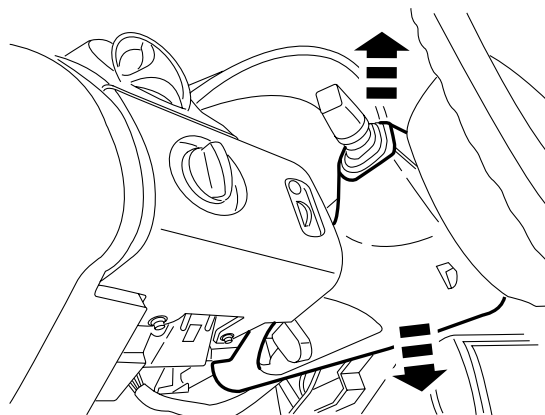

3

Test for Factory Perimeter Alarm (vehicles equipped with factory RKE only):

1. Roll down the driver's door window and then close all doors, hood, trunk or hatch;
  2. Lock the doors using the factory RKE transmitter;
  3. Wait one minute, then reach in the driver door window and open the drivers door (do not unlock doors with the factory RKE remote).
- € If the vehicle's horn begins sounding when the door is opened, the vehicle is equipped with factory perimeter alarm. Unlock the doors with the factory RKE remote to turn off the alarm. In this case, wire the systems factory perimeter alarm disarm wire to the vehicle's perimeter alarm disarm input (See the vehicle specific wiring section). Skip the test for door trim switch disable below.
- € If the horn does not begin sounding when the door is opened, the vehicle is not equipped with factory installed perimeter alarm. Follow the test procedure below for door trim switch disable.

Test for Door Trim Switch Disable option (vehicles equipped with factory RKE only):

1. Roll down the driver door window and close all doors, hood, trunk or hatch;
  2. Lock the doors using the factory RKE transmitter;
  3. Wait one minute, then reach in the driver door window and press the door trim unlock switch.
- € If the doors unlock, the door trim disable feature is not enabled and no further action is required.
- € If the doors do not unlock, refer to the vehicles owners manual on how to shut this feature off.

# DIPOLE ANTENNA MOUNTING

1



The optimum operating range for this system is dependant upon proper selection of the mounting location for the Dipole antenna.

- Never mount the antenna behind (or on) any metal film or metal film window tint on the windshield.
- Never mount the antenna so that one of the antenna elements touches or crosses any vehicle wiring and/or metal.
- On vehicles with no metal film in the windshield around the mirror and a non-electronic mirror, mount the di-pole antenna between the headliner and rearview mirror.
- On vehicles equipped with an "Electronic" mirror or vehicles with metal film in the windshield near the mirror, mount the di-pole antenna approximately 3" below the mirrors attachment point to the windshield and/or mirror electronics;

- A. Clean the selected mounting location using a alcohol based glass cleaning solution.
- B. Mount the Di-pole antenna as shown. Remove the protective backing from the adhesive. Use care not to touch the adhesive backing. Firmly press on the body of the antenna to ensure good glass to adhesive bond.

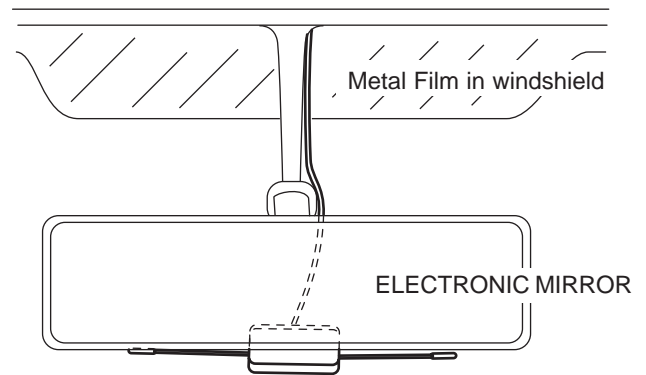
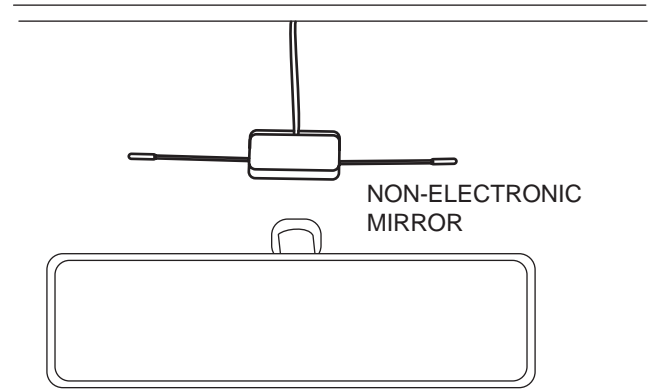

2

Route the antenna cable to the control module mounting location. Make sure that the antenna cable is routed free and clear of all moving assemblies such as the emergency brake and/or the adjustable brake pedal assembly.

The antenna cable can generally be "tucked" behind the headliner and "A-pillar" trim panel(s) without the need to loosen or remove any of the trim panels. If it is necessary to loosen or remove any of the interior trim panels to run the antenna cable, proceed with caution as these trim pieces are sometimes easily damaged. Also note that some interior trim fasteners are "one-time" use and must be replaced if removed.

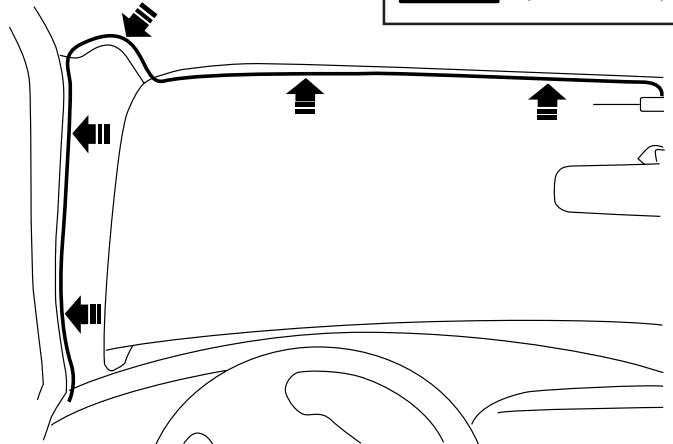

# STATUS LED (RKE/VSS/RMST ONLY)

1

Identify a suitable mounting location for the status LED. Make sure that there is at least 3/4" clearance behind the selected mounting location.

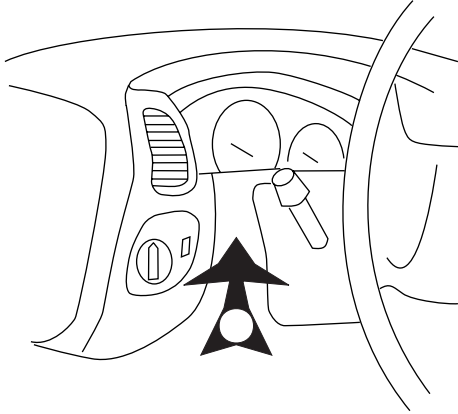

2

If necessary, remove the selected trim panel

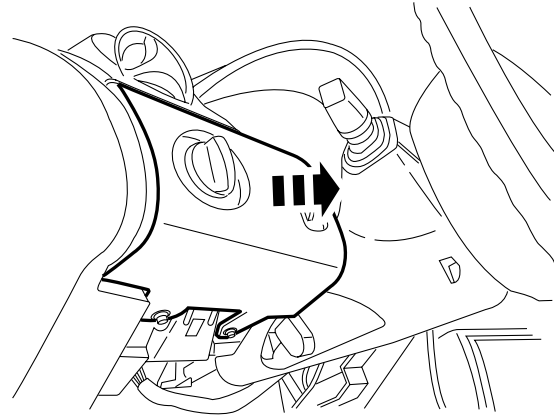

3

Drill a 9/32" mounting hole.

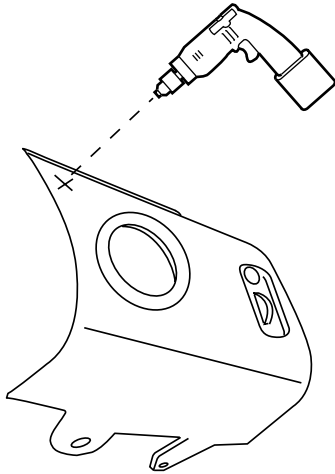

4

Insert status LED into drilled hole.

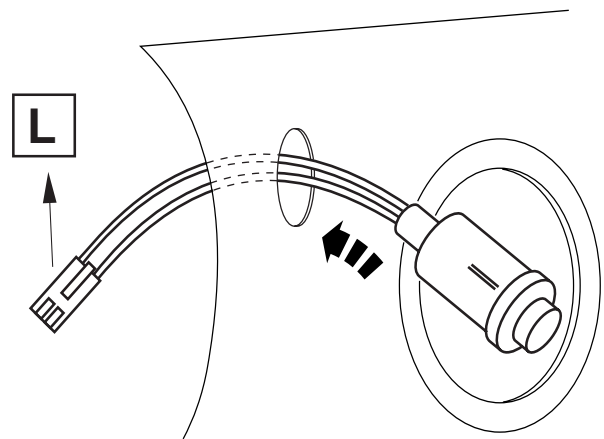

5

If necessary, reinstall any interior trim panels removed during this procedure.

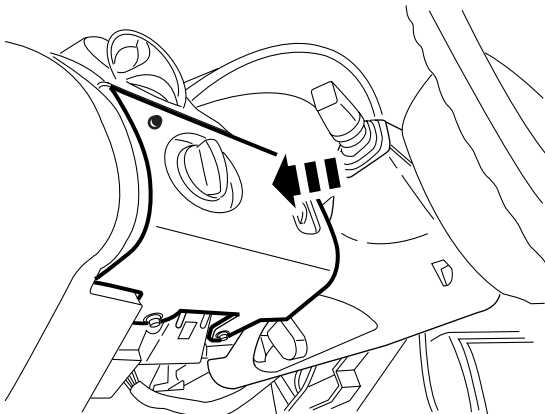

6

The LED will plug into the main wiring harness during the wiring steps. Make sure to leave the LED pigtail accessible.

# SECURILOCK INTERFACE KIT - 7L2Z-19G365-AA

1

Route the ring end of PATS interface antenna (S2) lead up along steering column to area around transceiver antenna coil.

SECURILOCK KIT COMPONENTS

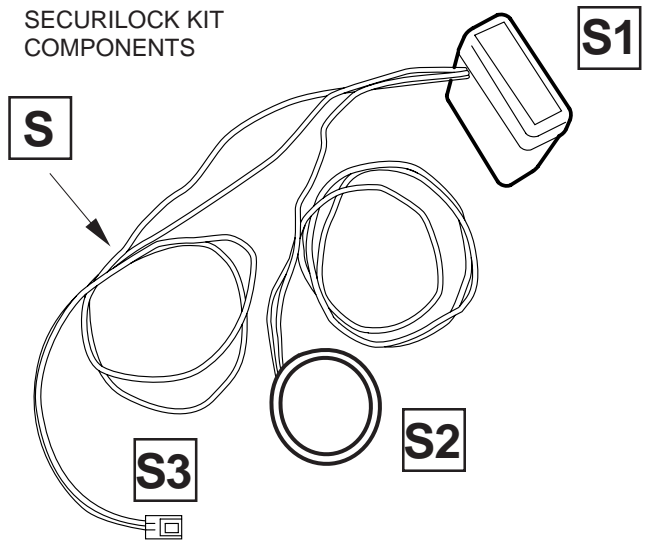

2

Slip antenna ring (S2) over PATS transceiver.

Note: On vehicles with an ignition switch tumbler that will not allow the ring to fit over it, refer to the vehicle's service manual on proper removal of the ignition key cylinder.

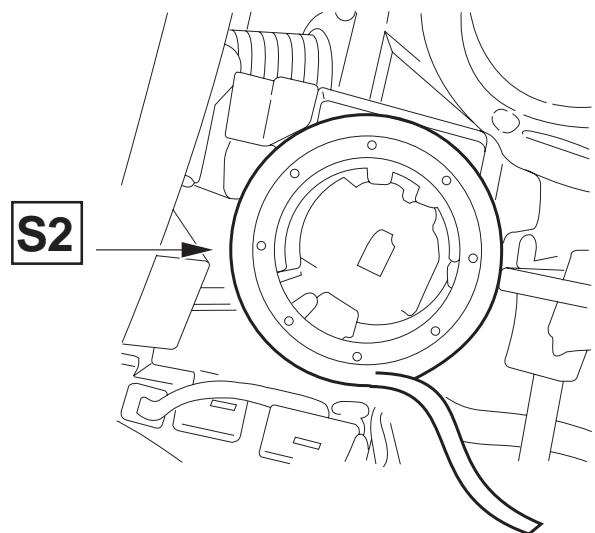

3

- A. Mount the Securilock Interface Module (S1) to an underdash wiring harness using one of the supplied long tie wraps (Y) as shown. DO NOT mount the Securilock Interface Module: 1) To or within 3" of a metal surface, including any underdash brackets, or 2) In the knee bolster area.
- B. Route the harness and connector (S3) to module mounting location.

WARNING: Do NOT tie harness to steering column!

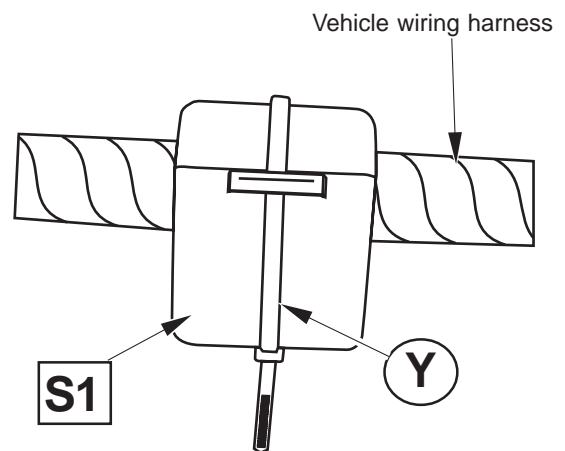

# HOOD TILT SWITCH INSTALLATION

1

Locate an easy to access area near the drivers side hood hinge.

**Note:** Make sure to allow enough clearance to adjust the tilt switch up or down after installation.

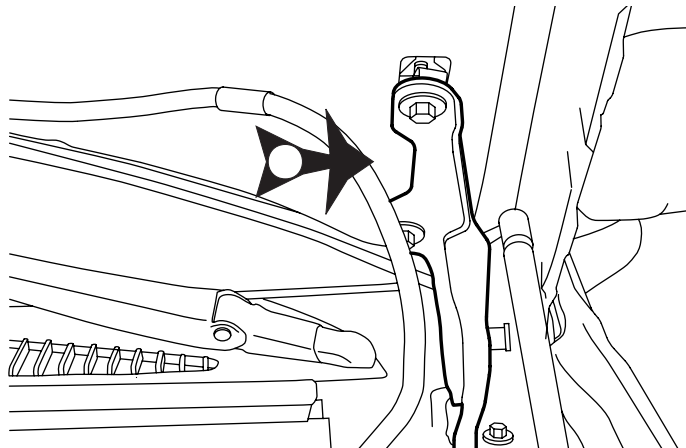

2

Mount the hood safety switch using the supplied sheet metal screws (CC) so that the switch will be biased downward when the hood is closed. Route the wire carefully avoiding any moving parts or excessive heat.

**Note:** The switch should be positioned about 30 degree's below parallel to the ground to accommodate for parking on inclines.

**Failure to position the switch properly could result in one of the following:**

- False alarm trips
- Non-Remote Start events
- Inadvertent shutdown during Remote Start

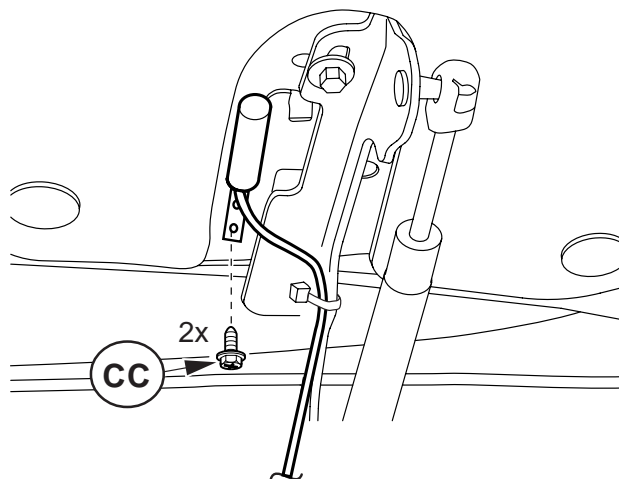

3

Select a proper grounding point and clean surface of paint, grease and dirt. Attach ground lug to connection point using the sheet metal screw provided (CC). Torque ground screw to 10 in / lbs. Apply rustproofing compound (PM-12A) to drilled hole.

**Note:** Ground connection must be tight and secure. Failure of ground connection can prevent proper operation of system.

The remaining hood switch wire will be connected during the wiring steps.

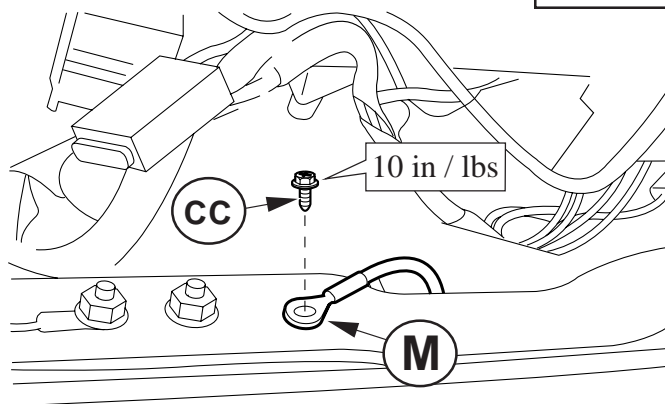

## MOUNTING THE CONTROL MODULE

1

Plug the connectors for the Securilock interface and antenna (if not already done) into the control module as shown.

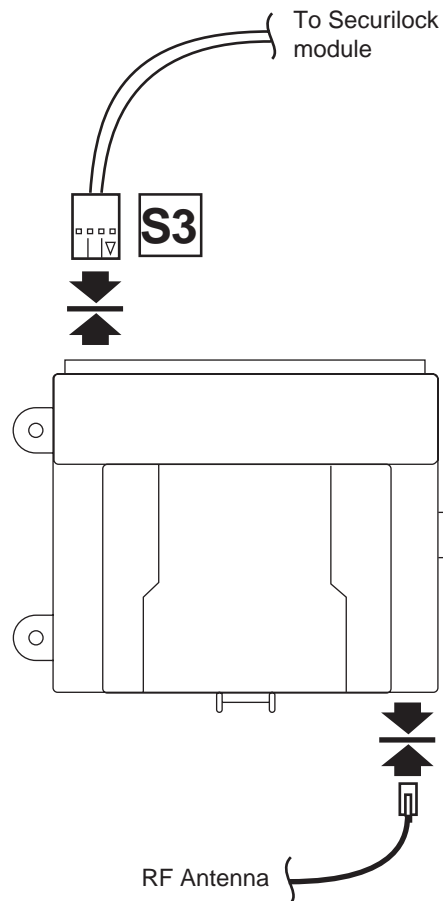

2

Plug the Status LED into the main wiring harness.

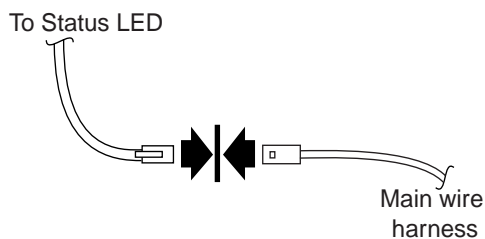

3

- A. Using the supplied long tie wraps (Y), mount the control module to underdash wiring harnesses and/or dash mounting brackets. Module mounting locations are provided on the last page of the vehicle specific wiring sections. **DO NOT** mount the control module in the knee bolster area. To ensure best performance of the built-in shock sensor, securely tie wrap the control module at three points to the vehicle.
- B. Route the different sections of the wiring harness to the appropriate underdash areas of the vehicle. Neatness in this area is very important in ensuring a quality finished installation. Wherever possible, route the PowerCode system wires along with existing vehicle wiring harnesses and tie wrap the PowerCode wiring harnesses to existing vehicle wiring harnesses.



Make sure to route the PowerCode system wiring so that it is free and clear of all moving underdash components (i.e. accelerator pedal, adjustable brake pedal assembly and/or parking brake mechanism).

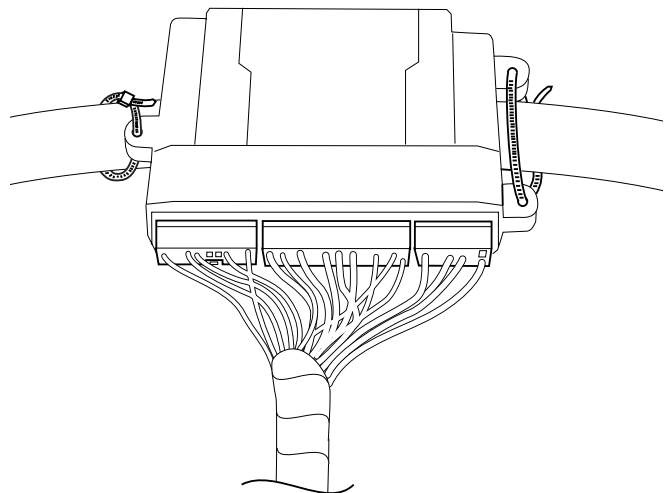



# SYSTEM WIRING CONNECTIONS

1

- A. Finish routing the systems wiring harnesses to their destination points and secure all system wiring using the supplied tie wraps (Y or Z).
- B. Make the wiring connections as shown. Vehicle specific wiring diagrams can be found in two separate files titled "CARS" and "TRUCKS" which are also found on the Ford websites along with this document.



**Make sure to test each vehicle circuit prior to making any connections - All vehicle wiring is subject to change.**

Instructions on proper wiring connection methods and circuit testing can be found in the reference section of this manual.

- C. After completing all the system wiring, follow the instructions beginning on the next page to program and test the systems functionality.

**NOTE: The system will not function properly if not programmed.**

# WARNING LABEL INSTALLATION

1

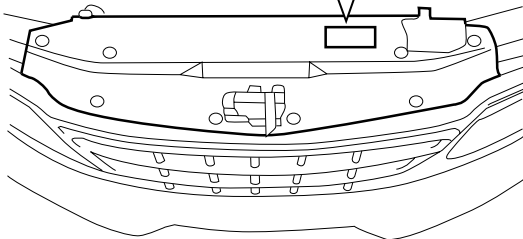
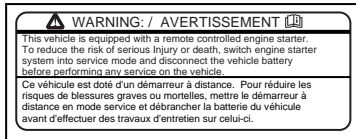

RMST & RKE/VSS/RMST SYSTEMS ONLY - Install the Orange warning label on the radiator shroud (or similar area).

2

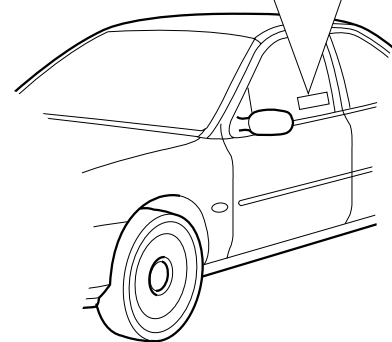
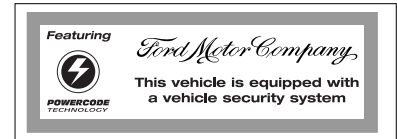

VSS & RKE/VSS/RMST SYSTEMS ONLY - Install the window decals on both the driver and passenger side windows.

# SYSTEM PROGRAMMING - (VSS)

## How to program the system:

This section describes how to select and scroll through the programming options. For a list of programming options, refer to the next page.

### A) Getting into programming mode:

1. Open the driver's door;



**NOTE:** On vehicles with negative polarity door ajar switch input circuits (Refer to the vehicle specific programming section), the door is closed during this step unless the door ajar switch input polarity option has been previously changed to negative.

2. Turn the ignition key to the ON or RUN position;
3. Press and hold the programming/override button;

*After 10 seconds the horn will chirp 3 times, indicating the system is now in the transmitter learn mode.*

4. Release the programming/override button;

### B) To change the setting of an option:

1. Press the door trim "Lock" switch to advance to the desired option (refer to the programming charts on the following pages for the specific system that you are programming;

*The horn will chirp a number of times to indicate which option is selected (i.e. Two chirps indicates that option number two has been selected).*

2. Press the door trim "Unlock" switch to change the setting of the option

*The status LED indicates the setting of the option: LED ON indicates that the option is on, LED OFF indicates that the option is off.*

**NOTE:** Pressing the door trim switch "lock button" while in transmitter learn mode will reset all options to their factory default settings, except for the installer options and shock sensor settings. The system will respond by chirping the horn 4 times.

### C) To advance to the next option bank:

1. At any point while in option programming, press and release the programming/override button to advance to the next option bank.

*The horn will chirp a number of times, indicating which option bank the system has entered (i.e. 5 chirps indicates that the system is in option programming bank #2. Refer to the option programming chart to correlate the horn chirps to option bank).*

# VSS OPTION CHART (press lock trim switch to scroll trough options, press unlock trim switch to change option)

<b>Option Bank 1 – 4 chirps</b>	<b>Factory setting (LED)</b>
1 – Lite-touch adjustment (refer to page 20 for Shock Sensor programming procedure)	
2 – Full shock adjustment (refer to page 20 for Shock Sensor programming procedure)	
3 – Door ajar switch input inverter LED On – Positive, LED Off – Negative .....	On (Positive)
4 – Unlock switch sense input inverter LED On – Positive, LED Off – Negative .....	On (Positive)
5 – Optional alarm disable Disables security functionality.....	Off
<b>Option Bank 2 – 5 chirps</b>	<b>Factory setting (LED)</b>
1 – Starter Interrupt Starter interrupt activates when Security System is armed. ....	Off
2 – Passive starter Interrupt Starter interrupt activates 1 minutes after key off event. ....	Off
3 – Passive arming Security system activates 1 minutes after key off event. ....	Off
4 – Passive door locks All doors lock automatically 1 minutes after key off event. ....	Off
5 – Selectable chirps Enables arming/disarming confirmation chirps (uses horn). ....	On
6 – Silent choice On – Confirmation chirp on second press of transmitter button Off – Confirmation chirp on first press of transmitter button. Requires option #5 (above) to be ON. ....	On
7 – Door Ajar Input Entry Delay 5 Second entry delay. Used for vehicles with external door mounted RKE keypads.....	Off
8 – Use trunk relay as Driver door unlock Switches Trunk release and Drivers door unlock outputs .....	Off
<b>Option Bank 3 – 6 chirps</b>	<b>Factory setting (LED)</b>
1 – Drivers door priority unlock Drivers door only unlocks on first press of Disarm/Unlock, All doors unlock on second press within 5 seconds. ....	Off
2 – Ignition lock All doors lock when ignition key is turned to on (run). ....	Off
3 – Ignition unlock All doors are unlocked when ignition key is turned to off. ....	Off
4 – Delayed door lock for ignition lock Waits 3 seconds after key on event before activating ignition lock. Used on vehicles with theater dimming interior lights. ....	Off
5 – Illuminated exit Activates dome light output for one minute when ignition key is turned off .....	On
6 – Extended Horn Honk Pulse LED On = Extended Horn Honk Pulse, LED Off = Standard horn honk pulse .....	Off
7 – Noise control Limits alarm trips to 5 per zone .....	On
8 – Factory RKE system does not arm alarm Prevents factory RKE from arming security system. Still allows factory RKE to disarm security system. ....	Off

## SYSTEM PROGRAMMING - Shock Sensor (VSS)



### How to Properly Adjust Shock (Lite Touch & Full Shock) Sensor Settings Using the Trim Switch (VSS):

Note: Powercode Systems with Alarm Feature contain one internal shock sensor with two different settings, Lite Touch and Full Shock. When the vehicle is armed, the force which chirps the horn due to impact is determined by the Lite Touch level setting. When the vehicle is armed, the force at which sounds the alarm due to impact is determined by the Full Shock level setting. THE FULL SHOCK LEVEL SHOULD ALWAYS BE LESS SENSITIVE THAN LITE TOUCH LEVEL.

- #1). Locate Override button coming from Powercode Module (usually mounted in driver's side kick panel or under dash).
- #2). Open driver's door and turn key to ON position.
- #3). Press and hold Override Button until horn chirps.
- #4). Press again until FOUR chirps are heard. This is option bank #1.
- #5). Press lock button on the trim switch (scroll down) to select first option in option bank #1.  
The horn will chirp once to indicate first option in option bank #1.
- #6) Make sure a window is rolled down and shut all doors.

This is the Lite Touch Adjustment Programming Option. When in this programming option the vehicle will CHIRP the horn when an impact is detected.

To test and adjust current sensitivity level: Start with a light tap on outer rim of steering wheel with open palm of hand. Gradually increase force of tap until horn chirp is detected. This should be set to chirp at a Light to Medium Impact level.

Pressing LOCK button on the trim switch will decrease sensitivity. Pressing UNLOCK will increase sensitivity.

- #7). When properly adjusted, open a door, press lock button on trim switch (scroll down) to select second option in option bank #1. The horn will chirp twice to indicate second option in option bank #1. Shut door again.

This is the Full Shock Adjustment Programming Option. When in this programming option the vehicle will CHIRP the horn when an impact is detected.

To test and adjust current sensitivity level: Start with a light tap on outer rim of steering wheel with open palm of hand. Gradually increase force of tap until horn chirp is detected. This should be set to chirp at a High impact level.

Pressing LOCK button on trim switch will decrease sensitivity. Pressing UNLOCK will increase sensitivity.

Only a High impact of open hand on steering wheel should cause a chirp. Light to Medium impacts need to be adjusted down by pressing the UNLOCK button on Powercode key fob.

- #7). When completed, turn key to OFF.
- #8). Arm system and recheck the new settings.

## TRANSMITTER PROGRAMMING - (RMST & RKE/VSS/RMST)



### How to program transmitters:

**NOTE: Transmitters come pre-programmed with kit. If using transmitters that came with the kit, please ignore this section. Use this section to program replacement or additional transmitters only.**

- A. Open the driver's door (**press and hold in brake pedal on Remote Start only system - RMST**);



**NOTE:** On vehicles with negative polarity door ajar switch input circuits (Refer to the vehicle specific programming section), the door is closed during this step unless the door ajar switch input polarity option has been previously changed to negative.

- B. Turn the ignition key to the ON or RUN position;
- C. Press and hold the programming/override button;  
*After 10 seconds the horn will chirp 3 times, indicating the system is now in the transmitter learn mode.*
- D. Release the programming/override button;
- E. Press transmitter button 1 (  on RKE/VSS/RMST, except RMST system which is  ) on the on the remote control transmitter to be programmed.  
*The horn will chirp one time to indicate that the transmitter has been learned.*

#### Notes:

- A. Up to a total of 8 transmitters can be programmed at this time
- B. Transmitters shipped with complete kits or personality kits are pre-programmed to the DNA and do not need to be programmed at this time.
- C. If the vehicle is equipped with memory seats/functions, the last two transmitters programmed will activate the memory seats/functions.
- D. All programmed transmitters can be erased from memory by pressing the door trim switch "unlock button" while in transmitter learn mode (requires that the Disarm input and Unlock sense input wires be connected)

## SYSTEM PROGRAMMING - (RKE/VSS/RMST)

### How to program the system:

This section describes how to select and scroll through the programming options.

**For mandatory programming options, refer to the first page (Fuse Placement Chart/Parts Required) on the vehicle specific instruction sheets.**

**Note: If vehicle options (Key-in sense invert, door ajar invert, unlock sense invert, or tach mode) are not programmed correctly, vehicle will not remote start or operate properly.**

**If Tachless Mode is listed as "OFF", a tach wire is required and you must refer to the section "Programming Tach Idle Speed" on page 26.**

For a list of the programming menu, refer to the next page.

Each system has several user programmable options which can be changed to accommodate different vehicle options and/or consumers desires. Virtually every installation will require that some option(s) to be changed. Charts listing the options for each system and the factory default settings are located on the following pages.

### Option programming (RKE/VSS/RMST systems):

#### A) Getting into programming mode:

1. Open the driver's door;





**NOTE:** On vehicles with negative polarity door ajar switch input circuits (Refer to the vehicle specific programming section), the door is closed during this step unless the door ajar switch input polarity option has been previously changed to negative.

2. Turn the ignition key to the ON or RUN position;
3. Press and hold the programming/override button;  
*After 10 seconds the horn will chirp 3 times, indicating the system is now in the transmitter learn mode.*
4. Release the programming/override button;
5. Press and release the programming/override button.  
*The horn will chirp four times indicating the system has entered the first option bank.*

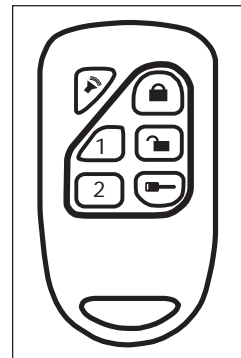
Note: The RKE/VSS/RMST system that you are working will have 5 option programming banks. Each option bank contains anywhere from 5 – 8 options within it.



#### B) To change the setting of an option:

1. Press the  button to advance to the desired option (refer to the programming charts on the following pages for the specific system that you are programming;  
*The horn will chirp a number of times to indicate which option is selected (i.e. Two chirps indicates that option number two has been selected).*
2. Press the  button to change the setting of the option  
*The status LED indicates the setting of the option: LED ON indicates that the option is on, LED OFF indicates that the option is off.*

Note: Pressing the  transmitter button while in any option bank will reset all options, except for the "Installer" options (1st Bank) and the shock sensor to their factory settings. The system will respond by chirping the horn 4 times.

#### C) To advance to the next option bank:

1. At any point while in option programming, press and release the programming/override button to advance to the next option bank.  
*The horn will chirp a number of times, indicating which option bank the system has entered (i.e. 5 chirps indicates that the system is in option programming bank #2. Refer to the option programming chart to correlate the horn chirps to option bank).*

# RKE/VSS/RMST OPTION CHART (press Panic to scroll through options, lock to change option)

Option Bank 1 – 4 chirps	Factory setting (LED)
1 – Lite-touch adjustment (refer to page 25 for Shock Sensor programming procedure) 2 – Full shock adjustment (refer to page 25 for Shock Sensor programming procedure) 3 – Learn tachometer With hood open or brake on, start engine. System will chirp horn every five seconds if a valid tach signal is present. Press Panic on transmitter when complete. 4 – Door ajar switch input inverter LED On – Positive, LED Off – Negative ..... 5 – Unlock switch sense input inverter LED On – Positive, LED Off – Negative ..... 6 – Key-in sense input inverter LED On – Positive, LED Off – Negative ..... 7 – Extended Horn Honk Pulse LED On = Extended Horn Honk Pulse, LED Off = Standard horn honk pulse ..... 8 – Optional alarm disable Disables security functionality. ....	On (Positive) On (Positive) On (Positive) Off Off
Option Bank 2 – 5 chirps	Factory setting (LED)
1 – Starter Interrupt Starter interrupt activates when Security System is armed. .... 2 – Passive starter Interrupt Starter interrupt activates 1 minutes after key off event. .... 3 – Passive arming Security system activates 1 minutes after key off event. .... 4 – Passive door locks All doors lock automatically 1 minutes after key off event. .... 5 – Selectable chirps Enables arming/disarming confirmation chirps (uses horn). .... 6 – Silent choice (Requires option #5 (above) to be ON) On – Confirmation chirp on second press of transmitter button Off – Confirmation chirp on first press of transmitter button ..... 7 – Door Ajar Input Entry Delay 5 Second entry delay. Used for vehicles with external door mounted RKE keypads ..... 8 – Use trunk relay as Driver door unlock Switches Trunk release and Drivers door unlock outputs .....	Off Off Off Off On On Off Off
Option Bank 3 – 6 chirps	Factory setting (LED)
1 – Drivers door priority unlock Drivers door only unlocks on first press of Disarm/Unlock, All doors unlock on second press within 5 seconds. .... 2 – Ignition lock All doors lock when ignition key is turned to on (run). .... 3 – Ignition unlock All doors are unlocked when ignition key is turned to off. .... 4 – Delayed door lock for ignition lock Waits 3 seconds after key on event before activating ignition lock. Used on vehicles with theater dimming interior lights. .... 5 – Illuminated exit Activates dome light output for one minute when ignition key is turned off ..... 6 – Horn used for alarm Horn sounds during alarm/panic cycles ..... 7 – Noise control Limits alarm trips to 5 per zone ..... 8 – Factory RKE system does not arm alarm Prevents factory RKE from arming security system. Still allows factory RKE to disarm security system. ....	Off Off Off Off On On On Off

**RKE/VSS/RMST OPTION CHART (Cont')** (press Panic to scroll through options, lock to change option)

Option Bank 4 – 7 chirps	Factory setting (LED)
1 – Tachless Mode LED On = Tachless, LED Off =Tach. ....	Off
2 – Tachless Timing LED On = 8-second Crank, LED Off = 1-second Crank .....	On
3 – Car start run time LED On – 15 minutes, LED Off – 10 minutes .....	Off
4 – Press & Hold to start LED On = Press & hold to start, LED Off = Double press to start .....	On
5 – Diesel timer Delays crank attempt 30 seconds after ignition on. ....	Off
6 – Horn honk on Start LED On = Horn honks during remote start, LED Off = No Horn Honks .....	On
Option Bank 5 – 8 chirps	Factory setting (LED)
1 – Headlight Output* Time (used only when option #5 below is in the LED Off position)* LED On – 20 seconds, LED Off – .5 seconds .....	On (20 sec.)
2 – Rear Defrost Output Time LED On – 10 minutes, LED Off – .5 seconds .....	Off (.5 sec.)
3 – Auxiliary Output Time LED On – .5 seconds, LED Off – Time held .....	On (.5 sec.)
4 – Power Sliding Door Output* Time (used only when option #5 below is in the LED On position)* LED On – .5 seconds, LED Off – Time held .....	On (.5 sec.)
5 – Convert headlight output to act as the power sliding door output LED On- Power Sliding Door Output, LED Off- Headlight Output .....	Off
* The Headlight Output and Power Sliding Door Output both use the C-10 Red/White wire controlled by button 1.	

**ONCE MODULE IS PROGRAMMED, PLEASE REFER TO PIK PROGRAMMING on PAGE 27**



## RKE/VSS/RMST Shock Sensor Programming



### How to Properly Adjust Shock (Lite Touch & Full Shock) Sensor Settings Using a Transmitter (RKE/VSS/RMST)

Note: Powercode Systems with Alarm Feature contain one internal shock sensor with two different settings, Lite Touch and Full Shock. When the vehicle is armed, the force which chirps the horn due to impact is determined by the Lite Touch level setting. When the vehicle is armed, the force at which sounds the alarm due to impact is determined by the Full Shock level setting. THE FULL SHOCK LEVEL SHOULD ALWAYS BE LESS SENSITIVE THAN LITE TOUCH LEVEL.

- #1). Locate Override button coming from Powercode Module (usually mounted in driver's side kick panel or under dash).
- #2). Open driver's door and turn key to ON position.
- #3). Press and hold Override Button until horn chirps.
- #4). Press again until FOUR chirps are heard. This is option bank #1.
- #5). Press button THREE (scroll down) to select first option in option bank #1.  
The horn will chirp once to indicate first option in option bank #1.

This is the Lite Touch Adjustment Programming Option. When in this programming option the vehicle will CHIRP the horn when an impact is detected.

To test and adjust current sensitivity level: Start with a light tap on outer rim of steering wheel with open palm of hand. Gradually increase force of tap until horn chirp is detected. This should be set to chirp at a Light to Medium Impact level.

Pressing UNLOCK button on Powercode transmitter will decrease sensitivity. Pressing LOCK will increase sensitivity.

- #6). When properly adjusted Press button THREE (scroll down) to select second option in option bank #1. The horn will chirp twice to indicate second option in option bank #1.

This is the Full Shock Adjustment Programming Option. When in this programming option the vehicle will CHIRP the horn when an impact is detected.

To test and adjust current sensitivity level: Start with a light tap on outer rim of steering wheel with open palm of hand. Gradually increase force of tap until horn chirp is detected. This should be set to chirp at a High impact level.

Pressing UNLOCK button on Powercode transmitter will decrease sensitivity. Pressing LOCK will increase sensitivity.

Only a High impact of open hand on steering wheel should cause a chirp. Light to Medium impacts need to be adjusted down by pressing the UNLOCK button on Powercode key fob.

- #7). When completed, turn key to OFF.
- #8). Arm system and recheck the new settings.

## SYSTEM PROGRAMMING - Tach Idle Speed Programming (RKE/VSS/RMST)

Tach (Idle speed) programming (for vehicles without Electronic Starter Motor Control)

**NOTE: If the first page (Fuse Placement/Parts Required) on the vehicle specific instruction sheets has Tachless Mode = "ON", a tach wire is not required and this section can be ignored.**



- A. Make sure that the hood is closed before proceeding.
  - B. Enter option learn mode as described in step 2 of this section.
  - C. € RKE/VSS/RMST systems - Advance to option bank # 1 (4 chirps)
  - D. € RKE/VSS/RMST system - Advance to option #3;
  - E. Press and hold in the brake pedal and start the engine using the ignition key. Allow the engine to settle to a normal idle speed. The system will chirp the horn every three (3) seconds if a valid tach signal is detected.
  - F. After the engine has settled to a normal idle speed, **press and release the FIND/PANIC button** (the horn will honk one (1) time) and turn the ignition key off.
- NOTE:** If the system is not chirping the horn every three (3) seconds after the engine has started, the system is not seeing a valid tach signal. Check your tach connection (refer to the appropriate vehicle specific wiring diagram)

# SYSTEM PROGRAMMING - Programming the PIK (RMST & RKE/VSS/RMST)

## Securilock (PATS) Interface Programming and Remote Start Operation Test (Two programmed PATS ignition keys are required for this step)



### Required for vehicles that have factory equipped Passive Anti-Theft System (PATS).

- A. Sitting in the driver seat, be prepared to press the brake pedal to shut down the remote starter system.
- B. Using the first key, turn the ignition on, wait for the THEFT light to turn off, then turn the ignition off and remove key from the ignition switch.
- C. Using the second key, turn the ignition on, wait for the THEFT light to turn off, then turn the ignition off and remove key from the ignition switch.
- D. Activate the remote start function using the PowerCode remote control transmitter.  
*The system should flash the parking lights and chirp the horn one time, pause for four seconds then start then start the engine.*
- E. After the engine is started. Press the brake pedal to shutdown the engine.  
The Securilock interface is now programmed. If the theft light begins flashing rapidly and/or the engine does not crank or cranks but will not start, refer to the troubleshooting information below.
- F. Open the hood.
- G. Sitting in driver's seat, be prepared to press the brake pedal, activate the start function.  
*The system should chirp the horn two (2) times and abort the start sequence.*
- H. Close the hood.
- I. Place ignition key in the ignition cylinder.
- J. Again, Sitting in driver's seat, be prepared to press the brake pedal and activate a start sequence.  
*The system should chirp the horn one (1) time pause four seconds, then chirp the horn two (2) times and abort the start sequence.*

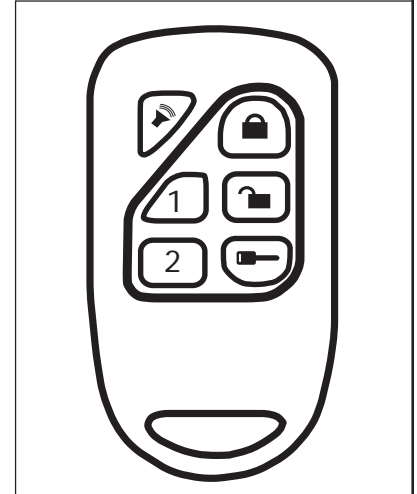

In steps G and J above, the engine MUST NOT start! If the system starts the engine in either steps G or J, check your hood tilt switch installation and key-in-sense connection.

#### Troubleshooting steps:

- A. If the Securilock interface fails to program (theft light flashing), check the following:  
When programming the Securilock Interface timing is important, make sure that you:
  1. Turn the ignition on with the second key within 5 seconds of the theft light going out on the first key;
  2. Engage the remote start within 5 seconds of the theft going out on the second key;
  3. Remove the second ignition key before engaging the remote starter.

**NOTE:** If a third (or more) PATS ignition key has been programmed to the vehicle using either the Ford NGS or IDS programmers, the "Add Key" mode described in the installation manual may have been disabled. If this is the case, use the NGS or IDS programmer to either re-enable the "add key" mode or program the Securilock Interface kit following the NGS or IDS procedure in the vehicle service manual for adding a new PATS key.

- B. If the theft light is solid and engine cranks but will not start:  
Check all Ignition (Hot through run and crank circuits) and Heater (Run circuits). Make sure that the correct outputs from the PowerCode module are connected to the correct vehicle circuits. Reversing the heater and ignition circuits from the PowerCode system will not permanently damage the vehicle but may cause the remote start function to not work and/or set a PCM error codes (which will cause the check engine light to stay on). If the check engine light stays on, use the NGS or WDS testers to identify which fault code has been set. The fault code will help identify which circuit is not properly connected.

# SYSTEM PROGRAMMING - Options (RMST)

## How to program the system:

This section describes how to select and scroll through the programming options.

**For mandatory programming options, refer to the first page (Fuse Placement Chart/Parts Required) on the vehicle specific instruction sheets.**

**Note: If vehicle options (Key-in sense invert, door ajar invert, or tach mode) are not programmed correctly, vehicle will not remote start or operate properly.**

**If Tachless Mode is listed as "OFF", a tach wire is required and you must refer to the section "Programming Tach Idle Speed" on page 30.**

For a list of the programming menu, refer to the next page.

Each system has several user programmable options which can be changed to accommodate different vehicle options and/or consumers desires. Virtually every installation will require that some option(s) to be changed. Charts listing the options for each system and the factory default settings are located on the following pages.

## Option programming (RMST systems):

### A) Getting into programming mode:

1. Press and hold in brake pedal ;



**NOTE:** On vehicles with negative polarity door ajar switch input circuits (Refer to the vehicle specific programming section), the door is closed during this step unless the door ajar switch input polarity option has been previously changed to negative.

2. Turn the ignition key to the ON or RUN position;
3. Press and hold the programming/override button;  
*After 10 seconds the horn will chirp 3 times, indicating the system is now in the transmitter learn mode.*
4. Release the programming/override button;
5. Press and release the programming/override button.  
*The horn will chirp four times indicating the system has entered the first option bank.*

NOTE: The RMST system that you are working will have 2 option programming banks. Each option bank contains anywhere from 5 – 6 options within it.

### B) To change the setting of an option:

1. Press the **brake pedal** to advance to the desired option (refer to the programming charts on the following pages for the specific system that you are programming;  
*The horn will chirp a number of times to indicate which option is selected (i.e. Two chirps indicates that option number two has been selected).*
2. Press the  button to change the setting of the option  
*The status LED indicates the setting of the option: LED ON indicates that the option is on, LED OFF indicates that the option is off.*

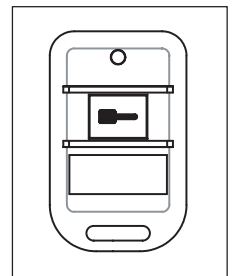

Note: Pressing and HOLDING the  transmitter button for 3 seconds while in any option bank will reset all options, except for the "Installer" options (1st Bank). The system will respond by chirping the horn 4 times.

### C) To advance to the next option bank:

1. At any point while in option programming, press and release the programming/override button to advance to the next option bank.  
*The horn will chirp a number of times, indicating which option bank the system has entered (i.e. 5 chirps indicates that the system is in option programming bank #2. Refer to the option programming chart to correlate the horn chirps to option bank).*

**RMST OPTION CHART** (press brake to scroll through options, press start button to change option)

Option Bank 1 – 4 chirps	Factory setting (LED)
1 – Learn tachometer With hood open or brake on, start engine. System will chirp horn every five seconds if a valid tach signal is present. Press Panic on transmitter when complete.	
2 – Door ajar switch input inverter LED On = Positive, LED Off = Negative ..... On (Positive)	
3 – Key-in sense input inverter LED On = Positive, LED Off = Negative ..... On (Positive)	
4 – Extended Horn Honk Pulse LED On = Extended Horn Honk Pulse, LED Off = Standard horn honk pulse ..... Off	
Option Bank 2 – 5 chirps	Factory setting (LED)
1 – Tachless Mode LED On = Tachless, LED Off =Tach. .... Off	
2 – Tachless Timing LED On = 8-second Crank, LED Off = 1-second Crank ..... On	
3 – Car start run time LED On – 15 minutes, LED Off – 10 minutes ..... Off	
4 – Press & Hold to start LED On = Press & hold to start, LED Off = Double press to start ..... On	
5 – Diesel timer Delays crank attempt 30 seconds after ignition on. .... Off	
6 – Horn honk on Start LED On = Horn honks during remote start, LED Off = No Horn Honks ..... On	

**ONCE MODULE IS PROGRAMMED, PLEASE REFER TO PIK PROGRAMMING ON PAGE 31**

## SYSTEM PROGRAMMING - Tach Idle Speed Programming (RMST)

### Tach (Idle speed) programming (for vehicles without Electronic Starter Motor Control)

**NOTE:** If the first page (Fuse Placement/Parts Required) on the vehicle specific instruction sheets has Tachless Mode = "ON", a tach wire is not required and this section can be ignored.

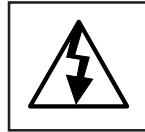

- A. Make sure that the hood is closed before proceeding.
  - B. Enter option learn mode as described in step 2 of this section.
  - C. € RMST system - Advance to option bank #1 (4 chirps) .
  - D. € RMST system - Advance to option #3.
  - E. Press and hold in the brake pedal and start the engine using the ignition key. Allow the engine to settle to a normal idle speed. The system will chirp the horn every three (3) seconds if a valid tach signal is detected.
  - F. After the engine has settled to a normal idle speed, **release, then press and release the BRAKE pedal** again (the horn will honk one (1) time) and turn the ignition key off.
- NOTE:** If the system is not chirping the horn every three (3) seconds after the engine has started, the system is not seeing a valid tach signal. Check your tach connection (refer to the appropriate vehicle specific wiring diagram)

## SYSTEM PROGRAMMING - Programming the PIK (RMST)

### Securilock (PATS) Interface Programming and Remote Start Operation Test (Two programmed PATS ignition keys are required for this step)



#### Required for vehicles that have factory equipped Passive Anti-Theft System (PATS).

- A. Sitting in the driver seat, be prepared to press the brake pedal to shut down the remote starter system.
- B. Using the first key, turn the ignition on, wait for the THEFT light to turn off, then turn the ignition off and remove key from the ignition switch.
- C. Using the second key, turn the ignition on, wait for the THEFT light to turn off, then turn the ignition off and remove key from the ignition switch.
- D. Activate the remote start function using the PowerCode remote control transmitter.  
*The system should flash the parking lights and chirp the horn one time, pause for four seconds then start then start the engine.*
- E. After the engine is started. Press the brake pedal to shutdown the engine.  
The Securilock interface is now programmed. If the theft light begins flashing rapidly and/or the engine does not crank or cranks but will not start, refer to the troubleshooting information below.
- F. Open the hood.
- G. Sitting in driver's seat, be prepared to press the brake pedal, activate the start function.  
*The system should chirp the horn two (2) times and abort the start sequence.*
- H. Close the hood.
- I. Place ignition key in the ignition cylinder.
- J. Again, Sitting in driver's seat, be prepared to press the brake pedal and activate a start sequence.

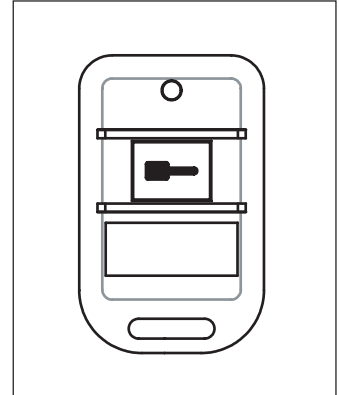

 *The system should chirp the horn one (1) time pause four seconds, then chirp the horn two (2) times and abort the start sequence.*

In steps G and J above, the engine MUST NOT start! If the system starts the engine in either steps G or J, check your hood tilt switch installation and key-in-sense connection.

#### Troubleshooting steps:

- A. If the Securilock interface fails to program (theft light flashing), check the following:  
When programming the Securilock Interface timing is important, make sure that you:
  1. Turn the ignition on with the second key within 5 seconds of the theft light going out on the first key;
  2. Engage the remote start within 5 seconds of the theft going out on the second key;
  3. Remove the second ignition key before engaging the remote starter.

**NOTE:** If a third (or more) PATS ignition key has been programmed to the vehicle using either the Ford NGS or IDS programmers, the "Add Key" mode described in the installation manual may have been disabled. If this is the case, use the NGS or IDS programmer to either re-enable the "add key" mode or program the Securilock Interface kit following the NGS or IDS procedure in the vehicle service manual for adding a new PATS key.

- B. If the theft light is solid and engine cranks but will not start:

Check all Ignition (Hot through run and crank circuits) and Heater (Run circuits). Make sure that the correct outputs from the PowerCode module are connected to the correct vehicle circuits. Reversing the heater and ignition circuits from the PowerCode system will not permanently damage the vehicle but may cause the remote start function to not work and/or set a PCM error codes (which will cause the check engine light to stay on). If the check engine light stays on, use the NGS or WDS testers to identify which fault code has been set. The fault code will help identify which circuit is not properly connected.

# System Programming Instructions - Security/Convenience Function Test

**1** Refer to the Operators manual as necessary and check out the following functions. If any of the functions below, fail to operate, first refer to the vehicle specific wiring diagrams and check the wiring and system programming.

## Convenience Functions

- All Door Lock / All Door Unlock
- Driver door unlock (if installed)
- Parking light flash (optional)
- Trunk or hatch release
- Illuminated entry
- Ignition triggered lock/unlock (if enabled)
- Illuminated exit
- Panic alarm
- Memory seat activation (if equipped)
- Power side Sliding door activation (if equipped)
- Express window down (if equipped)
- Headlight illumination (if installed)

## Security Functions

- Security System arm / disarm
  - Using PowerCode remote control transmitters
  - Using factory RKE keyfobs (if equipped)
  - Verify interior door trim unlock switch DOES NOT disarm system
- All entry points trip alarm cycle
- Status indicator flashes when armed
- Shock sensor settings (lite-touch & full shock)

## Remote start convenience functions

- Heater & A/C operation during remote start
- Rear defroster (if installed)

## Remote start safety functions

- No remote start activation with the ignition key inserted into the ignition switch (5-chirps)
- No remote start activation with the vehicle's hood open (2-chirps)
- No remote start activation with the vehicle's brake pedal depressed (2-chirps)
- No remote start activation with the vehicle's doors open (3-chirps)
- No power window or moonroof (if equipped) operation when remote started (certain models only - see I-sheets).



# PC-14 WIRING HARNESS LEGEND (VSS or RMST - Type "A")

EXTENDED FUNCTION

MAIN HARNESS

CAR START

1	2	3	4	5	6	7	8	9
10	11	12	13			14	15	16

1	2	3	4	5	6	7	8	9	10	11	12		
13	14	15	16	17	18			19	20	21	22	23	24

1	2	3	4	5	6
7	8			9	10

WIRE END VIEWS

Main Harness (24-way) (* = Security Only ** = Remote Start Only)			Car Start Harness (10-way) (Remote Start Only)		
Terminal	Wire Color	Function	Terminal	Wire Color	Function
A-1	WHITE	Parking Light Output	B-7	BROWN	Brake Input
A-2	BLUE	Door Lock Output*	B-8	BLACK/WHITE	Key-in-sense Input
<b>A-2</b>	<b>ORANGE</b>	<b>HVAC Output**</b>	B-9	VIOLET/WHITE	Tach Sense Input
A-3	BLACK/WHITE	Dome Light Output*	B-10	BLUE/BLACK	Active Out
<b>A-3</b>	<b>PINK</b>	<b>Ignition 2 Output**</b>	<b>Extended Function Harness (16-way) (Security Kit Only)</b>		
A-4	RED	Battery	Terminal	Wire Color	Function
A-5	BLACK	Ground	C-1	BLUE/BLACK	Door Lock Switch Input
A-6	VIOLET/RED	Starter Interrupt (Key side)*	C-2	BLACK/GREEN	AUX 3
A-7	PINK	Ignition 1 Input/Output	C-3	GREEN/BLACK	Door Unlock Switch Input
A-8	VIOLET	Starter Interrupt (Motor side)*	C-4	LT.GREEN/BLACK	Factory Perimeter Alarm Disarm Output
A-9	BROWN	Disarm Input*	C-5	Open	-
A-10	YELLOW/WHITE	Door Trigger Input Pull-up*	C-6	Open	-
A-11	WHITE/BLUE	Arm Input*	C-7	BROWN/TAN	Trunk Release Disarm Input
A-12	LT.GREEN	Unlock Switch Sense Input*	C-8	BLUE	Trunk Ajar Input
A-13	TAN	Trunk Release/Driver Door Unlock Release Output*	C-9	TAN/RED	Trunk Release/Driver Door Unlock Switch Input
<b>A-13</b>	<b>VIOLET</b>	<b>Starter (Crank) Output**</b>	C-10	RED/WHITE	Headlight Output / AUX 1
A-14	GREEN	Door Unlock Output*	C-11	BLUE/WHITE	Rear Defroster Output / AUX 2
A-15	RED	Siren Feed*	C-12	GREEN/WHITE	Memory 1 Output
A-16	BLACK	Siren Output*	C-13	YELLOW/GREEN	Memory 2 Output
A-17	BROWN	Programming/Override Button	C-14	Open	-
A-18	BROWN	Programming/Override Button	C-15	Open	-
A-19	GRAY	Hood Open Switch Input	C-16	Open	-
A-20	GREEN/VIOLET	Door Ajar Switch Input			
A-21	BROWN/BLACK	Horn Relay Output			
A-22	RED	LED			
A-23	BLACK	LED			
A-24	BLUE/GREEN	(-) Drivers Door Unlock/ Trunk release Output*			
<b>A-24</b>	<b>BLUE</b>	<b>Door Lock Output**</b>			

# PC-34 WIRING HARNESS LEGEND (RKE/VSS/RMST or RMST - Type "B" or "C")

EXTENDED FUNCTION

MAIN HARNESS

CAR START

1	2	3	4	5	6	7	8	9
10	11	12	13			14	15	16

1	2	3	4	5	6	7	8	9	10	11	12		
13	14	15	16	17	18			19	20	21	22	23	24

1	2	3	4	5	6
7	8			9	10

WIRE END VIEWS

Main Harness (24-way)			Car Start Harness (10-way)		
Terminal	Wire Color	Function	Terminal	Wire Color	Function
A-1	WHITE	Parking Light Output	B-1	BLUE	HVAC2 Feed
A-2	BLUE	Door Lock Output	B-2	RED	HVAC1 Feed
A-3	BLACK/WHITE	Dome Light Output	B-3	PINK/WHITE	Ignition 2 Output
A-4	RED	Battery	B-4	ORANGE	HVAC 1 Output
A-5	BLACK	Ground	B-5	ORANGE/WHITE	HVAC 2 Output
A-6	VIOLET/RED	Starter Interrupt (Key side)	B-6	Open	-
A-7	PINK	Ignition 1 Input/Output	B-7	BROWN	Brake Input
A-8	VIOLET	Starter Interrupt (Motor side)	B-8	BLACK/WHITE	Key-in-sense Input
A-9	BROWN	Disarm Input	B-9	VIOLET/WHITE	Tach Sense Input
A-10	YELLOW/WHITE	Door Trigger Input Pull-up	B-10	BLUE/BLACK	Active Out
A-11	WHITE/BLUE	Arm Input	<b>Extended Function Harness (16-way)</b>		
A-12	LT.GREEN	Unlock Switch Sense Input	<b>Terminal</b>	<b>Wire Color</b>	<b>Function</b>
A-13	TAN	Trunk Release/Driver Door Unlock Release Output	C-1	BLUE/BLACK	Door Lock Switch Input
A-14	GREEN	Door Unlock Output	C-2	BLACK/GREEN	AUX 3
A-15	RED	Siren Feed	C-3	GREEN/BLACK	Door Unlock Switch Input
A-16	BLACK	Siren Output	C-4	LT.GREEN/BLACK	Factory Perimeter Alarm Disarm Output
A-17	BROWN	Programming/Override Button	C-5	Open	-
A-18	BROWN	Programming/Override Button	C-6	Open	-
A-19	GRAY	Hood Open Switch Input	C-7	BROWN/TAN	Trunk Release Disarm Input
A-20	GREEN/VIOLET	Door Ajar Switch Input	C-8	BLUE	Trunk Ajar Input
A-21	BROWN/BLACK	Horn Relay Output	C-9	TAN/RED	Trunk Release/Driver Door Unlock Switch Input
A-22	RED	LED	C-10	RED/WHITE	Headlight Output / AUX 1
A-23	BLACK	LED	C-11	BLUE/WHITE	Rear Defroster Output / AUX 2
A-24	BLUE/GREEN	(-) Drivers Door Unlock/Trunk release Output	C-12	GREEN/WHITE	Memory 1 Output
			C-13	YELLOW/GREEN	Memory 2 Output
			C-14	Open	-
			C-15	Open	-
			C-16	Open	-

# Circuit Testing - Identifying Circuit Polarity

1

Use the following procedure to ensure proper vehicle circuit has been identified:

- Digital Volt Meter (DVM) set to "DC Volts".
- Negative lead (Black) connected to a chassis ground.
- Positive lead (Red) connected to circuit under test.
- Observe reading from meter.

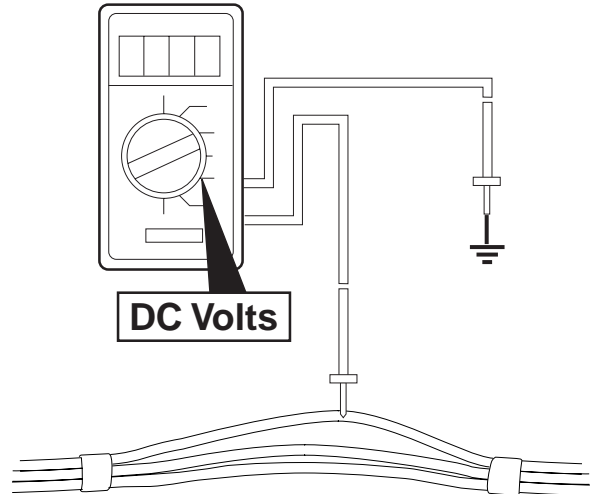

2

Actuate the circuit under test.

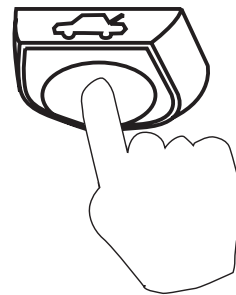

3

- Observe reading from meter.
- A reading of 0V transiting to +12V when the switch is pressed, indicates that the circuit under test is a **Positive** polarity circuit.
- A reading of +12V transiting to 0V when the switch is pressed, indicates that the circuit under test is a **Negative** polarity circuit.



**NOTE:** When testing a Negative polarity circuit, the stand by voltage will not always be +12V. In some cases the reading observed prior to actuating the circuit could be less than one (1) volt. However, when actuated the observed voltage will be 0V or very close to it.

0V → 12V

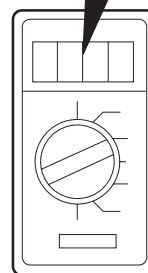

**POSITIVE  
POLARITY  
CIRCUIT**

12V → 0V

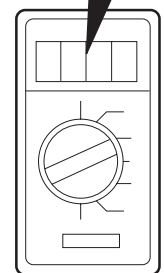

**NEGATIVE  
POLARITY  
CIRCUIT**

# Wire Connection Procedures

## 1 Inline wire splice procedure

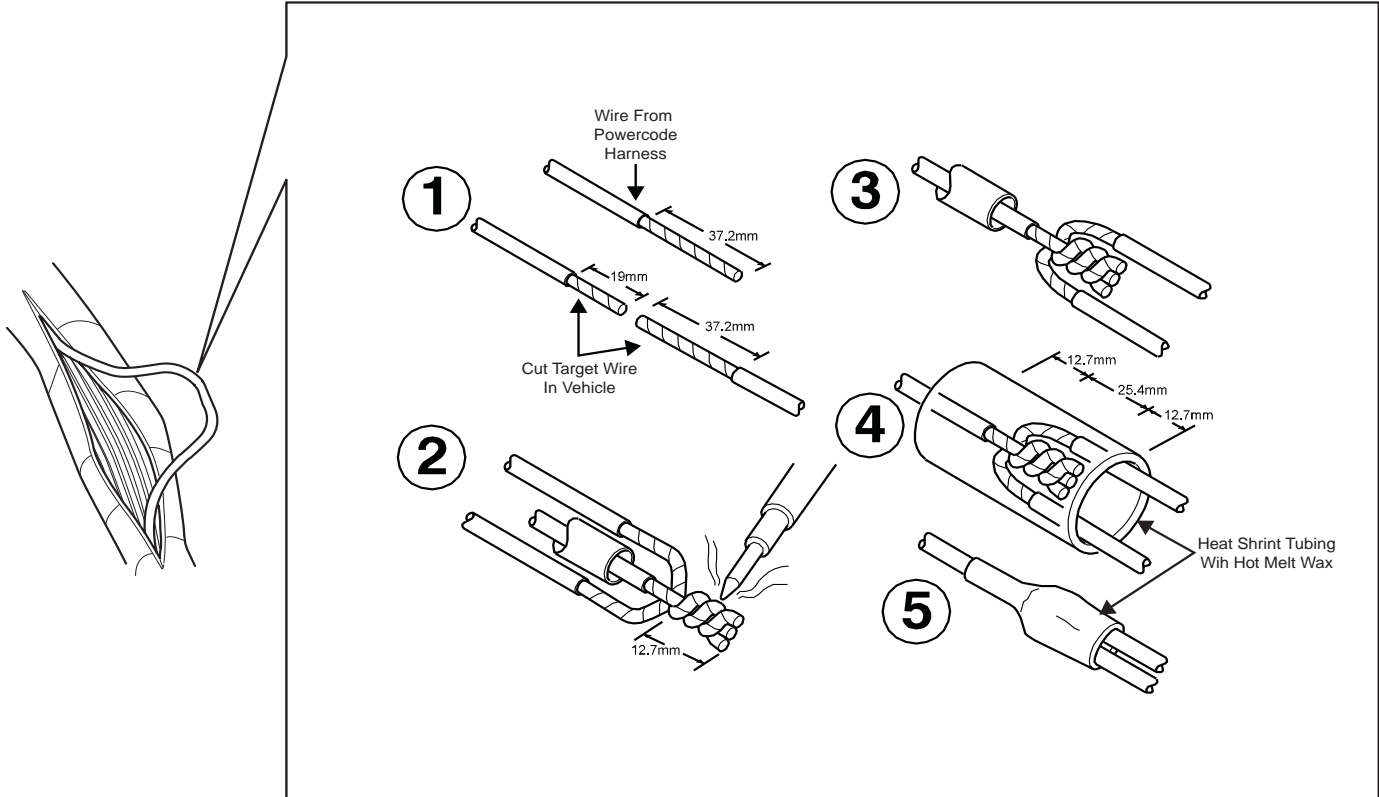
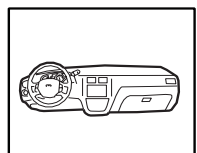
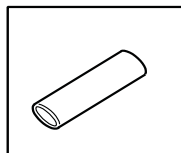
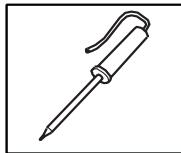
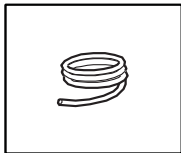
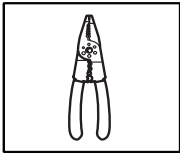
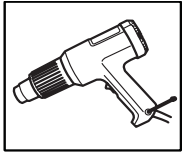
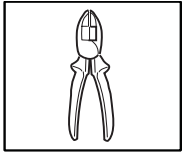

**NOTE:** TO INSURE PROPER INSTALLATION, USE THE FOLLOWING GUIDELINES:

APPLY FLOCK TAPE TO SHARP OR JAGGED AREAS DURING INSTALLATION OF WIRE HARNESS

APPLY FLOCK TAPE TO WIRE HARNESS IN AREAS WHERE SQUEAK AND RATTLE CONDITIONS MAY OCCUR, i.e. CONNECTORS

SECURE WIRE HARNESS AT LEAST 6MM FROM EXISTING SENSORS OR MODULES

SECURE WIRE HARNESS AT LEAST 19MM FROM MOVING PARTS, i.e. VACUUM MOTORS, etc.

**NOTE:** IF AN UNRELIABLE METHOD OF WIRE SPLICING IS USED WHEN INSTALLING ELECTRICAL ADD-ON EQUIPMENT, IT MAY CAUSE ELECTRICAL SYSTEMS TO MALFUNCTION BY CREATING VARIABLE RESISTANCE OR A SHORT CIRCUIT. VARIABLE RESISTANCE CAN RESULT FROM OXIDATION/CORROSION CAUSED BY AIR WITHIN THE JOINT AND A SHORT CIRCUIT CAN RESULT FROM THE MOISTURE ON THE JOINT

HEAT SHRINK TUBING MUST CONTAIN HOT MELT WAX. THIS WILL CREATE A WATERPROOF AND AIRTIGHT JOINT.

SOLDER MUST BE ROSIN CORE MILDLY ACTIVATED (RMA). DO NOT USE ACID CORE SOLDER.

DO NOT USE CRIMP-CONNECTORS OF ANY KIND. THEY ARE NOT A ROBUST METHOD FOR SPLICING IN NEW WIRES.

## Wire Connection Procedures

### 2 Ended Wire Splice Procedure

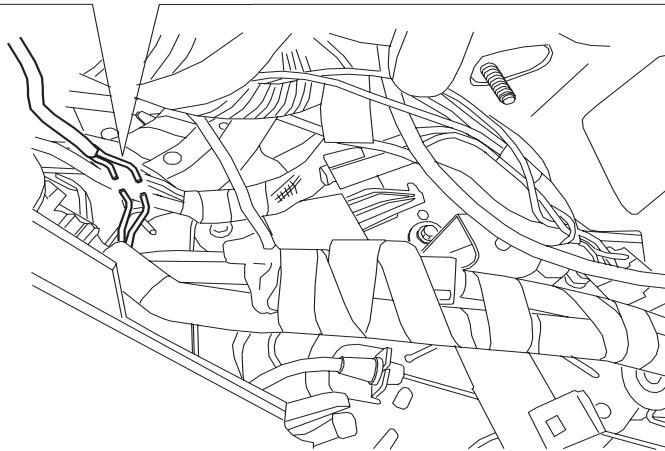
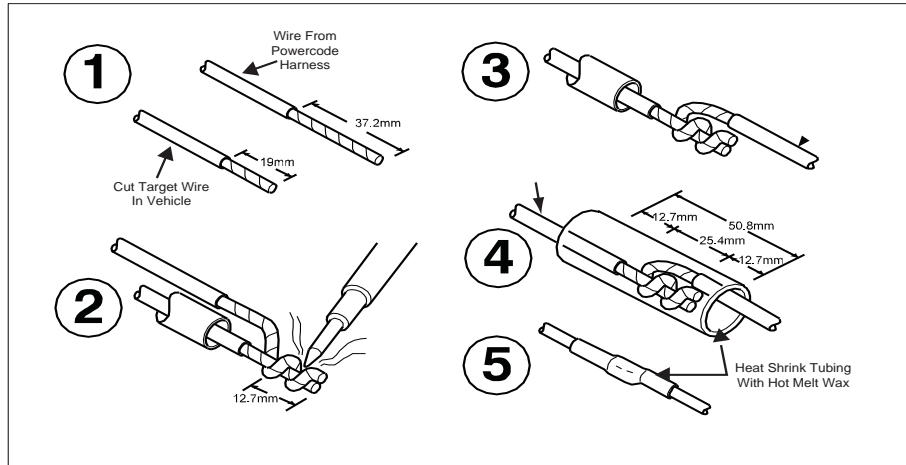
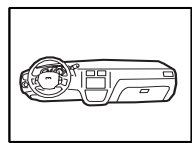
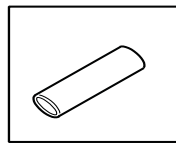
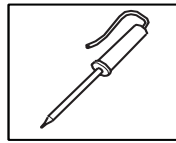
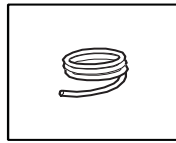
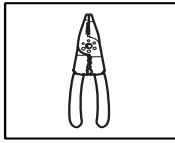
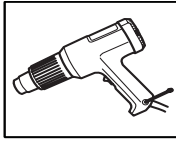
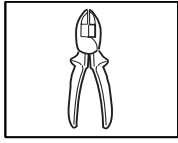

**NOTE:** TO INSURE PROPER INSTALLATION, USE THE FOLLOWING GUIDELINES:

APPLY FLOCK TAPE TO SHARP OR JAGGED AREAS DURING INSTALLATION OF WIRE HARNESS

APPLY FLOCK TAPE TO WIRE HARNESS IN AREAS WHERE SQUEAK AND RATTLE CONDITIONS MAY OCCUR, i.e. CONNECTORS

SECURE WIRE HARNESS AT LEAST 6MM FROM EXISTING SENSORS OR MODULES

SECURE WIRE HARNESS AT LEAST 19MM FROM MOVING PARTS, i.e. VACUUM MOTORS, etc.

**NOTE:** IF AN UNRELIABLE METHOD OF WIRE SPLICING IS USED WHEN INSTALLING ELECTRICAL ADD-ON EQUIPMENT, IT MAY CAUSE ELECTRICAL SYSTEMS TO MALFUNCTION BY CREATING VARIABLE RESISTANCE OR A SHORT CIRCUIT. VARIABLE RESISTANCE CAN RESULT FROM OXIDATION/CORROSION CAUSED BY AIR WITHIN THE JOINT AND A SHORT CIRCUIT CAN RESULT FROM THE MOISTURE ON THE JOINT

HEAT SHRINK TUBING MUST CONTAIN HOT MELT WAX. THIS WILL CREATE A WATERPROOF AND AIRTIGHT JOINT.

SOLDER MUST BE ROSIN CORE MILDLY ACTIVATED (RMA). DO NOT USE ACID CORE SOLDER.

DO NOT USE CRIMP-CONNECTORS OF ANY KIND. THEY ARE NOT A ROBUST METHOD FOR SPLICING IN NEW WIRES.