

**Classification:**

BT11-031

**Reference:**

ITB12-003

**Date:**

January 13, 2012

## 2009-2011 G37 CONVERTIBLE; SQUEAK / RATTLE / BUZZ NOISE FROM ROOF AREA

This bulletin supersedes ITB10-071. Discard all copies of ITB10-071.

**APPLIED VEHICLE:** 2009 - 2011 G37 Convertible (HV36)

**IF YOU CONFIRM:**

There is a squeak, rattle, or "buzz" type noise coming anywhere from the retractable hard top or trunk area while driving.

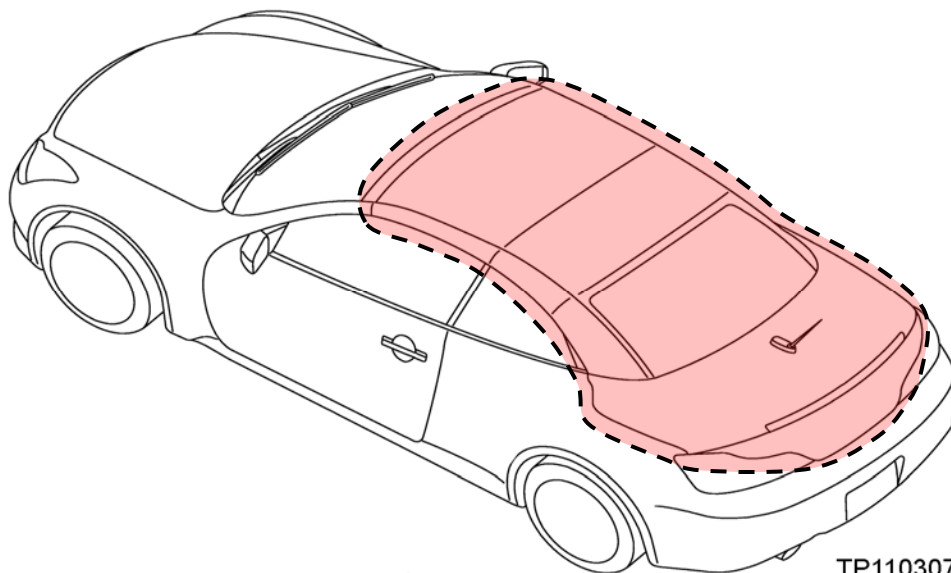

TP110307

**ACTION:**

 Perform all repairs as outlined in **SERVICE PROCEDURE**.

**NOTE:** This bulletin does not apply if: A rub type noise is heard, or if this bulletin has been previously performed. Refer to ASIST for further diagnosis.

**IMPORTANT:** The purpose of **ACTION** (above) is to give you a quick idea of the work you will be performing. You **MUST** closely follow the entire Service Procedure (starting on page 5) as it contains information that is essential to successfully completing this repair.

Infiniti Bulletins are intended for use by qualified technicians, not 'do-it-yourselfers'. Qualified technicians are properly trained individuals who have the equipment, tools, safety instruction, and know-how to do a job properly and safely. **NOTE:** If you believe that a described condition may apply to a particular vehicle, **DO NOT** assume that it does. See your Infiniti dealer to determine if this applies to your vehicle.

**PARTS INFORMATION**

DESCRIPTION	PART #	QUANTITY
PAD (felt cloth and tape kit)	97085-JJ52D	1 (a)
MALE ASSY – DOVETAIL	844A7-JJ50B	(b)

- (a) There are three sheets of felt cloth in three different thicknesses. Use the chart on page 3 to determine the location of each thickness of felt cloth. All pieces will need to be cut to size.
- (b) Up to two pieces, as needed.

**CLAIMS INFORMATION**

Submit a Primary Part (PP) line claim using the following claims coding:

DESCRIPTION	PFP	OP CODE	SYM	DIA	FRT
Repair Rear Roof	97160-JJ50A	SX08AA	ZL	46	2.7

## Felt cloth and tape kit



### Felt cloth:

Thickness	Size	Qty	Locations
0.45 mm (19 mm wide) (Tape roll)	19 x 50 mm	8	Plate, and rear roof <u>upper</u> garnish clips
	10 x 50	1	Rear rib locator
	19 x 900	1	Rear rib edge
	19 x 530	1	Front roof garnish
1 mm (Sheet)	10 x 50	17	Various Clips
	30 x 35	5	Rear rib emboss
	10 x 100	2	Rear roof lower garnish
2 mm (Sheet)	20 x 300	4	Rear rib
	20 x 80	2	Center roof panel pin
	20 x 20	2	Headlining mount
3 mm (Sheet)	10 x 20	2	Plate
	20 x 30	6	Flipper door
	15x15	2	Parcel shelf (adjusting screw)

Here are examples on how to cut out pieces from each felt cloth sheet:

1 mm sheet

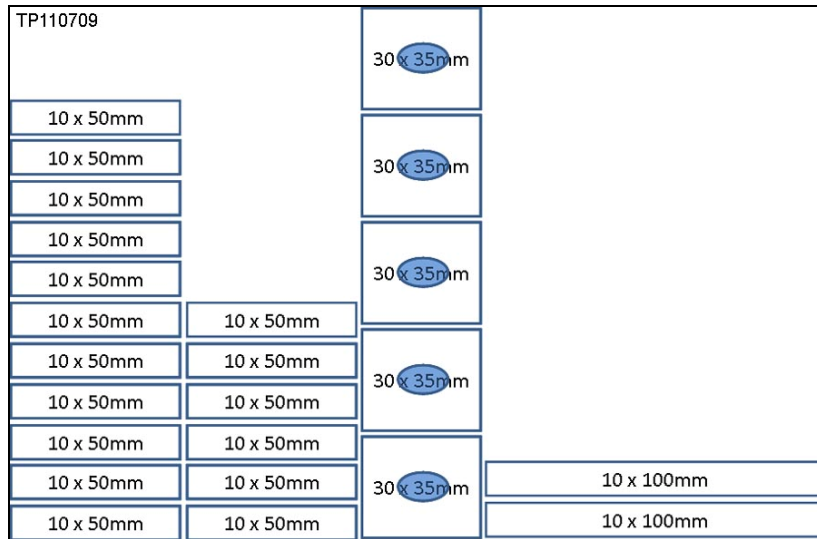

2 mm sheet

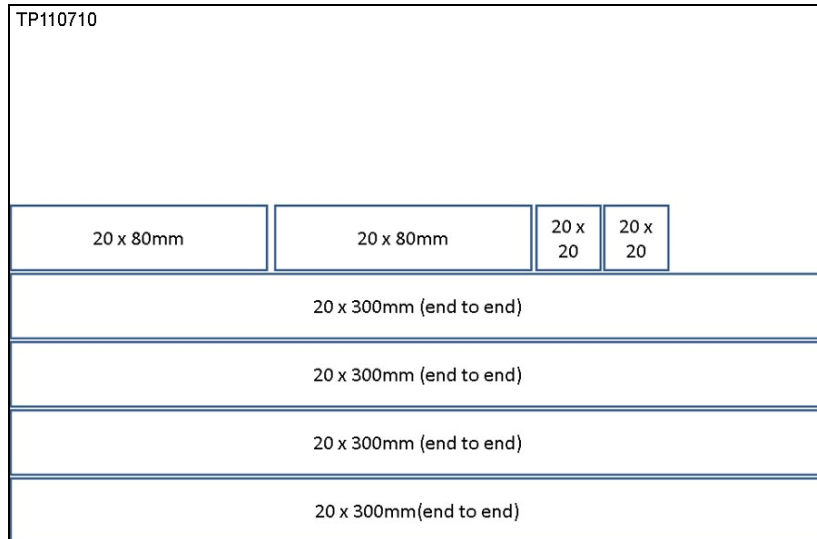

3 mm sheet

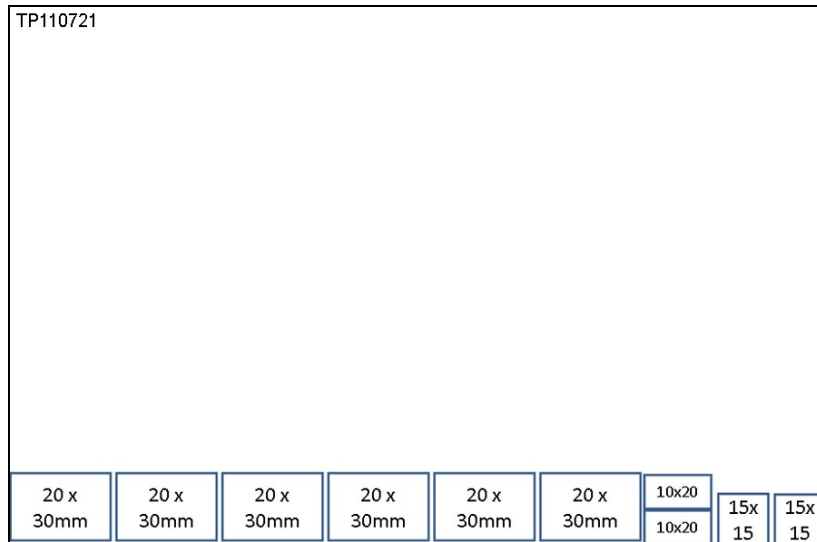

## SERVICE PROCEDURE

### NOTES:

Perform repairs in a clean work environment. Make sure your hands/gloves are clean.  
Use fender covers when leaning over the sides of the vehicle.  
Use protective covering as needed if planning to be positioned inside the vehicle.

1. Remove the rear roof lower garnish with a suitable pry tool.

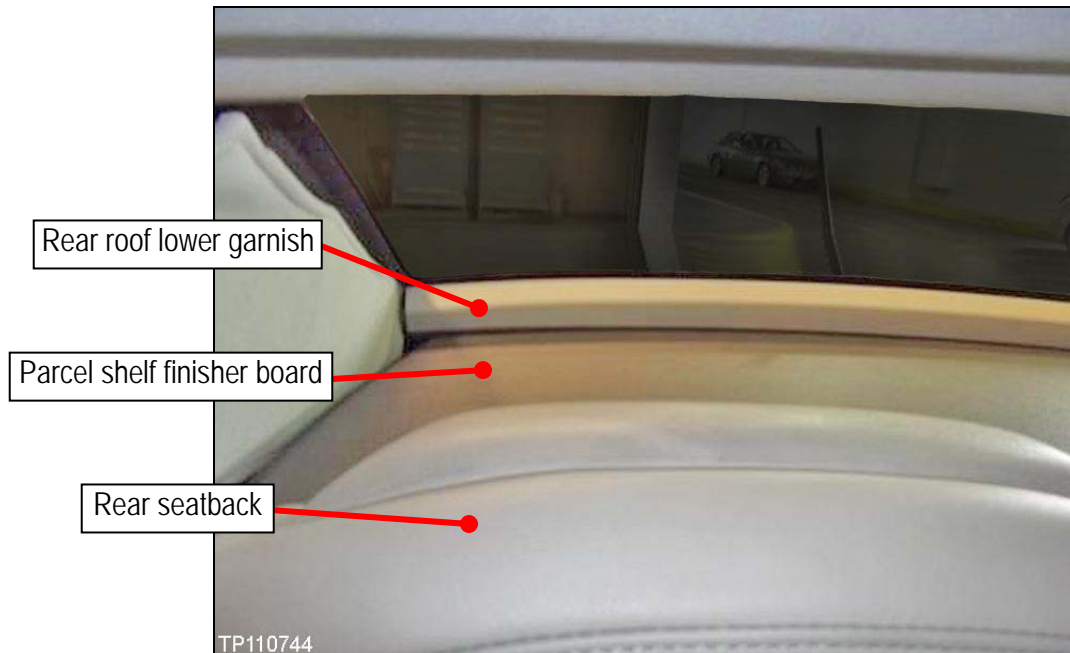

Figure 1

2. Cut two 10 mm x 100 mm pieces from the 1 mm sheet, and then install where shown in Figure 2.
3. Break off the locator pin with suitable pliers (see Figure 2).

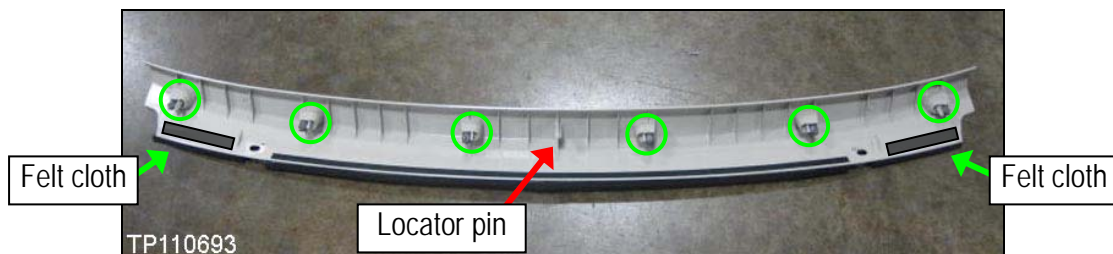

Figure 2

4. Cut six 10 x 50 mm pieces from the 1 mm sheet, and apply to the clips as shown in Figure 3, and where circled in Figure 2.



Figure 3

5. Next, position the retractable hard top (or hard top) as shown in Figure 4.  
**CAUTION:** When left in a partially closed position, the hard top could slowly drop which could cause hard top damage.
6. Remove the rear roof upper garnish with a suitable plastic pry tool.

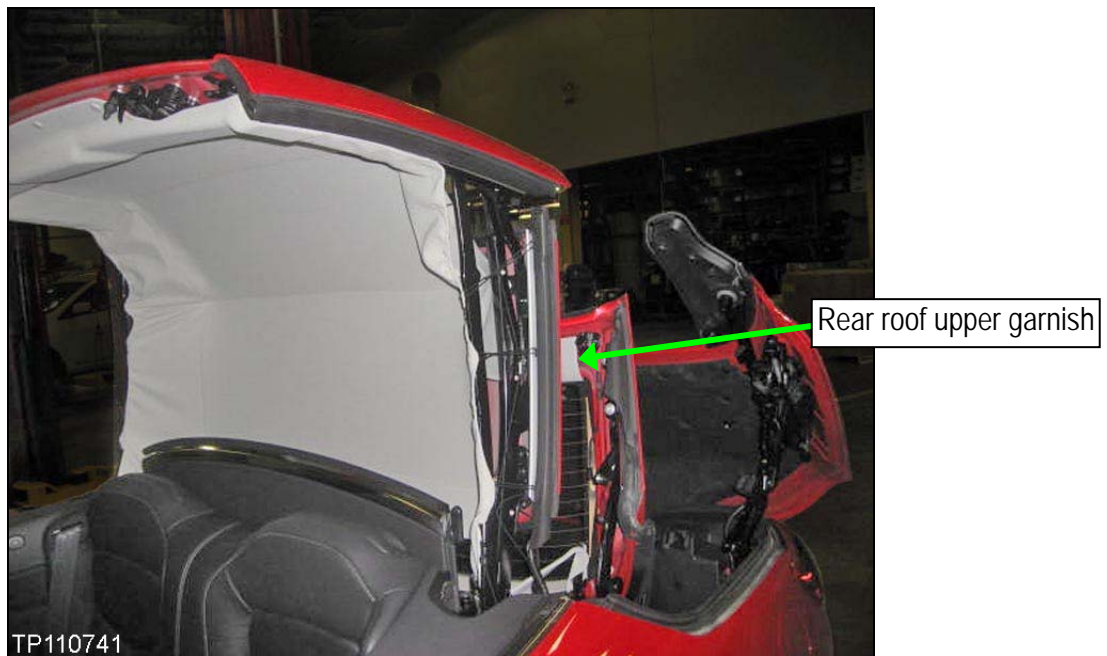

Figure 4

7. Break off flush both locator pins. See Figure 6, and arrows in Figure 5.



Figure 5

8. Remove any existing felt cloth from all clips.
9. Cut four 50 mm pieces from the tape roll, and then apply on the clips. See Figure 6, and circles in Figure 5.



Figure 6

10. Next, remove the front roof garnish with a suitable pry tool.



Figure 7

11. Apply felt cloth (from the tape roll) along the dotted line where shown in Figure 8.



Figure 8

- Figure 9 shows side view (cutaway) of felt cloth position.

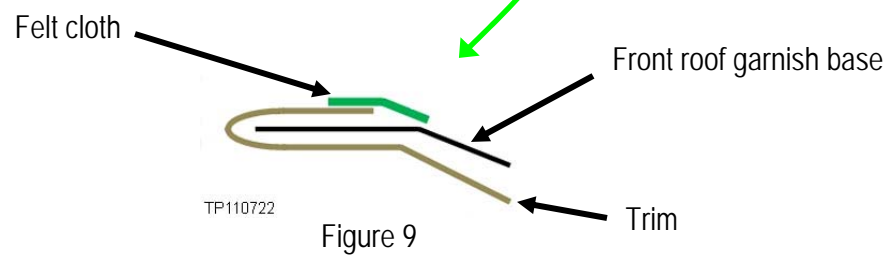

12. If felt cloth is already applied as shown in Figure 10, skip to Step 15.

- If not, go to the next step.



Figure 10

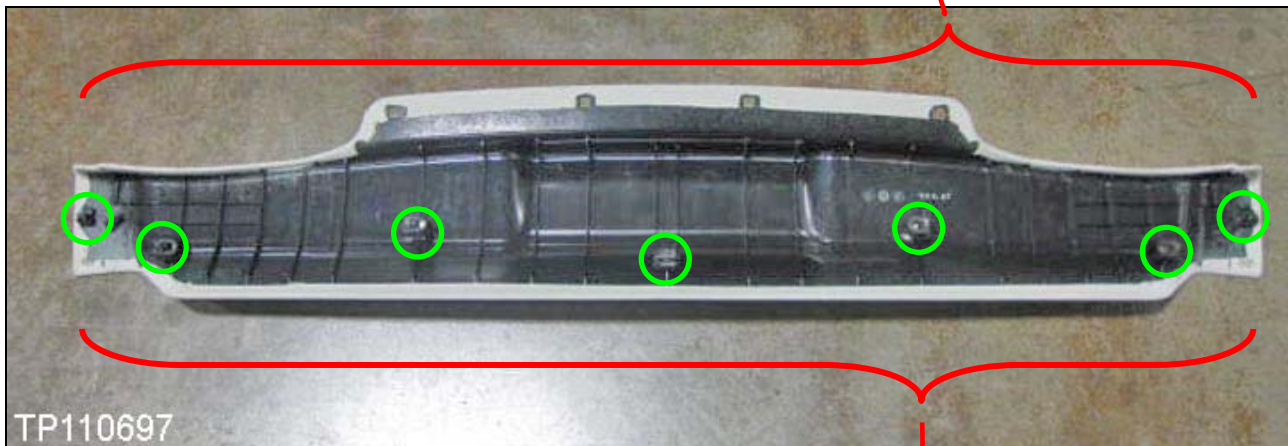

Figure 11

13. Remove any felt cloth found at the sides of the clips (see Figure 12).

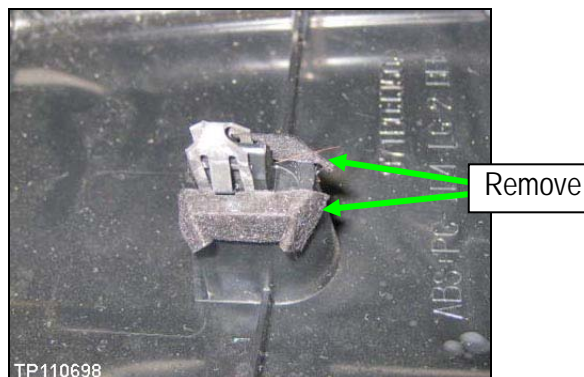

Figure 12

14. Cut seven 10 mm x 50 mm pieces from the 1 mm sheet, and apply to the clips as shown in Figure 10.



15. Apply felt cloth to both plates where shown in Figure 14.

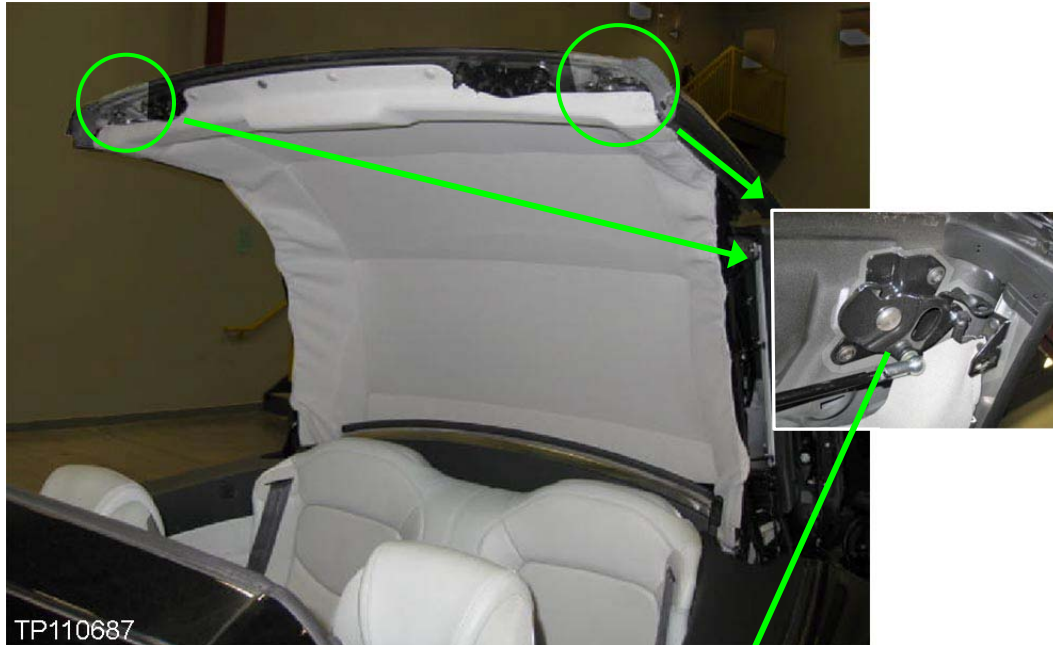

Figure 13

- Cut two 50 mm long pieces of felt cloth from the tape roll and wrap one at location #1 on each plate
- Cut two 10 mm x 20 mm pieces from the 3 mm felt cloth sheet, and then apply one at location #2 on each plate



Figure 14

16. Next, drop down the headlining and lay out on the rear back seat to access the rear rib (see Figure 15).

- Refer to the Electronic Service Manual (ESM) as needed.
- Do not entirely remove the headlining. Leave the tether cords fastened.

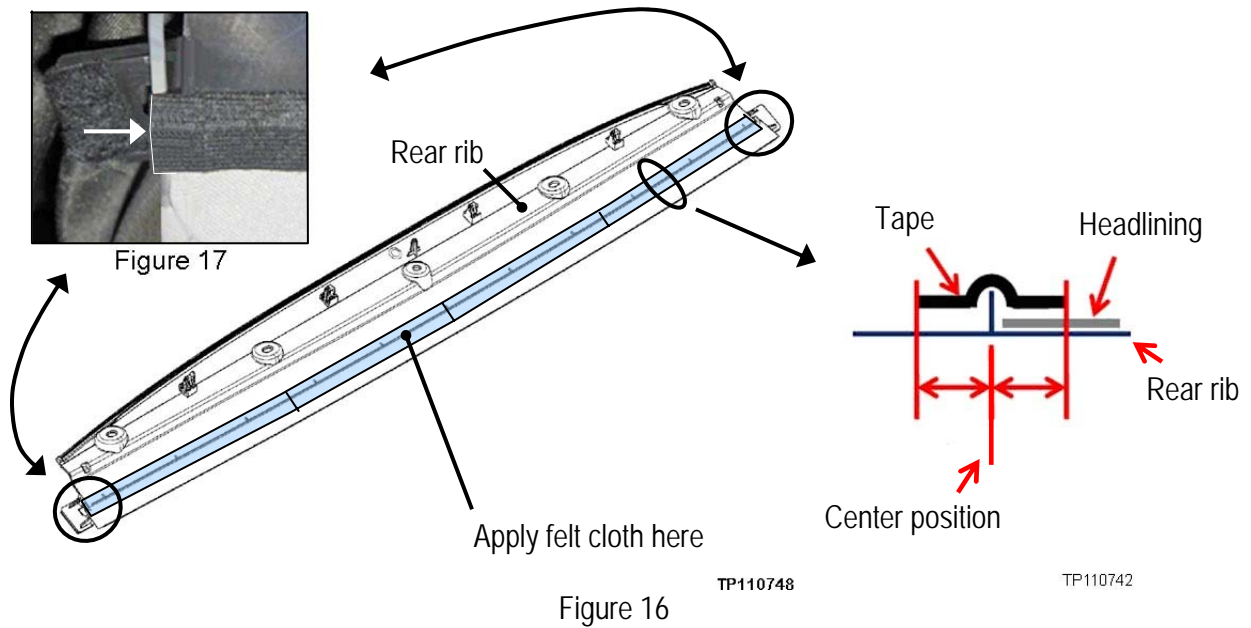
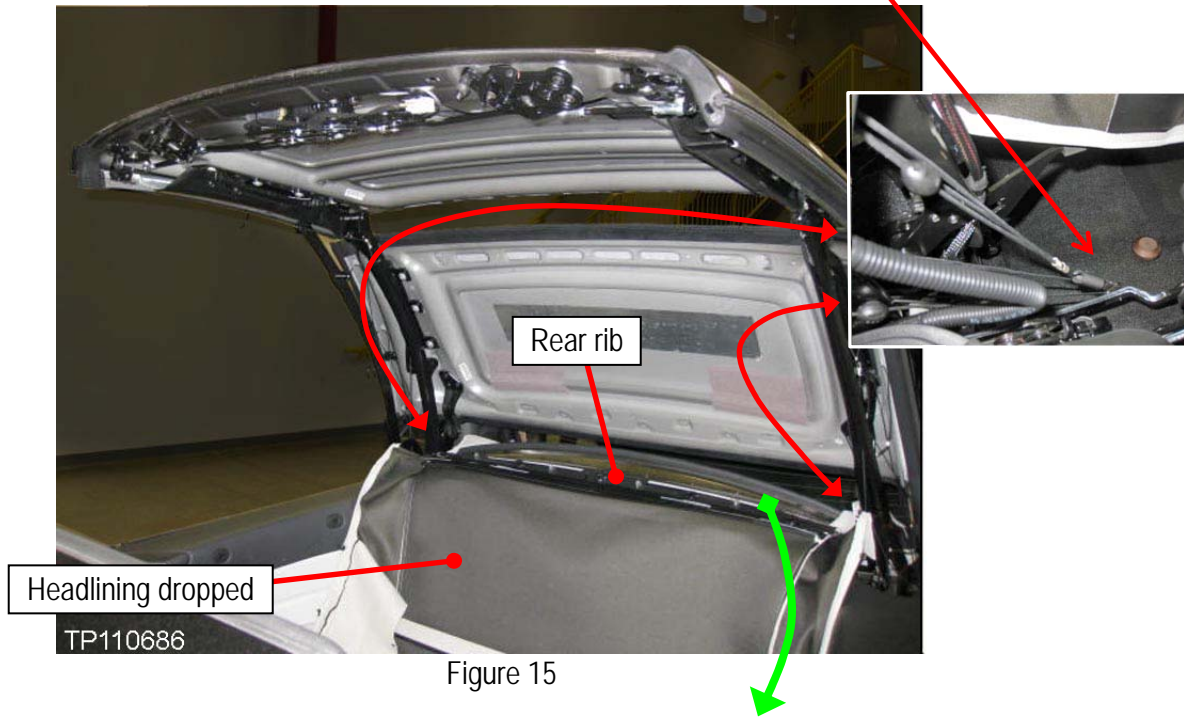

17. Remove any existing pieces of felt cloth where outlined in blue in Figure 16.

18. Cut four 20 mm x 300 mm pieces (approximate in length) from the 2 mm sheet.

19. Apply the cut pieces across the length of the rear rib where outlined in blue in Figure 16.

- Start and finish the application from edge to edge as shown in Figure 17.

20. Cut five 30 mm x 35 mm pieces from the 1 mm sheet.

21. Fold the longer length of each piece in half, and then cut a hole at the middle of the fold: 3 mm deep by 5 mm wide (see Figure 18).

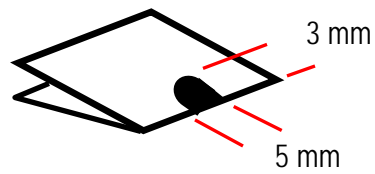

Figure 18

22. Apply these pieces where shown in Figure 19 and 20.

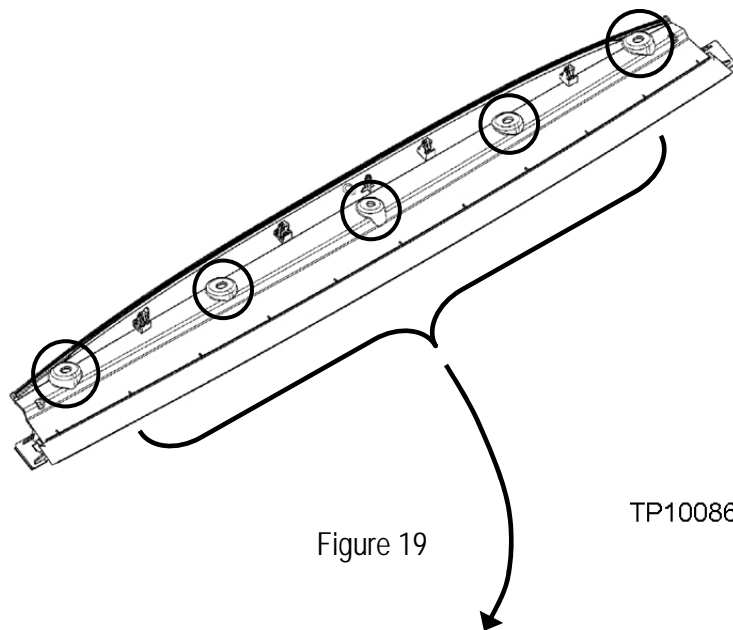

Figure 19

TP100862



Figure 20

23. Remove any existing pieces of clear tape from the edge of the rear rib (under blue outline). See Figure 21.

- It is ok to leave the tape's adhesive on the rib.

24. Cut pieces from the tape roll, and then apply on the edge where outlined in blue and black (see Figure 21 and 22).

- For easier application, cut the felt cloth in sections.

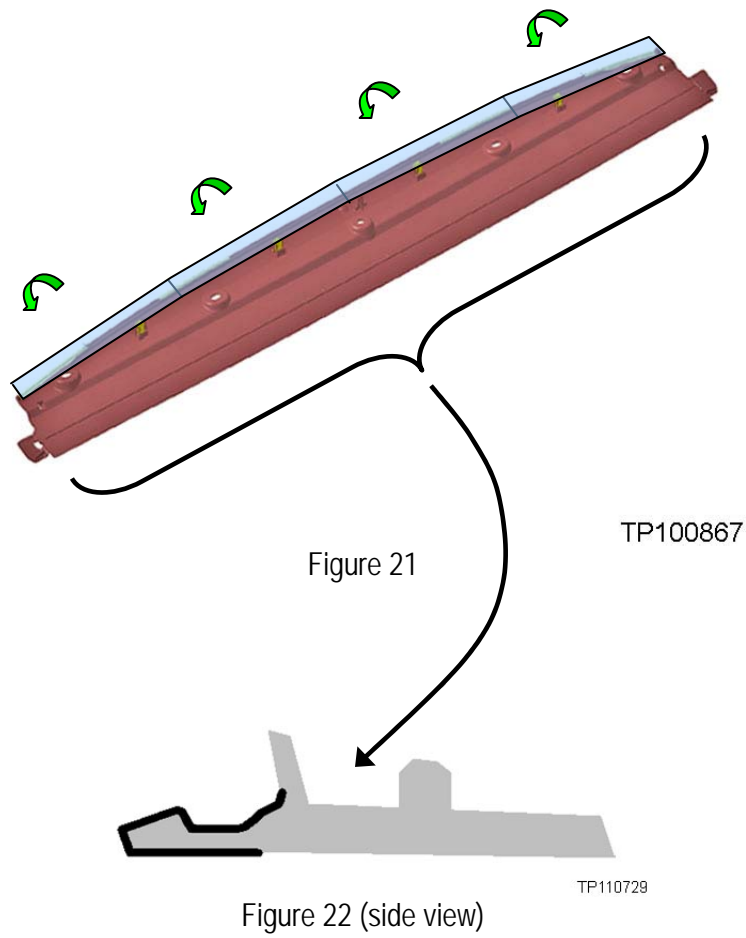

25. Remove any existing pieces of felt cloth from on and around the clips.

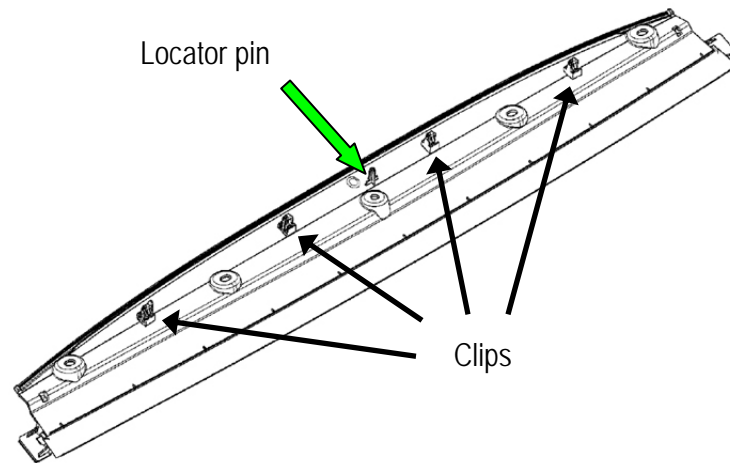

Figure 23

TP100862

26. Cut four 10 mm x 50 mm pieces from the 1 mm sheet, and then apply one to each clip where shown in Figure 23 and 24.

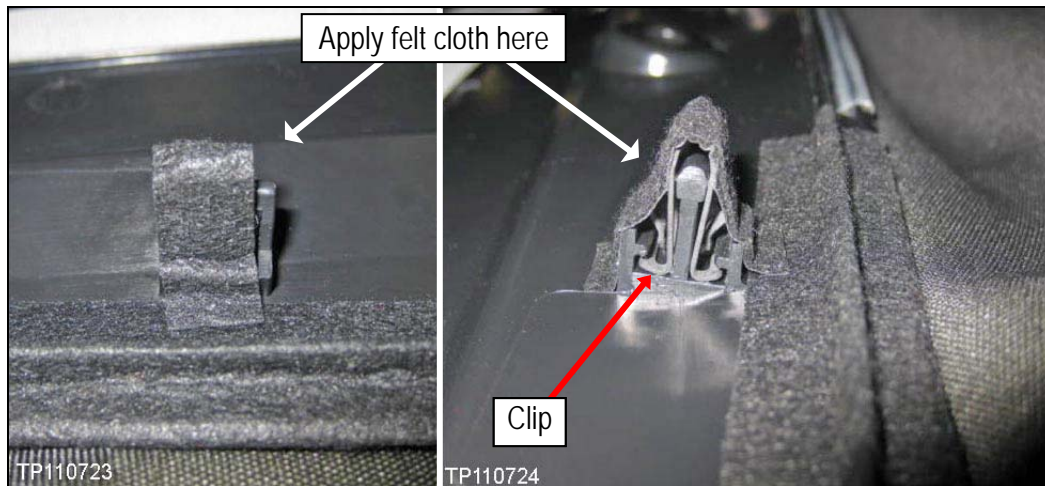

Figure 24

27. Break off flush the locator pin, and then apply a piece of felt cloth tape where broken off (see Figure 25).

- Felt cloth length (cut from the tape roll): 50 mm long

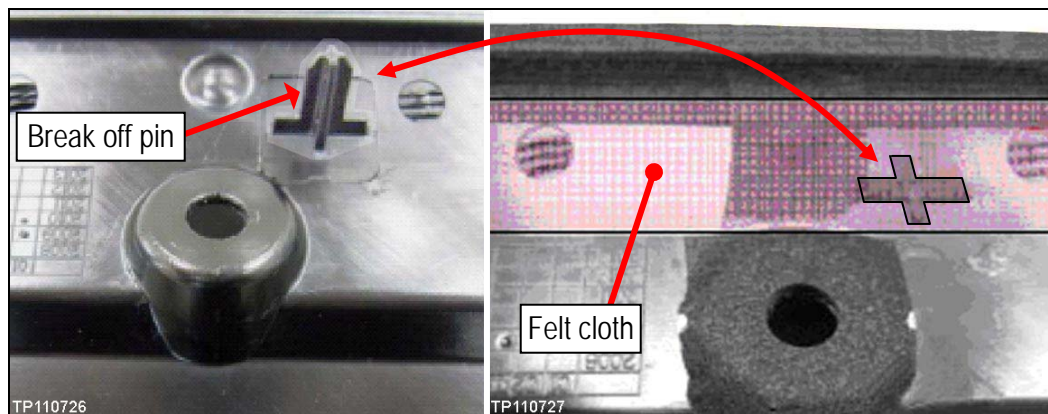

Figure 25

28. Inspect the center roof panel pins for felt cloth.

- If felt cloth is found, skip to step 30.
- If none, go to the next step.

29. Cut two 20 mm x 80 mm pieces from the 2 mm sheet, and then apply one on each center roof panel pin where shown in Figure 27.

**NOTE:** The center roof panel pin in Figure 27 is shown as removed for easier viewing. Neither pin does not need to be removed to apply the felt cloth.



Figure 26



Figure 27

30. Cut two 20 mm x 20 mm pieces from the 2 mm sheet, and then apply one on each part on each side of the vehicle where shown in Figure 29.



Figure 28



Figure 29

31. Cut two 50 mm pieces from the tape role, and then wrap one on each rear window defogger connector (see Figure 30).

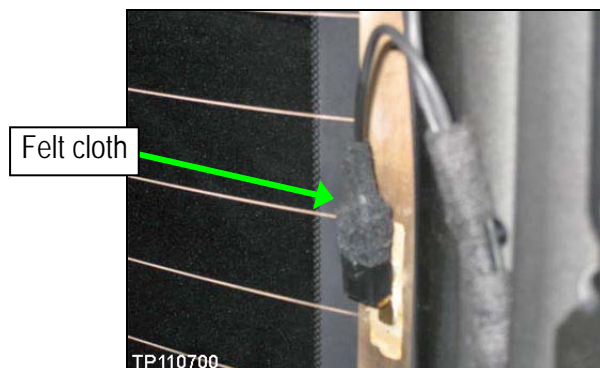

Figure 30

32. Apply "super glue" or equivalent adhesive to ALL tether cord clips where shown in Figure 31.



Figure 31

33. Reinstall the headlining.

- Refer to the ESM as needed.

Continue to the next page.



34. Next, fully close the hard top.
35. Proceed to open the hard top until the trunk lid is in the position shown in Figure 32.
36. If felt cloth is found under the flipper door where pointed in Figure 32, skip to Step 38.
  - If none found, go to the next step.

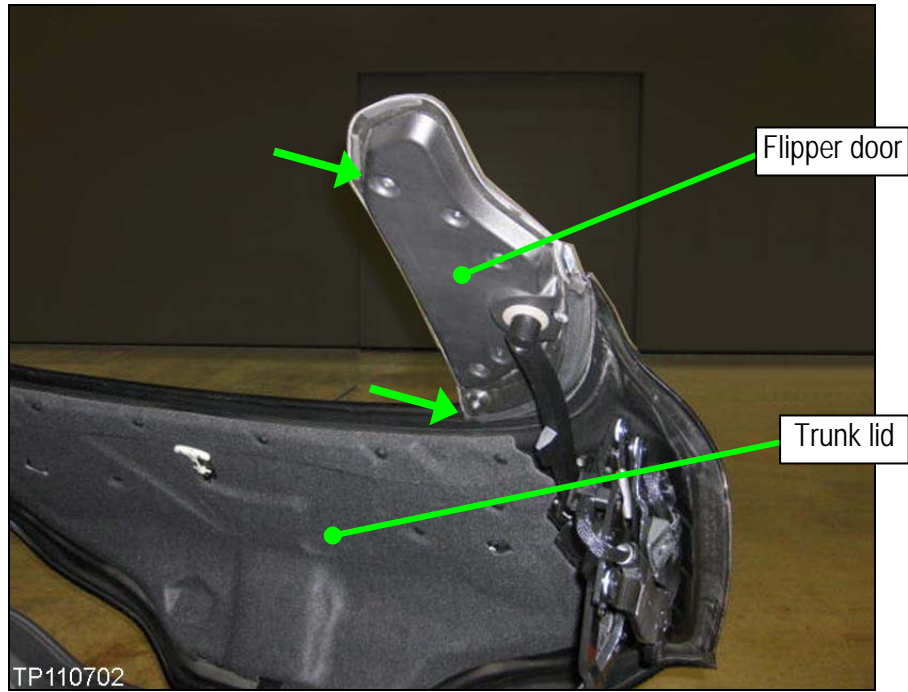

Figure 32

37. Cut six 20 mm x 30 mm pieces from the 3 mm sheet, and then apply under the flipper door as shown in Figure 33 and 34.

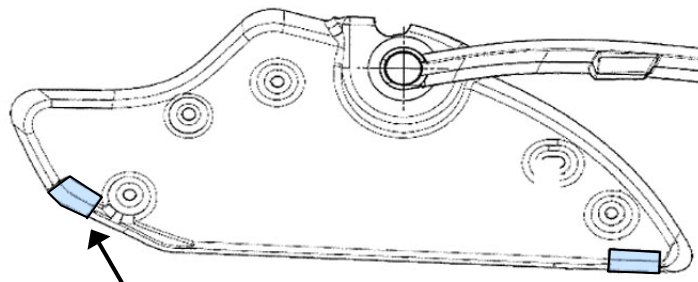

Figure 33

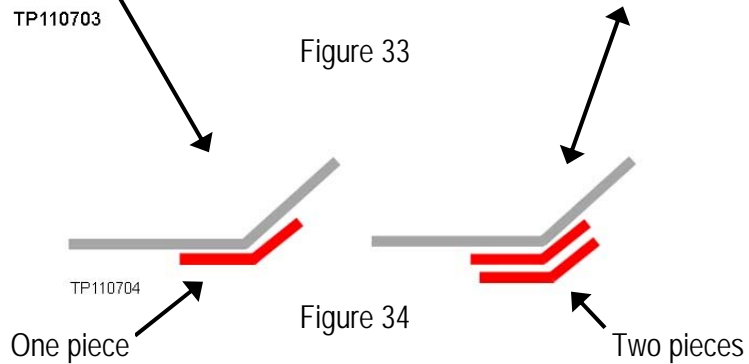

Figure 34

38. Next, adjust the side wedges on each side of the vehicle's trunk as shown in Figure 36.

- T40 Torx bolt torque: 23.5 - 27.5 N•m (2.4 - 2.8 kg-m, 17.3 - 20.3 ft lbs)

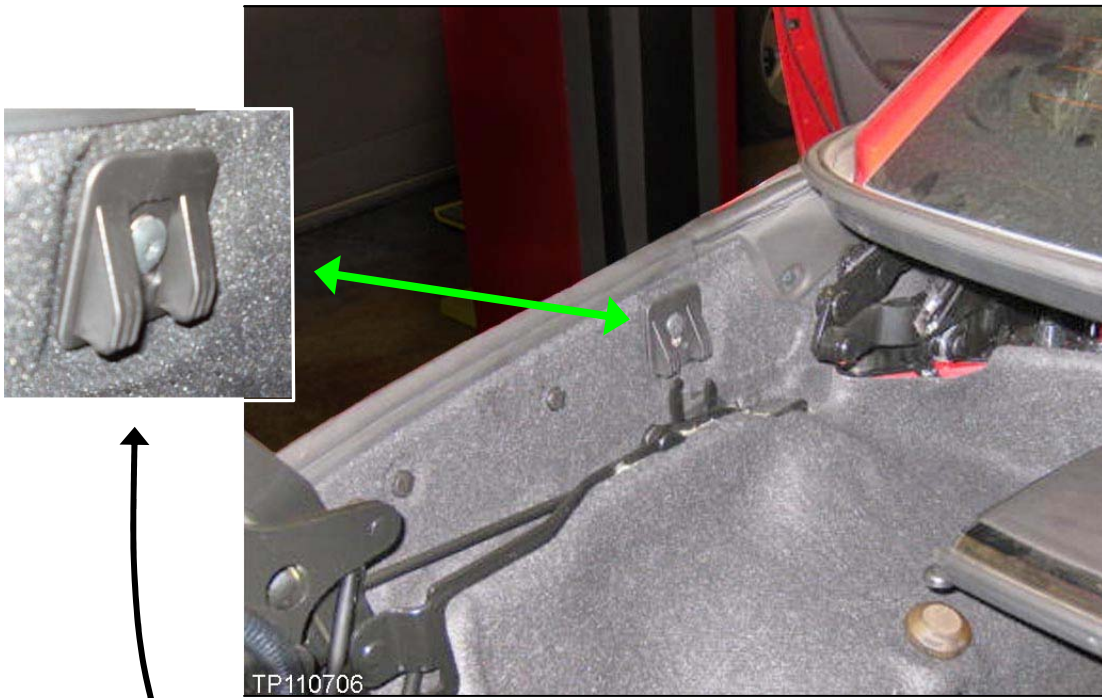

Figure 35

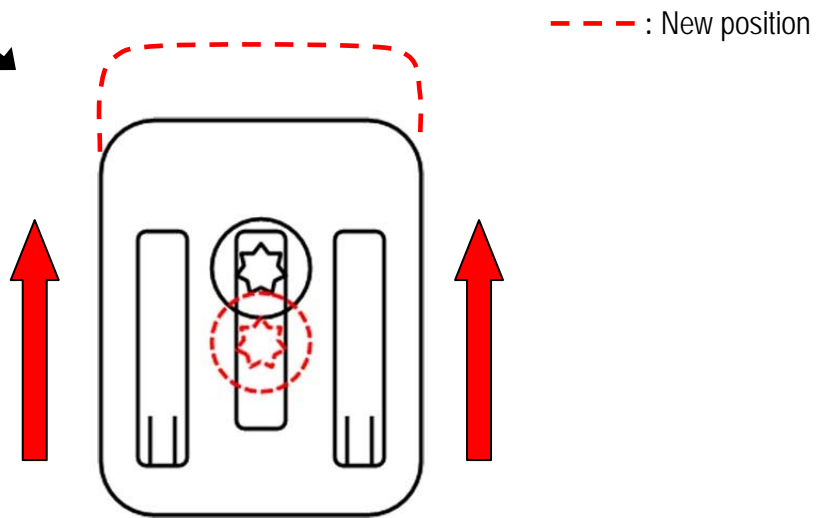

Figure 36

39. Next, fully close the hard top, and then open the trunk lid.

40. Adjust the trunk lid bumpers as follows:

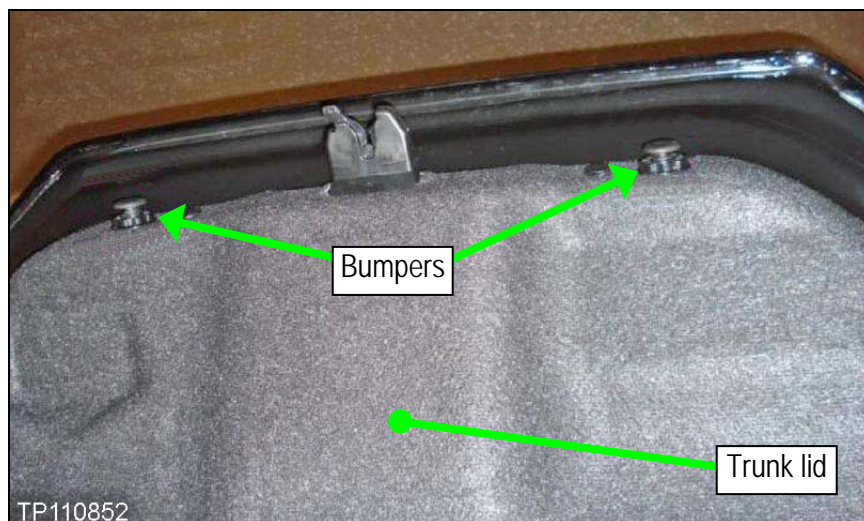

Figure 37

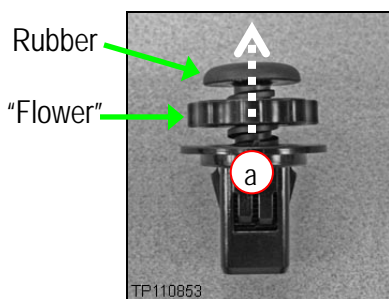

Figure 38

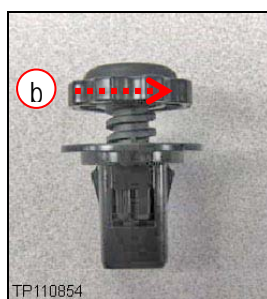

Figure 39



Figure 40

- a. Remove both bumpers, and then extend the rubbers all the way out (see Figure 37 and 38).
  - b. Turn the "flowers" until they bottom out under the rubbers (see Figure 39).
  - c. Reinstall both bumpers, and then carefully slowly close and latch the trunk lid.
  - d. Open the trunk lid, and then turn both "flowers" clockwise until they bottom out (see Figure 40).
- Make this adjustment with the bumpers still installed.
  - Make sure the rubbers do not move during this step.

41. Next, close the trunk lid, open the hard top as shown in Figure 41, and then inspect for felt cloth.

- If felt cloth is found, go to the next step.
- If felt cloth is not found, cut two 15 mm x 15 mm pieces from the 3 mm sheet, and then apply on the parcel shelf finisher board where the adjusting bolts come in contact (one on each side). See Figure 41.

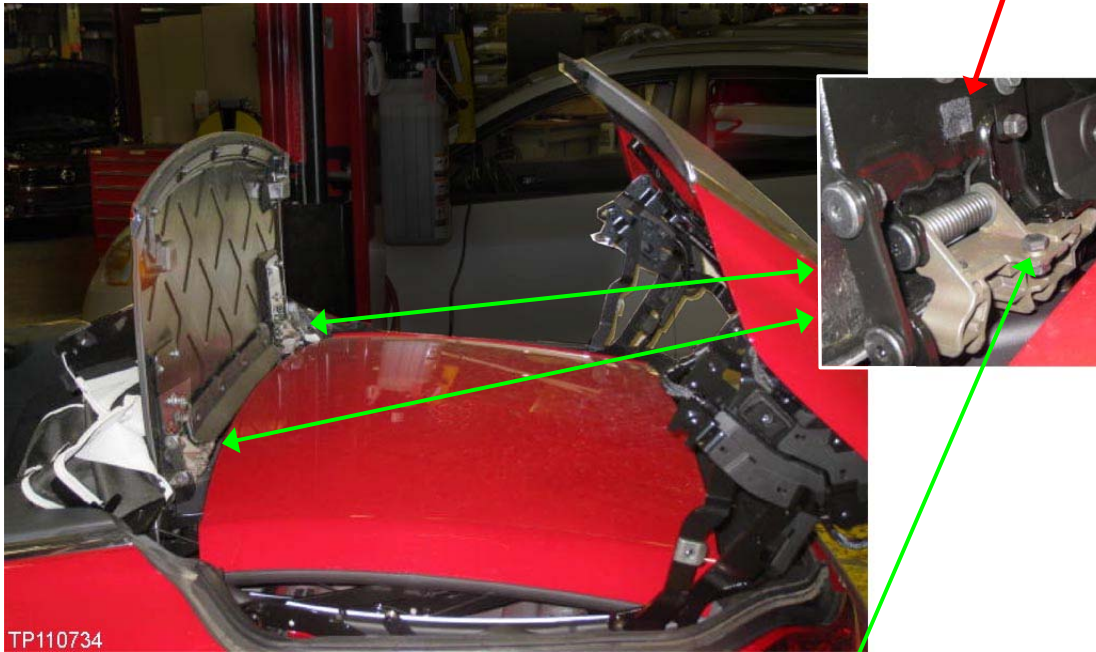

Figure 41

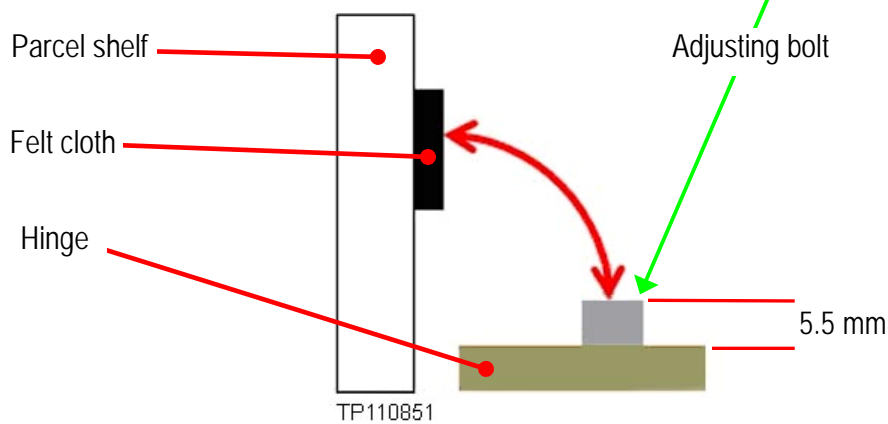

Figure 42

42. Locate the two adjusting bolts, and adjust the bolt heads to approximately 5.5 mm (0.20 inches). See Figure 41 and 42.

43. Close the hard top, and then open the trunk lid.

44. Measure the gap between the parcel shelf finisher board and rear roof lower garnish's sponge (it should be approximately 10 mm (0.40 inches)). See Figure 43, 44, and 45.

- If ok, go to the next step.
- If not, access the adjusting bolts and then readjust as needed.



Figure 43



Figure 44

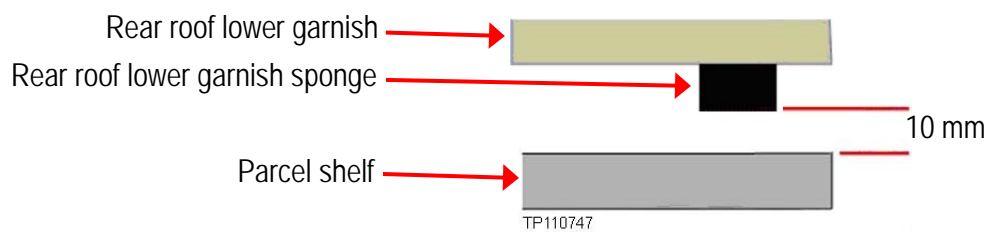

Figure 45 (side view)

45. Close the trunk lid, and then start opening the hard top until the trunk is opened as shown in Figure 32 on page 17, and 46 below.

46. Inspect both driver and passenger side hinge dove tails (see Figure 46).

- If either one is found worn, replace both.
  - T20 Torx bolt torque: 3.5 - 4.5 N•m (0.36 - 0.46 kg-m, 31.0 - 39.8 in lbs)

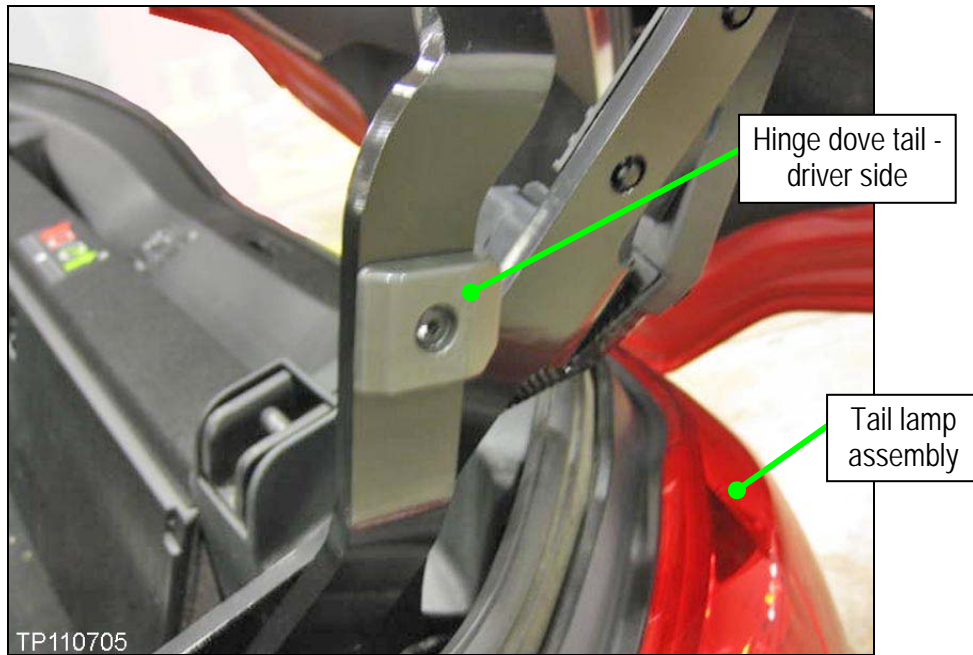

Figure 46

47. Fully close the hard top, road test, verify repairs.

