

**OPERATION
&
SERVICE MANUAL**

Torque-Switch Series[®]

Model GA370

**Pulse Width Modulated
Servo Amplifier**



GLENTTEK

"Solutions for Motion Control"

Table of Contents

CHAPTER ONE: INTRODUCTION

| | |
|--|---|
| 1.1 Introduction to the GA370 Manual | 4 |
|--|---|

CHAPTER TWO: DESCRIPTION and SPECIFICATIONS

| | |
|--|-----|
| 2.1 Description of the GA370..... | 5 |
| 2.2 Description of Features and Model Numbering Information..... | 5-6 |
| 2.2.1 Signal Input | 5 |
| 2.2.2 Velocity Mode or Current Mode Options..... | 5 |
| 2.2.3 External Programmable Current Limit..... | 5 |
| 2.2.4 + and - Limits..... | 5 |
| 2.2.5 Lock Out (Total Inhibit and Fault Monitor)..... | 5 |
| 2.2.6 Carrier Frequency | 5 |
| 2.2.7 Multi-Axes Configurations | 5 |
| 2.2.8 Example - Model Numbering..... | 6 |
| 2.3 Protection Circuits..... | 6 |
| 2.3.1 Over-Voltage Indicator (Red LED) | 6 |
| 2.3.2 Low-Speed Electronic Circuit Breaker (Red LED) | 6 |
| 2.3.3 High-Speed Electronic Circuit Breaker (Red LED) | 7 |
| 2.3.4 Temp Indicator Operation (Red LED) | 7 |
| 2.4 Specifications..... | 7-9 |
| 2.4.1 Output Power | 7 |
| 2.4.2 Input Power | 7 |
| 2.4.3 Signal Inputs..... | 7 |
| 2.4.4 Other Inputs and Outputs..... | 8 |
| 2.4.5 Mechanical (also see appendix B3-B6)..... | 8 |
| 2.4.6 Typical Factory Settings..... | 8 |

CHAPTER THREE: THEORY of OPERATION

| | |
|---|------|
| 3.1 Introduction to Theory of Operation | 9 |
| 3.2 Operation of Output Switching Transistors | 9 |
| 3.3 "H Type" Output Bridge Configuration..... | 9-10 |
| 3.4 <u>Pulse-Width-Modulation</u> (PWM)..... | 9-10 |
| 3.5 Current Loop Operation | 11 |
| 3.6 Velocity Loop Operation..... | 11 |

CHAPTER FOUR: INSTALLATION PROCEDURE

| | |
|--|-------|
| 4.1 Mounting..... | 12 |
| 4.2 Wiring Size and Proper Technique | 12-14 |
| 4.3 Baseplate Connections..... | 12 |
| 4.3.1 120 VAC 50/60 Hz for Fan(s)..... | 15 |
| 4.3.2 Input from Secondary of Power Transformer..... | 15 |
| 4.4 Amplifier Connections and Functions..... | 15-17 |
| 4.4.1 D.C. Buss | 15 |
| 4.4.2 Motor | 15 |
| 4.4.3 Signal Input | 15-16 |
| 4.4.4 Tachometer Input | 16 |
| 4.4.5 Decoupled Current Sense (DCS)..... | 16 |
| 4.4.6 + and - Limits..... | 16 |

| | | |
|--------|--|----|
| 4.4.7 | Lock Out (Total Inhibit and Fault Monitor) | 16 |
| 4.4.8 | Reset..... | 16 |
| 4.4.9 | Velocity Mode or Current Mode Option | 17 |
| 4.4.10 | External Programmable Current Limit | 17 |

CHAPTER FIVE: START UP and ADJUSTMENT PROCEDURE

| | | |
|-----|--|-------|
| 5.1 | Safety Precautions | 18 |
| 5.2 | Amplifier Alignment Introduction..... | 18 |
| 5.3 | Velocity Loop Phasing..... | 18-19 |
| 5.4 | Tach Gain Adjustment..... | 19-20 |
| 5.5 | Connecting Amplifier to Digital Position Loop..... | 20-21 |

CHAPTER SIX: MAINTENANCE, REPAIR and WARRANTY

| | | |
|-------|---|-------|
| 6.1 | Maintenance..... | 22 |
| 6.2 | Repair..... | 22-24 |
| 6.2.1 | Fault Tracing | 22 |
| 6.2.2 | Fault Tracing Charts | 22 |
| 6.2.3 | Part Replacement | 22-23 |
| 6.2.4 | Over Temperature Shutdown..... | 23 |
| 6.2.5 | Over Voltage Shutdown | 23 |
| 6.2.6 | Low-Speed Electronic Circuit Breaker (LS/ECB) Shutdown..... | 24 |
| 6.2.7 | High-Speed Electronic Circuit Breaker (HS/ECB) Shutdown | 24 |
| 6.2.8 | Reset..... | 24 |
| 6.3 | Factory Repair..... | 24 |
| 6.4 | Warranty..... | 25 |

APPENDIX A: FAULT TRACING CHARTS

| | | |
|----------------|--|----|
| Fault Chart 1: | Motor does not turn in either direction..... | 27 |
| Fault Chart 2: | Motor only turns in one direction | 28 |
| Fault Chart 3: | Motor does not develop maximum output speed (no load applied) in either direction | 29 |
| Fault Chart 4: | Motor does not develop maximum output torque in either direction..... | 30 |
| Fault Chart 5: | Motor wanders and hunts or does not track smoothly..... | 31 |

APPENDIX B: AMPLIFIER DRAWINGS

| | | |
|-------------------------|---------------------------------|----|
| Installation Schematic: | (GA370-3) - (370-3003) | 33 |
| Installation Schematic: | (GA370-3) - (370-3018) | 34 |
| Installation Schematic: | (GA370-1A-1) - (370-3004) | 35 |
| Installation Schematic: | (GA370-2A-2) - (370-3005) | 36 |
| Installation Schematic: | (GA370-4A-4) - (370-3006) | 37 |
| Installation Schematic: | (GA370-6A-6) - (370-3007) | 38 |

CHAPTER ONE: INTRODUCTION

1.1 INTRODUCTION TO THE GA370 MANUAL:

This manual is intended for use with Glentek's TORQUE-SWITCH™ series, model GA370 Pulse-Width-Modulated (PWM) servo amplifiers. It provides all of the information that is required for installation, alignment and maintenance of the GA370. We suggest that you take the time to read this manual from cover to cover before trying to work with a GA370 amplifier. If you have any questions not addressed in this manual please feel free to call and discuss them with a Glentek applications engineer. Having been in the servo system business for over 28 years, we have a vast pool of applications knowledge waiting to assist you.

Thank you for using Glentek's products. It is our goal to save you money, time and provide you with a superior product.

CHAPTER TWO: DESCRIPTION AND SPECIFICATIONS

2.1 DESCRIPTION OF THE GA370:

The GA370 is a modular, high power, high bandwidth PWM servo amplifier designed for use with DC permanent magnet servo motors. The GA370 utilizes today's latest technology in power semiconductors for high efficiency which in turn makes the amplifier extremely reliable in today's and tomorrow's demanding applications.

2.2 DESCRIPTION OF FEATURES AND MODEL NUMBERING INFORMATION:

2.2.1 SIGNAL INPUT:

The GA370 has two signal input configurations controlled by JP1. Configuration A (JP1 set on A) has two single-ended inputs SIG. IN. (J1-2) and AUX. IN. (J1-1). Configuration B (JP1 set on B) has one single-ended input AUX. IN (J1-1) and one differential input DIFF. IN (J2-1), DIFF. RET. (J2-2). (Refer to Appendix B, drawing 370-3003).

2.2.2 VELOCITY MODE OR CURRENT MODE OPTIONS:

The GA370 is most often used to close a critically damped velocity loop using a DC tachometer for velocity feedback. However, the input summing amplifier can be reduced to a gain of one by connecting a 20.0K resistor across pins 1 and 4 of J3. The gain of the GA370 can then be adjusted from 0 to 3 Amps/Volt (Refer to Appendix B, drawings 370-3003, 370-3018 and to 4.4.9).

2.2.3 EXTERNAL PROGRAMMABLE CURRENT LIMIT:

Pins 1 and 3 of J3 can be used to externally program the current limit by connecting a resistor or potentiometer across them (Refer to Appendix B, drawing 370-3003 and to 4.4.11).

2.2.4 + AND - LIMITS:

The GA370 may be configured for four different end of travel limit circuits (Refer to Appendix B, drawings 370-3018 and 370-3003 to implement these limits).

Type A: Requires grounding of pin 6 or pin 7 to disable amplifier.

Type B: Requires a positive voltage at pin 6 or pin 7 to disable amplifier.

Type C: Requires the removal of a ground from pin 6 or pin 7 to disable amplifier.

Type D: Requires the removal of a positive voltage from pin 6 or pin 7 to disable amplifier.

The amplifier is normally shipped with the type A + and - limit configuration.

2.2.5 LOCK OUT (TOTAL INHIBIT AND FAULT MONITOR):

LOCK OUT has two functions: total inhibit and fault monitor. When LOCK OUT is pulled to ground, either by the amplifier fault sensing circuit or some external circuit, the amplifier is totally inhibited (See 4.4.7 and 6.2.4 - 6.2.7).

2.2.6 CARRIER FREQUENCY:

The GA370 is provided with a carrier frequency of 20 KHz.

2.2.7 MULTI-AXES CONFIGURATIONS:

The single and multi-axes part number designators are as follows:

| | |
|-------------|--|
| GA370-1 | Single amplifier module. |
| GA370-2A- 1 | 2 Axes chassis with 1 Amplifier module. |
| GA370-2A-2 | 2 Axes chassis with 2 Amplifier modules. |
| GA370-4A-3 | 4 Axes chassis with 3 Amplifier modules. |
| GA370-4A-4 | 4 Axes chassis with 4 Amplifier modules. |
| GA370-6A-5 | 6 Axes chassis with 5 Amplifier modules. |
| GA370-6A-6 | 6 Axes chassis with 6 Amplifier modules. |

2.2.8 EXAMPLE - MODEL NUMBERING:

The following example of GA370 part numbering, is provided to help you better understand Glentek's part numbering system:

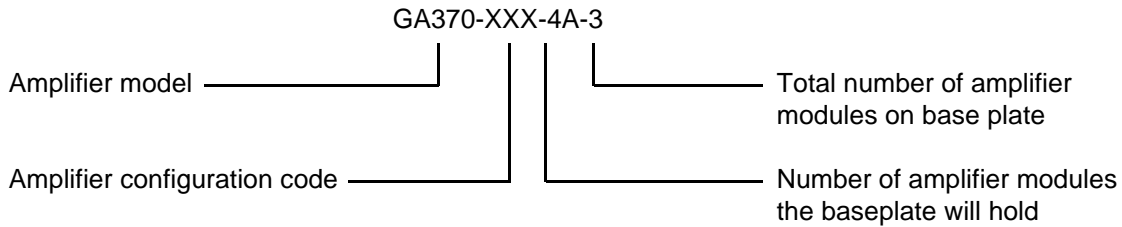

For this example each of the three amplifier modules would be labeled GA370-XXX with serial number. The 4 axes chassis would be labeled GA370-4A-3 with serial number.

Most amplifier options, e.g. limits, are user configurable. However, if you would prefer to have Glentek pre-configure your units, a three-digit amplifier configuration code is added to the end of the amplifier model number. The standard amplifier configuration code is 000. Refer to Configuration, section 2.1. The chart below shows how to construct a custom configuration suffix.

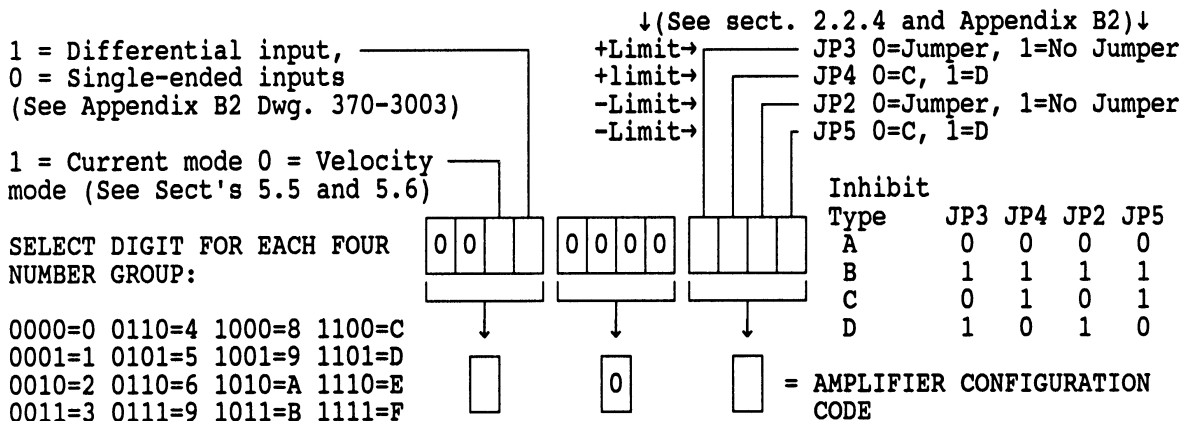

2.3 PROTECTION CIRCUITS:

The following protection circuits are integral to the GA370 amplifier to prevent damage to the amplifier and your equipment. When activated these protection circuits will totally inhibit the amplifier and turn on the fault output. Again, Glentek is anxious to work with you in helping to implement any circuit functions your system might require.

Note: For 2.3.1 to 2.3.4 refer to Appendix B, drawings 370-3018 and 370-3003.

2.3.1 OVER VOLTAGE INDICATOR (RED LED):

The indicator LED will turn ON and latch indicating the D.C. Buss Voltage has exceeded the maximum safe voltage for your system. This circuit protects the motor and amplifier from high D.C. Buss Voltages.

2.3.2 LOW SPEED ELECTRONIC CIRCUIT BREAKER (RED LED):

The indicator LED will turn ON and latch indicating the Low Speed Electronic Circuit Breaker (LS/ECB) has fired. This circuit protects the motor, amplifier and mechanical system from damage due to excessive mechanical bind or possibly driving into a hard mechanical stop.

Circuit operation is as follows:

When the motor current exceeds the value set at TP9, typically 1.5 VDC (scale factor 1 VOLT=10 AMPS), U1B-14 switches positive and voltage on C46 begins integrating up. If the current remains above the set point, typically for 1.5 seconds, the LS/ECB latch will trigger.

2.3.3 HIGH SPEED ELECTRONIC CIRCUIT BREAKER (RED LED):

The indicator led will turn ON and latch indicating the High Speed Electronic Circuit Breaker (HS/ECB) has fired. This circuit protects the amplifier from dead shorts across the amplifier output terminals. The HS/ECB is always factory set and should not be adjusted. The typical factory setting is 45 Amps for 10 micro seconds.

2.3.4 TEMP INDICATOR OPERATION (RED LED):

The Temp Indicator LED will Turn ON and latch when the transistor heatsink temperature exceeds 170° F.

2.4 SPECIFICATIONS:

2.4.1 OUTPUT POWER (For each GA370 amplifier module)

| | |
|---------------------------|----------|
| OUTPUT CURRENT (PEAK): | ±25 AMPS |
| OUTPUT CURRENT (RMS): | ±15 AMPS |
| OUTPUT VOLTAGE (TYPICAL): | ±100 VDC |

2.4.2 INPUT POWER:

| | |
|--------------------|---------------------------|
| FANS: | 120 VAC, 50/60 Hz @ 1 AMP |
| D.C. BUSS VOLTAGE: | |

TYPICAL: 65 VDC TO 170 VDC

MAXIMUM: 200 VDC

(Higher Buss Voltages available, consult Glentek.)

Note: DC Buss voltage should be selected approximately 10%-20% above the maximum voltage required at motor terminals for maximum system efficiency.

INPUT POWER FOR DC BUSS: A fused single phase full wave rectifier and filter capacitor are provided on the base plate. The AC input to this circuit is supplied by a separately mounted power transformer unique to the application. The power transformer and motor output inductors are not standard parts of the amplifier package. Glentek has power transformers and inductors in stock for your total system requirements.

2.4.3 SIGNAL INPUTS:

VOLTAGE, MAXIMUM

| | |
|-------------|-----------|
| Aux. Input | ±70 Volts |
| Sig. Input | ±70 Volts |
| Diff. Input | ±13 Volts |
| Tach. Input | ±90 Volts |

GAIN, MAXIMUM

| | |
|--------------------------------|------------------|
| Sig. and Aux. Inputs | 15,000 Amps/Volt |
| Tachometer | 7,000 Amps/Volt |
| Input Impedance, Minimum | 20K Ohm |
| Drift (Ref. to Input), Maximum | 0.01mV/°C |

| | |
|-----------------------------|----------|
| Frequency Response, Minimum | 1,500 Hz |
| Dead Band | None |
| Form Factor | 1.01 |

2.4.4 OTHER INPUTS AND OUTPUTS

| | |
|---------------------------|--|
| + and - Limits (Type IA@) | Activated by a 3ma. contact closure to common. |
| Lock Out | Total Inhibit, activated by a 3ma. contact closure to common. Fault monitor, 10k ohm pull up to +15VDC, will sink 15 ma. |
| Reset | Activated by a 3ma. contact closure to common. |

2.4.5 MECHANICAL (SEE APPENDICES B3-B6)

| | |
|--------------------------------------|--------------------|
| Mounting | Any Position |
| Cooling | 50° C Ambient Max. |
| Dimensions (Width x Depth x Height): | |

| | |
|------------|-------------------------------|
| GA370-3 | 8.5 in. x 1.8 in. x 6.2 in. |
| GA370-1A-1 | 5.0 in. x 10.3 in. x 7.0 in. |
| GA370-2A-2 | 9.0 in. x 10.5 in. x 7.3 in. |
| GA370-4A-4 | 13.0 in. x 10.5 in. x 7.5 in. |
| GA370-6A-6 | 16.5 in. x 10.5 in. x 7.8 in. |

| | | |
|--------|------------|----------|
| Weight | GA370-3 | 1.5 lbs. |
| | GA370-1A-1 | 6 lbs. |
| | GA370-2A-2 | 7.5 lbs. |
| | GA370-4A-4 | 12 lbs. |
| | GA370-6A-6 | 17 lbs. |

2.4.6 TYPICAL FACTORY SETTINGS

| | |
|--------------------|----------------------|
| Sig. and Aux. Gain | 5V(Sig.)/7V(Tach.) |
| Tach. Gain | 50% |
| Current Limit | CCW (OFF) |
| Comp. | CCW (Min. Bandwidth) |
| LS/ECB | 15A @ 3 sec. |
| HS/ECB | 45A @ 10 micro sec. |

CHAPTER THREE: THEORY OF OPERATION

3.1 INTRODUCTION TO THEORY OF OPERATION:

A Velocity Mode servo amplifier is essentially comprised of two control loops (see fig. 3.1).

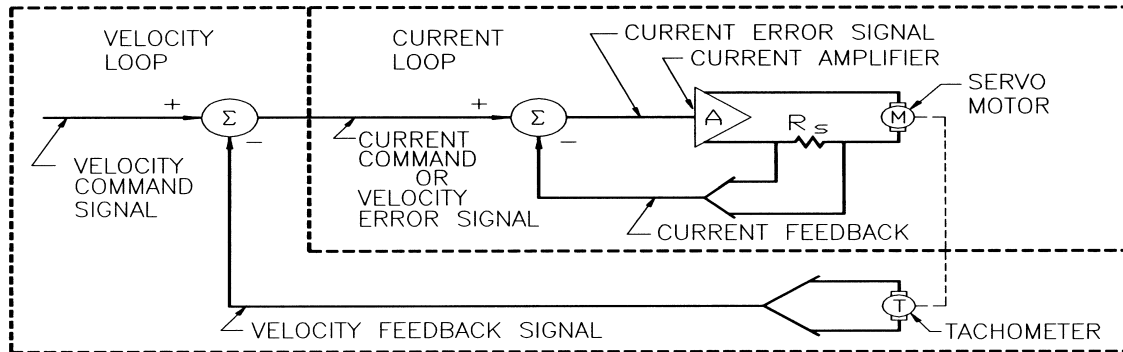

Figure 3.1

The inside control loop is referred to as the Current Loop and the outside loop is referred to as the Velocity Loop. Before we begin our analysis of the Current Loop, let us review some basic concepts which will help you to better understand the amplifier's operation.

3.2 OPERATION OF OUTPUT SWITCHING TRANSISTORS:

The output transistors, for all intents and purposes, operate in only two states. They are analogous to an ON/OFF switch. When an output transistor is OFF, there is no current flowing through it (it's resistance is infinite). When an output transistor is ON, current flows through it (it's resistance is near zero). When the transistor is ON, it is technically referred to as being in saturation.

3.3 AH TYPE® OUTPUT BRIDGE CONFIGURATION:

The output configuration of the amplifier is an AH TYPE® bridge (see fig. 3.2 for schematic representation of an output bridge with motor connected).

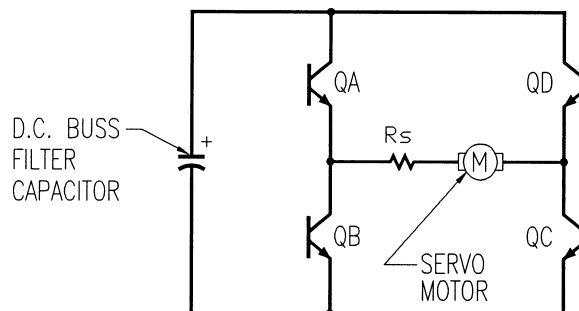

Figure 3.2

The advantage of an AH TYPE® output bridge configuration is that by controlling the switching of the opposite pairs of transistors, current can be made to flow through the motor in either direction using a single polarity power supply as shown in figure 3.2.

To provide motor current in one direction, A and C are turned ON, while B and D remain in the OFF state. To provide motor current in the other direction, B and D are turned ON, while A and C remain in the OFF state.

3.4 PULSE-WIDTH-MODULATION (PWM):

Pulse-Width-Modulation is the technique used for switching opposite pairs of output transistors ON and OFF to control the motor drive current. When zero current is commanded to the current loop, the opposite pair of transistors are turned ON and OFF as shown in figure 3.3. Note that since the pulse widths are equal, the net DC current in the motor is equal to zero.

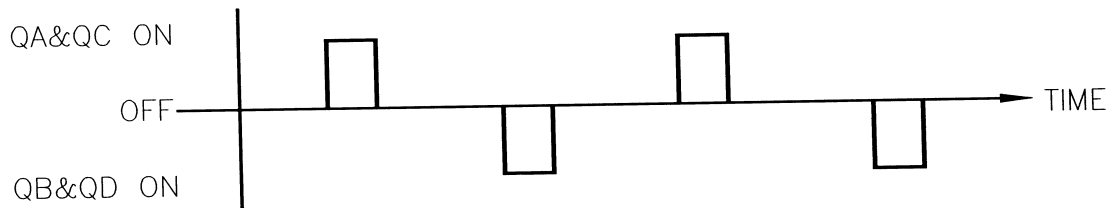

Figure 3.3

When a non-zero current is commanded to the current loop, the transistor switching waveform is as shown in figure 3.3A. Since there is a non-zero current command, the output transistor pulse widths will change and the motor will see a net DC current flowing from A through C (see fig. 3.2).

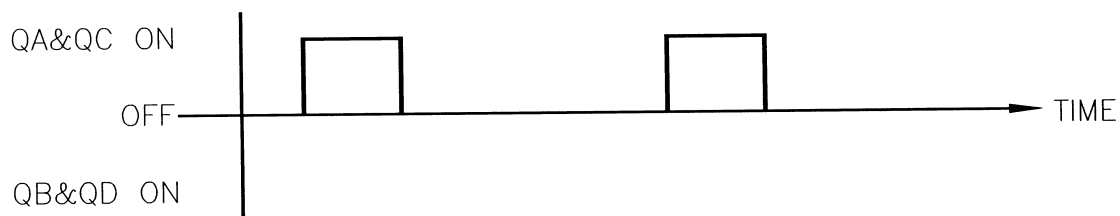

Figure 3.3A

If the input to the current loop had been changed in polarity, the output transistor switching waveform would be as shown in figure 3.3B.

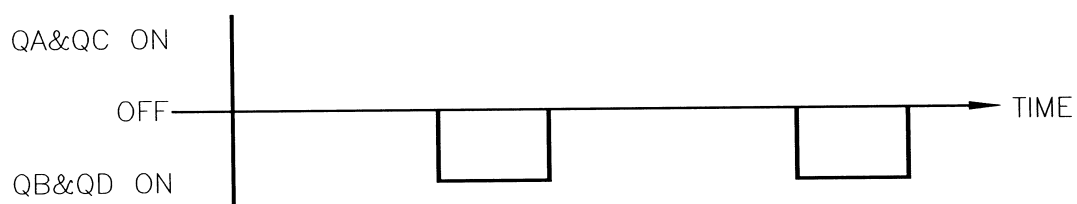

Figure 3.3B

If a larger current of the same polarity was commanded to the output transistors (see fig. 3.3B), the ON time widths of B and D would automatically increase to provide more current.

From the previous examples it is easy to understand why this output transistor switching technique is referred to as Pulse-Width-Modulation.

To change the magnitude and polarity of the current flow in the motor, the pulse widths of the opposite pairs of transistors are modulated. The frequency at which these output transistors are switched ON and OFF is referred to as the Carrier Frequency. Our carrier frequency is 20,000 cycles per second.

After realizing how the PWM amplifier output works, it becomes apparent that some inductance must be added to the motor circuit to prevent excessively high AC current ripple and heating in the servo motor. Consult a Glentek applications engineer for recommended inductance.

Now that we have a good understanding of how the current is provided from an AH TYPE® Pulse-Width-Modulated (PWM) bridge, let's analyze the operation of the current loop.

3.5 CURRENT LOOP OPERATION:

Please refer to figure 3.1 for a diagram of the Current Loop. In control electronics the symbol sigma (with the circle around it) is referred to as a Summing Junction. The manner in which this summing junction operates is as follows:

The Current Command Signal (also referred to as the Velocity Error Signal when received from the output of the velocity loop, as shown in fig. 3.1) is added to the current feedback signal. The signal resulting from this addition, is referred to as the Current Error Signal. This current error signal is fed into the current amplifier, which in turn produces a current in the motor. A voltage which is proportional to the motor current is developed across R_s (shunt resistor), this voltage is referred to as the Current Feedback Signal. The current in the motor increases until the current feedback signal is exactly equal in magnitude, but opposite in polarity, to the current command signal. At this point the current error signal drops to zero, and the commanded current is equal to the actual current. If anything happens to disturb either the current command signal, or the current feedback signal, the same process occurs again until the current command signal is equal in magnitude to the current feedback signal, but opposite in polarity.

The type of loop described above is referred to as a Servo Loop because the current servos about a commanded value.

We are surrounded in our everyday lives by a multitude of servo loops. For example, many of today's luxury cars have what is called Automatic climate control®. To operate this servo loop the climate control is set to the temperature to be maintained in the interior of the car (current command signal). The selected temperature is then summed with the actual temperature from a thermometer (current feedback), and the output (current error signal) activates either the heater or the air-conditioner until the set temperature (current command signal) is equal in magnitude, but opposite in polarity, to the actual temperature as measured by the thermometer (current feedback).

3.6 VELOCITY LOOP OPERATION:

Please refer to figure 3.1 for a diagram of a typical Velocity Loop. The velocity loop's operational description is analogous to the current loop description, except for the fact that the input signal is called the Velocity Command and the feedback signal from the DC tachometer is called the Velocity Feedback.

CHAPTER FOUR: INSTALLATION AND SETUP

4.1 MOUNTING:

The installation diagrams in Appendix B show the bolt hole mounting pattern to support the amplifier, the mounting holes will accept a 1/4 inch bolt. The base material is cadmium plated .060 inch thick steel.

THE MOUNTING BOLT SHOULD PROVIDE AN ELECTRICAL GROUND FOR THE CHASSIS TO MINIMIZE SHOCK HAZARD.

The surface that the amplifier package will be mounted on must be able to support its weight, but does not need to provide a cold plate cooling for the amplifier.

Standard 100 CFM muffin fan(s) are mounted on the baseplate to cool the amplifier(s). **It is IMPORTANT to allow a minimum of three inches between both the fan side and the module side (opposite fans) of the amplifier baseplate and the cabinet wall.** The distance between the other two sides and top of the amplifier and the cabinet walls are not critical, however, some space should be provided for wire routing and terminal strip access.

The amplifier package should be mounted in a clean, dry enclosure with a maximum ambient temperature of 50°C. To ensure maximum reliability, keep the amplifier cabinet cool and free from dust, oil and other contaminants.

NEVER INSTALL THE AMPLIFIER PACKAGE IN ANY LOCATION WHERE FLAMMABLE OR EXPLOSIVE VAPORS ARE PRESENT

4.2 WIRING SIZE AND PROPER TECHNIQUE:

Please refer to Appendix B, GA370 installation diagrams. These installation diagrams show the necessary external connections to ensure proper amplifier operation.

Glentek recommends that your wiring be in accordance with all national and local codes that are applicable to your system. Wire size must be sufficient to accommodate the maximum continuous current that will be run thru it.

Recommended wire sizes for the GA370 are as follows:

MOTOR ARMATURE - 14 ga.

0-105 VAC POWER INPUT (from secondary of power transformer) - 12 ga.

120 VAC FOR FANS - 16 ga. twisted pair.

SIGNAL INPUT - 22 ga. min. 2 conductor with shield.

TACHOMETER INPUT - 22 ga. min. 2 conductor with shield. Terminate shield, one end only at tachometer common J1 terminal 4 of amplifier module.

When wiring to and from the drive cabinet, it is considered good technique to route the power lines (16 ga. and larger) along different paths than the signal and tachometer lines. This minimizes the amount of stray noise and pick-up that is injected into the amplifier.

4.3 BASEPLATE CONNECTIONS:

4.3.1 120 VAC 50/60 Hz FOR FAN(S)

Connect the 120 VAC to terminals 11 and 12 of terminal barrier strip TB201 located on the baseplate.

DO NOT APPLY ANY POWER YET.

4.3.2 INPUT FROM SECONDARY OF POWER TRANSFORMER:

The AC voltage that is used to form the DC Buss of the amplifier package, is supplied from a separately

mounted transformer that has been selected by Glentek for your application. Connect the secondary of the power transformer to terminals 9 and 10 of TB201.

DO NOT APPLY ANY POWER YET.

4.4 AMPLIFIER CONNECTIONS AND FUNCTIONS:

4.4.1 DC BUSS:

The DC Buss, from the filter capacitor is connected to pins 1-2(+) and 4-5(-) of J5. This connection is already made for you on our multiaxes packages. The power transformer for the DC Buss is not a standard part of the amplifier package. Glentek can advise on transformer specifications for your application. Most styles and sizes are in stock at Glentek.

4.4.2 MOTOR:

The Motor is connected to pins 7-8(-) and 10-11 (+) of J5 (SEE APPENDIXES B4-B7). In most cases, if the motor inductance is less than 1 millihenry, an inductor should be connected in series with the motor leads. The inductor is considered to be a separate part from the amplifier package. Glentek can advise on inductor specifications for your application, and most styles and sizes are in stock at Glentek.

IT IS IMPERATIVE THAT YOU DO NOT USE GROUNDED TEST EQUIPMENT ON THE MOTOR ARMATURE NOR CONNECT EITHER END OF THE MOTOR ARMATURE TO SIGNAL GROUND OR DC BUSS RETURN.

4.4.3 SIGNAL INPUT:

The GA370 has two signal input configurations controlled by JP1. Configuration A (JP1 set on A) has two single-ended inputs SIG. IN. (J1-2) and AUX. IN. (J1-1). Configuration B (JP1 set on B) has one single-ended input AUX. IN (J1-1) and one differential input DIFF. IN (J2-1), DIFF. RET. (J2-2). (Refer to Appendix B, drawing 370-3003). Typically when operating in the velocity mode, the input signal range is ± 10 VDC. The input voltage is summed with a precision DC tachometer to provide accurate velocity control at the servo motor shaft (see fig. 3.1). The Signal Gain potentiometer RV2 (20 K), and Auxiliary Gain potentiometer RV1 (20 K), adjust the motor velocity desired for a given input voltage velocity command (see 4.2 for recommended wire type & size).

4.4.4 TACHOMETER INPUT:

The Tachometer is connected to pins 3 and 4 on J1 of the amplifier module (see 4.2 for recommended wire type & size).

4.4.5 DECOUPLED CURRENT SENSE (DCS):

The Decoupled Current Sense output signal can be monitored on pin 5 of J1 on the amplifier module. It is an isolated output signal that is proportional to motor current. The scale factor is 12 VOLT = 25 AMPS.

4.4.6 + AND - LIMITS:

The + and - Limits are located respectively at pins 6 and 7 on J1 of the amplifier module. Please refer to 2.2.3 for a description of the different configurations of limits that are available. Amplifier modules are normally shipped with type AA@ limits, when pins (J1-6 or J1-7) are pulled to ground (J1-9) by some external circuit the amplifier is inhibited in the + or - direction.

4.4.7 LOCK OUT (TOTAL INHIBIT AND FAULT MONITOR):

Lock Out is located at pin 8 on J1 of the amplifier module. When this pin (J1-8) is pulled to ground, either by the amplifier fault sensing circuit or some external circuit (a 3ma. contact closure to J1-9), the amplifier is totally inhibited. The amplifier will pull this terminal to ground by turning ON Q1(Q1 can sink 15 ma.) for the following fault conditions:

1. Transistor heatsink temperature in excess of 170°F.
2. Low Speed Electronic Circuit Breaker (LS/ECB) triggered.
3. High Speed Electronic Circuit Breaker (HS/ECB) triggered.
4. D.C. Buss Over Voltage Circuit triggered.

NOTE: Please refer to Chapter 2.3 on Protection Circuits and Chapter 6 for a more detailed description of the possible conditions that will cause the above faults to occur.

**FAULT SHUTDOWNS CAN ONLY BE CAUSED BY ABNORMAL CONDITIONS.
THE CAUSE SHOULD BE INVESTIGATED BEFORE REPEATED RECYCLING OF THE MOTOR DRIVE TO
PREVENT POSSIBLE DAMAGE TO THE AMPLIFIER.**

4.4.8 RESET:

RESET (J1-13) is activated by a 3ma. contact closure to amplifier common (J1-14). Reset is also accomplished by pressing the pushbutton Reset switch SW1 or by removing all power from amplifier, waiting until the D.C. Buss capacitor is discharged and reapplying power (Refer to appendix B, drawing 370-3003).

4.4.9 VELOCITY MODE OR CURRENT MODE OPTION:

The GA370 is most often used to close a critically damped velocity loop using a DC tachometer for velocity feedback. However, the input summing amplifier can be reduced to a gain of one by connecting a 20.0K resistor across pins 1 and 4 of J3. The gain of the GA370 can then be adjusted from 0 to 3 Amps/Volt. A 40.2K resistor is available at pin 2 of J3, jumpering pin 2 to pin 1 will give a gain of two allowing the input to be adjusted from 0 to 6 Amps/Volt (Refer to Appendix B, drawings 370-3018 and 370-3003).

4.4.10 EXTERNAL PROGRAMMABLE CURRENT LIMIT:

Pins 1 and 3 of J3 can be used to externally program the current limit by connecting a resistor or potentiometer to them (Refer to Appendix B, drawing 370-3003)

NOTE: Proper signal shielding must be used, a noisy signal can damage the output section of the amplifier.

CHAPTER FIVE: START UP AND ADJUSTMENT PROCEDURE

5.1 SAFETY PRECAUTIONS:

Before starting the adjustment and alignment procedure please be sure to observe the following precautions:

1. Be certain that there are no visibly loose or damaged components.
2. Check that all connections are tight.
3. Check all power and signal wiring. Remove power input fuses, apply power and measure that correct power voltage is being applied. Your DC Buss voltage will be 1.4 x the AC power applied (Refer to Appendix A, note 1).
4. Be sure that the motor mechanism is clear of all obstructions. If motor is connected to an axis lead screw or other device with limited motion, place at midposition.
5. Work on only one amplifier at a time.
6. Make sure all Current Limit pots are turned fully CCW before applying power.
7. **DO NOT** use grounded test equipment.

5.2 AMPLIFIER ALIGNMENT INTRODUCTION:

When adjusting an amplifier for optimum velocity loop operation it is desirable to achieve a critically damped, stable step velocity response with maximum DC Tach Gain. The following discussion will describe how to best achieve this result:

Your amplifier has been run at the factory with a known motor, tachometer and inertial load. In testing at the factory we try to simulate the same conditions you will have in your system. For this reason it is a good idea to start with the initial settings as shipped from the factory.

5.3 VELOCITY LOOP PHASING:

For proper servo operation it is necessary for the amplifier to receive negative feedback from the tachometer. If the tachometer leads are reversed (positive feedback), the amplifier will run away. To check the phasing of the motor and tachometer proceed as follows:

1. Make sure Current Limit potentiometer, RV5, is full CCW (as shipped from factory).
2. Make sure that nothing is connected to the Signal Input (J1-2) or the Auxiliary Signal Input (J2-1 or J2-2).
3. Apply the main power for DC Buss and the 120 volt power for the fans.
4. Slowly turn the Current Limit potentiometer, RV5, CW. If the motor starts to run away turn the Current Limit potentiometer full CCW and reverse the motor armature leads. Again, slowly turn the Current Limit potentiometer CW. The motor should be stopped or rotating slowly.
5. Set Current Limit potentiometer, RV5, to the desired peak current for the remaining adjustments and operations.

Typical settings for Current Limit potentiometer, RV5 (20 turn potentiometer).

3 turns CW = 30% peak current
6 turns CW = 60% peak current

10 turns CW = 85% peak current
14 turns CW = 95% peak current

5.4 TACH GAIN ADJUSTMENT:

1. At this point the motor will be rotating slowly. Adjust the Balance potentiometer, RV6, until the motor rotation is stopped.
2. While observing the tachometer output voltage with an oscilloscope, apply a step input voltage at the Signal Input terminal of the amplifier. A step input voltage can be simulated by applying and removing a flashlight battery to the Signal Input. For this purpose the battery is usually mounted inside of a small box with a switch. Common names used to describe this DC signal voltage source are Battery Box or DC Simulator.

Elaborate signal sources are often made for this purpose including bipolar output, potentiometer output adjust and polarity reversing switches, etc. You often hear the term **ADC Box the velocity loop servo** being used by people working on servo systems.

(This Battery Box may be purchased from Glentek Inc., Part Number BB700)

3. At this point the motor should be running smoothly. While applying and removing the DC input signal adjust the Current Limit potentiometer, RV5, for desired maximum acceleration and deceleration current. Motor current should be observed by using an oscilloscope at J1-5(DCS). Scale factor of voltage at this point is 12 VOLT = 25 AMPS of motor current. Leave the Current Limit potentiometer at this setting for all remaining adjustments. (Note the number of turns from the CCW end.)
4. Adjust the Signal Gain potentiometer, RV1 or RV2, of the signal input that you are using so when you apply the DC signal the motor rotates at approximately 400 RPM.
5. Observe the tachometer voltage with an oscilloscope while applying and removing the DC input signal. You will observe one of three possible waveforms; Critically Damped, Under Damped or Over Damped (see figure 5.4).
6. The waveform that for many systems is optimum is the critically damped waveform. If the waveform that you are observing is critically damped proceed to step 9.
7. If your waveform is under damped make the following adjustments:

Turn the Compensation potentiometer, RV4, CW until the waveform becomes critically damped. Note here that the limiting factor will be a motor oscillation, you must always leave the Compensation potentiometer CCW enough so that the velocity loop remains stable.

If the waveform is still under damped after adjusting the Compensation potentiometer for maximum bandwidth, turn the Tachometer Gain potentiometer, RV3, 2 turns CCW and then again adjust Compensation potentiometer, RV4, CW until waveform becomes critically damped. Repeat procedure if necessary. Again, the servo velocity loop must at all times remain stable. Consult the factory if necessary.

8. If the waveform is over damped make the following adjustments:
Turn the Tachometer Gain potentiometer, RV3, CW until a slight overshoot appears on the waveform then turn the Compensation potentiometer, RV4, CW until a critically damped waveform is observed.
9. Now that the waveform is critically damped, leave the Compensation, RV4, and Tachometer Gain, RV3, at these settings for all remaining adjustments and operations.
10. Next set the Signal potentiometer, RV1 or RV2, of the signal input that you are using to the gain required by your system (Ex: 10 VOLTS INPUT = 2000 RPM).
11. Adjust Balance potentiometer, RV6, one more time to null out any offset.
12. For all remaining adjustments when placing the amplifier in your system only the Signal potentiometer, RV1 or RV2, and Balance potentiometer, RV6, should be adjusted.

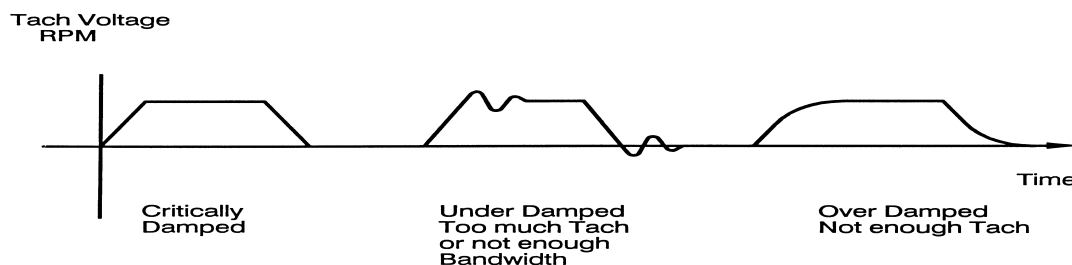

Figure 5.4

5.5 CONNECTING AMPLIFIER TO DIGITAL POSITION LOOP:

Before connecting the amplifier to the Digital Position Loop, be sure adjustments of section 5.4 have been made. Start out with Current Limit potentiometer, RV5, fully CCW and activate the Digital Position Loop. Slowly turn Current Limit potentiometer CW. If servo runs away, immediately adjust Current Limit fully CCW and turn power OFF.

1. It is possible, at this time, that the Digital Loop is reverse phased. An example of this would be if a positive voltage from the velocity DAC required the motor to turn CW, however, it turned CCW instead causing the encoder feedback signal to count up instead of down. This would cause a run away condition.
If you are out of phase as described, be sure power is OFF and reverse the motor leads at the amplifier and also the tachometer leads. This will cause the motor to rotate in the opposite direction as it did before, properly phasing the Digital Loop.
2. Now with the Digital Loop operating, set Current Limit potentiometer, RV5, to the desired peak current (See 5.3-5 and 5.4-3), and command a small move. Slowly increase or decrease the Signal Gain potentiometer, RV1 or RV2, of the amplifier until the servo is operating as required. It should be noted here that too much Signal Gain at this point can cause instability (oscillation). **Do not** stay in this oscillating condition long as it may result in system mechanical or electrical damage. Be sure when all signal adjustments are made that the Balance is rechecked and adjusted for zero rotation for zero signal input.
3. It should be noted here that the GA370 is designed to operate with many different systems and if after reading this manual you have further questions, do not hesitate to call a Glentek applications engineer.

ENGINEERING NOTE:

After all systems are aligned and functioning it is good practice to remove power from the amplifier and, using a digital ohm-meter, measure the impedance value of the following potentiometer wiper settings with respect to signal ground. These values may be useful for the next machine you align or for maintenance of this system at a later date. Make these measurements for each amplifier on a multiaxis baseplate.

Record resistance measurements:

| | AMP1 | AMP2 | AMP3 | AMP4 | AMP5 | AMP6 |
|---|-------|-------|-------|-------|-------|-------|
| 1.Tach. potentiometer wiper to signal ground. (ohms): | _____ | _____ | _____ | _____ | _____ | _____ |
| 2.Signal potentiometer wiper to signal ground. (ohms): | _____ | _____ | _____ | _____ | _____ | _____ |
| 3.Comp. potentiometer wiper to signal ground. (ohms): | _____ | _____ | _____ | _____ | _____ | _____ |
| 4.Current limit potentiometer wiper to signal ground (ohms): | _____ | _____ | _____ | _____ | _____ | _____ |
| Also, Record Signal voltage () volts to Tachometer () volts Tach. voltage ratio: | _____ | _____ | _____ | _____ | _____ | _____ |

Date data taken: ____ ____ ____

Also, note any changes of Compensation components, etc:

CHAPTER SIX: MAINTENANCE, REPAIR AND WARRANTY

6.1 MAINTENANCE:

The GA370 amplifiers do not require any scheduled maintenance. The only wear-out items are the cooling fans which are specified to have in excess of 5 years life by their manufacturer.

6.2 REPAIR:

If your system exhibits a problem, this manual should be of assistance in identifying the fault and to replace the defective component or sub-assembly. The GA370 amplifiers are modular assemblies and each individual amplifier section is designed to be easily removed and replaced at the field level. It is Glentek's recommendation that a failed amplifier module be replaced in the field and returned to Glentek for failure analysis and repair. However, Appendixes B and C contain complete system schematics that, in case of extreme emergency, should permit a skilled electronic technician to trouble shoot the circuit boards to levels lower than those recommended as replaceable.

6.2.1 FAULT TRACING:

This section will aid in the location of defective replaceable components and assemblies. A list of the fault tracing charts in Appendix A, along with the observable fault follows:

| | |
|---------------|--|
| Fault Chart 1 | Motor does not turn in either direction. |
| Fault Chart 2 | Motor only turns in one direction. |
| Fault Chart 3 | Motor does not develop maximum output speed (no load applied) in either direction. |
| Fault Chart 4 | Motor does not develop maximum output torque in either direction. |
| Fault Chart 5 | Motor wanders and hunts or does not track smoothly. |

6.2.2 FAULT TRACING CHARTS:

The fault tracing charts in Appendix A start with an observable fault listed at the top of each chart. Follow the line connections between blocks by the answers to the questions noted in the diamond shape blocks until the defective part is isolated. The charts are to be used only as a guide to identify the parts or assemblies that Glentek recommends as the lowest level of repair.

The fault tracing procedures assume that only a single failure mode exists.

6.2.3 PART REPLACEMENT:

The removal and replacement of the defective assembly can be accomplished with standard shop procedures. The assemblies that may be easily removed are as follows:

1. Fuses F201-F203 on baseplate and FI on each amplifier module.
2. Rectifier BR201 and BR202.
3. Capacitor C201.
4. Fan 201 -203.
5. Amplifier Module A1 -A6.

After reviewing the fault tracing charts it may be concluded that the complete amplifier should be returned to Glentek for failure analysis, repair and retesting to specifications. This is particularly true with failure modes in the amplifier module sections A1 thru A6.

**FAULT SHUTDOWNS CAN ONLY BE CAUSED BY ABNORMAL CONDITIONS.
THE CAUSE SHOULD BE INVESTIGATED BEFORE REPEATED RECYCLING OF THE MOTOR DRIVE TO
PREVENT POSSIBLE DAMAGE TO THE AMPLIFIER.**

6.2.4 OVER TEMPERATURE SHUTDOWN:

When the heatsink temperature has reached a level that, if exceeded, would damage the output transistors, the Temp indicator LED is latched ON inhibiting the amplifier.

List of possible causes of excessive temperature rise:

1. Loss of cooling air - Fans are defective or airflow is blocked.
2. Excessive rise in cooling air temperature due to cabinet ports being blocked or excessive hot air being ingested.
3. Extended operational duty cycle due to mechanical overload of motor or defective motor.
4. Defective power output section due to component failure (Return to Glentek for repair).
5. Noisy Tachometer Signal - A noisy tachometer causes a considerable amount of random switching of the power output transistors, thus increasing the amount of heat developed in the output section. The higher the bandwidth the more the heating due to a noisy tachometer. A noisy tachometer can be identified by a large amount of rumbling and twitching of the motor at low or zero shaft speeds.

6.2.5 OVER VOLTAGE SHUTDOWN:

When the D.C. Buss Voltage has exceeded the maximum safe voltage for your system, the Over voltage indicator LED is latched ON inhibiting the amplifier. This circuit protects the motor and amplifier from high D.C. Buss Voltages.

List of possible causes of high D.C. Buss Voltage:

1. AC main voltage too high.
2. Wrong transformer installed.
3. A spinning DC motor is basically a DC generator and it produces a voltage (BEMF) which is proportional to RPM. This BEMF voltage becomes additive to the DC Buss voltage (Regen Voltage) when the amplifier is commanded to decelerate a given motor inertial load. If the Regen Voltage is high enough to cause an OVER VOLTAGE SHUTDOWN consult with Glentek for the addition of a REGEN CLAMP to your system.

6.2.6 LOW SPEED ELECTRONIC CIRCUIT BREAKER (LS/ECB) SHUTDOWN:

The LS/ECB is tripped when a preset current threshold is exceeded for a preset length of time, typically 15 Amps for 3 seconds. The time delay is typically set at the factory to your system requirements.

List of possible causes:

1. Binding or stalling of motor shaft.
2. Overload of amplifier output to motor.
3. Large reflected load inertia.

6.2.7 HIGH SPEED ELECTRONIC CIRCUIT BREAKER (HS/ECB) SHUTDOWN:

The HS/ECB is tripped by 45 or more Amps of output current for 10 micro seconds.

List of possible causes:

1. Shorted motor leads.
2. Intermittent motor short.
3. Motor inductance too low.
4. Motor commutator flash over.

6.2.8 RESET:

RESET (J1-13) is activated by a 3ma. contact closure to amplifier common (J1-14). Reset is also accomplished by pressing the pushbutton Reset switch S1 or by removing all power from amplifier, waiting until the D.C. Buss capacitor is discharged and reapplying power. (Refer to appendix B, drawings 370-3003 and 370-3018)

6.3 FACTORY REPAIR:

Should it become necessary to return the GA370 to Glentek for repair, please follow the procedure described below:

1. Reassemble the unit if necessary, making certain that all the hardware is in place.
2. Contact a Glentek representative and confirm the unit is being returned to the factory and obtain an **ARMA NUMBER**® (Return Material Authorization)
3. Tag the unit with the following information:
 - A. Serial number.
 - B. RMA number obtained from the factory.
 - C. Company name and representative returning the unit.

- D. A brief notation explaining the malfunction.
- E. Date the unit is being returned.
- 4. Repackage the unit with the same care and fashion in which it was received. Label the container with the appropriate handling stickers (e.g. FRAGILE, HANDLE WITH CARE).
- 5. Return the unit by the best means possible. The method of freight chosen will directly affect the timeliness of its return.

6.4 WARRANTY:

Any product or part thereof manufactured by Glentek, Inc. described in the manual which, under normal operation conditions in the plant of the original purchaser thereof, proves defective in material or workmanship within one year from the date of shipment by us, as determined by an inspection by us, will be repaired or replaced free of charge FOB our factory, El Segundo, California provided that you promptly send to us notice of the defect and establish that the product has been properly installed, maintained and operated within the limits of rated and normal usage. Glentek's liability is limited to repair or replacement of defective parts.

Any product or part manufactured by others and merely installed by us, such as electric motors etc., is specifically not warranted by us and it is agreed that such product or part shall only carry the warranty, if any, supplied by the manufacturer. It is also understood that you must look directly to such manufacturer for any defect, failure, claim or damage caused by such product or part, including power transistors.

Under no circumstances shall Glentek, Inc. or any of our affiliates have any liability whatsoever for claims or damages arising out of the loss of use of any product or part sold to you. Nor shall we have any liability to yourself or anyone for any indirect or consequential damages such as injuries to person and property caused directly or indirectly by the product or part sold to you, and you agree in accepting our product or part to save us harmless from any and all such claims or damages that may be initiated against us by third parties.

APPENDIX A
FAULT TRACING CHARTS

Fault Chart 1

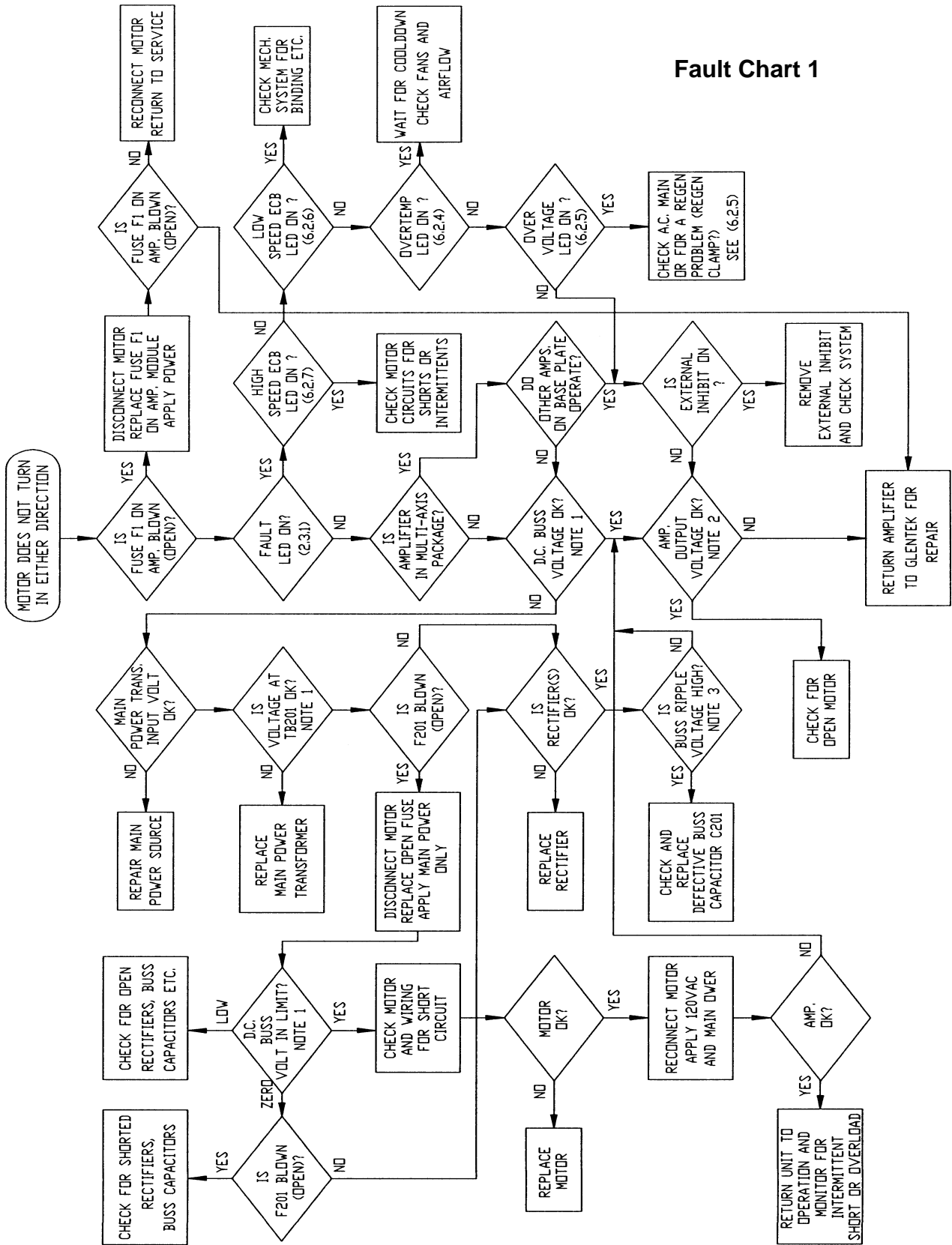

Fault Chart 2

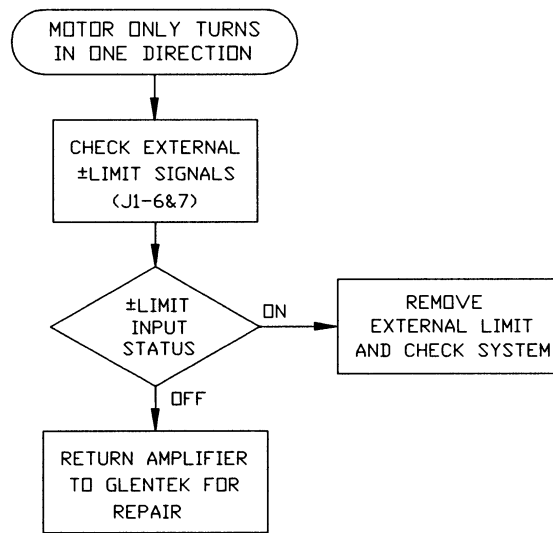

Fault Chart 3

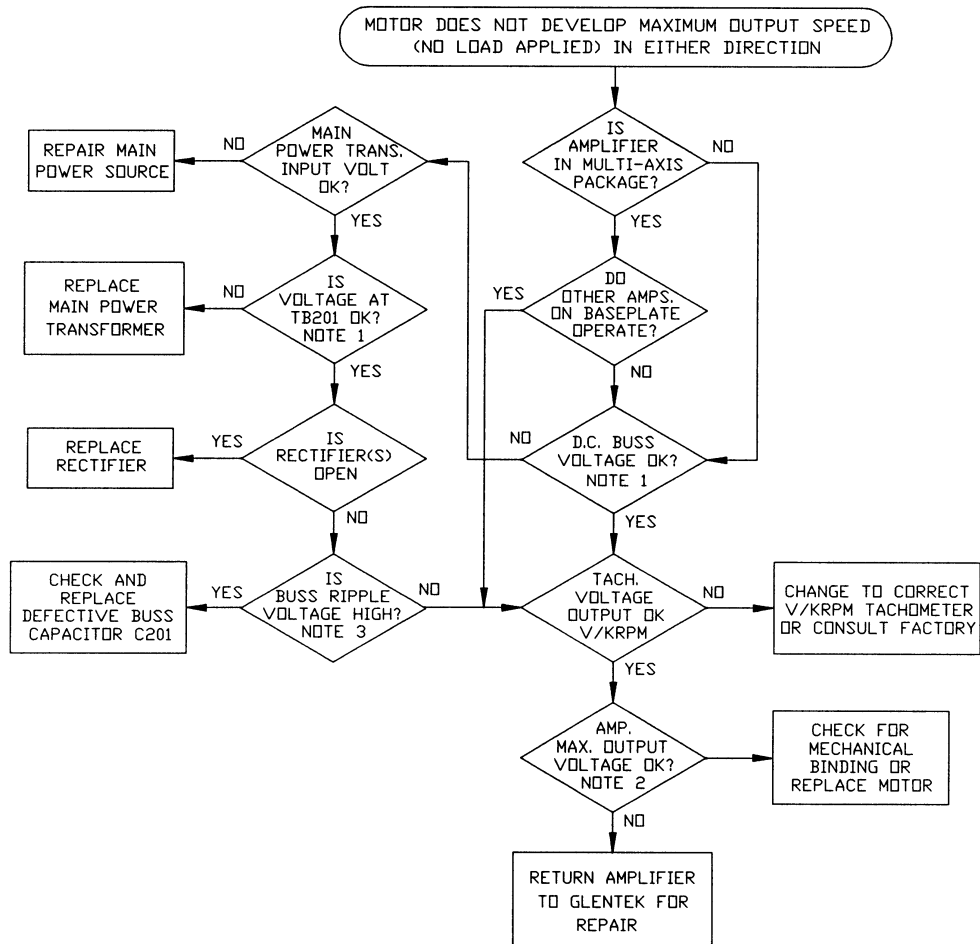

Fault Chart 4

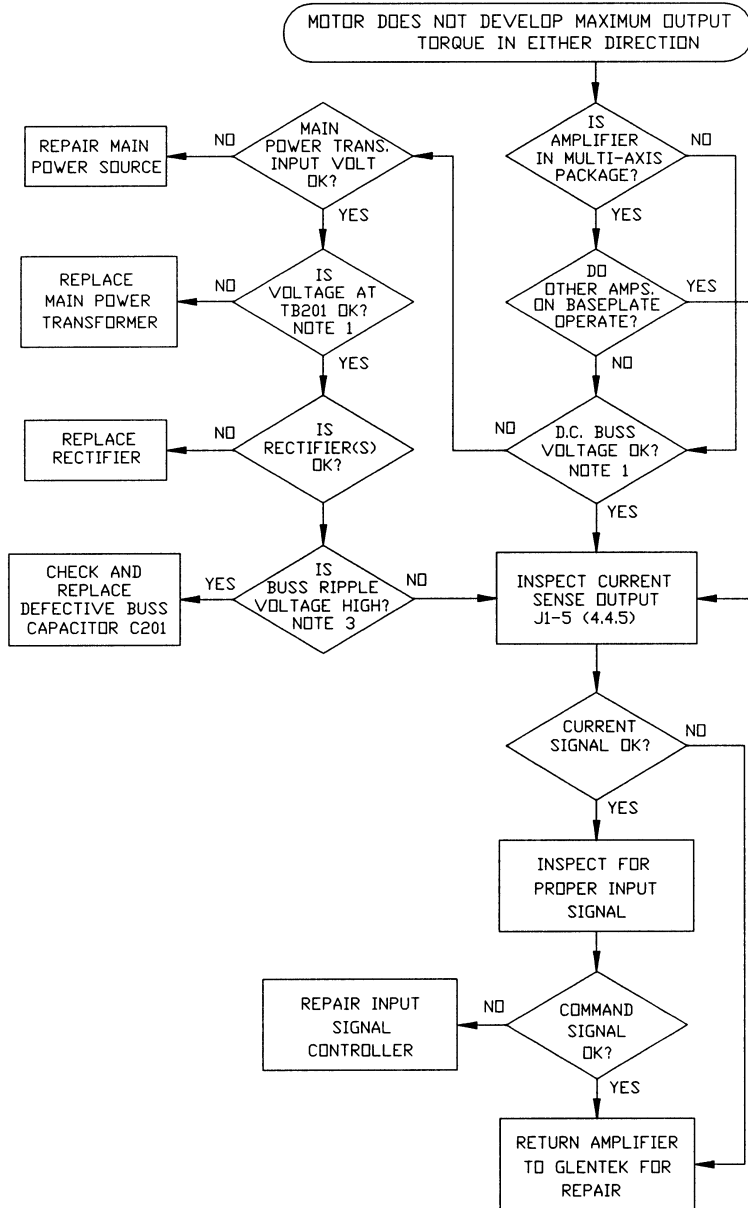

Fault Chart 5

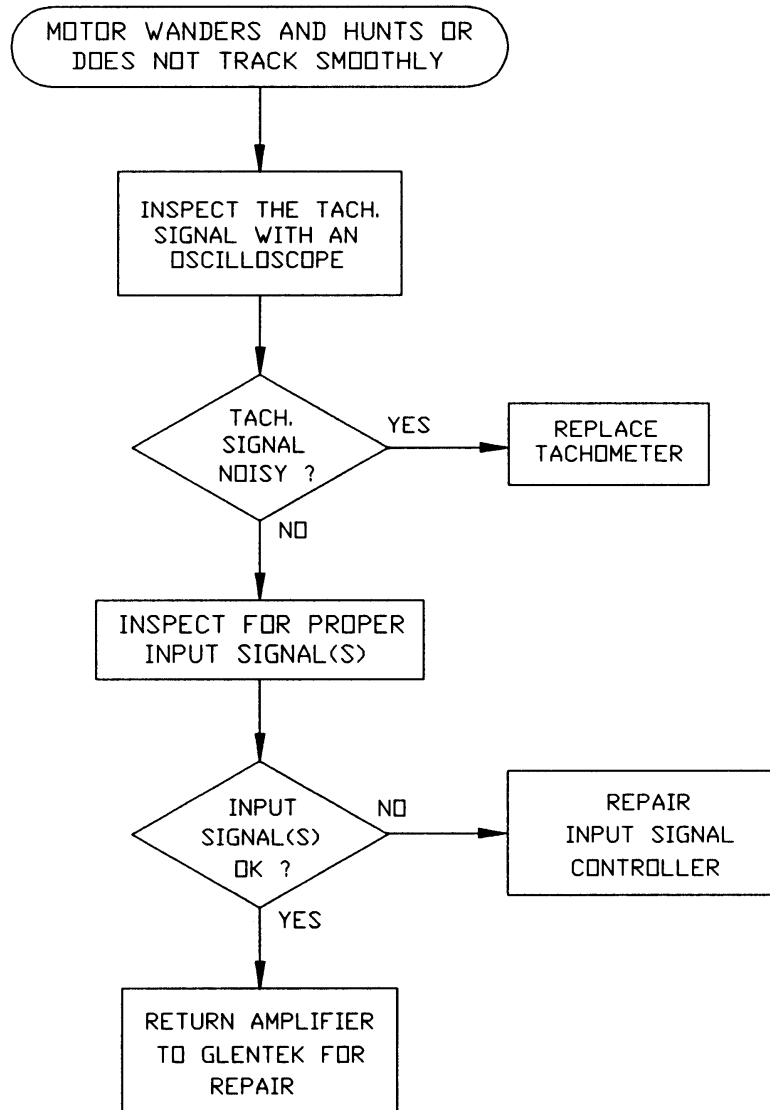

APPENDIX B
AMPLIFIER DRAWINGS

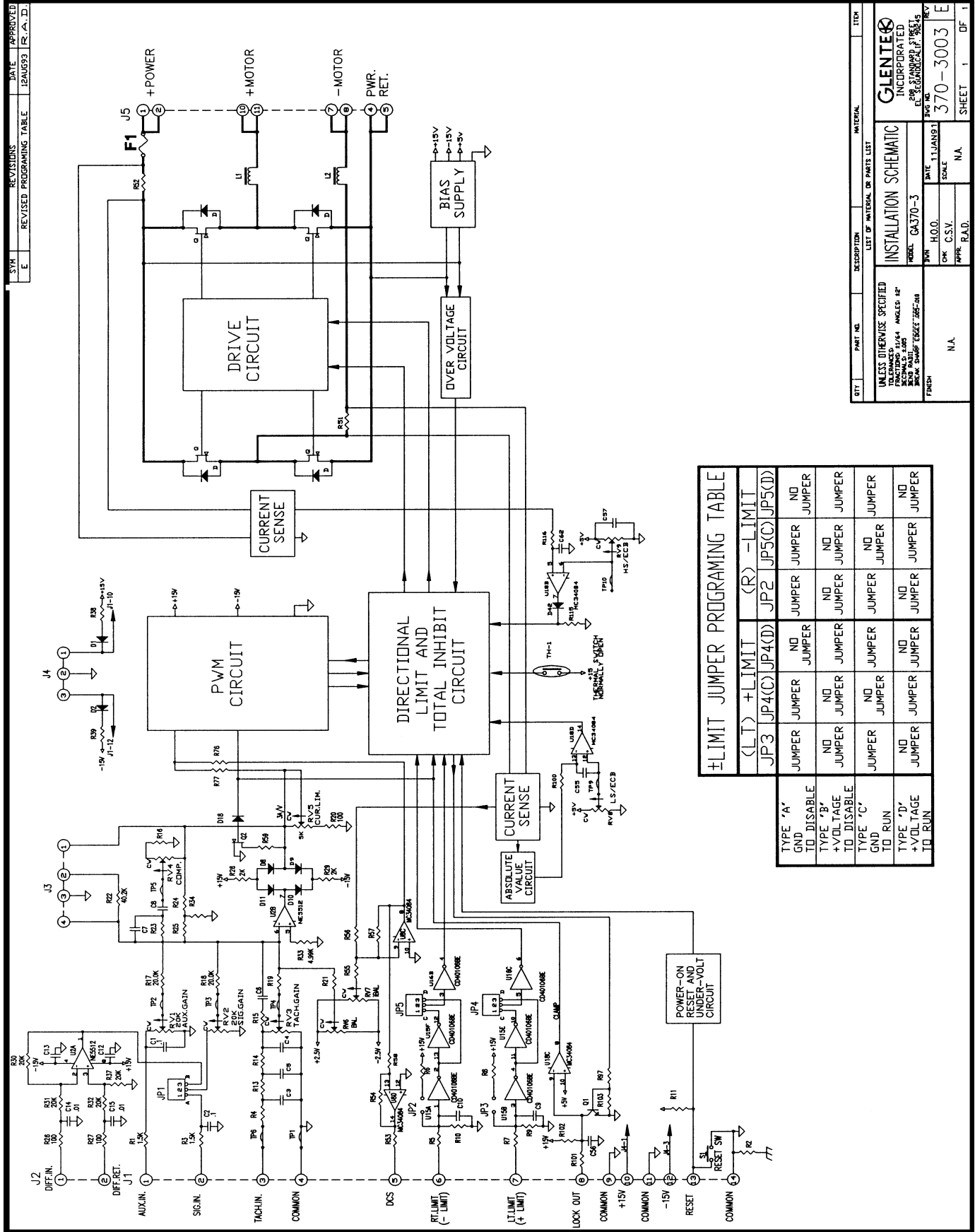

| REV. | DESCRIPTION | DATE | APPROVED |
|------|---------------------------|---------|----------|
| 1 | REVISED PROGRAMMING TABLE | 12AUG93 | R.A.D. |

| | | | | | | | | | |
|------------------------------|--|----------------|--|----------------|--|------------|--|---------------|--|
| GTY | | PART NO. | | DESCRIPTION | | MATERIAL | | ITEM | |
| UNLESS OTHERWISE SPECIFIED | | | | | | | | | |
| TOLERANCES: DIMS: ANGLES: 1F | | | | | | | | | |
| MOUNTING: 2X4 | | | | | | | | | |
| WELD: 1/16" DIA. | | | | | | | | | |
| HOLE: 1/16" DIA. | | | | | | | | | |
| FINISH: 11JAUN91 | | | | | | | | | |
| FRONT | | | | | | | | | |
| INSTALLATION SCHEMATIC | | MODEL: GA370-3 | | DATE: 11JAUN91 | | SCALE: N/A | | SHEET: 1 OF 1 | |
| DRAWN: N/A | | CHK: C.S.V. | | APPR: R.A.D. | | PART NO: | | 370-3003 E | |

LIMIT JUMPER PROGRAMMING TABLE

| TYPE | (LT) | +LIMIT | (R) | -LIMIT |
|------------|-----------|-----------|-----------|-----------|
| TYPE 'A' | JP3 | JP4(C) | JP4(D) | JP2 |
| TYPE 'B' | NO JUMPER | JUMPER | NO JUMPER | JUMPER |
| TYPE 'C' | JUMPER | NO JUMPER | JUMPER | NO JUMPER |
| TYPE 'D' | NO JUMPER | JUMPER | NO JUMPER | JUMPER |
| TO RUN | JUMPER | NO JUMPER | JUMPER | NO JUMPER |
| TO DISABLE | NO JUMPER | JUMPER | NO JUMPER | JUMPER |
| TO RUN | JUMPER | NO JUMPER | JUMPER | NO JUMPER |
| TO DISABLE | NO JUMPER | JUMPER | NO JUMPER | JUMPER |
| TO RUN | JUMPER | NO JUMPER | JUMPER | NO JUMPER |
| TO DISABLE | NO JUMPER | JUMPER | NO JUMPER | JUMPER |
| TO RUN | JUMPER | NO JUMPER | JUMPER | NO JUMPER |
| TO DISABLE | NO JUMPER | JUMPER | NO JUMPER | JUMPER |

| SY# | REVISIONS | DATE | APPROVED |
|-----|---|---------|----------|
| - | REPLACES 370-3002 (A) REVISED TO MATCH REV (C) PCB | 170019Z | J.C.V. |

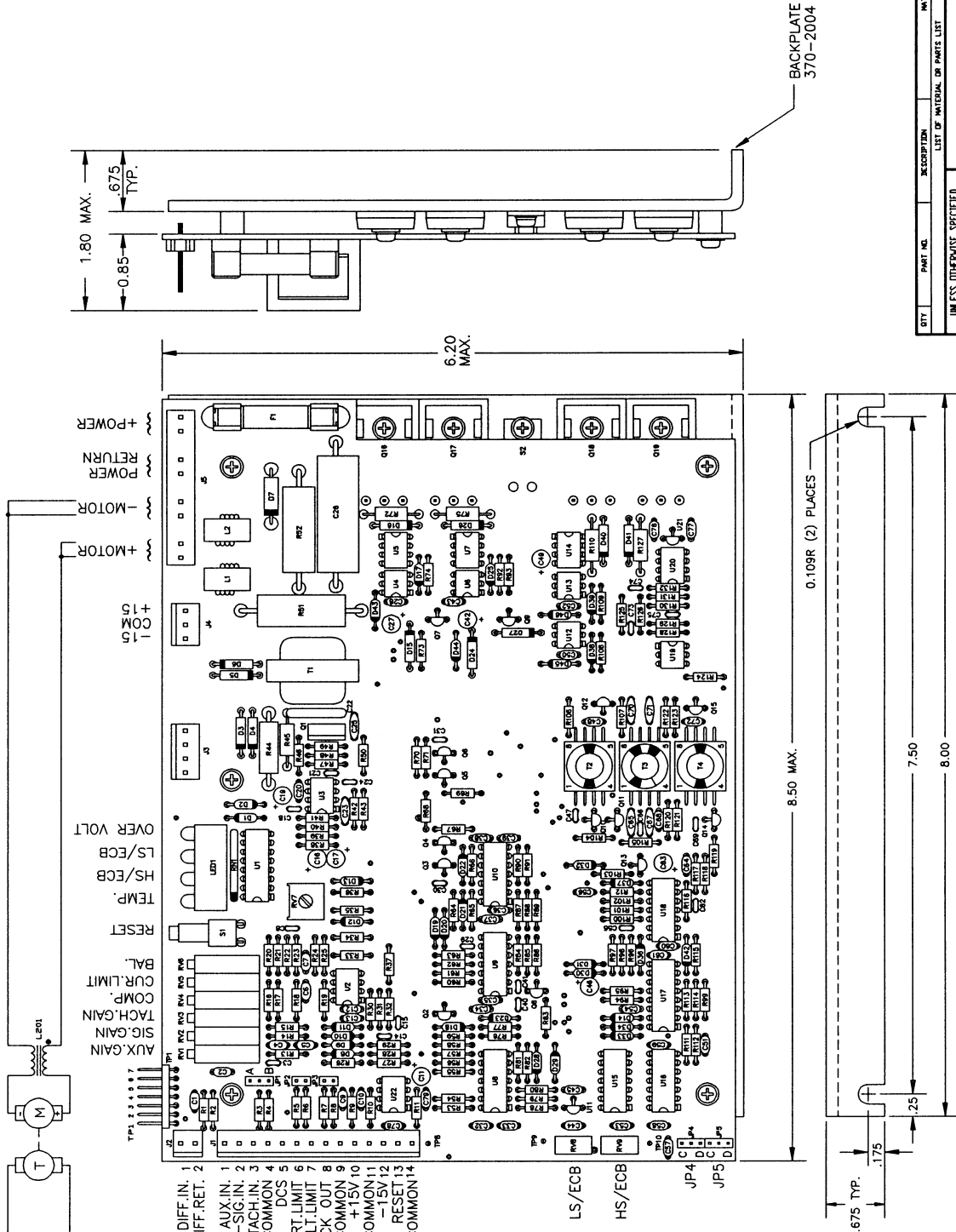

SCHEM: 370-3000 (E)
AW: 370-3001 (C)
EPL: 370-3009 (F)

| QTY | PART NO. | DESCRIPTION | MATERIAL | ITCM |
|--|----------|-------------|----------|--------------|
| UNLESS OTHERWISE SPECIFIED | | | | |
| TOLERANCES: FRACTIONS: 1/64 ANGLES: 45° | | | | |
| DECIMALS: 0.005 UNLESS OTHERWISE SPECIFIED | | | | |
| FINISH: BULK: SHIMMERS: 100-100-100 | | | | |
| INSTALLATION DIAGRAM | | | | |
| REV: | GA370-3 | DATE: | 19DEC80 | REV: |
| BY: | H.O.O. | SCALE: | N.A. | 370-3018 |
| CHK: | M.H.ESS | | | - |
| APPR: | R.A.D. | | | SHEET 1 OF 1 |

| REV | DATE | APPROVED |
|-----|------|----------|
| | | |

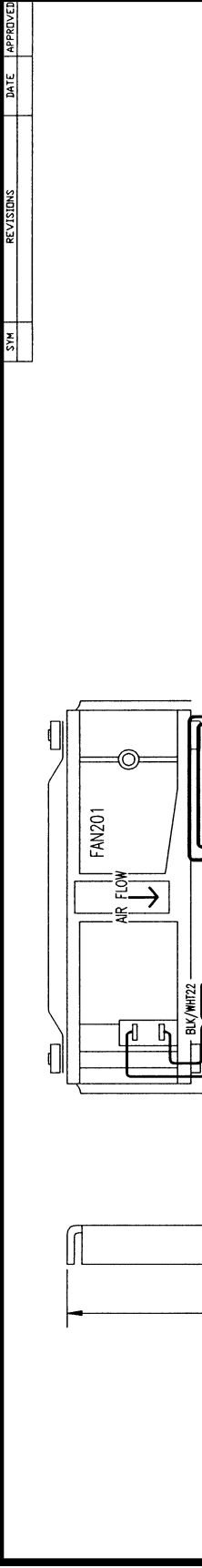

NOTES:
 1-NEVER GROUND THE OUTPUTS OF THE AMPLIFIER.
 2-USE SHIELDED CABLE FOR SIGNAL AND TACHOMETER LEADS; CONNECT SHIELD TO SIG. OR TACH. COM.

| | | |
|---|-----------|--------------------------------|
| 1 | FAN201 | FAN 120VAC, 50-60 HERTZ |
| 1 | F201 | FUSEHOLDER AND FUSE, 15AMP MDA |
| 1 | R201 | RESISTOR, 10K, 10W |
| 1 | C201,C202 | CAPACITOR, 2500MFED, 250VDC |
| 1 | T201 | TERMINAL STRIP, 6PIN |
| 1 | BR201 | RECTIFIER MD42504 |
| 1 | A1 | AMPLIFIER MODULE, GA370-1 |
| 1 | 370-3017 | 1-AXIS BASEPLATE |

UNLESS OTHERWISE SPECIFIED TOLERANCES ARE ANGLES: 45° RECESSES: .015" BEAD RADIUS: .03" EDGE WEIGHT: .030" FINISH: N/A

| ITEM | PART NO. | DESCRIPTION | MATERIAL |
|------|----------|------------------|----------|
| 1 | 370-3017 | 1-AXIS BASEPLATE | |

| | |
|----------|------------|
| MODEL: | GA370-1A-1 |
| DATE: | 20JUL92 |
| SCALE: | N/A |
| DWG NO.: | 370-3004 |
| SHEET: | 1 OF 1 |

1-AXIS
 INSTALLATION DIAGRAM
 MODEL: GA370-1A-1

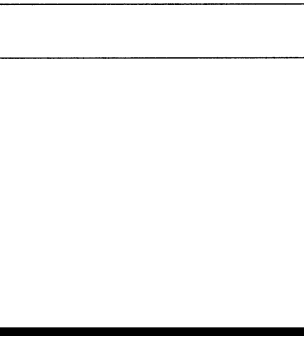

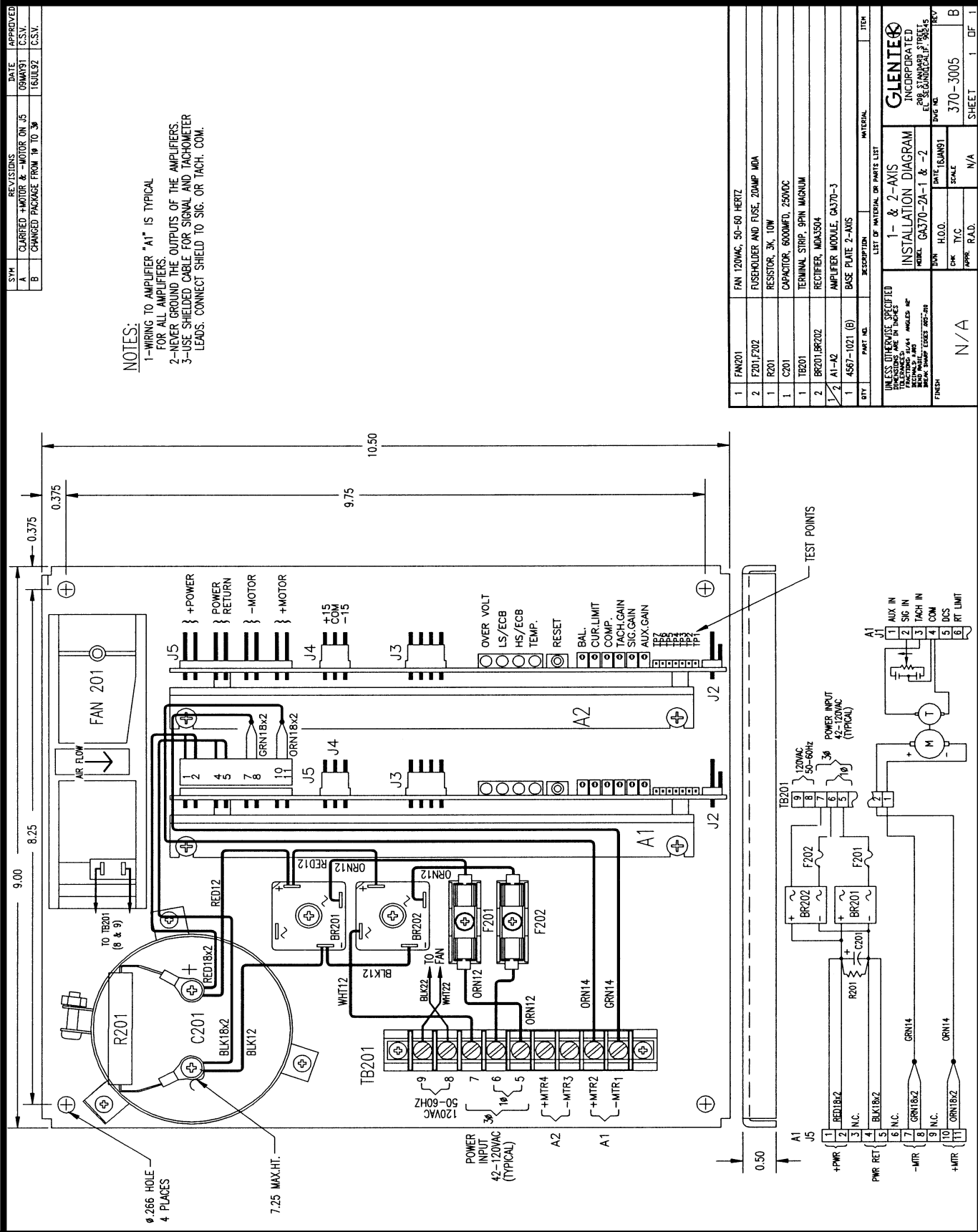

| SYM | REVISIONS | DATE | APPROVED |
|-----|--------------------------------|---------|----------|
| A | CLEARIED +MOTOR & -MOTOR ON J5 | 09MAY91 | C.S.S.V |
| B | CHANGED PACKAGE FROM 1B TO 3B | 16JUL92 | C.S.S.V |

NOTES:

- 1-WIRING TO AMPLIFIER "A1" IS TYPICAL FOR ALL AMPLIFIERS.
- 2-NEVER GROUND THE OUTPUTS OF THE AMPLIFIERS.
- 3-USE SHIELDED CABLE FOR SIGNAL AND TACHOMETER COMMON.
- 4-3 AXIS MODEL GA370-4A-3, OMMITS AMPLIFIER MODULE "A4".

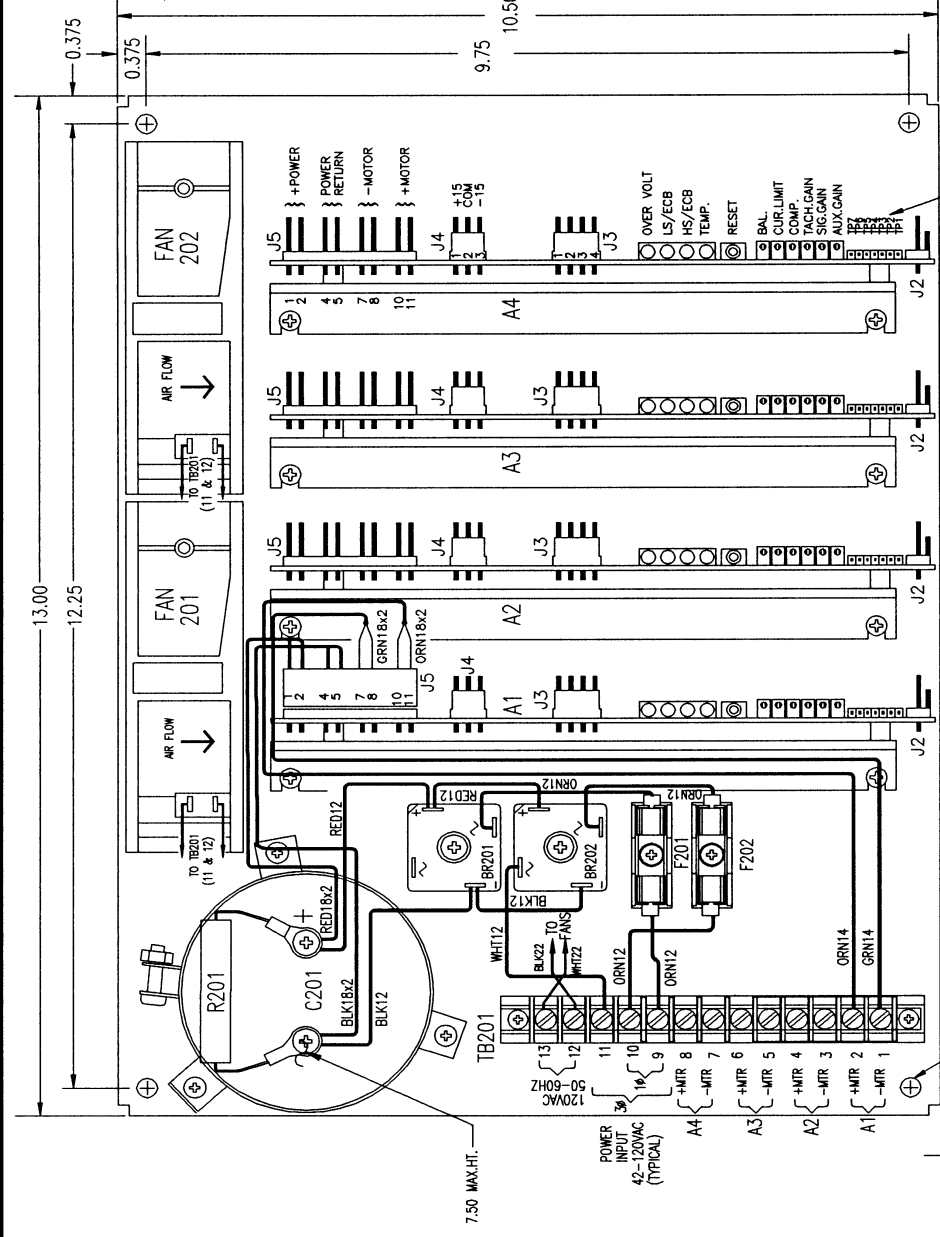

| QTY | PART NO. | DESCRIPTION | MATERIAL | ITEM |
|-----|-------------|---|----------|------|
| 2 | FAN 201&202 | FAN 120VAC, 50-60 HERTZ | | |
| 2 | F201,F202 | FUSEHOLDER AND FUSE, 20AMP MDA | | |
| 1 | R201 | RESISTOR, 3K, 10W | | |
| 1 | C201 | CAPACITOR, 6000MFD, 250VDC | | |
| 1 | TE201 | TERMINAL STRIP, 12PIN X 2, 0.093X 0.085(TPM) 12-141 | | |
| 2 | BR201,BR202 | RECTIFIER MDA3504 | | |
| 3 | A1-A4 | AMPLIFIER MODULE, GA370-3 | | |
| 1 | 4567-1006 | BASE PLATE 4-AXIS | | |

UNLESS OTHERWISE SPECIFIED DIMENSIONS ARE IN INCHES FRACTIONS SHALL BE IN 16ths UNLESS NOTED OTHERWISE

3- & 4-AXIS INSTALLATION DIAGRAM

DATE: 10AUG91 SCALE: N/A

REV. NO. 370-3006 SHEET 1 OF 1

INCORPORATED 208 STANDARD STREET EL SEANDO, CALIFORNIA 90245

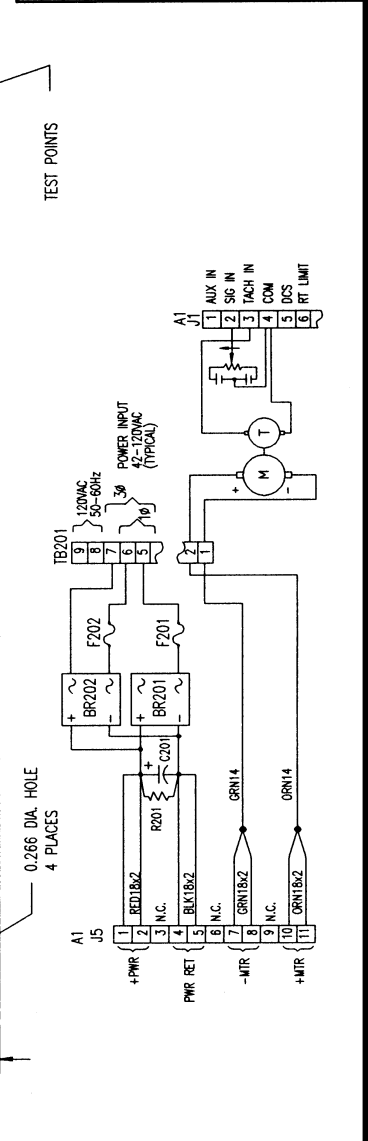

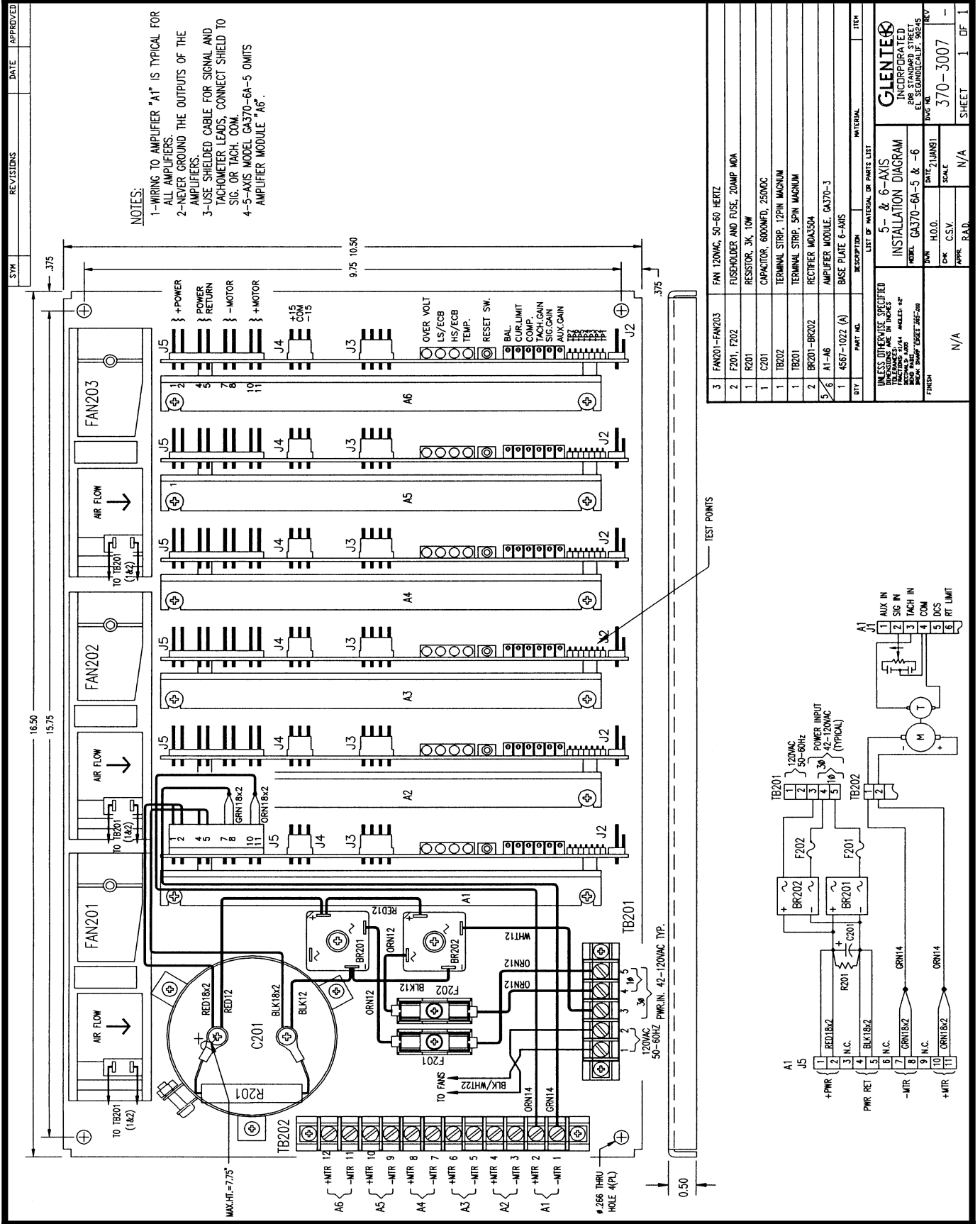

| REV | SYN | REVISIONS | DATE | APPROVED |
|-----|-----|-----------|------|----------|
| | | | | |

| BY | PART NO. | DESCRIPTION | MATERIAL | QTY |
|----|---------------|--------------------------------|----------|-----|
| 3 | FAN201-FAN203 | FAN 120VAC, 50-60 HERTZ | | |
| 2 | F201, F202 | FUSEHOLDER AND FUSE, 20AMP MDA | | |
| 1 | R201 | RESISTOR, 3K, 10W | | |
| 1 | C201 | CAPACITOR, 6000MFD, 250VDC | | |
| 1 | TB202 | TERMINAL STRIP, 12PIN MAGNUM | | |
| 1 | TB201 | TERMINAL STRIP, 5PIN MAGNUM | | |
| 2 | BR201-BR202 | RECTIFIER MODULES | | |
| 5 | A1-A6 | AMPLIFIER MODULE, GA370-3 | | |
| 1 | 4557-1022 (A) | BASE PLATE 6-AXIS | | |

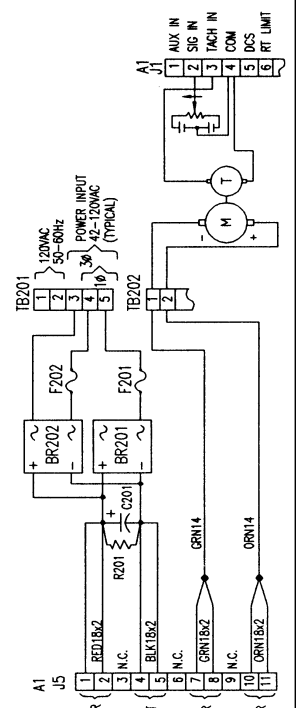

High Bandwidth Brush Type Servo Amplifiers

- Linear Brush type servo amplifiers to 2.25KW
- PWM (Pulse-width-modulated) Brush type servo amplifiers to 70KW

High Bandwidth Brushless Servo Amplifiers

- Linear Brushless servo amplifiers to 2.25KW
- PWM (Pulse-width-modulated) Brushless servo amplifiers to 65KW

Permanent Magnet DC Brush Type Servo Motors

- Continuous Torques to 335 in. lb.
- Peak Torques to 2100 in. lb.

Permanent Magnet DC Brushless Servo Motors

- Continuous Torques to 1100 in. lb.
- Peak Torques to 2200 in. lb.



GLENTEK

"Solutions for Motion Control"

MANUAL #: 370-3040-000

208 STANDARD STREET, EL SEGUNDO, CALIFORNIA 90245, USA.
TELEPHONE: (310) 322-3026 FAX: (310)322-7709
WWW.GLENTEK.COM