

# BENCH BRIEFS

SERVICE INFORMATION FROM HEWLETT-PACKARD

SEPTEMBER-OCTOBER 1977

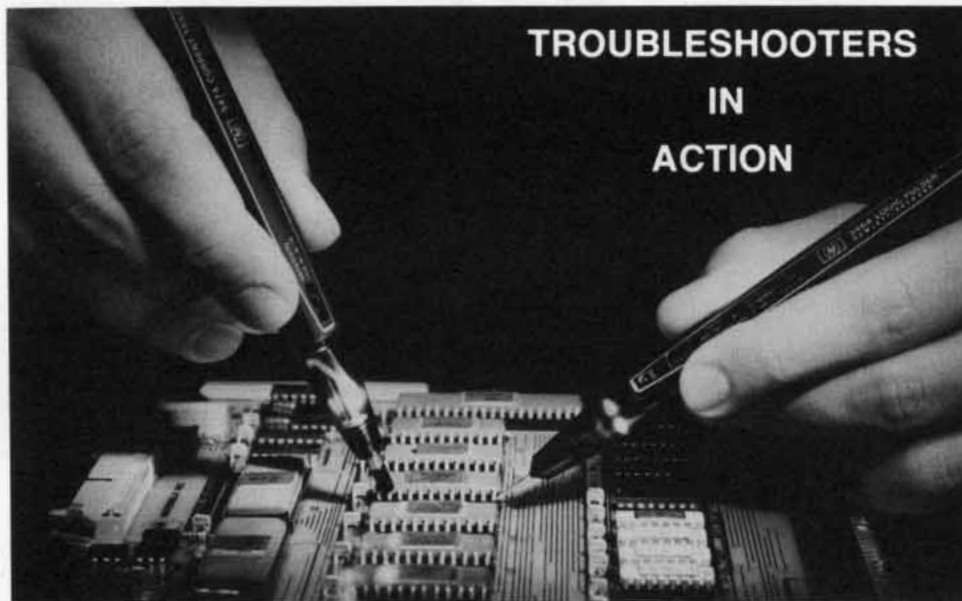

by Jim Bechtold, Editor

## ANALOG CIRCUIT TESTING

When troubleshooting circuits built with discrete components (resistors, capacitors, transistors, etc.), the task is one of verifying relatively simple characteristics such as resistance, capacitance, or bias voltages of components. While the function of the total circuit may be quite complex, each component in that circuit performs a relatively simple task, and proper operation is easily verified using a signal generator and a voltmeter, ohmmeter, diode checker, or oscilloscope — the traditional troubleshooting tools. But when this circuit is built in integrated circuit form, these components are no longer accessible. It now becomes necessary to test the operation of the complete circuit function using specialized IC troubleshooters.

*"Node" as used in this article and throughout the digital troubleshooting world means the point at which a collection of component terminals and interconnections come together, or the intersection or junction of two or more pc traces or wires, or an eyelett with a component lead soldered in it. — Editor.*

## TROUBLESHOOTERS IN ACTION

The traditional equipment can still be used, but an important characteristic of digital IC's is that when they fail, they usually fail catastrophically. This means that timing parameters rarely degrade or become marginal. Thus, observing timing parameters on an oscilloscope and making repeated decisions on their validity (a time consuming ordeal that contributes very little to the troubleshooting process), can all but be eliminated. The fact that pulse activity exists is usually enough indication of proper IC operation without further observation of pulse width, repetition rate, rise time or fall time.

Figure 1 shows a typical TTL (Transistor-Transistor-Logic) signal; one of the most popular IC logic family. This might as well be any analog signal when viewed on an oscilloscope. The oscilloscope displays absolute voltage with respect to time, but in the digital world absolute values are unimportant. A digital signal exists in one of two or three states — high, low, and undefined or in-between level — each determined by a threshold voltage. It is the relative value of the signal voltage with respect to these thresholds that determines the state of

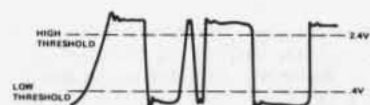

Figure 1. TTL Signal. In the digital world, the relative value of a signal voltage with respect to the threshold voltages determines the operation of the circuit. A signal above the high threshold is in the high state and whether it is 2.8V or 3.0V is unimportant to the operation of the circuit.

the digital signal and this digital state determines the operation of the IC, not absolute levels. In Figure 1, if the signal is greater than 2.4 volts, it is a high state and it is unimportant whether the level is 2.8 or 3.0 volts. Similarly for a low state the voltage must be below 0.4 volts. It is not important what the absolute level is as long as it is below this threshold. Thus when using an oscilloscope, the troubleshooter must over and over again determine if the signal meets the threshold requirement for the desired digital state.

Figure 2 shows a problem created by the TTL logic family. The output stage of a TTL device is a transistor totem pole. In either the high or low state, it is a low impedance. In the low state it is a saturated transistor to ground. It thus appears as 5—10 ohms to ground.

## IN THIS ISSUE

TROUBLESHOOTERS IN ACTION

SERVICE NOTE INDEX

5061A CESIUM BEAM  
SERVICE SEMINAR

NEW SERVICE NOTES

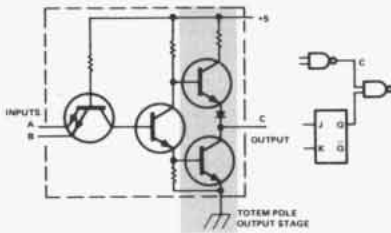

**Figure 2. TTL Logic.** When stimulating a node in circuit, such as C above, it is necessary to override the low impedance totem pole output stage driving that node. When the output is in the low state, it is a saturated transistor to ground. Presently used signal sources are not powerful enough to override this low state.

This presents a problem to in-circuit stimulation. A signal source used to inject a pulse at a node which is driven by a TTL output must have sufficient power to override the low impedance output state. Most conventional sources presently used for troubleshooting do not provide this capability. It has been necessary for the troubleshooter to either cut printed circuit traces or pull IC leads in order to stimulate the circuit being tested. Both of these practices are time consuming and lead to unreliable repairs. Now, instead of cutting traces, you can use specialized tools such as HP's Logic Pulser and Current Tracer or Gen-Rad's new Bughound — a signal source and microvolt meter.

Thus the use of the traditional oscilloscope and the traditional signal sources is inefficient. These tools are general purpose tools that can be applied to any situation if the troubleshooter has enough time. But with the quantity and complexity of today's electronic circuits, it makes sense to find the most efficient solution to the problem at hand. This suggests using the oscilloscope, diode checkers and voltmeter on discrete components where they really shine, and using instruments that take advantage of the digital nature of signals on the digital circuitry to be repaired.

## PRELIMINARY DIGITAL CIRCUIT TESTING

The type of digital circuit we are discussing here is normally part of an instrument. Individual board testing in a production environment is best handled by specialized automatic test equipment designed for that type of

job. However, in a production environment, once the trouble area in the reject board is isolated, the IC troubleshooters can be used to narrow the fault down to a component level.

The first step, usually before you pick up your tools, is to read the failure report to get an idea of the problem. Then analyze the symptoms yourself and compare them to the report. Many times there's more wrong with the instrument than the failure report indicates. Turn on the instrument if possible, and learn as much as you can from the front panel mis-operation (commonly called, "front panel milking"), to narrow down the malfunctioning area.

Next check power supply voltages. A low voltage does not necessarily mean the supply has failed, it may simply be loaded beyond its capacity by a short of some kind. Also check the supply voltage for excessive ripple which can cause false triggering. A counter, for example, that resets or counts erratically may have excessive power supply ripple. If the power supply voltage and ripple are ok, try to localize the trouble to one suspected module or circuit. This is usually done dynamically using an oscilloscope or logic probe and the equipment's service manual. Dynamic testing means to operate the equipment at its intended speed while checking for key signals. The service manual should indicate the key signals and where they're located. Often a key signal such as the clock pulse will completely disappear, localizing the fault down to a module or small group of IC's.

So, hopefully by now you have narrowed the problem down to a board, module, or circuit area. However, in order to troubleshoot to a component level efficiently, it's important to understand the type of failures found in digital integrated circuits.

## TYPES OF FAILURES

IC failures can be categorized into two main classes; failure in the circuit **external** to the IC, and **internal** IC failure. The four types of **internal** failures are:

- An open bond on either an input or output
- A short between two pins, neither of which is Vcc or ground

- A short between an input or output and power supply or ground
- A failure in the internal circuitry of the IC

In addition to these four internal IC failures, there are four failures that can occur in the circuit **external** to the IC. These are:

- An open signal path
- A short between two pins, neither of which are power supply or ground
- A short between a pin and power supply or ground
- A failure of a discrete component

Before discussing how to detect each of these failures, let's get an idea of the effect each has upon overall circuit operation. For example, an open bond failure has a different effect depending upon whether it is an open output bond or an open input bond.

**OPEN OUTPUT BOND** — If we have an open output bond (see Figure 3), the inputs (Point B for example) driven by that output are left to float. TTL and DTL logic circuits interpret a floating input as a HIGH. Thus an open output bond will cause all inputs driven by that output to respond to the bad level as though it were a static high signal. However, when checked by a logic probe the input shows as a "bad level" (neither high or low).

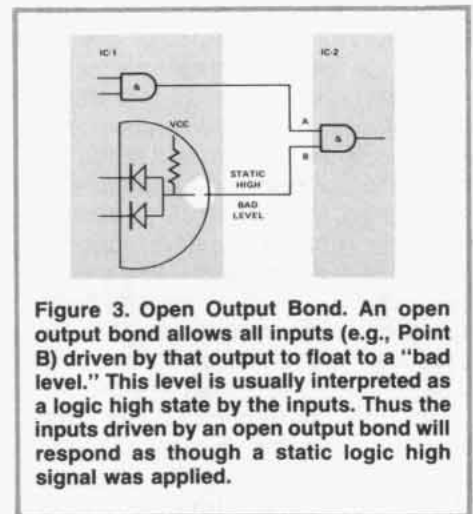

**Figure 3. Open Output Bond.** An open output bond allows all inputs (e.g., Point B) driven by that output to float to a "bad level." This level is usually interpreted as a logic high state by the inputs. Thus the inputs driven by an open output bond will respond as though a static logic high signal was applied.

**OPEN INPUT BOND** — In the case of an open input bond (see Figure 4), the open circuit blocks the signal driving the input from entering the IC chip. The input on the chip is thus allowed to float and will respond as though it were a static high signal.

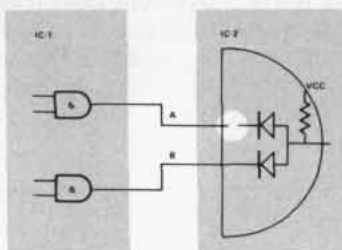
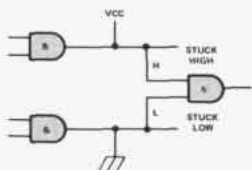

**Figure 4. Open Input Bond.** An open input bond has the effect of blocking the input signal from reaching the chip which allows the input of the chip to float to a "bad level." Thus, even though the signal can be viewed at external Point A, the input of the chip responds to the "bad level" as though it were a static high level.

It's important to realize that since this open occurs inside the IC, the digital signal driving this input at Point A will be unaffected by the open and will be detectable as a good signal when looking at the input pin. The effect will be to block this signal inside the IC and the resulting IC operation will be as though the input were a static high.

**OPEN SIGNAL PATH** — An open signal path creates the same symptoms as described for open output and input bonds. The signal on the output side of the open responds normally while on the input side, floats to a "bad level".

**SHORTS TO Vcc OR GROUND** — External or internal shorts to Vcc or ground all have the same effect on the circuit (see Figure 5). A short between a pin and Vcc will cause the signal lines connected to the pin to be stuck high. A short between a pin and ground will cause the signal lines connected to the pin to be stuck low.



**Figure 5. Shorts to Vcc or Ground.** A short between input or output and Vcc (Point H) causes the line to be stuck high. A short to ground (Point L) causes the line to be stuck low.

**SHORTS BETWEEN PINS** — External or internal shorts between two pins have the same effect on the circuit (see Figure 6). Whenever both outputs attempt to go high simultaneously or to go low simultaneously, the shorted pins will respond properly. But whenever one output tries to go high and the other output low, the low will always win. The shorted pins will be stuck low.

**INTERNAL IC FAILURES** — Any failure of the internal circuitry usually causes the output to be stuck either high or low.

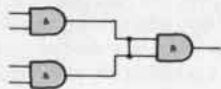

**Figure 6. Shorts Between Pins.** The pins will go high and low together, but when one tries to go high and the other low, low will always win.

## USING THE TROUBLESHOOTERS

The specialized logic troubleshooters we'll be using are:

- HP 545A Logic Probe
- HP 546A Logic Pulser
- HP 548A Logic Clip
- HP 10529A Logic Comparator
- HP 547A Current Tracer

In most cases the probe, pulser, and clip will do the job, but since the comparator and current tracer add another dimension, we'll touch on those also.

**THE LOGIC PROBE** — After milking the front panel for clues, and checking the power supply voltage and ripple, use the logic probe to detect the presence of key pulses. Make sure the switch on the probe is set for the correct logic family, or if there is no switch, make sure it has been designed to test the correct family (TTL, CMOS, DTL). See Figure 7.

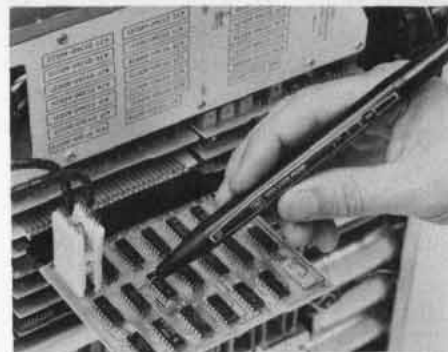

**Figure 7. 547A Logic Probe.** Most effective troubleshooting tool to detect pulse activity.

Probe the circuit. The logic probe lamp will flash at about 10 Hertz when you monitor pulses up to 80 MHz in TTL and 40 MHz in CMOS. Probing usually isolates the failure to a small group of IC's.

**THE LOGIC COMPARATOR** — Next, the logic comparator, which can test TTL and DTL logic families at frequencies up to 3 MHz, is used to check the suspected IC's for bad nodes (circuit interconnections). The comparator is clipped onto the suspected IC, and uses the in-circuit signals to drive an identical IC installed inside the comparator (see Figure 8). Any difference in operation is indicated by a lit LED. Note that only **output** differences are indicated, not input differences. This means that the comparator will **not** detect an open signal path because the output in front of the open responds normally, while the input behind the open floats to a static high and does not respond at all (refer to Figure 12).



**Figure 8. 10529A Logic Comparator.** An IC is checked during in-circuit operation.

**THE PULSER/PROBE/CLIP COMBINATION** — After the comparator has been used to dynamically narrow the faulty area down to several IC's, we can change to stimulus-response testing where the logic pulser is used to replace the system clock. This allows us to single-step the circuit while the probe or clip monitors the output.

The logic pulser automatically drives the circuits connected to it to their opposite state. Every time it's pulsed, it forces a low to momentarily go high and a high to momentarily go low. This particular pulser (the HP 546A) can also be programmed to output pulse bursts or pulse streams by pressing the push-button according to the code shown on the barrel of the pulser. Refer to Figure 9.

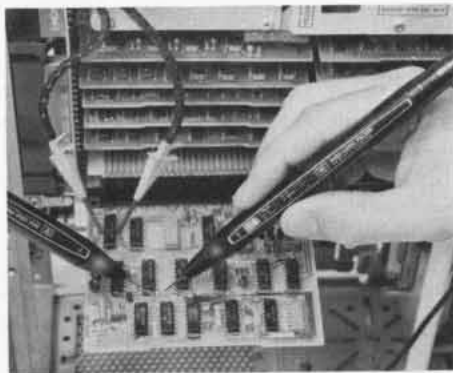
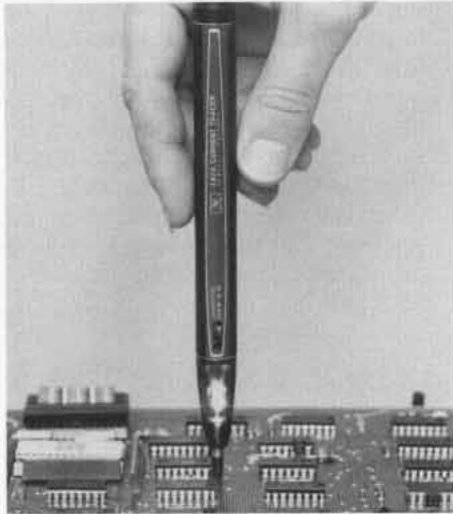

**Figure 9. 546A Logic Pulser.** This pulser can be programmed to output single pulses, bursts or streams.

The logic clip can be used together with the logic pulser to slowly single-step a counter or shift register to verify outputs, resets, clears and other signals. Where the clip will monitor up to 16 pins simultaneously, the logic probe monitors only one, however, the probe will provide a lot more information. When you touch the probe to the point you want to measure, the lamp will either glow bright, dim, or go out.

- Glows bright means a logic high.
- Goes out means a logic low.
- Glows dim means a high impedance and usually means you have a bad level. It is also associated with the open output of three state logic.

**THE CURRENT TRACER** — The 547A (see Figure 10) is compatible with all logic families including CMOS. It responds only to current and does not require a ground reference. A sensitivity control is used to adjust the



**Figure 10. 547A Current Tracer.** The lamp near the tip of the tracer varies in brightness according to the relative magnitude of the current. By observing how the lamp's brightness changes as the tracer is moved along the conductors, you follow the flow of current.

lamp for a normal indication of between one-half and fully lit. At this point you can get an indication of the magnitude of the current flowing simply by noting the position of the sensitivity control. Obviously, an abnormally high current indicates a low impedance — probably a short. When you move the tip of the tracer along the signal path the intensity of the indicator lamp tells you if current is flowing. The current tracer's tip need not make physical contact with the conductive path, so current can be followed in insulated wires and along inner traces of multilayer boards.

## LOOKING FOR PARTICULAR FAULTS

A review of the major types of IC failures show that we can have:

- An open signal path
- A short between an IC pin and Vcc or ground
- A short between IC pins (neither of which are Vcc or ground)

Now let's try to pinpoint these failures to the faulty component using the troubleshooters to their full advantage.

**OPEN SIGNAL PATH** — The pulser/probe combination shows a bad level (dim lamp) at an output. A bad level at an output pin usually indicates an open output bond. To make sure, piggyback the IC under test with another of the same type known to be good.

See Figure 11 for the piggyback technique. If the probe light **now** indicates a high or low, then the IC is definitely bad and must be replaced. Piggybacking is a good technique to use if you suspect open input or output bonds.

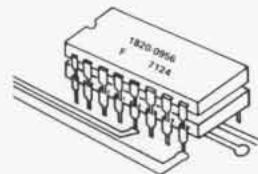

**Figure 11. Piggyback Example.** Make certain the IC's are identical. Also, the pins may have to be bent slightly inward to make good contact.

Another bad level example may be found at the input to an IC when the previous stage is open. (Either an open output bond or open trace.) Refer to Figure 12.

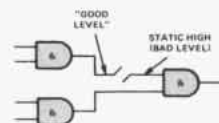

**Figure 12. Open Signal Path Example.**

An open signal path allows the input downstream of the open to float to a bad level. Use the logic probe to test the input of each IC for the bad level (probe lamp glows dim). After it's found, use the probe to follow the circuit trace back until the bad level changes to a good level (either high, low, or pulsing). The point where the change occurs pinpoints the open signal path.

**SHORT BETWEEN PIN AND Vcc OR GROUND** — The probe and pulser can be used in tandem to locate any pins that are shorted to the supply voltage or ground. If the logic probe indicates a high at the defective pin, touch the pulser to the same pin. If the probe cannot be pulsed, then we have a short to the power supply. A low that

cannot be pulsed high indicates a short to ground. The short can be either internal to the IC, along the external signal path, or internal to any IC's connected to the signal path.

Another way to locate a Vcc-to-ground short is with the current tracer and logic pulser (see Figure 13). To find the short, disconnect the power supply and pulse the power supply terminal using the logic pulser with the supply return connected to the GND lead of the pulser. Even if capacitors are connected between Vcc and ground, the current tracer will usually reveal the path carrying the greatest current.



Figure 13. Looking for shorts.

The current tracer can also be used to locate a short to ground. Use the pulser on the shorted pin and set the tracer's sensitivity control to get an indication. Then, trace the circuit to see where the current is flowing. The tracer light will go out when you pass the short.

**SHORT BETWEEN PINS** — The probe and pulser can also be used together to locate any shorted pins. To check for a short between pins, pulse the bad pin of the IC under test while monitoring any other suspected pins with the probe. If the probe can be pulsed, a short is indicated between the pulsed and probed pins. Reverse the probe and pulser and repeat the test. If the probe can still be pulsed, then we definitely have a short between two pins. A likely cause is a short in the circuit external to the IC's. Examine the circuit board closely for any possible shorts between printed circuit traces. Only if the two shorted pins are common to one IC can the failure be internal to that IC.

**INTERNAL IC FAILURE** — What if you have a stuck node caused by dead driver. Figure 14 illustrates a frequently occurring troubleshooting

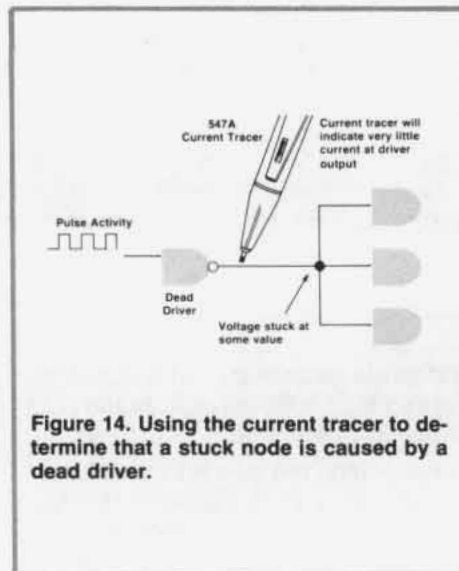

Figure 14. Using the current tracer to determine that a stuck node is caused by a dead driver.

symptom: a node has been identified on which the voltage is stuck high or low. Is the driver dead, or is something, such as a shorted input, clamping the node to a fixed value? This question is answered by tracing current from the driver to other components on the node. If the driver is dead, the only current indicated by the tracer will be that caused by parasitic coupling from any nearby currents, and this will be much smaller than the normal current capability of the driver. On the other hand, if the driver is good, normal short circuit current will be present and can be traced to the fault.

Another form of a stuck node is one caused by input short. Figure 15 illustrates this situation, which has exactly the same voltage symptoms as the previous case of a stuck node caused by a dead driver. However, the current tracer will now indicate a large current flowing from the driver, and will also make it possible to follow this current to the cause of the problem, the shorted input. The same procedure will also find the fault when the short is on the interconnecting path of the node — for example, a solder bridge to another node.

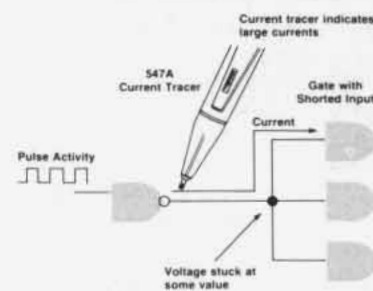
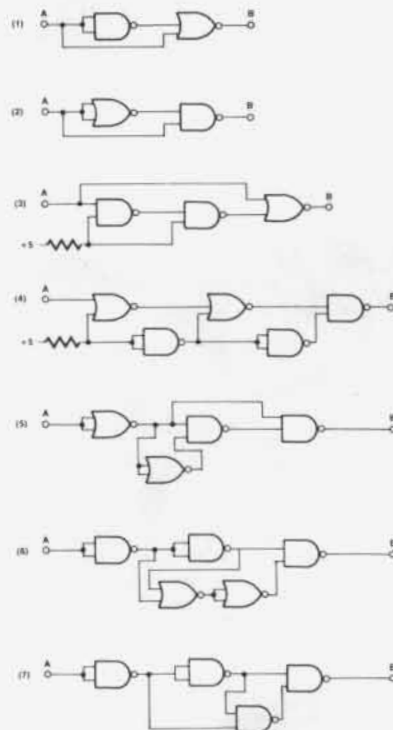

Figure 15. The current tracer shows that this stuck node is caused by an input short.

The material used in this article to show the systematic elimination of possible failures in digital IC's, together with the use of test equipment designed specifically for troubleshooting digital circuits, is based on information from Application Note 163-1, and the videotape series "Digital Troubleshooting" (HP p/n 90420D).

## TTL LOGIC QUIZ

Now that you're an expert at digital troubleshooting, try your TTL IQ on these circuits. For each one, determine the resulting outputs at B for the two possible logic inputs "high" or "low" at A.



## TROUBLESHOOTING THE 8505A NETWORK ANALYZER

Four new service notes have been written to help technicians reduce repair times for certain subassemblies of the 8505A. Each service note is a complete troubleshooting guide that includes general theory of operation, block diagrams, schematics, and a troubleshooting procedure. The service notes are:

- 8505A-6 — A3A11 Group Delay Detector
- 8505A-7 — A3A4 Processor Interface Board
- 8505A-10 — A3A5 Processor D/A Board
- 8505A-12 — CRT Control Circuits
- 8505A-17 — A3A17 Marker I
- 8505A-18 — A3A18 Marker II

Use the service note order form on page 11 and write the service note numbers in the margin (these notes were issued after the form was completed).

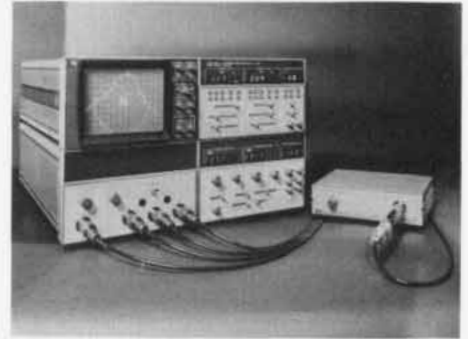

### Service Tips

## X-Y DISPLAYS

### INTENSITY FLICKER

If you are experiencing an intensity flicker, sometimes accompanied by an audible arcing sound, the culprit may be a static discharge from the CRT grid lead, or the low voltage transformer. If you are not sure the display is arcing, watch the protective neon lamps on boards A5 and A13 for flashing.

To remove the static discharge path, cut the ground lead from the CRT grid

lead at the back of the A5 board. Cutting this lead will not degrade the performance of the unit.

If after cutting the grid lead the flickering still persists, try disconnecting the CRT filament leads from the transformer and connect them to a 6-volt lantern battery.

### WARNING

HIGH VOLTAGE in the form of 4000 volts is present on the CRT filament leads. Use extreme caution and do not touch the lantern battery when the display is on.

If the transformer needs to be replaced, it can be ordered from an HP Sales and Service office specifying one of the following part numbers.

- 1310/1311 — HP pn 9100-3415
- 1313/1317/1321 — HP pn 9100-3437

### INPUT FET

A new improved input FET is now available for the large and small screen displays. In the past, if the input FET was replaced during the normal course of service, bead forming sometimes caused axial cracking of the hermetic seal. The new FET is HP pn 1855-0262 and can be ordered from an HP Sales and Service office.

## MICROWAVE LITERATURE

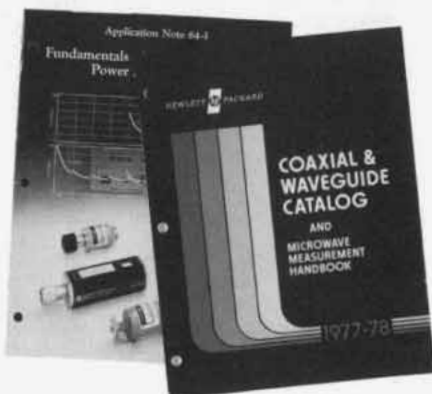

Two new microwave catalogs are available from HP:

**AN 64-1 RF and Microwave Power Measurements.** AN 64-1 is the first in a series of three application notes about power measurements. This series replaces the very popular, but now outdated AN 64. This first note reviews the instruments used for measuring power, discusses error mechanisms, and gives principles for calculating overall measurement accuracy.

**Coaxial and Waveguide Catalog, HP pn 5952-8170.** This microwave measurement handbook contains a Network Analyzer section, an expanded section on associated equipment, accessories and 75 ohm components, plus much more.

If you would like a copy of these catalogs, contact your local HP Sales and Service office.

## ATTENTION 1743A OSCILLOSCOPE OWNERS



A new service kit is available for the 1743A Oscilloscope that positions the Time Interval Board vertically outside the instrument for easier probing and troubleshooting. Order HP pn 01743-69502 from your HP Sales and Service office.

## SAFETY-RELATED SERVICE NOTES

### SPECTRUM ANALYZERS, NETWORK ANALYZERS, SWEEP OSCILLATORS

M57-S is a general Safety Service Note that provides an index to spectrum and network analyzers, and sweep oscillators. If you own one of the instruments on the list below, please perform the indicated safety modifications immediately. If the instrument is returned to a Hewlett-Packard sales or service office, the modification will be completed at no charge.

### 7221A/9872A GRAPHICS PLOTTER

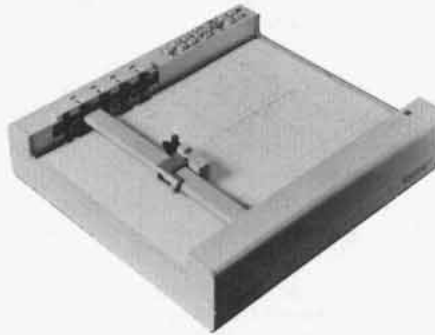

Two safety notes are listed in this issue; 7221A-1-S/9872A-5-S describes a possible shock hazard if the connector on the fan motor cable is inadvertently plugged into J-5 of A-9 (power

supply main printed circuit assy.) backwards. Due to pin alignment the high side of the input supply voltage could be connected to the fan case. The 7221A-1-S/9872A-5-S Safety Service Note describes the complete modification procedure required to correct this problem.

The 9872A-3-S Safety Service Note describes a potential shock hazard if a sheet metal fastening tab has punctured the insulation of a power supply capacitor, and the instrument safety ground is not connected to earth ground. The note provides all the steps necessary to correct this problem.

Instrument Model	Instrument Type	Repair Needed	Serial Number	Service Note Number
140T 141T 8406A 8690B	Oscilloscope Storage Oscilloscope Comb Generator Sweep Oscillator	Fan ground wire needed Fan ground wire needed Fuse wiring reversed Hot & neutral reversed at power receptacle	All Prefixes All Prefixes 1711A01585 & Below 95901651 thru 95901901	140T-1-S 141-7-S 8406A-1-S 8690B-12-S
8692A-4A	RF Units	Ground required on backward Wave Oscillator	1210A07405 & Below	8692-94A-9-S
8695-7A	RF Units	Ground required on backward Wave Oscillator	1210A07405 & Below	8695-97A-8-S
8700A 8705A	RF Drawer Signal Multiplexer	Change ground wire to 18 AWG Transformer primary hot on neutral wires reversed at power receptacle	1320A & Below Serial Prefix 985 thru 1142A	8700-2A-S 8705A-1A-S
8717A	Transistor Bias Supply	Insulate transistors Q1, Q2, Q3 and Q4	Below 917-00111	8717A-2A-S
8717A	Transistor Bias Supply	Insulate transistors Q1, Q2, Q3 and Q4	Below 927-00141	8717A-4A-S
8745A	S-Parameter Test Set	Hot and neutral reversed at power receptacle	0978A00050 thru 1142A-01165	8745A-2A-S

## THE NEW 1977 BENCH BRIEFS SERVICE NOTE INDEX IS AVAILABLE



Maybe some of you don't know what Service Notes really are, and how they can aid you in maintaining the HP instruments you have purchased, or are responsible for. These free Service Notes are your link to HP for a continuous flow of information relating to your instrument. No matter whether you repair the instrument yourself or rely on Hewlett-Packard service, Service Notes will help you keep your instrument up-to-date as follows:

- Service Notes recommend modifications to the hardware to increase reliability, improve performance, or extend the usefulness of an instrument.

- Service Notes can be used to inform you of a revised adjustment procedure or give you additional troubleshooting information.

- Safety Service Notes are used to communicate a potentially hazardous condition related to the use of an instrument.

Now, all of these Service Notes are listed in instrument model number order with a brief description of each note. The index is available free of charge by returning the order form on page 11. If desired, the index can also be ordered on microfiche. Once you have the index you can then determine which Service Notes are appropriate to order for your particular HP instruments.

# supplement to

## BENCH BRIEFS

### SERVICE NOTE INDEX

#### GENERAL

M-56A for 13XX CRT display, all prefixes. Contrast filter cross reference.

M57-S. Elimination of potential safety hazards for Santa Rosa Division Spectrum Analyzers, Network Analyzers, and Sweep Oscillators.

#### 141B/T OSCILLOSCOPES

141B-7. Serials 972 and below. Modification Kit 5061-0855 for improved storage CRT's.

141T-8. Serials 972 and below. Modification Kit 5061-0855 for improved storage CRT's.

#### 143A/S OSCILLOSCOPE

143A-4. Serials 1150A and below. Modification Kit 5061-0853 for improved CRT's.

143S-2. Serials 0967A and below. Modification Kit 5061-0853 for improved CRT's.

#### 204C/D OPTION 002, 204C—H20 OSCILLATOR

204C/D-3. Serials 204C, 204C—H20, 1715A-18215 and below; 204D, 1105A05486 and below. Modification to accept new type batteries. (Option 002 only.)

#### 236A TELEPHONE TEST OSCILLATOR

236A-3. Serials 1107A06375 and below. Improved pins on the A-1 board.

#### 310A WAVE ANALYZER

310A-10. Serials 1507A03720 and below. Replacement of germanium transistors.

#### 331A/332A DISTORTION ANALYZERS

331A/332A-U-10A-S. Serials below 1440U-00696 (331A); and 1448U00346 (332A). Elimination of a potential safety hazard.

331A/332A-10B-S. Serials below 1149A07206 (331A); and 1140A06311 (332A). Elimination of a potential safety hazard.

331A/332A-12/333A/334A-12.

Serial Numbers:

331A 1149A07845 and below.

1151U00495 and below.

332A 1145A23290 and below.

1551U00480 and below.

333A 1137A03610 and below.

1551U00950 and below.

334A 1140A07160 and below.

1551U01430 and below.

Modification to improve performance.

#### 333A/334A DISTORTION ANALYZERS

333A/334A-U-11. Serials 333A, 1726U-00961 and below; 334A, 1425U-01461 and below. Modification to eliminate the need to match beta's of transistors.

#### 1300A DISPLAY

1300A-12. Serials 1151A and below. Modification Kit 5061-0853 for improved CRT's.

1300A-13. All serials. Required modification if high-voltage oscillator is replaced.

#### 1308A MONITOR

1308A-12. Serials 0967A and below. Modification Kit 5061-0853 for improved CRT's.

1308A-13. All serials. Required modification if high-voltage oscillator is replaced. Supercedes 1308A-10.

#### 1309A MONITOR

1309A-12. Serials 0958A and below. Modification Kit 5061-0853 for improved CRT's.

1309A-13. All serials. Required modification if high-voltage oscillator is replaced. Supercedes 1309A-10.

#### 1600A LOGIC STATE ANALYZER

1600A-1. Serials 1631A03015 and below. Modification to eliminate a defocused display.

1600A-2. Serial prefix 1631A. Preferred replacement for A8U4.

#### 1611A LOGIC STATE ANALYZER

1611A-1. Serials 1635A00506 and below. Modification of A3U6 (1820-1796) to improve reliability.

1611A-2. Serials 1723A00565 and below. Modification to prevent bottom cover from shorting power supply.

1611A-3. Serials 1635A and below. Fuse change to prevent +5 volt supply fuse failure.

1611A-4. Serials 1723A00590 and below. Power supply current limit modification.

#### 1702A OSCILLOSCOPES

1702A-4. Serial prefix 1232A and below. Modification Kit 5061-0862 for improved CRT's.

#### 1703A OSCILLOSCOPES

1703A-8. Serials 1232A and below. Modification Kit 5061-0862 for improved CRT's.

#### 1707B OSCILLOSCOPE

1707B-6A. Handle replacement kit.

#### 1740A OSCILLOSCOPE

1740A-11B. Serials 1616A-01725 and below. Modification to prevent short sweep.

1740A-13. All serials. Modification to prevent vertical oscillations during turn-on.

#### 1741A OSCILLOSCOPE

1741A-4. All serials. Modification to prevent vertical oscillations during turn-on.

#### 3320A/B FREQUENCY SYNTHESIZER

3320A/B-6. 3320A serials — none; 3320B serials — 1319A01150 and below. Controller ROM change.

#### 3320C LEVEL GENERATOR

3320C-4. Serials 1314A00176 and below. Controller ROM change.

#### 3400A RMS VOLTMETER

3400A-10. Serials 1218A21280 and below. Series regulator transistor replacement.

#### 3455A DIGITAL VOLTMETER

3455A-1. All serials. "Bus Programming Tidbits."

3455A-2. Component changes to improve instrument utility and AC accuracy.

3455A-3. All serials. Modification to improve stability of zero detect amplifier.

3455A-4. All serials. How to improve air capacitor reliability.

#### 3465A MULTIMETER

3465A-3B. Serials below 1546A01501. Replacement of A1R75.

#### 3550A/B TEST SET

3550A/B-2. 3550A serials — all; 3550B serials — 829 and below. Replacement case power cord compatibility.

#### 3551A TRANSMISSION TEST SET

3551A-5A. All serials. Replacement part numbers for LED displays.

3551A-6. Serials 1550A02475 and below. Power supply fuse change.

3551A-7. Serials 1550A01705 and below. Power supply assembly and power transformer change.

3551A-8. Option H10 only, serials 1550A02525 and below. Linear amplifier changes.

3551A-9. Serials 1550A02575 and below. A3 Input Amplifier Assembly, Front Panel, and Front Subpanel replacement.

#### 3552A TRANSMISSION TEST SET

3552A-5. Serials 1604A00260 and below. Power Supply Assembly and Power Transformer change.

#### 3555B TRANSMISSION AND NOISE MEASURING SET

3555B-2. All serials. Series regulator capacitors and transistor change.

#### 3722A NOISE GENERATOR

3722A-8. Serials 1523U and below. Recommended parts replacement for the A2 3MHz Oscillator.

3722A-9. Serials 1523U and below. Modification to prevent high speed decade malfunction.

#### 3745A/B SELECTIVE LEVEL MEASURING SET

3745A/B-4A. Serials 1607U and below. HP-IB system operational errors and control hang-ups.

3745A/B-10. Serials below 1715U. Reduction of 10 MHz and 20 MHz spurious signals when using the 15580A Active Probe Accessory.

3745A/B-11A. Serials below 1720U. Modification to prevent loss of keyboard/HP-IB control due to power line transients & excessive SCR dissipation during +5.2V overvoltage faults.

3745A/B-12. Serials below 1720U. Preferred replacement of cord-wrap feet.

#### 3761A ERROR DETECTOR

3761A-6A. Serials below 1707U-00306. Modification to obtain the clock and data phasing lamp on with a 150MB/S NRZ Data Input.

#### 3770A AMPLITUDE/DELAY DISTORTION ANALYSER

3770A-2B. Serials below U-00451. Modification to improve receiver frequency display stability.

3770A-34. All serials. A39 Assembly replacement.

#### 3770B TELEPHONE LINE ANALYSER

3770B-10. All serials. A39 Assembly replacement.

3770B-11. All serials. A13 Assembly replacement.

3770B-12. Serials below U-00191. Modification to improve receiver frequency display stability.

#### 3780A PATTERN GENERATOR/ ERROR DETECTOR

3780A-13. All serials. Modification to prevent spurious printing when the 3780A is used with HP models 5050B, 5055A and 5150A printers.

#### 3964A INSTRUMENTATION TAPE RECORDER

3964A-9/8864A-9. All serials. Operator information.

3964A-10. Serials 1714A00316 through 1714A-00323. Signal to noise improvement.

#### 3968A INSTRUMENTATION TAPE RECORDER

3968A-10/8868A-10. All serials. Operator information.

#### 5045A DIGITAL IC TESTER

5045A-2. All serials. Repair of and adjustments to the Print Head Assembly.

#### 5300A COUNTER

5300A-1001. Serials 1724U-05380 and below. Recommended replacement for zener diode.



**5300B COUNTER**

5300B-1000. Serials 1707U-02600 and below. Recommended replacement for zener diode.

**5328A UNIVERSAL FREQUENCY COUNTER**

5328A-U-4. Serials 1706U-00190 and below. Modification to prevent spurious oscillation in arm lines.

**5340A FREQUENCY COUNTER**

5340-2. Serials 1320A-00450 and below. Stiffening bracket to improve chassis vibration stability.

5340A-3. All serials. Option 003 remote programming troubleshooting and check out aide.

**5345A ELECTRONIC COUNTER**

5345A-5. All serials. Air filter removal.  
5345A-6. A9 Maingate Assembly troubleshooting procedure.

5345A-7. A11 Scaler Assembly trouble shooting procedure.

5345A-8. A10 Gate Control Assembly troubleshooting procedure.

**5360A COMPUTING COUNTER**

5360A-9. All serials. New thermal switch.

**5441A DISPLAY**

5420A-1. Serials 1652 and below. Modification to improve performance. Front Panel board HP P/N 05441-60060.

5420A-2. Serials 1644 and below. Keyboard interface problem (05441-60200 or 05441-60210).

**5443A KEYBOARD CONTROLLER**

5420A-3. Serials 1644 and below. Keyboard interface problem.

**7221A GRAPHICS PLOTTER**

7221A-1-S/9872A-5-S. Serials below 1734. Elimination of a potential safety hazard.

**8016A WORD GENERATOR**

8016A-G2. Modification to improve remote programming operation.

**8406A COMB GENERATOR**

8406A-1-S. Serials 1711A01585 and below. Elimination of a potential safety hazard.

**8505A NETWORK ANALYZER**

8505A-9. Serials 1710A00350 and below. Modification to prevent erroneous data taken by HP-IB at turn on.

**8557A SPECTRUM ANALYZER**

8557A-1. Serials 1652A and below. Modification for use with 8750A Storage-Normalizer.

**8558B SPECTRUM ANALYZER**

8558B-11. Serials 1652A and below. Modification for use with 8750A Storage-Normalizer.

**8660A SYNTHESIZED SIGNAL GENERATOR**

8660A-16C. All serials. Internal crystal oscillator installation.

**8660C SYNTHESIZED SIGNAL GENERATOR**

8660C-5A. All serials. Internal Crystal Oscillator installation.

**8864A INSTRUMENTATION TAPE RECORDER**

3964A-9/8864A-9. All serials. Operator information.

**8868A INSTRUMENTATION TAPE RECORDER**

3968A-10/8868A-10. All serials. Operator information.

**9872A GRAPHICS PLOTTER**

9872A-3-S. Serials below 1719A. Elimination of a potential safety hazard.

9872A-4. Serials 1712A and below. Power supply reliability improvement.

7221A-1-S/9872A-5-S. Serials below 1734. Elimination of a potential safety hazard.

**10590A PLUG-IN ADAPTER**

10590A-1. A1 Board (10590-60001) Series 1628, Rev. A. Erroneous circuit trace.

**10631 HP-IB CABLES**

10631A/B/C/D-3. Recommended replacement parts. Supersedes 10631 A/B/C-2.

**59301A ASCII/PARALLEL CONVERTER**

59301A-2. All serials. HP-IB verification program using the 9825A. Supersedes 59301A-1.

**59303A DIGITAL TO ANALOG CONVERTER**

59303A-1. All serials. HP-IB verification program using the 9825A.

**59304A NUMERIC DISPLAY**

59304A-1. All serials. HP-IB verification program using the 9825A.

**59306A RELAY ACTUATOR**

59306A-4. All serials. HP-IB verification program using the 9825A. Supersedes 59306A-2.  
59306A-5. All serials. Programming codes ASCII A9 and B9.

59306A-6. Serials 1712A and below. Dropping out of REMOTE and unprogrammed relay state changes.

**59307A VHF SWITCH**

59307A-3. All serials. HP-IB verification program using the 9825A.

**59308A TIMING GENERATOR**

59308A-1. All serials. HP-IB verification program using the 9825A.

**59309A DIGITAL CLOCK**

59309A-3. All serials. HP-IB verification program using the 9825A.

**59403A COMMON CARRIER INTERFACE**

59403A-2. All serials below 1426A00431. Modification to tighten timing response to IFC command.

**62605L, 62605M MODULAR POWER SUPPLIES**

62605L-1/62605M-2. All serials. Replacement of switch transistors and output rectifiers.

## CUSTOMER SERVICE SEMINAR

The first seminar scheduled for 1978 is the 5061A Cesium Beam Frequency Standard located at the HP Santa Clara, CA Division. For registration please use the form on page 8 of *Bench Briefs* or contact your Hewlett Packard Sales and Service Office.

**5061A CESIUM BEAM  
FREQUENCY STANDARD  
FEB. 13-17, SANTA CLARA, CA**



COURSE CONTENT	
LECTURE	
I. General Information	
A. High Resolution Frequency Measurement	
B. 5061A Specifications	
II. Block Diagram Theory and Controls	
A. Cesium Tube Characteristics	
B. RF Circuits	
C. LF Circuits	
D. Front Panel Controls and Status Lamps	
E. Instrument Turn-On	
III. Instrument Operation	
A. C-Field/Frequency Setting	
B. Operating Routine	
IV. Cesium Beam Tube	
A. Operations	
B. Performance Verifications	
V. Circuit Alignment	
A. Procedure	
B. Circuit Alignment	
VI. Troubleshooting	
A. Procedures	
B. Troubleshooting	
VII. Subassembly Theory and Repair	
A. Discussion of each Major Circuit Assembly	
B. Troubleshooting	
VIII. Options	
A. Battery	
B. Clock	
C. Troubleshooting	
IX. Summary	
A. Review	
B. Non Field Repairable Parts	
C. Test Equipment Requirements	
LAB	
	The lecture will be given in a lab environment.
	PREREQUISITES — Familiarity with analog and digital circuits.
	PRESTUDY — None

## Protective Option

## 8558B SPECTRUM ANALYZER

The only thing worse than a burned-out input mixer in a spectrum analyzer is one that's only partially damaged. In these cases you usually can't figure out why the sensitivity is down and the amplitude inaccuracies are so high.

Here's a very economical solution to prevent future mixer burn-outs. An internal limiter listed as option 003 is now available. The limiter reduces maximum input to the mixer to +10 dBm. Flatness is increased from  $\pm 1$  dB to  $\pm 1.2$  dB.

Option 003 is available from Hewlett-Packard as part number 08558-60094 at \$100.00. Installation is relatively easy.



# READERS CORNER

## RE: A SHEEP PUZZLE

Gentlemen:

According to the way the puzzle was written, it is impossible to reach a just division of the value of the sheep. Counting the value of the penknife, which was 4 rubles, you have (-) 4 from the older brother and (+) 4 to the younger brother, which would leave the odd surplus at 2 rubles. This means that the number of sheep squared would have to end in the unit digit number 2 which does not occur in the decimal integer system.

Discounting the value of the knife, as far as the older brother is concerned, is another matter altogether. In this case, you must first have a number of sheep in the flock that would be ten or greater, since ten rubles at a time were divided. Second, the number of sheep squared must end in the unit digit 6, which is the difference between the 4 ruble value of the knife and the division increment of 10 rubles. Third, the ten-digit number in the number of sheep squared must be an odd number, since the older brother was both first and last in getting a ten-increment division. The first number, squared, meeting this criteria is 16, when squared, gives a total of 256. The older brother received 13 ten-ruble increments, or 130 rubles, and the younger brother received 12 ten-ruble increments, or 120 rubles, plus 6 rubles left over. Including the value of the knife given to the younger brother, his total was also 130 rubles.

Keep up the good work on the Bench Briefs. I especially liked the Microprocessor Buzz Words section and hope that you keep including material such as this in the Bench Briefs.

Yours truly,  
ALCOA LABORATORIES  
Joe Granger

## A SHEEP PUZZLE ANSWER

Sorry Joe, the first number we got (myself, my boss, our secretary, and 2 curious bystanders) is 14 sheep and 196 rubles — which does meet all of your criteria.

A simple way to solve it is to assign a variable to the younger brother starting with 56. It has to start at 56 because the puzzle initially stated that there were 4 divisions of 10 rubles to each brother, thus:

OB	YB
10	10
10	10
10	6
30	26 = 56

So 56 is the 1st number to try. Take the square root of it, which should equal the number of sheep. Well, they sure didn't have 7.48 sheep in the flock, so increment the younger brother's variable by 20 and try again. Why 20? If 56 doesn't work, then the division of rubles goes through another cycle of 10 to the younger brother and 10 to the older brother. 76 doesn't work either so keep adding increments of 20 until you get a number that its square root is an integer;  $196 = 14$ .

Of course, if you have an HP9825 Desk Top Computer handy, you might use that instead. For example:

- |                             |                             |
|-----------------------------|-----------------------------|
| 0: 30 → A                   | older brother (A)           |
| 1: 26 → B                   | younger brother (B)         |
| 2: A+B → C                  | total rubles (C)            |
| 3: $\sqrt{C} \rightarrow D$ | total sheep (D)             |
| 4: if D = int (D);          | check that D is an integer; |
| Prt D                       | print if yes, skip if no    |
| 5: C+20 → C                 | add 20 to total rubles      |
| 6: go to 3                  | back to step 3              |
| 7: end                      |                             |

## MICKEY MIKES?

Gentlemen:

Several years ago you published a table giving the various prefixes used in electronics, their mathematical equivalents, and the proper pronunciation. Would you please either republish it, or tell me how I can obtain another copy? I consider your table to be authoritative, and I want to cite it as such.

Thank you.

Sincerely,  
John A. Sutherland Jr., PE  
Asst. Electronics Superintendent

The April 1973 issue carried this table and description. I hope it's the one you wanted.

Editor

## METRIC MULTIPLIER PREFIXES

Here's a handy reference listing of all the multiplier prefixes currently being used. This may prove helpful when working with unfamiliar units or trying to determine conversions, such as how many nano seconds are in one micro-second. Or what is the capacitance in microfarads of a 1000 picofarad capacitor.

Of course some of us who have been around awhile will recognize the picofarad (which is  $10^{-12}$  farad) used to be called micro micro farad, and this is a good clue.

Prefix	Abbrev.	10?	Prefix	Abbrev.	10?
Tera	T	$10^{12}$	deci	d	$10^{-1}$
giga	G	$10^9$	centi	c	$10^{-2}$
mega	M	$10^6$	milli	m	$10^{-3}$
myria	ma	$10^4$	micro	$\mu$	$10^{-6}$
kilo	k	$10^3$	nano	n	$10^{-9}$
hecto	h	$10^2$	pico	p	$10^{-12}$
deca	da	$10^1$	femto	f	$10^{-15}$
(unit)	(unit)	$10^0$	atto	a	$10^{-18}$

## SERVICE NOTE AND SERVICE NOTE INDEX ORDER FORM

## INSTRUCTIONS

1. If you want service notes please check the appropriate boxes below and return this form to one of the following addresses.
2. If you want a copy of the service note index please check the appropriate box below for printed and/or microfiche copy and return this form to one of the following addresses.

For European customers (ONLY)

Hewlett-Packard  
Central Mailing Dept.  
P. O. Box 529  
Van Hueven Goedhartlaan 121  
AMSTELVEEN—1134  
Netherlands

All other customers

Hewlett-Packard  
1820 Embarcadero Road  
Palo Alto, California 94303

Name \_\_\_\_\_

Company Name \_\_\_\_\_

Address \_\_\_\_\_

City \_\_\_\_\_ State \_\_\_\_\_ Zip \_\_\_\_\_

## SERVICE NOTE INDEX

- Printed Copy  
 Microfiche (Reduction is 24x)

- |  |                                    |  |  |
|--|------------------------------------|--|--|
| <input type="checkbox"/> M56A                          | <input type="checkbox"/> 1611A-4   | <input type="checkbox"/> 3745A/B-4A        | <input type="checkbox"/> 5420A-2             |
| <input type="checkbox"/> M57-S                         | <input type="checkbox"/> 1702A-4   | <input type="checkbox"/> 3745A/B-10        | <input type="checkbox"/> 5420A-3             |
| <input type="checkbox"/> 141B-7                        | <input type="checkbox"/> 1703A-8   | <input type="checkbox"/> 3745A/B-11A       |  |
| <input type="checkbox"/> 141T-8                        | <input type="checkbox"/> 1707B-6A  |  | <input type="checkbox"/> 7221A-1-S/9872A-5-S |
| <input type="checkbox"/> 143A-4                        | <input type="checkbox"/> 1740A-11B |  | <input type="checkbox"/> 8016A-G2            |
|  |                                    | <input type="checkbox"/> 3745A/B-12        | <input type="checkbox"/> 8406A-1-S           |
| <input type="checkbox"/> 143S-2                        | <input type="checkbox"/> 1740A-13  | <input type="checkbox"/> 3761A-6A          | <input type="checkbox"/> 8505A-9             |
| <input type="checkbox"/> 204C/D-3                      | <input type="checkbox"/> 1741A-4   | <input type="checkbox"/> 3770A-2B          | <input type="checkbox"/> 8557A-1             |
| <input type="checkbox"/> 263A-3                        | <input type="checkbox"/> 3320A/B-6 | <input type="checkbox"/> 3770A-34          |  |
| <input type="checkbox"/> 310A-10                       | <input type="checkbox"/> 3320C-4   | <input type="checkbox"/> 3770B-10          | <input type="checkbox"/> 8558B-11            |
| <input type="checkbox"/> 331A/332A-U-10A-S             | <input type="checkbox"/> 3400A-10  | <input type="checkbox"/> 3770B-11          | <input type="checkbox"/> 8660A-16C           |
|  | <input type="checkbox"/> 3455A-1   | <input type="checkbox"/> 3770B-12          | <input type="checkbox"/> 8660C-5A            |
| <input type="checkbox"/> 331A/332A-10B-S               | <input type="checkbox"/> 3455A-2   | <input type="checkbox"/> 3780A-13          | <input type="checkbox"/> 9872A-3-S           |
| <input type="checkbox"/> 331A/332A-12/<br>333A/334A-12 | <input type="checkbox"/> 3455A-3   | <input type="checkbox"/> 3964A-9/8864A-9   | <input type="checkbox"/> 9872A-4             |
| <input type="checkbox"/> 333A/334A-U-11                |                                    | <input type="checkbox"/> 3964A-10          |  |
| <input type="checkbox"/> 1300A-12                      | <input type="checkbox"/> 3455A-4   | <input type="checkbox"/> 3968A-10/8868A-10 | <input type="checkbox"/> 10590A-1            |
|  | <input type="checkbox"/> 3465A-3B  | <input type="checkbox"/> 5045A-2           | <input type="checkbox"/> 10631A/B/C/D-3      |
| <input type="checkbox"/> 1300A-13                      | <input type="checkbox"/> 3550A/B-2 | <input type="checkbox"/> 5300A-1001        | <input type="checkbox"/> 59301A-2            |
| <input type="checkbox"/> 1308A-12                      | <input type="checkbox"/> 3551A-5A  | <input type="checkbox"/> 5300B-1000        | <input type="checkbox"/> 59303A-1            |
| <input type="checkbox"/> 1308A-13                      | <input type="checkbox"/> 3551A-6   | <input type="checkbox"/> 5328A-U-4         | <input type="checkbox"/> 59304A-1            |
| <input type="checkbox"/> 1309A-12                      |                                    | <input type="checkbox"/> 5340A-2           | <input type="checkbox"/> 59306A-4            |
| <input type="checkbox"/> 1309A-13                      | <input type="checkbox"/> 3551A-7   | <input type="checkbox"/> 5340A-3           | <input type="checkbox"/> 59306A-5            |
|  | <input type="checkbox"/> 3551A-8   | <input type="checkbox"/> 5345A-5           | <input type="checkbox"/> 59306A-6            |
| <input type="checkbox"/> 1600A-1                       | <input type="checkbox"/> 3551A-9   | <input type="checkbox"/> 5345A-6           | <input type="checkbox"/> 59307A-3            |
| <input type="checkbox"/> 1600A-2                       | <input type="checkbox"/> 3552A-5   | <input type="checkbox"/> 5345A-7           | <input type="checkbox"/> 59308A-1            |
| <input type="checkbox"/> 1611A-1                       | <input type="checkbox"/> 3555B-2   |  |  |
| <input type="checkbox"/> 1611A-2                       |                                    | <input type="checkbox"/> 5345A-8           | <input type="checkbox"/> 59309A-3            |
| <input type="checkbox"/> 1611A-3                       | <input type="checkbox"/> 3722A-8   | <input type="checkbox"/> 5360A-9           | <input type="checkbox"/> 59403A-2            |
|  | <input type="checkbox"/> 3722A-9   | <input type="checkbox"/> 5420A-1           | <input type="checkbox"/> 62605L-1/62605M-2   |



### U.S. SEMINAR REGISTRATION FORM

To enroll in the following seminars, fill out the registration form and mail it with your check to the address shown for the coordinator/location. Please use separate registration forms for each student. Make

your check payable to Hewlett-Packard Company in U.S. currency.

Upon receipt of your registration and check we will confirm your enrollment

by returning all necessary prestudy material along with a list of nearby motel accommodations and reservation forms. Attendees are responsible for their own transportation, accommodations, and meals.

COURSE	DATE	COST	COORDINATOR/ LOCATION
<input type="checkbox"/> 5061A	Feb. 13-17	\$450/Student	Fran Groat 5301 Stevens Creek Blvd. Santa Clara, CA 95050

Name \_\_\_\_\_

Company Name \_\_\_\_\_

Address \_\_\_\_\_

City \_\_\_\_\_ State \_\_\_\_\_ Zip \_\_\_\_\_

HEWLETT-PACKARD COMPANY  
1820 Embarcadero Road  
Palo Alto, California 94303

**BENCH BRIEFS**  
**SEPT-OCT 1977**  
Volume 17 Number 4

**Service information from  
Hewlett-Packard Company**

**To obtain a qualification form for a free  
subscription, send your request to the  
above address.**

**Reader comments or technical article  
contributions are welcomed. Please  
send them to the above address,  
attention Bench Briefs.**

**Editor: Jim Bechtold, HP Palo Alto  
California**

Address Correction Requested

Bulk Rate  
U.S. Postage  
PAID  
Sunnyvale, CA.  
Permit No.  
317

Printed in U.S.A.