



6 Bay Battery Charger Operation Manual



Sunoptic Technologies®
6018 Bowdendale Avenue
Jacksonville, FL 32216 USA

Customer Service: 904 737 7611
Toll Free 877 677 2832



RMS UK, Ltd.
28 Trinity Road
Nailsea, Somerset BS48 4NU
United Kingdom
TEL: 01275 858891

TABLE OF CONTENTS

- 1. INTENDED USE**
- 2. GENERAL WARNINGS**
- 3. BATTERY HANDLING RECOMMENDATIONS**
- 4. BATTERY CHARGING INSTRUCTIONS**
- 5. LED INDICATION**
- 6. BATTERY RECALIBRATION INSTRUCTIONS**
- 7. CLEANING INSTRUCTIONS**
- 8. STORAGE AND TRANSPORTATION CONDITION**
- 9. DISPOSAL/RECYCLE**
- 10. TROUBLESHOOTING GUIDE**
- 11. SYMBOLOGY**

1. INTENDED USE

The battery and charger are intended for use with the LED Headlight System which is intended to deliver illumination from a high intensity LED for surgical site illumination.

2. WARNINGS

- Upon initial receipt and before each use inspect each Battery and Charger for damage. Do not use any Battery if it appears to be damaged. Do not use a Battery pack that gives off an odor, generates heat, becomes discolored, or leaks. Do not use the Charger if the cord and/or plug appear to be damaged, such as cuts, bent pins or contact, and/or cracks.
- Do not expose the Battery or Charger to heat, fire, or mechanical shock. Do not heat the Battery above 80°C (176° F).
- Exposure to elevated temperatures may reduce Battery capacity and performance. Do not expose the Battery or Charger to heat sources or sunlight. Warm environments can cause the calibration to fail. Place the Charger in a cool spot, away from external heat sources.
- Do not cover the fan exhaust or obstruct the airflow. This will cause overheating.
- Do not use this equipment in the presence of a mixture containing a flammable anesthetic and/or air or oxygen or nitrous oxide.
- Do not sterilize, immerse, or expose the Battery, Charger, or Power Supply to water, solvents, lubricants, or other chemicals to clean the Charger unless otherwise directed. Do not allow water to collect in the modules or on top of the Charger. Do not allow water to enter the power connection on the back of the Charger. Keep clean and dry.
- Do not short-circuit, crush, open, shred, incinerate, or dismantle the Battery, Charger, or Power Supply case. Do not store cells or Batteries haphazardly in a box or drawer where they may short-circuit each other or be short-circuited by other metal objects. Damage increases the risk of chemical burns from electrolyte leakage, fire or explosion. The Charger does not have serviceable parts. Please contact Cuda Surgical for replacement instructions.
- Do not modify or change the Charger Power Cord. The Power Cord should be plugged into a hospital grade outlet.
- Use only the Battery, Charger, and Charger accessories in the application for which they are intended.
- Do not operate the Charger at a different voltage than what is listed on the unit and in the Instructions For Use.

3. BATTERY HANDLING RECOMMENDATIONS

- Do not remove a Battery from its original packaging until required for use.
- Observe the plus (+) and minus (-) marks on the Battery and ensure correct orientation.
- After extended periods of storage, it may be necessary to charge and discharge the Battery several times to obtain maximum performance.
- Dispose Battery and Charger per Disposal/Recycle section of this Instructions For Use.
- Rechargeable Batteries give the best performance when they are operated at normal room temperature, 20 °C ± 5 °C (68°F ±10°F).
- Retain the original product literature for future reference.

4. BATTERY CHARGING INSTRUCTIONS

NOTES:

- For optimal performance, charge the Batteries completely before initial use and after each use. Check the status window before each use to confirm the charging status (Figure 1). Each bar of the Battery status window represents approximately a 20% charge.
- LED Status window will show Battery status.
- Each charge bay operates independently and provides simultaneous charge for up to six Battery packs.

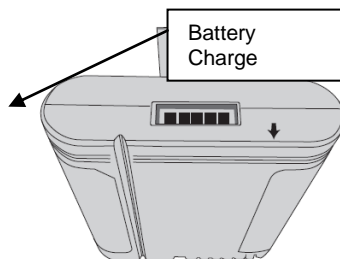

Figure 1: Battery with Full Charge

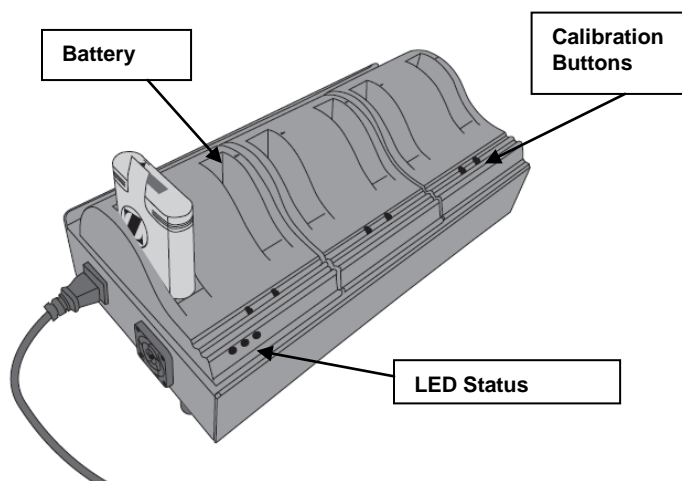

Figure 2: Battery Charger

1. Place the Charger on a flat, level surface away from sources of heat and moisture.
2. Connect the Power Supply to the mains AC supply using the cord provided.
3. Place the Battery in the Charger bay located on the Battery Charger (see Figure 2).
4. Align the arrows of the Battery and the Charger to ensure that the Battery makes contact with the Charger (see figure 3).
5. The LED status window on the Battery Charger will indicate the status of the Battery (refer to the LED indication section for details) and the Charger will automatically begin charging.
6. Remove the Battery when the Charger LED status window indicator is green solid.

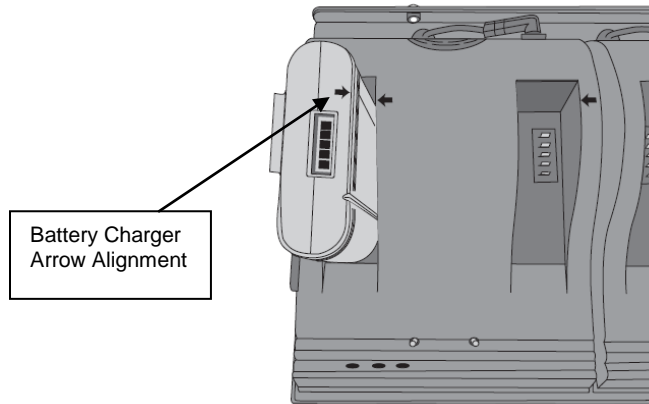

Figure 3: Battery Charger Arrow Alignment

5. LED INDICATION

NOTES: The Battery status is determined by the LEDs in the Charger status window. (Figure 2)

Green Flashing:	Battery Charging
Green Solid:	Battery Fully Charged
Blue Flashing:	Battery in calibration mode
Blue Solid:	Battery fuel gauge calibrated
Red Flashing:	Battery fuel gauge in need of recalibration
Red Solid:	Error

6. BATTERY RECALIBRATION INSTRUCTIONS

NOTES:

- During recalibration the Charger may become warm
- Calibration cycle will perform best if the Battery has a full charge in the beginning.
- Battery can either be calibrated and charged or just charged. Calibration takes longer than just charging.
- It is recommended that the recalibration button is not pressed after the calibration has started.

1. When calibration is required, the red LED will flash when the Battery is placed into the Charger bay.

NOTE: Recalibration is used to return the Battery gauge to full accuracy.

2. Press the recalibration button on the front of the Charger (see Figure 2) to begin recalibration of the Battery. If the button is not pressed the Charger will automatically charge the Battery.

3. When the blue LED flashes, the Battery is recalibrating.
4. When the calibration is completed, a solid blue LED will be present.

7. CLEANING INSTRUCTIONS

Battery Cleaning

1. Remove the Battery from the Holster.
2. Clean the exterior of the Battery with a cloth that has been dampened (not dripping) using a hospital disinfectant. Follow applicable hospital protocols during cleaning and dry immediately.

Charger Cleaning

1. Disconnect the Charger from the power source.
2. Clean the exterior of the Charger with a cloth that has been dampened (not dripping) using a hospital disinfectant. Follow applicable hospital protocols during cleaning and dry immediately.

8. STORAGE AND TRANSPORTATION CONDITION

CAUTION: For optimal Battery life the Battery packs should be stored in an environment with low humidity, free from corrosive gas at a recommended temperature <21°C. Extended exposure to temperatures above 45°C could degrade Battery life and performance.

Transport or store the Batteries and Chargers in an environment that limits exposure to dust, moisture and temperature extremes.

9. DISPOSAL/RECYCLE

Follow the hospital and/or local regulations to recycle or dispose of electrical equipment at the end of its useful life.



NOTICE: Battery Pack Disposal







The Battery is of a Lithium-Ion type. When the Battery reaches the end of its useful life, the Battery should be disposed of by a qualified recycler or hazardous materials handler. Do not mix this Battery with the solid waste stream. Contact your local recycler or hazardous material handler for recycling or disposal information.

10. TROUBLESHOOTING GUIDE

SYMPTOM	POSSIBLE CAUSES/SOLUTIONS
Battery not charging	<ul style="list-style-type: none">• Ensure Charger Power Cord is plugged in to the AC power outlet.• Ensure DC connector is plugged into the back of the Charger (for REF 00990020002, Two-bay Charger only).• Ensure Battery is properly seated in the Charger bay. Ensure arrows are aligned.• If repeated attempts to charge the Battery have failed, the Battery may be faulty. Replace the Battery.• The Charger may have a faulty Power Cord. Replace the Power Cord.
Charger LED indicator not working	<ul style="list-style-type: none">• Ensure Charger Power Cord is plugged in to the AC power outlet.• Ensure Battery is properly seated in the Charger bay. Ensure arrows are aligned.• The Charger may have a faulty Power Cord. Replace the Power Cord.
Battery LED indicator not functioning	<ul style="list-style-type: none">• Battery charge may be fully depleted. Charge the Battery pack.• Faulty Battery pack. Replace the Battery pack.
Battery does not recalibrate	<ul style="list-style-type: none">• The Battery pack may be faulty. Replace the Battery pack.• The Charger LED indicator may be faulty. Try a different Charger bay. If this is not successful, replace the Battery Charger unit.• The Charger may be faulty. Replace the Charger unit.

11. SYMBOLOGY



Graphic	What it means
---	Indicates suitability for direct current only.
	Indicates hazards arising from dangerous voltages.
	Contains a Li-ion Battery that must be recycled. The presence of these materials may, if not disposed of properly, have potential adverse affects on the environment. Presence of this label on the product means it must not be disposed of in normal household waste and must be disposed of separately. To find out how to properly dispose of this product, please contact your local Zimmer Representative.
	Contains a Li-ion Battery that must be recycled.
	Contains a Li-ion Battery that must be recycled.
	This product contains one or more toxic or hazardous substances or elements. The Environmental Protection Use Period on the logo refers to the period in years which toxic or hazardous substances or elements contained in the product will not leak or mutate under normal operating conditions.
	Certifies that the electromagnetic interference from the device is under limits approved by the Federal Communications Commission.
	Recycle Li-Ion Battery. To find out how to properly dispose the Battery, please call the phone number mentioned in the logo.