



www.regency-fire.com

**ULTIMATE U38 Freestanding Gas Stove**

**Owners & Installation Manual**



MODELS: U38-NG1 Natural Gas U38-LP1 Propane

**WARNING:**

If the information in these instructions are not followed exactly, a fire or explosion may result causing property damage, personal injury or loss of life.

**FOR YOUR SAFETY**

Do not store or use gasoline or other flammable vapors and liquids in the vicinity of this or any other appliance.

Installation and service must be performed by a qualified installer, service agency or the gas supplier.

**FOR YOUR SAFETY**

**What to do if you smell gas:**

- Do not try to light any appliance
- Do not touch any electrical switch: do not use any phone in your building.
- Immediately call your gas supplier from a neighbour's phone. Follow the gas supplier's instructions.
- If you cannot reach your gas supplier, call the fire department.

Tested by:



*Installer:* Please complete the details on the back cover and leave this manual with the homeowner.

*Homeowner:* Please keep these instructions for future reference.

**To the New Owner:**

Congratulations! You are the owner of a state-of-the-art ULTIMATE Gas Stove by FIREPLACE PRODUCTS INTERNATIONAL LTD. The Regency® Gas Series of hand crafted appliances has been designed to provide you with all the warmth and charm of a woodstove, at the flick of a switch. The models U38-NG1, and U38-LP1 of this series has been approved by Warnock Hersey for both safety and efficiency. As it also bears our own mark, it promises to provide you with economy, comfort and security for many trouble free years to follow. Please take a moment now to acquaint yourself with these instructions and the many features of your Regency® Gas Stove.

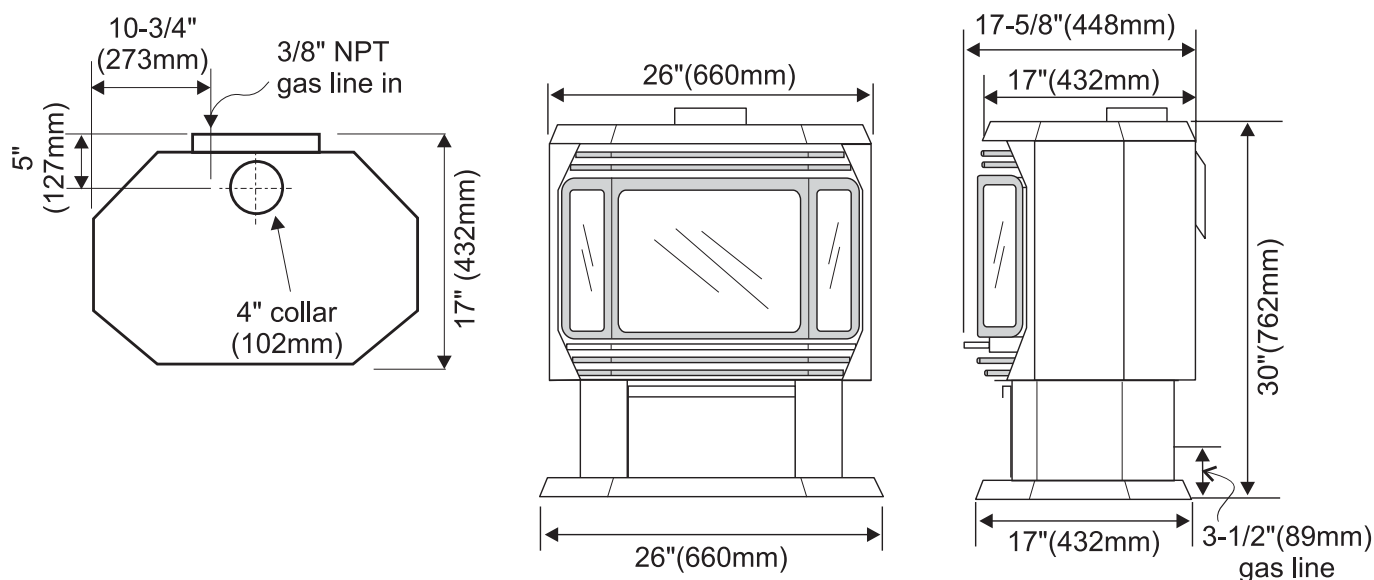

U38-NG1 & U38-LP1

 <p><b>NATIONAL FIREPLACE INSTITUTE</b> <b>CERTIFIED</b> www.nficertified.org</p>	<p>We recommend that our products be installed and serviced by professionals who are certified in the U.S. by the National Fireplace Institute® (NFI) or in Canada by Wood Energy Technical Training (WETT).</p>	 <p><b>Wood Energy Technical Training</b> www.wettinc.ca</p>
--	--	---

# TABLE OF CONTENTS

## SAFETY LABEL

Serial No. Decal .....	4
------------------------	---

## REQUIREMENTS

MA Code - CO Detector (for state of Massachusetts only) .....	5
--	---

## INSTALLATION

Before You Start .....	6
Important Message .....	6
General Safety Information .....	6
Installation Checklist.....	6
Clearances to Combustibles .....	7
Optional Outside Air .....	7
Venting .....	8
Draft Hood .....	8
High Elevation .....	8
Gas Connection.....	9
Gas Pipe Pressure Testing.....	9
Conversion kit# 731-969 for NG to LP.....	10
Conversion to Lower BTU Rating.....	13
Log Set Installation .....	13
Front Door Installation .....	15
Louver Installation .....	15
Test for Flue Spillage.....	15
Wall Thermostat .....	16
Remote Control .....	16
Final Check .....	16
Wiring Diagrams.....	17

## OPERATING INSTRUCTIONS

Operating Instructions .....	19
Lighting Instructions .....	19
Shutdown Instructions .....	19
First Fire .....	19
Automatic Convection Fan Operation .....	19
Adjusting Flame Height .....	19
Copy of the Lighting Plate Instructions .....	20
Pilot Adjustment.....	21
Aeration Adjustment .....	21
Normal Operating Sounds of Gas Appliances .....	21

## MAINTENANCE

Maintenance Instructions .....	22
Log Replacement .....	22
Door and Glass Gasket .....	22
Gold-plated Doors .....	22
Glass Replacement .....	22
Fan Maintenance.....	23
Removing Valve.....	24

## PARTS LIST

U38-1 Main Assembly .....	25
U38-1 Burner & Log Assembly .....	26
U38-1 Door Assemblies.....	27

## WARRANTY

Warranty .....	31
----------------	----

# SAFETY LABEL

This is a copy of the label that accompanies each ULTIMATE Freestanding Gas Stove. We have printed a copy of the contents here for your review. The safety label is located on the inside of the drop down pedestal door.

NOTE: Regency® units are constantly being improved. Check the label on the unit and if there is a difference, the label on the unit is the correct one.

## Copy of the Safety Label for the U38-1 Freestanding Gas Stove

	Listed: GAS FIRED VENTED ROOM HEATER Tested to: CAN/CGA 2.17-M91, ANSI Z21.88b-2003/ CSA 2.33b-2003 Certified for/Certifiée pour: CANADA and USA Report No. 476-1846-00 (Oct. 2000)		DO NOT REMOVE THIS LABEL/NE PAS ENLEVER CETTE ÉTIQUETTE 314 Serial No./No de serie																																																																																												
	<table border="1"> <tr> <td rowspan="10">                 Model/Modèle: U38-NG1             </td> <td colspan="2"> <b>FACTORY EQUIPPED FOR NATURAL GAS: Model U38-NG1</b> </td> <td> <b>ÉQUIPÉ À L'UISINE POUR GAZ NATUREL:</b> </td> </tr> <tr> <td>Minimum supply pressure</td> <td>5" WC/C.E. (1.25kPa)</td> <td>Pression d'alimentation minimum</td> </tr> <tr> <td>Manifold pressure High</td> <td>3.8" WC/C.E. (0.94kPa)</td> <td>Pression tubulure d'échappement élevée</td> </tr> <tr> <td>Manifold pressure Low</td> <td>1.1" WC/C.E. (0.27kPa)</td> <td>Pression tubulure d'échappement basse</td> </tr> <tr> <td colspan="3">                 Model U38-NG: Factory Equipped for Altitude 0-2000 ft.             </td> </tr> <tr> <td>Orifice size</td> <td>#31 DMS</td> <td>Dimensions de l'orifice</td> </tr> <tr> <td>Altitude</td> <td>0-2000 ft/pi (0-610)</td> <td>L'altitude</td> </tr> <tr> <td>Maximum Input</td> <td>40,000 Btu/h (11.73Kwh)</td> <td>Débit calorifique maximum selon</td> </tr> <tr> <td>Minimum Input</td> <td>21,000 Btu/h (6.15Kwh)</td> <td>Débit calorifique minimum selon</td> </tr> <tr> <td colspan="3">                 Model U38-NG: Convertible for Altitude 2000-4500 ft.             </td> </tr> <tr> <td>Orifice size</td> <td>#33 DMS</td> <td>Dimensions de l'orifice</td> </tr> <tr> <td>Altitude</td> <td>2000-4500ft/pi (610-1370m)</td> <td>L'altitude</td> </tr> <tr> <td>Maximum Input</td> <td>36,000 Btu/h (10.55Kw)</td> <td>Débit calorifique maximum selon</td> </tr> <tr> <td>Minimum Input</td> <td>19,000 Btu/h (5.57Kwh)</td> <td>Débit calorifique minimum selon</td> </tr> <tr> <td colspan="3">                 Model U38-NG: Convertible to 30,000 Btu for Altitude 0-4500 ft.             </td> </tr> <tr> <td>Orifice size</td> <td>#37 DMS</td> <td>Dimensions de l'orifice</td> </tr> <tr> <td>Maximum Input</td> <td>30,000 Btu/h (8.78Kwh)</td> <td>Débit calorifique maximum selon</td> </tr> <tr> <td>Minimum Input</td> <td>15,000 Btu/h (4.39Kwh)</td> <td>Débit calorifique minimum selon</td> </tr> <tr> <td rowspan="10">                 Model/Modèle: U38-LP1             </td> <td colspan="2"> <b>FACTORY EQUIPPED FOR PROPANE GAS: Model U38-LP1</b> </td> <td> <b>EQUIPE A L'UISINE POUR GAZ PROPANE:</b> </td> </tr> <tr> <td>Minimum supply pressure</td> <td>12" WC/C.E. (3.00Kpa)</td> <td>Pression d'alimentation minimum</td> </tr> <tr> <td>Manifold pressure High</td> <td>11" WC/C.E. (2.74Kpa)</td> <td>Pression tubulure d'échappement élevée</td> </tr> <tr> <td>Manifold pressure Low</td> <td>2.9" WC/C.E. (0.72Kpa)</td> <td>Pression tubulure d'échappement basse</td> </tr> <tr> <td>Orifice size</td> <td>50 DMS</td> <td>Dimensions de l'orifice</td> </tr> <tr> <td>Altitude</td> <td>0-2,000 ft/pi (0-610m)</td> <td>L'altitude</td> </tr> <tr> <td>Maximum Input</td> <td>38,000 BTU/h (11.14Kw/h)</td> <td>Débit calorifique maximum selon</td> </tr> <tr> <td>Minimum Input</td> <td>20,000 BTU/h (5.86Kw/h)</td> <td>Débit calorifique minimum selon</td> </tr> <tr> <td colspan="3">                 Model U38-LP: Convertible to 30,000 Btu for Altitude 0-4500 ft.             </td> </tr> <tr> <td>Orifice size</td> <td>#52 DMS</td> <td>Dimensions de l'orifice</td> </tr> <tr> <td>Maximum Input</td> <td>30,000 Btu/h (8.78Kwh)</td> <td>Débit calorifique maximum selon</td> </tr> <tr> <td>Minimum Input</td> <td>15,000 Btu/h (4.39Kwh)</td> <td>Débit calorifique minimum selon</td> </tr> </table>			Model/Modèle: U38-NG1	<b>FACTORY EQUIPPED FOR NATURAL GAS: Model U38-NG1</b>		<b>ÉQUIPÉ À L'UISINE POUR GAZ NATUREL:</b>	Minimum supply pressure	5" WC/C.E. (1.25kPa)	Pression d'alimentation minimum	Manifold pressure High	3.8" WC/C.E. (0.94kPa)	Pression tubulure d'échappement élevée	Manifold pressure Low	1.1" WC/C.E. (0.27kPa)	Pression tubulure d'échappement basse	Model U38-NG: Factory Equipped for Altitude 0-2000 ft.			Orifice size	#31 DMS	Dimensions de l'orifice	Altitude	0-2000 ft/pi (0-610)	L'altitude	Maximum Input	40,000 Btu/h (11.73Kwh)	Débit calorifique maximum selon	Minimum Input	21,000 Btu/h (6.15Kwh)	Débit calorifique minimum selon	Model U38-NG: Convertible for Altitude 2000-4500 ft.			Orifice size	#33 DMS	Dimensions de l'orifice	Altitude	2000-4500ft/pi (610-1370m)	L'altitude	Maximum Input	36,000 Btu/h (10.55Kw)	Débit calorifique maximum selon	Minimum Input	19,000 Btu/h (5.57Kwh)	Débit calorifique minimum selon	Model U38-NG: Convertible to 30,000 Btu for Altitude 0-4500 ft.			Orifice size	#37 DMS	Dimensions de l'orifice	Maximum Input	30,000 Btu/h (8.78Kwh)	Débit calorifique maximum selon	Minimum Input	15,000 Btu/h (4.39Kwh)	Débit calorifique minimum selon	Model/Modèle: U38-LP1	<b>FACTORY EQUIPPED FOR PROPANE GAS: Model U38-LP1</b>		<b>EQUIPE A L'UISINE POUR GAZ PROPANE:</b>	Minimum supply pressure	12" WC/C.E. (3.00Kpa)	Pression d'alimentation minimum	Manifold pressure High	11" WC/C.E. (2.74Kpa)	Pression tubulure d'échappement élevée	Manifold pressure Low	2.9" WC/C.E. (0.72Kpa)	Pression tubulure d'échappement basse	Orifice size	50 DMS	Dimensions de l'orifice	Altitude	0-2,000 ft/pi (0-610m)	L'altitude	Maximum Input	38,000 BTU/h (11.14Kw/h)	Débit calorifique maximum selon	Minimum Input	20,000 BTU/h (5.86Kw/h)	Débit calorifique minimum selon	Model U38-LP: Convertible to 30,000 Btu for Altitude 0-4500 ft.			Orifice size	#52 DMS	Dimensions de l'orifice	Maximum Input	30,000 Btu/h (8.78Kwh)	Débit calorifique maximum selon	Minimum Input	15,000 Btu/h (4.39Kwh)	Débit calorifique minimum selon
Model/Modèle: U38-NG1	<b>FACTORY EQUIPPED FOR NATURAL GAS: Model U38-NG1</b>		<b>ÉQUIPÉ À L'UISINE POUR GAZ NATUREL:</b>																																																																																												
	Minimum supply pressure	5" WC/C.E. (1.25kPa)	Pression d'alimentation minimum																																																																																												
	Manifold pressure High	3.8" WC/C.E. (0.94kPa)	Pression tubulure d'échappement élevée																																																																																												
	Manifold pressure Low	1.1" WC/C.E. (0.27kPa)	Pression tubulure d'échappement basse																																																																																												
	Model U38-NG: Factory Equipped for Altitude 0-2000 ft.																																																																																														
	Orifice size	#31 DMS	Dimensions de l'orifice																																																																																												
	Altitude	0-2000 ft/pi (0-610)	L'altitude																																																																																												
	Maximum Input	40,000 Btu/h (11.73Kwh)	Débit calorifique maximum selon																																																																																												
	Minimum Input	21,000 Btu/h (6.15Kwh)	Débit calorifique minimum selon																																																																																												
	Model U38-NG: Convertible for Altitude 2000-4500 ft.																																																																																														
Orifice size	#33 DMS	Dimensions de l'orifice																																																																																													
Altitude	2000-4500ft/pi (610-1370m)	L'altitude																																																																																													
Maximum Input	36,000 Btu/h (10.55Kw)	Débit calorifique maximum selon																																																																																													
Minimum Input	19,000 Btu/h (5.57Kwh)	Débit calorifique minimum selon																																																																																													
Model U38-NG: Convertible to 30,000 Btu for Altitude 0-4500 ft.																																																																																															
Orifice size	#37 DMS	Dimensions de l'orifice																																																																																													
Maximum Input	30,000 Btu/h (8.78Kwh)	Débit calorifique maximum selon																																																																																													
Minimum Input	15,000 Btu/h (4.39Kwh)	Débit calorifique minimum selon																																																																																													
Model/Modèle: U38-LP1	<b>FACTORY EQUIPPED FOR PROPANE GAS: Model U38-LP1</b>		<b>EQUIPE A L'UISINE POUR GAZ PROPANE:</b>																																																																																												
	Minimum supply pressure	12" WC/C.E. (3.00Kpa)	Pression d'alimentation minimum																																																																																												
	Manifold pressure High	11" WC/C.E. (2.74Kpa)	Pression tubulure d'échappement élevée																																																																																												
	Manifold pressure Low	2.9" WC/C.E. (0.72Kpa)	Pression tubulure d'échappement basse																																																																																												
	Orifice size	50 DMS	Dimensions de l'orifice																																																																																												
	Altitude	0-2,000 ft/pi (0-610m)	L'altitude																																																																																												
	Maximum Input	38,000 BTU/h (11.14Kw/h)	Débit calorifique maximum selon																																																																																												
	Minimum Input	20,000 BTU/h (5.86Kw/h)	Débit calorifique minimum selon																																																																																												
	Model U38-LP: Convertible to 30,000 Btu for Altitude 0-4500 ft.																																																																																														
	Orifice size	#52 DMS	Dimensions de l'orifice																																																																																												
Maximum Input	30,000 Btu/h (8.78Kwh)	Débit calorifique maximum selon																																																																																													
Minimum Input	15,000 Btu/h (4.39Kwh)	Débit calorifique minimum selon																																																																																													
<b>GAS FIRED VENTED ROOM HEATER</b> This appliance must be installed in accordance with local codes, if any; if not, follow: ANSI Z223.1/CAN/CGA-B149 Electrical Supply (115 V, 1.13 A, 60 Hz) Not for use with solid fuel.		<b>POLE R GAZ RADIATEUR VENTILE</b> Cet appareil doit être installé conformément aux exigences des codes locaux, s'il n'existe aucun code local, se conformer à la norme: ANSI Z223.1 / CAN 1-B149 en vigueur. Alimentation électrique. Ne doit pas être utilisé avec un combustible solide.																																																																																													
FPI Fireplace Products International Ltd., Delta, BC, Canada		Made in CANADA / FABRIQUE AU CANADA 918-508																																																																																													

For the State of Massachusetts, installation and repair must be done by a plumber or gasfitter licensed in the Commonwealth of Massachusetts.

For the State of Massachusetts, flexible connectors shall not exceed 36 inches in length.

For the State of Massachusetts, the appliances individual manual shut-off must be a t-handle type valve.

The State of Massachusetts requires the installation of a carbon monoxide alarm in accordance with NFPA 720 and a CO alarm with battery back up in the same room where the gas appliance is installed.

---

## MA Code - CO Detector (for the State of Massachusetts only)

### 5.08: Modifications to NFPA-54, Chapter 10

(2) Revise 10.8.3 by adding the following additional requirements:

(a) For all side wall horizontally vented gas fueled equipment installed in every dwelling, building or structure used in whole or in part for residential purposes, including those owned or operated by the Commonwealth and where the side wall exhaust vent termination is less than seven (7) feet above finished grade in the area of the venting, including but not limited to decks and porches, the following requirements shall be satisfied:

1. **INSTALLATION OF CARBON MONOXIDE DETECTORS.** At the time of installation of the side wall horizontal vented gas fueled equipment, the installing plumber or gasfitter shall observe that a hard wired carbon monoxide detector with an alarm and battery back-up is installed on the floor level where the gas equipment is to be installed. In addition, the installing plumber or gasfitter shall observe that a battery operated or hard wired carbon monoxide detector with an alarm is installed on each additional level of the dwelling, building or structure served by the side wall horizontal vented gas fueled equipment. It shall be the responsibility of the property owner to secure the services of qualified licensed professionals for the installation of hard wired carbon monoxide detectors

a. In the event that the side wall horizontally vented gas fueled equipment is installed in a crawl space or an attic, the hard wired carbon monoxide detector with alarm and battery back-up may be installed on the next adjacent floor level.

b. In the event that the requirements of this subdivision can not be met at the time of completion of installation, the owner shall have a period of thirty (30) days to comply with the above requirements; provided, however, that during said thirty (30) day period, a battery operated carbon monoxide detector with an alarm shall be installed.

2. **APPROVED CARBON MONOXIDE DETECTORS.** Each carbon monoxide detector as required in accordance with the above provisions shall comply with NFPA 720 and be ANSI/UL 2034 listed and IAS certified.

3. **SIGNAGE.** A metal or plastic identification plate shall be permanently mounted to the exterior of the building at a minimum height of eight (8) feet above grade directly in line with the exhaust vent terminal for the horizontally vented gas fueled heating appliance or equipment. The sign shall read, in print size no less than one-half (1/2) inch in size, "**GAS VENT DIRECTLY BELOW. KEEP CLEAR OF ALL OBSTRUCTIONS**".

4. **INSPECTION.** The state or local gas inspector of the side wall horizontally vented gas fueled equipment shall not approve the installation unless, upon inspection, the inspector observes carbon monoxide detectors and signage installed in accordance with the provisions of 248 CMR 5.08(2)(a)1 through 4.

(b) **EXEMPTIONS:** The following equipment is exempt from 248 CMR 5.08(2)(a)1 through 4:

1. The equipment listed in Chapter 10 entitled "Equipment Not Required To Be Vented" in the most current edition of NFPA 54 as adopted by the Board; and

2. Product Approved side wall horizontally vented gas fueled equipment installed in a room or structure separate from the dwelling, building or structure used in whole or in part for residential purposes.

(c) **MANUFACTURER REQUIREMENTS - GAS EQUIPMENT VENTING SYSTEM PROVIDED.** When the manufacturer of Product Approved side wall horizontally vented gas equipment provides a venting system design or venting system components with the equipment, the instructions provided by the manufacturer for installation of the equipment and the venting system shall include:

1. Detailed instructions for the installation of the venting system design or the venting system components; and

2. A complete parts list for the venting system design or venting system.

(d) **MANUFACTURER REQUIREMENTS - GAS EQUIPMENT VENTING SYSTEM NOT PROVIDED.** When the manufacturer of a Product Approved side wall horizontally vented gas fueled equipment does not provide the parts for venting the flue gases, but identifies "special venting systems", the following requirements shall be satisfied by the manufacturer:

1. The referenced "special venting system" instructions shall be included with the appliance or equipment installation instructions; and

2. The "special venting systems" shall be Product Approved by the Board, and the instructions for that system shall include a parts list and detailed installation instructions.

(e) A copy of all installation instructions for all Product Approved side wall horizontally vented gas fueled equipment, all venting instructions, all parts lists for venting instructions, and/or all venting design instructions shall remain with the appliance or equipment at the completion of the installation.

# INSTALLATION

## BEFORE YOU START

Safe installation and operation of this appliance requires common sense, however, we are required by the Canadian Safety Standards and ANSI Standards to make you aware of the following:

**INSTALLATION AND REPAIR SHOULD BE DONE BY A QUALIFIED SERVICE PERSON. THE APPLIANCE SHOULD BE INSPECTED BEFORE USE AND AT LEAST ANNUALLY BY A PROFESSIONAL SERVICE PERSON. MORE FREQUENT CLEANING MAY BE REQUIRED DUE TO EXCESSIVE LINT FROM CARPETING, BEDDING MATERIAL, ETC. IT IS IMPERATIVE THAT CONTROL COMPARTMENTS, BURNERS AND CIRCULATING AIR PASSAGEWAYS OF THE APPLIANCE BE KEPT CLEAN.**

**DUE TO HIGH TEMPERATURES, THE APPLIANCE SHOULD BE LOCATED OUT OF TRAFFIC AND AWAY FROM FURNITURE AND DRAPERIES.**

**WARNING: FAILURE TO INSTALL THIS APPLIANCE CORRECTLY MAY CAUSE A SERIOUS HOUSE FIRE AND WILL VOID YOUR WARRANTY.**

**CHILDREN AND ADULTS SHOULD BE ALERTED TO THE HAZARDS OF HIGH SURFACE TEMPERATURES, ESPECIALLY THE FIREPLACE GLASS, AND SHOULD STAY AWAY TO AVOID BURNS OR CLOTHING IGNITION.**

**YOUNG CHILDREN SHOULD BE CAREFULLY SUPERVISED WHEN THEY ARE IN THE SAME ROOM AS THE APPLIANCE.**

**CLOTHING OR OTHER FLAMMABLE MATERIAL SHOULD NOT BE PLACED ON OR NEAR THE APPLIANCE.**

## IMPORTANT MESSAGE SAVE THESE INSTRUCTIONS

The ULTIMATE Freestanding Gas Stove must be installed in accordance with these instructions. Carefully read all the instructions in this manual first. Consult the "authority having jurisdiction" to determine the need for a permit prior to starting the installation.

## GENERAL SAFETY INFORMATION

- 1) The appliance installation must conform with local codes or, in the absence of local codes, with the current Canadian or National Gas Codes, CAN1-B149 or ANSI-223.1 Installation Codes.
- 2) The appliance when installed, must be electrically grounded in accordance with local codes, or in the absence of local codes with the current National Electrical Code, ANSI/NFPA 70 or CSA C22.1 Canadian Electrical Code.
- 3) This appliance is Listed for bedroom installations when used with a Listed Millivolt Thermostat. Some areas may have further requirements, check local codes before installation.
- 4) This appliance is Listed for Alcove installations, maintain minimum Alcove clearances as follows, minimum ceiling height of 66", minimum width of 48" and a maximum depth of 36".
- 5) This unit is not approved for installation into a mobile home.
- 6) See general construction and assembly instructions.
- 7) This appliance must be connected to a vent and terminate to the outside of the building envelope. Never vent to another room or inside a building.
- 8) Inspect the venting system annually for blockage and any signs of deterioration.
- 9) Any safety glass removed for servicing must be replaced prior to operating the appliance.
- 10) To prevent injury, do not allow anyone who is unfamiliar with the operation to use the fireplace.
- 11) Wear gloves and safety glasses for protection while doing required maintenance.

- 12) Under no circumstances should this appliance be modified. Parts that have to be removed for servicing should be replaced prior to operating this appliance.
- 13) Installation and any repairs to this appliance should be done by a qualified service person. A professional service person should be called to inspect this appliance annually. Make it a practice to have all of your gas appliances checked annually.
- 14) Do not strike the glass door.
- 15) Under no circumstances should any solid fuels (wood, paper, cardboard, coal, etc.) be used in this appliance.
- 16) The appliance area must be kept clear and free of combustible materials, (gases and other flammable vapours and liquids).
- 17) Do not connect this gas appliance to chimney flue serving a separate solid-fuel burning appliance.
- 18) **WARNING:** Operation of this appliance when not connected to a properly installed and maintained venting system or tampering with the blocked vent shutoff system can result in carbon monoxide (CO) poisoning and possible death.
- 19) This appliance needs fresh air for safe operation and must be installed so there are provisions for adequate combustion and ventilation air.

Emissions from burning wood or gas could contain chemicals known to the State of California to cause cancer, birth defects or other reproductive harm.

## INSTALLATION CHECKLIST

- 1) Locating your appliance. Refer to the "Clearance to Combustibles" section.
- 2) If using outside air. Refer to the "Optional Outside Air" section.
- 3) Install venting. Refer to the "Venting" section.
- 4) Make gas connections. Refer to the "Gas Connection" section.  
  
Test the pilot. Must be as per diagram in the "Pilot Adjustment" section.
- 5) If necessary, convert Natural Gas to Propane (Refer to the "Conversion from Natural Gas to Propane" section), or convert to lower BTU (Refer to the "Conversion to Lower BTU Rating" section).

- 6) Test Gas Pressure. Refer to the "Gas Pipe Pressure Testing" section.
- 7) Install standard and optional features. Refer to the following sections where applicable.
  - a. Log Set Installation
  - b. Front Door Installation
  - c. Louver Installation
  - d. Wall Thermostat
  - e. Remote Control
- 8) Test for flue spillage (draft test). Refer to the "Test for Flue Spillage" section.
- 9) Final check. Refer to the "Final Check" section.

Before leaving this unit with the customer, the installer must ensure that the appliance is firing correctly and operation fully explained to customer.

**This includes:**

- 1) Clocking the appliance to ensure the correct firing rate (rate noted on label) after burning appliance for 15 minutes.
- 2) If required, adjusting the primary air to ensure that the flame does not carbon. First allow the unit to burn for 15-20 min. to stabilize.

**CAUTION:** Any alteration to the product that causes sooting or carboning or that results in damage is not the responsibility of the manufacturer.

## CLEARANCES TO COMBUSTIBLES

The clearances listed below are MINIMUM distances. Measure the clearance to both the appliance and the chimney connector. **(The farthest distance is correct if the two clearances do not coincide.)** For example, if the appliance is set as indicated in one of the figures but the connector is too close, move the stove until the correct clearance to the connector is obtained.

This unit can be installed on a solid combustible surface like a wood floor. This unit can also be installed directly on carpeting or vinyl when the bottom pedestal cover plate (provided with unit) is installed.

This appliance may be installed only with the clearances as shown in the situations pictured. Do not combine clearances from one type of installation with another in order to achieve closer clearances.

Use the minimum clearances shown in the diagrams below for installation with "B" vent.

U38-NG1 & U38-LP1 Clearances	
A Side Wall to Unit	7-1/2" / 190 mm
B Back Wall to Unit	6" / 155 mm
E Side Wall to Unit	2" / 50 mm

### U38-NG1 & U38-LP1 REFERENCE DIMENSIONS

- C Back Wall to Flue Centerline 10-3/4" / 273 mm  
 D Side Wall to Flue Centerline 20-1/2" / 520 mm  
 F Side Wall to Flue Centerline 11" / 280 mm

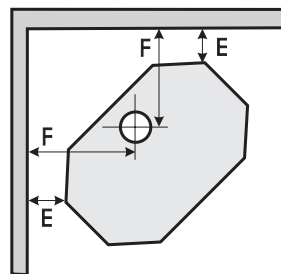
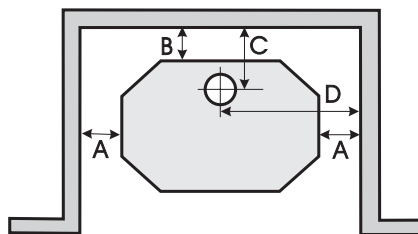

Minimum ceiling height is 36" / 914 mm from top of unit.

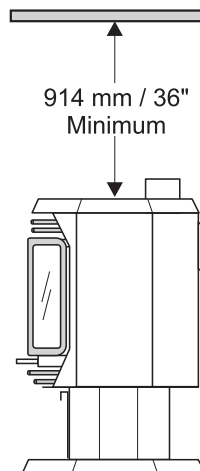

If further reduced clearances are needed, obtain requirements for construction of a protected wall from your local building authorities and their allowable reductions of the listed clearances.

## OPTIONAL OUTSIDE AIR

Outside air for combustion can be brought in either through the bottom of the pedestal or through the rear plate of the pedestal.

For both bottom and rear "outside air" the Pedestal Cover Plate must be installed. Loosen the 4 screws on the rear of the pedestal and slide the cover plate over them. Slide the plate to the left to center it and tighten down the 4 screws.

### Outside Air Through Pedestal Bottom

Once you have properly marked the position of your unit as outlined in "General Information" and "Clearances to Combustibles", cut a properly sized hole though the floor directly under your pedestal base to the outside. Pipe fresh air into the pedestal area by using appropriate metallic duct pipe with a mesh grill at the outside termination. Do not remove the knockout.

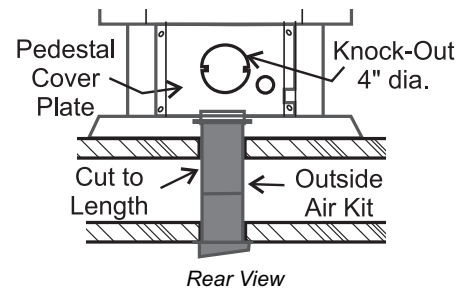

### Outside Air Through Rear of Pedestal

Remove the blanking plate from the rear of the pedestal cover plate and bend the two tabs out 90 degrees. Pipe fresh air into the pedestal area by using duct pipe with a mesh grill at the outside termination. Attach the pipe to the tabs with screws.

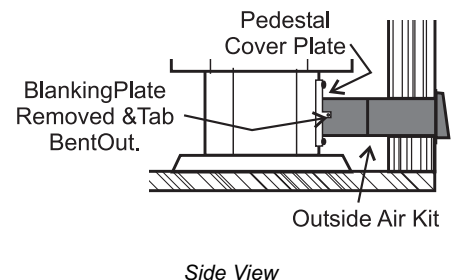

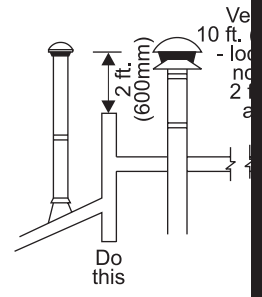

Minimum vertical distance in ft. (m) from lowest operable window

8	(2.4)
7	(2.1)
6	(1.8)
5	(1.5)
4	(1.2)
3	(0.9)
2	(0.6)

Roof pitch



## GAS CONNECTION

The gas line can be rigid pipe, or to make installation easier, use a listed flexible connector if allowed by local codes. Copper may also be used if approved by local codes.

The gas connection at the valve is 3/8" NPT. For minimum and maximum supply pressure see the System Data Table.

System Data U38-1 with 40,000 BTU		
U38-NG1: For 0 to 2000 feet altitude U38-LP1: For 0 to 4500 feet altitude		
Burner Inlet Orifice Sizes:		
	Natural Gas	Propane
Burner	#31	#50
<b>Max. Input</b>		
Natural Gas	40,000 Btu/h	
Propane	38,000 Btu/h	
<b>Min. Input</b>		
Natural Gas	22,000 Btu/h	
Propane	20,000 Btu/h	
<b>Supply Pressure</b>		
Natural Gas	min. 5" w.c.	
Propane	min. 12" w.c.	
<b>Manifold Pressure</b>		
Natural Gas	3.8"	+/- 0.2" w.c.
Propane	11"	+/- 0.2" w.c.
Electrical: 120 V. 1.13A 60Hz. Circulation: Variable speed fan, 125/75 CFM. Log Set: Ceramic fiber, 7 per set.		
System Data: HIGH ELEVATION - U38-NG1		
For 2,000 - 4,500 feet altitude		
Burner Inlet Orifice Sizes:		
	Natural Gas	Burner #33
<b>Max. Input Rating</b> 36,000 Btu/h		
<b>Min. Input Rating</b> 19,000 Btu/h		

System Data U38-1 Converted to 30,000 Btu		
For 0 to 4500 feet altitude		
Burner Inlet Orifice Sizes:		
	Natural Gas	Propane
Burner	#37	#52
<b>Max. Input</b>		
Natural Gas	30,000 Btu/h	
Propane	30,000 Btu/h	
<b>Min. Input</b>		
Natural Gas	15,000 Btu/h	
Propane	15,000 Btu/h	
<b>Supply Pressure</b>		
Natural Gas	min. 5" w.c.	
Propane	min. 12" w.c.	
<b>Manifold Pressure</b>		
Natural Gas	3.8"	+/- 0.2" w.c.
Propane	11"	+/- 0.2" w.c.
Electrical: 120 V. 1.13A 60Hz. Circulation: Variable speed fan, 125/75 CFM.		

## GAS PIPE PRESSURE TESTING

The appliance must be isolated from the gas supply piping system by closing its individual manual shut-off valve during any pressure testing of the gas supply piping system at test pressures equal to or less than 1/2 psig. (3.45 kPa). Disconnect piping from valve at pressures over 1/2 psig (14" w.c.).

The manifold pressure is controlled by a regulator built into the gas control, and should be checked at the pressure test point.

**Note:** *To properly check gas pressure, both inlet and manifold pressures should be checked using the valve pressure ports on the valve.*

- 1) Make sure the valve is in the "OFF" position.
- 2) Loosen the "IN" (# 7) and/or "OUT" (# 6) pressure tap(s), turning counterclockwise with a 1/8" wide flat screwdriver.
- 3) Attach manometer to "IN" and/or "OUT" pressure tap(s) using a 5/16" ID hose.

- 4) Light the pilot and turn the valve to "ON" position.
- 5) The pressure check should be carried out with the unit burning and the setting should be within the limits specified on the safety label.
- 6) When finished reading manometer, turn off the gas valve, disconnect the hose and tighten the screw (clockwise) with a 1/8" flat screwdriver. *Screw should be snug, but do not over tighten.*

## S.I.T. Valve Description

- 1) Gas on/off knob
- 2) Manual high/low adjustment
- 3) Pilot Adjustment
- 4) Thermocouple Connection
- 5) Main Operator
- 6) Outlet Pressure Tap
- 7) Inlet Pressure Tap
- 8) Pilot Outlet
- 9) Main Gas Outlet
- 10) Flange Securing Screw Holes
- 11) Alternative TC Connection Point
- 12) Thermoelectric Unit
- 13) Additional Valve Mounting Hole

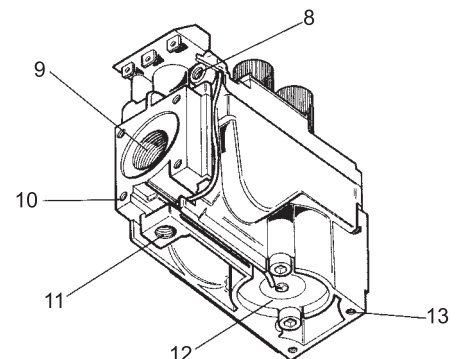
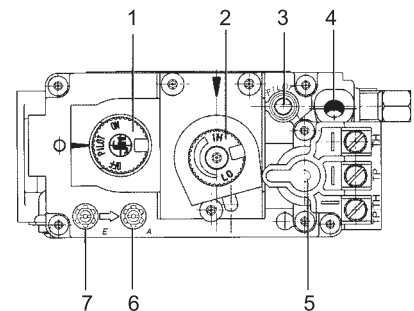

# INSTALLATION

## CONVERSION KIT# 731-969 FOR NG TO LP

**THIS CONVERSION MUST BE DONE BY A QUALIFIED GAS FITTER IF IN DOUBT DO NOT DO THIS CONVERSION !!**

### Each Kit contains one LPG Conversion Kit and one DC Sparker Kit.

#### LPG Conversion Kit Contains:

Qty.	Part #	Description
1	904-529	5/32" Allen Key
1	904-641	Burner Orifice #50
1	918-590	Label "Converted to LPG"
1	908-528	Red "LPG" label
1	910-037	LPG Injector (Pilot Orifice)
1	918-485	Instruction Sheet

#### DC Sparker Kit Contains:

Qty.	Part #	Description
1	820-475	Bracket DC Sparker
1	820-476	Bracket DC Sparker
1	904-153	Washer #8 External Star
1	904-330	Nut 8-32 Hex
1	904-438	Plug Nylon 0.750 Hole, Black
2	904-531	Bushing Split Plastic 0.500 in.
1	904-543	Screw 8-32 x 3/4 Pan Head
2	904-553	Screw #8 x 1/2 Type "B", Black Oxide
1	910-073	Spark Generator Battery Holder
1	910-074	Spark Generator Switch C/W Wire
1	910-078	Battery Size AA Energizer En91
2	910-199	Clip Wire Holder
1	910-903	Wire Fan To Power Cord, Ground 30 in.
	904-781	Velcro Hook, Black
	904-782	Velcro Hook, Black

- 3) Remove burner. See diagram below.

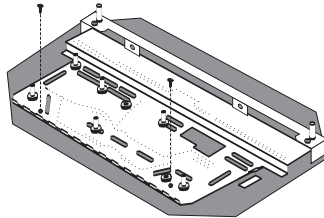

Note: Use a magnetic type screwdriver if possible.

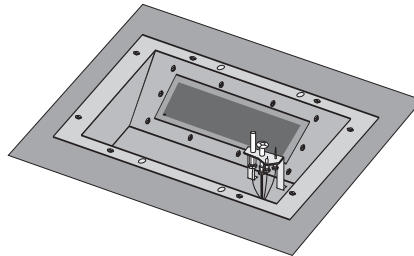

Pilot assembly is now accessible for steps 4) to 9).

- 4) Open pedestal door and remove the gold chain from door which will allow door to fall.
- 5) Remove lighting panel by removing the 6 Phillips head screws and put to the side.
- 6) Remove hi-low extension knob.
- 7) Turn control knob to the "OFF" position.
- 8) Remove the black protection cap by hand from the high-low knob (Fig.1).

- 9) Insert a 5/32" or 4mm Allen wrench into the hexagonal key-way of the screw (Fig. 2), rotate it counter-clockwise until it is free and extract it.

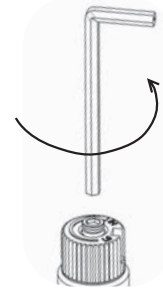

Fig.2

- 10) Check that the screw is clean and if necessary remove dirt.
- 11) Flip the screw (Fig. 3).

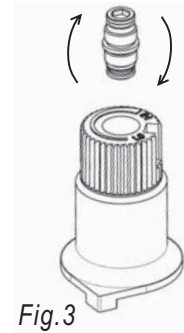

Fig.3

- 12) Using the Allen wrench as shown in Fig.4, rotate the screw clockwise until snug, do not overtighten.

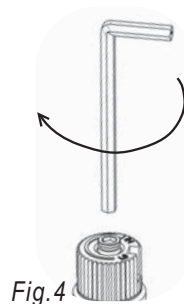

Fig.4

### Installation of LPG Conversion Kit:

- 1) Shut off the gas supply.
- 2) Open the front door and carefully remove the logs and lava rock.



Fig.1

**WARNING!**  
Do not over tighten the screw.  
Recommended to grip the  
wrench by the short side.

- 13) Verify that if the conversion is from NG to LPG, the screw must be re-assembled with the red o-ring visible (Fig. 5).

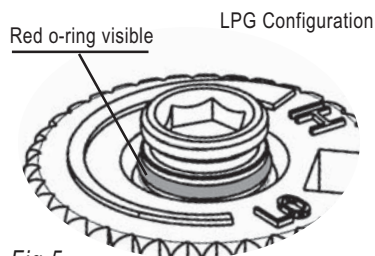

Fig. 5

- 14) Re-assemble the black protection cap (Fig. 6).

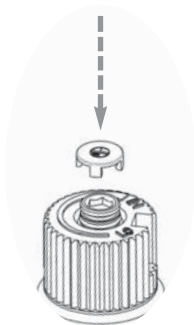
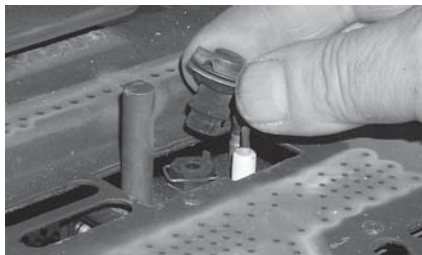

Fig. 6

**WARNING!**  
Also check that the pilot  
and main burner injectors are  
appropriate for the gas type.

- 15) Pull off the pilot cap to expose the pilot orifice.



- 16) Unscrew the pilot orifice with the allen key and replace with the LPG pilot orifice in the kit.

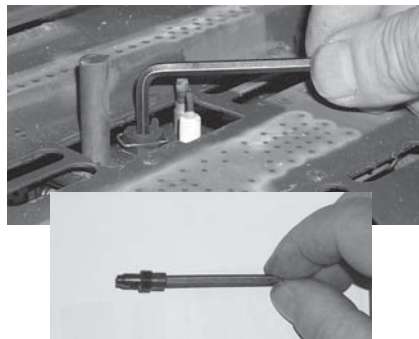

- 17) Remove burner orifice with a 1/2" wrench while using a 9/16" wrench to hold onto the elbow behind the orifice, then discard the orifice.

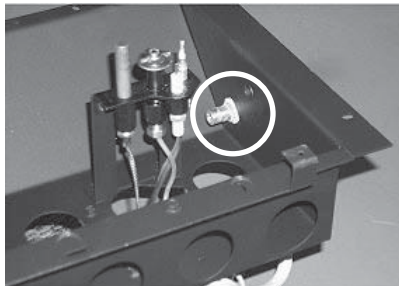

Burner Orifice

- 18) Reinstall new burner orifice LPG stamped #50 and tighten.  
19) Reverse steps 3) to 2).  
20) Attach the label "This unit has been converted to LPG" near or on top of the Serial # decal.  
21) Replace yellow "NG" label with red "LPG" label.

## Installation of the DC Sparker:

- 22) Remove the back pedestal cover by unscrewing the 4 screws.

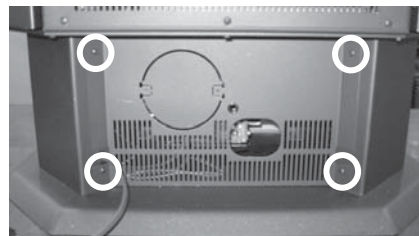

- 23) Remove the front control panel by unscrewing the 6 screws.

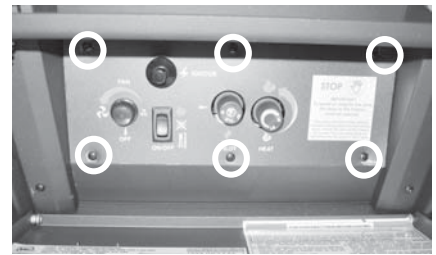

- 24) Unplug the Piezo Ignitor wire and remove Piezo Ignitor from the control panel.

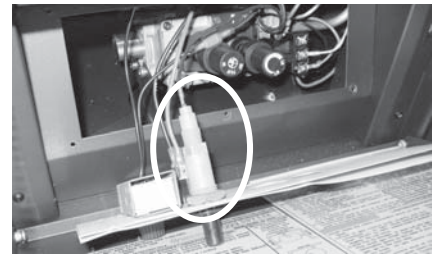

- 25) Plug up the Piezo Ignitor mounting hole with the plastic plug.



- 27) Connect the DC spark generator wires to the SIT Valve with the screw, which is provided in the kit.

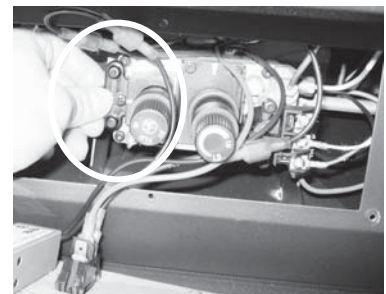

# INSTALLATION

28) Secure with screw.

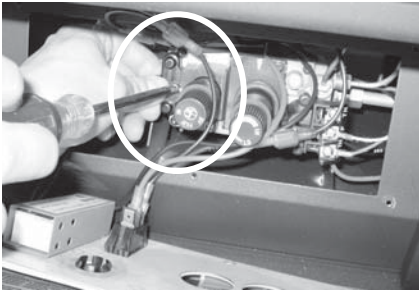

29) Reversing step 23 and secure the control panel back onto the stove pedestal with the screws.



30) Attach one end of the green ground wire to the grounding stud on the inside of the pedestal.

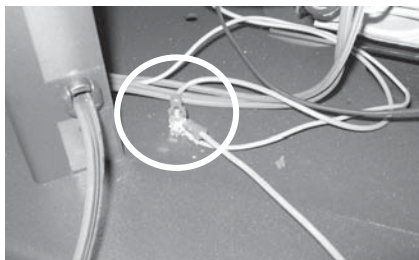

31) The Ground Wire, DC Sparker Ignition Wire and Piezo Spark Wire all go through the hole located on the pedestal back cover.

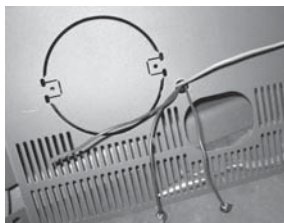

32) Put on the plastic split bushing.

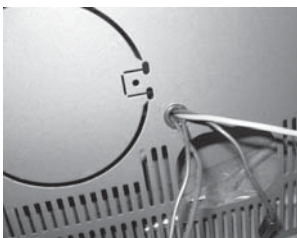

33) Attach the Piezo Ignition Wire to the back of the DC Sparker box.

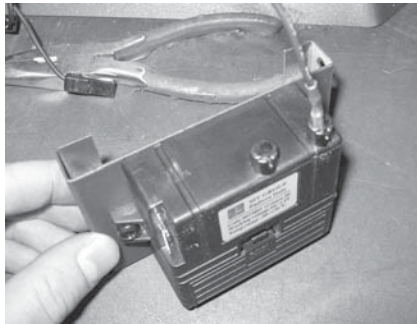

34) The ground wire and DC Sparker ignition go through the hole on the heat shield.

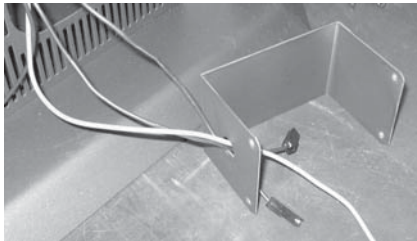

35) Apply the plastic bushing to the heat shield hole.

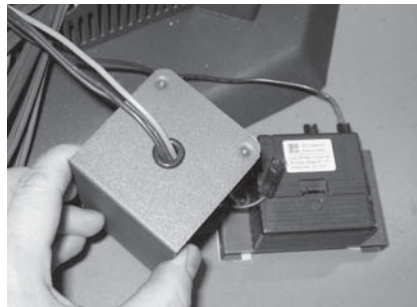

36) Connect the DC Sparker Ignition Wire to the DC Sparker.

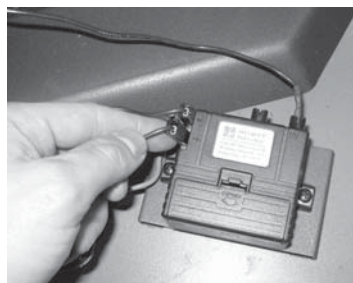

37) Attach the green ground wire.

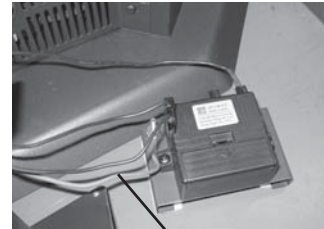

*green ground wire*

38) Install the supplied battery into the DC Sparker Box by opening the battery compartment.

**NOTE:** The battery in the DC Sparker Box will need to be replaced annually.

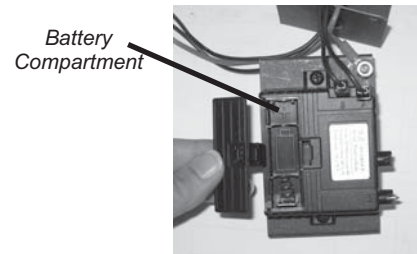

39) Place the heat shield over the DC Sparker.

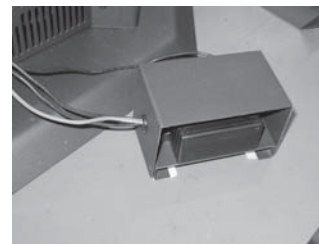

40) We recommend mounting the DC Sparker box onto the pedestal back cover.

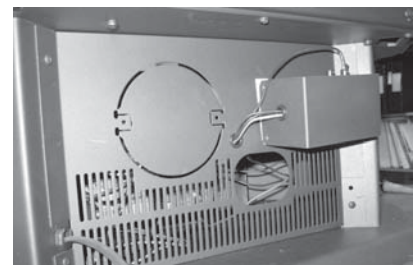

41) Check for gas leaks.

42) Check inlet and outlet pressures.

43) Check operation of flame control.

44) Check for proper flame appearance and glow on logs.

## CONVERSION TO LOWER BTU RATING

**THIS CONVERSION MUST BE DONE BY A QUALIFIED GAS FITTER  
IF IN DOUBT DO NOT DO THIS CONVERSION !!**

### Natural Gas Conversion Kit 730-920

#### Contains:

Qty.	Part #	Description
1	904-240	Burner Orifice #37 (NG)
1	918-034	Decal "Converted to 30,000 Btu"
1	918-033	Instruction Sheet

### Propane Conversion Kit 730-922

#### Contains:

Qty.	Part #	Description
1	904-390	Burner Orifice #52 (Propane)
1	918-034	Decal "Converted to 30,000 Btu"
1	918-033	Instruction Sheet



Burner Orifice

- 7) Reinstall new burner orifice (NG stamped #37 or LP stamped #52) and tighten.
- 8) Reverse steps 3) and 2).
- 9) Adjust Vent restrictor setting: To set the Vent restriction as indicated in the diagram, simply loosen the screws and push the vent restrictor plate to the correct position. Tighten the screws.

Unit	Btu/h	Restrictor Opening
U38-1	40,000	A 1-3/8" (35mm)
U38-1	30,000	B 1-1/8" (29mm)

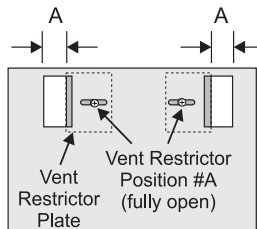

Vent Restrictor setting at High 40,000 Btu/h

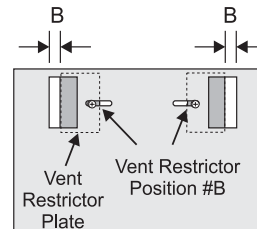

Vent Restrictor setting at Low 30,000 Btu/h

- 1) Shut off the gas supply.
- 2) Open the front door. Carefully remove the logs and lava rock.
- 3) Remove burner. See diagram below.

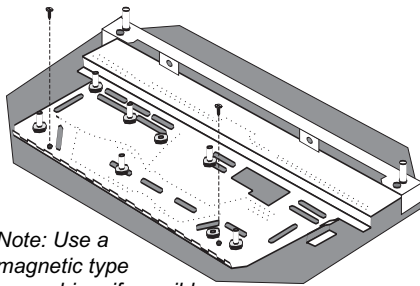

Note: Use a magnetic type screwdriver if possible.

- 4) Unscrew the 2 Rear Log Pins and move to the front hole position.
- 5) Remove Rear Log Bracket and slide the Log Bracket Restrictor between the Rear Log Bracket and the burner, secure with the 2 screws.

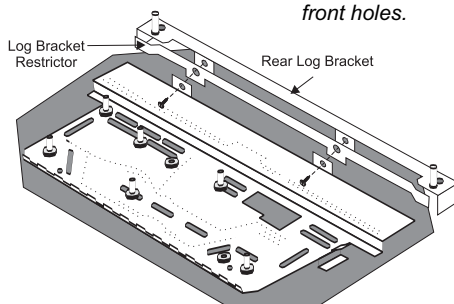
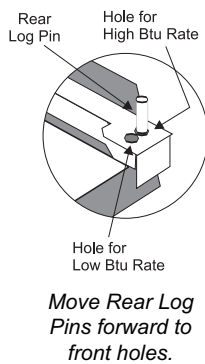

- 6) Remove burner orifice with a 1/2" wrench and discard.

- 10) Attach the label "This unit has been converted to..." on top of the Serial # decal over the higher Btu information.
- 11) Check for gas leaks.
- 12) Check inlet and outlet pressures.
- 13) Check operation of flame control. Check for proper flame appearance and glow on

## LOG SET INSTALLATION

Read the instructions below carefully and refer to the diagrams. If logs are broken do not use the unit until they are replaced. Broken logs can interfere with the pilot operation.

The gas log kit contains the following:

- |    |       |                  |         |
|----|-------|------------------|---------|
| a) | 02-65 | Rear Log         |         |
| b) | 02-56 | Middle Left Log  |         |
| c) | 02-44 | Front Left Log   |         |
| d) | 02-46 | Left Top Log     |         |
| e) | 02-45 | Front Right Log  |         |
| f) | 02-47 | Center Log       |         |
| g) | 02-48 | Middle Right Log |         |
| h) |       | Embers           | 902-151 |
| i) |       | Lava             | 902-154 |

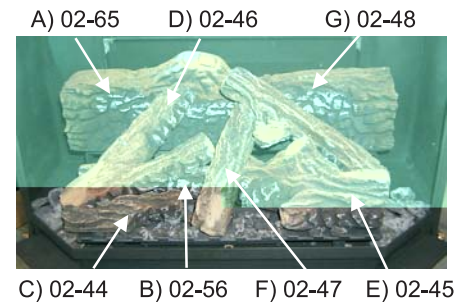

The "02" refer numbers (i.e. 02-65) are molded into the rear of each log.

- 1) Carefully remove the logs from the box and unwrap them. The logs are fragile, handle with care - do not force into position.
- 2) Sprinkle the embers on the left and right sides of the firebox base.



Embers.

Embers

# INSTALLATION

- 3) Place Rear Log A)02-65 on the two pins on the rear log support.

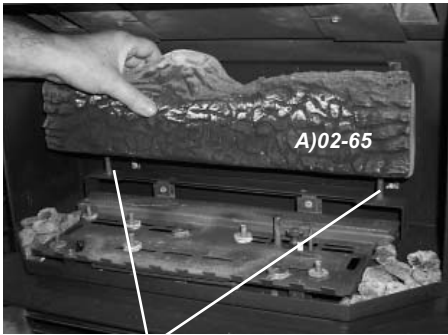

Pins on Rear Log Support

- 4) Place the Middle Left Log B)02-56 on the two pins as shown.



- 5) Sprinkle some lava rock just in front of B)02-56 on the burner holes.

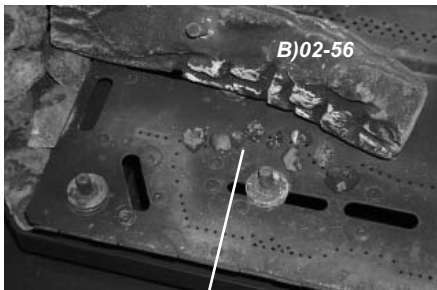

lava rock

- 6) Place Front Left Log C)02-44 onto the 2 front pins as shown.



- 7) Place the Left Top Log D)02-46 on the pin on Log B)02-56 and on top of the cutout on Log A)02-65.

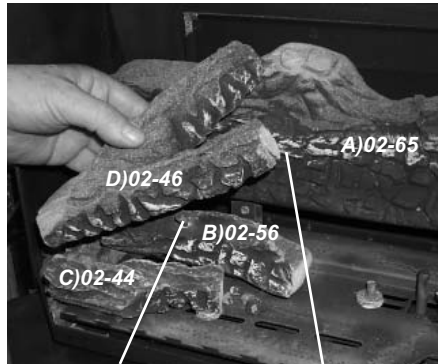

Pin

Cutout

- 8) Place Front Right Log E)02-45 on the two pins as shown.



- 9) Place the lava rock in the area between the left and right logs, leaving a space in the middle for log (F) 02-47.

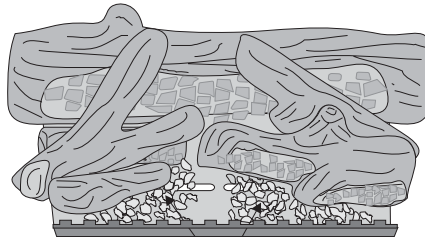

lava rocks

- 10) Place the notch in Center Log F)02-47 over Log E)02-45 and across the cutout on Log A)02-65.

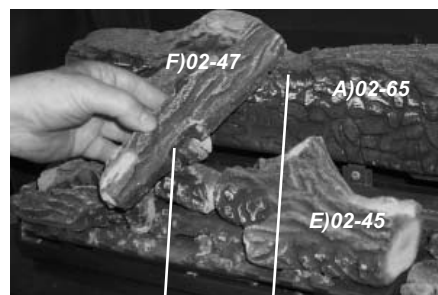

Notch

Cutout

- 11) Position notch in Front Right Log G)02-48 on Log F)02-47 and push the bottom right edge against the bracket on the burner tray.

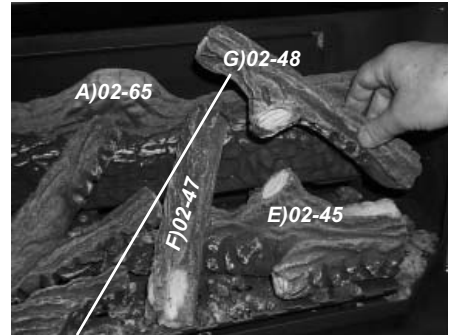

Notch

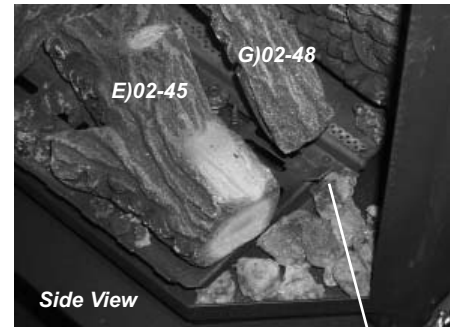

Bracket

The bottom right edge of Log G)02-48 must sit snugly against the bracket

- 12) Test fire to ensure proper light off (make sure flame flows smoothly from one end of burner to the other. If there is any flame hesitation, check that area for any blockage of the burner port.

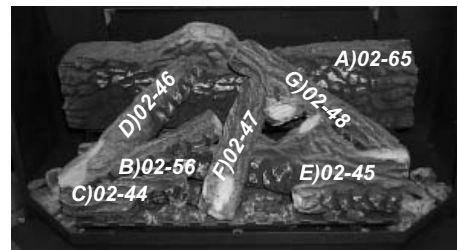

## FRONT DOOR INSTALLATION (packaged separately)

- 1) Open the two side panels.
- 2) Slide the door onto the two hinge pins making sure the two pieces are flush together. See diagram 1.

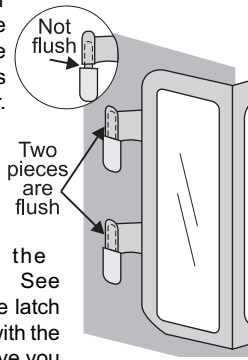

Diagram 1

- 3) Close the door. The latch plate must be centered around the alignment pin. See diagram 2. If the latch plate interferes with the corner of the stove you may want to angle the plate slightly so the door closes easier.
- 4) The latches should already be at the proper setting. If they are too hard or too easy to close, you may want to adjust them by loosening the latch catch. See diagram 3.

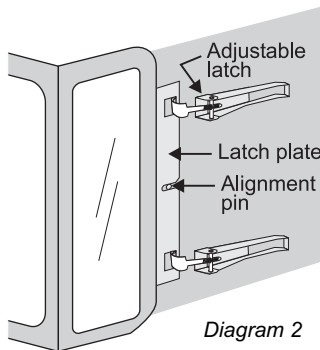

Diagram 2

- 5) Remove the blue plastic protective coating from the glass.
- 6) Test the seal around the door by placing a piece of paper between the unit and the door, close the door and try to pull the paper out. If it slips out easily, then the door is not properly sealed. Tighten or loosen the latch. See diagram 3.

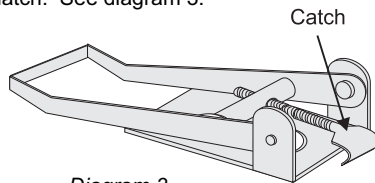
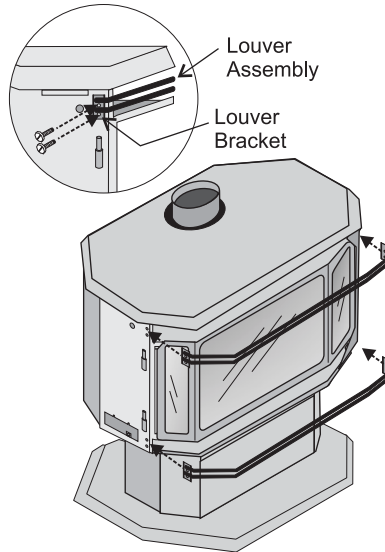

Diagram 3

**Note:** The door latch may require adjustment as the door gasket material compresses after a few fires and after glass replacement. Turn the latch catch inward or outward to loosen or tighten.

## LOUVER INSTALLATION

- 1) Attach the top & bottom louvers to the side stove panel using 2 screws per side.



The smoke should be drawn into the draft hood. If the smoke is not drawn into the draft hood, turn the unit off and check for the cause of lack of draft.

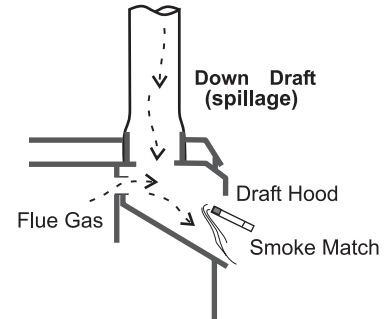

**Note:** If the flue is blocked or has a strong reverse flow, the thermally actuated safety switch mounted in the draft hood will automatically shut off the gas supply within about 10 minutes. If the heater turns off because of this during the spillage test, check for the cause of the lack of draft.

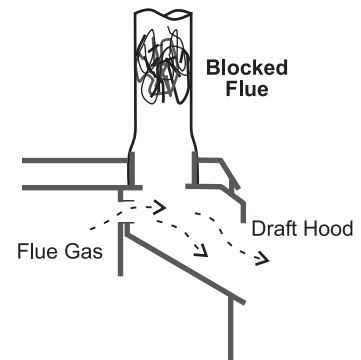

**The thermally activated safety switch must be manually reset before first startup.**

## TEST FOR FLUE SPILLAGE

A "spillage" test must be made before the installed unit is left with the customer. Follow the procedure below:

- 1) Start all exhaust fans in the home and any other gas appliances. Then close all doors and windows.
- 2) Light the unit and set controls to maximum.
- 3) After five minutes, test that there is a "pull" on the flue by placing a smoke match, cigarette or similar device which gives off smoke, on the edge of the draft hood. See diagrams.

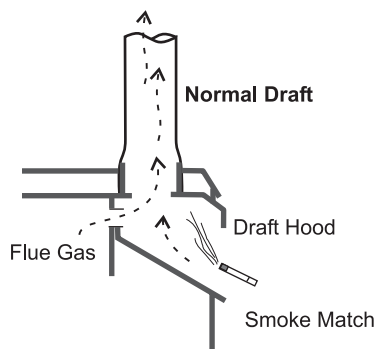

# INSTALLATION

## OPTIONAL WALL THERMOSTAT

A wall thermostat may be installed if desired. Connect the wires as per the wiring diagrams. Note that the wires are connected to the "TH" on the gas valve. Use table below to determine the maximum wire length:

**Note: Preferable if the thermostat is installed on an interior wall.**

Regency® offers an optional programmable thermostat but any 250-750 millivolt rated non-anticipator type thermostat that is CSA, ULC or UL approved may be used.

**CAUTION**  
Do not connect the millivolt wall thermostat wires to the 120V wires.

**Thermostat Wire Table**

Recommended Maximum Lead Length (Two-Wire) When Using Wall Thermostat (CP-2 System)	
Wire Size	Max. Length
14 GA.	50 Ft.
16 GA.	32 Ft.
18 GA.	20 Ft.
20 GA.	12 Ft.
22 GA.	9 Ft.

## OPTIONAL REMOTE CONTROL

Use the Regency® Remote Control Kit approved for this unit. Use of other systems may void your warranty.

The remote control kit comes with a hand held transmitter, a receiver and a wall mounting plate.

- 1) Choose a convenient location on the wall to install the receiver and the receptacle box (protection from extreme heat is very important). Run wires from the fireplace to that location, use Thermostat Wire Table.
- 2) Connect the wires as per the wiring diagram above.

**CAUTION**  
Do not connect the millivolt remote control wires to the 120V wires.

- 3) Install 3 AAA alkaline batteries in transmitter and 4 AA alkaline batteries in the receiver. Install the receiver and its cover in the wall. Switch the remote receiver to "remote" mode. The remote control is now ready for operation.

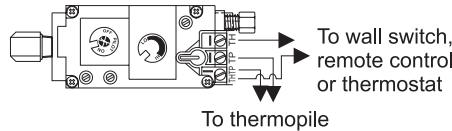

## FINAL CHECK

Before leaving this unit with the customer, the installer must ensure that the appliance is firing correctly. This includes:

- 1) Locking the appliance to ensure the correct firing rate (rate noted on label) at 15 minutes.
- 2) If required, adjusting the primary air to ensure that the flame does not carbon. First allow the unit to burn for 15 min. to stabilize.
- 3) Check for proper draft.

## CAUTION

**Any alteration to the product that causes sooting or carboning that results in damage to the exterior facia is not the responsibility of the manufacturer.**







# OPERATING INSTRUCTIONS

## OPERATING INSTRUCTIONS

Before operating this appliance, proceed through the following check list.

- 1) Read and understand these Instructions before operating this appliance.
- 2) Check to see that all wiring is correct and enclosed to prevent possible shock.
- 3) Check to ensure there are no gas leaks.
- 4) Make sure the three pieces of door glass are properly positioned. Never operate the appliance with any of the glass removed or with the door open.
- 5) Verify that all venting and the cap is unobstructed.
- 6) Verify log placement. If the pilot cannot be seen when lighting the unit - the logs or the embers have been incorrectly positioned.
- 7) The unit should never be turned off and on without a minimum of a 60 second wait.

## LIGHTING INSTRUCTIONS

**NOTE:** For all propane units and units equipped with electric spark boxes, see "Copy of Lighting Plate Instructions" section for more details.

**IMPORTANT:** The PILOT knob cannot be turned from *pilot to off* unless it is partially depressed.

**Note:** *Open the pedestal door of the unit before lighting the pilot. Once the pilot is lit, close the door. You should never operate the unit with the door open.*

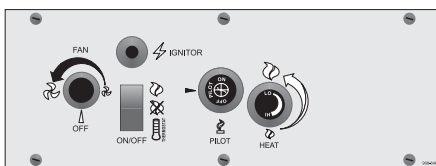

Diagram 1

- 1) If the PILOT knob is in the **off** position proceed to Step 4.

- 2) Push in PILOT knob slightly and turn clockwise to **off**. Knob cannot be turned from **pilot to off** unless knob is pushed in slightly. Do not force.
- 3) Wait five minutes to allow gas, that may have accumulated in the main burner compartment, to escape. If you smell gas, follow the instructions on the front of this manual. If you don't smell gas continue on to the next step.
- 4) Turn the PILOT knob counterclockwise to **pilot** and align it with the arrow as shown in diagram 1.
- 5) Push in PILOT knob all the way in and hold. Immediately push IGNITOR button until pilot lights. Continue to hold the PILOT knob in for approximately one minute, then release the PILOT knob. The pilot flame should continue to burn. If the pilot does not remain lit, repeat operation allowing a longer period before releasing PILOT knob.
- 6) Turn PILOT knob counter clockwise to **on**.
- 7) Use the Burner ON/OFF switch to turn on the burner.
- 8) Rotate the HEAT control to adjust the flame height **higher** or **lower**.

## SHUTDOWN INSTRUCTIONS

- 1) Use the Burner ON/OFF switch, thermostat or remote control to turn off the burner.
- 2) Push in the PILOT knob slightly and turn clockwise to off. Do not force.
- 3) Turn off all electric power to the appliance if service is to be performed.

## FIRST FIRE

The **FIRST FIRE** in your stove is part of the paint curing process. To ensure that the paint is properly cured, it is recommended that you burn your fireplace for at least four (4) hours the first time you use it with the fan on. When first operated, the unit will release an odour caused by the curing of the paint and the burn-

ing off of any oils remaining from manufacturing. Smoke detectors in the house may go off at this time. Open a few windows to ventilate the room for a couple of hours. The glass may require cleaning.

**DO NOT ATTEMPT TO CLEAN THE GLASS WHILE IT IS STILL HOT!**

**Note:** **When the glass is cold and the appliance is lit, it may cause condensation and fog the glass. This condensation is normal and will disappear in a few minutes as the glass heats up.**

**DO NOT BURN THE APPLIANCE WITHOUT THE GLASS FRONT IN PLACE.**

## AUTOMATIC CONVECTION FAN OPERATION

The fan operates automatically - turn the knob on the pedestal control panel to adjust to the desired speed. The fan will turn on as the stove comes up to operating temperature. After the unit has been turned off and cools to below a useful heat output range the fan will shut off automatically.

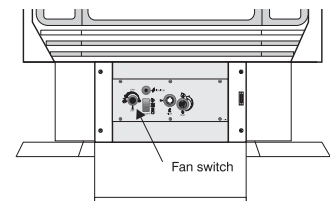

## ADJUSTING FLAME HEIGHT

Your heater has an adjustable flame to tailor the look and heat output to your specific needs. It is adjusted by turning the flame adjustment dial on the gas control valve.

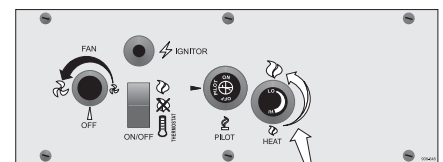

Turn clockwise to adjust the flame higher, counterclockwise for a lower flame.

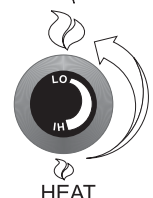

23.1/  
61)

damage,  
can cause  
assistance

some gas is heavier than

or turn the knob, don't try to  
to inspect the appliance and  
combustion and ventilation air.

**Surface temperatures  
burners away. Keep burner  
ing appliance.**

**UNITS AND  
ELECTRIC SPARK BOXES:**

and turn to "PILOT" position.  
and hold in until the pilot lights  
burn in for about 20 seconds

and turn to "ON" position.

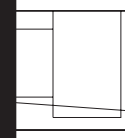

**DO NOT REMOVE THIS IN**

# OPERATING INSTRUCTIONS

## PILOT ADJUSTMENT

Periodically check the pilot flames. Correct flame pattern has three strong blue flames: 1 flowing around the thermopile and 1 around the thermocouple, and 1 flowing across the rear of the burner (it does not have to be touching the burner).

**Note:** *If you have an incorrect flame pattern, contact your Regency® dealer for further instructions.*

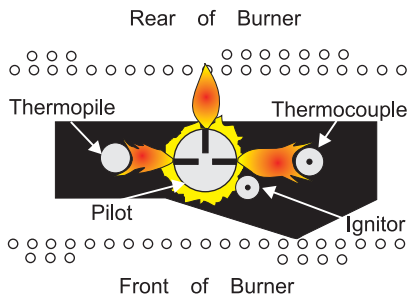

Top View of pilot flame

Incorrect flame pattern will have small, probably yellow flames, not coming into proper contact with the rear of the burner or thermopile.

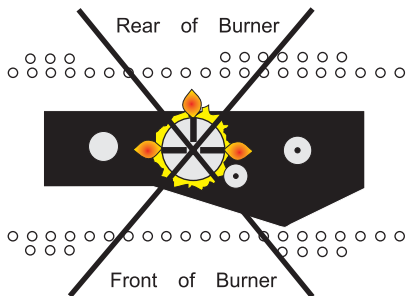

Top View of pilot flame

## AERATION ADJUSTMENT

The burner aeration is factory set but may need adjusting due to either the local gas supply or altitude.

### U38-1 with 40,000 Btu/h

U38-NG1	Natural Gas:	1/4" open
U38-LP1	Propane:	1/2" open

### U38-1 with 30,000 Btu/h

U38-NG1	Natural Gas	3/16" open
U38-LP1	Propane	3/8" open

The aeration adjustment gears are located on the right side of the burner box and can be accessed from the side or from the front when the louvers are removed.

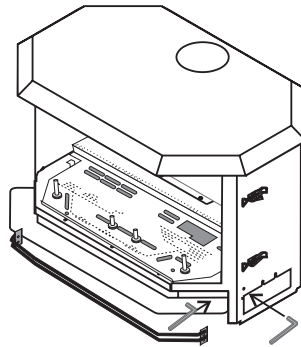

To adjust the aeration: use the allen key to turn the turning gear which will adjust the air shutter. Open the air shutter for a blue flame or close it for a yellower flame.

### Closed -Tall yellow flame Open -Short blue flame

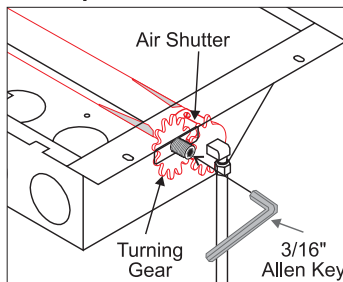

Clockwise to open,  
counter-clockwise to close.

**Caution:** Carbon will be produced if the air shutter is closed too much.

**Note:** Any damage due to carboning resulting from improperly setting the aeration controls is NOT covered under warranty.

**Note:** Aeration Adjustment should only be performed by an authorized Regency® Installer at the time of installation or service.

## NORMAL OPERATING SOUNDS OF GAS APPLIANCES

It is possible that you will hear some sounds from your gas appliance. This is perfectly normal due to the fact that there are various gauges and types of steel used within your appliance. Listed below are some examples. All are **normal operating sounds** and should not be considered as defects in your appliance.

### Blower:

Regency® gas appliances use high tech blowers to push heated air farther into the room. It is not unusual for the fan to make a "whirring" sound when ON. This sound will increase or decrease in volume depending on the speed setting of your fan speed control.

### Burner Tray:

The burner tray is positioned directly under the burner tube(s) and logs and is made of a different gauge material from the rest of the firebox and body. Therefore, the varying thicknesses of steel will expand and contract at slightly different rates which can cause "ticking" and "cracking" sounds. You should also be aware that as there are temperature changes within the unit these sounds will likely re-occur. Again, this is normal for steel fireboxes.

### Blower Thermodisc:

When this thermally activated switch turns ON it will create a small "clicking" sound. This is the switch contacts closing and is normal.

### Pilot Flame:

While the pilot flame is on it can make a very slight "whisper" sound.

### Gas Control Valve:

As the gas control valve turns ON and OFF, a dull clicking sound may be audible, this is normal operation of a gas regulator or valve.

### Unit Body/Firebox:

Different types and thicknesses of steel will expand and contract at different rates resulting in some "cracking" and "ticking" sounds will be heard throughout the cycling process.

# MAINTENANCE

## MAINTENANCE INSTRUCTIONS

- 1) Always shut the valve off before cleaning. For relighting, refer to lighting instructions. Keep the burner and control compartment clean by brushing and vacuuming at least once a year. When cleaning the logs, use a soft clean brush as the logs are fragile and easily damaged.
- 2) Clean glass (never when unit is hot), appliance, louvers, and door with a damp cloth. Never use an abrasive cleaner. The gold louvers (and optional gold door) may be scratched if abrasives are used to clean them.

The heater is finished in a heat resistant paint and should only be refinished with heat resistant paint (not with wall paint). Regency® uses StoveBright Paint - Metallic Black #6309.

- 3) Make a periodic check of burner for proper position and condition. Visually check the flame of the burner periodically, making sure the flames are steady; not lifting or floating. If there is a problem, call a qualified service person.
- 4) The appliance and venting system must be inspected before use, and at least annually, by a qualified field service person, to ensure that the flow of combustion and ventilation air is not obstructed.

During the annual service call, the burners should be removed from the burner tray and cleaned. Replace the embers - do not block the pilot or burner ports.

- 5) Keep the area near the appliance clear and free from combustible materials, gasoline and other flammable vapours and liquids.

**WARNING: CHILDREN AND ADULTS SHOULD BE ALERTED TO THE HAZARDS OF HIGH SURFACE TEMPERATURE AND SHOULD STAY AWAY TO AVOID BURNS OR CLOTHING IGNITION. YOUNG CHILDREN SHOULD BE CAREFULLY SUPERVISED WHEN THEY ARE IN THE SAME ROOM AS THE APPLIANCE.**

**CAUTION: ANY SAFETY SCREEN OR GUARD REMOVED FOR SERVICING AN APPLIANCE MUST BE REPLACED PRIOR TO OPERATING THE APPLIANCE.**

**CLOTHING OR OTHER FLAMMABLE MATERIAL SHOULD NOT BE PLACED ON OR NEAR THE APPLIANCE.**

**DO NOT USE THIS APPLIANCE IF ANY PART HAS BEEN UNDER WATER. IMMEDIATELY CALL A QUALIFIED SERVICE TECHNICIAN TO INSPECT THE APPLIANCE AND TO REPLACE ANY PART OF CONTROL SYSTEM AND ANY GAS CONTROL WHICH HAS BEEN UNDER WATER.**

- 6) Verify proper operation after servicing.

## LOG REPLACEMENT

The unit should never be used with broken logs. Turn off the gas valve and allow the unit to cool before opening door to carefully remove the logs. The pilot light generates enough heat to burn someone. If for any reason a log should need replacement, you must use the proper replacement log. The position of these logs must be as shown in the diagram under Log Installation.

**Note: Improper positioning of logs may create carbon build-up and will alter the unit's performance which is not covered under warranty.**

## DOOR AND GLASS GASKET

If the door gasket requires replacement use 7/8" diameter oval door gasket (Part #650-920). The glass requires 5/8" flat glass gasket. See your Regency® dealer.

## GOLD-PLATED DOORS

The 24 carat gold plated finish on the door requires little maintenance, and need only be cleaned with a damp cloth. DO NOT use abrasive materials or chemical cleaners, as they may harm the finish and will void the warranty. Clean any fingerprints off before turning the unit on.

## GLASS REPLACEMENT

Your Regency® stove is supplied with high temperature, 5 mm Neoceram ceramic glass that will withstand the highest heat that your unit will produce. In the event that you break your glass, purchase your replacement from an authorized Regency® dealer only, and follow the step-by-step instructions for replacement. **Never operate your unit with broken glass.**

**WARNING: Do not operate appliance with the glass front removed, cracked or broken. Replacement of the glass should be done by a licensed or qualified service person.**

### MITRED DOOR

#### Removing Glass:

**Note: Wearing gloves will protect your hands while handling glass.**

- 1) Remove the door from the unit and place on a soft surface to prevent scratching.
- 2) Pull out the door gasket.
- 3) Remove the 24 nuts holding the glass retainers in place. *Do not remove the nuts underneath the retainers.*

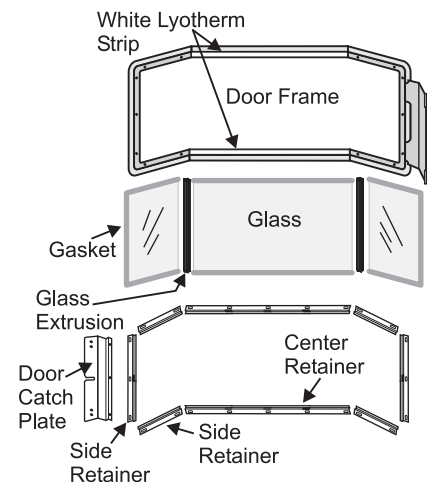

- 4) Remove the door catch plate.
- 5) Remove glass retainers on sides first (3 each side) then remove two center retainers.  
**Note: Center glass retainers are glued to center glass.**
- 6) Remove glass from extrusions. When removing center glass, leave white insulation in place.

## Installing Glass

- 1) Install both center and side glass onto extrusions as per diagram.
- 2) Place glass assembly into door frame.
- 3) Install retainers by placing 1 drop of glue where previously glued and put in place.
- 4) Install side retainers.
- 5) Install door catch plate.
- 6) Install the 24 nuts loosely, do not tighten yet.
- 7) Tighten side panels nuts using the following procedure:

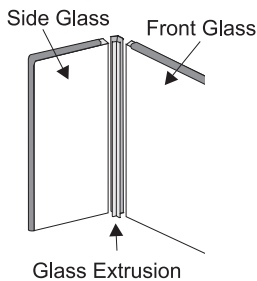

- a. tighten top & bottom outside corner nuts (2)
  - b. tighten inside nuts (3)
  - c. tighten top & bottom inside corners (2)
- 8) Tighten the 10 nuts on center glass retainer.
  - 9) Repeat step 7 for other side panel.
  - 10) Replace new gasket by gluing it in place.
  - 11) Install door onto stove and check the seal.

## PANEL DOOR

- 1) Remove the door from the unit and place on a soft surface to prevent scratching.
- 2) Pull out the door gasket.
- 3) Remove the nuts holding the glass retainers in place.
- 4) Remove the glass retainers (sides, top and bottom) and the door catch plate.
- 5) Replace the glass. **The glass must have gasketing around it.**
- 6) Reverse the previous steps, replace the retainers and fasten with the nuts but do not overtighten, as this can break the glass. Note: the door catch plate fits on top of the left side retainer.

- 7) Put gasket glue on the retainers, but do not put glue on the screws. Replace the door gasket, the two ends butt tight together on the bottom edge of the door.
- 8) Replace door on the stove and check the seal.

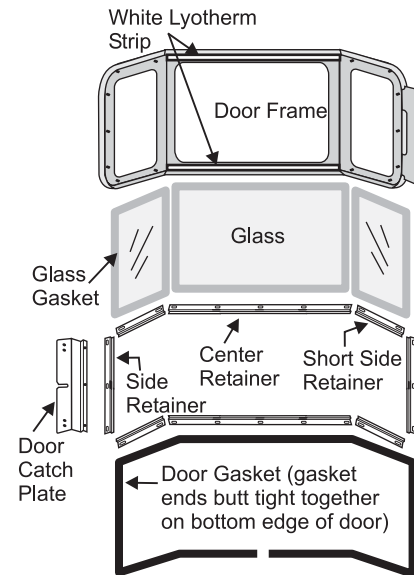

## FAN MAINTENANCE

If your fan requires maintenance or replacement, access to the fan is through the access panel on the rear wall of the firebox.

**Note:** The unit **MUST NOT** be operated without the fan access panel securely in place and correctly sealed.

**IMPORTANT:** These fans collect a lot of dust from within your home. Ensure you maintain these fan motors on a regular basis by vacuuming out the fan squirrel cages, around the motor, and around the grills on the back of the stove.

**IMPORTANT**  
**Disconnect power supply**  
**before servicing**

**WARNING: Electrical Grounding Instructions** This appliance is equipped with a three pronged (grounding) plug for your protection against shock hazard and should be plugged directly into a properly grounded three-prong receptacle. Do not cut or remove the grounding prong from this plug.

## To Remove U38-1 Fan:

- 1) Unplug or disconnect power source to stove.
- 2) Remove all logs and the rear log support, then remove the 10 screws holding the access panel in place, see Diagram 1. (Fan is also accessible by opening the right side door. See Diagram 2).
- 3) Unclip the black and white wires from the fan motor.

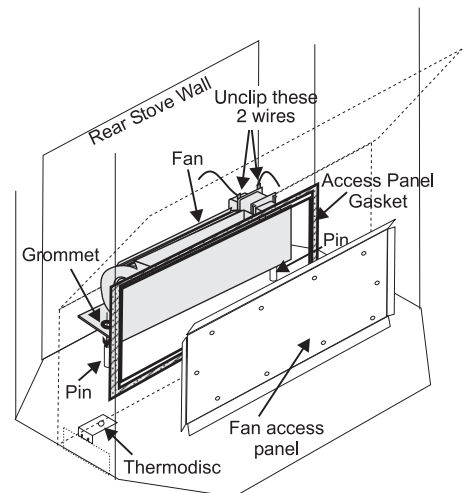

Diagram 1

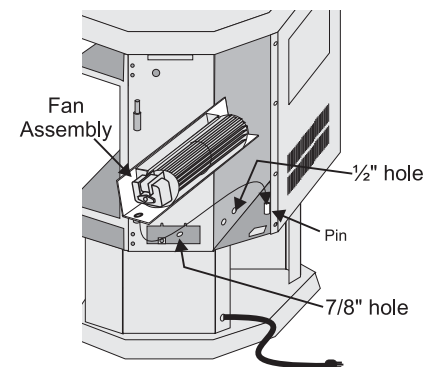

Diagram 2

- 4) Lift fan off of the 2 pins, tip back and pull through firebox opening. Disconnect the green ground wire from the left side of the fan as soon as you can reach it.

## Replacing U38-1 Fan:

Reverse the above steps (1 - 4). If necessary install a new gasket before replacing the fan access panel. Make sure the fan wires and the ground wire are reattached.



replace-

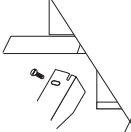
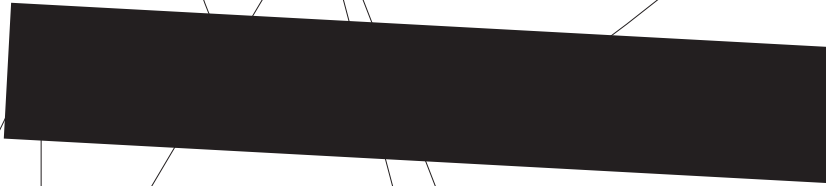

move the  
shoul

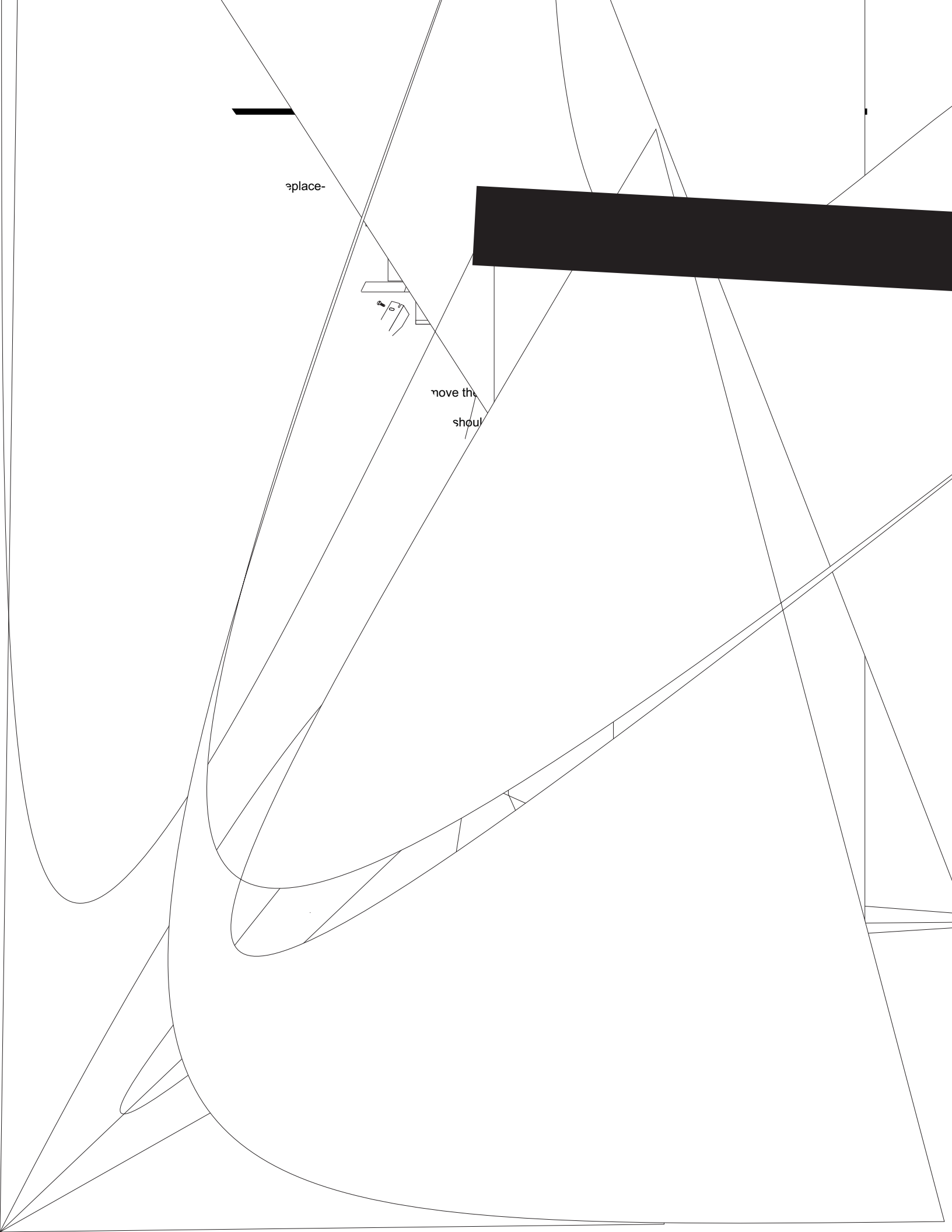



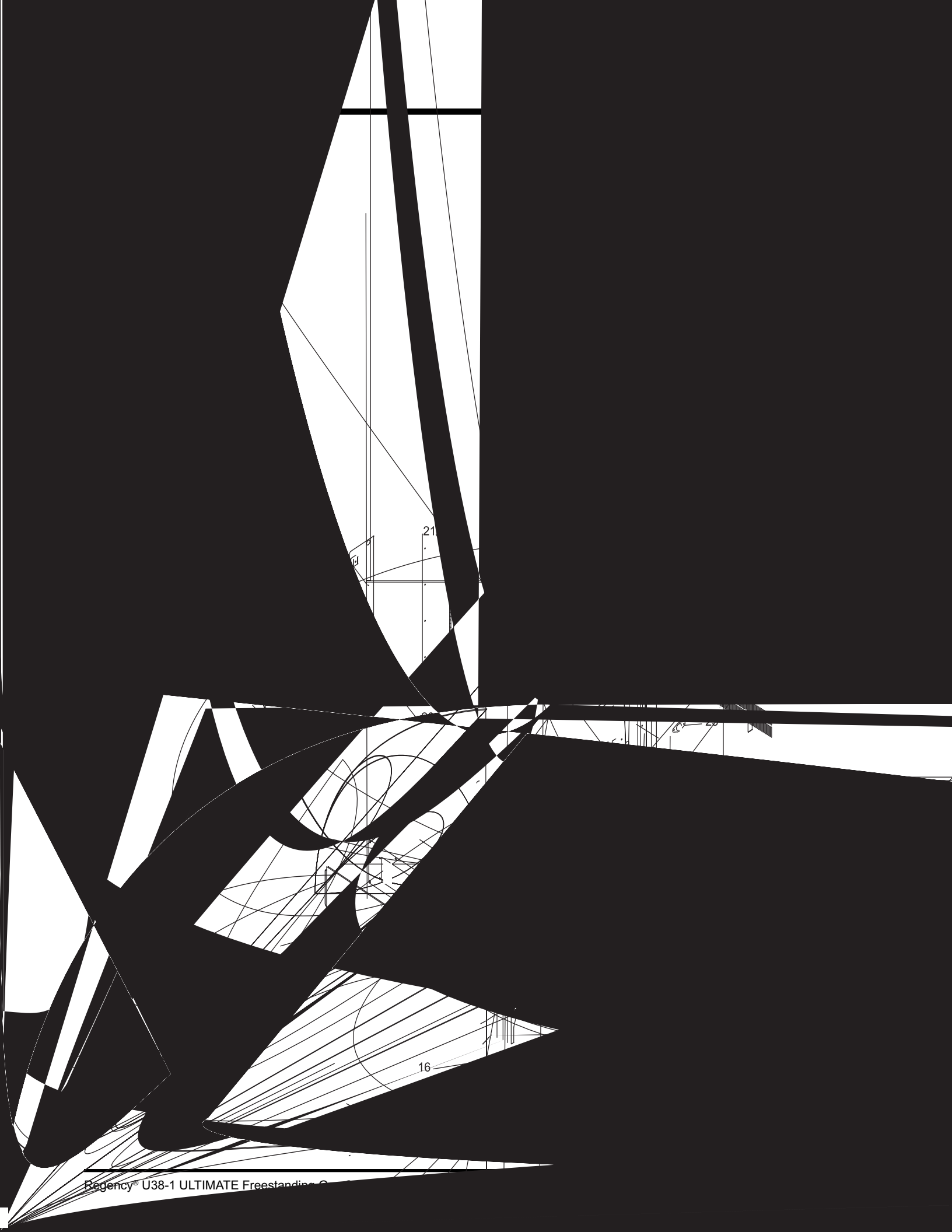

21

16

# PARTS LIST

## U38-1 BURNER & LOG ASSEMBLY

Part #	Description
51)	910-241 Burner ON/OFF Switch (3-way)
52)	910-190 Piezo Ignitor & Nut
53)	904-586 Knob - Fan Control Switch
54)	910-373 Knob - Pilot Valve Extension
55)	910-372 Flame Adjusting Knob
56)	908-646 Control Panel Decal
57)	650-220 Control Panel Plate
58)	910-330 Fan Speed Control (120 V)
	750-524/P Valve Assembly - Natural Gas
	750-526/P Valve Assembly - Propane
60)	910-478 Valve S.I.T. - Natural Gas / Propane
	904-240 #37 Orifice - N.G. (at 30,000 Btu/hr)
	904-690 #31 Orifice - N.G. (at 40,000 Btu/hr)
	904-390 #52 Orifice - Propane (at 30,000 Btu/hr)
	904-641 #50 Orifice - Propane (at 38,000 Btu/hr)
71)	730-528 Rear Log Bracket Assy
72)	910-034 Pilot Assy-S.I.T.- 3 flame - N.G.
	910-035 Pilot Assy-S.I.T.-3 flame- Propane
75)	730-935 Log Set
78)	730-550 Burner Assy - NG/LP
80)	260-565 Air Shutter Gear Assembly (Female)
81)	904-565 Hex Key 3/16" AF
84)	* Air Shutter Gear Assembly (Male)

\*Not available as a replacement part.

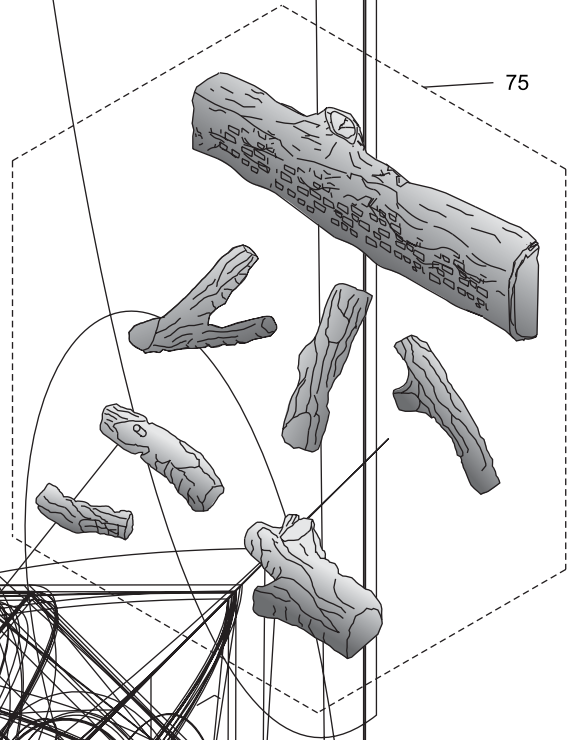

## U38-1 DOOR ASSEMBLIES

Part #	Description
730-921	Brush Nickel Mitred Door - Complete
730-924	Gold Mitred Door - Complete
730-926	Black Mitred Door - Complete
730-932	Gold Wrap Door - Complete
730-928	Gold Panel Door - Complete
101)	650-920 Door Gasket Kit
105)	* Ceramic Paper
106)	940-323/P Side Glass
107)	936-243 Glass Gasket
108)	940-322/P Centre Glass
111)	* Door Frame Fibre Paper
112)	750-015 Door Glass Extrusion
208)	940-325/P Wrap Glass

\*Not available as a replacement part.

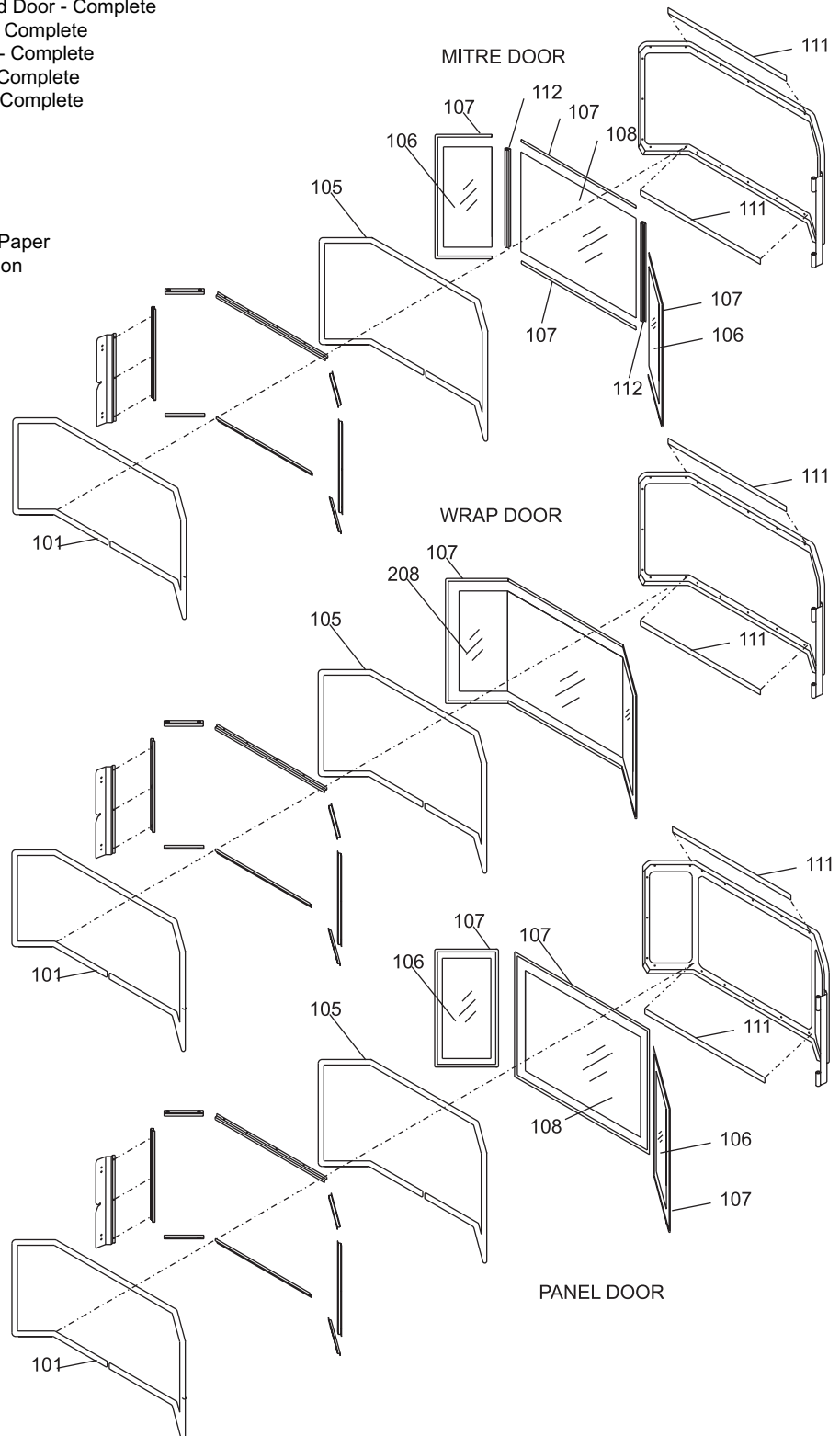

# NOTES

---

---

---

---

---

---

---

---

---

---

---

---

---

---

---

---

---

---

---

---

---

---

---







Regency® Fireplace Products are designed with reliability and simplicity in mind. In addition, our internal Quality Assurance Team carefully inspects each unit thoroughly before it leaves our facility. FPI Fireplace Products International Ltd. is pleased to extend this limited lifetime warranty to the original purchaser of a Regency® Product. This warranty is not transferable.

**The Warranty:** Limited Lifetime

The combustion chamber, heat exchanger, burner tubes/pans, logs and gold plating (against defective manufacture only) are covered under the Limited Lifetime Warranty for five (5) years for parts and subsidized labour\* and parts only thereafter.

Glass is covered for lifetime against thermal breakage only, parts and subsidized labour\* for five (5) years and parts only thereafter from date of purchase.

Special Finishes - One year on brushed nickel, louvers and doors. You can expect some changes in color as the product "ages" with constant heating and cooling. FPI warrants the product for any manufacturing defects on the original product. However, the manufacturers warranty does not cover changing colors and marks, ie. finger prints, etc applied after the purchase of the product. Damage from the use of abrasive cleaners is not covered by warranty.

Electrical and mechanical components such as blowers, switches, wiring, thermocouples, FPI remote controls, spill switches, thermopiles, thermocouples, pilot assembly components, and gas valves are covered for one year parts and subsidized labour\* from the date of purchase. Blowers and valves replaced under warranty are considered repairs and continue as if new with appliance. ie. twelve (12) months from original purchase date of appliance with a minimum of three (3) months coverage from date of replacement.

FPI venting components (Direct Vent units) are covered parts and subsidized labour\* for three (3) years from date of purchase.

Simpson Dura-Vent venting components (Direct Vent units) are covered by Simpson Dura-Vent Inc. warranty.

**Conditions:**

Any part or parts of this unit which in our judgement show evidence of such defects will be repaired or replaced at FPI's option, through an accredited distributor or agent provided that the defective part be returned to the distributor or agent **Transportation Prepaid**, if requested.

It is the general practice of FPI to charge for larger, higher priced replacement parts and issue credit once the replaced component has been returned to FPI and evaluated for manufacturer defect.

The authorized selling dealer is responsible for all in-field service work carried out on your Regency® product. FPI will not be liable for results or costs of workmanship from unauthorized service persons or dealers.

At all times FPI reserves the right to inspect product in the field which is claimed to be defective.

All claims must be submitted to FPI by authorized selling dealers. It is essential that all submitted claims provide all of the necessary information including customer name, purchase date, serial #, type of unit, problem, and part or parts requested, without this information the warranty will be invalid.

**Exclusions:**

This limited Lifetime Warranty does not extend to or include paint, door or glass gasketing or trim.

At no time will FPI be liable for any consequential damages which exceed the purchase price of the unit. FPI has no obligation to enhance or modify any unit once manufactured. ie. as products evolve, field modifications or upgrades will not be performed.

FPI will not be liable for travel costs for service work.

Installation and environmental problems are not the responsibility of the manufacturer and therefore are not covered under the terms of this warranty policy.

Embers, glass and door gaskets, door handles and paint are not covered under the terms of this warranty policy.

Any unit which shows signs of neglect or misuse is not covered under the terms of this warranty policy.

The warranty will not extend to any part which has been tampered with or altered in any way, or in our judgment has been subject to misuse, improper installation, negligence or accident, spillage or downdrafts caused by environmental or geographical conditions, inadequate ventilation, excessive offsets, negative air pressure caused by mechanical systems such as furnaces, fans, clothes dryer, etc.

Freight damage to stoves and replacement parts is not covered by warranty and is subject to a claim against the freight carrier by the dealer.

FPI will not be liable for acts of God, or acts of terrorism, which cause malfunction of the appliance.

Performance problems due to operator error will not be covered by this warranty policy.

Products made or provided by other manufacturers and used in conjunction with the operation of this appliance without prior authorization from Regency®, may nullify your warranty on this product.

Any alteration to the unit which causes sooting or carboning that results in damage to the interior / exterior facia is not the responsibility of FPI.

\* Subsidy according to job scale as predetermined by FPI.

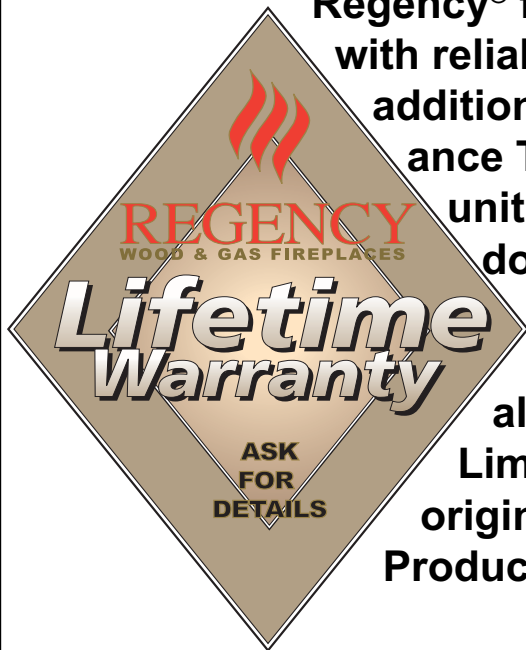

Regency® fireplace products are designed with reliability and simplicity in mind. In addition, our internal Quality Assurance Team carefully inspects each unit thoroughly before it leaves our door.

Fireplace Products International Ltd. is pleased to extend this Limited Lifetime Warranty to the original purchaser of a Regency® Product.

See the inside back cover for details.

Register your Regency® online at  
<http://www.regency-fire.com>

*Installer: Please complete the following information*

Dealer Name & Address: \_\_\_\_\_

Installer: \_\_\_\_\_

Phone #: \_\_\_\_\_

Date Installed: \_\_\_\_\_

Serial No.: \_\_\_\_\_