

SUPER TWO[®]

Expansion Enclosure
with
Supervised Alarm/Relay I/O Board

**Model CICP1300IOENCL with
Model CICP1300IOBD**

Installation and Service Manual

Continental Access



CONTINENTAL INSTRUMENTS LLC

A NAPCO SECURITY GROUP COMPANY

355 Bayview Avenue, Amityville, NY 11701
Phone: 631-842-9400 Fax: 631-842-9135

FCC Warning

Changes or modifications to this unit not expressly approved by the party responsible for compliance could void the user's authority to operate the equipment.

NOTE

This equipment has been tested and found to comply with the limits for a Class A digital device, pursuant to Part 15 of the FCC Rules. These limits are designed to provide reasonable protection against harmful interference when the equipment is operated in a commercial environment. This equipment generates, uses, and can radiate radio frequency energy and, if not installed and used in accordance with the instruction manual, may cause harmful interference to radio communications. Operation of this equipment in a residential area is likely to cause harmful interference in which the user will be required to correct the interference at his own expense.

Shielded cables must be used with this unit to ensure compliance with the Class A FCC limits.

DISCLAIMER

Continental Instruments LLC makes no representations or warranties with respect to the contents hereof and specifically disclaims any implied warranties of merchantability or fitness for any particular purpose. Further, Continental Instruments LLC reserves the right to revise this publication and to make changes from time to time in the content hereof without obligation of Continental Instruments LLC to notify any person of such revision or changes.

Information furnished by Continental Instruments LLC is believed to be accurate and reliable. However, no responsibility is assumed by Continental Instruments LLC for its use; nor for any infringements of other rights of third parties which may result from its use. No license is granted by implications or otherwise under any patent or patent rights of Continental Instruments LLC.

Copyright © 2005 by Continental Instruments LLC. All rights reserved. No part of this publication may be reproduced, transmitted, transcribed, or stored in a retrieval system, without the prior written permission of Continental Instruments LLC, 355 Bayview Avenue, Amityville, NY 11701. 631-842-9400

A NAPCO SECURITY GROUP COMPANY

THE INSTALLATION OF THIS PRODUCT SHOULD BE MADE BY QUALIFIED SERVICE PERSONNEL AND SHOULD CONFORM TO ALL LOCAL CODES.



	 <p>The lightning flash with arrowhead symbol, within an equilateral triangle, is intended to alert the user to the presence of uninsulated 'dangerous voltage' within the product's enclosure that may be of sufficient magnitude to constitute a risk of electric shock to persons.</p>  <p>The exclamation point within an equilateral triangle is intended to alert the user to the presence of important operating and maintenance (servicing) instructions in the literature accompanying the product.</p>
<p style="text-align: center;">WARNING</p> <p>This product generates, uses, and can radiate radio frequency energy and if not installed and used in accordance with the instruction manual, may cause interference to radio communications. It has been tested and found to comply with the limits for a Class A computing device pursuant to Part 15 of FCC Rules, which are designed to provide reasonable protection against such interference when operated in a commercial environment. Operation of this product in a residential area is likely to cause interference in which case the user at his own expense will be required to take whatever measures may be required to correct the interference.</p>	<p style="text-align: center;">UNPACKING AND INSPECTION</p> <p>Unpack carefully. This is an electronic product and should be handled as such. Compare the items received with the packing list with your order.</p> <p>BE SURE TO SAVE THE SHIPPING CARTONS AND INSERT PIECES. THEY ARE THE SAFEST MATERIAL IN WHICH TO MAKE FUTURE SHIPMENTS OF THE PRODUCT.</p>
<p style="text-align: center;">WARNING</p> <p>TO REDUCE THE RISK OF FIRE OR SHOCK HAZARD, DO NOT EXPOSE THIS PRODUCT TO RAIN OR MOISTURE.</p>	<p style="text-align: center;">MAINTENANCE</p> <p>User maintenance of this unit is limited to external cleaning and inspection.</p>

TABLE OF CONTENTS

DESCRIPTION	5
IMPORTANT SAFETY INFORMATION	6
CONFIGURATION	7
<i>PC Board Layout: Alarm/Relay Board</i>	8
<i>Additional Configurations</i>	9
INSTALLATION	10
<i>Installation Preparation</i>	11
<i>Cabinet Mounting</i>	12
<i>Cable and Wiring Categories</i>	13
<i>Low-Voltage Power and Accessory Relay Devices</i>	13
<i>Communication Cables</i>	13
<i>Accessory Conduit Knockouts</i>	13
<i>Grounding Accessory Drain and Shield Wires</i>	13
<i>Modular Cable</i>	14
AUXILIARY POWER	15
<i>Replay Power</i>	15
RELAY CONNECTIONS	16
<i>Description</i>	16
<i>Relay Characteristics</i>	16
ALARM CONNECTION	17
<i>Supervised Alarms</i>	17
<i>Configuring an Alarm in the Supervised Condition</i>	17
<i>Alarm Cable Requirements</i>	17
<i>Tamper Switch</i>	17
INTERNAL EXPANSION	18
<i>Installing the Supervised Alarm/Relay Board</i>	18
SPECIFICATIONS	19
SUPER TWO EXPANSION BOARD MAPPING	20
INDEX	21
WARRANTY	23
WIRING DIAGRAM	27

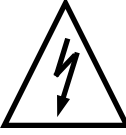

DESCRIPTION

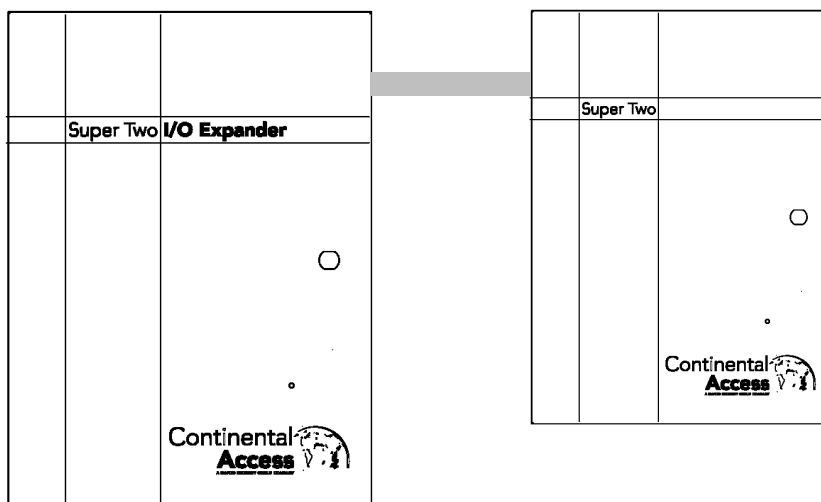
The CICP1300IOENCL allows two CICP1300IOBD Supervised Alarm / Relay Boards to be installed (these may be purchased separately). No power supply or backup battery is provided. 12 Volt DC power for the relay circuits is required either from the Accessory Power output of the Super Two Access Control Panel, or from a CICP1300IOCOMBO unit that also may provide accessory power.

The following is provided on each CICP1300IOBD PCB:

- Sixteen supervised inputs with performance matching that of the ALARM inputs of the Super Two. A status change is signaled by a half-second activation of an EVENT lamp.
- Sixteen relay outputs with LED indication of relay activation.
- An OK lamp that blinks to indicate correct operation of the equipment.
- Status lamps show LOGIC power and 12V relay power.

Sixteen more alarm inputs and sixteen more relays may be added into the enclosure by ordering and installing a second CICP1300IOBD Supervised Alarm / Relay Board.

As with the original Superterm expansion boards, using three boards, a total of 48 supervised inputs and 48 relays are added. Each Super Two Access Control panel may be configured to monitor a total of 56 supervised alarm inputs, and may control a total of 52 relay outputs. The three-board configuration will require an additional enclosure.

The Expansion Enclosure offers a matching appearance to the Super Two. A tamper switch is installed in each CICP1300IOENCL which may be monitored by an accessory alarm input of the Super Two or by one of the inputs on the Supervised Alarm / Relay Board.

The enclosure is the same width as the Super Two housing, but 3" taller to contain the power supply and battery, and to allow a channel for field wiring across the top inside the unit.

The Access Control Panel and the Alarm/Relay Expansion Unit(s) are connected and powered by short modular [RJ12] cables provided. These cables must be routed through short pieces of metal conduit. The 12 volt relay power wiring may also be routed through this conduit.

A three-foot RJ12 cable is provided with each CICP1300IOENCL Expansion Enclosure, and a four-inch RJ12 cable is provided with each Alarm/Relay Expansion Board.

Host Software Version 2.3.16 build 166 or later is required to operate with the Supervise Alarm / Relay Expansion Board. Firmware release 2.0.15 or later must be installed or downloaded to the Access Control Panel.

The alarm circuits and alarm interface components receive 5 Volt power from the Access Control Panel through the modular cable. The correct connection to this power is shown by the LOGIC Power LED. The 12 Volt power for the relays, the relay indicators, the OK lamp, and the EVENT lamp must be obtained from the Accessory Power Output of the Super Two Access Control Panel or from an adjacent CICP1300IOCOMBO Expansion Unit. The correct connection and operation of this power is shown by the activation of the 12V lamp. Because all relays may be activated at the same time, the 12 Volt power source must be able to supply at least 500mA for each CICP1300IOBD Alarm/Relay expansion board.

IMPORTANT SAFETY INFORMATION

The Super Two is defined as a Stand-Alone Access Control System. The PC connection provides convenient setup and monitoring of the system, but all decision-making for a cardholder's authorizations at a particular time and place are made by the Access Control Panel. Likewise, all time-controlled relay activities and link functions of the Access Control Panel and the Alarm/Relay Expansion Unit do not depend upon the normal operation of the PC. During disruptions in the operation of the PC, or the communications link with the PC, Access Transactions, Alarm Events, and other activities are logged in the individual Access Control Panel. When communication is restored, these buffered transactions are transferred to the PC.

The Expansion Unit is to be installed in a secured area. Nevertheless, because opening the enclosure door gives access to terminals that can allow false signals, a tamper switch is installed on the door. The tamper switch must be configured at the host computer to signal an alert when the tamper switch is an open-circuit. The tamper switch may also be configured to activate the console relay, which may then be wired into a Burglar Alarm Signal Circuit or an Alarm Sounding Circuit.

In some localities, the Alarm Circuit and Relay Circuit wiring may use UL Type CM or UL Type CL2 foil-shielded multi-conductor and multi-pair cable. Where the AHJ's (Authorities Having Jurisdiction) require Plenum-Rated cabling, UL Type CL2P cabling will be acceptable. In Canadian installations, CSA CMG FT4 foil-shielded cabling may be used in non-plenum installations, and CSA CMP FT6 foil-shielded cabling may be used in installations requiring plenum ratings.

Fault-Tolerance, Fault Isolation, and Conditions that may result in impaired operation.

Sensing the status of the Accessory Alarm Inputs will be impaired by a cut cable or short-circuit in the Alarm Signal Circuit wiring. By installing end-of-line termination resistors, as described in this manual, the Alarm Circuits may be supervised to detect such faults and indicate the need for a repair.

The Access Control Panel constantly exchanges data with the Alarm/Relay Expansion Board through the modular cable. If the cable is disconnected while the units are powered, no equipment damage will occur, but setup data stored in the Expansion Board will be lost. When the cable is reconnected, the relays will not be activated. Self-Test Firmware in the Access Control Panel will detect this disruption, and restore the setup data and relay activation within one minute. Resetting the Access Control Panel will immediately restore normal operation of the Expansion Units. Because no power supply is included in the CICP1300IOENCL Expansion Unit, 12 Volt power for the relays and indicator lamps must be obtained from the Super Two Access Control Panel or from a nearby CICP1300IO-COMBO. Whether powered from the ACC. PWR OUT terminals of the Battery-Top Charger in the CICP1300IOCOMBO unit, or the 12V OUT on the CICP1300 PC Board, the requirements of Power-Limited wiring are assured by the use of self-resetting current limiting devices.

CONFIGURATION

CICP1300IOENCL Enclosure shown with one Supervised Alarm/Relay Board CICP1300IOBD installed.

Modular Cable - A three-foot, 6-Pin, 6-Conductor modular cable is provided to supply the data and logic power connection to the Super Two or other compatible Access Control Panel. This must be plugged into the right side of the CICP1300IOBD Board, routed through metal conduit, and plugged into the Modular Jack on the left side of the Super Two Access Control Panel.

GROUNDING REQUIRED

For the built-in Alarm-Contact Surge Protection to perform effectively, the enclosure must be tied securely to earth ground. The Super Two Access Control Panel and the CICP1300IOCOMBO unit are effectively grounded through the mains power connection. When the conduit is installed, the knockout area near the conduit nut may be burnished to assure that enough paint is removed to provide an effective ground. Alternatively, a wire may be connected between one of the many drain-wire studs on the CICP1300IOENCL and one of the drain-wire studs on the Access Control Panel or a CICP1300IOCOMBO.

Component Layout is shown below.

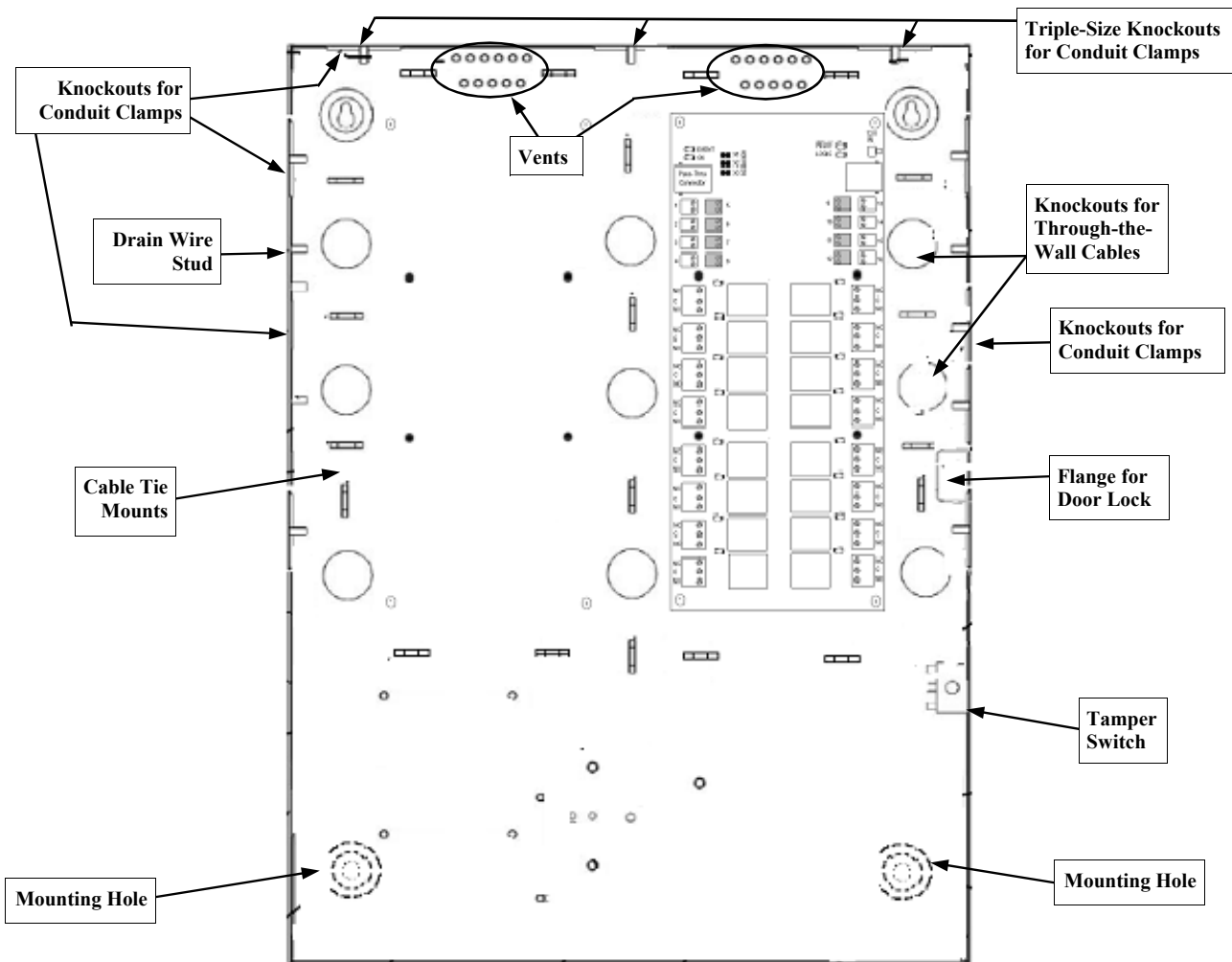

Figure 1 - Expansion Unit Components

CONFIGURATION

PC Board Layout: Alarm/Relay Board (CICP1300IOBD)

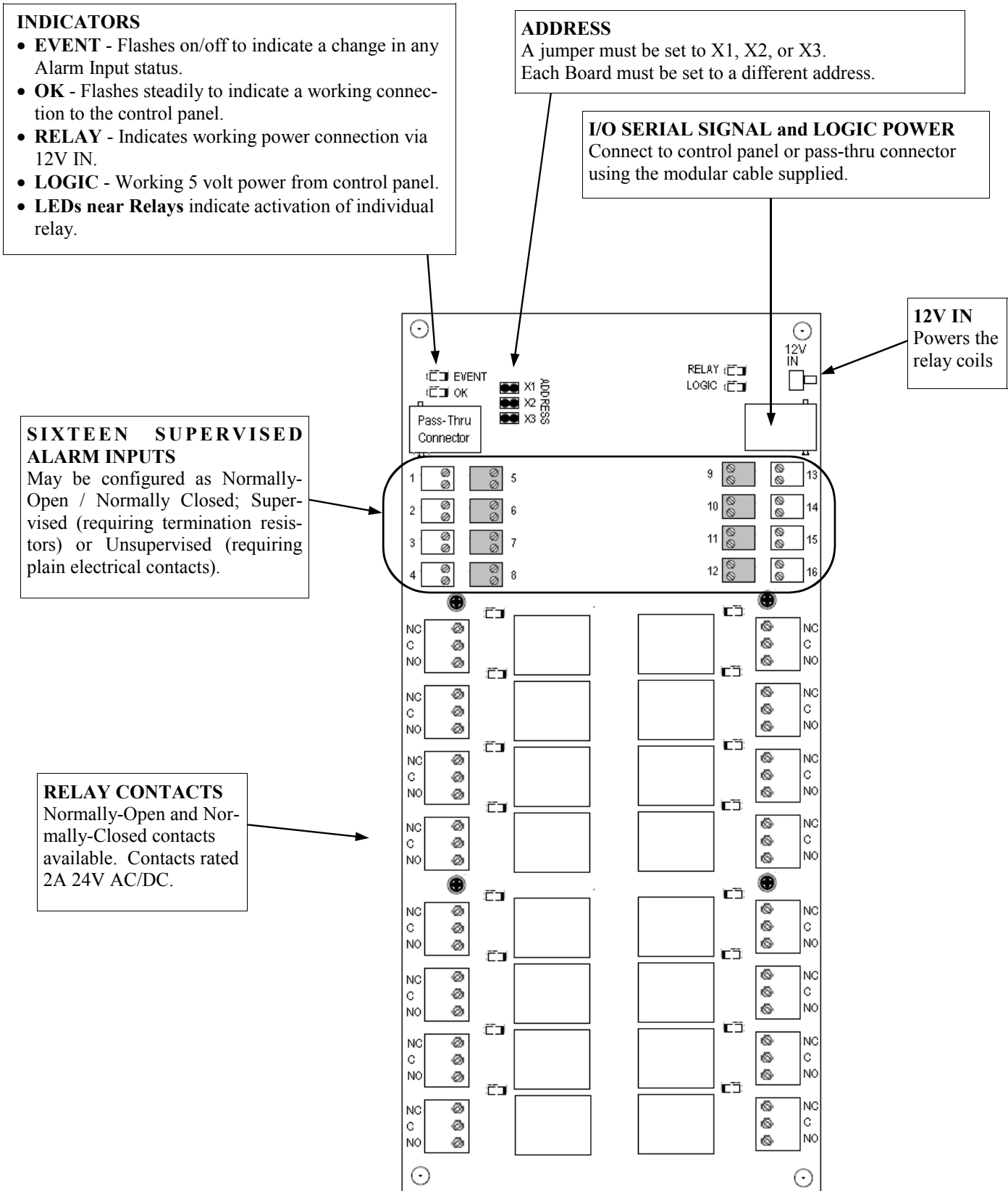

Figure 2 - PC Board Layout

Additional Configurations

A second CICP1300IOBD Alarm/Relay Board may be installed as described on page 18. Then, a second CICP1300ENCL Expansion Unit may be installed with one more CICP1300IOBD Alarm/Relay Board, bringing the total number of Alarm/Relay boards to three.

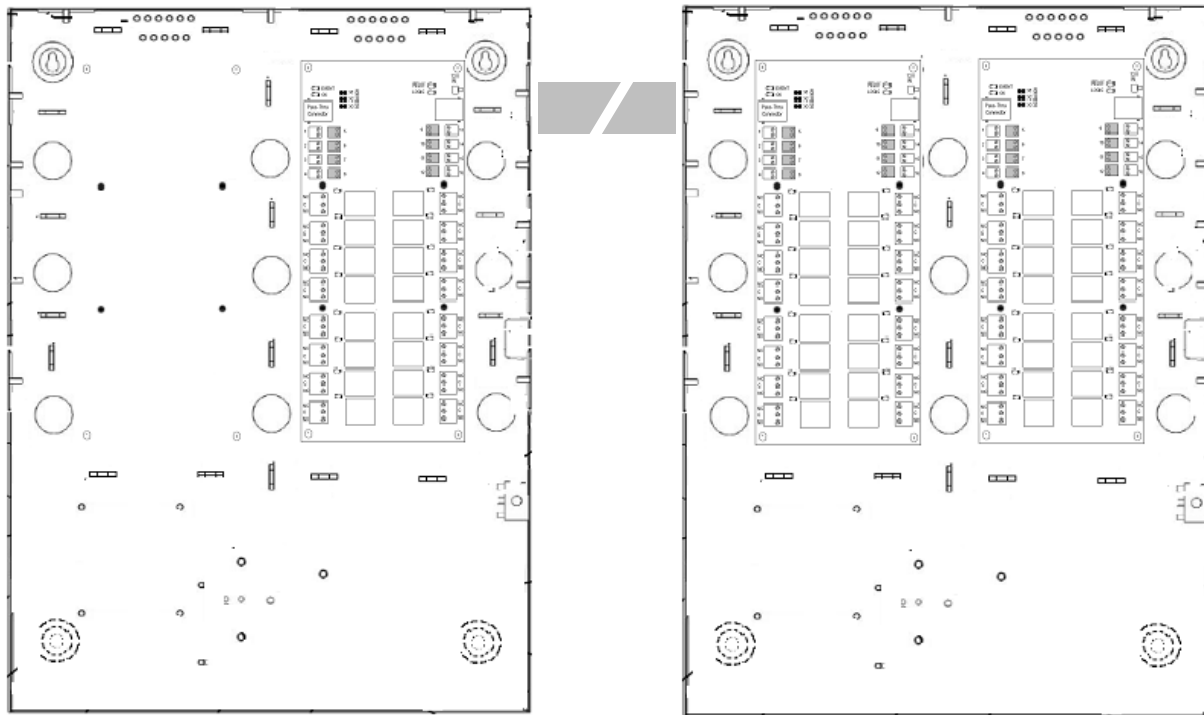

Figure 3 - Installation of a second CICP1300IOBD Alarm/Relay Board

The wire harness provided with the CICP1300ENCL Expansion Unit allows it to be powered by an adjacent Access Control Panel, but be mindful of the 500mA load that must be met by the 12 Volt power source for each Alarm/Relay Board. With three Alarm/Relay boards installed, the total load rating is 1.5A, which is close to the 1.6A limit for accessory loads on the Super Two.

Note: The maximum total length of modular cable to be used to connect the three Alarm/Relay Boards to the Access Control Panel is 9 feet (2.74 meters).

INSTALLATION

INSTALLATION

Only qualified service personnel familiar with all local building codes should attempt this installation. Take appropriate safeguards to avoid unintentional operation by employees and maintenance personnel working about the premises.

The installation of each Expansion Unit should be completed and tested on its own before connecting into a network. Any possible wiring or installation problems are magnified many times by the complexity of the network.

Once an individual panel has been tested and found operating satisfactorily, it can then be safely brought into the network.

The Expansion Unit is categorized as PERMANENTLY CONNECTED EQUIPMENT with fixed wiring. This system must be installed within the protected premise in accordance with the National Electrical Code (NFPA70), local codes, and the authorities having jurisdiction.

The following warnings are designed for the safety of the Expansion Unit install/service technician and for the continued proper function of the Expansion Unit.



About This Manual

This manual describes the installation of the Expansion Unit Access Control Unit and the specific accessories that connect to it.

End-User Periodic Tests and Emergency Planning

The Host Computer Software supervises the Access Control System, reporting failures at an individual panel within seconds of the occurrence. Nevertheless, failures can occur at the Door Sense and Bypass contact monitoring hardware, the individual Card Reader electronics and wiring, or the Electric Door Lock Hardware that will not be detected until the equipment is used. For this reason, please instruct staff at the installation to perform a "walk through" test at every controlled entrance and verify operation of all the monitored contacts at least once per week, especially at sites that are less frequently used. Assist the Security Staff at the installation to devise acceptable alternates to allow entrance and monitoring of access at controlled sites impacted by equipment failures, especially in high-traffic areas.

Provide staff members at the facility with contact information that will help assure the swift correction of equipment outages.

NOTES:	Notes are included with a procedure informing the installer about related material.
CAUTION 	Cautions indicate that a particular process requires special attention.
WARNING 	Warnings indicate that a particular process exposes the installer to live circuits or that making wrong connections can lead to equipment failure.
CAUTION 	Do not place accessory circuit cables in the same conduit sections containing power cables.

Installation Preparation

First, select a mounting location within a secure, limited access area (see Figure 4). Note the type of wall construction that the enclosure will be secured to.

- Determine that adequate space is available for mounting the Expansion Unit cabinet on a wall with no interference from wires, pipes, or other obstructions.
- Proper installation of the Expansion Unit cabinet requires an area of free space measuring at least:

23 inches high (584mm)
X
20 inches wide (508mm)
X
4.0 inches deep (101.6mm)

- Confirm that adequate free space exists on both sides of the Expansion Unit cabinet for cabling conduit entering

and exiting the cabinet.

- Determine the directions of the cabling conduit exiting the Expansion Unit cabinet. Confirm sufficient access to ceilings and/or walls before fitting the conduit lengths.
- Knockouts at the back of the unit may be used for "hidden wiring" installations.

NOTE: All Expansion Unit signal wiring and accessory power circuits are certified as power limited. The use of conduit is optional for these circuits.

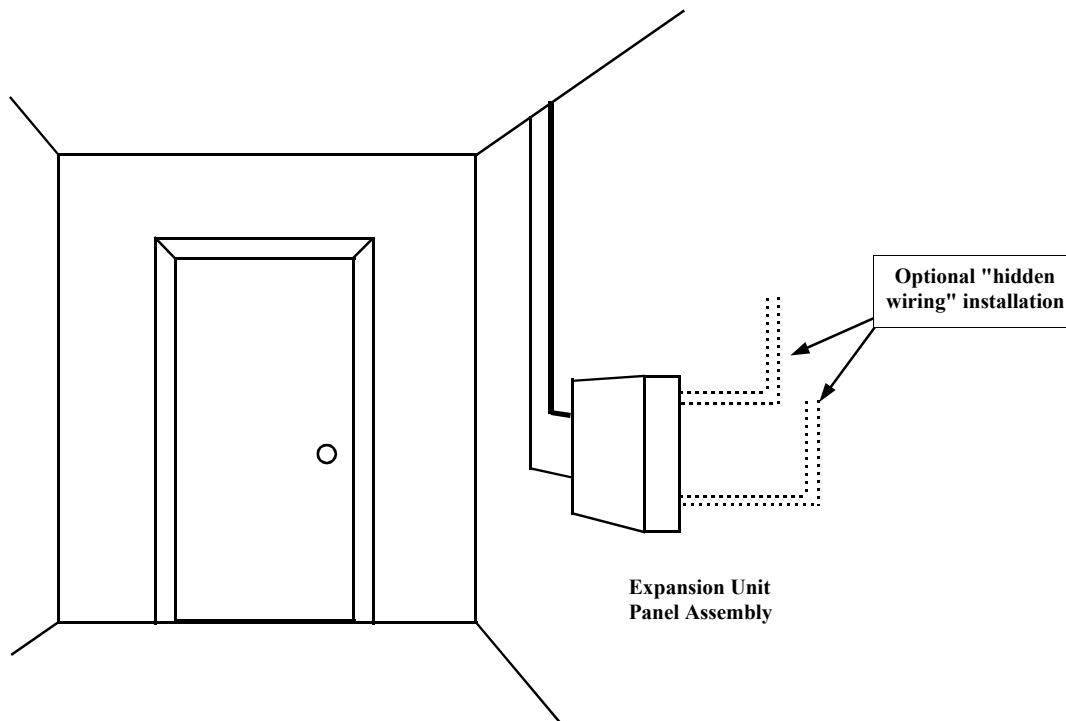

Figure 4 - Expansion Unit Installation Location

INSTALLATION

Cabinet Mounting

Inspect the mounting surface around the proposed installation site. The mounting surface must be capable of supporting 10.75 lbs. (4.9Kg) plus any additional weight of the installation hardware.



CAUTION

Use only suitable mounting hardware for the type of wall construction encountered.

1. Determine the Expansion Unit cabinet mounting location. Keep in mind that conduit will be used to connect the Expansion Unit to the Super Two Access Control Panel. If the tops of the enclosures are kept on the same line, the conduit connection will be simplified. The Expansion Unit will normally be to the left of the Super Two Access Control Panel.
2. Mark the four mounting holes against the mounting surface using the Expansion Unit cabinet as a template, or using the measurements provided in Figure 5.

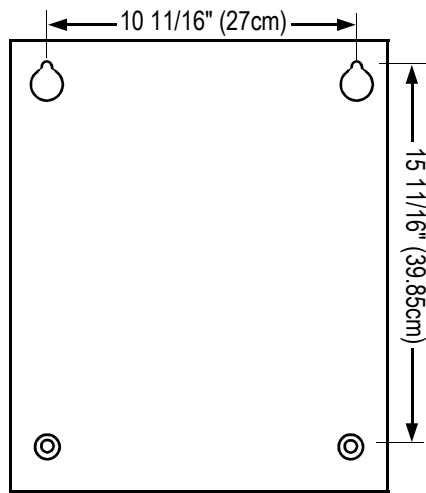

Figure 5 - Expansion Unit Cabinet Mounting Hole Dimensions

NOTE: Mark the small oval portion of the cabinet screw holes (see Figure 6, Detail A and B).

3. Place the Expansion Unit cabinet out of the way.
4. Drill pilot holes to the required depth and size for the mounting screws.
5. Insert the top two mounting screws into the wall. Leave approximately one quarter of the screw's length protruding from the wall.

NOTE: Do not tighten screws completely at this time.

6. Place the Expansion Unit cabinet over the mounting screws. Secure the Expansion Unit cabinet to the mounting surface using the two lower screws, and then tighten the remaining length of the screws.

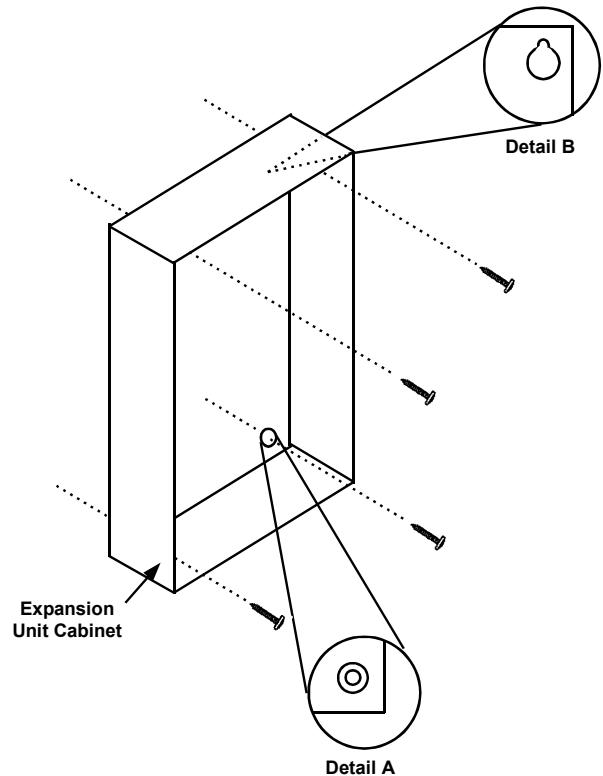

Figure 6 - Expansion Unit Mounting Screws

Cable and Wiring Categories

The wiring and cabling for the CICP1300IOENCL Expansion Unit fall into two categories:

Low-Voltage Power and Accessory Relay Devices

12 or 5 volt Power, any accessory relay controlled devices connected to the Panel, and any 12 volt Accessories receiving battery-backed power from the panel. (These are power-limited circuits, and normally do not require a licensed electrician to complete this work). The wiring inside the enclosure must be kept at least 1/4" away from the high-power (black and white pair) wires between the AC Terminal Block and the Power Supply, as well as the Red and Blacks Leads between the Battery and the PC Board.

Communication Cables

This category contains all the communication cabling between the Expansion Unit and all communication equipment, all alarm circuits, and all card reader devices. (These are power-limited circuits, and normally do not require a licensed electrician to complete this work). The wiring inside the enclosure must be kept at least 1/4" away from the high-power wires, as described in the paragraph above. **NOTE:** For proper operation of the Expansion Unit, route EACH category of cabling in SEPARATE conduit or bundle (i.e., **DO NOT mix alarm and communication cables in the same conduit as relay and power cables**). Plenum-Rated cabling may be required in certain installations. See Important Safety Information, page 6.



NOTE: This system must be installed within the protected premise in accordance with the National Electrical Code (NFPA70), local codes, and the authorities having jurisdiction.

Accessory Conduit Knockouts

All cabling for the Expansion Unit is routed through EIA standard 3/4-inch knockouts located on the left and right sides of the cabinet (see Figure 7). On the top of the enclosure, three-size knockouts are available.

Grounding Accessory Drain and Shield Wires

Ensure electromagnetic compatibility and reliable performance by keeping all accessory drain and shield wires as short as possible.

All accessory drain and shield wires connect to ground posts mounted along the knockout strips on both sides of the Expansion Unit cabinet (see Figure 7).

The following procedures assure proper installation of all drain and shield wires.

- Carefully remove the cable jacket after the cable enters the Expansion Unit cabinet.
- Place the drain wires under the ground post screw. Trim as needed.
- Verify a good connection and tighten the ground post nut.
- Connect the accessory wires to the appropriate terminal strip on the Expansion Unit circuit board.

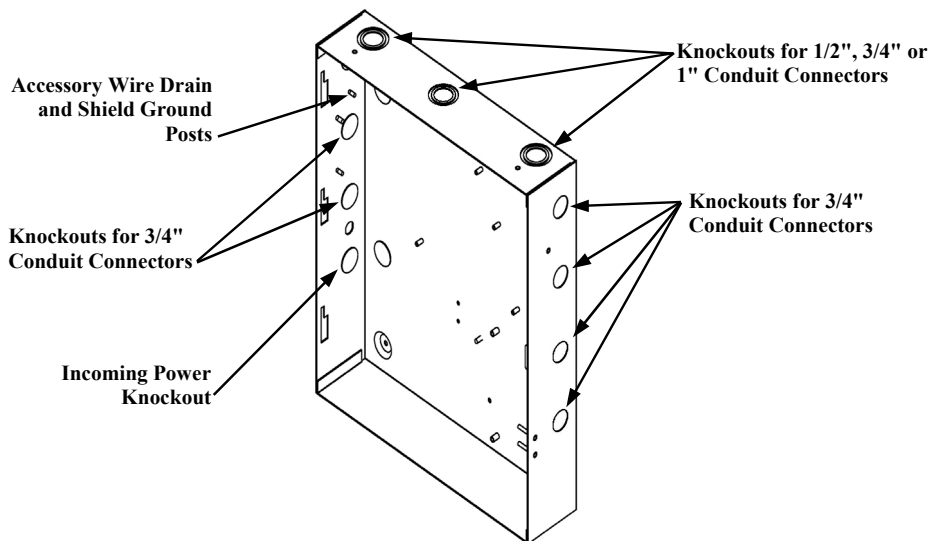

Figure 7 - Cabling Conduit Knockouts

MODULAR CABLE

Modular Cable

The Modular Cable carries Alarm Data to the Access Control Panel and Relay Activation commands from the Access Control Panel. The modest power requirements of the Logic and Alarm Circuits are provided from the Access Control Panel through this cable. The relay coil power is supplied through the 12V IN connector just above the Modular Jack on the right side of the board.

The first Alarm/Relay Board must connect to the Access Control Panel using the Jack on the right side of the board. A Pass-through connector is on the left side of the board if additional boards are used. Always connect the cable between the left of one board to the right of the next board. If this rule is

not followed, the product will not be damaged, but the system will not work correctly.

The Modular Cable must be run through metal conduit between the system enclosures. The total length must not exceed 9 feet (2.74 meters).

When removing the cable, note that the latching lever is on the side near the printed circuit board.

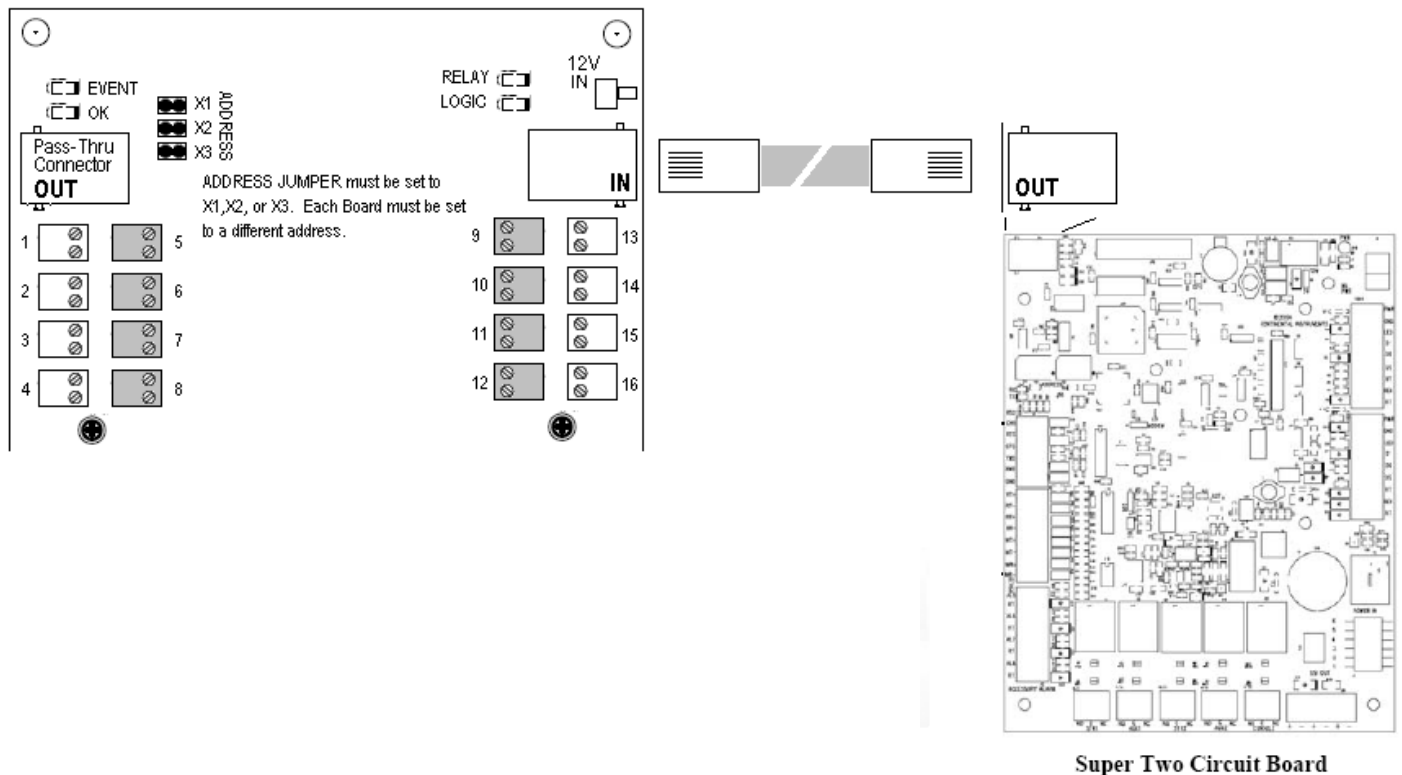

Figure 8 - Modular Cable Connection

RELAY POWER

The CICP1300IOENCL does not provide 12 Volt power that may be used for the CICP1300IOBD Alarm/Relay boards. Thus the power must be obtained from the Accessory Power output of a Super Two Access Control Panel or a CICP1300COMBO Alarm/Relay/Power Expansion Unit. Each Alarm/Relay Board Kit is supplied with a suitable long power cable for this reason. The cable may be extended if needed, and it may be routed through the conduit connecting the enclosure to the Access Control Panel.

Be careful to observe polarity when connecting to the ACC. PWR OUT terminals of the Battery-Top Charger in the CICP1300IOCOMBO unit, or the 12V OUT on the CICP1300 PC Board. The cable provided follows the convention:

- **Red is Positive**
- **Black is Negative**

Reverse polarity protection is provided, but normal operation of the equipment will be disrupted.

NOTE: +12VDC current draw on the Super Two Access Control Panel or the CICP1300IOCOMBO Expansion Unit is limited to a total maximum of 1.60 Amps for Readers, EM Locks, and Accessories.



WARNING

Observe Positive and Negative wire polarity between accessory devices and the Expansion Unit.

RELAY CONNECTIONS

RELAY CONNECTIONS

Description

Each Alarm/Relay board provides sixteen Form C relays to control Area Entry, Shift Signaling Devices, etc. If used to control high-voltage equipment such as outdoor lighting in parking areas, a suitably-wired external relay must be added to switch the high-voltage equipment.

Relay Characteristics

The relays all share the following characteristics:

- Form C relay with a contact rating of 2A at 24V AC/DC.
- The Normally Open (NO), and the Normally Closed (NC) contacts are the default state of non-energized relays. An

LED located near each relay will light when the associated relay is activated.

- Metal oxide varistors (MOVs) are placed across the contacts to reduce electrical noise. The MOVs limit any noise caused by the switching an inductive load to 56 volts.

NOTES:

- Installing a 56V MOV at the controlled device further reduces possible noise input.
- Additional MOVs are available from Continental Instruments as part number R783R.
- Because of this noise, relay wiring **MUST NOT** be put in the same conduit with other wiring.

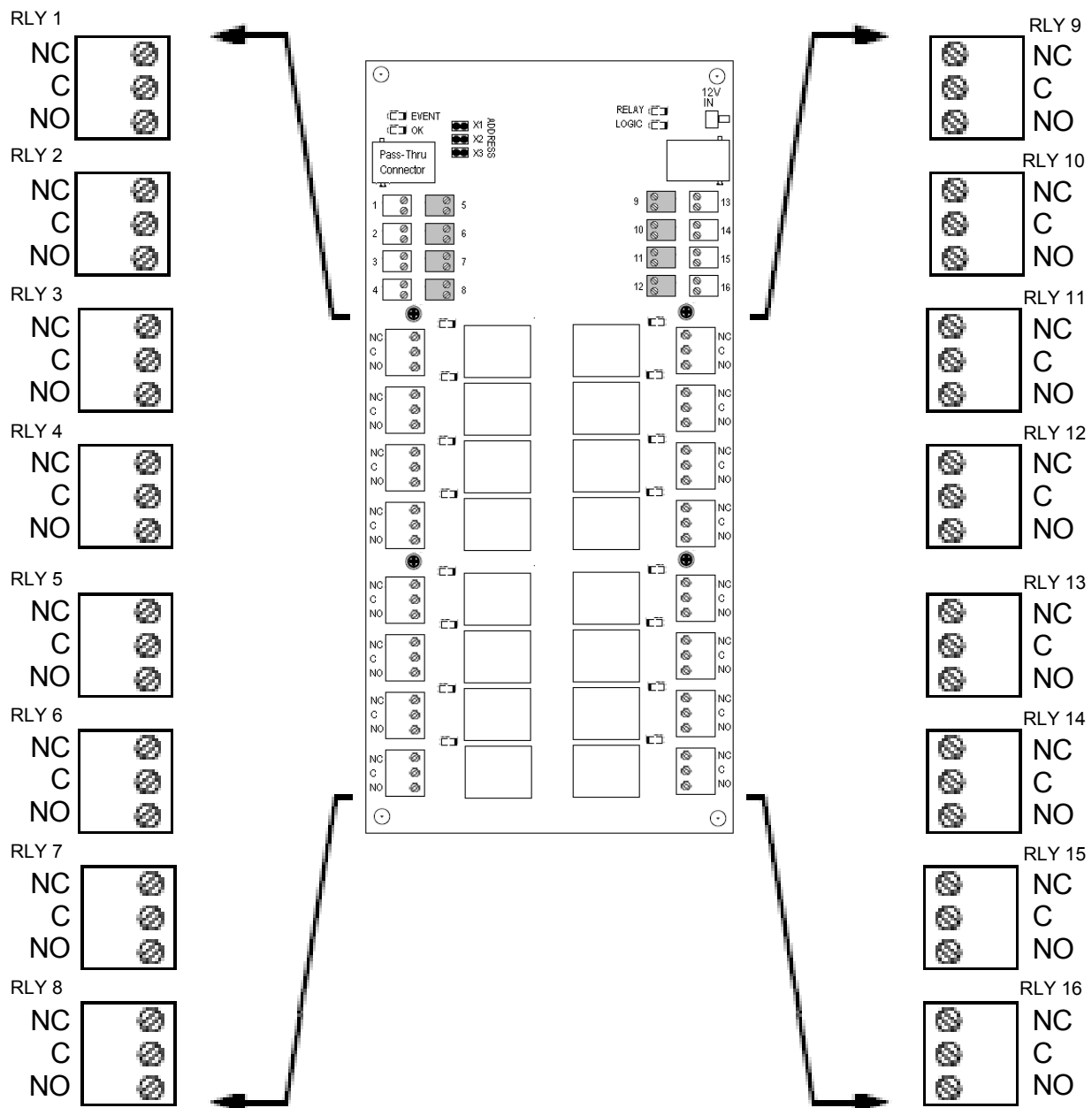

Figure 9 - Relay Contact and Accessory Power Outputs

ALARM CONNECTION

Each Alarm/Relay Board has a total of 16 supervised alarm inputs. These are located on the top portion of the PC Board. The inner columns use "Riser" Headers to ease wiring. These alarm inputs may be used for dry contact type inputs (unsupervised) or supervised alarms.

Supervised Alarms

Supervised alarms provide monitoring of alarm inputs for fault or tamper conditions. Two additional alarm states may be detected by installing two-1K ohm resistors near the alarm contacts. In addition to the standard Normal and Abnormal alarm conditions, the supervised alarms report line open and line short conditions.

- A line open condition is the result of a cut wire.
- A line short condition is the result of a short in the alarm wiring.

These fault conditions may be the result of tampering, and indicate the system cannot correctly detect the state of the alarm contacts.

Configuring an Alarm in the Supervised Condition

1. Use two 1K Ohm, 1/4W, $\pm 5\%$ carbon film resistors per alarm.
2. Install R1 in parallel with the alarm contacts (see Figure 10).
3. Install R2 in series with the alarm input conductor.

NOTE: For maximum protection, install the resistors close to the alarm contacts and embed them in epoxy.

Alarm Cable Requirements

Connecting alarm sensors to the expansion board requires 22 AWG, stranded, shielded cables with drain wires.



CAUTION

Keep all drain wires short. Connect drain wires to the ground posts located on both sides of the Expansion Unit cabinet. DO NOT ground drain wires at any other point.

Tamper Switch

The Expansion Unit Enclosure has a built-in tamper switch. The tamper switch is supplied with wiring sufficient to connect to an Alarm Input of the Access Control Panel, and may be extended with an in-line terminal block if desired. The Tamper switch wiring may be run in the same conduit with the modular cable connecting the Expander Board to the Access Control Panel. The leads may also be trimmed to connect to one of the Alarm/Relay Board Alarm Inputs. The Tamper switch is normally-closed when the enclosure door is closed. The tamper switch must be configured at the Host Computer to signal an Alert when the tamper switch is activated. The tamper switch may also be configured to activate the Console Relay that is wired to an alarm signal circuit or an alarm sounder.

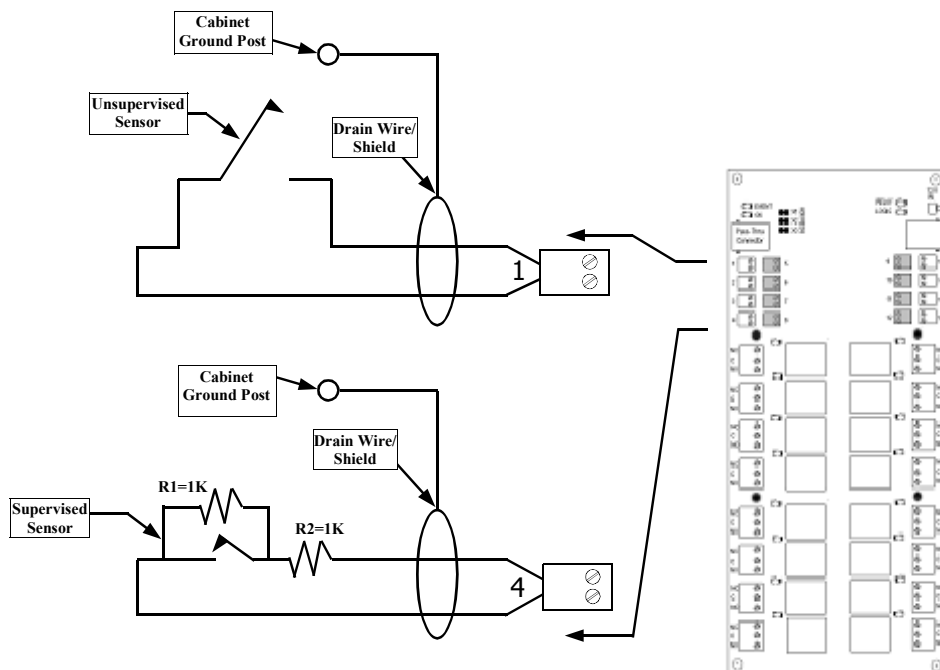
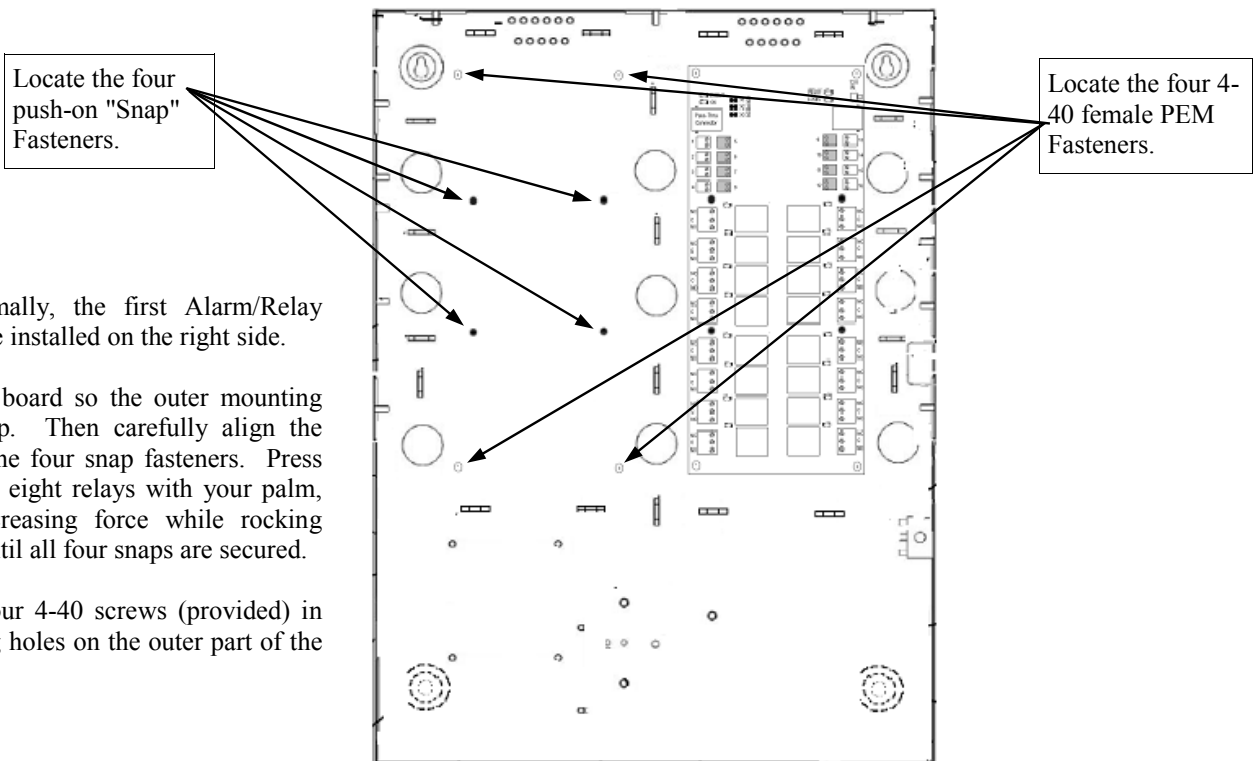

Figure 10 - ALARM Terminal Strip - Unsupervised and Supervised Alarm Connections

INTERNAL EXPANSION

Installing the Supervised Alarm/Relay (CICP1300IOBD) Boards



Note: Normally, the first Alarm/Relay Board will be installed on the right side.

Position the board so the outer mounting holes line up. Then carefully align the board over the four snap fasteners. Press on the upper eight relays with your palm, applying increasing force while rocking your palm until all four snaps are secured.

Install the four 4-40 screws (provided) in the mounting holes on the outer part of the board.

Figure 11 - Fastener Mounting Locations

Locate the **12V IN** connector on the upper-right of the board.

When being installed in the CICP1300IOCOMBO (with the power supply and battery) connect the small white Molex Connector from the cable plugged into **RLY PWR OUT** Connector.

When installed in the CICP1300ENCL (without the power supply and battery) use the long cable provided to connect to the Accessory Power Connector in the Access Control Panel. Note this cable may be routed with the Modular cable in the same conduit.

Connect the Short Modular Cable (provided) between the two Alarm/Relay boards.

Connect the Long Modular Cable (provided with the enclosure) to the adjacent Super Two panel or another I/O Expansion Unit.

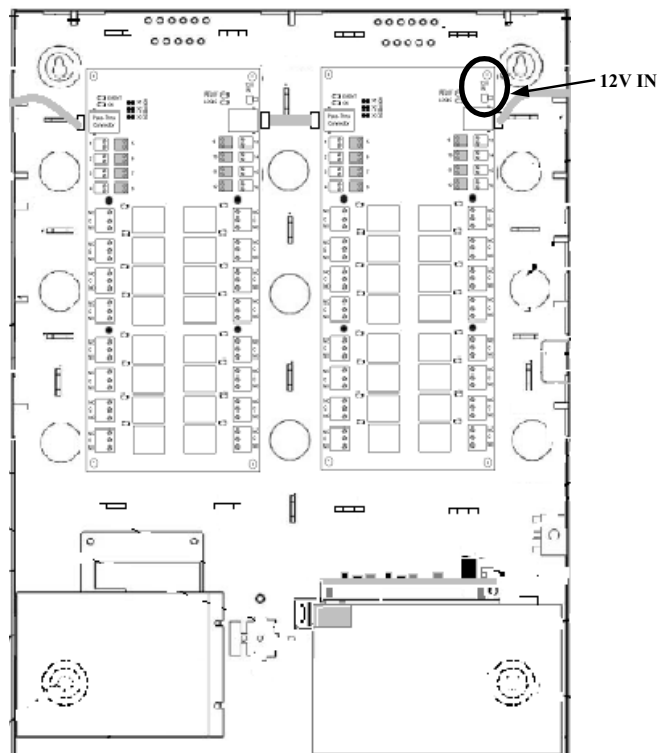

Figure 12 - Power Connection Locations

SPECIFICATIONS

SPECIFICATION	Quantity	Comments
Relays	16 (each PDB) per panel.	Form "C", contact rating of 2A @ 24V AC/DC 48 maximum per Super Two panel
Alarms	16 (each PDB) per panel.	Supervised or non-supervised (host programmable) 48 maximum per Super Two panel
Status LEDs	16 4	One LED per relay EVENT, OK, RELAY power, LOGIC power
Tamper Switch	1	
Supply Voltage		12 Volts DC
Current Draw		500mA maximum
Weight		10.75 lbs (4.9kg)
Enclosure Dimensions (H x W x D)		18.75" x 13.85" x 3.25" (47cm x 35.2cm x 8.3cm)
Temperature Range Operating Storage		32-115°F (0-46°C) 32-149°F (0-65°C)
Relative Humidity		0% to 85% non-condensing
Link Programs	64	Standard

Cables	AWG	Type	Maximum Length
Alarm Inputs	22 ga	Stranded, shielded, w/drain 2-conductor alarm	500 ft (153m)
Relay Circuits	18 ga	Stranded, shielded, w/drain	500 ft (153m)

SUPER TWO EXPANSION BOARD MAPPING

Expansion Board #1

Relay	Input
5	9
6	10
7	11
8	12
9	13
10	14
11	15
12	16
13	17
14	18
15	19
16	20
17	21
18	22
19	23
20	24

Expansion Board #2

Relay	Input
21	25
22	26
23	27
24	28
25	29
26	30
27	31
28	32
29	33
30	34
31	35
32	36
33	37
34	38
35	39
36	40

Expansion Board #3

Relay	Input
37	41
38	42
39	43
40	44
41	45
42	46
43	47
44	48
45	49
46	50
47	51
48	52
49	53
50	54
51	55
52	56

VIRTUAL INPUTS

Reader 1	
Function	Input
Forced Door	49
Valid Tracked	50
Void /Denied Card	51
Open Too Long	52

Reader 2	
Function	Input
Forced Door	53
Valid Tracked	54
Void /Denied Card	55
Open Too Long	56

NOTE: Virtual Inputs are not available if Expansion Board # 3 is used.

ACCESSORY POWER	13, 15	MODULAR CABLE	
ADDITIONAL CONFIGURATIONS	9	LENGTH LIMITATIONS.....	9
ADDRESS		MODULAR CABLE	7, 14
JUMPER.....	8	MODULAR JACK.....	7
ALARM CABLE REQUIREMENTS.....	17	MOUNTING	
ALARM CONNECTION.....	17	CABINET	12
ALARM INPUTS.....	17	MOUNTING LOCATIONS	11
BOARD LAYOUT	8	OK	
CABINET MOUNTING	12	INDICATOR.....	8
CABLE		PC BOARD LAYOUT	8
REQUIREMENTS.....	6	PERIODIC TESTS	10
CABLE		RELAY	
CATEGORIES	13	INDICATOR.....	8
COMMUNICATION.....	13	RELAY CHARACTERISTICS.....	16
CICP1300IOBD		RELAY CONNECTIONS	16
DESCRIPTION	5	RELAY CONTACTS	
INSTALLING.....	18	RATINGS	8
CICP1300IOENCL		RELAY OUTPUTS	5
DESCRIPTION	5	RELAY POWER.....	15
CIPC1300IOBD COMPONENTS.....	7	SAFETY INFORMATION	6
CONFIGURATION	7	SHIELD WIRES	13
DRAIN WIRES	13	SHIELDED CABLING	
EVENT		REQUIREMENTS.....	6
INDICATOR.....	8	SOFTWARE VERSION	
EXPANSION BOARD MAPPING	20	REQUIREMENTS.....	5
EXPANSION UNIT COMPONENTS.....	7	SPECIFICATIONS	19
GROUNDING		SUPERVISED ALARMS	17
REQUIREMENTS.....	7	SUPERVISED INPUTS.....	5
I/O SERIAL SIGNAL.....	8	TAMPER SWITCH.....	17
INDICATORS	8	VIRTUAL INPUTS.....	20
INSTALLATION		WARRANTY	23
PREPARATION	11	WIRE POLARITY	15
INSTALLATION.....	10	WIRING	
JUMPER	8	CABLE REQUIREMENTS	6
KNOCKOUTS.....	13	WIRING	
LED		CATEGORIES	13
INDICATORS.....	8	WIRING DIAGRAM	27
LOGIC			
INDICATOR.....	8		
LOGIC POWER.....	8		

NOTES

WARRANTY / TERMS & CONDITIONS

Standard Terms of Sale

Ordering

Orders for Continental products may be placed by calling Continental's order department or by issuing a purchase order specifying the quantity of Products, the desired delivery date, shipping method, and the location to which product should be shipped. If an order is placed by telephone, it must be confirmed in writing by fax or mail.

If the customer requests a guaranteed ship date or expedited shipping, Continental reserves the right to add to the price, with the customer's approval, expenses which increase the cost of production and delivery, i.e. freight charges, overtime expenses, etc. Continental reserves the right to change any price on this price list and all prices are subject to factory reconfirmation at the time of placing an order.

Sales Assistance

Continental will furnish to customers, reasonable quantities of product-related catalogs and other sales and promotional literature.

Continental will provide customer training, both technical and sales at Continentals facilities in New York. Contact the factory for costs and requirements.

Payment Terms

- Sales terms are Cash on Delivery (COD) unless prior credit arrangements are established.
- If credit arrangements are established with Continental, terms of sale are net 10 days.
- Interest charges shall accrue on all past due accounts at a rate of 1.5% per month (18% APR).
- Continental reserves the right to place a customer on a C.O.D. status in the event that customer's account becomes delinquent or Continental becomes unsure about customer's financial capabilities.
- Continental will charge a Service Fee of \$50.00 for any returned check.

- If customer believes an invoice to be in error, customer shall notify Continental of the error within thirty (30) days.
- Continental reserves a security interest in all products sold hereunder, together with all proceeds thereof to secure the performance of the customer's obligations hereunder.
- All orders unless otherwise requested are shipped F.O.B. Amityville, NY.

Cancelled Orders

Special or custom order items that cannot be cancelled with our suppliers are subject to a 100% cancellation charge.

No unauthorized, returned merchandise will be accepted for credit.

Orders returned or canceled are subject to a 25% restocking charge.

Return Material Authorizations

No products will be accepted for return to Continental without prior written authorization (RMA). Unauthorized returns will not be accepted from the carrier by the receiving department. The customer may request a return material authorization (RMA), whether for credit or repair of the product. Continental will either issue an RMA or provide the customer with a written explanation for not issuing the RMA. Except for warranty claims, no returns will be accepted more than 60 days after shipment from Continental. Orders that are accepted for return are subject to a 25% restocking charge. No product will be accepted for return which has been special ordered or custom in nature.

Limited Warranty

Return Material Authorization (RMA) numbers are required to be issued by Continental prior to returning any Product for service, repair, credit or exchange. Continental warrants that its Products shall be free from defects in materials and workmanship for a pe-

riod of one year from date of shipment of the product to purchaser. The warranty on 3rd party equipment such as terminals, printers, and communications devices shall be 1 year from date of shipment. Remediation of this warranty shall be limited to the repair or replacement of those products which are defective or become defective under normal use. Continental's warranty shall not extend to any product which is found after examination to be defective as a result of misuse, improper storage, incorrect installation, operation or maintenance, alteration, modification or accident.

There are no other warranties which extend beyond this provision. This warranty is in lieu of all other warranties whether express, implied or statutory, including implied warranties of merchantability or fitness for any particular purpose. No representation or warranty of the distributor shall extend the liability or responsibility of the manufacturer beyond the terms of this provision. In no event shall Continental be liable for any costs, loss of profits, loss of use, incidental, consequential or special damages to any person resulting from the use of Continental's products.

The above limited warranty is the only warranty provided by Continental. Continental makes no other warranties or guarantees, whether expressed or implied, including, but not limited to, warranties and/or guarantees of merchantability or fitness for a particular purpose. In no event shall Continental be liable for any indirect, consequential or incidental damages, including those to person and those for lost wages, or other economic loss.

Product Liability

Continental's sole Liability and the customer's exclusive remedy for damages, shall not exceed the cost of correcting the defect and in no event shall such liability be greater than the purchase price paid by the customer for the defective equipment or software. Under

no Circumstances will Continental be liable for direct, indirect or consequential damages of any kind.

General Notices:

In order to assure that Continental's customers receive the most accurate and reliable information possible, Continental at times monitors telephone calls

Information and pricing contained within this document are subject to change without notice.

Continental does not recommend that these products be used as the primary means of monitoring, warning or egress. Primary warning or monitoring systems should always meet local fire and safety code requirements.

This transaction shall be governed and construed in accordance with the laws of the State of New York.

Continental specifically rejects any terms or conditions stated by the customer or contained within purchase documents or correspondence from the customer which are in addition to, conflict with or limit, terms or conditions set forth herein. The customer's execution or other acceptance of this proposal or its acceptance of delivery of all or part of the goods to be delivered hereunder shall constitute customer's acceptance of the terms and conditions herein and shall be deemed to exclude any additional, conflicting or limiting terms stated by customer or contained in customer's purchase documents or correspondence.

NOTES

NOTES

Continental Access 

CONTINENTAL INSTRUMENTS LLC

A NAPCO SECURITY GROUP COMPANY

355 Bayview Avenue, Amityville, NY 11701
Phone: 631-842-9400 Fax: 631-842-9135