

PROCOM

Vent Free L.P. & NATURAL
GAS VENT-FREE STOVE

OWNER'S OPERATION AND INSTALLATION MANUAL

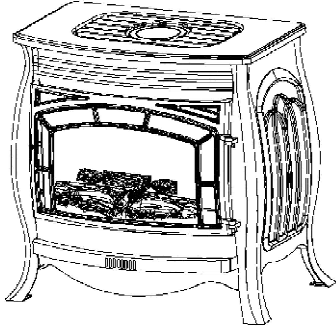

SSU320RHN-GB	SSU320RHL-GB
SSU320RHN-B	SSU320RHL-B
SSU320RHN-G	SSU320RHL-G
SSU320RHN-S	SSU320RHL-S

⚠ WARNING: Improper installation, adjustment, alteration, service or maintenance can cause injury or property damage. Refer to this manual for correct installation and operational procedures. For assistance or additional information consult a qualified installer, service agency, or local gas supplier.

⚠ WARNING: This is an unvented gas-fired heater. It uses air (oxygen) from the room in which it is installed. Provisions for adequate combustion and ventilation air must be provided. Refer to Air For Combustion and Ventilation section on page 5 of this manual.

Continental Appliance Inc./U.S. Office

5 Musick Irvine CA 92618	4600 Highlands Parkway S.E. Suite# D/E Smyrna GA 30080
--------------------------------	--

Nanjing PRO-COM Electric Appliance Co., Ltd.
#6 Chuangye Road, High New Tech. Zone,
Great Bridge Road North, Nanjing, 210061, China.



TOLL-FREE NUMBER: 1-877-886-5989

⚠ WARNING: If the information in this manual is not followed exactly, a fire or explosion may result causing property damage, personal injury, or loss of life.

Do not store or use gasoline or other flammable vapors and liquids in the vicinity of this or any other appliance.

WHAT TO DO IF YOU SMELL GAS

- Do not try to light any appliance.
- Do not touch any electrical switch; do not use any phone in your building.
- Immediately call your gas supplier from a neighbor's phone. Follow the gas supplier's instructions.
- If you cannot reach your gas supplier, call the fire department.

Installation and service must be performed by a qualified installer, service agency, or local gas supplier.

This appliance may be installed in an aftermarket*, permanently located manufactured (mobile) home, where not prohibited by local codes. This appliance is only for use with the type of gas indicated on the rating plate. This appliance is not convertible for use with other gases.

WATER VAPOR: A BY-PRODUCT OF UNVENTED ROOM HEATERS

Water vapor is a by-product of gas combustion. An unvented room heater produces approximately one (1) ounce (30)ml of water for every 1,000BTU'S (.3KW'S) OF gas input per hour, Refer to page 7.

Consumer : Please retain these instruction for future use.

Installer: Please leave these instructions with the consumer.

* Aftermarket: Completion of sale, not for purpose of resale, from the manufacturer.

PC-SL035A058-0505

Table of Contents

Safety Information-----	2
Product Features-----	4
Local codes-----	4
Unpacking-----	4
Air for Combustion & Ventilation-----	5
Installation-----	7
Connecting To Gas Supply-----	8
Checking Gas Connections-----	9
Log Placement-----	10
Operating Heater-----	11
Cleaning and Maintenance-----	14
Specification-----	16
Troubleshooting-----	17
Parts Breakdown & Parts List-----	20

SAFETY INFORMATION

Make certain you read and understand all warnings. Keep this manual for reference. It is your guide to safe and proper operation of this heater.

IMPORTANT: Read this owner's manual carefully and completely before trying to assemble, operate, or service this heater. Improper use of this heater can cause serious injury or death from burns, fire, explosion, electrical shock, and carbon monoxide poisoning.

⚠ DANGER: Carbon monoxide poisoning may lead to death!

WARNING

When used without fresh air, heater may give off CARBON MONOXIDE, an odorless, poisonous gas.

DO NOT INSTALL HEATER UNTIL ALL NECESSARY PROVISIONS ARE MADE FOR COMBUSTION AND VENTILATION AIR. CONSULT THE WRITTEN INSTRUCTIONS PROVIDED WITH THE HEATER FOR INFORMATION CONCERNING COMBUSTION AND VENTILATION AIR. IN THE ABSENCE OF INSTRUCTIONS, REFER TO THE NATIONAL FUEL GAS CODE, ANSI Z223.1, SECTION 5.3 OR APPLICABLE LOCAL CODES.

This heater is equipped with a PILOT LIGHT SAFETY SYSTEM designed to

turn off the heater if not enough fresh air is available

DO NOT TAMPER WITH PILOT LIGHT SAFETY SYSTEM!

If heater shuts off, do not relight until you provide fresh air.

If heater keeps shutting off have it serviced. Keep burner and control compartment clean.

CARBON MONOXIDE POISONING MAY LEAD TO DEATH!

Early signs of carbon monoxide poisoning resemble the flu with headache, dizziness and/or nausea. If you have these signs, heater may not be working properly. Get fresh air at once! Have heater serviced. Some people - pregnant women, persons with heart or lung disease, anemia, those under the influence of alcohol, those at high altitude - are more affected by carbon monoxide than others.

Natural and Propane/LP Gas: Natural and Propane/LP gas is odorless. An odor-making agent is added to the gas. The odor helps you detect a gas leak. However, the odor added to the gas can fade. Gas may be present even though no odor exists.

⚠ WARNING: Any change to this fireplace or its controls can be dangerous.

WARNING

Models SSU320RHN is equipped for Natural gas. Field conversion is not permitted.

Models SSU320RHL is equipped for propane gas. Field conversion is not permitted.

⚠ WARNING: Do not allow fans to blow directly into the heater. Avoid any drafts that alter burner flame patterns. Ceiling fans can create drafts that alter burner flame patterns. Altered burner patterns can cause sooting.

⚠ WARNING: Do not use a blower insert, heat exchanger insert, or other accessory not approved for use with this heater.

Due to high temperatures, the appliance should be located out of traffic and away from furniture and draperies.

Heater becomes very hot when running. Keep children and adults away from hot surfaces to avoid burns or clothing ignition. Heater will remain hot for a time after shutoff. Allow surfaces to cool before touching.

SAFETY INFORMATION

Continued

Do not place clothing or other flammable material on or near the appliance. Never place any objects in the heater.

Carefully supervise young children when they are in the room with the heater.

You must operate this heater with the heater door with screen in place. Make sure the heater door with screen is in place before running heater.

Keep the appliance area clear and free from combustible materials, gasoline, and other flammable vapors and liquids.

WATER VAPOR: A BY-PRODUCT OF UNVENTED ROOM HEATERS

Water vapor is a by-product of gas combustion. An unvented room heater produces approximately one (1) ounce (30ml) of water for every 1,000 BTU's (.3kw's) of gas input per hour. Unvented room heaters are intended as supplemental heat (a room) rather than a primary heat source (an entire house) in most supplemental heat applications, the water vapor does not create a problem, in most applications the water vapor enhances the low humidity atmospheres experienced during cold weather.

The following steps will help insure that water vapor does not become a problem.

1. Be sure the heater is sized properly for the application, including ample combustion air and circulation of the air.
2. If high humidity is experienced, a dehumidifier may be used to help lower the water vapor content of the air.
3. Do not use an unvented room heater as the primary heat source.

1. This appliance is only for use with the type of gas indicated on the rating plate. This appliance is not convertible for use with other gases.
2. Do not place Propane/LP supply tank (s) inside any structure. Locate Propane/LP supply tank(s) outdoors.
3. If you smell gas
 - Shut off gas supply.
 - Do not try to light any appliance.
 - Do not touch any electrical switch: do not use any phone in your building.
 - Immediately call your gas supplier from a neighbor's phone. Follow the gas supplier's instructions.
 - If you cannot reach your gas supplier, call the fire department.
4. This heater shall not be installed in a bedroom or bathroom.
5. Do not use this heater as a wood-burning heater. Use only the logs provided with the heater.
6. Do not add extra logs or ornaments such as pine cones, vermiculite, or rock wool. Using these added items can cause sooting. Do not add lava rock around base. Rock and debris could fall into the control area of heater. After servicing, always replace screen before operating heater.
7. This heater is designed to be smokeless. If logs ever appear to smoke, turn heater off and call a qualified service person. Note: During initial operation, slight smoking could occur due to log curing and heater burning manufacturing residues.
8. To prevent the creation of soot, follow the instructions in *Cleaning and Maintenance*.
9. This heater needs fresh air ventilation to run properly. This heater has an Oxygen Depletion Sensing (ODS) safety shutoff system. The ODS shuts down the heater if not enough fresh air is available. See *Air for Combustion and Ventilation*, pages 5 through 6. If heater keeps shutting off, see *Troubleshooting*, pages 17 through 19.
10. Keep all air openings in front and bottom of heater clear and free of debris. This will insure enough air for proper combustion.
11. If heater shuts off. Do not relight until you provide fresh, outside air. If heater keeps shutting off, have it serviced.
12. Do not run heater:
 - Where flammable liquids or vapors are used or stored.
 - Under dusty conditions.
13. Before using furniture polish, wax, carpet cleaner, or similar products, turn heater off. If heated, the vapors from these products may create a white powder residue within burner box or on adjacent walls or furniture.
14. Do not use this heater to cook food or burn paper or other objects.
15. Do not use heater if any part has been under water. Immediately call a qualified service technician to inspect the room heater and to replace any part of the control system and any gas control which has been under water.
16. Turn off and unplug heater and let cool before servicing. Only a qualified service person should service and repair heater.
17. Operating heater above elevations of 4,500 feet could cause pilot outage.
18. Do not operate heater if any log is broken. Do not operate heater if a log is chipped (dime-sized or larger).
19. To prevent performance problems, do not use Propane/LP fuel tank of less than 100 lbs. capacity.

SAFETY INFORMATION Continued

QUALIFIED INSTALLING AGENCY

Installation and replacement of gas piping, gas utilization equipment or accessories and repair and servicing of equipment shall be performed only by a qualified agency. The term "qualified agency" means any individual, firm, corporation, or company that either in person or through a representative is engaged in and is responsible for (a) the installation, testing, or replacement of gas piping or (b) the connection, installation, testing, repair, or servicing of equipment; that is experienced in such work; that is familiar with all precautions required, and that has complied with all the requirements of the authority having jurisdiction.

PRODUCT FEATURES

SAFETY PILOT

This heater has a pilot with an Oxygen Depletion Sensing (ODS) safety shutoff system. The ODS/pilot is a required feature for vent-free room heaters. The ODS/pilot shuts off the heater if there is not enough fresh air.

AUTOMATIC IGNITION SYSTEM

This heater is equipped with an automatic control system.

This system requires no matches, or batteries to light heater.

THERMOSTATIC HEAT CONTROL MODULE

This heater has a control module with a thermostat sensing bulb. SET TEMP with remote control. This results in the greatest heater comfort and may result in lower gas bills.

MANUAL OVERRIDE CONTROL SYSTEM

This heater has two operation functions: Remote Control and Manual Override Control. The Remote Control has a transmitter, which requires three AAA batteries and electric power outlet to operate. If no electric power is available, then you can operate the heater by manual override.

LOCAL CODES

This heater is designed for vent free operation. Some state and local codes prohibit the use of vent-free gas heaters.

Install and use heater with care. Follow all local codes. In the absence of local codes, use the latest edition of *The National Fuel Gas Code, ANSI Z223.1*, also known as NFPA 54*.

*Available from:

American National Standards Institute, Inc.

1430 Broadway
New York, NY 10018

National Fire Protection Association, Inc.

Batterymarch Park
Quincy, MA 02269

State of Massachusetts: The installation must be made by a licensed plumber or gas fitter in the Commonwealth of Massachusetts.

Sellers of unvented propane or natural gas-fired supplemental room heaters shall provide to each purchaser a copy of 527 CMR 30 upon sale of the unit.

In the state of Massachusetts, unvented propane or natural gas-fired space heaters shall be prohibited in bedrooms and bathrooms.

In the State of Massachusetts the gas cock must be a "T" handle type. The State of Massachusetts requires that a flexible appliance connector cannot exceed three feet in length.

UNPACKING

1. Remove top inner pack.
2. Tilt carton so that stove is upright.
3. Remove protective side packaging.
4. Slide stove out of carton.
5. Remove protective plastic wrap.
6. Rotate door handle and open door.
7. Remove log set by cutting plastic ties.
8. Carefully unwrap log.
9. Check for any shipping damage. If stove or logs are damaged, promptly inform dealer where you bought stove.

PRODUCT IDENTIFICATION

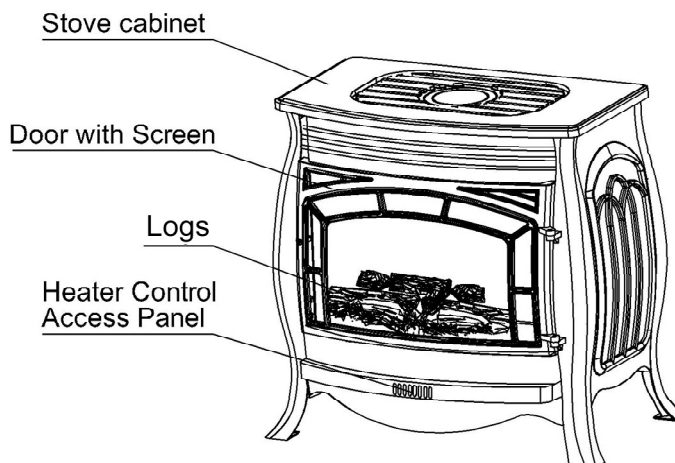

Figure 1- Vent Free Gas Stove

AIR FOR COMBUSTION AND VENTILATION

⚠ WARNING: This heater shall not be installed in a confined space or unusually tight construction unless provisions are provided for adequate combustion and ventilation air. Read the following instructions to insure proper fresh air for this and other fuel-burning appliances in your home.

PROVIDING ADEQUATE VENTILATION

The following are excerpts from *National Fuel Gas Code, NFPA 54/ANSI Z223.1, Section 5.3, Air for Combustion and Ventilation*.

All spaces in homes fall into one of the three following ventilation classifications:

1. Unusually Tight Construction
2. Unconfined Space
3. Confined Space

The information on pages 5 through 6 will help you classify your space and provide adequate ventilation.

Confined and Unconfined Space

The National Fuel Gas Code, ANSI Z223.1 defines a confined space as a space whose volume is less than 50 cubic feet per 1,000 Btu per hour (4.8 m³ per kw) of the aggregate input rating of all appliances installed in that space and an unconfined space as a space whose volume is not less than 50 cubic feet per 1,000 Btu per hour (4.8 m³ per kw) of the aggregate input rating of all appliances installed in that space. Rooms communicating directly with the space in which the appliances are installed*, through openings not furnished with doors, are considered a part of the unconfined space.

This heater shall not be installed in a confined space or unusually tight construction unless provisions are provided for adequate combustion and ventilation air.

* Adjoining rooms are communicating only if there are doorless passageways or ventilation grills between them.

Unusually Tight Construction

The air that leaks around doors and windows may provide enough fresh air for combustion and ventilation. However, in buildings of unusually tight construction, you must provide additional fresh air.

Unusually tight construction is defined as construction where:

- a) Walls and ceilings exposed to the outside atmosphere have a continuous water vapor retarder with a rating of one perm (6×10⁻¹¹kg per pa-sec-m²) or less with openings gasketed or sealed and
- b) Weather stripping has been added on openable windows and doors and
- c) Caulking or sealants are applied to areas such as joints around window and door frames, between sole plates and floors, between wall ceiling joints, between wall panels, at penetrations for plumbing, electrical, and gas lines, and at other openings.

If your home meets all of the three criteria above, you must provide additional fresh air. See *Ventilation Air From Outdoors*.

If your home does not meet all of the three criteria above, proceed to *Determining Fresh-Air Flow For Heater Location*.

DETERMINING FRESH-AIR FLOW FOR HEATER LOCATION

Determining if You Have a Confined or Unconfined Space

Use this worksheet to determine if you have a confined or unconfined space.

Space: Includes the room in which you will install heater plus any adjoining rooms with doorless passageways or ventilation grills between the rooms.

1. Determine the volume of the space (length×width×height).

Length×Width×Height= _____cu.ft. (volume of space)

Example: Space size 20ft. (length)×16ft.(width)×8ft. (ceiling height)=2560cu. ft. (volume of space)

If additional ventilation to adjoining room is supplied with grills or openings, add the volume of these rooms to the total volume of the space.

2. Divide the space volume by 50 cubic feet to determine the maximum Btu/Hr the space can support.

_____(volume of space)÷50 cu. ft.=(Maximum Btu/Hr the space can support)

Example: 2560 cu. ft. (volume of space)÷50 cu.ft.=51.2 or 51,200(maximum Btu/Hr the space can support)

3. Add the Btu/Hr of all fuel burning appliances in the space.

Vent-free heater	_____	Btu/Hr
Gas water heater*	_____	Btu/Hr
Gas furnace	_____	Btu/Hr
Vented gas heater	_____	Btu/Hr
Gas heater logs	_____	Btu/Hr
Other gas appliances* +	_____	Btu/Hr
Total	= _____	Btu/Hr

Example:

Gas water heater	30,000	Btu/Hr
Vent-free heater	+ 26,000	Btu/Hr
Total	= 56,000	Btu/Hr

*Do not include direct-vent gas appliances. Direct-vent draws combustion air from the outdoors and vents to the outdoors.

4. Compare the maximum Btu/Hr the space can support with the actual amount of Btu/Hr used.

_____ Btu/Hr (maximum the space can support)
 _____ Btu/Hr (actual amount of Btu/Hr used)

Example : 51,200 Btu/Hr(maximum the space can support)
 56,000 Btu/Hr(actual amount of Btu/Hr used)

The space in the above example is a confined space because the actual Btu/Hr used is more than the maximum Btu/Hr the space can support.

You must provide additional fresh air. Your options are as follows:

- A. Rework worksheet, adding the space of an adjoining room. If the extra space provides an unconfined space, remove door to adjoining room or add ventilation grills between rooms. See *Ventilation Air From Inside Building*.
- B. Vent room directly to the outdoors. See *Ventilation Air From Outdoors*.
- C. Install a lower Btu/Hr heater, if lower Btu/Hr size makes room unconfined.

If the actual Btu/Hr used is less than the maximum Btu/Hr the space can support, the space is an unconfined space. You will need no additional fresh air ventilation.

NOTE: If the area in which the heater may be operated is smaller than that defined as an unconfined space or if the building is of unusually tight construction, provide adequate combustion and ventilation air by one of the methods described in the *National Fuel Gas Code, ANSI Z223.1, Section 5.3* or applicable local codes.

Ventilation Air From Inside Building

This fresh air would come from an adjoining unconfined space. When ventilating to an adjoining unconfined space, you must provide two permanent openings: one within 12" of the ceiling and one within 12" of the floor on the wall connecting the two spaces (see options 1 and 2, Figure 2). You can also remove door into adjoining room (see option 3, Figure 2). Follow the *National Fuel Gas Code, NFPA 54/ANSI Z223.1, Section 5.3, Air for Combustion and Ventilation* for required size of ventilation grills or ducts.

Ventilation Air From Outdoors

Provide extra fresh air by using ventilation grills or ducts. You must provide two permanent openings: one within 12" of the ceiling and one within 12" of the floor. Connect these items directly to the outdoors or spaces open to the outdoors. These spaces include attics and crawl spaces. Follow the *National Fuel Gas Code, NFPA 54/ANSI Z223.1, Section 5.3, Air for Combustion and Ventilation* for required size of ventilation grills or ducts.

IMPORTANT: Do not provide openings for inlet or outlet air into attic if attic has a thermostat-controlled power vent. Heated air entering the attic will activate the power vent.

Rework worksheet, adding the space of the adjoining unconfined space. The combined spaces must have enough fresh air to supply all appliances in both spaces.

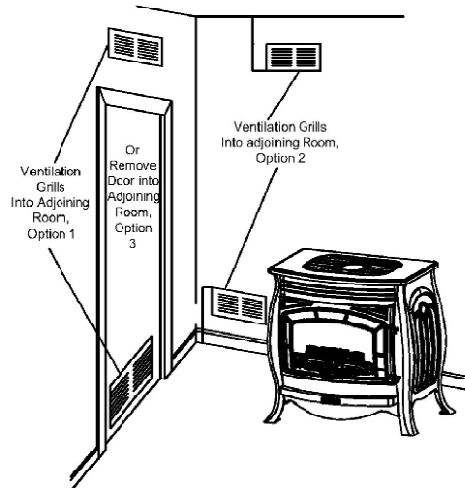

Figure 2 -Ventilation Air from Inside Building

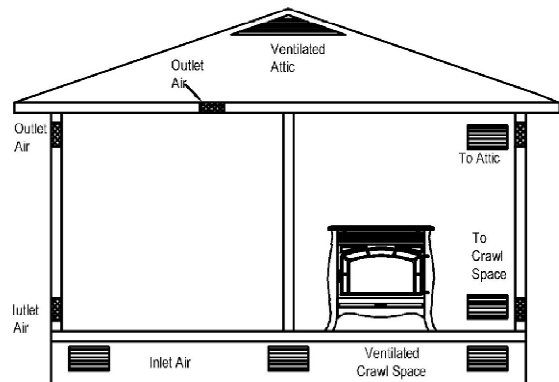

Figure 3 -Ventilation Air from Outdoors

INSTALLATION

NOTICE: This heater is intended for use as supplemental heat. Use this heater along with your primary heating system. Do not install this heater as your primary heat source. If you have a central heating system, you may run system's circulating blower while using heater. This will help circulate the heat throughout the house. In the event of a power outage, you can use this heater as your primary heat source.

IMPORTANT: Installing heater in rooms without enough ventilation air may cause mildew to form from too much moisture. See Air for Combustion and Ventilation, pages 5 and 6.

WARNING: A qualified service person must install heater. Follow all local codes.

WARNING

Electrical Grounding Instructions

This appliance is equipped with a three-prong (grounding) plug for your protection against shock hazard and should be plugged directly into a properly grounded three-prong receptacle.

WARNING: Never install the heater

- in a bedroom or bathroom
- in a recreational vehicle
- where curtains, furniture, clothing, or other flammable objects are less than 42 inches from the front, top, or sides of the heater
- in high traffic areas
- in windy or drafty areas

WARNING: Maintain the minimum clearances. If you can, provide greater clearances from floor, ceiling, and adjoining side and back walls.

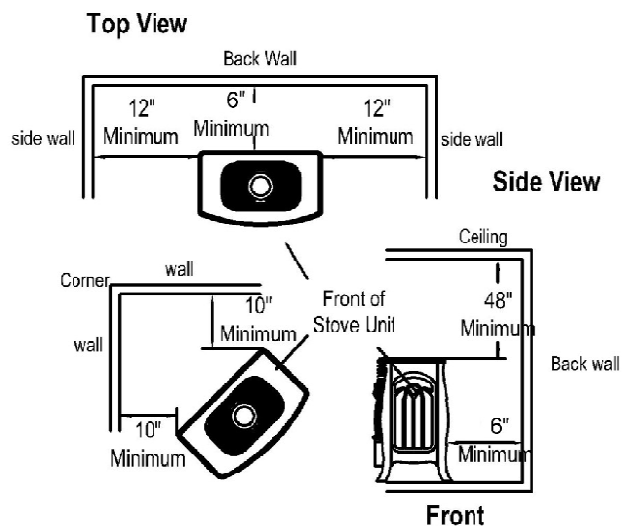
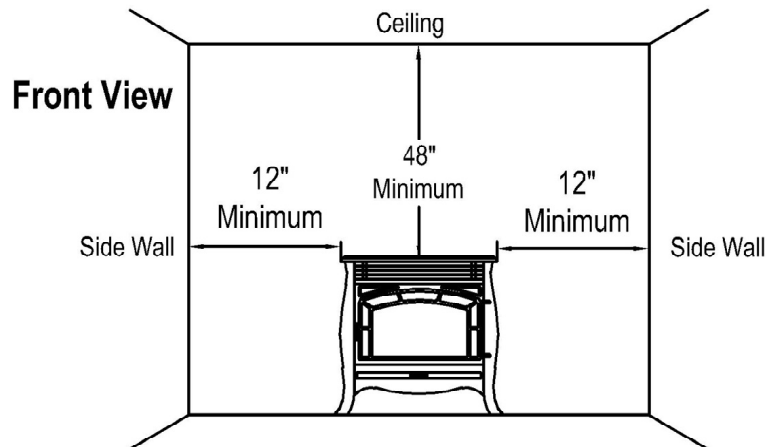

Figure 4 - Minimum Clearance to Wall and Ceiling

CAUTION: This heater creates warm air currents. These currents move heat to wall surfaces next to heater. Installing heater next to vinyl or cloth wall coverings or operating heater where impurities (such as tobacco smoke, aromatic candles, cleaning fluids, oil or kerosene lamps, etc.) in the air exist, may discolor walls.

CHECK GAS TYPE

Be sure your gas supply is right for your heater. Otherwise, call dealer where you bought the heater for proper type heater.

CLEARANCES TO COMBUSTIBLES

Carefully follow the instructions below. This stove is a freestanding unit designed to set directly on the floor.

IMPORTANT: You must maintain minimum wall and ceiling clearances during installation. The minimum clearances are shown in Figure 4. Measure from outermost point of stove top.

If heater is installed directly on carpeting, tile or other combustible material, other than wood flooring, the heater shall be installed on a metal or wood panel extending the full width and depth of the heater.

INSTALLATION

Continued

Minimum Wall and Ceiling Clearances

(see Figure 4)

- A. Clearances from outermost point of stove top to any combustible side wall should not be less than 12 inches.
- B. Clearances from outermost point of stove top to any combustible back wall should not be less than 6 inches (Includes corner installations).
- C. Clearances from the stove top to the ceiling should not be less than 48 inches.

CONNECTING TO GAS SUPPLY

WARNING: A qualified service person must connect heater to gas supply. Follow all local codes.

WARNING: This appliance requires a 3/8" NPT (National Pipe Thread) inlet connection to the pressure regulator.

WARNING: Never connect heater to private (non-utility) gas wells. This gas is commonly known as wellhead gas.

WARNING: Do not over tighten gas connections

CAUTION: Never connect heater directly to the gas supply. This heater requires an external regulator (not supplied). Install the external regulator between the heater and gas supply.

CAUTION: Use only new, black iron or steel pipe. Internally-tinned copper tubing may be used in certain areas. Check your local codes. Use pipe of 1/2" diameter or greater to allow proper gas volume to heater. If pipe is too small, undue loss of pressure will occur.

CAUTION: Use pipe joint sealant that is resistant to gas (PROPANE or NG).

CAUTION: Avoid damage to regulator. Hold gas regulator with wrench when connecting into gas piping and/or fittings.

INSTALLATION ITEMS NEEDED

Before installing heater, make sure you have the items listed below.

- piping (check local codes)
- sealant (resistant to propane/LP gas)
- equipment shutoff valve*
- test gauge connection*
- sediment trap
- tee joint
- pipe wrench
- flexible gas hose. (Check local codes)

*A CSA design-certified equipment shutoff valve with 1/8" NPT tap is an acceptable alternative to test gauge connection. Purchase the optional CSA design-certified equipment shutoff valve from your dealer.

The installer must supply an external regulator. The external regulator will reduce incoming gas pressure. If you do not reduce incoming gas pressure, heater regulator damage could occur. Install external regulator with the vent pointing down as shown in Figure 6. Pointing the vent down protects it from freezing rain or sleet.

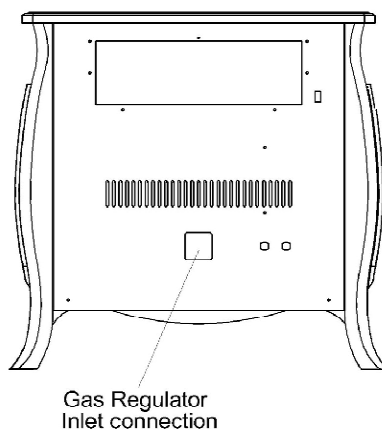

Figure 5 - Gas Regulator Location For Gas inlet Connection

LP Models:
11"-14" W.C. supply pressure
Gas supplier provides external regulator for propane gas.

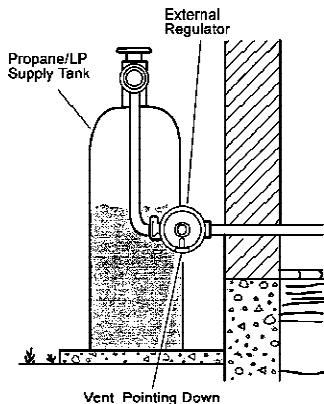

Figure 6 - External Regulator With Vent Pointing Down

NG Models:
5"-10.5" W.C. supply pressure
Gas supplier provides external regulator for natural gas.

* Purchase the optional CSA design-certified equipment shutoff valve from your dealer.

** Minimum inlet pressure for purpose of input adjustment.

In the State of Massachusetts the gas cock must be a T handle type. The State of Massachusetts requires that a flexible appliance connector cannot exceed three feet in length.

Installation must include an equipment shutoff valve, union, and plugged 1/8" NPT tap. Locate NPT tap within reach for test gauge hook up. NPT tap must be upstream from heater (see Figure 7).

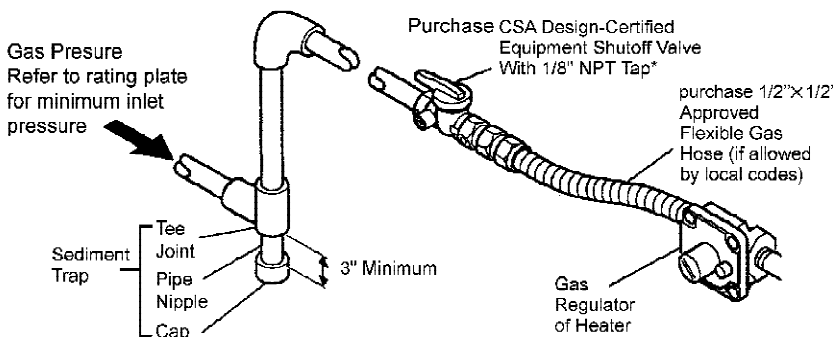

Figure 7 - Gas Connection

IMPORTANT: Install equipment shutoff valve in an accessible location. The equipment shutoff valve is for turning on or shutting off the gas to the appliance. Apply pipe joint sealant lightly to male threads. This will prevent excess sealant from going into pipe. Excess sealant in pipe could result in clogged heater valves.

We recommend that you install a sediment trap in supply line as shown in Figure 7. Locate sediment trap where it is within reach for cleaning. Install in piping system between fuel supply and heater. Locate sediment trap where trapped matter is not likely to freeze. A sediment trap traps moisture and contaminants. This keeps them from going into heater controls. If sediment trap is not installed or is installed incorrectly, heater may not run properly.

CHECKING GAS CONNECTIONS

WARNING: Test all gas piping and connections for leaks after installing or servicing. Correct all leaks at once.

WARNING: Never use an open flame to check for a leak. Apply a mixture of liquid soap and water to all joints. Bubbles forming show a leak. Correct all leaks at once.

CAUTION: Make sure external regulator has been installed between gas supply and heater. See guidelines under Connecting to Gas Supply.

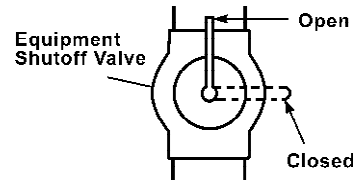

Figure 8 - Equipment Shutoff Valve

Pressure Testing Gas Supply Piping System Test Pressures In Excess Of 1/2 PSIG(3.5kPa)

1. Disconnect heater with its appliance main gas valve (control valve) and equipment shutoff valve from gas supply piping system. Pressures in excess of 1/2 PSIG will damage heater regulator.
2. Cap off open end of gas pipe where equipment shutoff valve was connected.
3. Pressurize supply piping system by either using compressed air or opening gas supply tank valve.
4. Check all joints of gas supply piping system. Apply mixture of liquid soap and water to gas joints. Bubbles forming show a leak.
5. Correct all leaks at once.
6. Reconnect heater and equipment shutoff valve to gas supply. Check reconnected fittings for leaks.

Test Pressures Equal To or Less Than 1/2 PSIG(3.5 kPa)

1. Close equipment shutoff valve (see Figure 8).
2. Pressurize supply piping system by either using compressed air or opening natural supply tank valve.
3. Check all joints from gas meter to equipment shutoff valve (see Figure 9). Apply mixture of liquid soap and water to gas joints. Bubbles forming show a leak.
4. Correct all leaks at once.

Pressure Testing Heater Gas Connections

1. Open equipment shutoff valve (see Figure 8).
2. Open gas supply tank valve.
3. Make sure control knob of heater is in the OFF position.
4. Check all joints from equipment shutoff valve to control valve (see Figure 9). Apply mixture of liquid soap and water to gas joints. Bubbles forming show a leak.

Pressure Testing Heater Gas Connections

Continued

5. Correct all leaks at once.
6. Light heater (see Operating Heater). Check all other internal joints for leaks.
7. Turn off heater (see To Turn Off Gas Appliance).

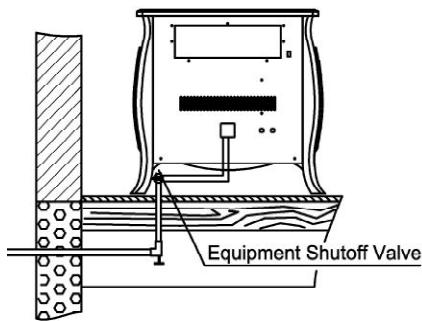

Figure 9 - Checking Gas Joints

LOG PLACEMENT

WARNING: Failure to position the parts in accordance with these diagrams or failure to use only parts specifically approved with this heater may result in property damage or personal injury.

CAUTION: After installation and periodically thereafter, check to ensure that no yellow flame comes in contact with any log. With the heater set to High, check to see if yellow flames contact any log. If so, reposition logs according to the log installation instructions in this manual. Yellow flames contacting logs will create soot.

It is very important to install the logs exactly as instructed. Do not modify logs. Only use logs supplied with heater.

Make sure log sits flat on firebox floor.

IMPORTANT: Make sure log does not cover any burner ports (see Figure 10).

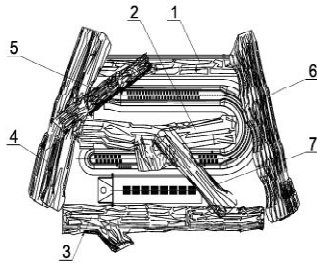

Figure 10- Installing Log Set (Top View)



FIG (1)



FIG (2)

STEP 1: Install log 1 onto the two slots in the rear plate.



FIG (3)

STEP 2: Install log 2 onto the two slots in the middle plate.

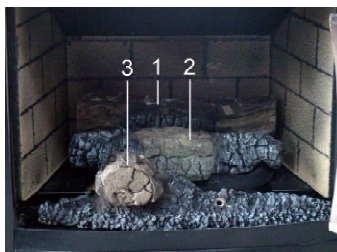

FIG (4)

STEP 3: Insert the two pins on the bottom of log 3 into the two holes on firebox floor.

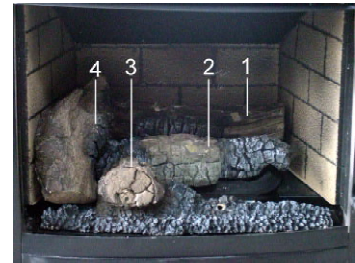

FIG (5)

STEP 4: Place log 4 on log 1 and log 3, as shown.

Note: Log 4 will contact inside of heater.

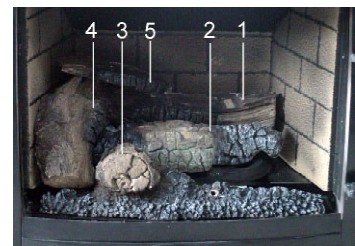

FIG (6)

STEP 5: Insert the recessed hole on the bottom of log 5 onto the pin on log 1, with the other end of log 5 placed on log 4, as shown.

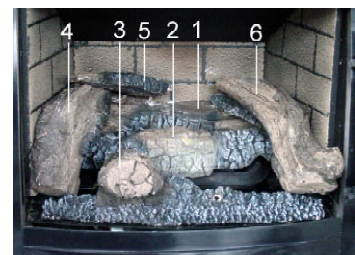

FIG (7)

STEP 6: Place log 6 on log 1 and log 3.

Note: Log 6 will contact inside of heater.

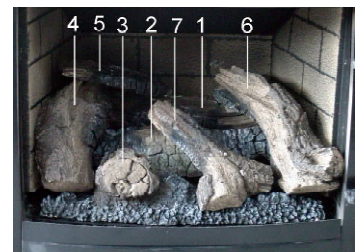

FIG (8)

STEP 7: Insert the recessed hole on the bottom of log 7 onto the pin on log 2, with the other end placed on log 3.

OPERATING HEATER

FOR YOUR SAFETY

READ BEFORE LIGHTING

WARNING: If you do not follow these instructions exactly, a fire or explosion may result causing property damage, personal injury or loss of life.

CAUTION: Do not try to adjust heating levels by using the equipment shutoff valve.

NOTICE: During initial operation of new heater, logs will give off a paper-burning smell. Orange flame will also be present. Open a window to vent smell. This will only last a few hours.

A. This appliance is equipped with an ignition device which automatically lights the pilot. Do not try to light the pilot by hand.

B. BEFORE LIGHTING smell all around the appliance area for gas. Be sure to smell next to the floor because some gas is heavier than air and will settle on the floor.

WHAT TO DO IF YOU SMELL GAS

- Do not try to light any appliance.
- Do not touch any electrical switch; do not use any phone in your building.
- Immediately call your gas supplier from a neighbor's phone. Follow the gas supplier's instructions.
- If you cannot reach your gas supplier, call the fire department.

C. Use only your hand to push control. Never use tools. If the appliance does not operate, don't try to repair it, call a qualified service technician or gas supplier. Force or attempted repair may result in a fire or explosion.

D. Do not use this appliance if any part has been under water. Immediately call a qualified service technician to inspect the appliance and to replace any part of the control system and any gas control which has been under water.

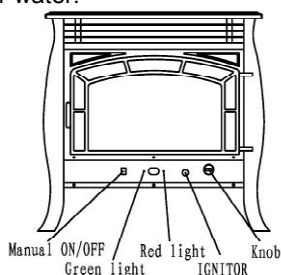

Figure 11 - Manual ON/OFF Button Location
(With access panel removed)

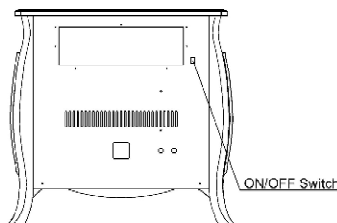

Figure 12 - On/Off Switch
Function of Manual ON/OFF Button and Power ON/OFF Switch

If your remote transmitter is lost or does not function, you can press the Manual ON/OFF Button on front of heater in order to manually operate your heater. (See Figure 11)

Note: To operate your heater the ON/OFF switch on back of heater must be in the ON position. The RED light on the front of heater indicates there is electrical power to your heater when the ON/OFF switch is in the ON position. The GREEN light on the front of heater indicates the pilot light is ON. (See Figure 12)

Note: Please wait for one minute to light again after shutting off heater.



REMOTE CONTROL OPERATING INSTRUCTION

Note: If operating by remote control, you must set the Control Knob on ELECTRIC position. (See Figure 11) Do not set the control knob between the locked position, otherwise there will be no power to the heater.

1. STOP! Read the safety information above.
2. Disconnect or turn off all electric power to heater.
3. This appliance is equipped with an ignition device which automatically lights the pilot. Do not try to light the pilot by hand.
4. Wait five (5) minutes to clear out any gas. Then smell for gas around heater including near floor. If you smell gas, **STOP!** Follow "B" in the safety information above. If you don't smell gas, go to the next step.
5. Plug into a properly grounded three-prong receptacle, and install three AAA batteries in remote. A high pitch sound will occur and red power light on front of heater will be lit.
6. Make sure Control Knob is in Electric Position.
7. Point remote at bottom front of heater, press IGN/OFF button, an electric spark will ignite the pilot, and green light on front of heater will be lit.

Note: When operating heater for the first time, the ignition period may be 30 seconds or longer. This will allow air to exit from the gas system.

Note: The pilot is located on back of front burner. If pilot does not stay lit, contact a qualified service person or gas supplier for repairs.

Note: If the  appears on the control board, press the  button, then press LOCK button to unlock.

OPERATING HEATER

Continued

- Press BURNER button for desired burner operation.
 AUTO: Burner will automatically turn on and off.
 MAN: Burner operates continuously.
- If the appliance will not operate, follow the instructions "To Turn Off Gas To Appliance" and call your service technician or gas supplier.

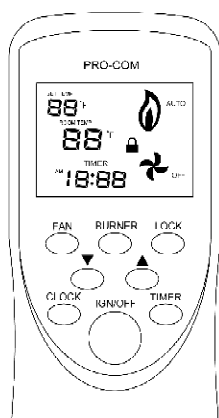

Fig 13 - Front of Remote Control

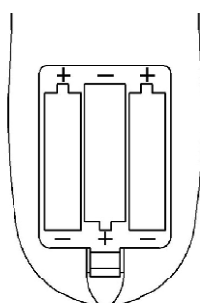

Fig 14 - Back of Remote Control (cover removed)

TO TURN OFF GAS TO APPLIANCE

Shut off heater

- Press the IGN/OFF button.
- Set Switch on OFF position or unplug the electric power to the heater. (See Figure 12)

SETTING CLOCK

Press CLOCK button for hours or minutes. Press ▲ or ▼ for correct time. Press CLOCK button again to set time.

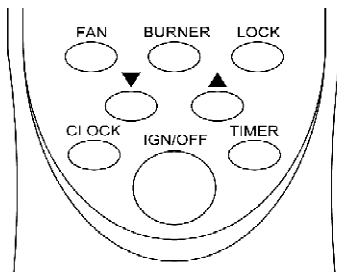

Fig 15 - Control board

SETTING TIMER

1. AUTO ON:

With burner off, press TIMER button. Then press ▲ or ▼ to change to the scheduled time, then press the TIMER button again, the TIMER starts timing and the TIMER will flash and the green operation light flashes. Burner will automatically come on at set time.

2. AUTO OFF:

With burner operating, press TIMER button. Then press ▲ or ▼ to change to the scheduled time, then press the TIMER button again, the TIMER starts timing and the TIMER will flash and the green operation flashes. Burner will automatically shut off at set time.

SETTING TEMPERATURE

With burner is on "Auto" position, press ▲ or ▼ to change to the desired temperature.

LOCKING REMOTE CONTROL (child proof)

1. Key press locking:

Press LOCK button, a  symbol will appear on the LCD.

2. Key-press unlocking:

Press ▼, then press LOCK button to unlock.

OPERATING FAN

Press FAN button for desired fan operation.

AUTO: Blower will come on several minutes after burner comes on and will go off several minutes after burner goes off.

MAN: Blower operates continuously.

OFF: Blower is off.

MANUAL OPERATING INSTRUCTIONS

We provide the manual control system just in case of power shortage.



Install battery for Manual Ignitor:

- Unscrew the ignitor cap.
- Insert a AAA type battery with its anode ("+") pointing out.
- Screw the ignitor cap back.

Note: We recommend that the battery be taken out of the ignitor when the power supply gets right.

LIGHTING INSTRUCTIONS

If power is off, you can operate the fireplace manually.

- STOP! Read the safety information on page 11.
- Check that gas supply to heater is on.
- Open bottom front access panel.
- Push in gas Control Knob slightly and turn clockwise  to the OFF position. If Control Knob is on ELECTRIC position, press in the Control Knob and turn counterclockwise  to OFF position.

NOTE: Knob cannot be turned from PILOT/IGN to "OFF" unless knob is pushed in slightly. Do not force.

MANUAL OPERATING INSTRUCTIONS

Continued

5. Wait five (5) minutes to clear out any gas. Then smell for gas, including near the floor. If you smell gas, **STOP!** Follow "B" in the safety information on page 11. If you do not smell gas, go to the next step.
6. Push in gas control slightly and turn counterclockwise ↶ to PILOT/IGN and depress for five (5) seconds.

NOTE: The first time that the heater is operated after connecting the gas supply, the control knob should be depressed for about thirty (30) seconds. This will allow air to bleed from the gas system.

7. With Control Knob pressed in, push and release the ignitor button. This will light the pilot. If needed, keep pressing ignitor button until pilot lights.
8. Keep Control Knob depressed for ten (10) seconds after lighting pilot. If pilot goes out, repeat steps 6, 7 and 8.
9. Turn counterclockwise ↶ to "ON" position. Do not operate between locked positions.

TO TURN OFF GAS TO APPLIANCE

Push in gas Control Knob slightly and turn clockwise ↷ the OFF position. Do not force.

When electric power is available and electric operation is desired, turn clockwise ↷ to OFF position for one minute. Then press down knob and rotate clockwise ↷ to ELECTRIC position.

Do not operate between locked position.

MANUAL LIGHTING PROCEDURE (match light)

1. Open front door.
2. Follow steps 1 through 5 under *MANUAL OPERATING Lighting Instructions*.
3. With Control Knob in PILOT/IGN position, strike match, and hold near pilot. Press in Control Knob, pilot should light.
4. Keep Control Knob pressed in for 30 seconds after lighting pilot. After 30 seconds, release Control Knob. Follow step 9 under *MANUAL OPERATING Lighting Instructions*.

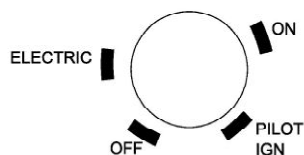

Figure 16 - Manual Control

INSPECTING FLAME PATTERN

Check pilot flame pattern and burner flame patterns often.

PILOT FLAME PATTERN

Figure 17 shows a correct pilot flame pattern. Figure 18 shows an incorrect pilot flame pattern. The incorrect pilot flame is not touching the thermocouple. This will cause the thermocouple to cool. When the thermocouple cools, the heater will shut down. If pilot flame pattern is incorrect, as shown in Figure 18.

- Turn heater off (see TO TURN OFF GAS TO APPLIANCE)
- See *troubleshooting*

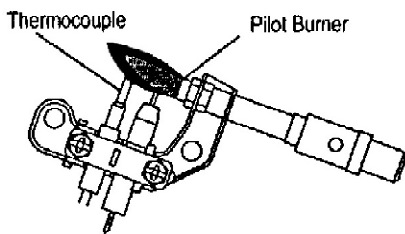

Figure 17 - Correct Pilot Flame Pattern

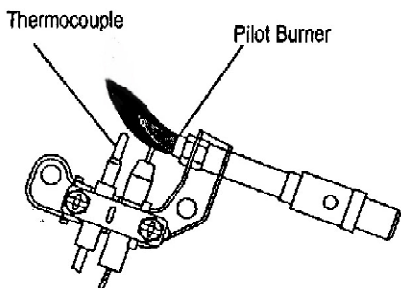

Figure 18 - Incorrect Pilot Flame Pattern

BURNER FLAME PATTERN

Figure 19 shows a correct burner flame pattern. Figure 20 shows an incorrect burner flame pattern. If burner flame is incorrect:

- Turn heater off (see TO TURN OFF GAS TO APPLIANCE)
- See *troubleshooting*

Approx. 3-6" Above
Top of logs



Figure 19 - Correct Flame Pattern with heater set to High Flame

More Than 8"
Above Top of logs

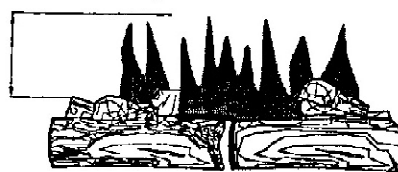

Figure 20 - Incorrect Flame Pattern with heater set to High Flame

CLEANING AND MAINTENANCE

WARNING: Disconnect power before attempting any maintenance or cleaning to reduce the risk of fire, electric shock or personal injury. Turn off heater and let cool before cleaning.

WARNING: Failure to keep primary/air openings of burners clean may result in sooting and property damage.

CAUTION: Label all wires prior to disconnection when servicing controls. Wiring errors can cause improper and dangerous operation. Verify proper operation after servicing.

CAUTION: You must keep control areas, burner, and circulating air passageways of heater clean. Inspect these areas of heater before each use. Have heater inspected yearly by a qualified service person. Heater may need more frequent cleaning due to excessive lint from carpeting, bedding material, pet hair, etc.

DISCONNECT WIRING OR CONTROL MODULE

1. Remove screws from the rear control panel, take out thermostat sensing bulb from the clip, then disconnect the wires from control module.
2. Remove two screws and hex nuts, securing control module. When installing, reverse the steps above. (See Figure 21 and Figure 25)

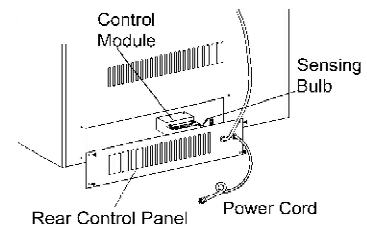

Figure 21 - Control Module Access

DISCONNECT FAN

1. Remove screws from the fan bracket panel, pull the fan bracket panel out to remove. Disconnect two wires from fan T-stat Switch.
2. Mark or tag each wire removed for its exact reconnection. Remove the four screws from the fan. When installing, reverse the steps above. (See Figure 22 and Figure 25)

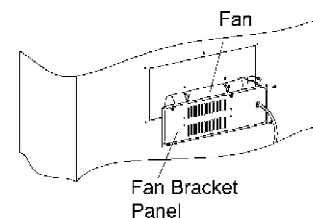

Figure 22 - Fan Access

CLEANING BURNER INJECTOR HOLDER AND PILOT AIR INLET HOLE

We recommend that you clean the unit every 2,500 hours of operation or every three months.

The primary air inlet holes allow the proper amount of air to mix with the gas. This provides a clean burning flame. Keep these holes clear of dust, dirt, lint, and pet hair. Clean these air inlet holes prior to each heating season. Blocked air holes will create soot. We recommend that you clean the unit every three months during operation and have heater inspected yearly by a qualified service person.

We recommend you keep the burner and pilot assembly clean and free of dust and dirt.

To clean these parts we recommend using compressed air no greater than 30 PSI. Your local computer store, hardware store, or home center may carry compressed air in a can. You can use a vacuum cleaner in the blow position. If using compressed air in a can, please follow the directions on the can. If you don't follow directions on the can, you could damage the pilot assembly.

1. Shut off the unit, including the pilot. Allow the unit to cool for at least thirty minutes.
2. Inspect burner, pilot and primary air inlet holes on injector holder for dust and dirt (See Figure 23).
3. Blow air through the ports/slots and holes in the burner.
4. Check the injector holder located at the end of the burner tube again. Remove any large particles of dust, dirt, lint, or pet hair with a soft cloth or vacuum cleaner nozzle.
5. Blow air into the primary air inlet holes on the injector holder.
6. In case any large clumps of dust have now been pushed into the burner repeat steps 3 and 4.

Clean the pilot assembly also. A yellow tip on the pilot flame indicates dust and dirt in the pilot assembly. There is a small air inlet hole about two inches from where the pilot flame comes out of the pilot assembly (see Figure 24). With the unit off, lightly blow air through the air inlet hole. You may blow through a drinking straw if compressed air is not available.

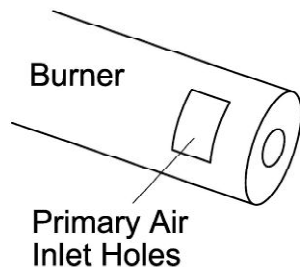

Figure 23 - Burner Primary Air Inlet

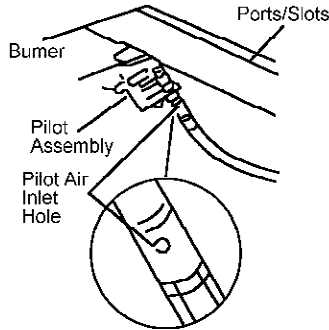

Figure 24 - Pilot Air Inlet Hole

MAINBURNER

Periodically inspect all burner flame holes with the heater running. All slotted burner flame holes should be open with yellow flame present. All round burner flame holes should be open with a small blue flame present. Some burner flame holes may become blocked by debris or rust, with no flame present. If so, turn off heater and let cool. Either remove blockage or replace burner. Blocked burner flame holes will create soot.

CABINET

Air Passageways

- Use a vacuum cleaner or pressurized air to clean.

Exterior

- Use a soft cloth dampened with a mild soap and water mixture. Wipe the cabinet to remove dust.

Logs

- If you remove logs for cleaning, refer to Installing Logs to properly replace logs.
- Replace logs if broken or chipped (dime size or larger).

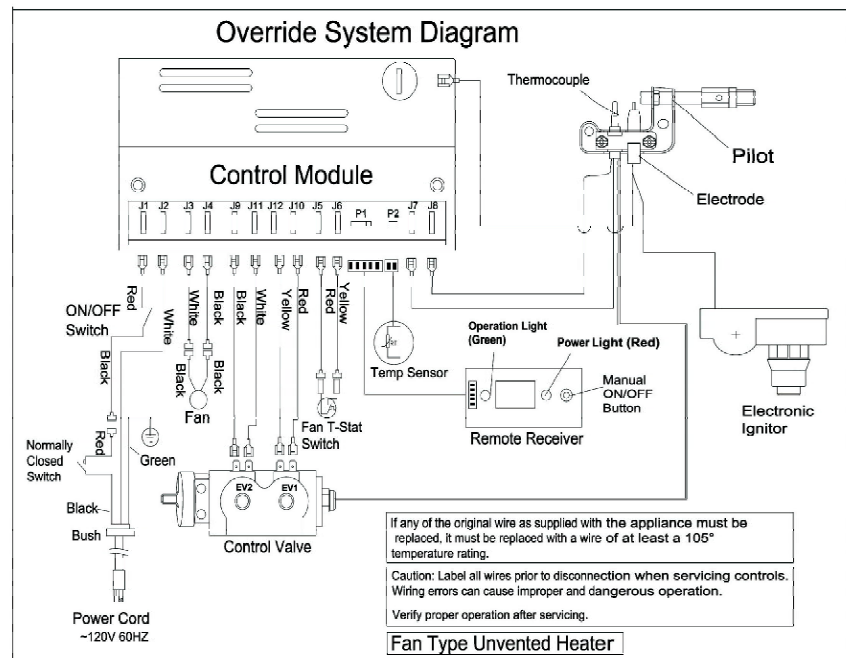

Figure 25 - Override Control System Diagram

REPLACEMENT PARTS

Use only original replacement parts. This will protect your warranty coverage for parts replaced under warranty.

PARTS UNDER WARRANTY

Contact authorized dealers of this product. If they can't supply original replacement part(s) call the number on the back of manual. When contacting your dealer or PRO-COM, have ready:

- Your name
- Your address
- Model and serial numbers of your heater
- How heater was malfunctioning
- Type of gas used (Propane/LP or Natural gas/NG)
- Purchase date
- Warranty card.

Usually, we will ask you to return the defective part to the factory.

PARTS NOT UNDER WARRANTY

Contact authorized dealers of this product. If they can't supply original replacement part(s) call PRO-COM's toll-free number (877)886-5989.

TECHNICAL SERVICE

For questions about installation, operation, or troubleshooting, contact PRO-COM toll -free at (877)886-5989.

ACCESSORIES

Purchase these heater accessories from your local dealer. If they can not supply these accessories, contact PRO-COM for information. You can also write to the address listed on the front of this manual.

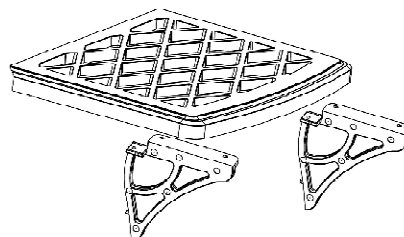

SIDE SHELF

SPECIFICATIONS

	SSU320RHL-GB	SSU320RHN-GB
	SSU320RHL-B	SSU320RHN-B
	SSU320RHL-G	SSU320RHN-G
	SSU320RHL-S	SSU320RHN-S
Btu (Variable)	32,000	32,000
Gas Type	LP Gas	Natural Gas
Ignition	Automatic or Electronic	Automatic or Electronic
Manifold Pressure	9" W.C.	4" W.C.
Inlet Gas Pressure (In. of water)*		
Maximum	14"	10.5"
Minimum	11"	5"
Dimensions, Inches (H×W×D)		
Heater	26 1/8"×42 5/16" ×16 7/8"	26 1/8"×42 5/16" ×16 7/8"
Carton	18 7/8"×35 7/16" ×30"	18 7/8"×35 7/16" ×30"
Weight, lbs		
Stove	108	108
Shipping	117	117
Volts	120	120
Watts	32	32

*For purposes of input adjustment

TROUBLESHOOTING

NOTE: BEFORE YOU SWITCH TO “ELECTRIC” CONTROL LEVEL FROM MANUAL CONTROL, YOU NEED TO TURN THE KNOB TO “OFF” LEVEL FIRST AND WAIT FOR ONE MINUTE, THEN TURN THE KNOB TO “ELECTRIC”.

IN CASE OF “ELECTRONIC” CONTROL LEVEL DOES NOT WORK, PLEASE TURN THE CONTROL KNOB COUNTERCLOCKWISE TO “OFF” LEVEL AND WAIT FOR ONE MINUTE.

- ⚠ WARNING:** If you smell gas
- Shut off gas supply.
 - Do not try to light any appliance.
 - Do not touch any electrical switch; do not use any phone in your building.
 - Immediately call your gas supplier from a neighbor’s phone. Follow the gas supplier’s instructions.
 - If you cannot reach your gas supplier, call the fire department.

⚠ WARNING: Make sure that power is turn off before proceeding.

⚠ WARNING: Turn off and let cool before servicing. Only a qualified service person should service and repair heater.

⚠ CAUTION: Never use a wire, needle, or similar object to clean ODS/pilot. This can damage ODS/pilot unit.

OBSERVED PROBLEM	POSSIBLE CAUSE	REMEDY
No spark when IGN/OFF is pressed	<ol style="list-style-type: none"> 1. No power to heater 2. No battery in remote control or battery isn’t correct orientation 3. ON/OFF switch not ON 4. Wire is damaged or loose 5. Pilot electrode position is not correct 6. System halt 	<ol style="list-style-type: none"> 1. Check the electric power 2. Place or replace the battery 3. Turn ON/OFF switch ON 4. Check the wire for damage and make sure connection is tight 5. Replace Pilot 6. Place the control knob of manual override on OFF position for at least 1 minute, then turn to ELECTRIC position
Spark at ODS/pilot but no ignition	<ol style="list-style-type: none"> 1. Gas supply turned off or equipment shutoff valve closed 2. Air in gas lines when installed 3. Depleted gas supply 4. ODS/pilot is clogged 5. Gas inlet supply pressure not correct 6. Wire is damaged or loose 7. Pilot electrode position is not correct 8. Gas valve or regulator is damaged 	<ol style="list-style-type: none"> 1. Turn on gas supply or open equipment shutoff valve 2. Press ON/OFF button again until air is removed 3. Contact local gas company 4. Clean ODS/pilot (see <i>Cleaning and Maintenance</i>, page 14) 5. Have qualified service technician check inlet pressure 6. Check the wire and make wire correct 7. Replace Pilot 8. Contact dealer or PROCOM
ODS/pilot has flame but continues to spark	<ol style="list-style-type: none"> 1. Thermocouple connection loose 2. Low gas pressure 3. Dirty or partially clogged ODS pilot 4. Thermocouple damaged 5. Gas valve or regulator damaged 	<ol style="list-style-type: none"> 1. Check that connectors are secure on module 2. Contact local gas company 3. Clean ODS/pilot (see <i>Cleaning and Maintenance</i>, page 14) 4. Replace thermocouple 5. Contact dealer or PROCOM

TROUBLESHOOTING *Continued*

OBSERVED PROBLEM	POSSIBLE CAUSE	REMEDY
ODS/pilot has flame but burner does not light	<ol style="list-style-type: none"> 1. Burner injector clogged 2. Inlet gas pressure is too low 3. Thermocouple leads disconnected or improperly connected 4. Batteries weak 	<ol style="list-style-type: none"> 1. Clean burner (<i>see Cleaning and Maintenance</i>, page 14) or replace burner injector 2. Contact local gas company 3. Reconnect leads (<i>see wiring diagram</i>) 4. Replace batteries
Delayed ignition at burner	<ol style="list-style-type: none"> 1. Manifold pressure is too low 2. Burner parts or injector clogged 	<ol style="list-style-type: none"> 1. Contact local gas company 2. Clean burner (<i>see Cleaning and Maintenance</i>, page 14)
Burner backfiring during combustion	<ol style="list-style-type: none"> 1. Damaged burner injector 2. Excessive supply pressure damaged regulator 	<ol style="list-style-type: none"> 1. Clean burner injector (<i>see Cleaning and Maintenance</i>, page 14) 2. Replace gas regulator
Slight smoke or odor during initial operation	<ol style="list-style-type: none"> 1. Residues from manufacturing processes 2. Not enough air 3. Excessive supply pressure damaged regulator 	<ol style="list-style-type: none"> 1. Problem will stop after a few hours of operation. 2. Check burner for dirt and debris. If found, clean burner. (<i>See Cleaning and Maintenance</i>, page 14) 3. Replace gas regulator
Dark residue on logs or inside of fireplace	<ol style="list-style-type: none"> 1. Improper log placement 2. Air holes at burner inlet blocked 3. Burner flame holes blocked 	<ol style="list-style-type: none"> 1. Properly locate logs (<i>see Log Placement</i>, page 10) 2. Clean out air holes at burner inlet. Periodically repeat as needed 3. Remove blockage or replace burner
Heater produces a clicking/ticking noise just after burner is lit or shut off	<ol style="list-style-type: none"> 1. Metal expanding while heating or contracting while cooling 	<ol style="list-style-type: none"> 1. This is common with most heaters. If noise is excessive, contact qualified service person
White powder residue forming within burner box or on adjacent walls or furniture	<ol style="list-style-type: none"> 1. Heated vapors from furniture polish, wax, carpet cleaners, etc. turn into white powder residue 	<ol style="list-style-type: none"> 1. Turn heater off when using furniture polish, wax, carpet cleaner, or similar products

TROUBLESHOOTING

Continued

OBSERVED PROBLEM	POSSIBLE CAUSE	REMEDY
Heater produces unwanted odors	<ol style="list-style-type: none"> 1. Heater is burning vapors from paint, hair spray, glues, etc. (See IMPORTANT statement at beginning of troubleshooting) 2. Gas leak. See WARNING Statement at beginning of troubleshooting 	<ol style="list-style-type: none"> 1. Ventilate room. Stop using odor causing products while heater is running 2. Locate and correct all leaks (see Checking Gas Connections, Page 9)
Heater shuts off in use (ODS operates)	<ol style="list-style-type: none"> 1. Not enough fresh air is available 2. Low line pressure 3. ODS/pilot is partially clogged 	<ol style="list-style-type: none"> 1. Open window and/or door for, ventilation 2. Contact local propane/LP gas company 3. Clean ODS/pilot (see Cleaning Page 14)
Gas odor exists even when heater is shut off	<ol style="list-style-type: none"> 1. Gas leak. See WARNING Statement at beginning of troubleshooting 	<ol style="list-style-type: none"> 1. Locate and correct all leaks (see Checking Gas Connections, Page 9)
Gas odor during combustion	<ol style="list-style-type: none"> 1. Foreign matter between control valve and burner 2. Gas leak. See WARNING Statement at beginning of troubleshooting 	<ol style="list-style-type: none"> 1. Remove foreign matter 2. Locate and correct all leaks (see Checking Gas Connections, Page 9)
Moisture/condensation on windows	<ol style="list-style-type: none"> 1. Not enough combustion/ventilation air 	<ol style="list-style-type: none"> 1. Refer to Air for Combustion and Ventilation requirements, Page 5

ILLUSTRATED PARTS BREAKDOWN

SSU320RHN-GB SSU320RHL-GB
SSU320RHN-B SSU320RHL-B
SSU320RHN-G SSU320RHL-G
SSU320RHN-S SSU320RHL-S

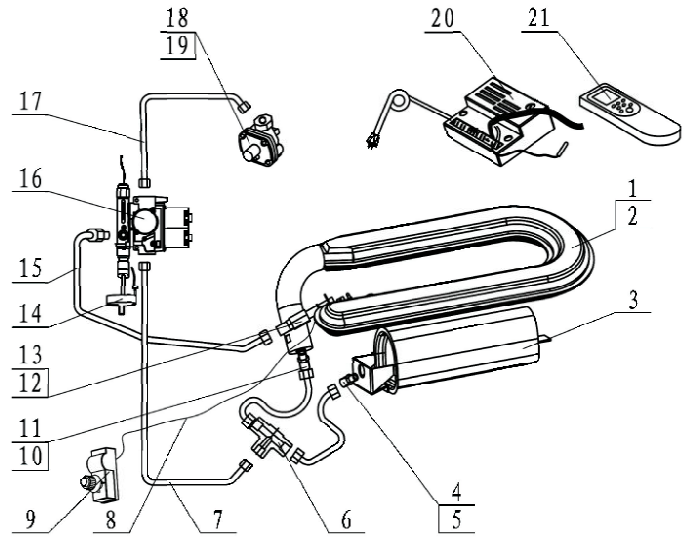

Key No.	Part Number	Description	QTY	
			NG	LP
1	SLU35A410(NG)	BURNER ASSEMBLY	1	
2	SLU35A410(LP)	BURNER ASSEMBLY		1
3	SLU35A420	BURNER ASSEMBLY	1	1
4	ML091-05	INJECTOR	1	
5	ML091-10	INJECTOR		1
6	ML056-04	CONNECTOR	1	1
7	SLU35A031	OUTLET TUBE	1	1
8	NAY03-05-01	IGNITOR CABLE	1	1
9	AL092-01	IGNITOR	1	1
10	QL027-02	INJECTOR	1	
11	QL028-02	INJECTOR		1
12	ND4703X400-RH	ODS	1	
13	ND4908X400-RH	ODS		1
14	MCL08-01	KNOB	1	1
15	SL035A032	ODS INLET TUBE	1	1
16	NV2020-22	GAS VALVE	1	1
17	SLU35A020	INLET TUBE ASSEMBLY	1	1
18	NRV82FB-4	REGULATOR	1	
19	NRV82FB-9	REGULATOR		1
20	NAYB02-00	ELECTRONIC MODULE	1	1
21	NAYB01-00	REMOTE CONTROL	1	1

ILLUSTRATED PARTS BREAKDOWN

SSU320RHN-GB **SSU320RHL-GB**
SSU320RHN-B **SSU320RHL-B**
SSU320RHN-G **SSU320RHL-G**
SSU320RHN-S **SSU320RHL-S**

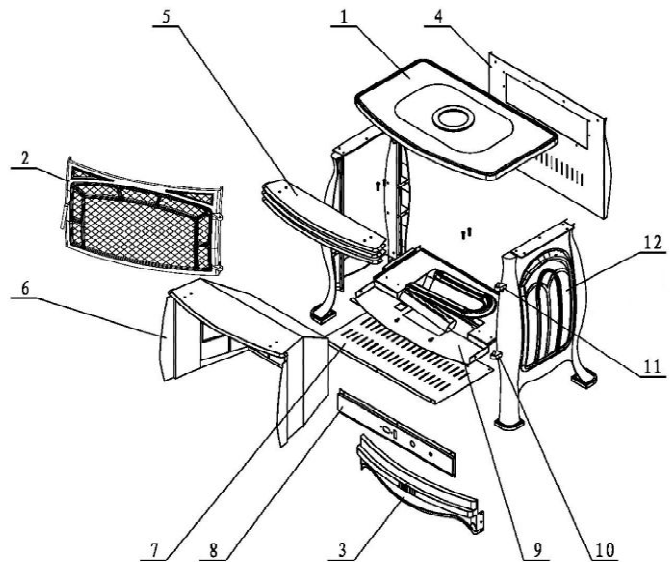

Key No.	Part Number	Description	QTY			
			SSU320RHN-GB SSU320RHL-GB	SSU320RHN-B SSU320RHL-B	SSU320RHN-G SSU320RHL-G	SSU320RHN-S SSU320RHL-S
1	SLU35A102-GB	TOP	1			
	SLU35A102-B	TOP		1		
	SLU35A102-G	TOP			1	
	SLU35A102-S	TOP				1
2	SLU35A130-GB	DOOR WITH SCREEN	1			
	SLU35A130-B	DOOR WITH SCREEN		1		
	SLU35A130-G	DOOR WITH SCREEN			1	
	SLU35A130-S	DOOR WITH SCREEN				1
3	SLU35A106-GB	ACCESS PANEL	1			
	SLU35A106-B	ACCESS PANEL		1		
	SLU35A106-G	ACCESS PANEL			1	
	SLU35A106-S	ACCESS PANEL				1
4	SLU35A101C	BACK	1	1	1	1
5	SLU35A103	LOUVER ASSEMBLY	1	1	1	1
6	SLU35A201	FIREBOX ASSEMBLY	1	1	1	1
7	SLU35A108	CABINET BOTTOM	1	1	1	1
8	SLU35A116	LOWER FRONT PANEL	1	1	1	1
9	SLU35A401	FIREBOX FLOOR	1	1	1	1
10	SLU35A132	DOOR HINGE	1	1	1	1
11	SLU35A131	DOOR HINGE	1	1	1	1
12	SLU35A105	SIDE	2	2	2	2

