

# Service Manual

Digital Video Camcorder

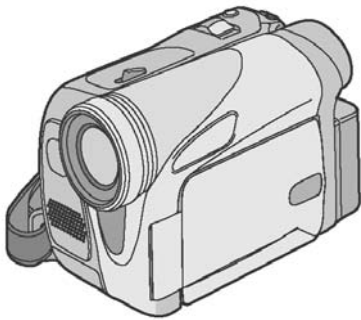

PbF  
Solder Lead free

NV-GS6EE  
NV-GS6GC  
NV-GS17E  
NV-GS17EB  
NV-GS17EF  
NV-GS17EG  
NV-GS17EP  
NV-GS18E  
NV-GS21E  
NV-GS21EB  
NV-GS21EG  
NV-GS21EK  
NV-GS21EP  
NV-GS25GC  
NV-GS25GN  
NV-GS28GK  
NV-GS35E  
NV-GS35EB  
NV-GS35EG  
NV-GS35EP  
NV-GS35GC  
NV-GS35GN  
NV-GS38GK

**Panasonic**

© 2005 Matsushita Electric Industrial Co., Ltd. All rights reserved. Unauthorized copying and distribution is a violation of law.

Vol. 1

(S).....Silver Type

Colours

ITEM	SPECIFICATION	1	2	3	4	5	ITEM	SPECIFICATION	1	2	3	4	5
Power	Digital Video Camera: Power Source: DC 7.5/2 V Power Consumption (Recording): 2.6 W (When using viewfinder) 3.2 W (When using LCD monitor)						Speaker	1 round speaker Ø 20 mm					
	AC adaptor: Power Source: AC 110-240 V, 50/60 Hz Power Consumption: 19 W DC Output: DC 7.5 V, 1.4 A (Movie camera operation) DC 8.4 V, 0.65 A (Battery charging)						Standard illumination	1,400 lx					
Recording format	Mini DV (Consumer-use digital video SD format)						Minimum required illumination	2 lx (Colour Night View Mode)					
Tape used	6.35 mm digital video tape						Output level	Video output level: 1.0 Vp-p, 75 ohm S-Video output level: Y Output: 1.0 Vp-p, 75 ohm C Output: 0.3 Vp-p, 75 ohm Audio output level (Line): 316 mV, 600 ohm					
Recording/playback time	SP: 80 min.; LP: 120 min. (with DVM80)						Mic input	Mic sensitivity -50 dB (0 dB=1 V/Pa, 1 kHz) (Stereo mini jack)					
Video recording system	Digital component						USB	Card reader/writer function, USB 2.0 compliant (Full-Speed) (Hi-Speed) No copyright protection support					
Television system	CCIR: 625 lines, 50 fields PAL colour signal						Digital interface	DV output terminal (IEEE1394, 4-pin)					
Audio recording system	PCM digital recording 16 bit (48 kHz/2ch), 12 bit (32 kHz/4ch)						Card memory functions	Recording media: SD Memory Card (8 MB/16 MB/32 MB/64 MB/128 MB/256 MB/ 512 MB/1 GB (Maximum)) Still picture recording file format: JPEG (Design rule for Camera File system, based on Exif 2.2 standard), DPOF corresponding Still picture size: VGA recording: 640 X 480					
Image sensor	1/6-inch CCD image sensor						WEB camera	Compression: Motion JPEG Image size: 320 X 240 pixels (QVGA)					
Lens	Auto Iris, F1.8, Focal length: 2.1 mm - 42 mm 2.1 mm - 50.4 mm 1.9 mm - 57 mm						Operating condition	0 °C-40 °C (Temperature) 10 %-80 % (Humidity)					
	Macro (Full range AF)						Weight	Digital Video Camera: 410 g (without supplied battery, DV cassette and lens cap) 480 g (with supplied battery, DV cassette and lens cap) AC adaptor: 110 g					
Filter diameter	30.5 mm						Dimensions	Digital Video Camera: 63.5 mm x 81 mm x 114 mm (W x H x D) AC adaptor: 61 mm x 32 mm x 91 mm (W x H x D)					
Zoom	20:1 Power zoom 24:1 Power zoom 30:1 Power zoom						Solder	This model uses lead free solder (PbF).					
Monitor	2.5-inch LCD												
Viewfinder	Electronic viewfinder Color electronic viewfinder												
Microphone	Stereo (with a zoom function)												

1. NV-GS6EE/ NV-GS6GC
2. NV-GS17EG/ NV-GS17EB/ NV-GS17EF/ NV-GS17E/ NV-GS17EP/ NV-GS17EB  
NV-GS18E
3. NV-GS21EG/ NV-GS21EK/ NV-GS21E/ NV-GS21EP/ NV-GS21EB
4. NV-GS25GC/ NV-GS25GN/ NV-GS28GK
5. NV-GS35EG/ NV-GS35E/ NV-GS35EP/ NV-GS35EB/ NV-GS35GC/ NV-GS35GN/ NV-GS38GK

Weight and dimensions shown are approximate.  
Designs and specifications are subject to change without notice.

**⚠ WARNING**

This service information is designed for experienced repair technicians only and is not designed for use by the general public. It does not contain warnings or cautions to advise non-technical individuals of potential dangers in attempting to service a product. Products powered by electricity should be serviced or repaired only by experienced professional technicians. Any attempt to service or repair the product or products dealt with in this service information by anyone else could result in serious injury or death.

**CONTENTS**

	Page		Page
<b>1 INTRODUCTION</b> .....	<b>4</b>	10.2. FRONT SCHEMATIC DIAGRAM .....	68
1.1. INTRODUCTION .....	4	10.3. JACK SCHEMATIC DIAGRAM .....	69
1.2. CAUTION FOR AC CORD(VJA0940 TYPE) .....	4	10.4. LCD BACKLIGHT SCHEMATIC DIAGRAM .....	70
1.3. CAUTION FOR AC MAINS LEAD .....	4	10.5. EVF BACKLIGHT / CASSETTE COVER SCHEMATIC DIAGRAMS .....	71
<b>2 SAFETY PRECAUTIONS</b> .....	<b>6</b>	10.6. CCD / SIDE CASE R / LCD SW SCHEMATIC DIAGRAMS .....	72
<b>3 PREVENTION OF ELECTRO STATIC DISCHARGE (ESD) TO ELECTROSTATICALLY SENSITIVE (ES) DEVICES</b> .....	<b>7</b>	10.7. INTERCONNECTION SCHEMATIC DIAGRAM .....	73
<b>4 ABOUT LEAD FREE SOLDER (PbF)</b> .....	<b>7</b>	10.8. VOLTAGE CHART .....	74
<b>5 OPERATION GUIDE</b> .....	<b>8</b>	<b>11 CIRCUIT BOARD LAYOUT</b> .....	<b>75</b>
<b>6 HOW TO REPLACE THE LITHIUM BATTERY</b> .....	<b>22</b>	11.1. FRONT C.B.A. ....	75
<b>7 SERVICE NOTES (PLEASE READ)</b> .....	<b>23</b>	11.2. JACK C.B.A. ....	76
7.1. SERVICE NOTES .....	23	11.3. LCD BACKLIGHT C.B.A. ....	77
<b>8 DISASSEMBLY/ASSEMBLY PROCEDURES</b> .....	<b>34</b>	<b>12 BLOCK DIAGRAMS</b> .....	<b>79</b>
8.1. CABINET SECTION .....	34	<b>13 EXPLODED VIEWS</b> .....	<b>93</b>
8.2. MECHANISM SECTION .....	53	13.1. MAIN PARTS SECTION .....	93
<b>9 ADJUSTMENT PROCEDURES</b> .....	<b>57</b>	13.2. FRONT AND BOTTOM CASE SECTION .....	94
9.1. SERVICE FIXTURES & TOOLS .....	57	13.3. SIDE CASE R AND LCD SECTION .....	95
9.2. MECHANICAL ADJUSTMENT .....	59	13.4. CCD AND LENS SECTION .....	96
9.3. ELECTRICAL ADJUSTMENT .....	60	13.5. EVF SECTION .....	97
<b>10 SCHEMATIC DIAGRAMS</b> .....	<b>67</b>	13.6. MECHANISM SECTION .....	98
10.1. SCHEMATIC DIAGRAM & CIRCUIT BOARD LAYOUT NOTES .....	67	13.7. PACKING PARTS AND ACCESSORIES SECTION .....	99

**14 REPLACEMENT PARTS LISTS ..... 100**  
14.1. MECHANICAL REPLACEMENT PARTS LIST ..... 100

14.2. ELECTRICAL REPLACEMENT PARTS LIST ..... 103

# 1 INTRODUCTION

## 1.1. INTRODUCTION

This service manual contains technical information which will allow service personnel's to understand and service this model. Please place orders using the parts list and not the drawing reference numbers.

If the circuit is changed or modified, this information will be followed by supplement service manual to be filed with original service manual.

**Note 1:**

AC Adaptor used on these movie camera is VSK0651A or VSK0651B.

However, DE-974HA is supplied as a replacement part for VSK0651A. Also, DE-974GA is supplied for VSK0651B.

This AC Adaptor is supplied only as a unit.

**Note 2:**

1. This service manual does not contain the following information, because of the impossibility of servicing at component level.

a. Schematic Diagram, Block Diagram and C.B.A. layout of Main C.B.A.

b. Parts List for individual parts of Main C.B.A.

2. The following category is recycle module part. Please send it to Central Repair Center.

a. \*Main C.B.A. (LSEP8295P1/ LSEP8295Q1/  
LSEP8295R1/ LSEP8295S1/ LSEP8295T1/  
LSEP8295U1)

When a part replacement is required for repairing each Main C.B.A., replace the assembly parts.

## 1.2. CAUTION FOR AC CORD (VJA0940 TYPE)

### 1.2.1. INFORMATION FOR YOUR SAFETY

**IMPORTANT**

Your attention is drawn to the fact that recording of pre-recorded tapes or discs or other published or broadcast material may infringe copyright laws.

**WARNING**

To reduce the risk of fire or shock hazard, do not expose this equipment to rain or moisture.

**CAUTION**

To reduce the risk of fire or shock hazard and annoying interference, use the recommended accessories only.

**FOR YOUR SAFETY**

**DO NOT REMOVE THE OUTER COVER**

To prevent electric shock, do not remove the cover. No user serviceable parts inside. Refer servicing to qualified service personnel.

## 1.3. CAUTION FOR AC MAINS LEAD

For your safety, please read the following text carefully.

This appliance is supplied with a moulded three-pin mains plug for your safety and convenience.

A 5-ampere fuse is fitted in this plug.

Should the fuse need to be replaced please ensure that the replacement fuse has a rating of 5 amperes and it is approved by ASTA or BSI to BS1362.

Check for the ASRA mark or the BSI mark on the body of the fuse.



If the plug contains a removable fuse cover you must ensure that it is refitted when the fuse is replaced.

If you lose the fuse cover, the plug must not be used until a replacement cover is obtained.

A replacement fuse cover can be purchased from your local Panasonic Dealer.

If the fitted moulded plug is unsuitable for the socket outlet in your home then the fuse should be removed and the plug cut off and disposed of safely.

There is a danger of severe electrical shock if the cut off plug is inserted into any 13-ampere socket.

If a new plug is to be fitted please observe the wiring code as shown below.

If in any doubt, please consult a qualified electrician.

### 1.3.1. Important

The wires in this mains lead are coloured in accordance with the following code:

Blue	Neutral
Brown	Live

As the colours of the wires in the mains lead of this appliance may not correspond with the coloured markings identifying the terminals in your plug, proceed as follows:

The wire which is coloured BLUE must be connected to the terminal in the plug which is marked with the letter N or coloured BLACK.

The wire which is coloured BROWN must be connected to the terminal in the plug which is marked with the letter L or coloured RED.

Under no circumstances should either of these wires be connected to the earth terminal of the three pin plug, marked with the letter E or the Earth Symbol.

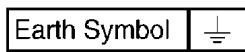

### 1.3.2. Before use

remove the Connector Cover as follows.

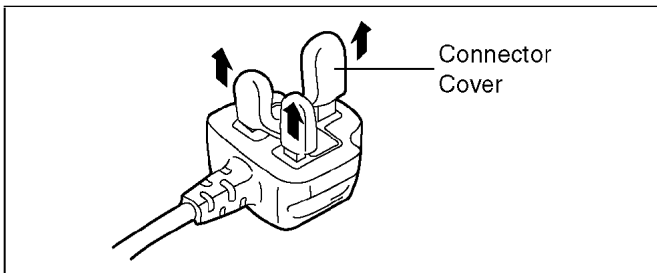

### 1.3.3. How to replace the Fuse

1. Remove the Fuse Cover with a screwdriver.

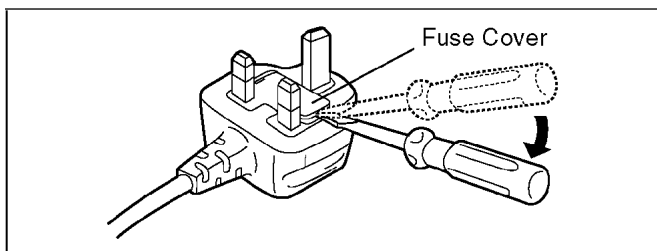

2. Replace the fuse and attach the Fuse cover.

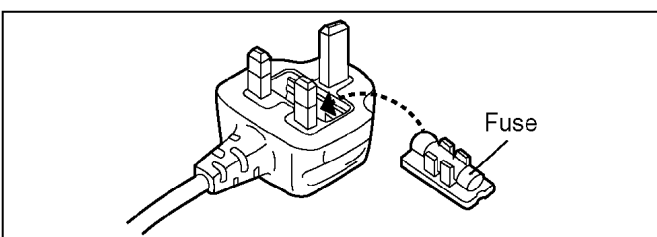

## 2 SAFETY PRECAUTIONS

### GENERAL GUIDELINES

#### 1. IMPORTANT SAFETY NOTICE

There are special components used in this equipment which are important for safety. These parts are marked by  $\triangle$  in the Schematic Diagrams, Circuit Board Layout, Exploded Views and Replacement Parts List. It is essential that these critical parts should be replaced with manufacturer's specified parts to prevent, shock, fire, or other hazards. Do not modify the original design without permission of manufacturer.

2. An Isolation Transformer should always be used during the servicing of AC Adaptor whose chassis is not isolated from the AC power line. Use a transformer of adequate power rating as this protects the technician from accidents resulting in personal injury from electrical shocks. It will also protect AC Adaptor from being damaged by accidental shorting that may occur during servicing.
3. When servicing, observe the original lead dress. If a short circuit is found, replace all parts which have been overheated or damaged by the short circuit.
4. After servicing, see to it that all the protective devices such as insulation barriers, insulation papers shields are properly installed.
5. After servicing, make the following leakage current checks to prevent the customer from being exposed to shock hazards.

A leakage current tester (Simpson Model 228 or equivalent) may be used to make the hot checks, leakage current must not exceed 1/2 mA. In case a measurement is outside of the limits specified, there is a possibility of a shock hazard, and the equipment should be repaired and rechecked before it is returned to the customer.

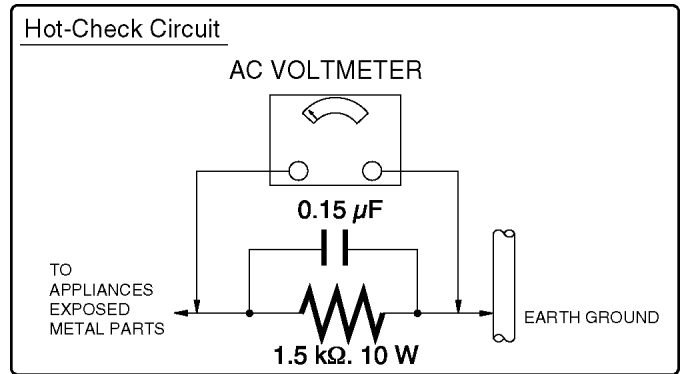

Figure. 1

### LEAKAGE CURRENT COLD CHECK

1. Unplug the AC cord and connect a jumper between the two prongs on the plug.
2. Measure the resistance value, with an ohmmeter, between the jumpered AC plug and each exposed metallic cabinet part on the equipment such as screwheads, connectors, control shafts, etc. When the exposed metallic part has a return path to the chassis, the reading should be between 1 M $\Omega$  and 5.2 M $\Omega$ . When the exposed metal does not have a return path to the chassis, the reading must be infinity.

### LEAKAGE CURRENT HOT CHECK

(See Figure 1.)

1. Plug the AC cord directly into the AC outlet. Do not use an isolation transformer for this check.
2. Connect "A" to exposed metallic part on the set. And connect "B" to a good earth ground, as shown in Figure 1.
3. Use an AC voltmeter, with 1 k $\Omega$ /V or more sensitivity, to measure the potential across the resistor.
4. Check each exposed metallic part, and measure the voltage at each point.
5. Reverse the AC plug in the AC outlet and repeat each of the above measurements.
6. The potential at any point should not exceed 0.25 V RMS.

### 3 PREVENTION OF ELECTRO STATIC DISCHARGE (ESD) TO ELECTROSTATICALLY SENSITIVE (ES) DEVICES

Some semiconductor (solid state) devices can be damaged easily by static electricity. Such components commonly are called Electrostatically Sensitive (ES) Devices. Examples of typical ES devices are integrated circuits and some field-effect transistors and semiconductor "chip" components. The following techniques should be used to help reduce the incidence of component damage caused by electro static discharge (ESD).

1. Immediately before handling any semiconductor component or semiconductor-equipped assembly, drain off any ESD on your body by touching a known earth ground. Alternatively, obtain and wear a commercially available discharging ESD wrist strap, which should be removed for potential shock reasons prior to applying power to the unit under test.
2. After removing an electrical assembly equipped with ES devices, place the assembly on a conductive surface such as aluminum foil, to prevent electrostatic charge buildup or exposure of the assembly.
3. Use only a grounded-tip soldering iron to solder or unsolder ES devices.
4. Use only an antistatic solder removal device. Some solder removal devices not classified as "antistatic (ESD protected)" can generate electrical charge sufficient to damage ES devices.
5. Do not use freon-propelled chemicals. These can generate electrical charges sufficient to damage ES devices.
6. Do not remove a replacement ES device from its protective package until immediately before you are ready to install it. (Most replacement ES devices are packaged with leads electrically shorted together by conductive foam, aluminum foil or comparable conductive material).
7. Immediately before removing the protective material from the leads of a replacement ES device, touch the protective material to the chassis or circuit assembly into which the device will be installed.

#### CAUTION :

Be sure no power is applied to the chassis or circuit, and observe all other safety precautions.

8. Minimize bodily motions when handling unpackaged replacement ES devices. (Otherwise harmless motion such as the brushing together of your clothes fabric or the lifting of your foot from a carpeted floor can generate static electricity (ESD) sufficient to damage an ES device).

### 4 ABOUT LEAD FREE SOLDER (PbF)

#### Distinction of PbF PCB:

PCBs (manufactured) using lead free solder will have a PbF stamp on the PCB.

#### Caution:

- Pb free solder has a higher melting point than standard solder; Typically the melting point is 50-70°F (30-40°C) higher.  
Please use a high temperature soldering iron. In case of the soldering iron with temperature control, please set it to 700±20°F (370±10°C).
- Pb free solder will tend to splash when heated too high (about 1100°F/600°C).

When soldering or unsoldering, please completely remove all of the solder on the pins or solder area, and be sure to heat the soldering points with the Pb free solder until it melts enough.

## 5 OPERATION GUIDE

Followings are the Operation Guide for NV-GS35EB/21EB/17EB as a sample.

For other models, refer to each original Operation Guide.

Before using

### Before using

#### ■ Sales and Support Information

##### Customer Care Centre

- For UK customers: 08705 357357
- For Republic of Ireland customers: 01 289 8333
- Visit our website for product information
- E-mail: [customer.care@panasonic.co.uk](mailto:customer.care@panasonic.co.uk)

##### Technical Support for AV Software

- For callers in UK: 08701 505610
- For callers in ROI: 0044 8701 505610

##### Direct Sales at Panasonic UK

- Order accessory and consumable items for your product with ease and confidence by phoning our Customer Care Centre Monday–Friday 9:00am– 5:30pm. (Excluding public holidays).
- Or go on line through our Internet Accessory ordering application at [www.panasonic.co.uk](http://www.panasonic.co.uk).
- Most major credit and debit cards accepted.
- All enquiries transactions and distribution facilities are provided directly by Panasonic UK Ltd.
- It couldn't be simpler!
- Also available through our Internet is direct shopping for a wide range of finished products, take a browse on our website for further details.

#### Accessories

The followings are the accessories supplied with this product.

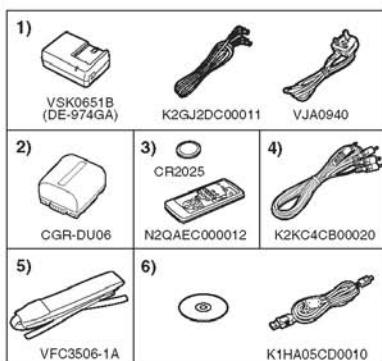

- 1) AC adaptor, DC input lead, AC mains lead -9-
- 2) Battery pack -9-
- 3) Remote control, button-type battery (supplied with NV-GS35) -16-
- 4) AV cable -37-
- 5) Shoulder strap (supplied with NV-GS35) -7-
- 6) USB cable supplied with NV-GS35 and NV-GS21, CD-ROM supplied with NV-GS35

### Optional

- 1) AC adaptor (VW-AD11EB)
  - 2) Battery pack (lithium/CGR-DU06/640mAh)
  - 3) Battery pack (lithium/CGA-DU07/680mAh)
  - 4) Battery pack (lithium/CGA-DU12/1150mAh)
  - 5) Battery pack (lithium/CGA-DU14/1360mAh)
  - 6) Battery pack (lithium/CGA-DU21/2040mAh)
  - 7) Wide conversion lens (VW-LW3007E)
  - 8) Tele conversion lens (VW-LT3014E)
  - 9) ND filter (VW-LND30E)
  - 10) MC protector (VW-LMC30E)
  - 11) Tripod (VW-CT45E)
  - 12) DV cable (VW-CD1E)
  - 13) Jacket pouch (VW-SJ05E)
- Some optional accessories may not be available in some countries.

### Parts identification and handling

#### ■ Camera

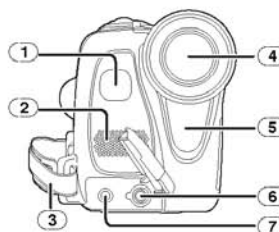

- 1) Built-in LED video light (NV-GS35 and NV-GS21 only) -18-
- 2) Microphone (built-in, stereo) -23-, -25-
- 3) Grip belt -7-
- 4) Lens
  - Fit the MC protector (VW-LMC30E; optional), the ND filter (VW-LND30E; optional), the tele conversion lens (VW-LT3014E; optional) or the wide conversion lens (VW-LW3007E; optional) in front of the lens. Do not fit the other accessories. (except for the lens cap)
- 5) White balance sensor -28-  
Remote control sensor (NV-GS35 only) -17-
- 6) Audio-video output terminal [A/V] -37-
- 7) Microphone terminal [MIC] (NV-GS35 only)
  - When connecting an external microphone or audio equipment to this jack, the built-in microphone does not operate.



Before using

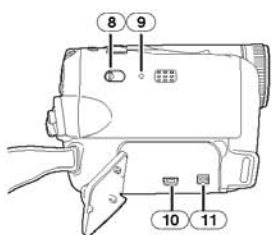

- 8 Mode select switch [AUTO/MANUAL/ FOCUS] -19-, -27-, -29-
- 9 Reset button [RESET] -44-
- 10 USB terminal [Ψ]
- 11 DV terminal [DV] -38-

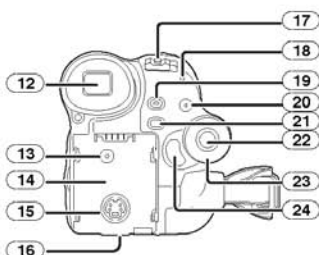

- 12 Viewfinder -8-, -52-

Due to limitations in LCD production technology, there may be some tiny bright or dark spots on the Viewfinder screen. However, this is not a malfunction and does not affect the recorded picture.

- 13 DC input terminal [DC/C.C.IN] -9-
- 14 Battery holder
- 15 S-Video output terminal [S-VIDEO] -33-
- 16 Battery release lever [BATTERY RELEASE] -9-
- 17 Power switch [OFF/ON] -12-
- 18 Power lamp -12-
- 19 Quick start recording button [QUICK START] -23-
- Quick start recording lamp -23-
- 20 Light button [LIGHT] (NV-GS35 and NV-GS21 only) -18-
- 21 Menu button [MENU] -14-
- 22 Joystick -13-
- 23 Mode dial -12-
- 24 Recording start/stop button -20-

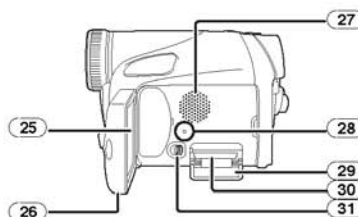

- 25 LCD monitor -8-, -52-

Due to limitations in LCD production technology, there may be some tiny bright or dark spots on the LCD monitor screen. However, this is not a malfunction and does not affect the recorded picture.

- 26 LCD monitor open part [OPEN] -8-
- 27 Speaker -31-
- 28 Card access lamp (NV-GS35 and NV-GS21 only) -11-
- 29 Card slot cover (NV-GS35 and NV-GS21 only) -11-
- 30 Card slot (NV-GS35 and NV-GS21 only) -11-
- 31 Card slot cover open lever (NV-GS35 and NV-GS21 only) -11-

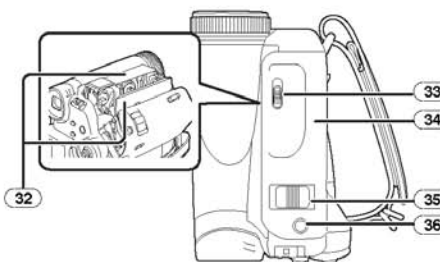

- 32 Cassette holder -10-
- 33 Cassette eject lever [OPEN/EJECT] -10-
- 34 Cassette cover -10-
- 35 Zoom lever [W/T] -22-
- Volume lever [-VOL+] -31-
- 36 Photoshot button [PHOTO SHOT] -21-

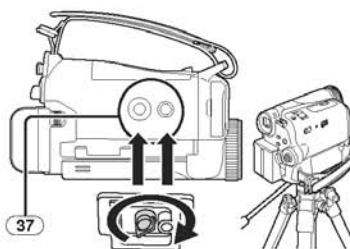

- 37 Tripod receptacle

Before using

This is a hole for attaching the camera to optional tripod/VW-CT45E. (Please carefully read the operating instructions for how to attach the tripod to the camera.)

- You cannot open the card slot cover when the tripod is used. Insert the card first and then attach the tripod.

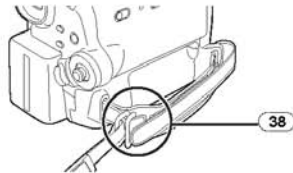

38 Shoulder strap fixture

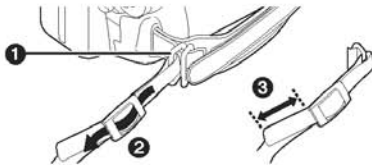

- Put the strap (NV-GS35 only) through the fixture ① and through the stopper ② so it will not come off. Extend part ③ by at least 2 cm.
- Fit the other end of the belt similarly.

**Fitting the lens cap**

Fit the lens cap to protect the surface of the lens.

- 1 The lens cap and lens cap cord comes preattached to the grip belt. Pass the end of the lens cap cord through the attached eye on the lens cap. Then pass the lens cap through the loop made by itself and pull tight.

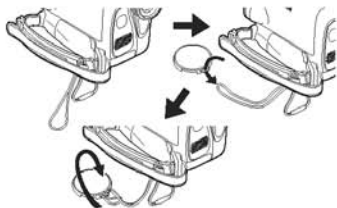

- When not using the Lens Cap, pull the Lens Cap Cord in the direction of the arrow. ①
- When you are not recording, be sure to cover the Lens with the Lens Cap for protection. ②

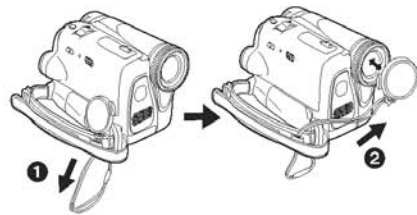

- When you remove the lens cap, press the knobs firmly.



**The grip belt**

Adjust the belt length so it fits your hand.

- 1 Adjust the belt length.

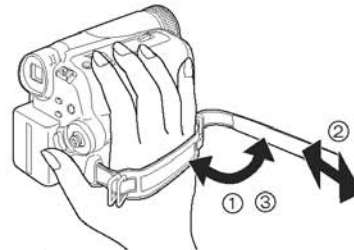

- ① Flip the belt.
- ② Adjust the length.
- ③ Fix the belt.

Before using

**Using the LCD monitor**

You can record the image while viewing it on the LCD monitor opened.

- 1 Put a finger on the LCD monitor open part and pull the LCD monitor out in the direction of the arrow.

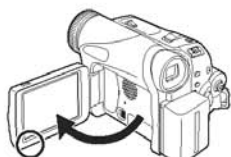

- The viewfinder will go off.
- It can open up to 90°.

- 2 Adjust the angle of the LCD monitor as you prefer.



- It can rotate up to 180° ① towards the lens or 90° ② towards the viewfinder.

- The brightness and colour level of the LCD monitor can be adjusted from the menu.
- If it is forcibly opened or rotated, the camera may be damaged or fail.
- Check that the card slot cover is closed.
- When the LCD monitor is rotated by 180° towards the lens (when recording yourself), the LCD monitor and the viewfinder will be simultaneously activated.

**Using the viewfinder**

■ **Extending the viewfinder**

- 1 Pull out the viewfinder and extend it by pinching the extension knob.

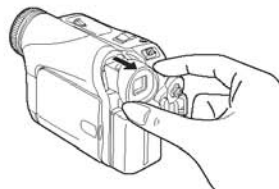

■ **Adjusting the field of view**

- 1 Adjust the focus by sliding the eyepiece corrector knob.

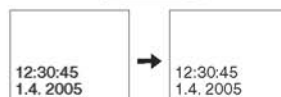
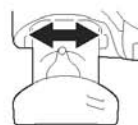

- You can adjust the brightness of the viewfinder from the menu.

Before using

**Power supply**

**■ Charging the battery**

When this product is purchased, the battery is not charged. Charge the battery before using this product.

- Battery charging time (-10-)
- We recommend using Panasonic batteries.
- If you use other batteries, we cannot guarantee the quality of this product.
- If the DC input lead is connected to the AC adaptor, then the battery will not get charged. Remove the DC input lead from the AC adaptor.

- 1 Connect the AC mains lead to the AC adaptor and the AC mains socket.
- 2 Put the battery on the battery mount by aligning the mark, and then securely plug it in.

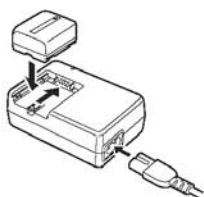

**■ Charging lamp**

Lights up: Charging

Goes off: Charging completed

Flashing: The battery is over discharged (discharged excessively). In a while, the lamp will light up and normal charging will start.

When the battery temperature is excessively high or low, the [CHARGE] lamp flashes and the charging time will be longer than normal.

**■ Connecting to the AC outlet**

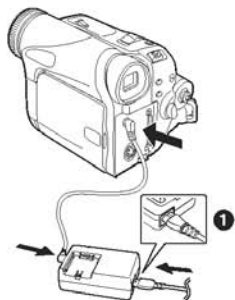

- 1 Connect the AC mains lead to the AC adaptor and the AC mains socket.
- 2 Connect the DC input lead to the AC adaptor.

**3 Connect the DC input lead to this product.**

- The output plug of the AC mains lead is not completely connected to the AC adaptor socket. As shown in ①, there is a gap.
- Do not use the power cord for other equipment since the power cord is exclusively designed for the movie camera. Or do not use the power cord of other equipment for the movie camera.

**■ Fitting the battery**

Push the battery against the battery holder and slide it until it clicks.

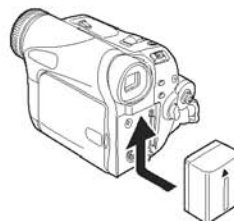

**■ Removing the battery**

While sliding the [BATTERY RELEASE] lever, slide the battery to remove it.

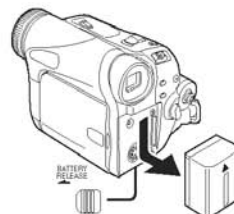

- Hold the battery with your hand so it does not fall.

Before using

**Charging time and recordable time**

The times shown in the table below show the times at a temperature of 25°C and a humidity of 60%. This is just a guide. If the temperature is higher or lower than the specified value, the charging time will become longer.







Supplied battery/ CGR-DU06 (7.2 V/ 640 mAh)	(A)	1 h. 40 min.
	(B)	1 h. 45 min. (1 h. 25 min.)
	(C)	55 min. (45 min.)
CGA-DU12 (7.2 V/ 1150 mAh)	(A)	2 h. 25 min.
	(B)	3 h. 10 min. (2 h. 35 min.)
	(C)	1 h. 35 min. (1 h. 20 min.)
CGA-DU14 (7.2 V/ 1360 mAh)	(A)	2 h. 45 min.
	(B)	3 h. 40 min. (3 h.)
	(C)	1 h. 50 min. (1 h. 30 min.)
CGA-DU21 (7.2 V/ 2040 mAh)	(A)	3 h. 55 min.
	(B)	5 h. 30 min. (4 h. 30 min.)
	(C)	2 h. 45 min. (2 h. 15 min.)
CGA-DU07 (7.2 V/ 680 mAh)	(A)	1 h. 30 min.
	(B)	1 h. 50 min. (1 h. 30 min.)
	(C)	55 min. (45 min.)

- (A) Charging time
- (B) Maximum continuously recordable time
- (C) Intermittent recordable time

(The intermittent recordable time refers to recordable time when the recording and stopping operations are repeated.)

"1 h. 10 min." indicates 1 hour 10 minutes.

- The battery CGR-DU06 is supplied.
- The times shown in the table are rough estimates. The times indicate the recordable times when the viewfinder is used. The times in parentheses indicate the recordable times when the LCD monitor is used.
- We recommend the Battery Pack CGA-DU12, CGA-DU14 and CGA-DU21 for long time recording (2 hours or more for continuous recording, 1 hour or more for intermittent recording).

- The recordable time will become shorter in the following cases:
  - When you use both the viewfinder and the LCD monitor simultaneously while rotating the LCD monitor frontward to record yourself etc.
  - The batteries heat up after use or charging. The main unit of the movie camera being used will also heat up. This is normal.
- Along with the reduction of the battery capacity, the display will change:  →  →  → . If the battery discharges, then  (  ) will flash.

**Inserting/removing a cassette**

- 1 Slide the [OPEN/EJECT] lever and open the cassette cover.

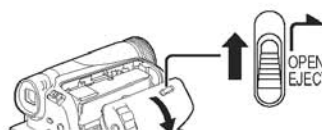

- When the cover is fully opened, the cassette holder will come out.

- 2 After the cassette holder is opened, insert/remove the cassette.

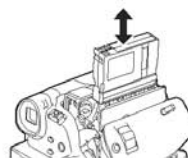

- When inserting a cassette, orient it as shown in the figure, and then securely insert it as far as it goes.
- When removing, pull it straight out.

- 3 Push the [PUSH] mark ① in order to close the cassette holder.

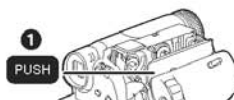

- 4 Only after the cassette holder is completely housed, close the cassette cover by pressing the mark ②.



Before using

- After using, make sure to rewind the cassette completely, remove it, and put it in a case. Store the case in an upright position. (-52-)
- When condensation is formed on the lens or the main unit of the movie camera, even if no condensation alarm is indicated, condensation may have formed on the heads or the cassette tape. Do not open the cassette cover. (-49-)

■ **When the cassette holder does not come out**

- Close the cassette cover completely, and then open it again completely.
- Check if the battery has run down.
- Check if the cassette compartment cover is in contact with grip belt as shown below. If so, be sure the grip belt stays clear of the cover when opening.

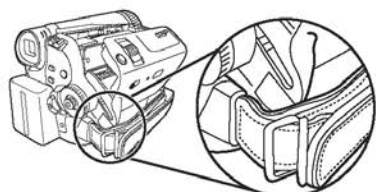

■ **When the cassette holder cannot be housed**

- Set the [OFF/ON] switch to [OFF], then to [ON] again.
- Check if the battery has run down.

■ **Inserting/removing the cassette**

- When the cassette holder is in action, do not touch anything except the [PUSH] mark.
- When inserting a previously recorded cassette, use the blank search function to find the position where you want to continue recording. If you overwrite-record on a previously recorded cassette, be sure to find the position where you continue recording.
- Close the cassette cover tightly.
- When closing the cassette cover, do not get anything, such as a cable, caught in the cover.

■ **Accidental erasure prevention**

If the accidental erasure prevention slider ① of a cassette is opened (slide in the direction of the [SAVE] arrow), the cassette cannot be recorded. When recording, close the accidental erasure prevention slider of the cassette (slide in the direction of the [REC] arrow).

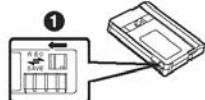

**Inserting/removing a card**

Before inserting/removing a card, be sure to turn the power [OFF].

- If the card is inserted or removed with the power turned on, this camera may malfunction or the data recorded on the card may be lost.

**1 Open the LCD monitor and then slide the [◀OPEN] Lever to open the card slot cover.**

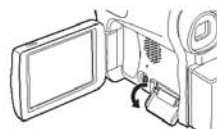

**2 Insert/remove the card into/from the card slot.**

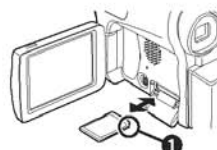

- When inserting a card, face the label side ① towards you and push it straight in with one stroke as far as it goes.
- When removing the card, open the card slot cover and press the centre of the card and then pull it straight out.

**3 Securely close the card slot cover.**

■ **Concerning the card**

- Do not touch the terminals on the back of the card.
- Do not format the card with another movie camera or any personal computer. This operation may make the card unusable.
- Electrical noise, static electricity, or failure of the movie camera or the card may damage or erase the data stored on the card. We recommend saving important data on a personal computer by using a USB cable, PC card adaptor, and USB reader/writer.

■ **Card access lamp**

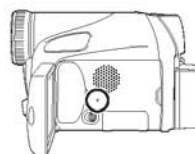

- When the camera accesses the card (reading, recording, playback, erasing, etc.), the access lamp lights up.

Before using

- If the following operations are performed when the access lamp is lit, then the card or the recorded data may be damaged or the camera may malfunction.
  - Opening the card slot cover and inserting or removing the card
  - Operating the [OFF/ON] switch or the mode dial

**SD Memory Card**

- The memory capacity indicated on the SD Memory Card label corresponds to the total amount of capacity to protect and manage the copyright and the capacity available as conventional memory for a movie camera, personal computer or other equipment.

**Concerning the write protection switch on the SD Memory Card**

- The SD Memory Card has a write protection switch on it. If the switch is moved to [LOCK], you cannot write to the card, erase the data on it, or format it. If it is moved back, you can.

**Turning the camera on**

When the camera is turned on with the lens cap fitted, the automatic white balance adjustment may not function properly. Please turn the camera on after removing the lens cap.

**How to turn on the power**

- 1 While pressing the button ❶, set the [OFF/ON] switch to [ON].

- The power lamp lights up.

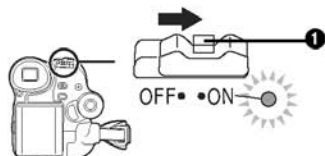

**How to turn off the power**

- 1 While pressing the button ❶, set the [OFF/ON] switch to [OFF].

- The power lamp goes off.

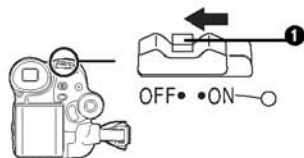

**Selecting a mode**

Rotate the mode dial to select the desired mode.

- 1 Rotate the mode dial.

- Set your desired mode to ❶.

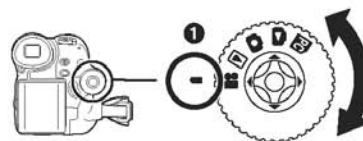

**Tape recording mode**

Use this when you record the image on a tape. (Also, you can simultaneously record still pictures on a card while recording images on a tape.)

**Tape playback mode**

Use this to play back a tape.

**Card recording mode**

Use this to record still pictures on a card.

**Picture playback mode**

Use this to play back the still pictures recorded on a card.

**PC mode**

You can view or edit the images recorded on a card on your personal computer.

(Refer to the operating instructions for PC connection.)

Before using

**How to use the joystick**

**Basic joystick operations**

Operations on the menu screen and selection of files to be played back on the multi-image display

Move the joystick up, down, left, or right to select an item or file, and then push in the centre to set it.

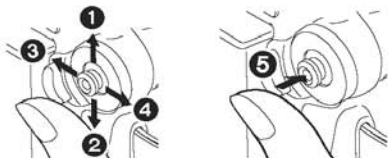

1	Select by moving up.
2	Select by moving down.
3	Select by moving left.
4	Select by moving right.
5	Determine by pushing the centre.

**Joystick and screen display**

Push the centre of the joystick, and icons will be displayed on the screen. Each push switches the display as follows depending on the mode. (In the Tape playback mode or the Picture playback mode, the icons will be automatically displayed on the screen.)

**1) Tape recording mode**  
([AUTO/MANUAL/FOCUS] switch is set to [AUTO])



▼	☺	Soft skin mode	-24-
◀	☒	Fade	-25-
▶	☒	Backlight compensation	-24-
▲	☾	Night view	-24-
▼	☒	Recording check	-21-

**2) Tape recording mode**  
([AUTO/MANUAL/FOCUS] switch is set to [MANUAL])



▼	▼	White balance Shutter speed Iris or gain value	-28-
▶	+	Select/Adjust	-28-
◀	-	Select/Adjust	-28-

**3) Tape playback mode**

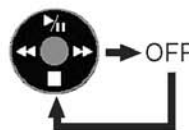

▲	⏮	Playback/pause	-31-
▼	■	Stop	-31-
◀	◀◀	Rewind (review playback)	-31-
▶	▶▶	Fast forward (cue playback)	-31-

**4) Card recording mode**  
([AUTO/MANUAL/FOCUS] switch is set to [AUTO])



▼	☺	Soft skin mode	-24-
▶	☒	Backlight compensation	-24-

**5) Card recording mode**  
([AUTO/MANUAL/FOCUS] switch is set to [MANUAL])



▼	▼	White balance Shutter speed Iris or gain value	-28-
▶	+	Select/Adjust	-28-
◀	-	Select/Adjust	-28-



Before using

6) Picture playback mode

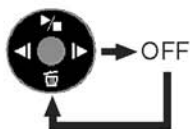

▲	▶	Playback/stop	-33-
▼	🗑️	Erase	-34-
◀	◀	Playback previous picture	-33-
▶	▶	Playback next picture	-33-

**Switching the language**

You can switch the language on the screen display or the menu screen.

- 1 Set [LANGUAGE] >> select the desired language.



**Using the menu screen**

For each individual menu, please refer to -40-.

- 1 Press the [MENU] button.



- The menu corresponding to the mode selected by the mode dial is displayed.
- Do not switch the mode dial when the menu is displayed.

- 2 Move the joystick up or down in order to select the top menu.



- 3 Move the joystick right or press it to set the selection.



- 4 Move the joystick up or down in order to select the sub-menu.



- 5 Move the joystick right or press it to set the selection.



- 6 Move the joystick up or down in order to select the item to be set.



- 7 Press the joystick to determine the setting.



■ To exit the menu screen

Press the [MENU] button.

■ To get back to the previous screen

Move the joystick left.



■ About the menu setting

- The menu screen does not appear during recording. And you cannot record when the menu screen appears.

Before using

**■ Operating with remote control (NV-GS35 only)**

The menu screen transition is the same as when the buttons on the main unit are used.

**1 Press the [MENU] button.**

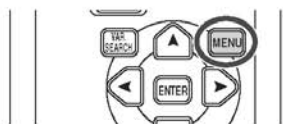

**2 Select a menu item.**

- Use the direction buttons (▲, ◀, ▶, ▼) and [ENTER] button in place of the joystick on the main unit.

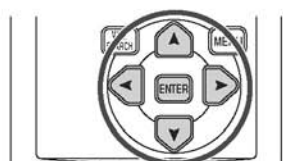

**3 Press the [MENU] button to exit the menu screen.**

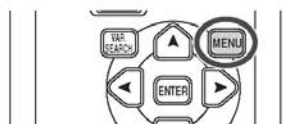

**Setting date and time**

If the screen shows the incorrect date/time, then adjust it.

- **Set to Tape Recording Mode or Card Recording Mode.**

**1 Set [BASIC] >> [CLOCK SET] >> [YES].**



**2 Move the joystick left or right in order to select the item to be set. Then move the joystick up or down to set the desired value.**

- The year will change as follows:  
2000, 2001, ..., 2089, 2000, ...
- The 24-hour clock is used.

**3 Press the joystick to determine the setting.**

- The clock function starts at [00] seconds.

**■ About date/time**

- The date and time function are driven by a built-in lithium battery.
- Make sure to check the time before recording because the built-in clock is not very accurate.

**■ Recharging the built-in lithium battery**

- If [🔋] or [--] is indicated when the camera is turned on, then the built-in lithium battery runs down. Connect the AC adaptor to the camera or place the battery on the camera, and the built-in lithium battery will be recharged. Leave the camera as is for approx. 24 hours, and the battery will drive the date and time for approx. 6 months. (Even if the [OFF/ON] switch is set to [OFF], the battery is still being recharged.)

**WARNING**

THE LITHIUM BATTERY IN THIS EQUIPMENT MUST ONLY BE REPLACED BY QUALIFIED PERSONNEL. WHEN NECESSARY, CONTACT YOUR LOCAL PANASONIC SUPPLIER.

Before using

## Adjusting LCD monitor/viewfinder

### ■ Adjusting the brightness and colour level

1 Set [SETUP] >> [LCD SET] or [EVF SET] >> [YES].



2 Move the joystick up or down in order to select the item to be adjusted.

[LCD SET]

☀ :Brightness of the LCD monitor

⊕ :Colour level of the LCD monitor

[EVF SET]

EVF☀ :Brightness of the viewfinder

3 Move the joystick left or right to move the bar indication representing the brightness.

4 Press the [MENU] button or the joystick to complete the settings.

- In order to adjust the brightness of the viewfinder, close the LCD monitor, and the viewfinder will be activated.
- When the LCD monitor is rotated by 180° towards the lens, the brightness of the LCD monitor cannot be adjusted.
- These settings will not affect the images actually recorded.

## Using the remote control (NV-GS35 only)

### ■ Remote control

Using the remote control supplied will enable controlling almost all the functions of this camera to be controlled.

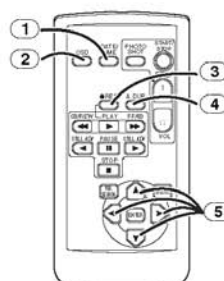

- ① Date/time button [DATE/TIME] -40-
- ② On-screen display button [OSD] -33-
- ③ Record button [●REC] (not available)
- ④ Audio dubbing button [A.DUB] -38-
- ⑤ Direction buttons [▲, ◀, ▶, ▼] -15-

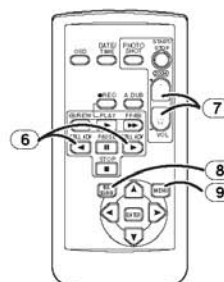

- ⑥ Slow/frame-by-frame forward button [◀, ▶] (◀: reverse, ▶: forward) -31-
- ⑦ Zoom/volume button [ZOOM/VOL] \*
- ⑧ Search button [VAR. SEARCH] -32-
- ⑨ Menu button [MENU] -15-

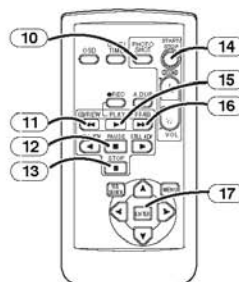

- ⑩ Photoshot button [PHOTO SHOT] \*
- ⑪ Rewind/review button [◀◀]

Before using

- 12 Pause button [II]
- 13 Stop button [■]
- 14 Recording start/stop button [START/STOP] \*
- 15 Playback button [▶]
- 16 Fast forward/cue button [▶▶]
- 17 Enter button [ENTER] -15-

\* means that these buttons function in the same manner as the corresponding buttons on the movie camera.

**■ Install a button-type battery**

Install the button-type battery supplied in the remote control before using it.

- 1 While pressing the stopper ①, pull out the battery holder.



- 2 Set the button-type battery with its (+) mark facing upward and get the battery holder back in place.

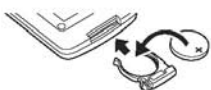

**WARNING**

"THE LITHIUM BATTERY IS A CRITICAL COMPONENT (TYPE NUMBER CR2025 MANUFACTURED BY PANASONIC). IT MUST NEVER BE SUBJECTED TO EXCESSIVE HEAT OR DISCHARGE. IT MUST THEREFORE ONLY BE FITTED IN EQUIPMENT DESIGNED SPECIFICALLY FOR ITS USE. REPLACEMENT BATTERIES MUST BE OF THE SAME TYPE AND MANUFACTURER. THEY MUST BE FITTED IN THE SAME MANNER AND LOCATION AS THE ORIGINAL BATTERY, WITH THE CORRECT POLARITY CONNECTIONS OBSERVED. DO NOT ATTEMPT TO RE-CHARGE THE OLD BATTERY OR RE-USE IT FOR ANY OTHER PURPOSE. IT SHOULD BE DISPOSED OF IN WASTE PRODUCTS DESTINED FOR BURIAL RATHER THAN INCINERATION."

**■ Remote control usable range**

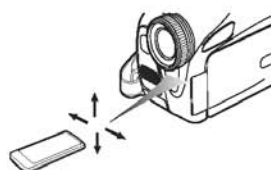

- The distance between the remote control and the camera: Within approx. 5 m  
Angle: Approx. 15° up, down, left, and right

**■ Selecting the remote control mode**

If 2 cameras are used simultaneously, set the mode for one pair of movie camera and remote control to [VCR1] and that of the other pair to [VCR2]. This will prevent interference between the 2 pairs. (The default setting is [VCR1]. When the button-type battery is replaced, the setting will revert to the default [VCR1].)

- 1 Setting on the camera:  
Set [SETUP] >> [REMOTE] >> [VCR1] or [VCR2].
- 2 Setting on the remote control:

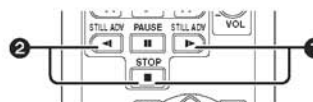

- [VCR1]:  
Press [▶] and [■] simultaneously. ①
- [VCR2]:  
Press [◀] and [■] simultaneously. ②

**■ Concerning the button-type battery**

- When the button-type battery runs down, replace it with a new battery (part number: CR2025). The battery is normally expected to last about 1 year, but it depends on operation frequency.
  - Keep the button-type battery out of the reach of children.
- 
- If the remote control mode of the camera and that of the remote control do not match with each other, "REMOTE" will appear. When the remote control is operated for the first time after the camera is turned on, "CHECK REMOTE MODE" (-4-) will appear and operation is impossible. Set the same remote control mode.
  - The remote control is intended for indoor operation. Outdoors or under strong light, the movie camera may not operate properly even within the usable ranges.

### Recording with the built-in LED video light (NV-GS35 and NV-GS21 only)

Gain up mode works with the built-in LED video light to enhance the light's brightness and brighten the natural colours in a scene.

**1 Press the [LIGHT] button. ①**

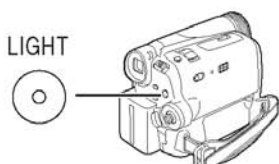

- The built-in LED video light lights up and the gain up mode is set to on.
- The gain up mode will be brighter than when only the LED video light is on, but ghost images will appear.

**2 Press the [LIGHT] button. ②**

- The gain up mode is set to off.
- To eliminate ghost images, use this mode.

**3 Press the [LIGHT] button. ③**

- The LED video light turns off.
- Pressing the [LIGHT] button again returns to ①.

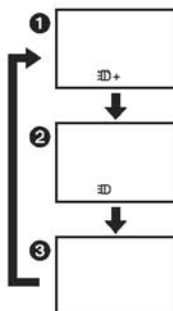

- The subject should be within 1.5 metres of the movie camera.
- Using the LED video light reduces battery time.
- Set the LED video light to off when not in use.
- Do not look directly into the light.
- If the LED video light is used with a conversion lens attached, a slight vignetting (darkening around edges) effect occurs on the screen.
- Using the night view function at the same time will make conditions even brighter.
- The LED video light enables simply lightening the images taken in a dimly-lit place. We also recommend using it in a bright place to obtain high quality images.

## 6 HOW TO REPLACE THE LITHIUM BATTERY

Remove the Jack C.B.A. (Refer to “DISASSEMBLY/ASSEMBLY PROCEDURES.”)

Unsolder the Lithium Battery “ML-621SF9DE” and then replace the new one.

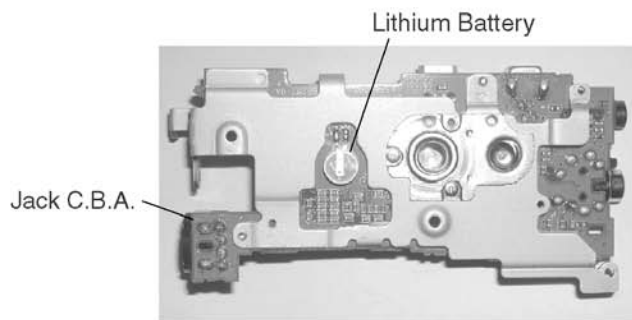

Danger of explosion if battery is incorrectly replaced.  
Replace only with the same or equivalent type.

**CAUTION** - The battery used in this device may present a risk of fire or chemical burn if mistreated.

Do not recharge, disassemble, heat above 100 °C (212 °F), or incinerate.

Replace battery with Panasonic part number ML-621SF9DE only. Use of another battery may present a risk of fire or explosion.

Dispose of used battery promptly. Keep away from children. Do not disassemble and do not dispose of in fire.

### NOTE:

This Lithium battery is a critical component. (Type No.: ML-621SF9DE)

It must never be subjected to excessive heat or discharge.

It must therefore only be fitted in equipment designed specifically for its use.

Replacement batteries must be of the same type and manufacture.

They must be fitted in the same manner and location as the original battery, with the correct polarity contacts observed.

Do not attempt to re-charge the old battery or re-use it for any other purpose.

It should be disposed of in waste products destined for burial rather than incineration.

### CAUTION

Danger of explosion if battery is incorrectly replaced.

Replace only with the same or equivalent type recommended by the equipment manufacturer.

Discard used batteries according to manufacturer's instructions.

### PRECAUTION

Le fait de remplacer incorrectement la pile peut présenter des risques d'explosion.

Remplacer la pile uniquement par une pile identique ou de type équivalent recommandée par le fabricant. Se débarrasser des piles usagées conformément aux instructions du fabricant.

### VORSICHT

Bei einer falsch eingesetzten Batterie besteht Explosionsgefahr. Nur mit einer vom Hersteller empfohlenen Batterie vom gleichen Typ ersetzen.

Verbrauchte Batterien beim Fachhändler oder einer Sammelstelle für Sonderstoffe abliefern.

### VARNING

Explosionsfara vid felaktigt batteribyte.

Använd samma batterityp eller en ekvivalent typ som rekommenderas av apparattillverkaren.

Kassera använt batteri enligt fabrikantens instruktion.

### ADVARSEL!

Lithiumbatteri-Eksplodingsfare ved fejlagtig håndtering.

Udskiftning må kun ske med batteri af samme fabrikat og type.

Levér det brugte batteri tilbage til leverandøren.

### VAROITUS

Paristo voi räjähtää, jos se on virheellisesti asennettu.

Vaihda paristo ainoastaan laitevalmistajan suosittelemaan tyyppiin.

Hävitä käytetty paristo valmistajan ohjeiden mukaisesti.

## 7 SERVICE NOTES (PLEASE READ)

### 7.1. SERVICE NOTES

#### 7.1.1. EXTENSION CABLES FOR SERVICE POSITION

Using the following Extension Cables, place the unit as shown for check and service.

NO.	PART NUMBER	PART NAME	CONNECTION
①	VUVS0012	22Pin Extension Cable	FP10 on Main C.B.A. ~ Zoom Switch F.P.C. of Cassette Cover Unit
②	VUVS0012	22Pin Extension Cable	FP701 on Main C.B.A. ~ Lens F.P.C. on Lens Unit
③	VFKW0124A	14Pin Extension Cable	FP301 on Main C.B.A. ~ CCD F.P.C. on Lens Unit
④	LSUA0017	18Pin Extension Cable	FP4 on Main C.B.A. ~ Capstan F.P.C. on Mechanism Chassis Ass'y
⑤	LSUA0016	10Pin Extension Cable	FP3 on Main C.B.A. ~ Cylinder F.P.C. on Mechanism Chassis Ass'y
⑥	LSUA0019	8Pin Extension Cable	FP5 on Main C.B.A. ~ Head Amp F.P.C. on Mechanism Chassis Ass'y
⑦	LSUA0019	8Pin Extension Cable	FP1 on Main C.B.A. ~ Mechanism F.P.C. on Mechanism Chassis Ass'y
⑧	LSUA0017	18Pin Extension Cable	FP2 on Main C.B.A. ~ Sub Mechanism F.P.C. on Mechanism Chassis Ass'y
⑨	VUVS0007	12Pin Extension Cable	FP6 on Main C.B.A. ~ Front F.P.C. of Front C.B.A.

**Note :**

1. The LCD open/close SW. is for changing between LCD Display or EVF Display. When turning on EVF Display, place some paper or tape, etc. on LCD open/close SW. so that this SW. stays ON.
2. To eject the Mechanism, hold down the Eject Switch on the Jack C.B.A. for a short time.
3. Use a grounded ESD wrist strap while disassembling the Lens portion.
4. Connect the F.P.C.s to the connectors, verifying the direction of F.P.C as shown.
5. Use extreme care when unplugging or plugging in connectors.

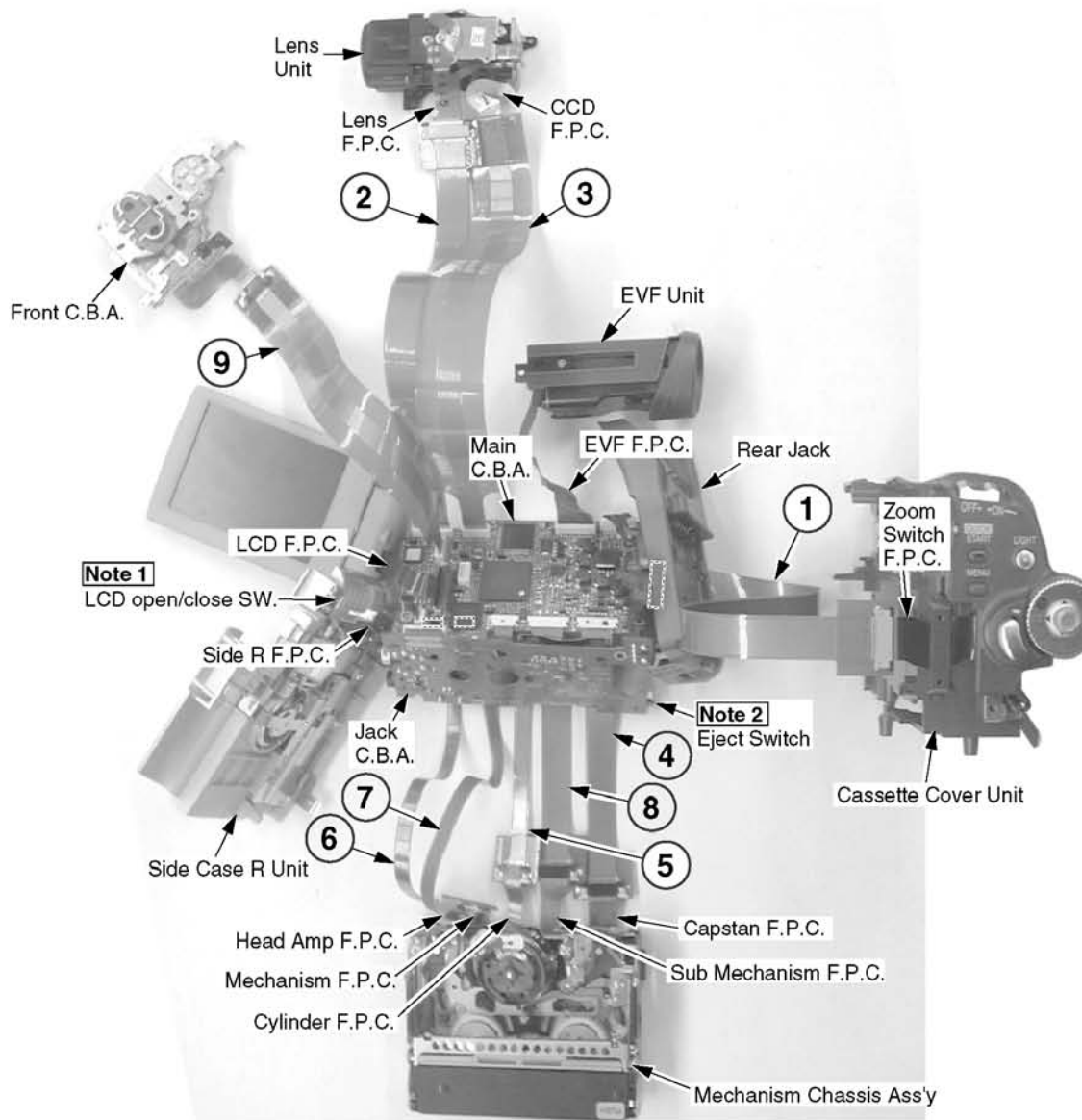

**Note 1**  
LCD open/close SW.

**Note 2**  
Eject Switch

**Non ZIF connectors are on the Main C.B.A. as shown in gray.**

Direction of F.P.C.s connection

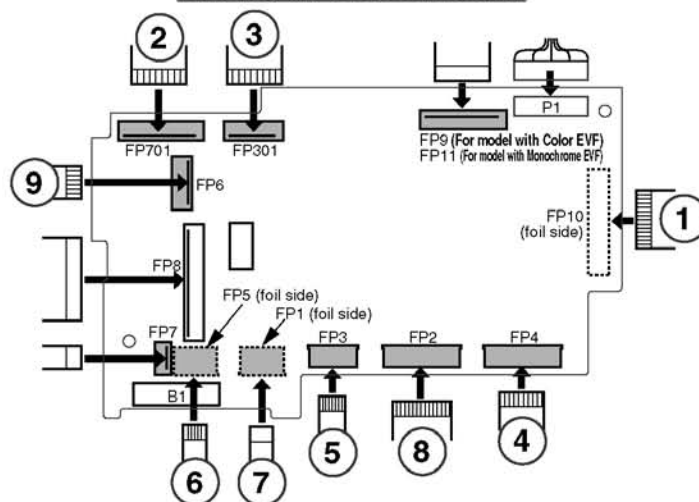

**Main C.B.A. (component side)**

Fig. 1



## 7.1.2. SERVICE MODE

### 7.1.2.1. ERROR DISPLAY

"PUSH THE RESET SWITCH" is displayed automatically on the EVF or the LCD Monitor when an undesirable condition has occurred.

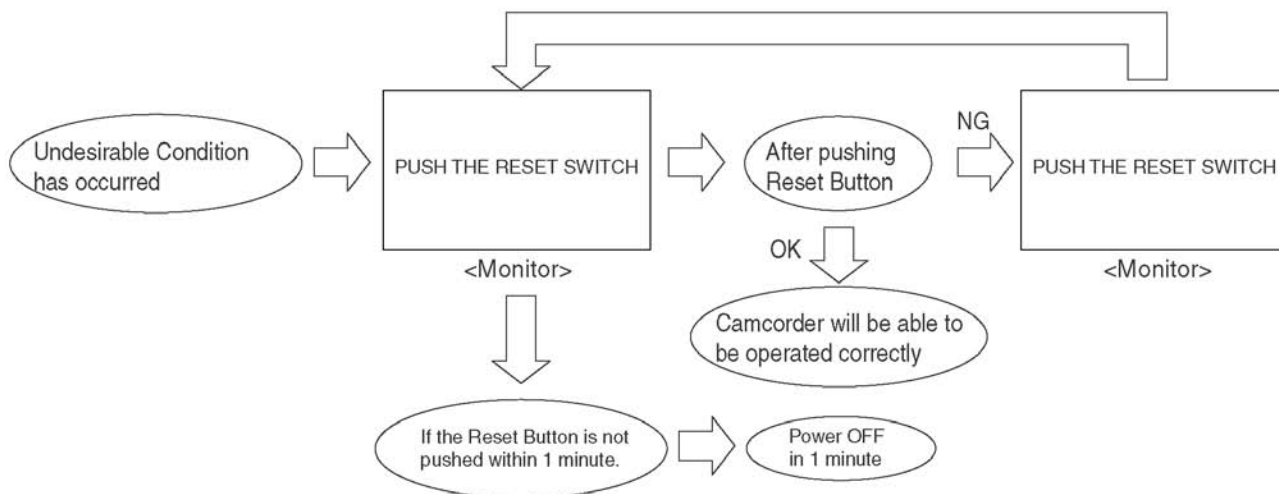

**Note:**

When "PUSH THE RESET SWITCH" is displayed repeatedly, service is required. Check the Error Code which is listed in the Service Menu.

### 7.1.2.2. SERVICE MENU

**When abnormal detection contents are confirmed, do the following operation. Automatic diagnosis cord will be displayed. (Service menu)**

**To enter the Service Menu**

Push the [QUICK START], [JOYSTICK CONTROL LEFT] and [PHOTO SHOT] simultaneously for 3 seconds (with no SD Card inserted).

**Note:**

If a tape or SD Card is inserted, the above operation will not work.

This operation displays the following Service Menu items.

- \*1 ... Cylinder elapsed time clear.  
 After replacing the Cylinder Unit, clear the Cylinder elapsed time to 0.  
 Set to Service Menu.  
 Press the [JOYSTICK CONTROL UP/DOWN] to select item [8].  
 Press the [JOYSTICK CONTROL RIGHT] to display [NO/YES] screen.  
 Press the [JOYSTICK CONTROL UP/DOWN] to select [YES].  
 Press the [JOYSTICK CONTROL CENTER] button.
- \*2 ... Cylinder elapsed time  
 This item displays the Cylinder elapsed time (in Base 16).  
 Set to Service Menu.  
 Press the [JOYSTICK CONTROL UP/DOWN] to select item [3].  
 Press the [JOYSTICK CONTROL RIGHT] to display [OFF/ON] screen.  
 Press the [JOYSTICK CONTROL UP/DOWN] to select [ON].  
 Press the [JOYSTICK CONTROL CENTER] button.

Calculation method of the Cylinder elapsed time:

(For example) If "0001234F" is displayed, 0001234F (in Base 16) = 74574 (in Base 10)

$$74574 \times 5.1 \text{ (seconds)} = 380327.4 \text{ (seconds)}$$

└ fixed value

$$320672.5 / 3600 \text{ (seconds)} = 105.6 \text{ (hours)}$$

• \*3 ... Mechanism lock code record

The current lock code, the last lock code and the lock code before last are displayed in the Item [3] screen.

• \*4 ... Lens motor lock code record

The current lock code, the last lock code and the lock code before last are displayed in the Item [3] screen.

### Cylinder elapsed time and lock code (Item [3] screen)

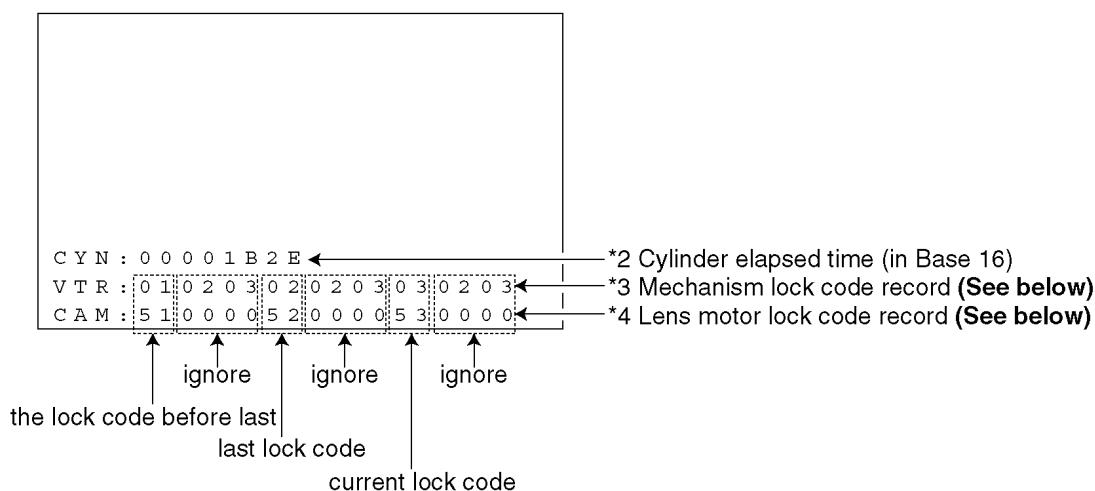

Mechanism & Lens motor lock code

DISPLAY	Explanation of cause
01	T Reel Lock
02	S Reel Lock
03	Unloading Lock
04	Loading Lock
05	Cylinder Lock
51	Zoom Motor Lock
52	Focus Motor Lock

### To exit the Service Menu

Unplug the AC Cord.

### CLEAR METHOD

If a Card or Tape is inserted, remove before Service Mode operation.

To place the mode dial of this machine into PC connection mode, push the [QUICK START], [JOYSTICK CONTROL LEFT] and [RECORDING START/STOP] simultaneously for 3 seconds.

### Note:

Only perform items 3 and 8 of items 1~8 in the Service Menu.

### 7.1.3. REMOVAL/INSTALLATION OF F.P.C. FROM NON ZIF (Zero Insertion Force) CONNECTOR

Removal/Installation of F.P.C. from the Non ZIF (Zero Insertion Force) connector:

1. The Non ZIF connectors and the ZIF connectors are used on the unit. And there are 2 types (Type A, Type B) of Non ZIF connectors.
2. To remove the F.P.C. from the Non ZIF connector, use the Plier for Non ZIF Connector (LSVQ0028) to pull out the F.P.C. as shown. The same Plier for Non ZIF Connector (LSVQ0028) should also be used to install the F.P.C. to the Non ZIF Connector.

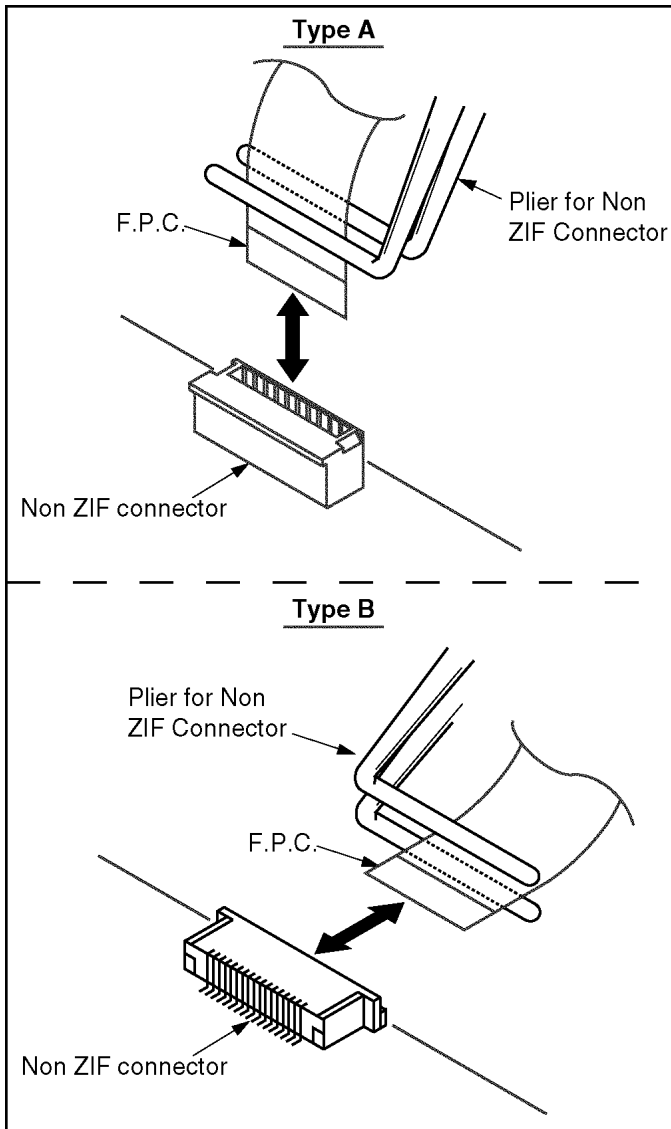

Fig. 4-1

3. Connect the F.P.C.s to the Non ZIF connectors, verifying the direction of F.P.C. as shown.

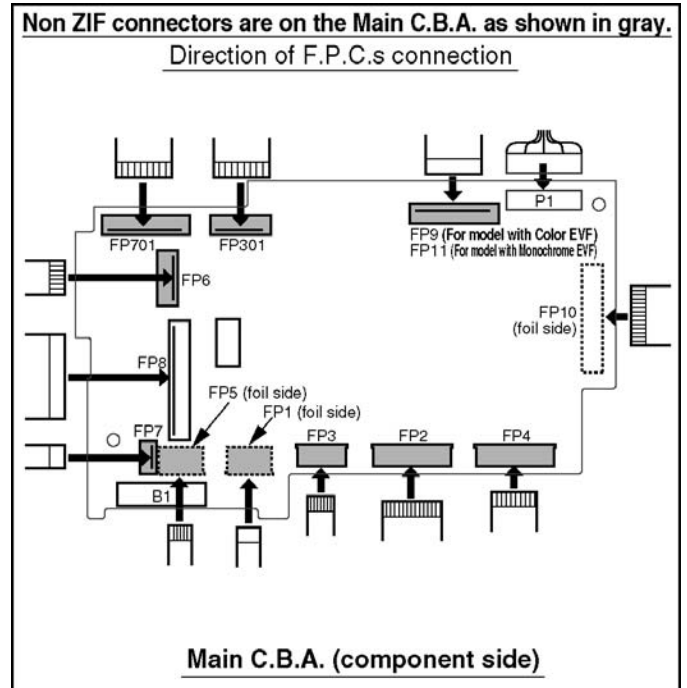

Fig. 4-2

### 7.1.4. METHOD FOR LOADING/UNLOADING OF MECHANISM

**CAUTION:**

If loading does not start after DC Power Supply is applied, DO NOT continue to apply DC Power.

Apply +3 VDC Power Supply to the Loading Motor terminals.

**Loading:**

DC (-) to Portion "a," DC (+) to Portion "b"

**Unloading:**

DC (+) to Portion "a," DC (-) to Portion "b"

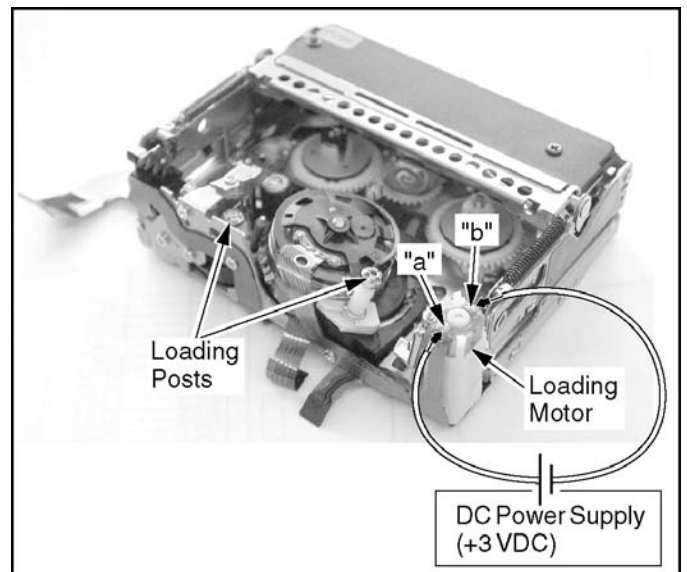

Fig. 5

## 7.1.5. EEPROM DATA

### CAUTION:

Be sure to save the EEPROM data using PC-EVR Adjustment Program before service and adjustment in order to make sure to avoid an accidental data loss, etc. using PC-EVR Adjustment Program by first.

### EEPROM IC

C.B.A.	EEPROM IC Ref. No.
Main C.B.A.	IC6002

## 7.1.6. SIGNAL DESCRIPTION ON MEASURING BOARD FOR ELECTRICAL ADJUSTMENT (VFK1308E)

A signal check can be performed using the Measuring Board.

Signal Name (on board)	Description	Waveforms
E2DATA	Not used	-----
CAM_TEST	Not used	-----
E2CLK	Not used	-----
EVR3V	Not used	-----
VD	Not used	-----
SBO	To monitor LCD red signal at Pin 9 of IC8001 on LCD C.B.A. This test point is used for "LCD Sub Bright adjustment."	2.75 V (1st step - 1st step)  Camera Mode (Built in 10 step)
SBI	To monitor LCD blue signal at Pin 5 of IC8001 on LCD C.B.A. This test point is used for "LCD Sub Bright adjustment."	2.85 V (1st step - 1st step)  Camera Mode (Built in 10 step)
E2CS	Not used	-----
MREF/VREF-T	Not used	-----
AFST	Not used	-----
UARTI	To monitor RS232C received data	-----
UARTO	To monitor RS-232C transmitted data	-----
VTR_RESET	Power microcontroller reset: low	-----
BST_TEST	Not used	-----
TCK	Not used	-----
TMS	Not used	-----
TDO	Not used	-----
TDI	Not used	-----
MIC_CLK	MIC serial clock output from camcorder to PC	-----
MIC_DT	MIC serial data output from camcorder to PC	-----
MON_PLL	Not used	-----
MON_VCOM	To monitor LCD VCOM signal at Pin 10 of IC8001 on LCD C.B.A. This test point is used for "EVF Horizontal free running adjustment" and "LCD VCOM level adjustment."	7.0 Vp-p  Camera Mode (Built in 10 step)
F_VSS	Not used	-----
F_SDA	Not used	-----
F_SCLK	Not used	-----
F_MODE	Not used	-----
F_VEE	Not used	-----

Fig. 6-1

Signal Name (on board)	Description	Waveforms
SCK	Not used	-----
SIO	Not used	-----
MB	Not used	-----
D_GND	Not used	-----
VCC41*	To monitor EVF red signal at Pin 22 of IC8001 on Main C.B.A. This test point is used for "EVF Sub Bright adjustment."	2.15 V (1st step - 1st step)  1 V 20 μs Camera Mode (Built in 10 step)
VCC9*	<b>(For model with Color EVF)</b> To monitor EVF green signal at Pin 20 of IC8001 on Main C.B.A. <b>(For model with Monochrome EVF)</b> To monitor EVF luminance at Pin 20 of IC8001 on the Main C.B.A. This test point is used for "EVF Sub Bright adjustment" and "EVF Contrast/Bright adjustment."	<b>(Color EVF)</b> 2.2 V (1st step - 1st step)  1 V 20 μs Camera Mode (Built in 10 step) <b>(Monochrome EVF)</b> 2.9 V (1st step - 1st step)  1 V 20 μs Camera Mode (Built in 10 step)
F_VCC*	To monitor EVF blue signal at Pin 18 of IC8001 on Main C.B.A. This test point is used for "EVF Sub Bright adjustment."	2.3 V (1st step - 1st step)  1 V 20 μs Camera Mode (Built in 10 step)
F_OE*	To monitor EVF VCOM signal at Pin 16 of IC8001 on Main C.B.A. This test point is used for "EVF VCOM level adjustment."	3.5 Vp-p  1 V 20 μs Camera Mode (Color Bar Chart)
F_BUSY	Not used	-----
MON_CR	Not used	-----
MON_CB	Not used	-----
MON_B	Not used	-----
MON_G	To monitor LCD green signal at Pin 7 of IC8001 on LCD C.B.A. This test point is used for "LCD Contrast/Bright adjustment" and "LCD Sub Bright adjustment."	2.8 V (1st step - 1st step)  1 V 20 μs Camera Mode (Built in 10 step)
HID	To monitor HID signal at Pin 44 of IC3201 on Main C.B.A. This test point is used for "VCR PG shifter adjustment."	2.0 Vp-p  1 V 2 ms Rec/PB Mode
ENVELOPE	To monitor Envelope signal at Pin 41 of IC5001 on Main C.B.A.	0.30 Vp-p  0.1 V 5 ms PB Mode

**\*Note:**

To check for "VCC41," "VCC9," "F\_VCC" or "F\_OE," rotate the LCD Monitor 180 degrees so it faces the same direction as the lens. (EVF display is ON.)

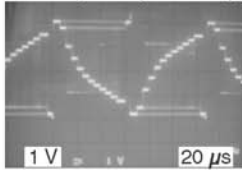
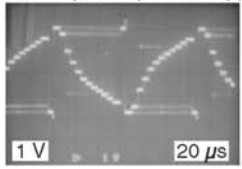
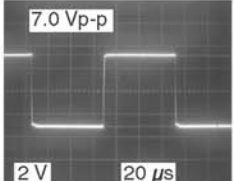
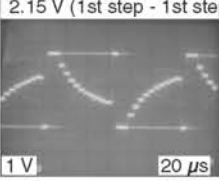
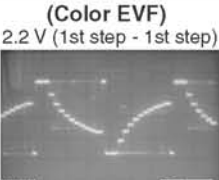
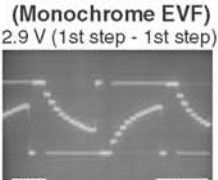
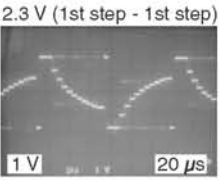
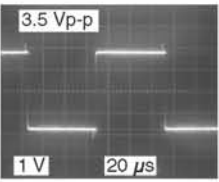
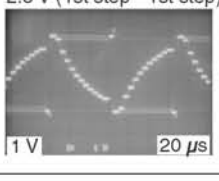
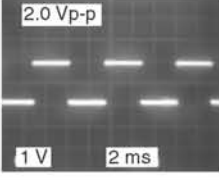
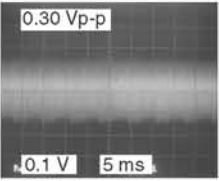
Fig. 6-2

Signal Name (on board)	Description	Waveforms
RF GND	Not used	-----
RECI	Not used	-----
SPA	Not used	-----
ATFI	To monitor ATF signal at Pin 23 of IC3201 on Main C.B.A.	-----
VCO	Not used	-----
TP1	Not used	-----
VREF_+/-	Not used	-----
MA	Not used	-----
CPOB	Not used	-----
FNO	Not used	-----
VREF_H/L	Not used	-----
CAM-A_GND	Grounding terminal	-----
CDS	Not used	-----
CDS/AGC	Not used	-----
ADIN	Not used	-----

Fig. 6-3

### 7.1.7. HOW TO USE THE DVC HEAD CLEANING TAPE / VFK1451

Please use the cleaning tape as described below.

**Note:** This cleaning tape has a total playbacktime of 2 minutes 30 seconds. it can be used 30 times.

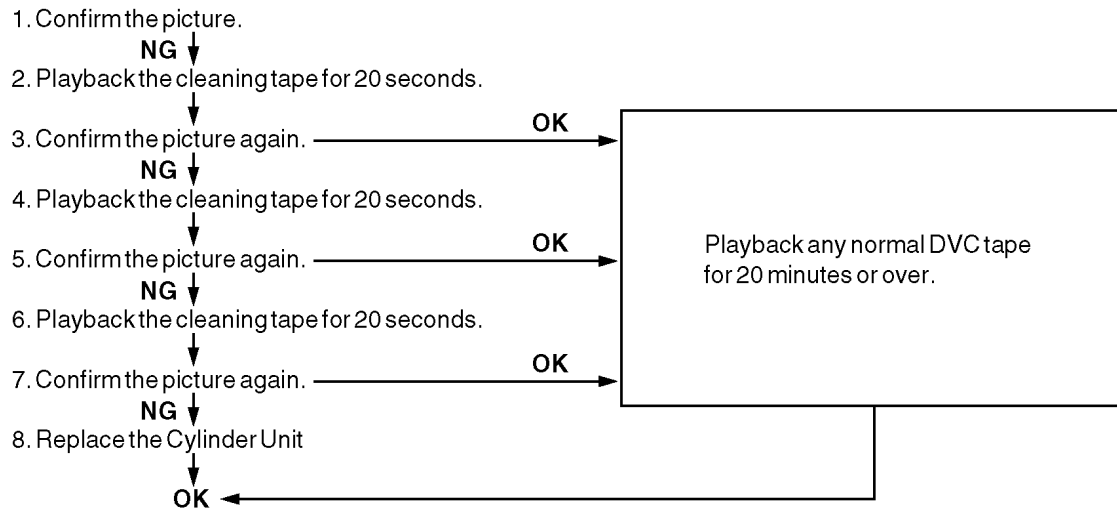

The picture will look like this in case of clogged video head.

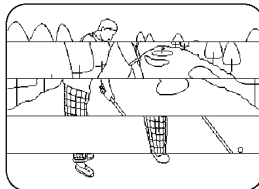

Fig. 7



### **7.1.8. SPECIAL NOTE**

All integrated circuits and many other semiconductor devices are electrostatically sensitive and therefore require the special handling techniques described under the "ELECTROSTATICALLY SENSITIVE (ES) DEVICES" section of this service manual.

## 8 DISASSEMBLY/ASSEMBLY PROCEDURES

### 8.1. CABINET SECTION

#### 8.1.1. DISASSEMBLY FLOWCHART

This flow chart indicates the disassembly steps of the cabinet parts and the P.C.Boards in order to gain access to item (s) to be serviced. When reassembling, perform the step (s) in the reverse order. Bend, route and dress the wires as they were originally.

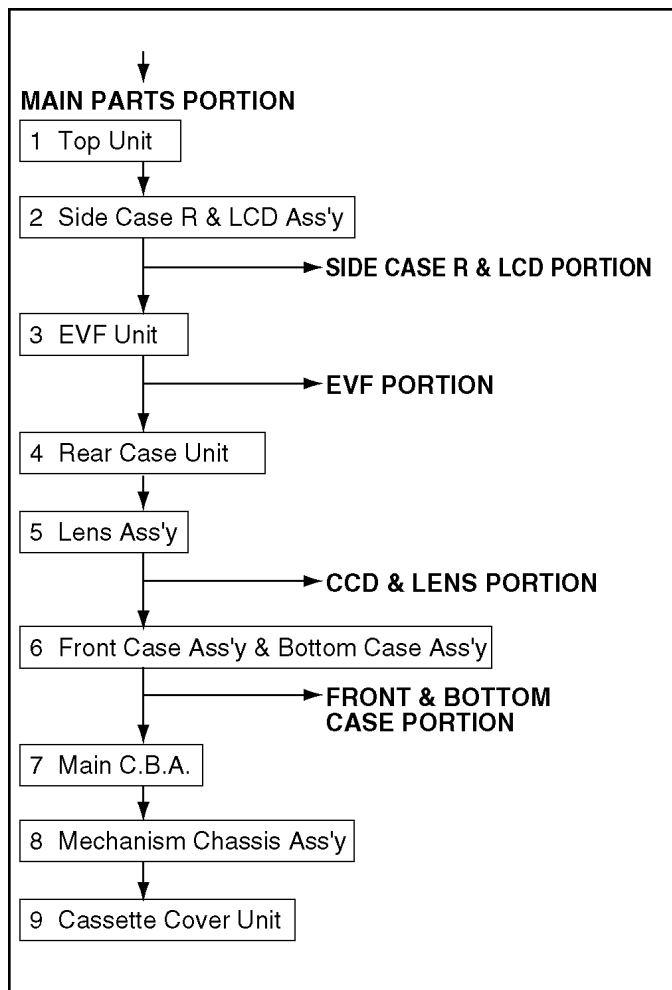

**Note :**

1. When removing the cabinet, work with care so as not to break the Locking Tabs.
2. Place a cloth or some other soft material under the P.C. Boards or Unit to prevent damage.
3. When reinstalling, ensure that the connectors are connected and electrical components have not been damaged.
4. Do not supply power to the unit during disassembly and reassembly.

## 8.1.2. Disassembly Method

### MAIN PARTS PORTION

STEP No.	Ref. No.	PART	Section No.	REMOVE	NOTE
1	⑤②	Top Unit	①	4 ④③③, ⑤④①	1
2	-	Side Case R & LCD Ass'y	①	2 ④⑤①, 4 ⑤③③, FP7, FP8	2
3	⑫②	EVF Unit	①	⑤③③, FP11 or FP9 (For model with Color EVF)	3
4	⑪①	Rear Case Unit	①	2 ④③③, ④⑤①, ⑤③③, ⑤③③ (For model with S-VIDEO) P1, (L-1)	4
5	-	Lens Ass'y	①	2 ⑤③③, FP301, FP701	5
6	-	Front Case Ass'y & Bottom Case Ass'y	①	3 ④③③, FP6, B1	6
7	⑩①①	Main C.B.A.	①	2 ④⑤①, FP1, FP2, FP3, FP4, FP5, FP10	7
8	-	Mechanism Chassis Ass'y	①	3 ④①③	8
9	②②	Cassette Cover Unit	①	-----	-

↑ A    ↑ B    ↑ C    ↑ D    ↑ E    ↑ F

#### How to read chart shown above:

- A: Order of Procedure steps.  
When reassembling, perform steps(s) in reverse order.
- B: Ref No.
- C: Part to be removed or installed.
- D: Section No.
- E: Identification of part to be removed, unhooked, unlocked, released, unplugged, unclamped, or unsoldered.  
3 ④④ = 3 Screws ④④, 2(L-1) = 2 Looking Tabs (L-1)
- F: Refer to "Notes in chart."

# 1 MAIN PARTS SECTION

**Note:**

1. Parts with no Ref. No. in "EXPLODED VIEW" are not supplied. And some Ref. No. will be skipped. Be sure to make your orders of replacement parts according to the parts list.
2. The parts indicated by the dotted line  are for Ass'y only and are not supplied.
3. Disregard Ref. No. suffixes when ordering parts. They are used to describe parts in "Disassembly/Assembly Procedures" section.

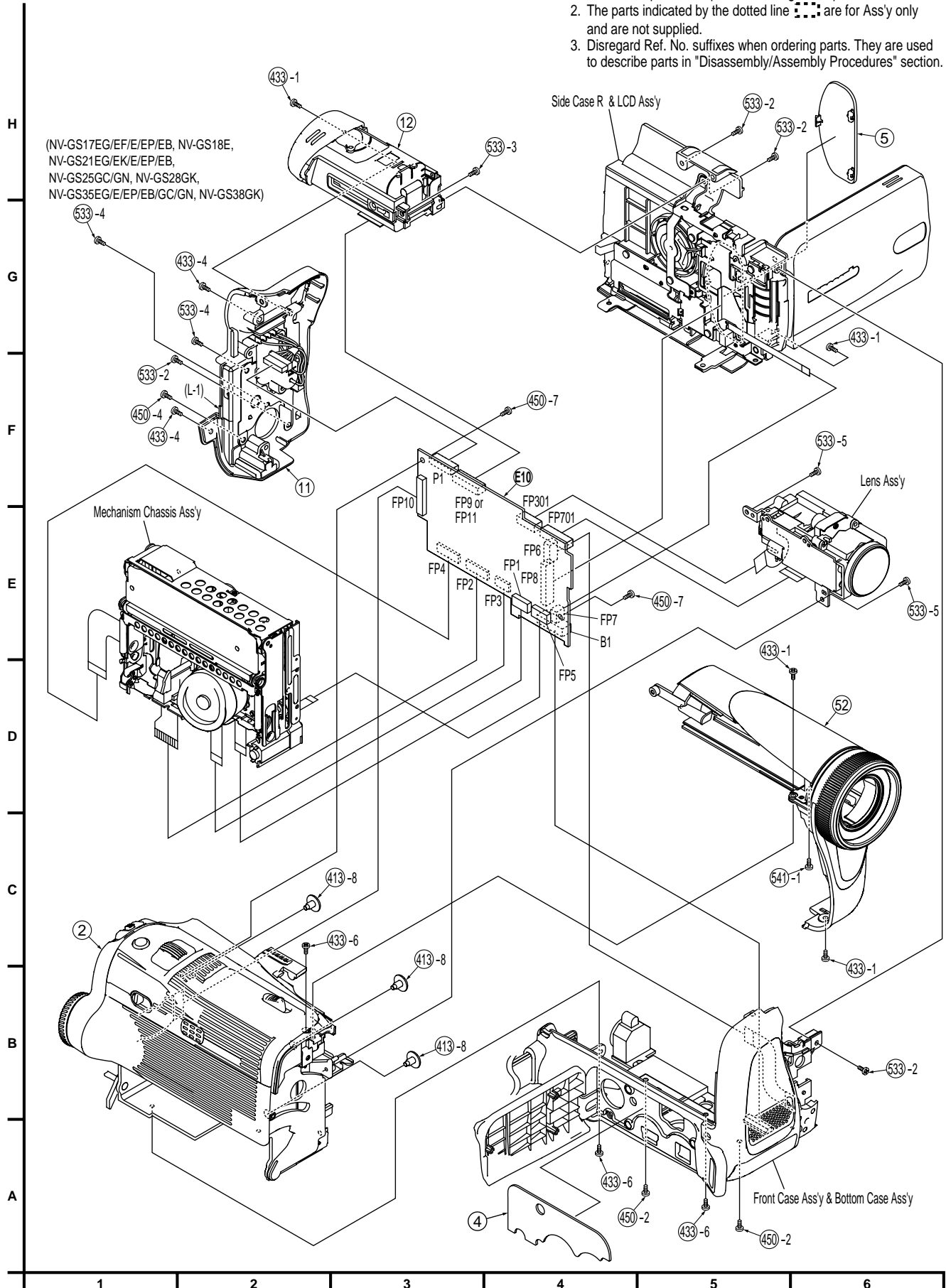

### FRONT & BOTTOM CASE PORTION

STEP No.	Ref. No.	PART	Section No.	REMOVE	NOTE
1	-	Bottom Case Ass'y	2	433, 450	-
2	E30	Jack C.B.A.	2	450, 2 541	9
	-	Bottom Angle Ass'y	2	2 541	

↑ A    ↑ B    ↑ C    ↑ D    ↑ E    ↑ F

STEP No.	Ref. No.	PART	Section No.	REMOVE	NOTE
1	E20	Front C.B.A.	2	4 533, Light Shield Sheet	10
2	56	(For model with Light) Four Eyes Lens	2	-----	10
3	51	Front Case	2	-----	-

↑ A    ↑ B    ↑ C    ↑ D    ↑ E    ↑ F

**How to read chart shown above:**

- A: Order of Procedure steps.  
 When reassembling, perform steps(s) in reverse order.
- B: Ref No.
- C: Part to be removed or installed.
- D: Section No.
- E: Identification of part to be removed, unhooked, unlocked, released, unplugged, unclamped, or unsoldered.  
 3 404 = 3 Screws 404, 2(L-1) = 2 Looking Tabs (L-1)
- F: Refer to "Notes in chart."



### SIDE CASE R & LCD PORTION

STEP No.	Ref. No.	PART	Section No.	REMOVE	NOTE
1	③①	Side Case R Unit	③	④①⑨, ④⑤⑦	11
2	③③	LCD Case A Unit	③	2④⑤⑤, 8(L-1)	-
3	③②	Shaft Case Unit	③	FP8101	11
4	④④①	LCD Backlight C.B.A.	③	⑤④② (L-2), FP8102	12
5	③④	LCD Case B	③	4(L-3)	12
6	-	LCD Panel Ass'y	③	3(L-4)	12
	③⑤	LCD Shield Case Unit			

↑ A    ↑ B    ↑ C    ↑ D    ↑ E    ↑ F

STEP No.	Ref. No.	PART	Section No.	REMOVE	NOTE
1	④②	LCD Panel	③	-----	13
2	③⑨	Reflect Sheet	③	(L-5)	13
3	③⑦	Lead Light Panel	③	-----	13
4	③⑧	Diffusion Sheet	③	-----	13
5	④①	BEF Sheet	③	-----	13
6	④①	BEF Sheet A	③	-----	13
7	③⑥	Panel Holder Unit	③	-----	13

↑ A    ↑ B    ↑ C    ↑ D    ↑ E    ↑ F

**How to read chart shown above:**

- A: Order of Procedure steps.  
When reassembling, perform steps(s) in reverse order.
- B: Ref No.
- C: Part to be removed or installed.
- D: Section No.
- E: Identification of part to be removed, unhooked, unlocked, released, unplugged, unclamped, or unsoldered.  
③④④ = 3 Screws ④①④, 2(L-1) = 2 Looking Tabs (L-1)
- F: Refer to "Notes in chart."





**CCD & LENS PORTION**

STEP No.	Ref. No.	PART	Section No.	REMOVE	NOTE
1	Ⓔ50	CCD C.B.A.	4	2Ⓔ530	14
2	Ⓔ64	Filter Rubber	4	-----	14
3	Ⓔ63	Optical Filter	4	-----	14
4	Ⓔ62	(For model with 20,24X zoom) Filter Holder	4	-----	14

↑ A    ↑ B    ↑ C    ↑ D    ↑ E    ↑ F

STEP No.	Ref. No.	PART	Section No.	REMOVE	NOTE
1	Ⓔ65	Zoom Motor Unit	4	2Ⓔ530, Unsolder	15
2	Ⓔ66	Focus Motor Unit	4	2Ⓔ530, Ⓔ533 (For model with 30X zoom), Unsolder	15

↑ A    ↑ B    ↑ C    ↑ D    ↑ E    ↑ F

**How to read chart shown above:**  
 A: Order of Procedure steps.  
     When reassembling, perform steps(s) in reverse order.  
 B: Ref No.  
 C: Part to be removed or installed.  
 D: Section No.  
 E: Identification of part to be removed, unhooked, unlocked, released, unplugged, unclamped, or unsoldered.  
     3Ⓔ404 = 3 Screws Ⓔ404, 2(L-1) = 2 Looking Tabs (L-1)  
 F: Refer to "Notes in chart."

## 4 CCD AND LENS SECTION

### Note:

1. Parts with no Ref. No. in "EXPLODED VIEW" are not supplied. And some Ref. No. will be skipped. Be sure to make your orders of replacement parts according to the parts list.
2. The parts indicated by the dotted line  are for Ass'y only and are not supplied.
3. Disregard Ref. No. suffixes when ordering parts. They are used to describe parts in "Disassembly/Assembly Procedures" section.

### LUBRICATION POINTS

When the marked parts are replaced, apply the recommended lubricants or adhesive for better maintenance of the unit.

Mark	Kind of Lubricant	Availability	Part Number
<input type="checkbox"/> <input type="checkbox"/>	Grease	Available from Factory	LSUQ0050

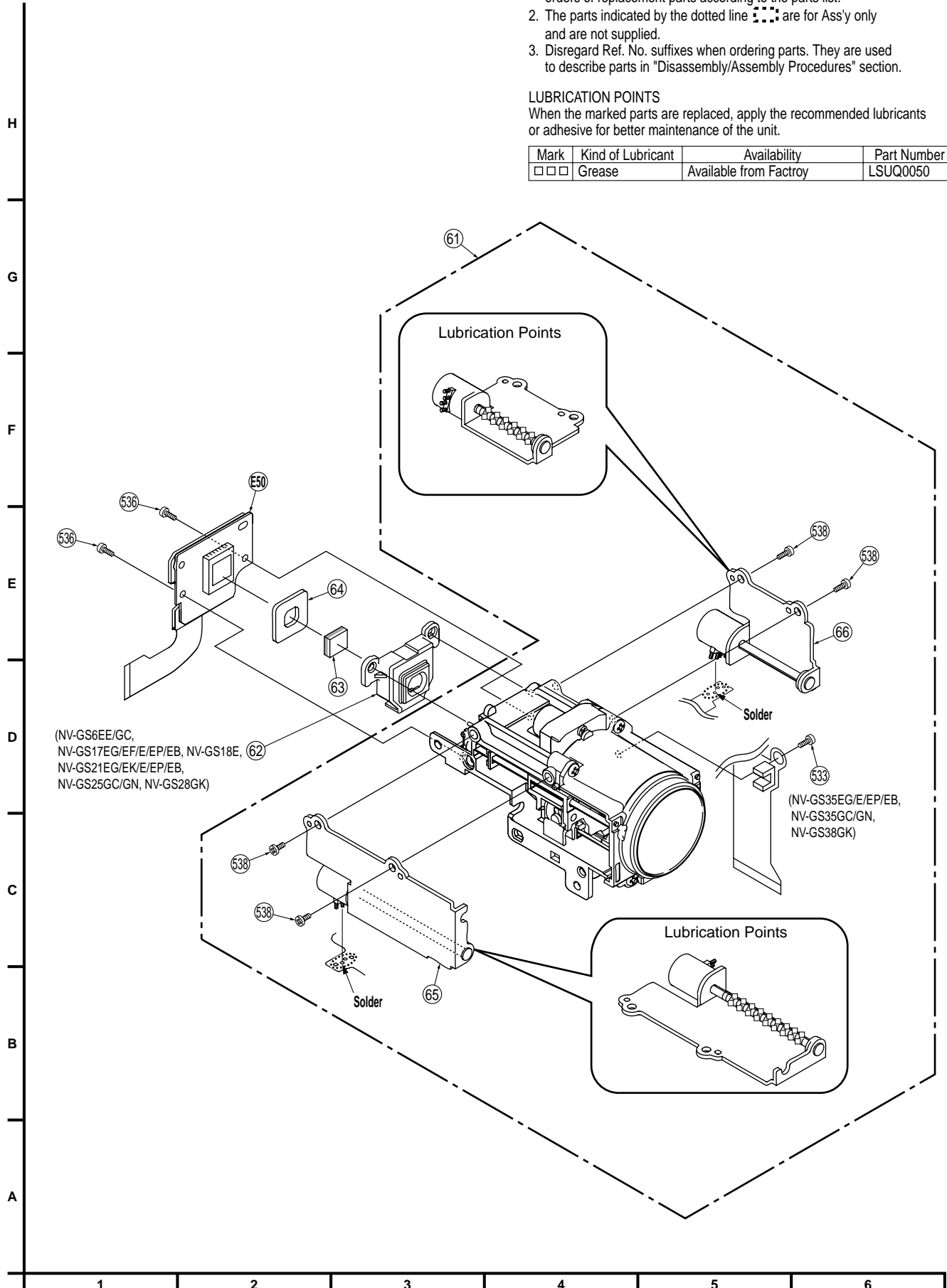

**EVF PORTION**

STEP No.	Ref. No.	PART	Section No.	REMOVE	NOTE
1	⑩①⑥	EVF Slide Piece	⑤	2④⑤①	16
2	⑩①③ ⑩①⑤	EVF Base Frame EVF Earth Plate	⑤	2(L-1)	16
3	⑩①④	EVF Spring	⑤	④⑤①, (L-2)	17
4	⑩①⑦	EVF F.P.C.	⑤	FP951	17

↑ A      ↑ B                  ↑ C                  ↑ D                  ↑ E                  ↑ F

STEP No.	Ref. No.	PART	Section No.	REMOVE	NOTE
1	⑩①⑧	Eye Cap	⑤	2④②④	18
2	⑩②③	EVF Lens Unit	⑤	-----	19
3	⑩②②	Eye Sight Lever	⑤	-----	19

↑ A      ↑ B                  ↑ C                  ↑ D                  ↑ E                  ↑ F

**How to read chart shown above:**

- A: Order of Procedure steps.  
When reassembling, perform steps(s) in reverse order.
- B: Ref No.
- C: Part to be removed or installed.
- D: Section No.
- E: Identification of part to be removed, unhooked, unlocked, released, unplugged, unclamped, or unsoldered.  
3④① = 3 Screws ④①, 2(L-1) = 2 Looking Tabs (L-1)
- F: Refer to "Notes in chart."

## 5 EVF SECTION

**Note:**

1. Parts with no Ref. No. in "EXPLODED VIEW" are not supplied. And some Ref. No. will be skipped. Be sure to make your orders of replacement parts according to the parts list.
2. The parts indicated by the dotted line  are for Ass'y only and are not supplied.
3. Disregard Ref. No. suffixes when ordering parts. They are used to describe parts in "Disassembly/Assembly Procedures" section.

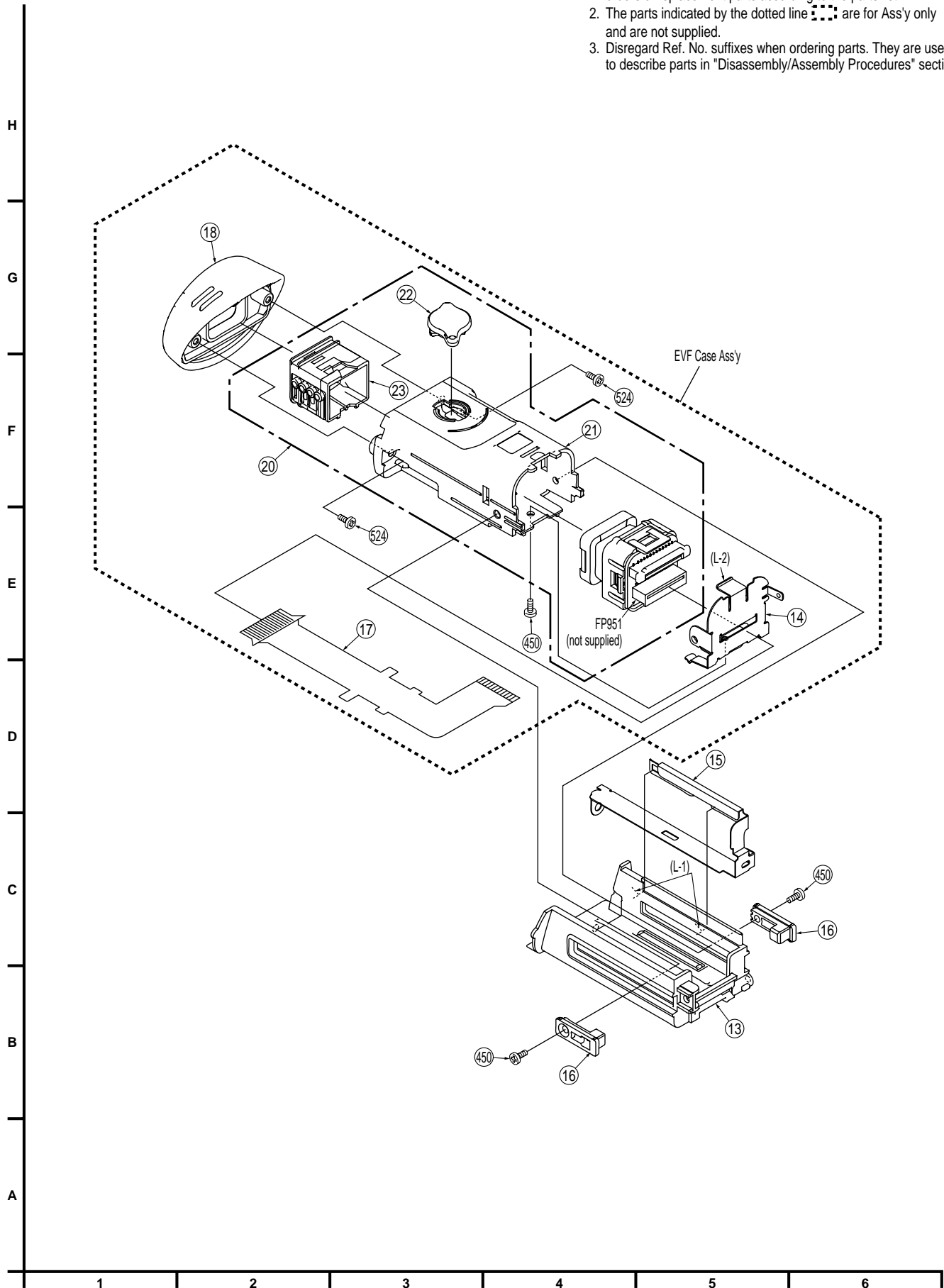

## Notes in chart

### 1. Removal of Top Unit

- 1) Open the LCD and the Cassette Cover, then remove the 5 Screws (433, 541).
- 2) Slide to extend the EVF.
- 3) Pull and slide the Top Unit carefully.

### Installation of Top Unit

- 1) Slide to extend the EVF.
- 2) Insert Portion A of the Top Unit, and slide firmly to install.

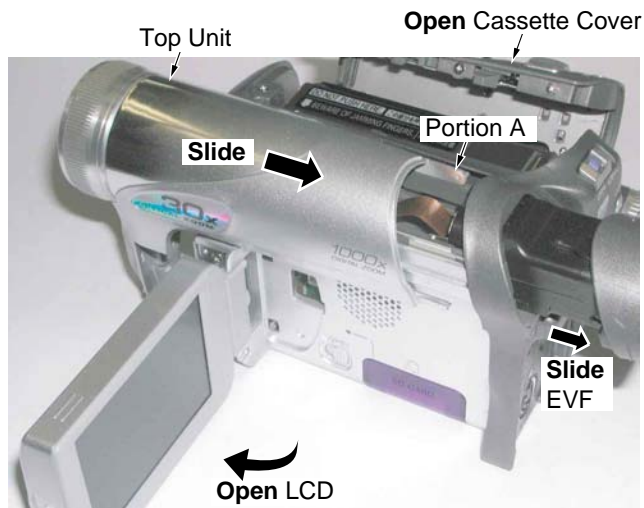

### 2. Installation of Side Case R & LCD Ass'y

- 1) Connect the LCD F.P.C. and Side R F.P.C. to the Connectors FP7 and FP8 so as not to damage the F.P.C.s.
- 2) Secure Front Portion and Rear Portion, and tighten 6 Screws (450, 533)

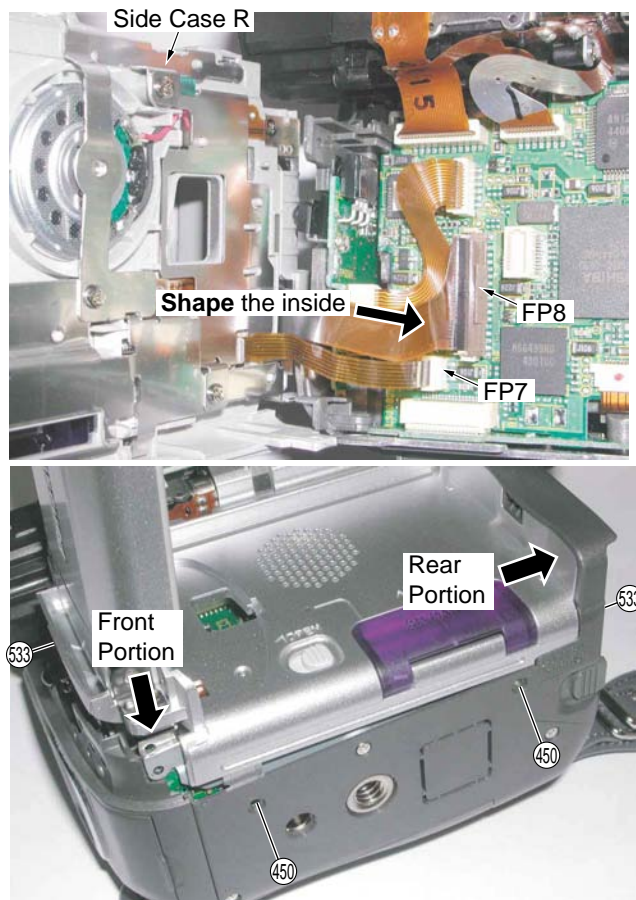

### 3. Installation of EVF Unit

- 1) Confirm that the EVF F.P.C. is hooked to the Hooking Portions on the Bottom.
- 2) Install the EVF Unit while holding the EVF F.P.C. to avoid damage of the EVF F.P.C.

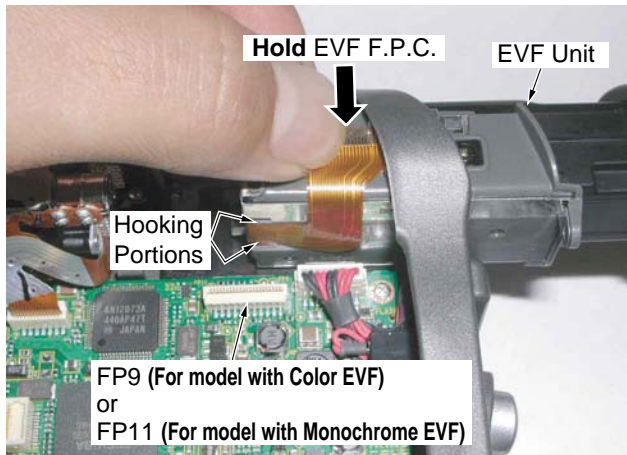

Fig. D3

### 4. Installation of Rear Case Unit

- 1) Position connector leads so as not to cover Portion A.

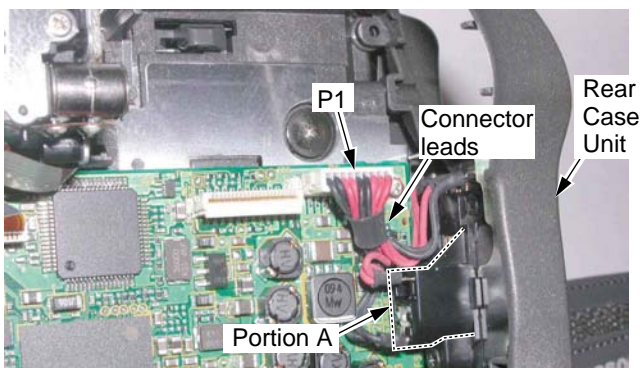
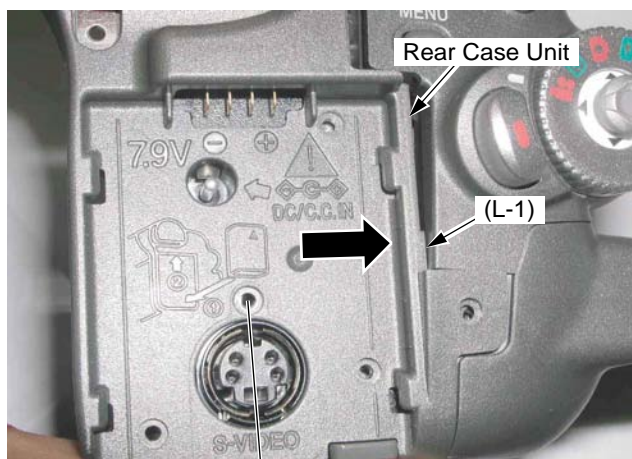

Fig. D4-1

- 2) Secure the Locking Tab (L-1) of the Rear Case Unit to install it.



533 (For model with S-VIDEO)

Fig. D4-2

### 5. Installation of Lens Ass'y

- Take care not to damage the motor leads.  
Install the Lens Ass'y with the 2 Bosses and 2 Screws (533).

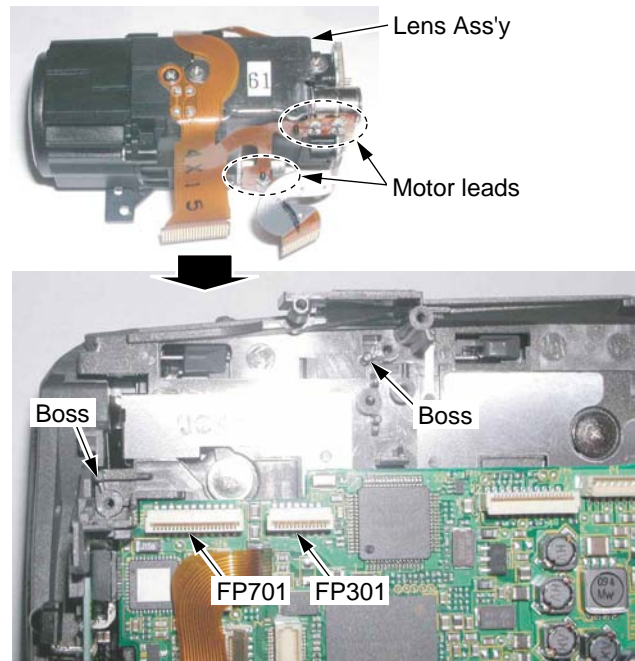

Fig. D5

### 6. Removal of Front Case Ass'y & Bottom Ass'y

- 1) Disconnect the Front F.P.C. from the Connector FP6.
- 2) Open the Cassette Cover and remove the 3 Screws (433).
- 3) Remove both the Front Case Ass'y & Bottom Case Ass'y and continue to grasp them, while disconnecting the Connector B1.

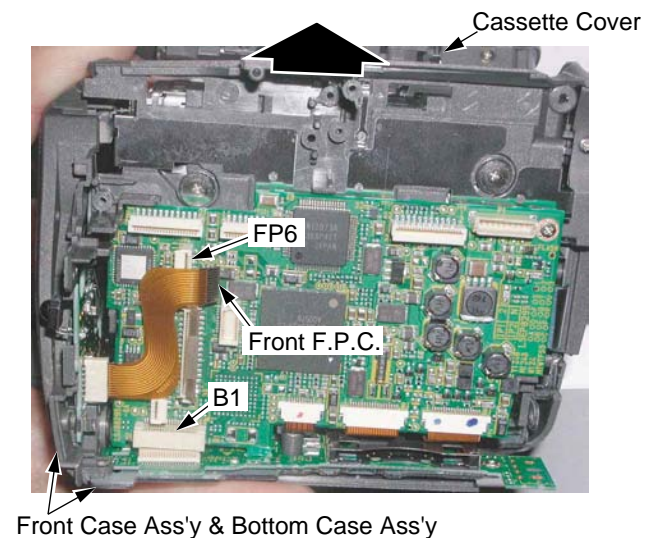

Fig. D6

#### Alternative method:

If necessary, the Front Case Ass'y can be removed at first.

**7. Installation of Main C.B.A.**

Take care not to damage the F.P.C.s.

- 1) Connect the Zoom Switch F.P.C. to the Connector FP10 on the Main C.B.A.
- 2) Connect the F.P.C.s to the connectors on the Main C.B.A, verifying that the direction of the Flexible Cables is correct. Refer to "REMOVAL/INSTALLATION OF F.P.C. FROM NON ZIF (Zero Insertion Force) CONNECTOR."
- 3) After installing the Main C.B.A., confirm the F.P.C.s are positioned as shown.

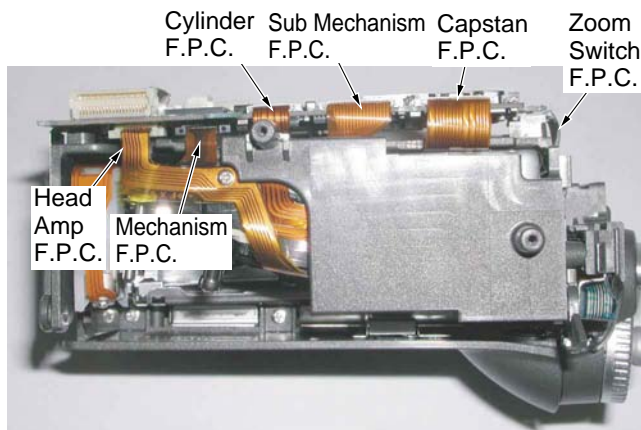

Fig. D7

**8. Installation of Mechanism Chassis Ass'y**

Take care not to damage the F.P.C.s.

- 1) After installing the Mechanism Chassis Ass'y, confirm the F.P.C.s are positioned as shown.

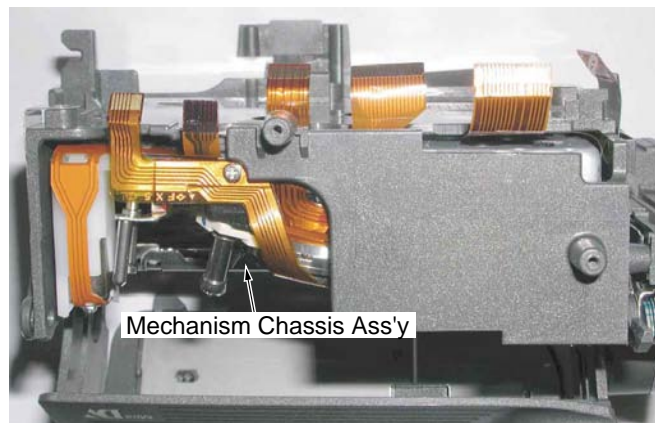

Fig. D8-1

**Replacement of Mechanism Chassis Ass'y**

When replacing the Main Chassis Ass'y or the Cylinder Unit, be sure to perform the Envelope Output Adjustment. Refer to "ENVELOPE OUTPUT ADJUSTMENT" in MECHANICAL ADJUSTMENT.

**Handling Caution of Mechanism Chassis Ass'y**

When servicing the Mechanism Chassis Ass'y without the Cassette Up Unit, do not handle the Sub Chassis of the Mechanism Chassis Ass'y.

Mechanism Chassis Ass'y  
(without Cassette Up Unit)

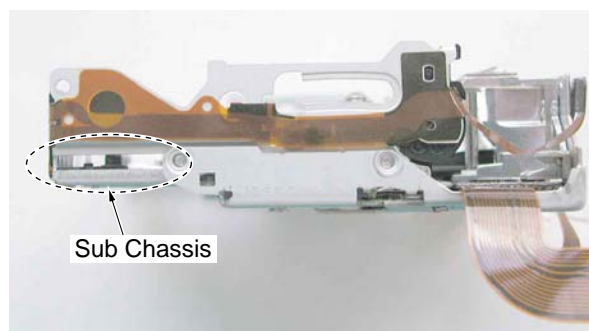
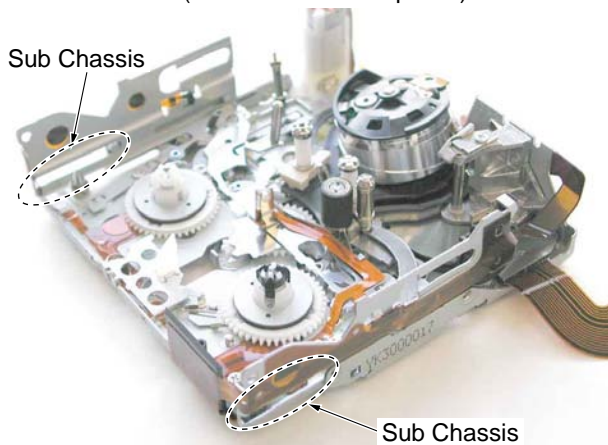

<Side View>

Fig. D8-2

### 9. Removal of Jack C.B.A. & Bottom Angle Ass'y

- 1) Open the L Cover.
- 2) Remove the Screw (450) and release the Tripod Portion from the hole.

### Installation of Jack C.B.A. & Bottom Angle Ass'y

Insert both the Jack C.B.A. & Bottom Angle Ass'y into the 2 slots and secure the Tripod into the hole.

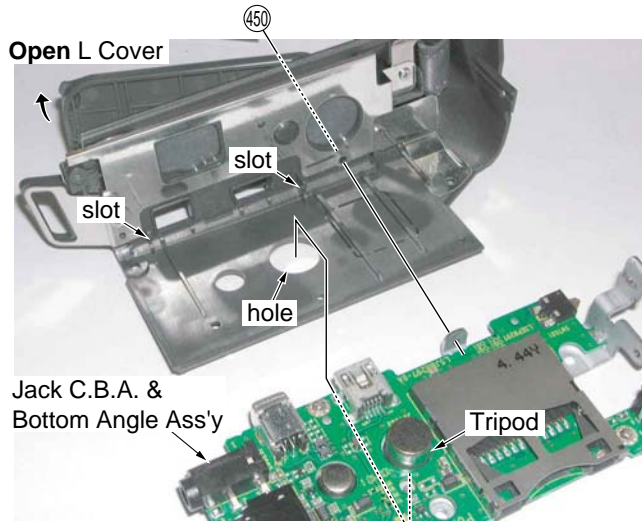

Fig. D9

### 10. Installation of Front C.B.A.

- 1) Install the Four Eyes Lens (For model with Light) into the Front Case. Then, install the Front C.B.A. with 2 bosses of the Four Eyes Lens and 2 Screws (533).
- 2) Install the Light Shield Sheet with 2 Screws (533).

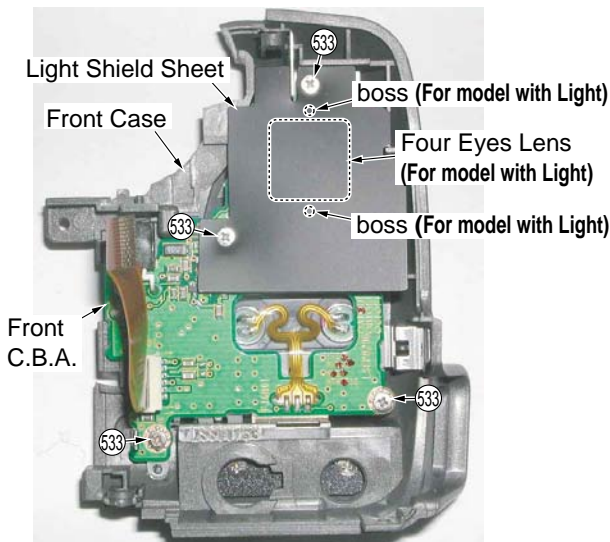

Fig. D10

### 11. Removal of Side Case R Unit

Open and rotate the LCD to access the 2 Screws (419, 457) as shown below, then remove it.

### Installation of Side Case R Unit

When installing, note to the direction of the Shaft Case Unit. Be sure to install the LCD (Ass'y) into the Side Case R Unit with the LCD rotated as shown. Otherwise, the LCD open/close switch on the Side Case R Unit will be damaged.

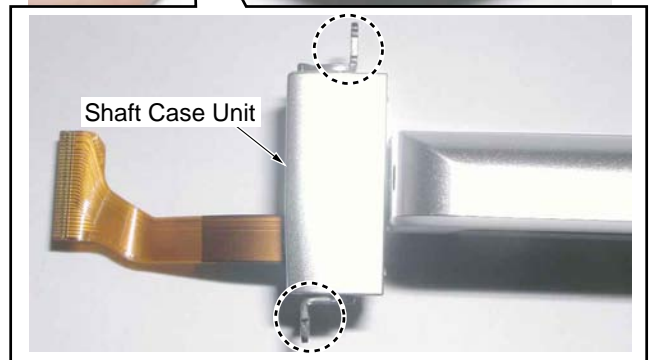
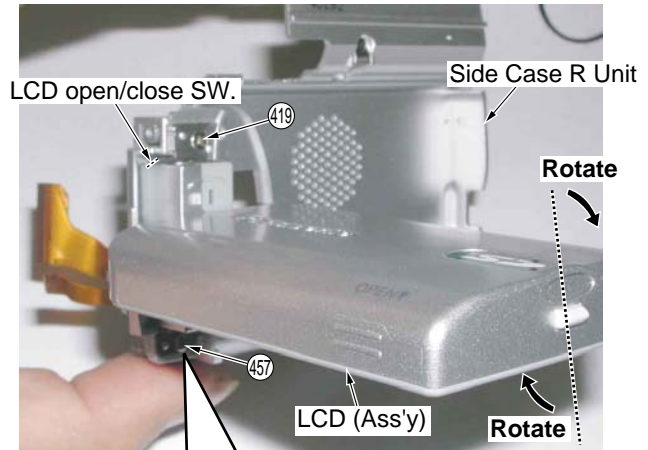

Fig. D11



**12. Installation of LCD Backlight C.B.A., LCD Panel Ass'y, LCD Shield Case Unit, LCD Case B**

Use extreme care regarding LEDs when handling the LCD Backlight C.B.A.

Install in order shown below.

- 1) Install the LCD Panel Ass'y onto the LCD Shield Case Unit with the 3 Locking Tabs (L-4) while carefully bending the LCD F.P.C. at it's base so as not to damage it.
- 2) Install the LCD Shield Case into the LCD Case B with the 4 Locking Tabs (L-3).
- 3) Install the LCD Backlight C.B.A. onto the LCD Panel Ass'y with the Locking Tab (L-2).
- 4) Tighten the Screw (542) while keeping the LCD Backlight C.B.A. pressed toward the right. Then, connect the Connector FP8102.

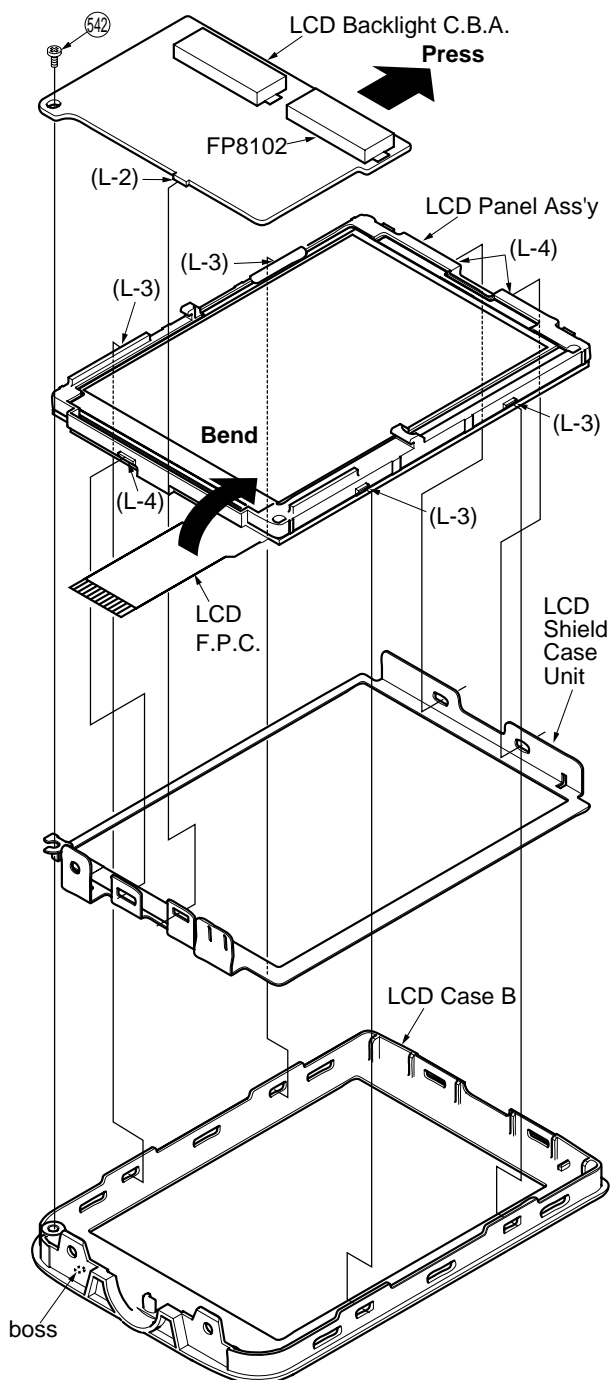

Fig. D12

### 13. Installation of LCD Panel, Reflect Sheet, Lead Light Panel, Diffusion Sheet, BEF Sheet, BEF Sheet A, Panel Holder Unit

a. When replacing the LCD Panel, the Diffusion Sheet, the BEF Sheet and the BEF Sheet A, make sure to remove the Protection Sheets.

**To distinguish Sheets from attached Protection Sheet:**

- A blue Protection Sheet is affixed to both faces of the Diffusion Sheet.
- A yellow Protection Sheet is affixed to both faces of the BEF Sheet.
- A transparent Protection Sheet is affixed to both faces of the BEF Sheet A.

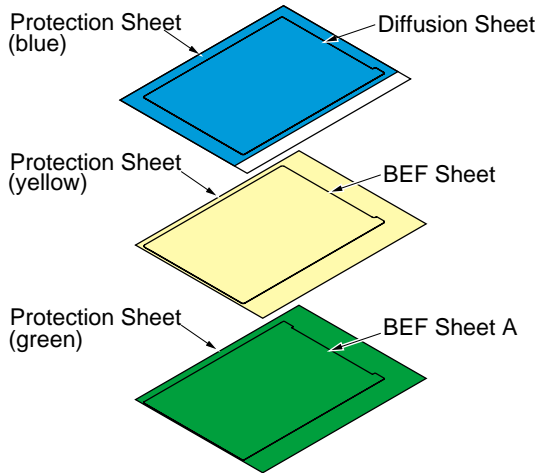

b. Use extreme care when handling the LCD Panel, the Reflect Sheet, the Lead Light Panel, the Diffusion Sheet, the BEF Sheet and the BEF Sheet A to avoid damage, dust, and spots (especially fingerprints, etc.)

Install in order shown below.

- 1) Install in order the BEF Sheet A, BEF Sheet and Diffusion Sheet while inserting the corners of each sheets into the slots of the Panel Holder Unit.
- 2) Install the Lead Light Panel while inserting the corners into the slots of the Panel Holder Unit.
- 3) Align the Reflect Sheet with the edge of the Panel Holder Unit, and install it using adhesive tape on the Reflect Sheet.

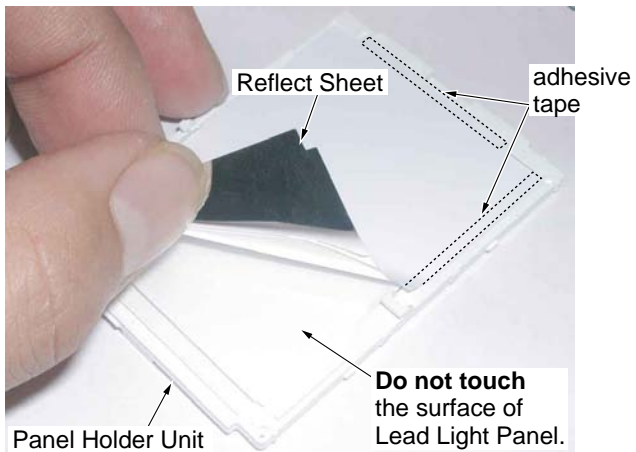

Fig. D13-1

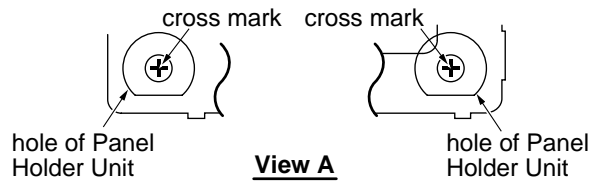
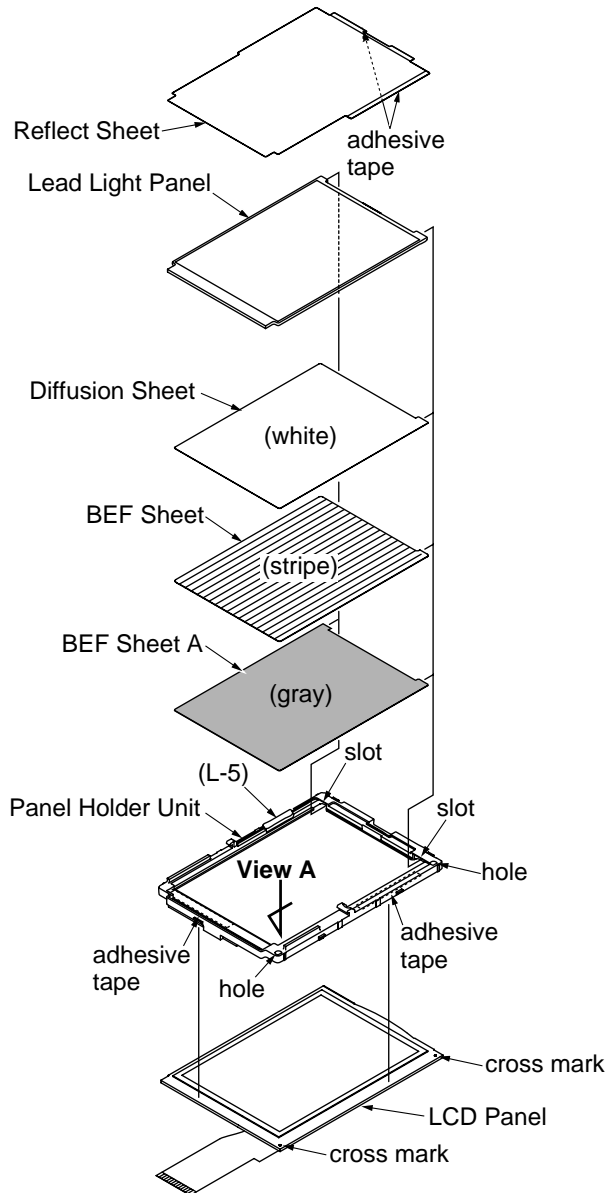

Fig. D13-2

- 4) Install the LCD Panel with adhesive tape so that the cross marks are positioned in the center of the holes in the Panel Holder Unit.

**14. Removal of CCD C.B.A., Filter Rubber, Optical Filter, Filter Holder**

**CAUTION:**

- 1) When removing the CCD C.B.A., take care that the Optical Filter does not fall out.
- 2) Use extreme caution when removing the CCD C.B.A. as it is easily damaged by static electricity. Use a Wrist Strap while removing and installing.
- 3) Do not touch the CCD window surface.

**Installation of CCD C.B.A., Filter Rubber, Optical Filter, Filter Holder**

Install in order shown below.

- 1) Install the Filter Holder (**For model with 30X zoom**) correctly.
- 2) Install the Optical Filter correctly.  
**Note:** Make sure that no dust gets on the Optical Filter or in the Lens Unit. Clean the Optical Filter with lens cleaning paper dampened with lens cleaner if necessary.
- 3) Install the Filter Rubber on the Optical Filter correctly as shown below.  
**Note:** Make sure that no dust gets on the Filter Rubber.
- 4) Install the CCD C.B.A. into the Lens Unit. Then, tighten the 2 Screws (536).  
**Note:** Do not touch the Lens Surface. Clean the surface with lens cleaning paper dampened with lens cleaner if necessary.

**15. Installation of Zoom Motor Unit/Focus Motor Unit**

Install the Zoom Motor Unit/Focus Motor Unit so that the Shaft of the Zoom Motor Unit/Focus Motor Unit is set in the Holder.

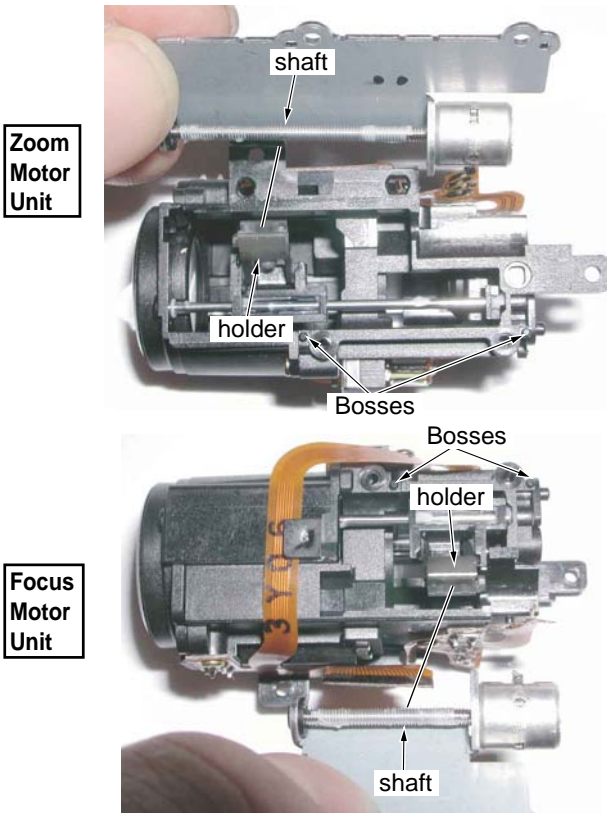

Fig. D15

**16. Installation of EVF Slide Piece, EVF Base Frame**

- 1) Pass the EVF F.P.C. through the EVF Base Frame hole.
- 2) Install the EVF Slide Pieces into the EVF Base Frame from both sides.
- 3) Slide the EVF Case Ass'y to the end so that the ribs are inserted into the holes of the EVF Slide Pieces.
- 4) Locate the threaded holes, and tighten the 2 Screws (450).
- 5) After installing, confirm the EVF moves correctly.

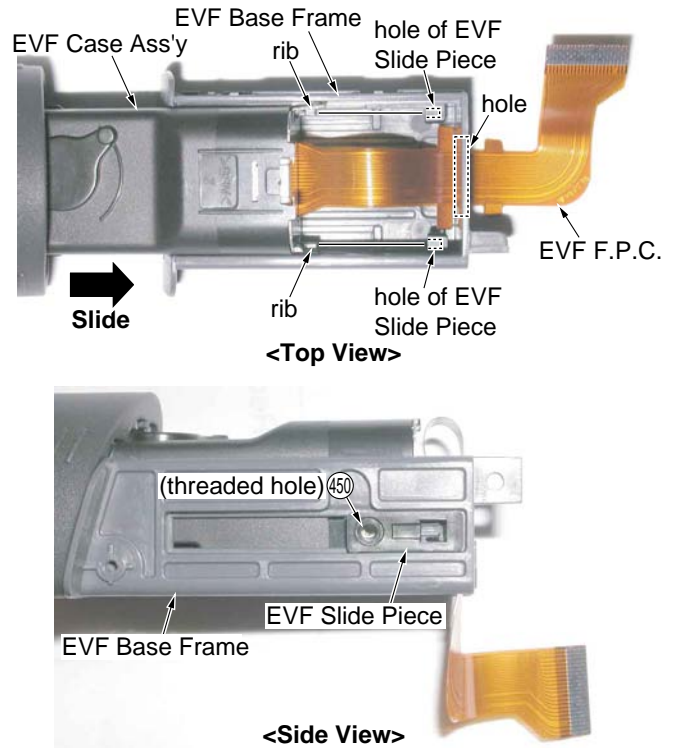

Fig. D16

**17. Installation of EVF Spring, EVF F.P.C.**

- 1) Insert the EVF F.P.C. into the EVF Spring hole paying particular attention to the direction.
- 2) Connect the EVF F.P.C. to Connector FP951.
- 3) Insert the Locking Tab (L-2) at first, then fit the EVF Spring in the EVF Case and tighten the Screw (450).

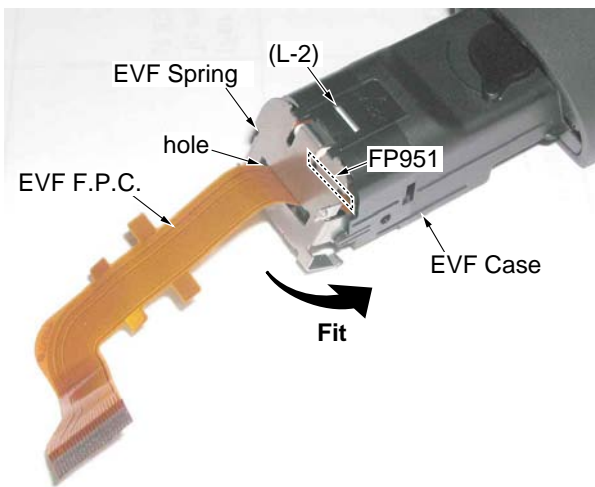

Fig. D17

**18. Removal of Eye Cap**

Remove the Eye Cap after removing the 2 Screws (524).

**19. Handling cautions of EVF Lens Unit**

Use extreme care when handling the EVF Lens Unit to avoid damage, dust, and spots (especially fingerprints, etc.)

**Installation of EVF Lens Unit, Eye Sight Lever**

- 1) Install the Eye Sight Lever into the EVF Case hole in the direction shown.
- 2) Install the EVF Lens Unit into the EVF Case while grasping both sides of the springs with tweezers, etc.
- 3) After installing, confirm the Eye Sight Lever and the EVF Lens Unit work together correctly.

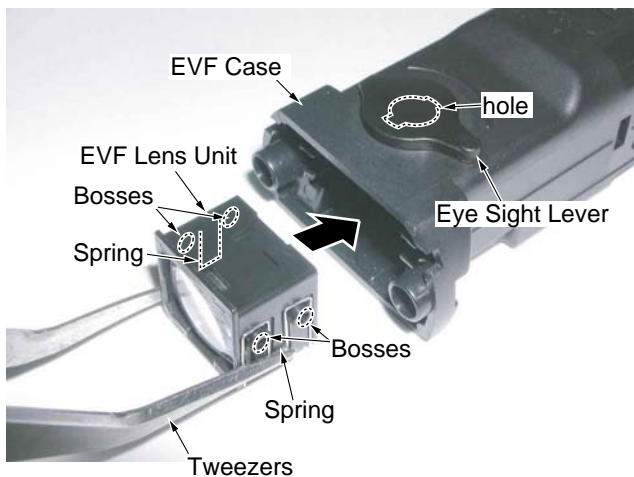

Fig. D19

## 8.2. MECHANISM SECTION

### Flow-Chart for Disassembly Procedures

No.	Item / Part	Fig.	Removal (Screw, Connector, Flex. & Other)
1	Cassette Up Unit	Fig. M1 Fig. M2 Fig. M3 Fig. M4	It makes the mechanism position in Eject condition (For Battery) 3-Screws (A)
2	Cylinder Unit	Fig. M5 Fig. M6	1-Screw (B) 3-Screw (C) Cylinder Unit

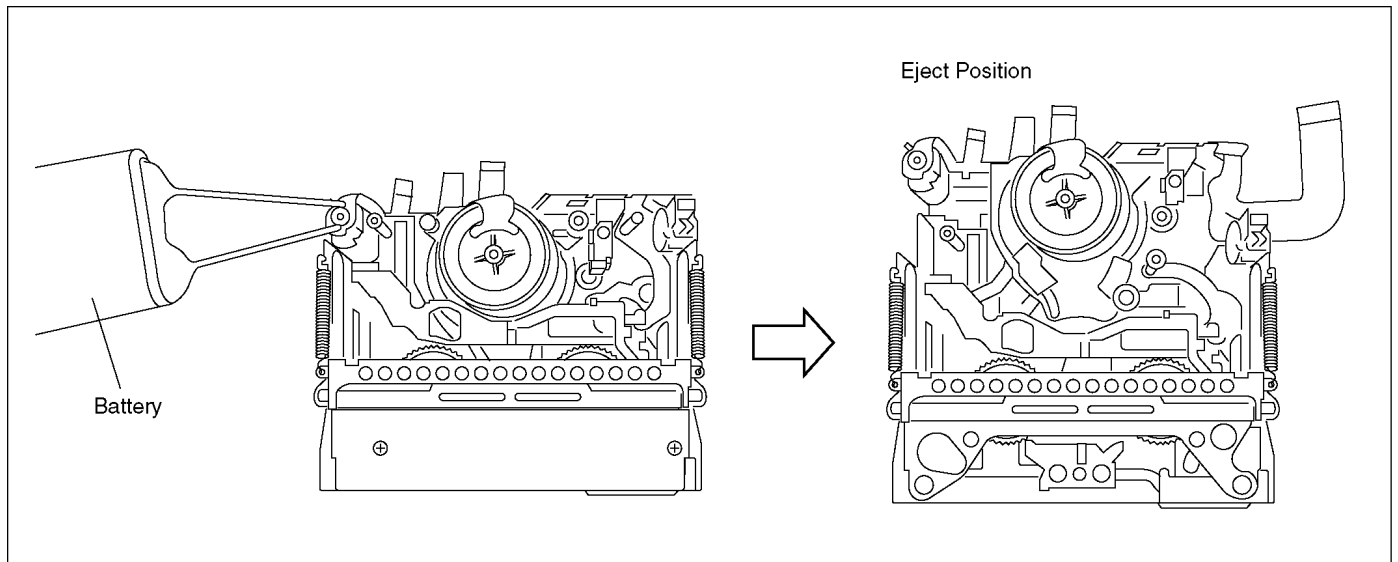

Fig. M1

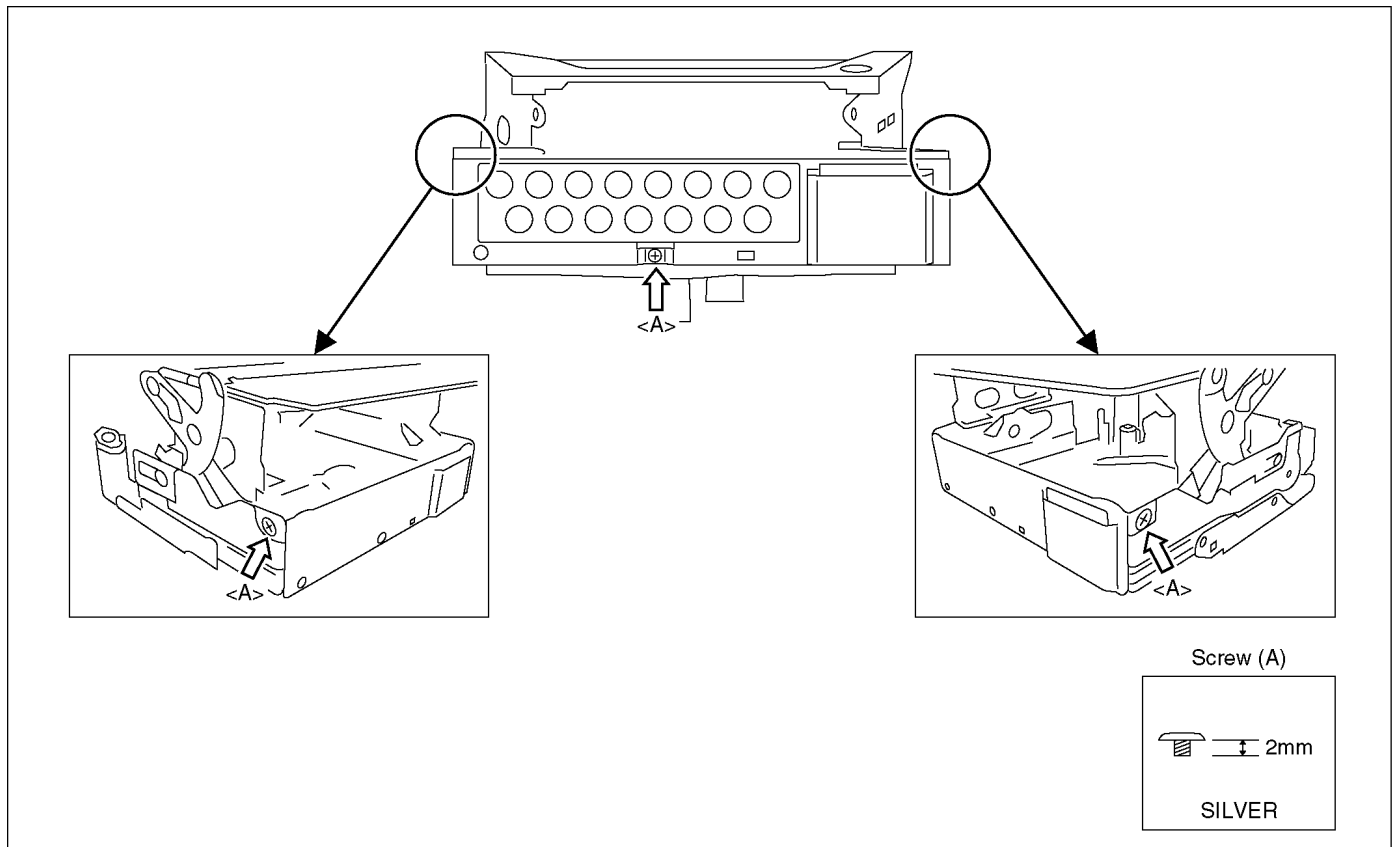

Fig. M2

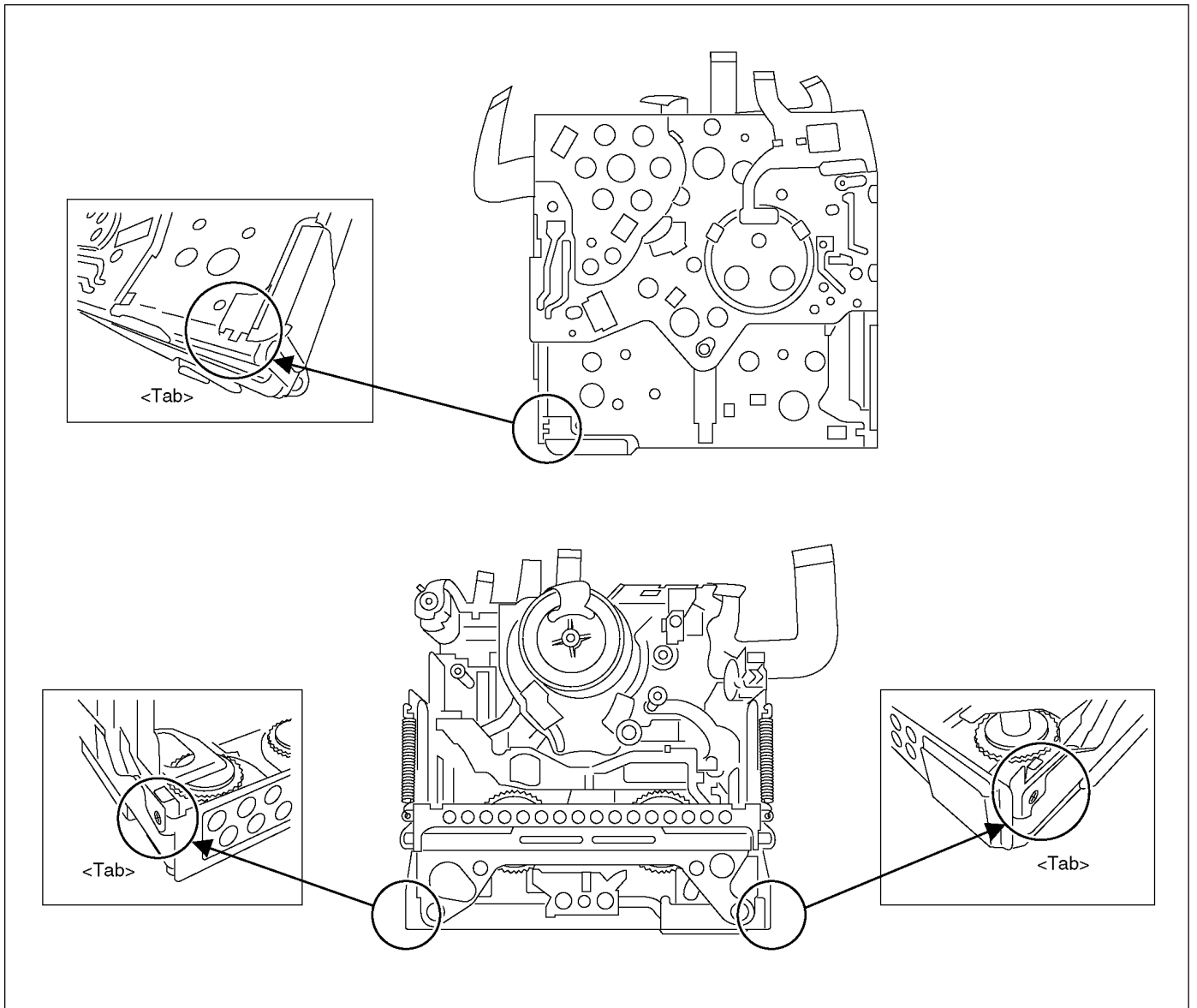

Fig. M3

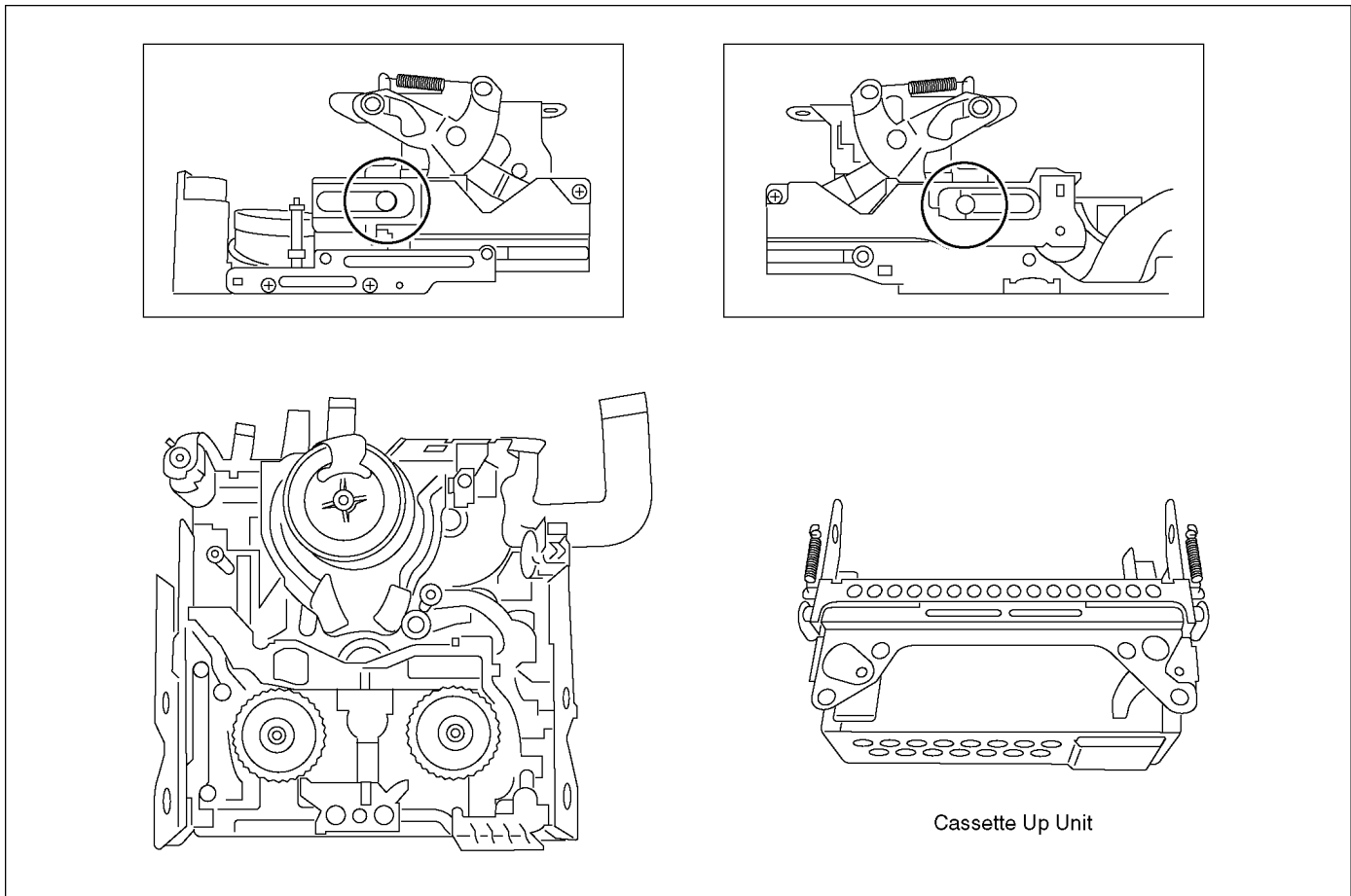

Fig. M4

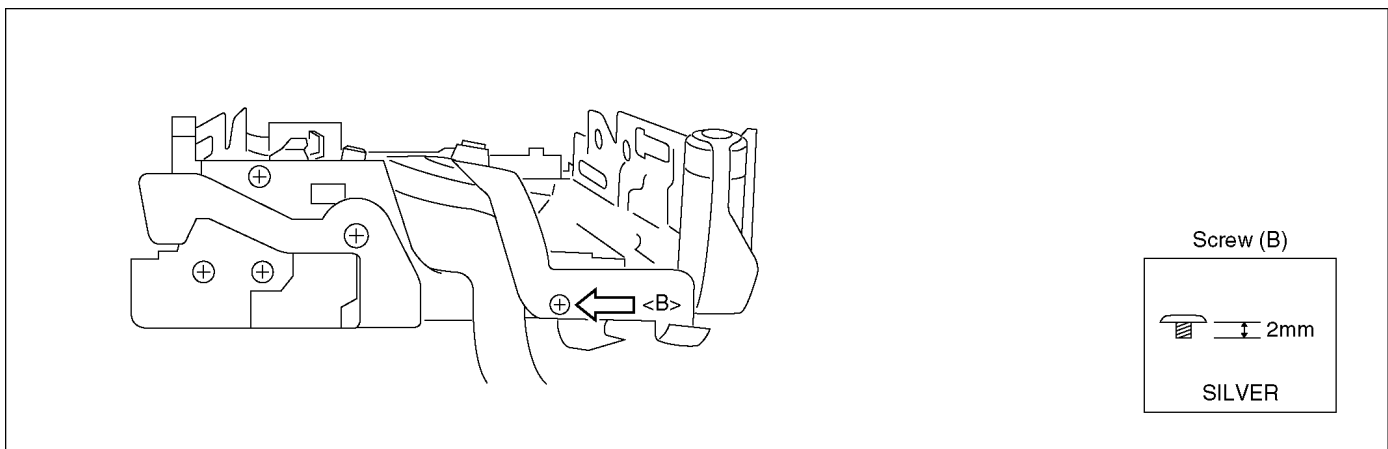

Fig. M5

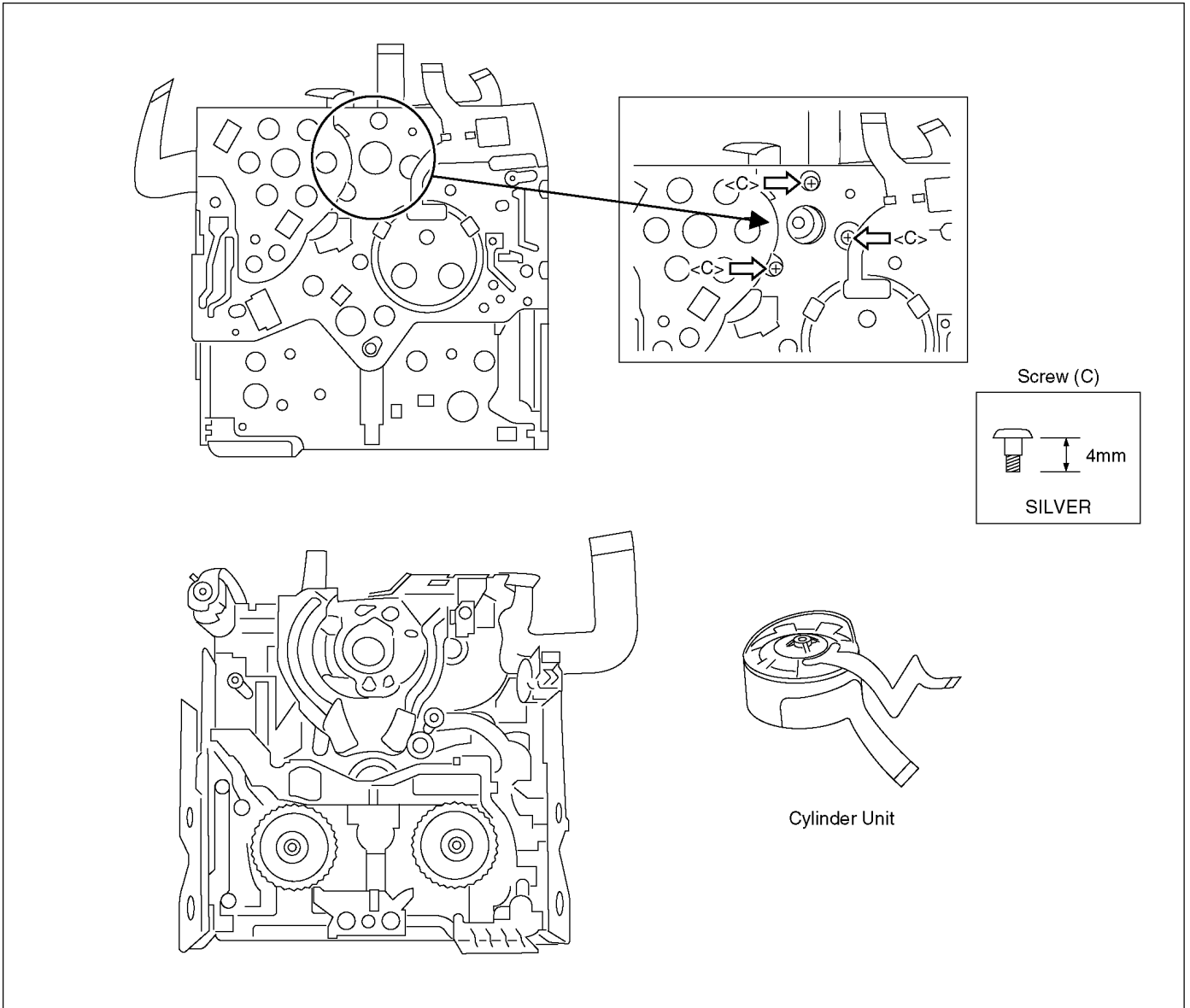
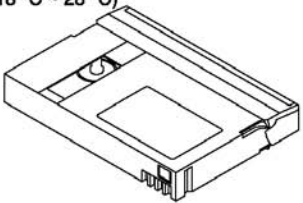
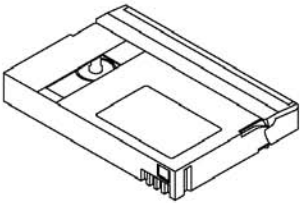

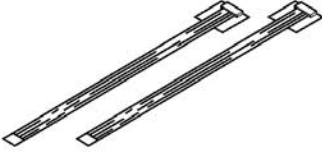
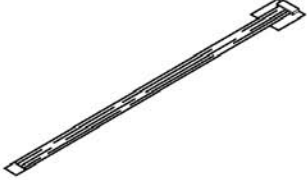
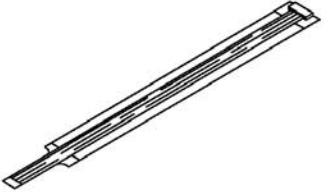
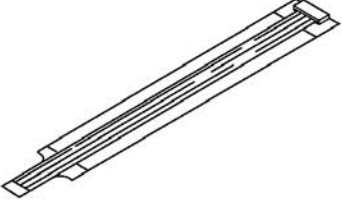

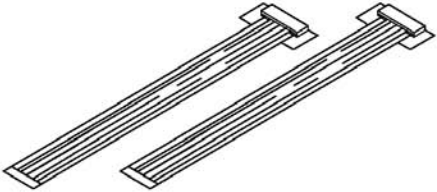

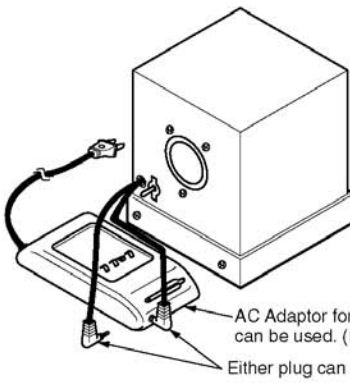
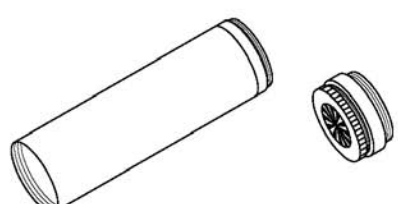









Fig. M6



# 9 ADJUSTMENT PROCEDURES

## 9.1. SERVICE FIXTURES & TOOLS

<p><b>Color Bar Standard Tape</b>                  (Keeping condition:                  Keep at 18 °C ~ 28 °C)</p> <p><b>VFM3110EDS</b></p> 	<p><b>DVC Head Cleaning Tape</b></p> <p><b>VFK1451</b></p> 	<p><b>Plier for Non ZIF Connector</b></p> <p><b>LSVQ0028</b></p> 
<p><b>Grease</b></p> <p><b>LSUQ0050</b></p> 	<p><b>Extension Cable 8P</b>                  (2 pcs)</p> <p><b>LSUA0019</b></p> 	<p><b>Extension Cable 10P</b></p> <p><b>LSUA0016</b></p> 
<p><b>Extension Cable 12P</b></p> <p><b>VUVS0007</b></p> 	<p><b>Extension Cable 14P</b></p> <p><b>VFKW0124A</b></p> 	<p><b>Extension Cable 18P</b>                  (2 pcs)</p> <p><b>LSUA0017</b></p> 
<p><b>Extension Cable 22P</b>                  (2 pcs)</p> <p><b>VUVS0012</b></p> 		

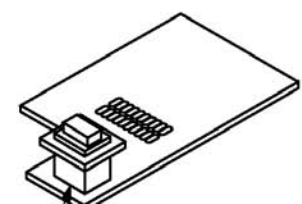
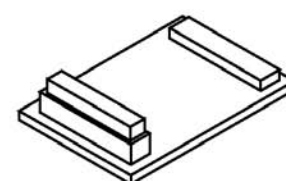
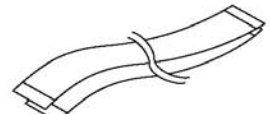
<p><b>Light Box and AC Adaptor</b> VFK1164LBX1</p>  <p>AC Adaptor for C-Movie can be used. (DC +6V) Either plug can be used.</p> <p>(AC Adaptor is not supplied)</p>	<p><b>Infinity Lens (with Focus Chart)</b> VFK1164TCM02</p> 			
<p><b>27mm Ring</b> VFK1164TAR27</p> 		<p><b>Color Conversion Filter (C14)</b> VFK1164TFCT2</p> 	<p><b>232C(M3) I/F Cable</b> VFK1395</p> 	
<p><b>Post Height Adjustment Fixture</b> VFK1899</p> 		<p><b>DC Output Cable and AC Adaptor</b> VJA0941</p>  <p>(AC Adaptor is not supplied)</p>		
<p><b>White Chart</b> VFK1164TFWC2</p> 	<p><b>Color Bar Chart</b> VFK1164TFCB2</p> 	<p><b>Gray Scale Chart</b> VFK1164TFGS2</p> 	<p><b>Measuring Board for Electrical Adjustment</b> VFK1308E</p> 	
<p><b>Connection Adaptor</b> VFK1898</p> 	<p><b>EVR Connector Board</b> VFK1897</p>  <p>(With one Connection Adaptor)</p>		<p><b>EVR Connector Board</b> VFK1309</p> 	<p><b>30 pin Flat Cable (2 pcs)</b> VFK1317</p> 

## 9.2. MECHANICAL ADJUSTMENT

### 9.2.1. ENVELOPE OUTPUT ADJUSTMENT

When replacing the Main Chassis Unit or the Cylinder Unit, be sure to perform the Envelope Output Adjustment as shown below.

1. Open the L Cover. Then, insert a flat headed (-) screwdriver or similar object into the gap of the Post Cover, and remove it.
2. Connect the Camcorder and the Measuring Board with the EVR Connector Boards, the Connection Adaptors and the 30 pin Flat Cables.
3. Connect the oscilloscope to "Envelope TP" on the Measuring Board.
4. Playback the Color Bar Standard Tape (VFM3110EDS).
5. Adjust the S1 post by turning the top of post with Post Height Adjustment Fixture so that the left half of envelope signal becomes flat as possible.
6. Adjust the T1 post by turning the top of post with Post Height Adjustment Fixture so that the right half of envelope signal becomes flat as possible.

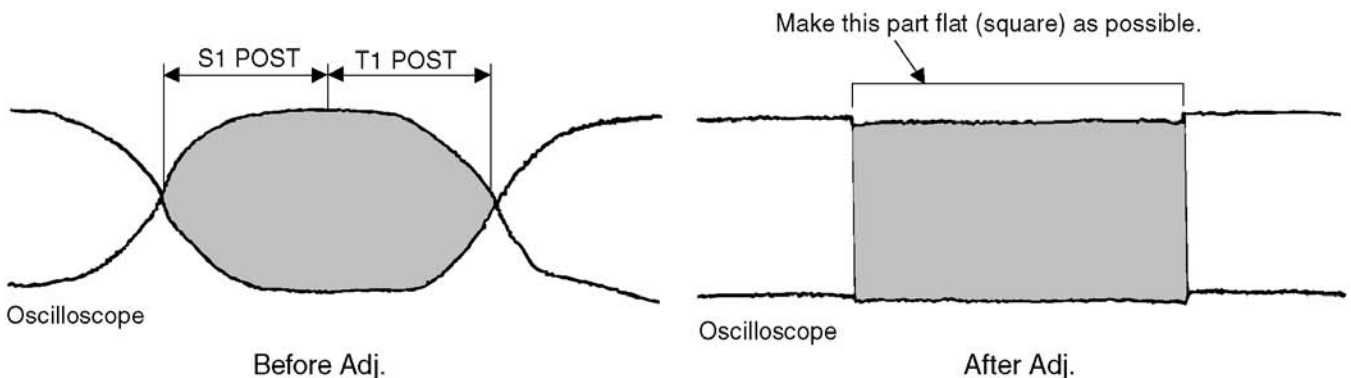
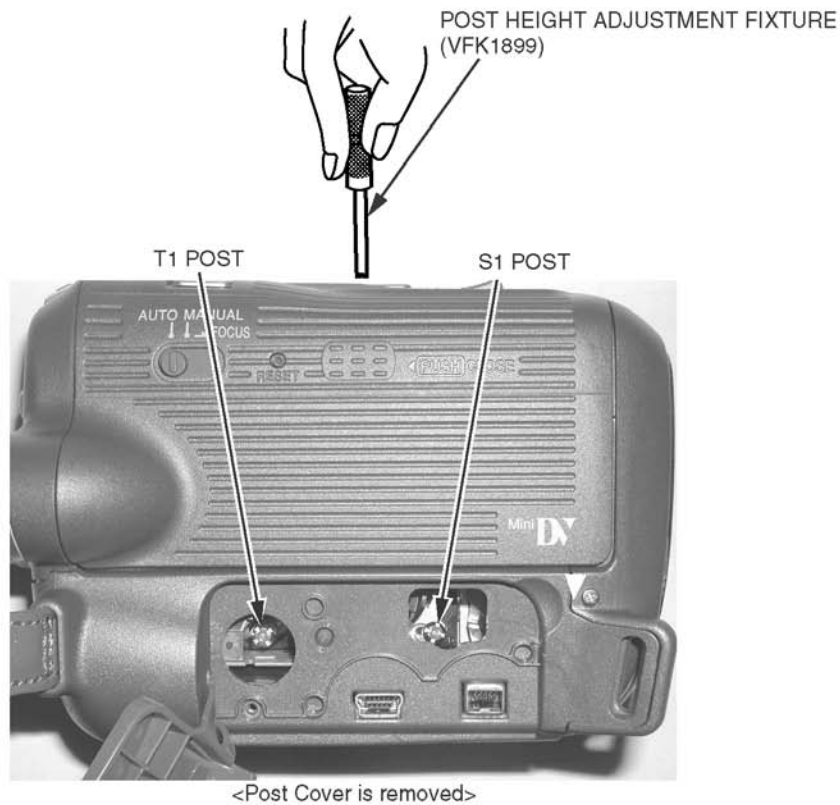

**Note:**  
After the adjustment, be sure to confirm BER (Bit Error Ratio) using EVR Adjustment Software.  
If it is NG, try this adjustment once again.

### 9.3. ELECTRICAL ADJUSTMENT

#### 9.3.1. INITIAL GUIDELINE

The table below shows which adjustments are necessary according to the unit parts and individual parts to be replaced. Make sure to perform these adjustments shown below as necessary.

Adjustment Item		Replacement Parts												
		MAIN C.B.A.	IC302 (CAMERA SIGNAL PROCESS)	IC701 (FOCUS/ZOOM MOTOR DRIVE & IRIS/HALL AMP CONTROL)	IC3001 (CAMERA DIGITAL SIGNAL PROCESS/SHUFFLING)	IC3101 (VIDEO/AUDIO SIGNAL PROCESS)	IC6001 (SYSTEM MICROCONTROLLER)	IC6002 (EEPROM)	LCD C.B.A.	IC8001(LCD RGB /EVF SIGNAL PROCESS)	CCD UNIT	LENS UNIT	CYLINDER UNIT	MAIN CHASSIS UNIT
Camera	CAM hall amplifier and Iris PWM	<input type="radio"/>	<input type="radio"/>	<input type="radio"/>	<input type="radio"/>	<input type="radio"/>	<input type="radio"/>	<input type="radio"/>	<input type="radio"/>	<input type="radio"/>	<input type="radio"/>	<input type="radio"/>	<input type="radio"/>	<input type="radio"/>
	CAM Zoom Tracking and De-focus	<input type="radio"/>	<input type="radio"/>	<input type="radio"/>	<input type="radio"/>	<input type="radio"/>	<input type="radio"/>	<input type="radio"/>	<input type="radio"/>	<input type="radio"/>	<input type="radio"/>	<input type="radio"/>	<input type="radio"/>	<input type="radio"/>
	CAM WB coarse	<input type="radio"/>	<input type="radio"/>	<input type="radio"/>	<input type="radio"/>	<input type="radio"/>	<input type="radio"/>	<input type="radio"/>	<input type="radio"/>	<input type="radio"/>	<input type="radio"/>	<input type="radio"/>	<input type="radio"/>	<input type="radio"/>
	CAM AWB 3100	<input type="radio"/>	<input type="radio"/>	<input type="radio"/>	<input type="radio"/>	<input type="radio"/>	<input type="radio"/>	<input type="radio"/>	<input type="radio"/>	<input type="radio"/>	<input type="radio"/>	<input type="radio"/>	<input type="radio"/>	<input type="radio"/>
	CAM AWB 5100	<input type="radio"/>	<input type="radio"/>	<input type="radio"/>	<input type="radio"/>	<input type="radio"/>	<input type="radio"/>	<input type="radio"/>	<input type="radio"/>	<input type="radio"/>	<input type="radio"/>	<input type="radio"/>	<input type="radio"/>	<input type="radio"/>
	CAM Revision CCD scrach	<input type="radio"/>	<input type="radio"/>	<input type="radio"/>	<input type="radio"/>	<input type="radio"/>	<input type="radio"/>	<input type="radio"/>	<input type="radio"/>	<input type="radio"/>	<input type="radio"/>	<input type="radio"/>	<input type="radio"/>	<input type="radio"/>
Video	VCR Sensitivity adj of Tape sensors	<input type="radio"/>	<input type="radio"/>	<input type="radio"/>	<input type="radio"/>	<input type="radio"/>	<input type="radio"/>	<input type="radio"/>	<input type="radio"/>	<input type="radio"/>	<input type="radio"/>	<input type="radio"/>	<input type="radio"/>	<input type="radio"/>
	VCR PG shifter adjustment	<input type="radio"/>	<input type="radio"/>	<input type="radio"/>	<input type="radio"/>	<input type="radio"/>	<input type="radio"/>	<input type="radio"/>	<input type="radio"/>	<input type="radio"/>	<input type="radio"/>	<input type="radio"/>	<input type="radio"/>	<input type="radio"/>
	VCR Luminance level	<input type="radio"/>	<input type="radio"/>	<input type="radio"/>	<input type="radio"/>	<input type="radio"/>	<input type="radio"/>	<input type="radio"/>	<input type="radio"/>	<input type="radio"/>	<input type="radio"/>	<input type="radio"/>	<input type="radio"/>	<input type="radio"/>
	VCR Chroma level	<input type="radio"/>	<input type="radio"/>	<input type="radio"/>	<input type="radio"/>	<input type="radio"/>	<input type="radio"/>	<input type="radio"/>	<input type="radio"/>	<input type="radio"/>	<input type="radio"/>	<input type="radio"/>	<input type="radio"/>	<input type="radio"/>
LCD	LCD Contrast	<input type="radio"/>	<input type="radio"/>	<input type="radio"/>	<input type="radio"/>	<input type="radio"/>	<input type="radio"/>	<input type="radio"/>	<input type="radio"/>	<input type="radio"/>	<input type="radio"/>	<input type="radio"/>	<input type="radio"/>	<input type="radio"/>
	LCD Bright	<input type="radio"/>	<input type="radio"/>	<input type="radio"/>	<input type="radio"/>	<input type="radio"/>	<input type="radio"/>	<input type="radio"/>	<input type="radio"/>	<input type="radio"/>	<input type="radio"/>	<input type="radio"/>	<input type="radio"/>	<input type="radio"/>
	LCD Sub Bright	<input type="radio"/>	<input type="radio"/>	<input type="radio"/>	<input type="radio"/>	<input type="radio"/>	<input type="radio"/>	<input type="radio"/>	<input type="radio"/>	<input type="radio"/>	<input type="radio"/>	<input type="radio"/>	<input type="radio"/>	<input type="radio"/>
	LCD VCOM level	<input type="radio"/>	<input type="radio"/>	<input type="radio"/>	<input type="radio"/>	<input type="radio"/>	<input type="radio"/>	<input type="radio"/>	<input type="radio"/>	<input type="radio"/>	<input type="radio"/>	<input type="radio"/>	<input type="radio"/>	<input type="radio"/>
EVF	EVF Horizontal free running	<input type="radio"/>	<input type="radio"/>	<input type="radio"/>	<input type="radio"/>	<input type="radio"/>	<input type="radio"/>	<input type="radio"/>	<input type="radio"/>	<input type="radio"/>	<input type="radio"/>	<input type="radio"/>	<input type="radio"/>	<input type="radio"/>
	EVF Contrast	<input type="radio"/>	<input type="radio"/>	<input type="radio"/>	<input type="radio"/>	<input type="radio"/>	<input type="radio"/>	<input type="radio"/>	<input type="radio"/>	<input type="radio"/>	<input type="radio"/>	<input type="radio"/>	<input type="radio"/>	<input type="radio"/>
	EVF Bright	<input type="radio"/>	<input type="radio"/>	<input type="radio"/>	<input type="radio"/>	<input type="radio"/>	<input type="radio"/>	<input type="radio"/>	<input type="radio"/>	<input type="radio"/>	<input type="radio"/>	<input type="radio"/>	<input type="radio"/>	<input type="radio"/>
	EVF Sub Bright	<input type="radio"/>	<input type="radio"/>	<input type="radio"/>	<input type="radio"/>	<input type="radio"/>	<input type="radio"/>	<input type="radio"/>	<input type="radio"/>	<input type="radio"/>	<input type="radio"/>	<input type="radio"/>	<input type="radio"/>	<input type="radio"/>
	EVF VCOM leve	<input type="radio"/>	<input type="radio"/>	<input type="radio"/>	<input type="radio"/>	<input type="radio"/>	<input type="radio"/>	<input type="radio"/>	<input type="radio"/>	<input type="radio"/>	<input type="radio"/>	<input type="radio"/>	<input type="radio"/>	<input type="radio"/>

Note: ○ : Adjustment Item

### 9.3.2. TEST EQUIPMENT

1. Dual-Trace Oscilloscope

Voltage Range: 0.001 to 50 V/Div.

Frequency Range: DC to 50 MHz

Probes: 10:1, 1:1

2. Frequency Counter

3. Vectorscope

4. Plastic Tip Driver

5. Personal Computer

PC: IBM PC/AT or compatible

OS: Microsoft® Windows®98 - Windows®XP

CPU: 486 or higher

Drive: 3.5 inch 1.44 MB floppy disk drive

Port: D-Sub-9-pin Serial or D-Sub-25-pin Serial

Monitor: VGA Color

6. PC-EVR Adjustment Program (VF0D2005DV10)

**Note:**

Ask for the latest version when placing an order for the PC-EVR Adjustment Program.

7. Measuring Board (VFK1308E)

8. 232C (M3) I/F Cable (VFK1395)

9. DC Output Cable and AC Adaptor (VJA0941)

10. Connection Adaptor (VFK1898)

11. EVR Connector Board (VFK1897)

12. EVR Connector Board (VFK1309)

13. 30 pin Flat Cable (VFK1317)

14. Color Bar Standard Tape (VFM3110EDS)

(Keeping condition: Keep at 18 °C ~ 28 °C)

15. Gray Scale Chart (VFK1164TFGS2)

16. White Chart (VFK1164TFWC2)

17. Color Bar Chart (VFK1164TFCB2)

18. Light Box and AC Adaptor (for VHS-C)

19. Infinity Lens (with Focus Chart) (VFK1164TCM02)

20. AC Adaptor (for DVC)

21. 27 mm Ring (VFK1164TAR27)

22. Color Conversion Filter (C14) (VFK1164TFCT2)

### 9.3.3. PREPARATION

1. Insert a flat headed (-) screwdriver or similar object, remove the EVR Cover.
2. Connect the Connection Adaptor and the 2 EVR Connector Boards. Then, connect the 30 pin Flat Cables to P101 and P102 on the Interface Board.

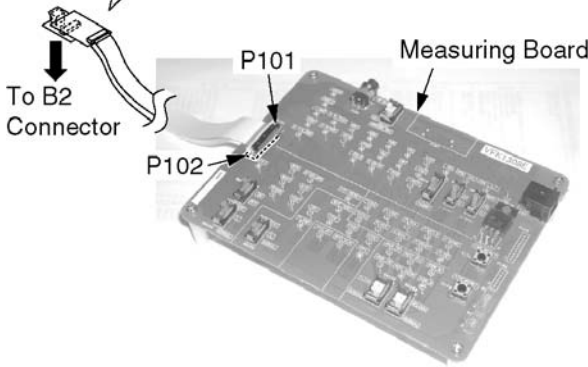
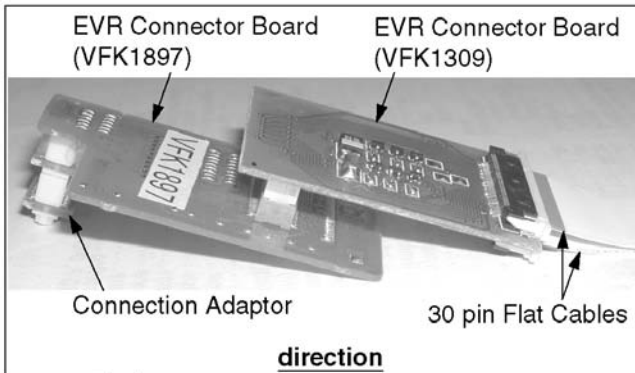

Fig. E1-1

**Note:**

When connecting them, pay attention to the direction of them.

3. Connect them to the Connector B2 on the Main C.B.A.

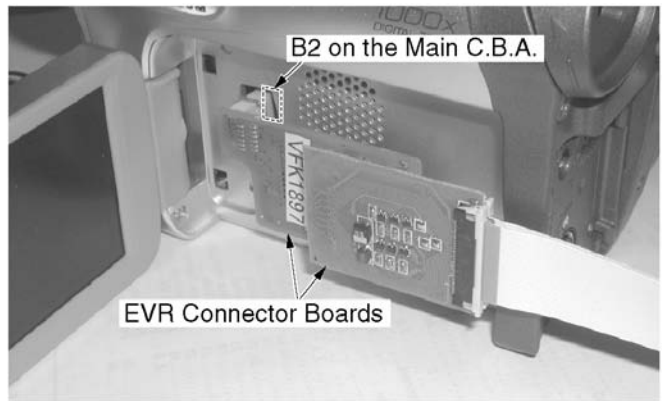

Fig. E1-2

4. Connect the AC Adaptor to the camcorder.
5. Connect the DC Output Cable (and AC Adaptor) to the J101 on the Measuring Board.
6. Connect the J102 on the Measuring Board to RS232C of the PC with 232C (M3) I/F Cable.
7. Set the SW101 (RS232C\_SEL) on the Measuring Board to "M3."
8. Set the SW102 (FLUSH1) on the Measuring Board to "NORMAL."
9. Set the SW103 (VTR\_TEST) on the Measuring Board to "NORMAL."
10. Set the SW104 (BST\_TEST) on the Measuring Board to "NORMAL."
11. Set the SW105 on the Measuring Board to "L."
12. Set the SW106 on the Measuring Board to "ON."
13. Set the SW107 on the Measuring Board to center.
14. Set the SW108 on the Measuring Board to "L."
15. Set the SW109 (FLUSH2) on the Measuring Board to "FLUSH."
16. Power on the set.

### <Computer Assisted Adjustment System>

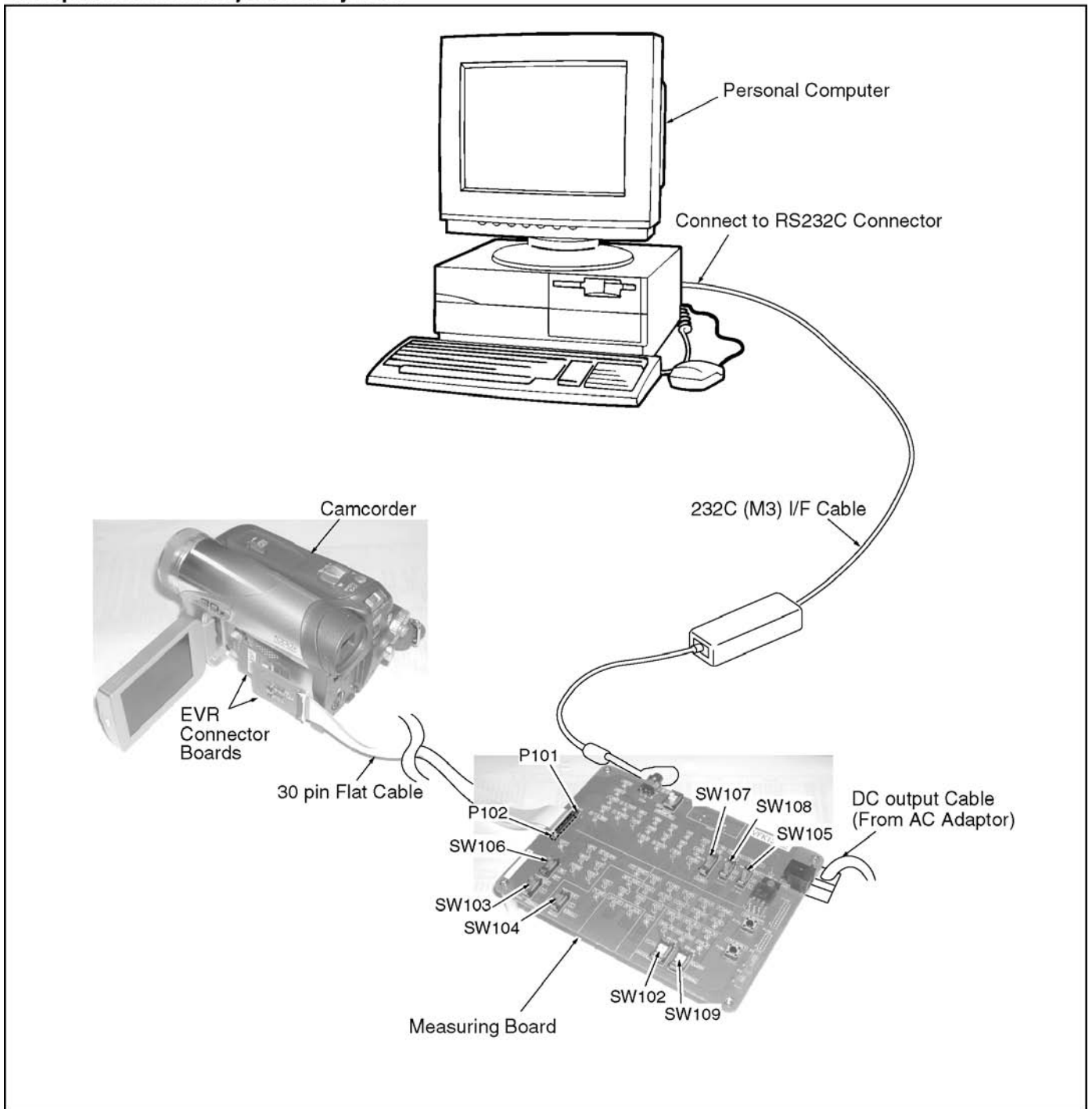

Fig. E1-3

### 9.3.4. TP Board Location

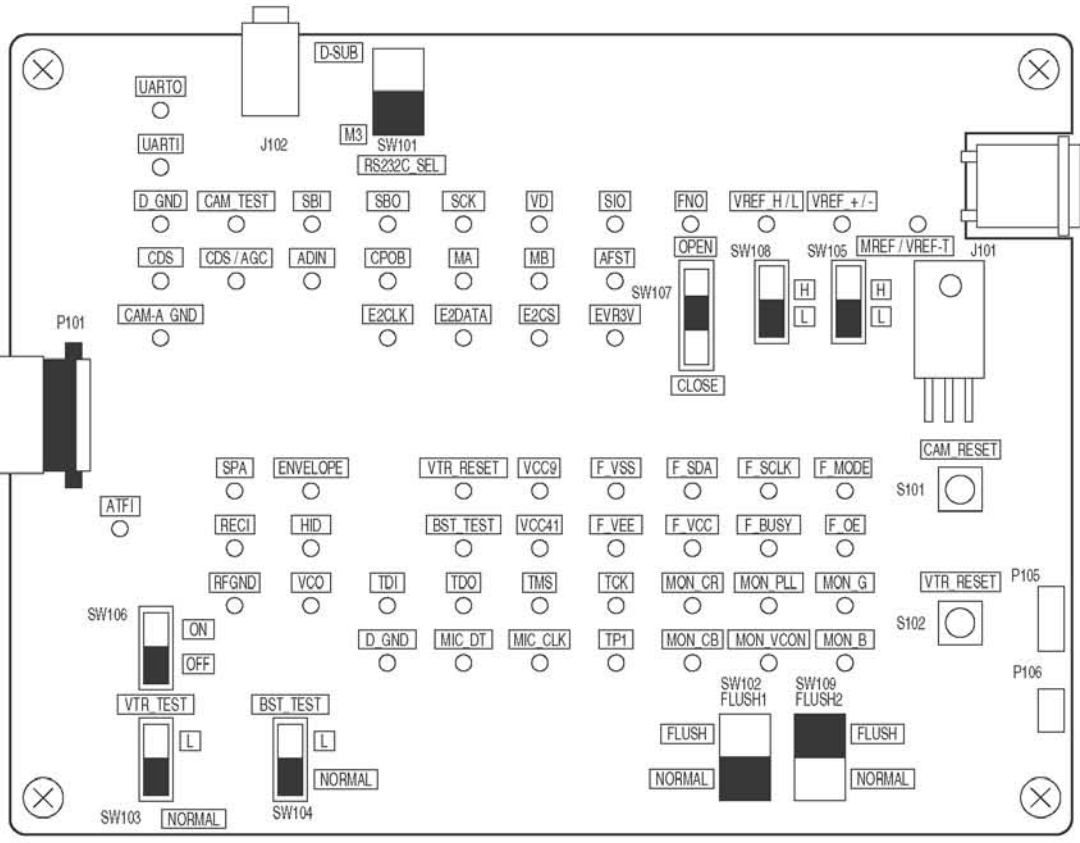
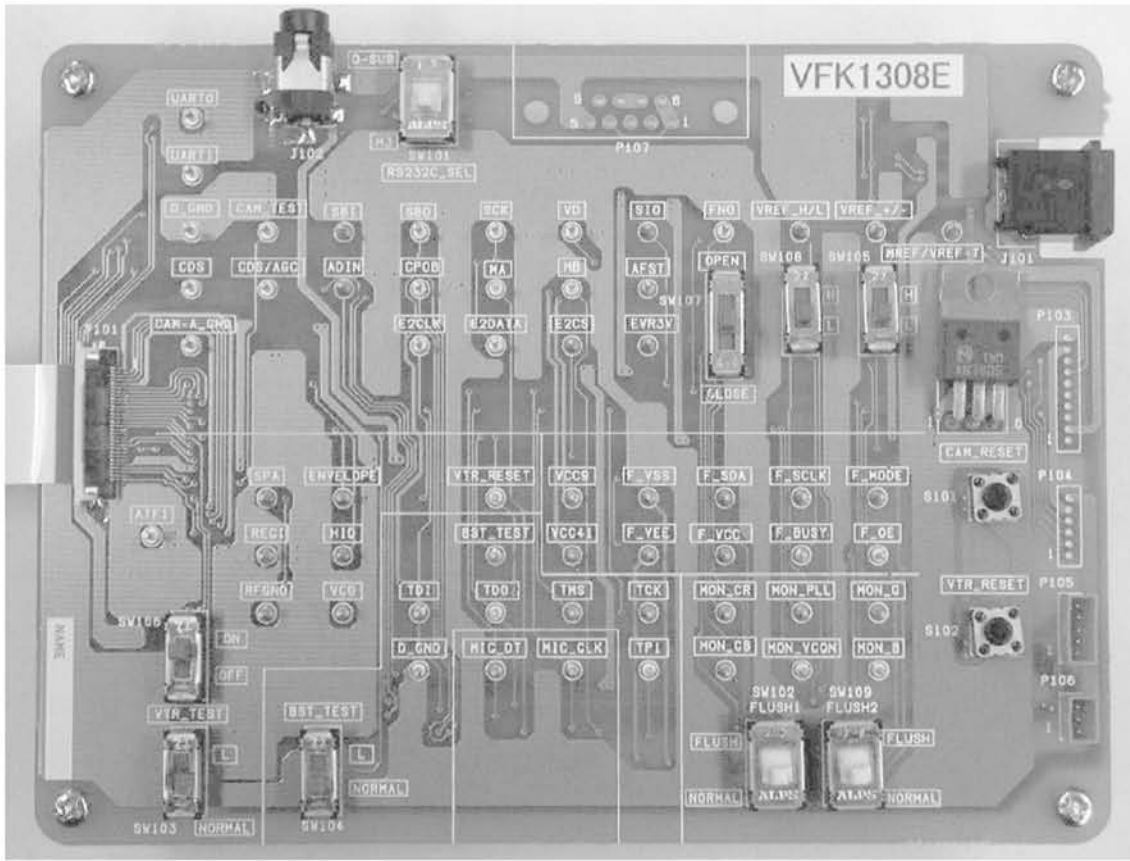

Fig. E1-4



### 9.3.5. SET UP OF PC-EVR ADJUSTMENT PROGRAM

1. Turn on the PC and install the PC-EVR Adjustment Program into the PC.
2. Execute the "kdv2005.exe" file by double clicking to start up the PC-EVR Adjustment Program.  
The main menu will be displayed.
3. Select the desired model.
4. Turn on the camcorder. Then click "Start."

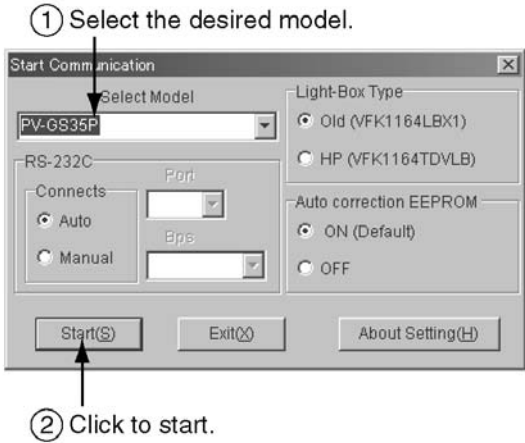

Fig. E2-1

5. When the communication is complete, the dialog will appear.  
Then, click "Yes," and "Save" to save the EEPROM data.

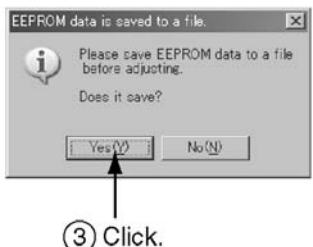

Fig. E2-2

6. When saving for EEPROM data is complete, the menu will appear.  
To perform each adjustment, display the adjustment menu by selecting the desired menu from "Camera Adjust," "Vcr Adjust," "LCD Adjust" or "EVF Adjust" and select each adjustment item.

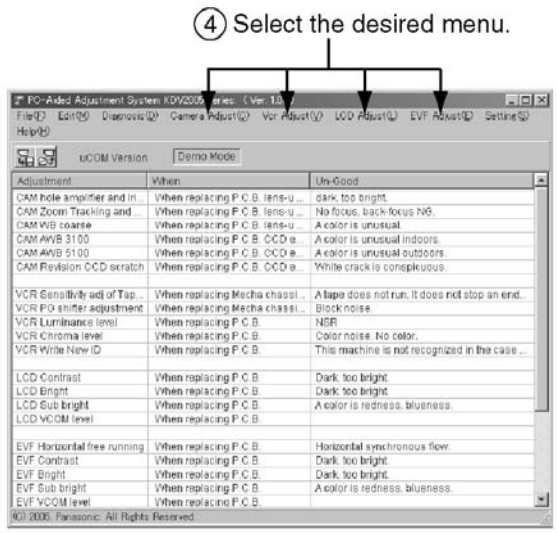

Fig. E2-3

**Note:**

The adjusted data is stored in the EEPROM IC after each adjustment.

7. After adjustment, to close the software, select "Exit" in the File menu or close the window.

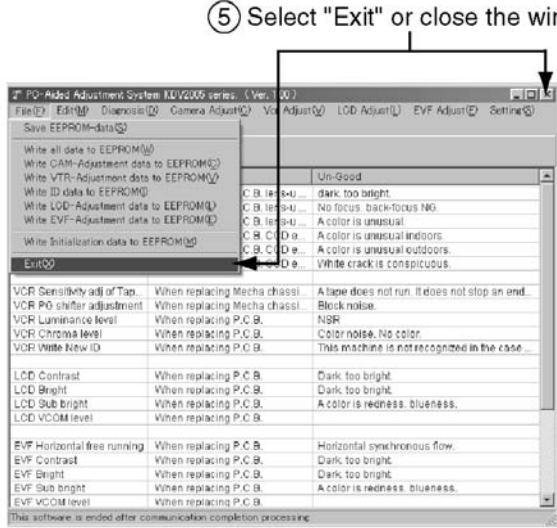



Fig. E2-4



# 10 SCHEMATIC DIAGRAMS

## 10.1. SCHEMATIC DIAGRAM & CIRCUIT BOARD LAYOUT NOTES

### 1. Important safety notice

Components identified by the sign  have special characteristics important for safety. When replacing any of these components. Use only the specified parts.

### 2. Do not use the part number shown on this drawing for ordering.

The correct part number and part value is shown in the parts list, and may be slightly different or amended since this drawing was prepared.

### 3. Use only original replacement parts:

To maintain original function and reliability of repaired units, use only original replacement parts which are listed with their part numbers in the parts list section of the service manual.

### 4. Parts different in shape or size may be used.

However, only interchangeable parts will be supplied as service replacement parts.

### 5. Test point information

 : Test point with no test pin.

### Schematic Diagram Notes

#### 1. Indication for Zener Voltage of Zener Diodes

The Zener Voltage of Zener Diodes are indicated as such on Schematic Diagrams.

Example:  
(6.2V).....Zener Voltage

#### 2. How to identify Connectors

Each connector is labeled with a Connector No. and Pin No. Indicating what it is connected to, in other words, its counter part.

Use the interconnection schematic diagram to find the connection between associated connectors.

Example:

The connections between C.B.A.s are shown below.

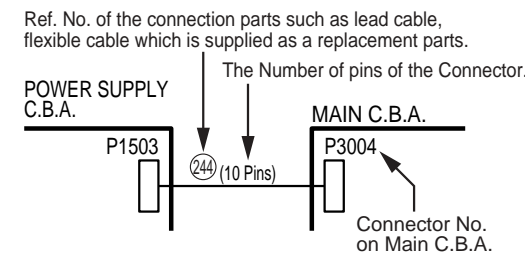

### 3. Parts marked "PT" are not used in any models included in this service model.

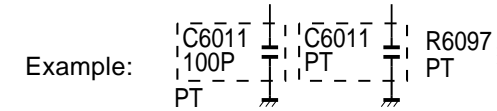

### Signal Waveform Note

How to read Signal Waveform

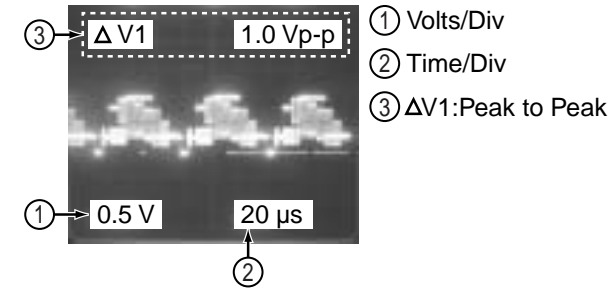

### Voltage Chart Note

Voltage Measurement

- a. Color bar signal in SP mode.
- b. ---:Unmeasurable or not necessary to measure.

### Circuit Board Layout Note

Circuit Board Layout shows components installed for various models.

For proper parts content for the model you are servicing, please refer to the schematic diagram and parts list.

NOTE:

Circuit Board Layout includes components which are not used.

### Model Number Indication

Model numbers are indicated without "NV-GS."

**SCHEMATIC DIAGRAM & CIRCUIT BOARD LAYOUT NOTES**  
**NV-GS6EE/GC, NV-GS17EG/EF/E/EP/EB, NV-GS18E, NV-GS21EG/EK/E/EP/EB,**  
**NV-GS25GC/GN, NV-GS28GK, NV-GS35EG/E/EP/EB/GC/GN, NV-GS38GK**

## 10.2. FRONT SCHEMATIC DIAGRAM

### FRONT SCHEMATIC DIAGRAM

NOTE: For placing a purchase order of the parts, be sure to use the part number listed in the parts list. Do not use the part number on this diagram.

NOTE: PARTS MARKED "PT" ARE NOT USED.

NOTE: FOR SCHEMATIC DIAGRAM AND CIRCUIT BOARD LAYOUT NOTES, REFER TO BEGINNING OF SCHEMATIC SECTION.

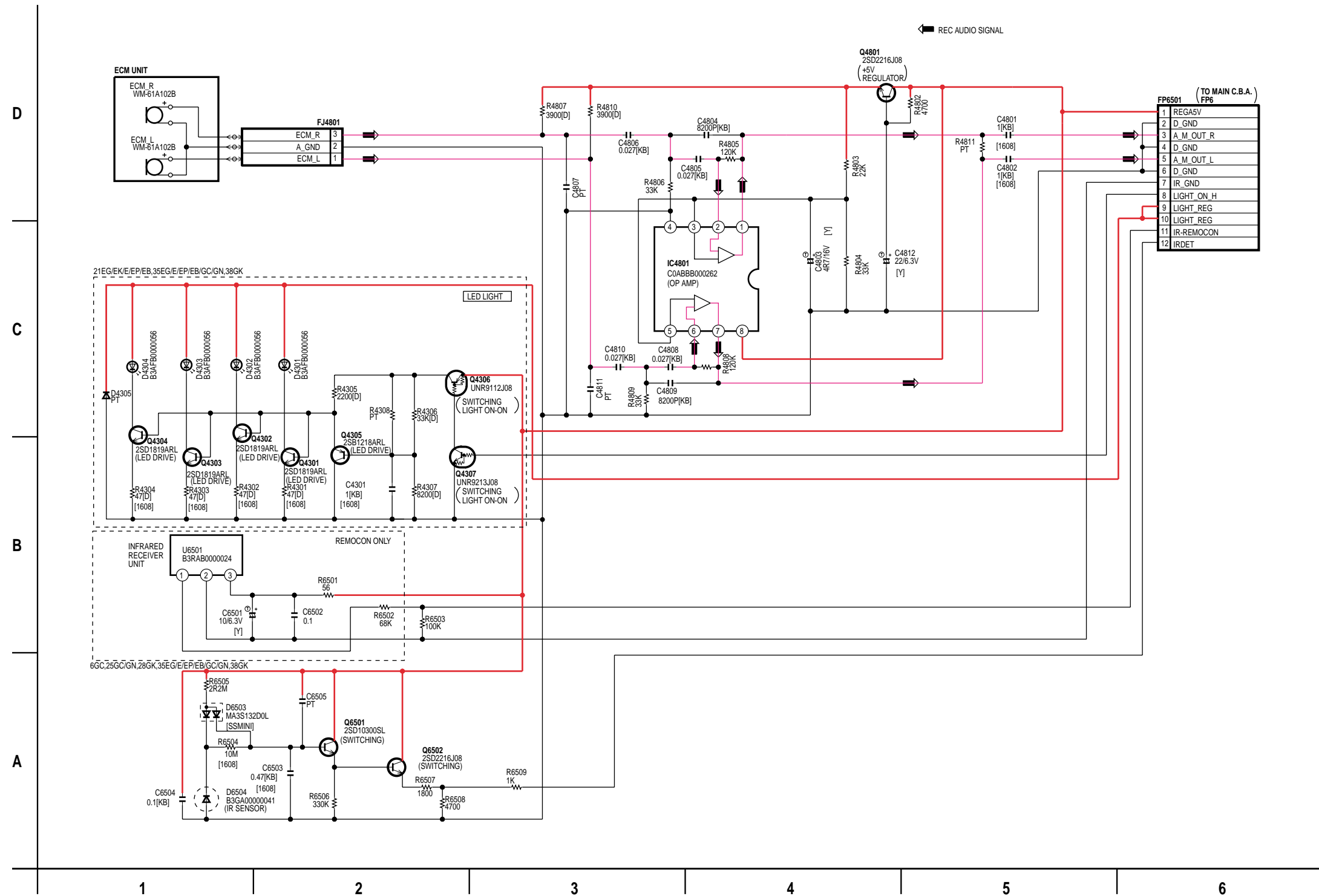

LSJB8296  
FRONT SCHEMATIC DIAGRAM  
NV-GS6EE/GC, NV-GS17EG/EF/E/EP/EB, NV-GS18E, NV-GS21EG/EK/E/EP/EB,  
NV-GS25GC/GN, NV-GS28GK, NV-GS35EG/E/EP/EB/GC/GN, NV-GS38GK

### 10.3. JACK SCHEMATIC DIAGRAM

#### JACK SCHEMATIC DIAGRAM

NOTE: For placing a purchase order of the parts, be sure to use the part number listed in the parts list. Do not use the part number on this diagram.

NOTE: PARTS MARKED "PT" ARE NOT USED.

NOTE: FOR SCHEMATIC DIAGRAM AND CIRCUIT BOARD LAYOUT NOTES, REFER TO BEGINNING OF SCHEMATIC SECTION.

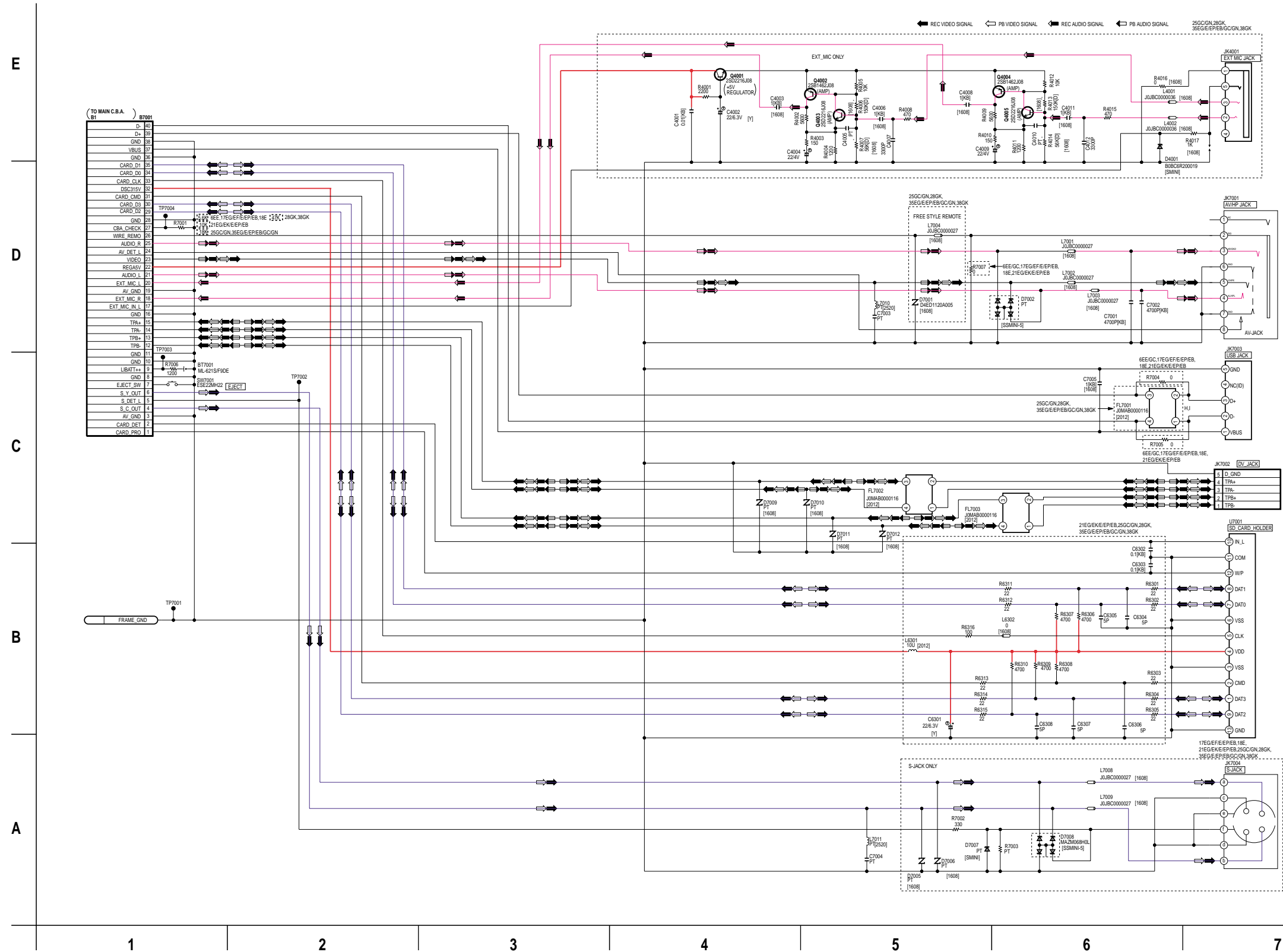

LINK TO VOLTAGE CHART

LSJB8297

JACK SCHEMATIC DIAGRAM

NV-GS6EE/GC, NV-GS17EG/EF/E/EP/EB, NV-GS18E, NV-GS21EG/EK/E/EP/EB, NV-GS25GC/GN, NV-GS28GK, NV-GS35EG/E/EP/EB/GC/GN, NV-GS38GK

# 10.4. LCD BACKLIGHT SCHEMATIC DIAGRAM

## LCD BACKLIGHT SCHEMATIC DIAGRAM

NOTE:  
ALL INDIVIDUAL PARTS EXCEPT D8101, D8103, D8105, AND D8107  
ON LCD BACKLIGHT C.B.A. ARE SUPPLIED AS REPLACEMENT PARTS.  
WHEN SERVICING THESE PARTS, REPLACE LCD BACKLIGHT C.B.A.  
INSTEAD OF INDIVIDUAL PARTS.

NOTE: For placing a purchase order of the parts,  
be sure to use the part number listed in the parts list.  
Do not use the part number on this diagram.

NOTE: PARTS MARKED "PT" ARE NOT USED.

NOTE: FOR SCHEMATIC DIAGRAM AND CIRCUIT BOARD LAYOUT NOTES,  
REFER TO BEGINNING OF SCHEMATIC SECTION.

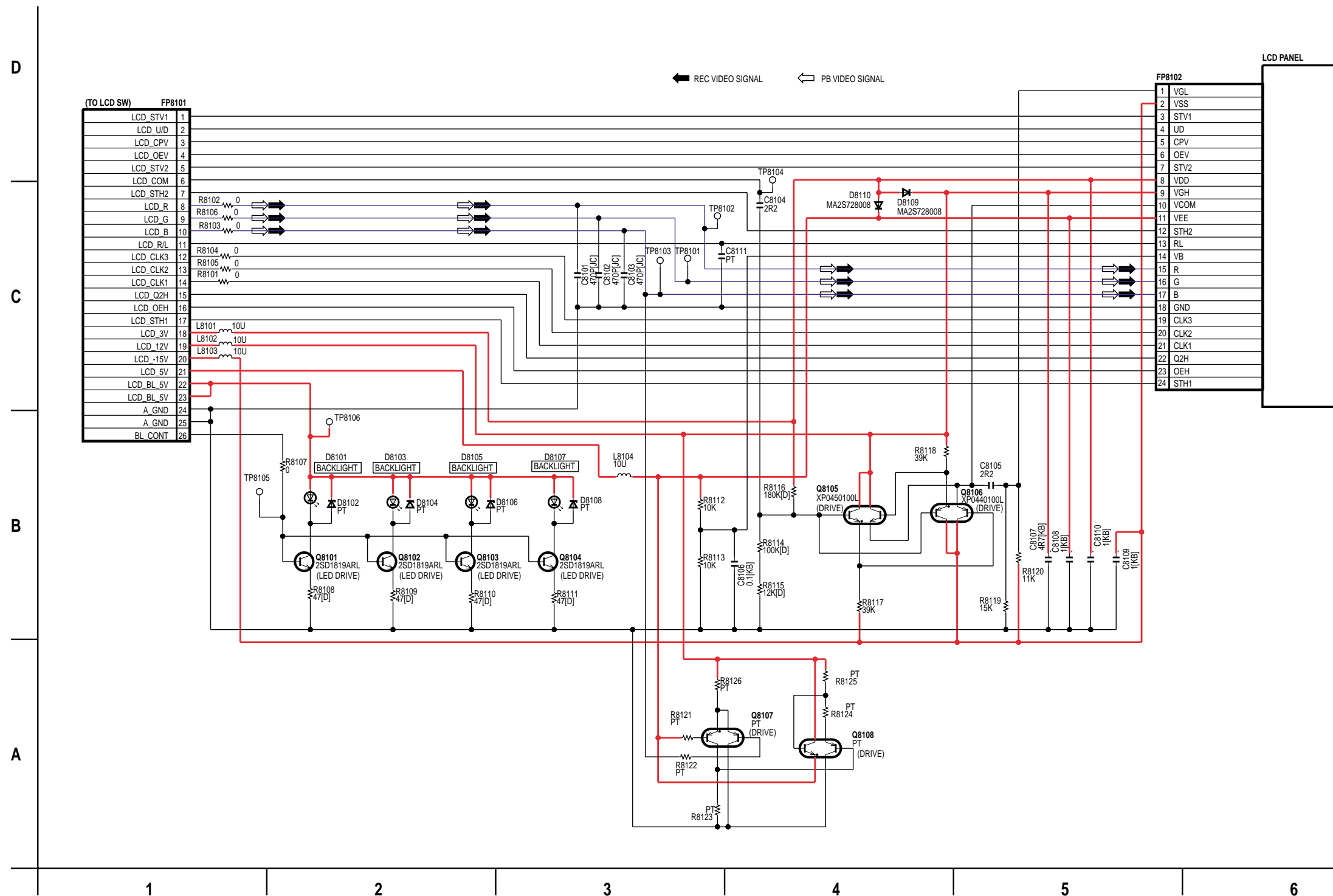

LINK TO VOLTAGE CHART

LSJB8298  
LCD BACKLIGHT SCHEMATIC DIAGRAM  
NV-GS6EE/GC, NV-GS17EG/EF/E/EP/EB, NV-GS18E, NV-GS21EG/EK/E/EP/EB,  
NV-GS25GC/GN, NV-GS28GK, NV-GS35EG/E/EP/EB/GC/GN, NV-GS38GK

### 10.5. EVF BACKLIGHT / CASSETTE COVER SCHEMATIC DIAGRAMS

**EVF BACKLIGHT SCHEMATIC DIAGRAM**  
**NV-GS6EE/GC, NV-GS17EG/EF/E/EP/EB, NV-GS18E,**  
**NV-GS21EG/EK/E/EP/EB, NV-GS25GC/GN, NV-GS28GK**

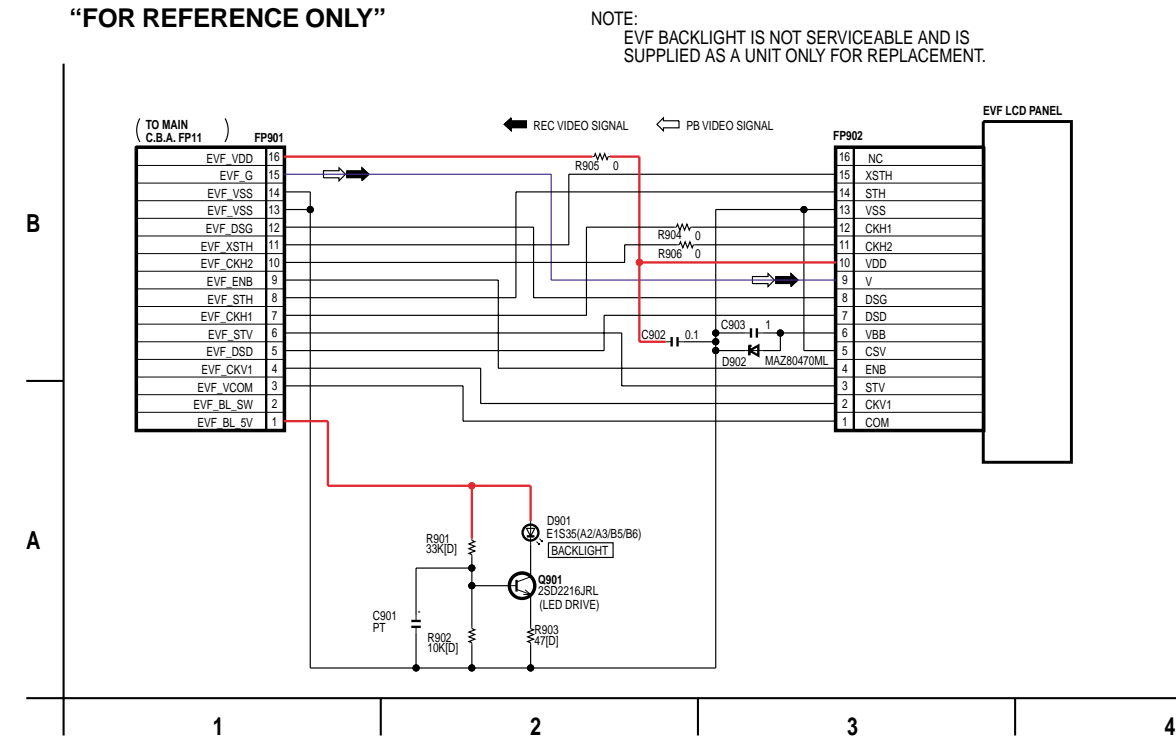

**EVF BACKLIGHT SCHEMATIC DIAGRAM NV-GS35EG/E/EP/EB/GC/GN, NV-GS38GK**

“FOR REFERENCE ONLY”

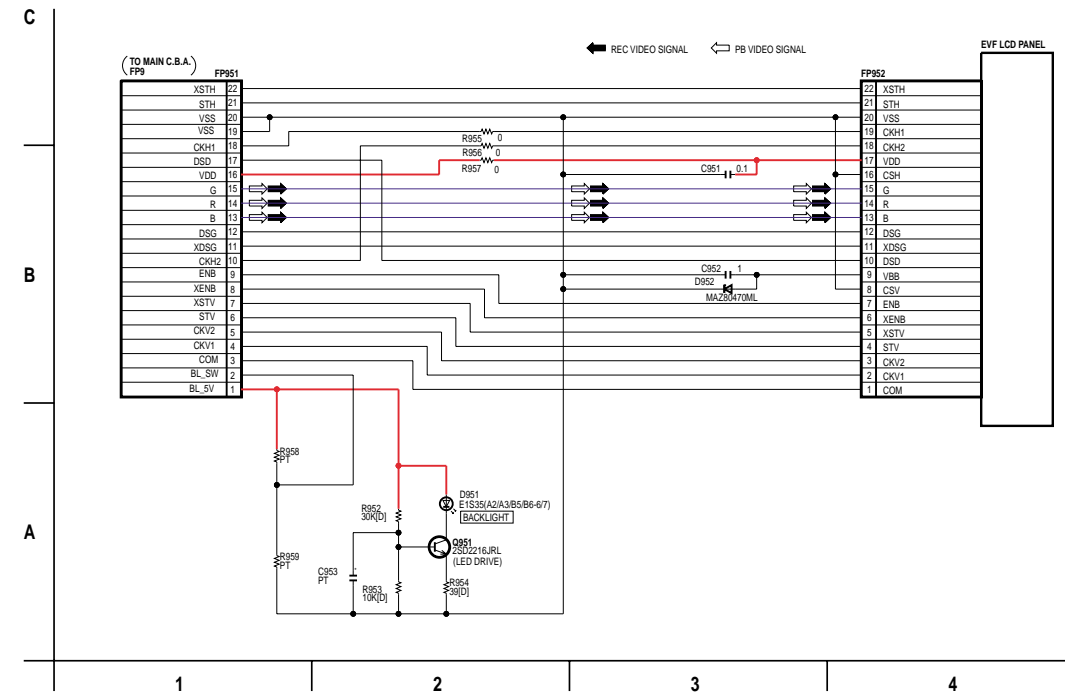

**CASSETTE COVER SCHEMATIC DIAGRAM**

“FOR REFERENCE ONLY”

NOTE: CASSETTE COVER UNIT IS NOT SERVICEABLE AND IS SUPPLIED AS A UNIT ONLY FOR REPLACEMENT.

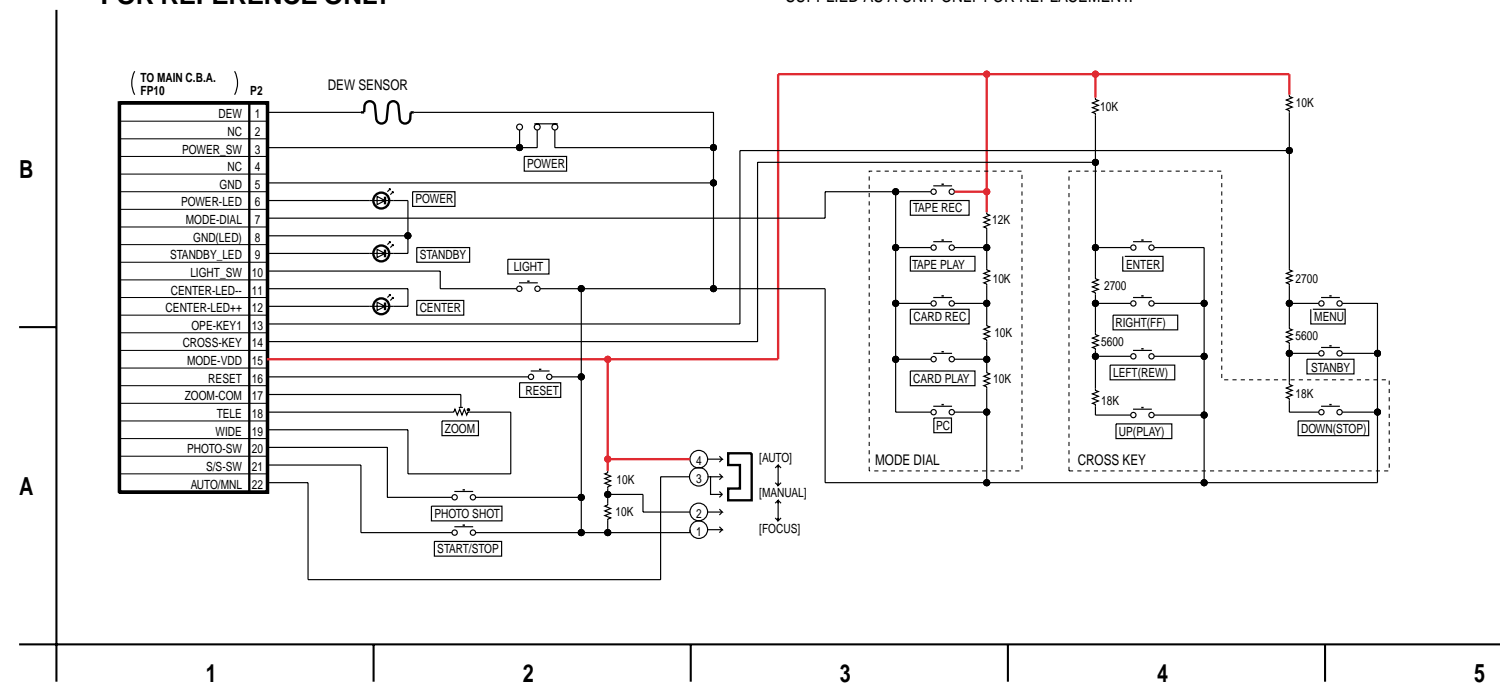

**EVF BACKLIGHT SCHEMATIC DIAGRAM**  
**CASSETTE COVER SCHEMATIC DIAGRAM**  
**NV-GS6EE/GC, NV-GS17EG/EF/E/EP/EB, NV-GS18E, NV-GS21EG/EK/E/EP/EB,**  
**NV-GS25GC/GN, NV-GS28GK, NV-GS35EG/E/EP/EB/GC/GN, NV-GS38GK**

### 10.6. CCD / SIDE CASE R / LCD SW SCHEMATIC DIAGRAMS

NOTE: For placing a purchase order of the parts, be sure to use the part number listed in the parts list. Do not use the part number on this diagram.

NOTE: PARTS MARKED "PT" ARE NOT USED.

NOTE: FOR SCHEMATIC DIAGRAM AND CIRCUIT BOARD LAYOUT NOTES, REFER TO BEGINNING OF SCHEMATIC SECTION.

**CCD SCHEMATIC DIAGRAM**  
"FOR REFERENCE ONLY"

NOTE: CCD C.B.A. IS NOT SERVICEABLE AND IS SUPPLIED AS A UNIT ONLY FOR REPLACEMENT.

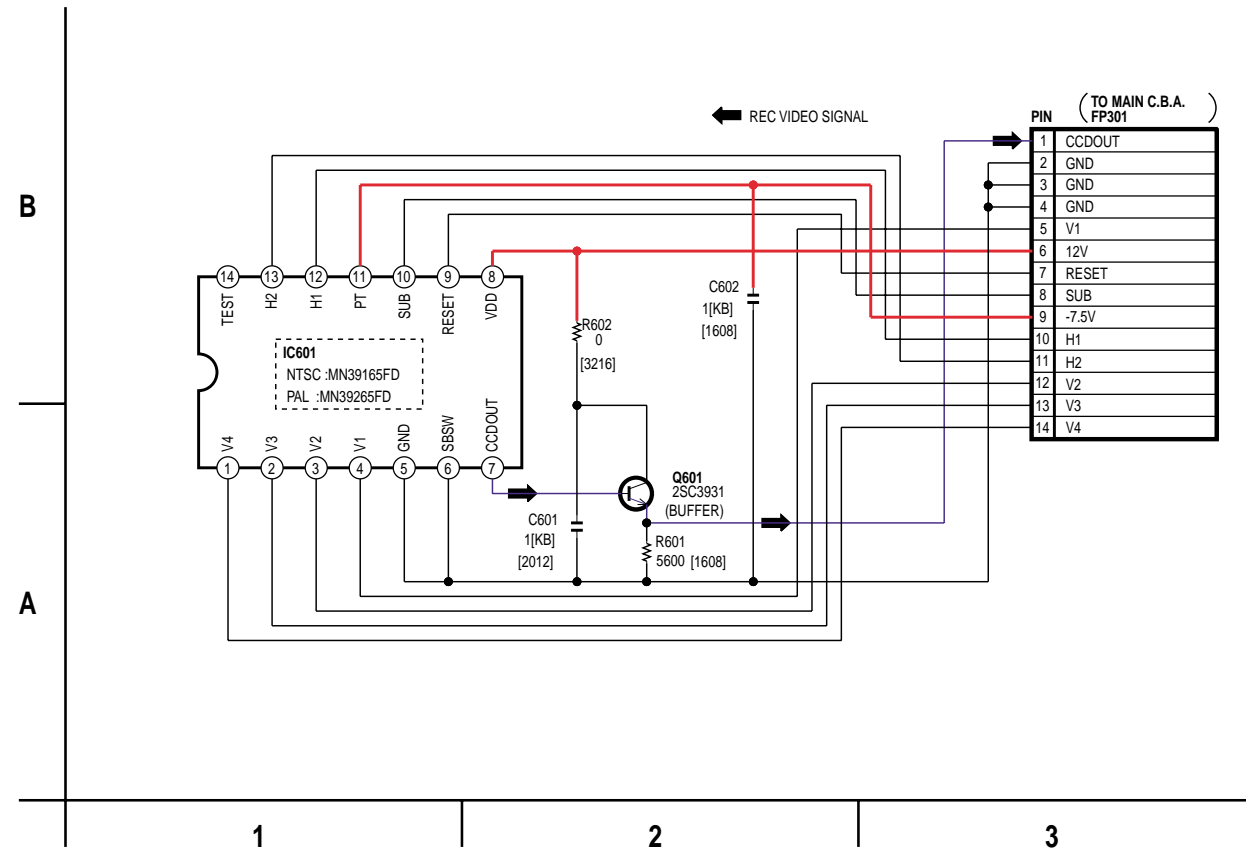

**LCD SW SCHEMATIC DIAGRAM**  
"FOR REFERENCE ONLY"

NOTE: LCD SW IS NOT SERVICEABLE AND IS SUPPLIED AS A SHAFT CASE UNIT ONLY FOR REPLACEMENT.

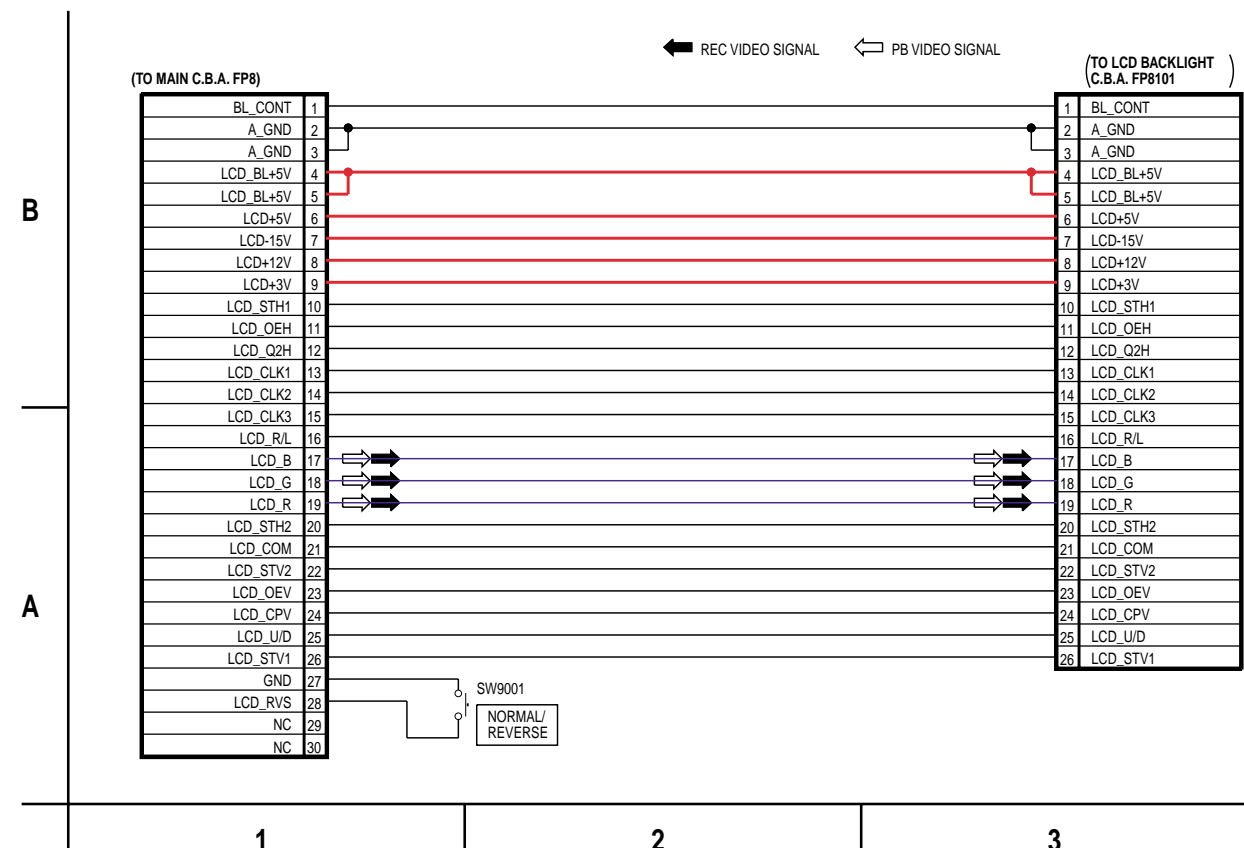

**SIDE CASE R SCHEMATIC DIAGRAM**  
"FOR REFERENCE ONLY"

NOTE: SIDE CASE R UNIT IS NOT SERVICEABLE AND IS SUPPLIED AS A UNIT ONLY FOR REPLACEMENT.

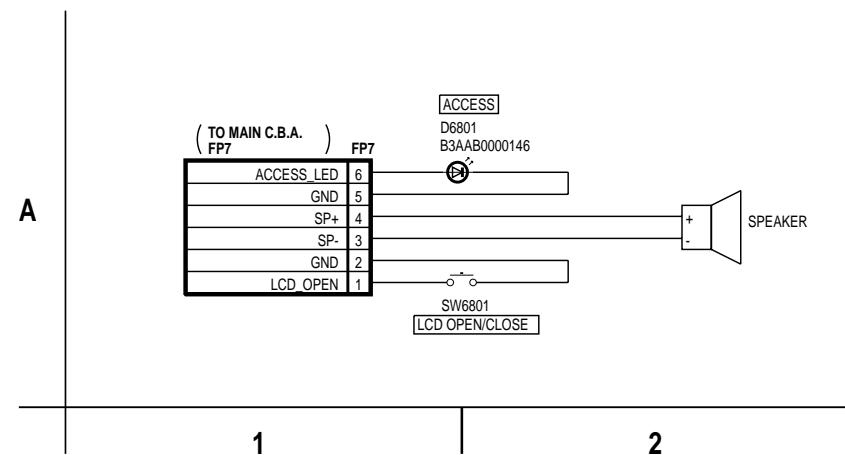

CCD SCHEMATIC DIAGRAM  
SIDE CASE R SCHEMATIC DIAGRAM  
LCD SW SCHEMATIC DIAGRAM  
NV-GS6EE/GC, NV-GS17EG/EF/E/EP/EB, NV-GS18E, NV-GS21EG/EK/E/EP/EB,  
NV-GS25GC/GN, NV-GS28GK, NV-GS35EG/E/EP/EB/GC/GN, NV-GS38GK



# 10.7. INTERCONNECTION SCHEMATIC DIAGRAM

## INTERCONNECTION SCHEMATIC DIAGRAM

NOTE: For placing a purchase order of the parts, be sure to use the part number listed in the parts list. Do not use the part number on this diagram.

NOTE: PARTS MARKED "PT" ARE NOT USED.

NOTE: FOR SCHEMATIC DIAGRAM AND CIRCUIT BOARD LAYOUT NOTES, REFER TO BEGINNING OF SCHEMATIC SECTION.

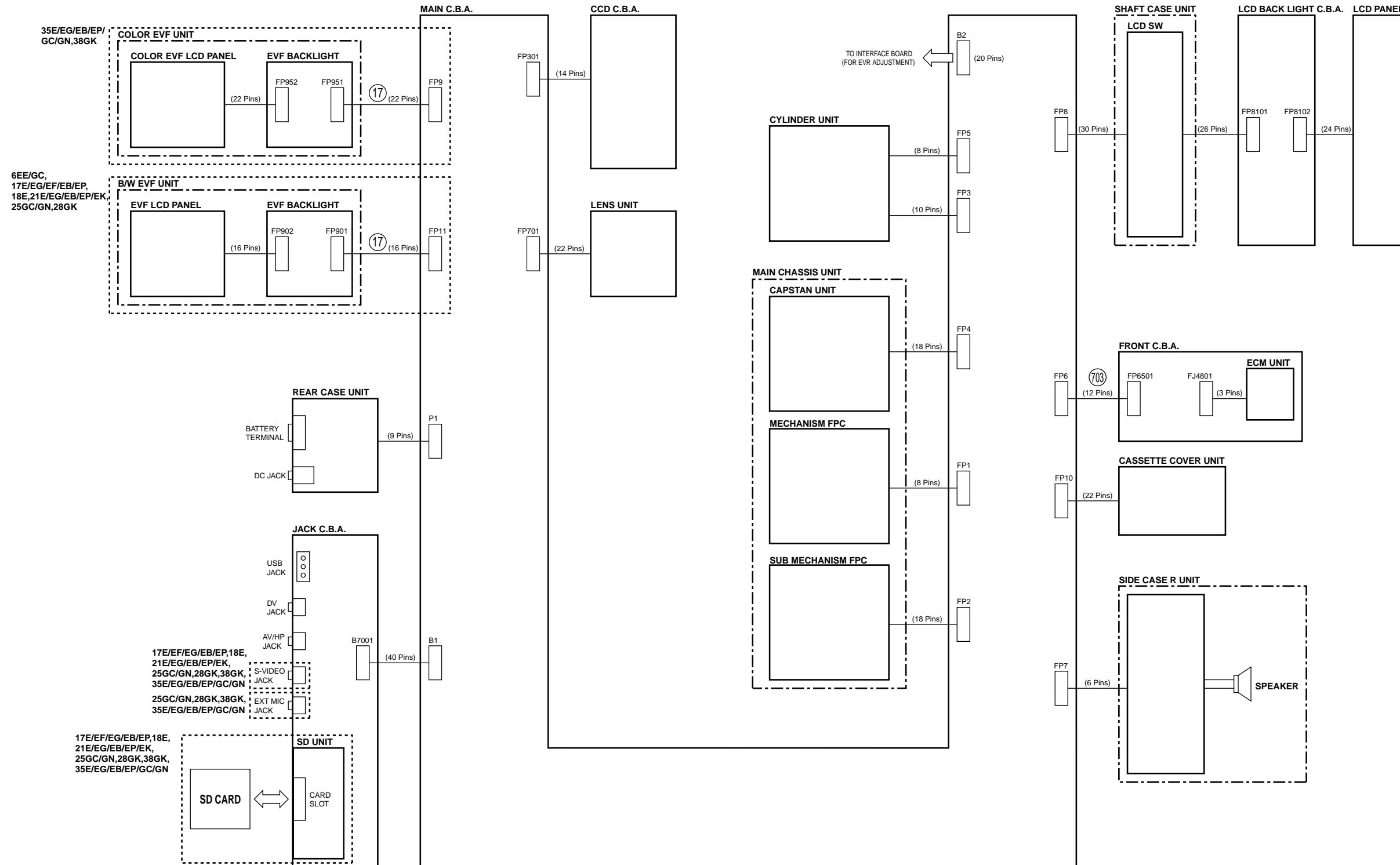

INTERCONNECTION SCHEMATIC DIAGRAM  
 NV-GS6EE/GC, NV-GS17EG/EF/E/EP/EB, NV-GS18E, NV-GS21EG/EK/E/EP/EB,  
 NV-GS25GC/GN, NV-GS28GK, NV-GS35EG/E/EP/EB/GC/GN, NV-GS38GK





## 11.2. JACK C.B.A.

JACK C.B.A. LSEP8297T1 NV-GS6EE  
 LSEP8297D1 NV-GS6GC  
 LSEP8297P1 NV-GS17EG/EF/E/EP/EB, NV-GS18E

LSEP8297R1 NV-GS25GC/GN, NV-GS35EG/E/EP/EB/GC/GN  
 LSEP8297S1 NV-GS28GK, NV-GS38GK

(COMPONENT SIDE) 3

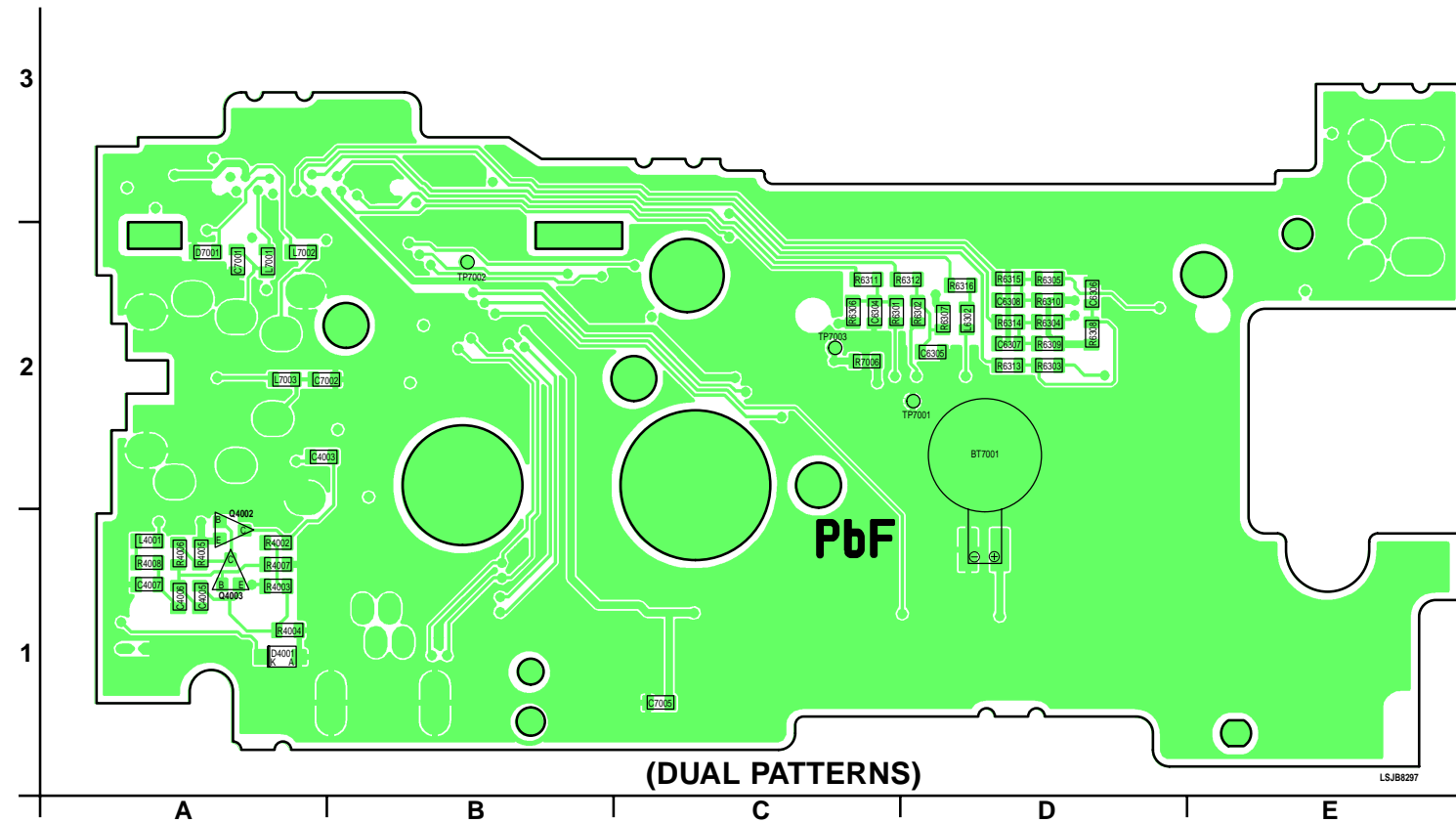

NOTE:  
 FOR SCHEMATIC DIAGRAM AND CIRCUIT BOARD LAYOUT NOTES,  
 REFER TO BEGINNING OF SCHEMATIC SECTION.

NOTE:  
 CIRCUIT BOARD LAYOUT SHOWS COMPONENTS INSTALLED FOR VARIOUS MODELS.  
 FOR PROPER PARTS CONTENT FOR THE MODEL YOU ARE SERVICING,  
 PLEASE REFER TO THE SCHEMATIC DIAGRAM AND PARTS LIST.

NOTE:  
 CIRCUIT BOARD LAYOUT INCLUDES COMPONENTS WHICH ARE NOT USED.

### Parts Location

JACK C.B.A.									
Transistors			Switch			Resistors			
Q4001	D-2	F	SW7001	A-1	F	R4001	D-2	F	
Q4002	A-1	C	Capacitors			R4002	A-1	C	
Q4003	A-1	C	C4001	D-2	F	R4003	A-1	C	
Q4004	D-2	F	C4002	D-2	F	R4004	A-1	C	
Q4005	D-1	F	C4003	A-2	C	R4005	A-1	C	
Test Points			C4004	D-2	F	R4006	A-1	C	
TP7001	D-2	C	C4005	A-1	C	R4007	A-1	C	
TP7002	B-2	C	C4006	A-1	C	R4008	A-1	C	
TP7003	C-2	C	C4007	A-1	C	R4009	D-2	F	
TP7004	D-3	F	C4008	D-2	F	R4010	D-2	F	
Diodes			C4009	D-2	F	R4011	E-2	F	
D4001	A-1	C	C4010	E-1	F	R4012	D-2	F	
D7001	A-2	C	C4011	E-1	F	R4013	D-1	F	
D7002	E-3	F	C4012	E-2	F	R4014	E-1	F	
D7005	A-2	F	C6301	C-2	F	R4015	E-1	F	
D7006	A-3	F	C6302	C-1	F	R4016	E-1	F	
D7007	C-2	F	C6303	C-2	F	R4017	E-1	F	
D7008	D-2	F	C6304	C-2	C	R6301	C-2	C	
D7009	D-1	F	C6305	D-2	C	R6302	D-2	C	
D7010	D-1	F	C6306	D-2	C	R6303	D-2	C	
D7011	D-1	F	C6307	D-2	C	R6304	D-2	C	
D7012	D-1	F	C6308	D-2	C	R6305	D-2	C	
Coilss			C7001	A-2	C	R6306	C-2	C	
L4001	A-1	C	C7002	A-2	C	R6307	D-2	C	
L4002	E-1	F	C7003	E-3	F	R6308	D-2	C	
L6301	C-2	F	C7004	D-3	F	R6309	D-2	C	
L6302	D-2	C	C7005	C-1	C	R6310	D-2	C	
L7001	A-2	C	Miscellaneous			R6311	C-2	C	
L7002	A-2	C	BT7001	D-2	C	R6312	C-2	C	
L7003	A-2	C	FL7001	D-1	F	R6313	D-2	C	
L7004	E-2	F	FL7002	D-1	F	R6314	D-2	C	
L7008	A-3	F	FL7003	D-1	F	R6315	D-2	C	
L7009	A-2	F	JK4001	E-1	F	R6316	D-2	C	
L7010	E-3	F	JK7001	E-2	F	R7001	D-3	F	
L7011	D-3	F	JK7002	D-1	F	R7002	D-2	F	
			JK7003	C-1	F	R7003	C-2	F	
			JK7004	A-3	F	R7004	D-1	F	
			U7001	B-2	F	R7005	D-1	F	
						R7007	E-2	F	
						R7006	C-2	C	

(FOIL SIDE) 3

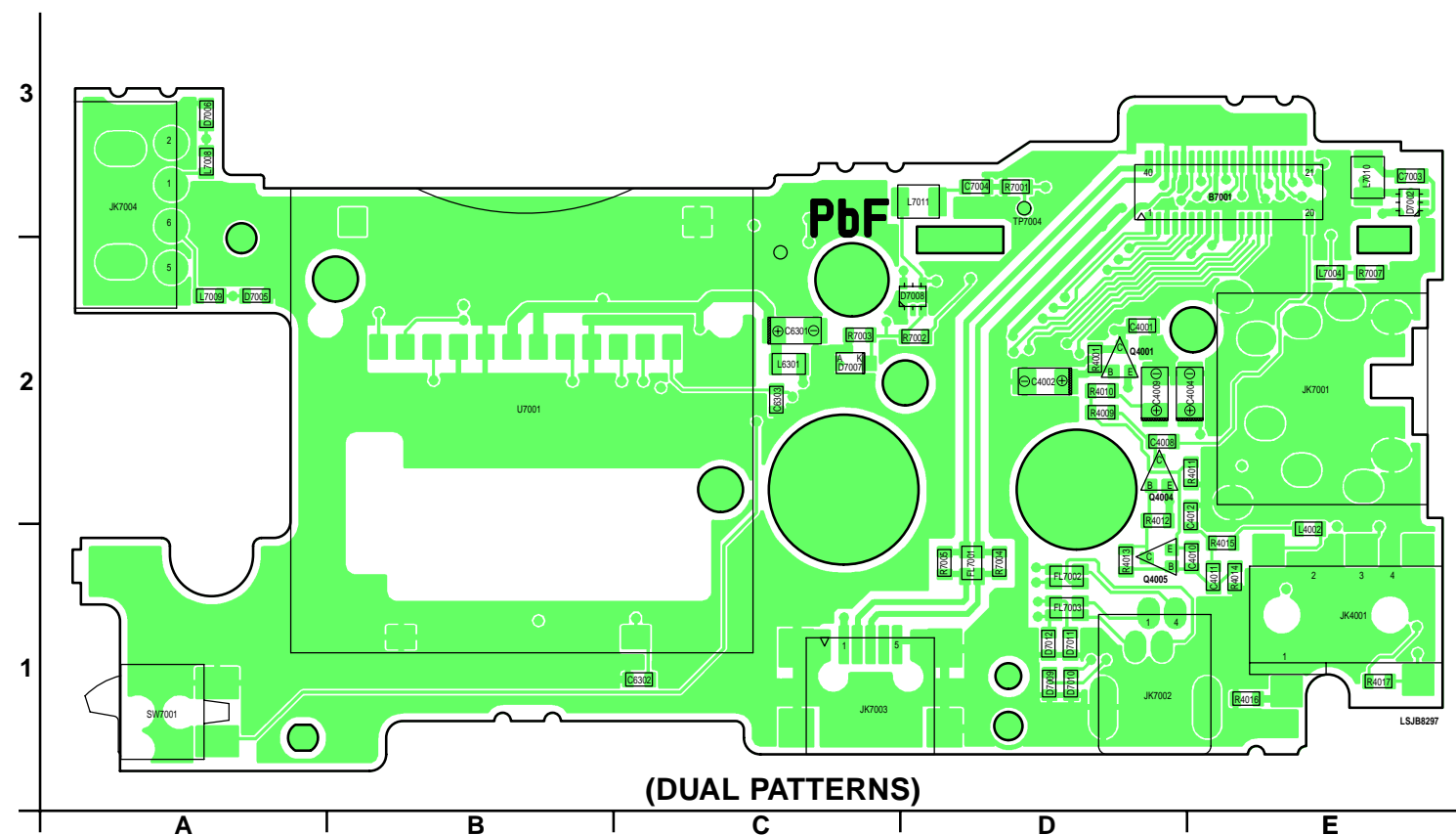

JACK C.B.A.  
 LSEP8297T1/LSEP8297D1/LSEP8297P1  
 /LSEP8297Q1/LSEP8297R1/LSEP8297S1  
 NV-GS6EE/GC, NV-GS17EG/EF/E/EP/EB, NV-GS18E, NV-GS21EG/EK/E/EP/EB,  
 NV-GS25GC/GN, NV-GS28GK, NV-GS35EG/E/EP/EB/GC/GN, NV-GS38GK

### 11.3. LCD BACKLIGHT C.B.A.

#### LCD BACKLIGHT C.B.A. LSEP8298P1

NOTE:  
CIRCUIT BOARD LAYOUT SHOWS COMPONENTS INSTALLED FOR VARIOUS MODELS.  
FOR PROPER PARTS CONTENT FOR THE MODEL YOU ARE SERVICING,  
PLEASE REFER TO THE SCHEMATIC DIAGRAM AND PARTS LIST.

NOTE:  
FOR SCHEMATIC DIAGRAM AND CIRCUIT BOARD LAYOUT NOTES,  
REFER TO BEGINNING OF SCHEMATIC SECTION.

NOTE:  
ALL INDIVIDUAL PARTS EXCEPT D8101, D8103, D8105, AND D8107  
ON LCD BACKLIGHT C.B.A. ARE SUPPLIED AS REPLACEMENT PARTS.  
WHEN SERVICING THESE PARTS, REPLACE LCD BACKLIGHT C.B.A.  
INSTEAD OF INDIVIDUAL PARTS.

NOTE:  
CIRCUIT BOARD LAYOUT INCLUDES COMPONENTS WHICH ARE NOT USED.

(COMPONENT SIDE)

(FOIL SIDE)

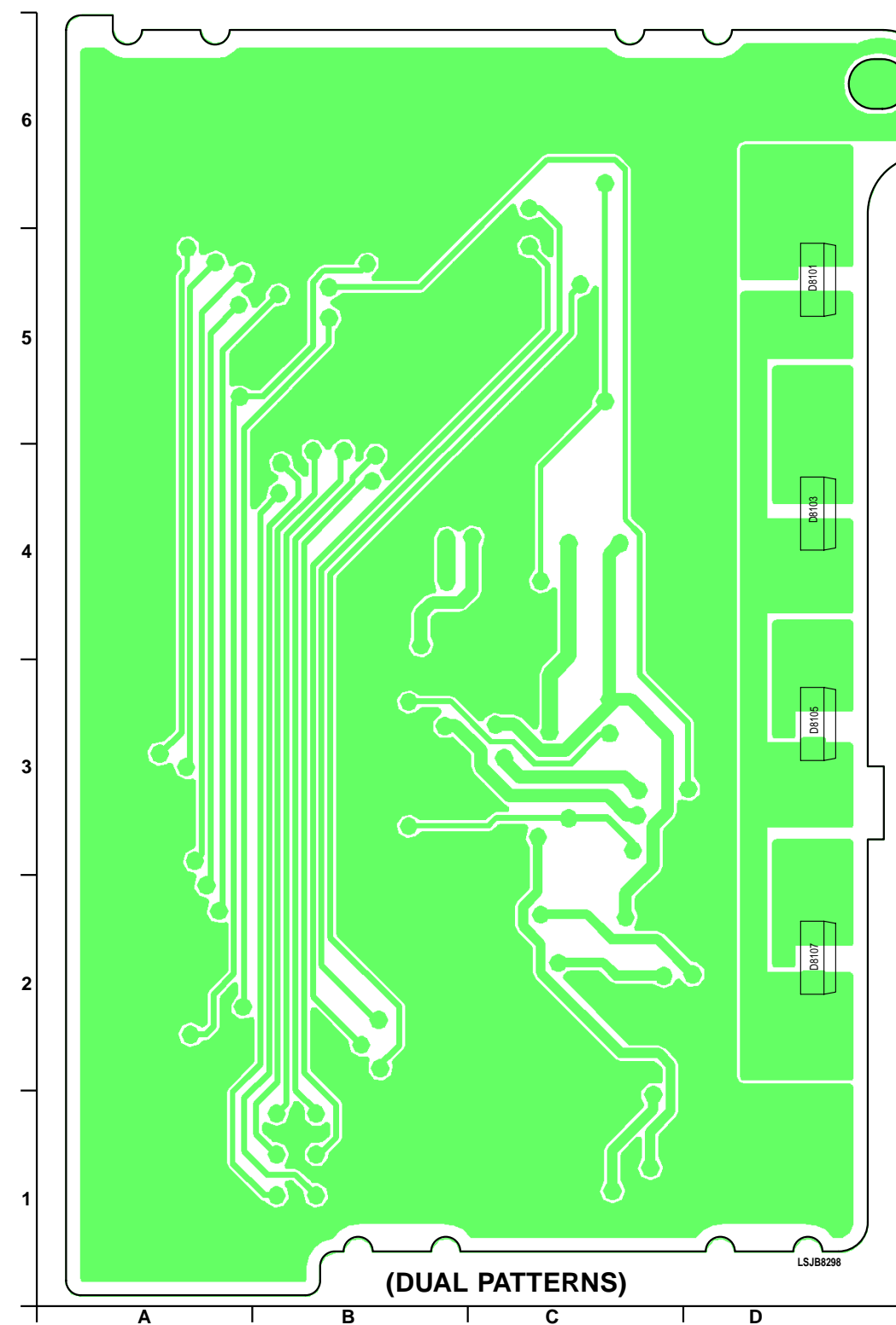
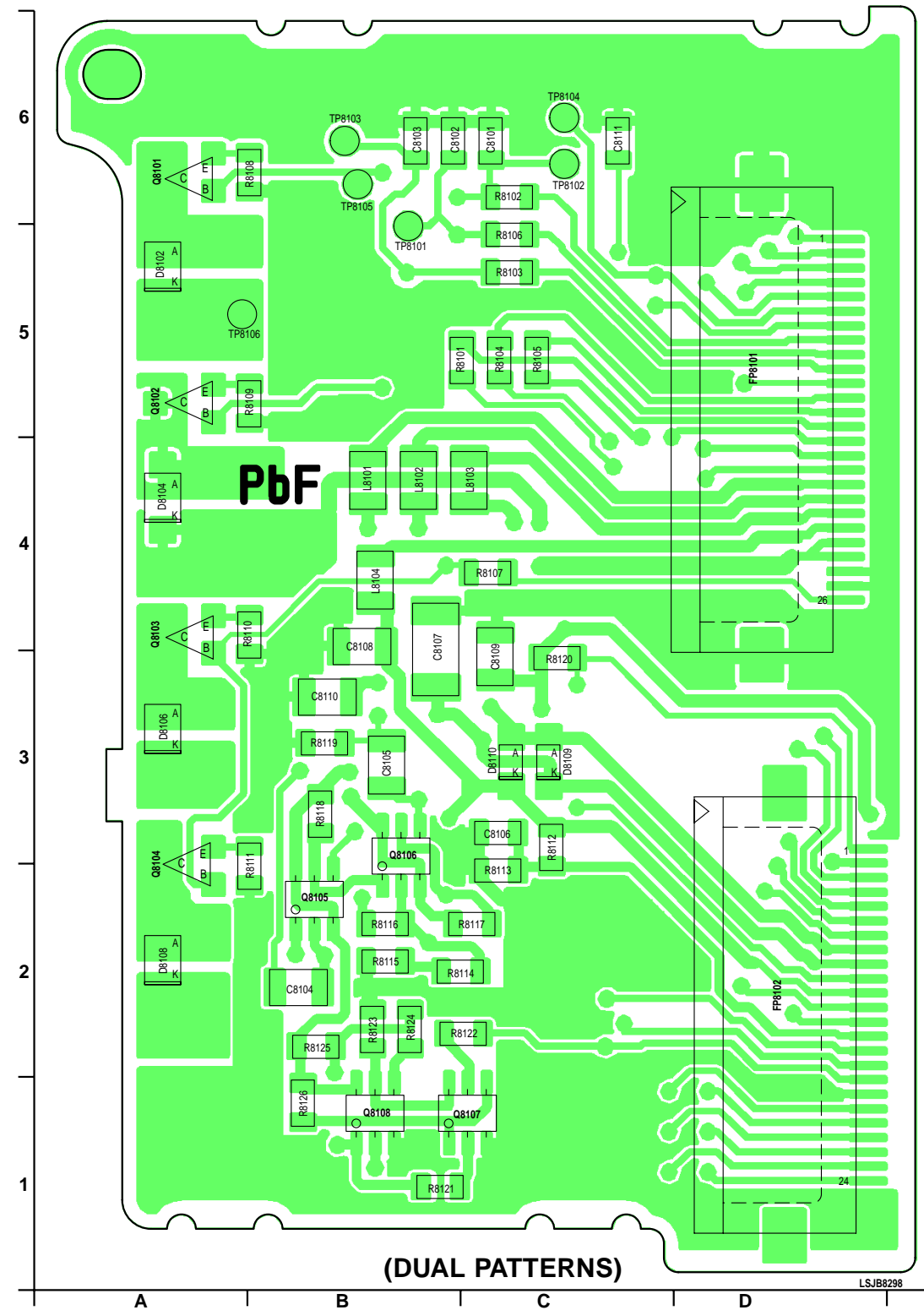

**Parts Location**

LCD C.B.A.					
Transistors			Capacitors		
Q8101	A-6	C	C8101	C-6	C
Q8102	A-5	C	C8102	B-6	C
Q8103	A-4	C	C8103	B-6	C
Q8104	A-2	C	C8104	B-2	C
Q8105	B-2	C	C8105	B-3	C
Q8106	B-3	C	C8106	C-3	C
Q8107	C-1	C	C8107	B-3	C
Q8108	B-1	C	C8108	B-4	C
			C8109	C-3	C
			C8110	B-3	C
			C8111	C-6	C
Test Points					
TP8101	B-5	C			
TP8102	C-6	C			
TP8103	B-6	C			
TP8104	C-6	C			
TP8105	B-6	C			
TP8106	A-5	C			
Connectors					
FP8101	D-5	C			
FP8102	D-2	C			
Diodes					
D8101	D-5	F	R8108	B-6	C
D8102	A-5	C	R8109	B-5	C
D8103	D-4	F	R8110	B-4	C
D8104	A-4	C	R8111	B-2	C
D8105	D-3	F	R8112	C-3	C
D8106	A-3	C	R8113	C-2	C
D8107	D-2	F	R8114	B-2	C
D8108	A-2	C	R8115	B-2	C
D8109	C-3	C	R8116	B-2	C
D8110	C-3	C	R8117	C-2	C
Coils					
L8101	B-4	C	R8118	B-3	C
L8102	B-4	C	R8119	B-3	C
L8103	C-4	C	R8120	C-3	C
L8104	B-4	C	R8121	B-1	C
			R8122	B-2	C
			R8123	B-2	C
			R8124	B-2	C
			R8125	B-2	C
			R8126	B-1	C

LCD BACKLIGHT C.B.A. LSEP8298P1  
NV-GS6EE/GC, NV-GS17EG/EF/E/EP/EB, NV-GS18E, NV-GS21EG/EK/E/EP/EB,  
NV-GS25GC/GN, NV-GS28GK, NV-GS35EG/E/EP/EB/GC/GN, NV-GS38GK



# 12 BLOCK DIAGRAMS

## OVERALL BLOCK DIAGRAM

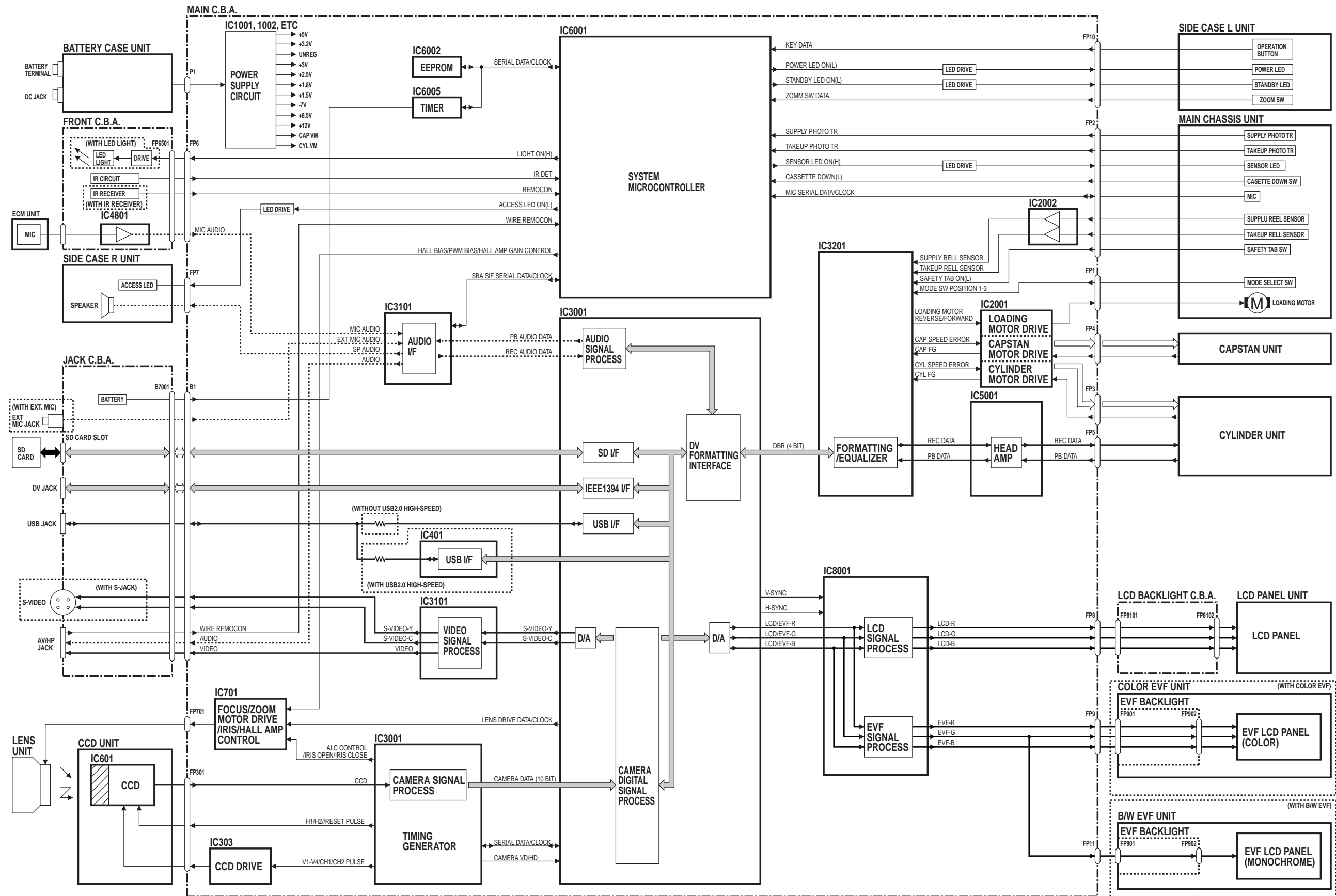

OVERALL BLOCK DIAGRAM  
 NV-GS6EE/GC, NV-GS17EG/EF/E/EP/EB, NV-GS18E, NV-GS21EG/EK/E/EP/EB,  
 NV-GS25GC/GN, NV-GS28GK, NV-GS35EG/E/EP/EB/GC/GN, NV-GS38GK

### CCD DRIVE BLOCK DIAGRAM

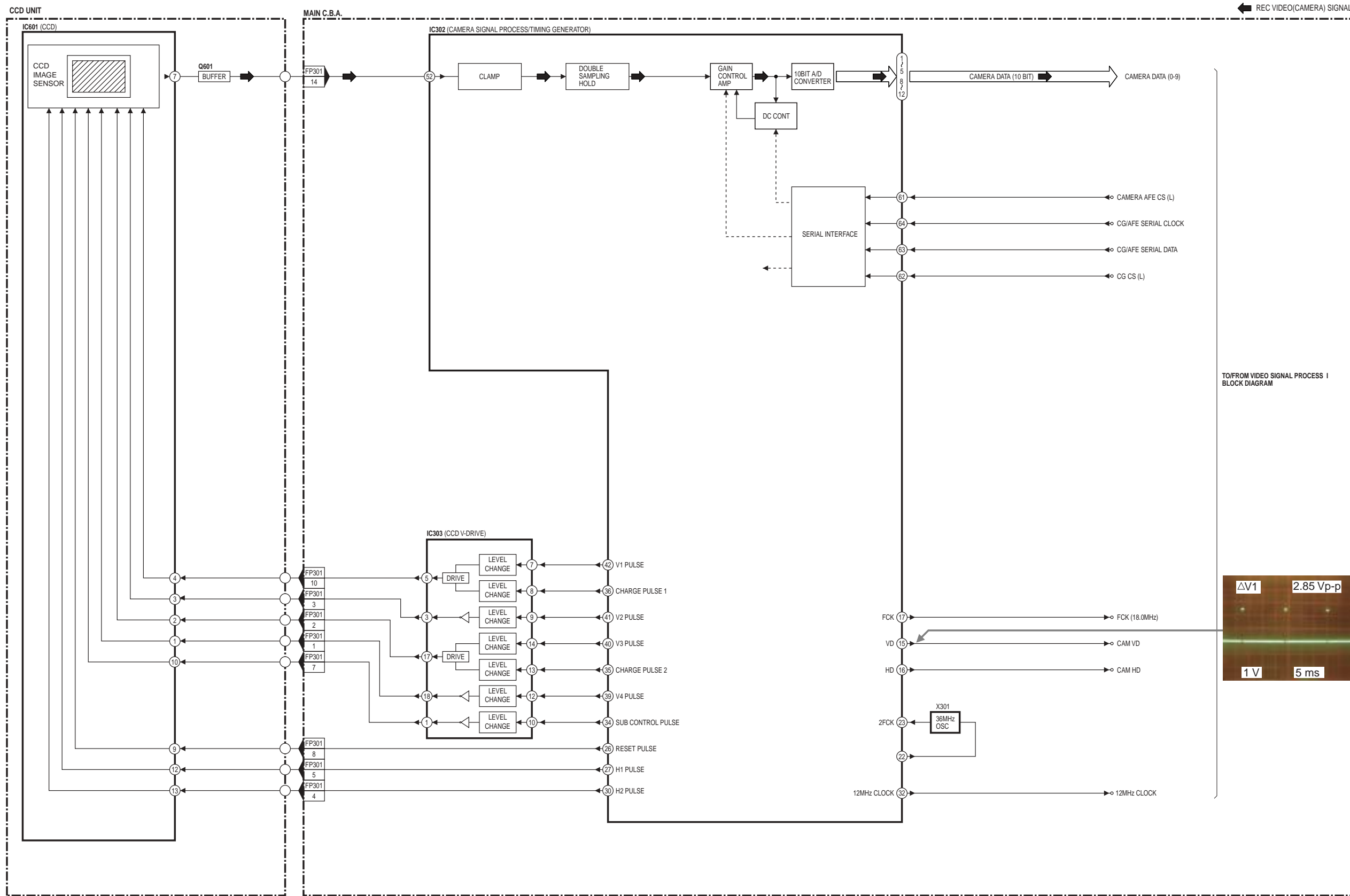

CCD DRIVE BLOCK DIAGRAM  
 NV-GS6EE/GC, NV-GS17EG/EF/E/EP/EB, NV-GS18E, NV-GS21EG/EK/E/EP/EB,  
 NV-GS25GC/GN, NV-GS28GK, NV-GS35EG/E/EP/EB/GC/GN, NV-GS38GK



# VIDEO SIGNAL PROCESS I BLOCK DIAGRAM

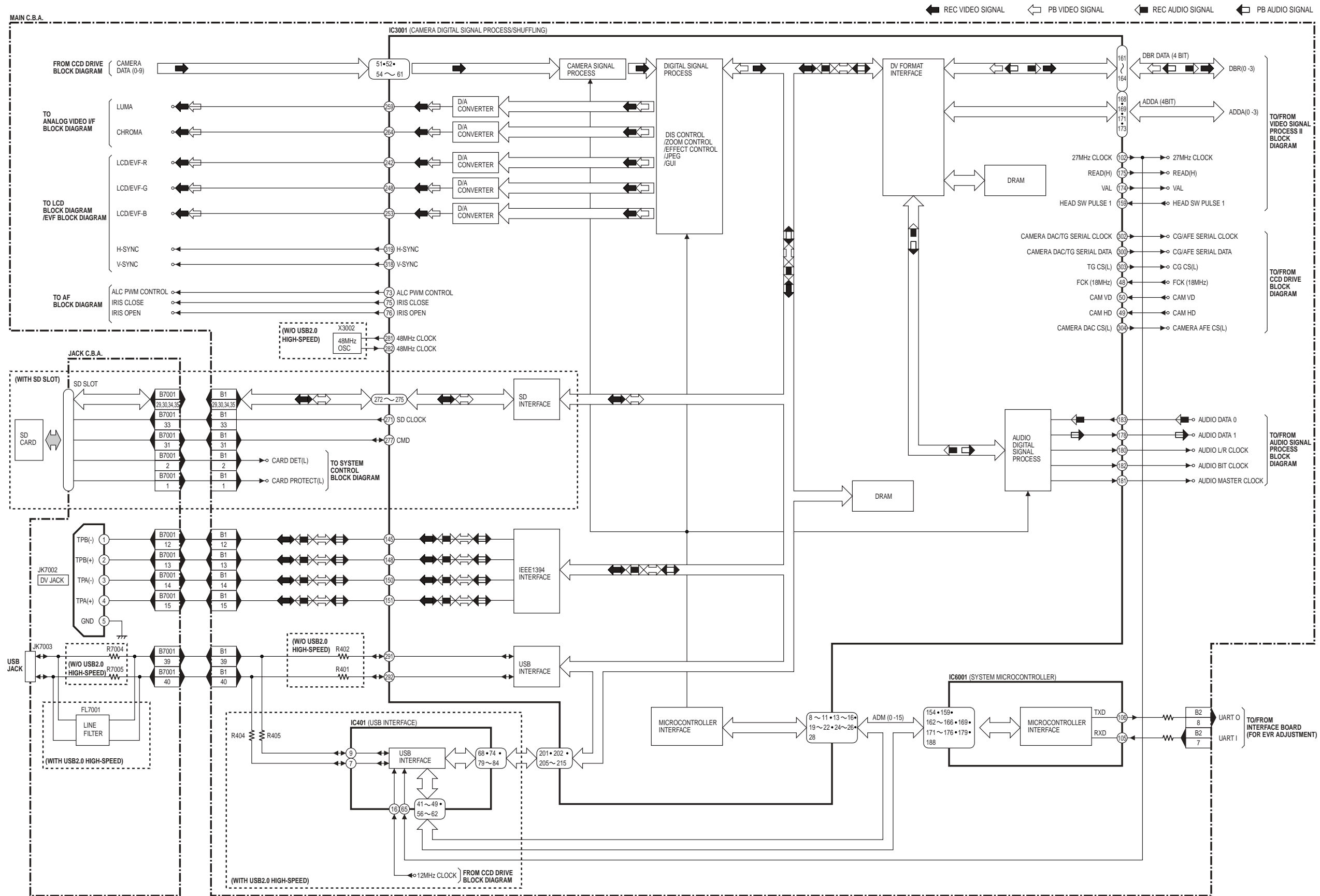

VIDEO SIGNAL PROCESS I BLOCK DIAGRAM  
 NV-GS6EE/GC, NV-GS17EG/EF/E/EP/EB, NV-GS18E, NV-GS21EG/EK/E/EP/EB,  
 NV-GS25GC/GN, NV-GS28GK, NV-GS35EG/E/EP/EB/GC/GN, NV-GS38GK

# VIDEO SIGNAL PROCESS II BLOCK DIAGRAM

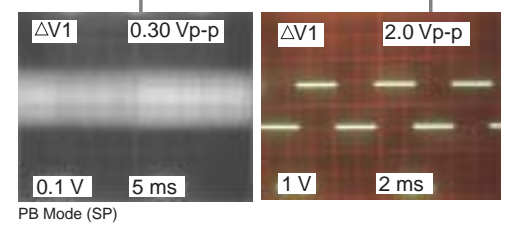
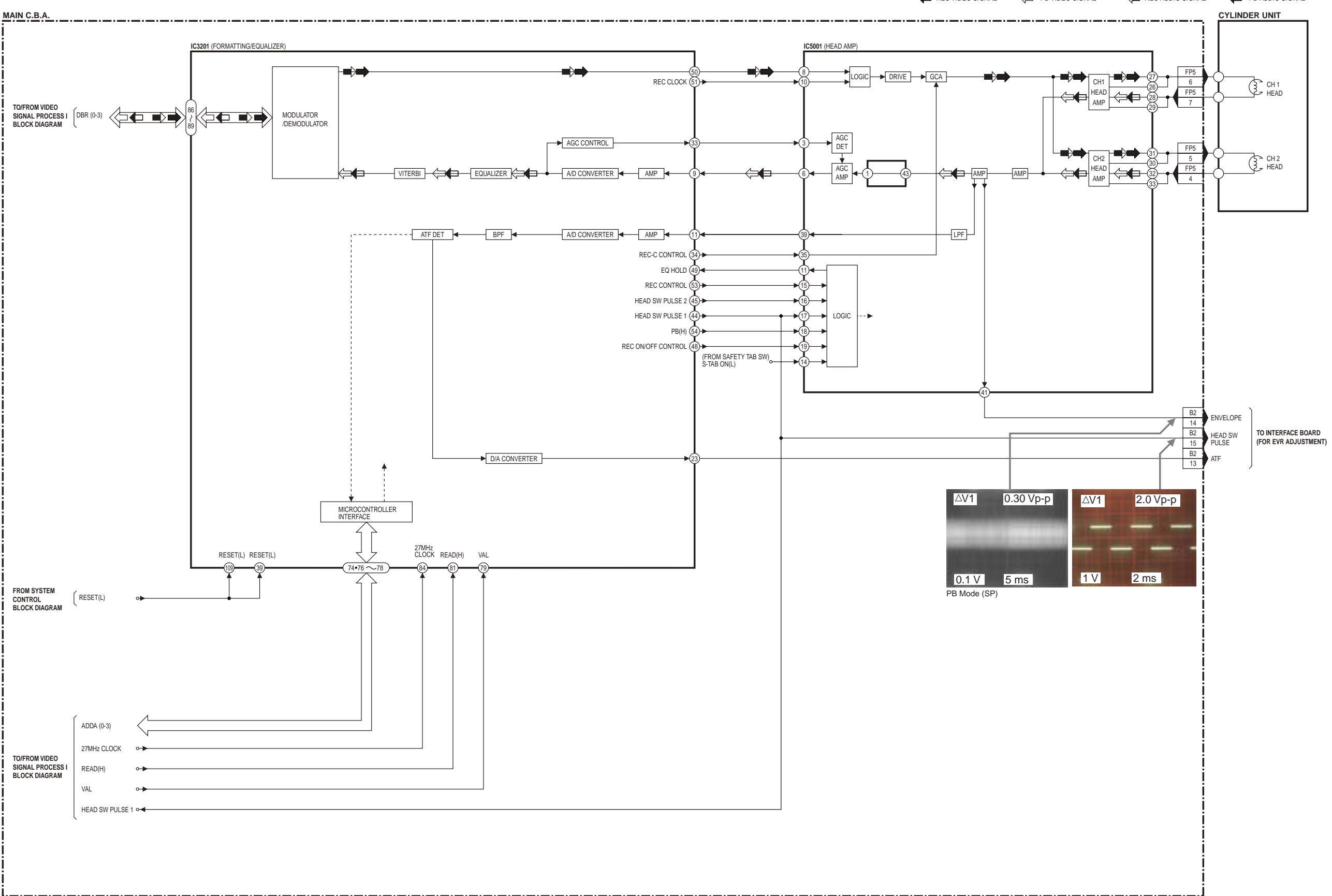

VIDEO SIGNAL PROCESS II BLOCK DIAGRAM  
 NV-GS6EE/GC, NV-GS17EG/EF/E/EP/EB, NV-GS18E, NV-GS21EG/EK/E/EP/EB,  
 NV-GS25GC/GN, NV-GS28GK, NV-GS35EG/E/EP/EB/GC/GN, NV-GS38GK

### ANALOG VIDEO I/F BLOCK DIAGRAM

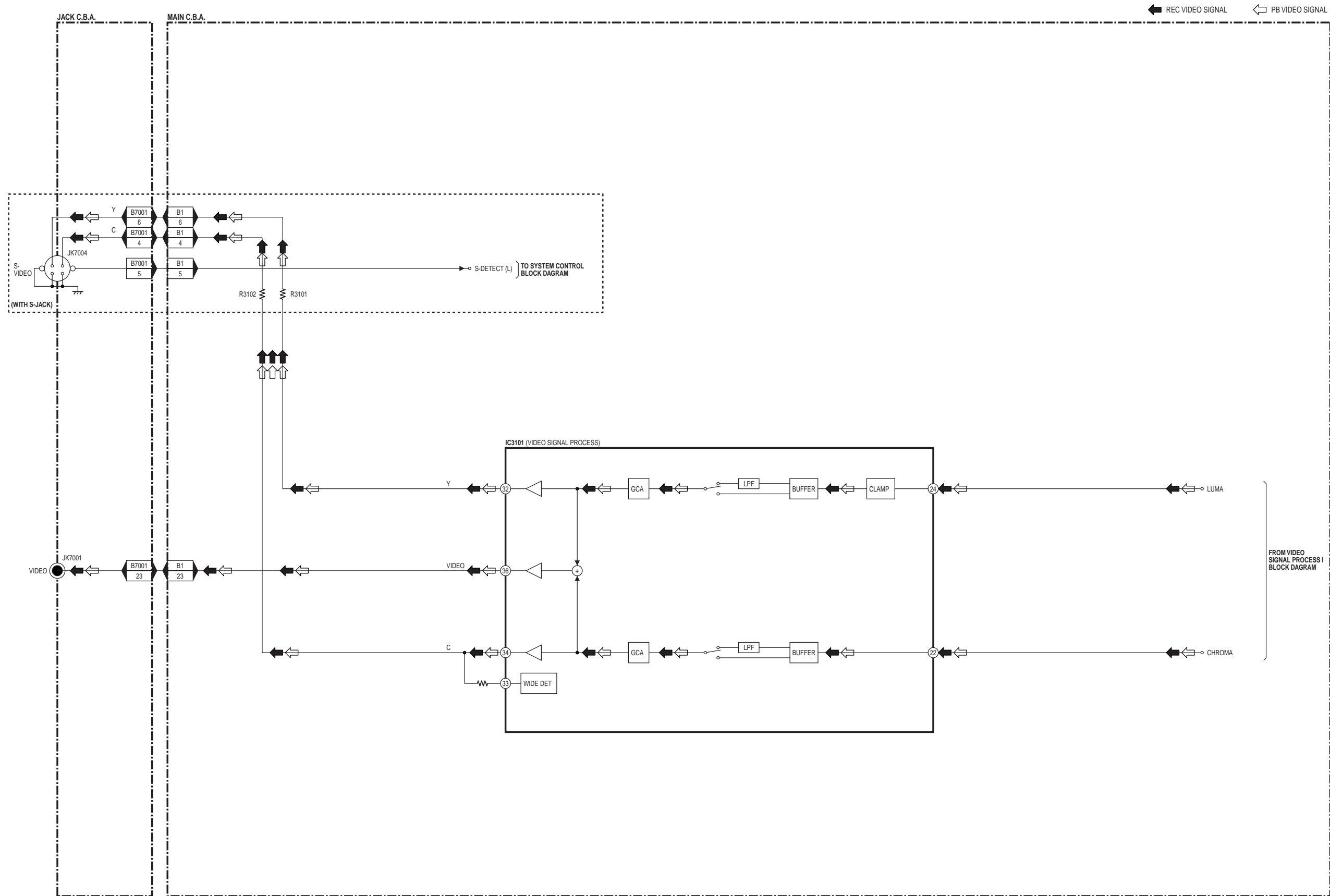

ANALOG VIDEO I/F BLOCK DIAGRAM  
 NV-GS6EE/GC, NV-GS17EG/EF/E/EP/EB, NV-GS18E, NV-GS21EG/EK/E/EP/EB,  
 NV-GS25GC/GN, NV-GS28GK, NV-GS35EG/E/EP/EB/GC/GN, NV-GS38GK

# AUDIO SIGNAL PROCESS BLOCK DIAGRAM

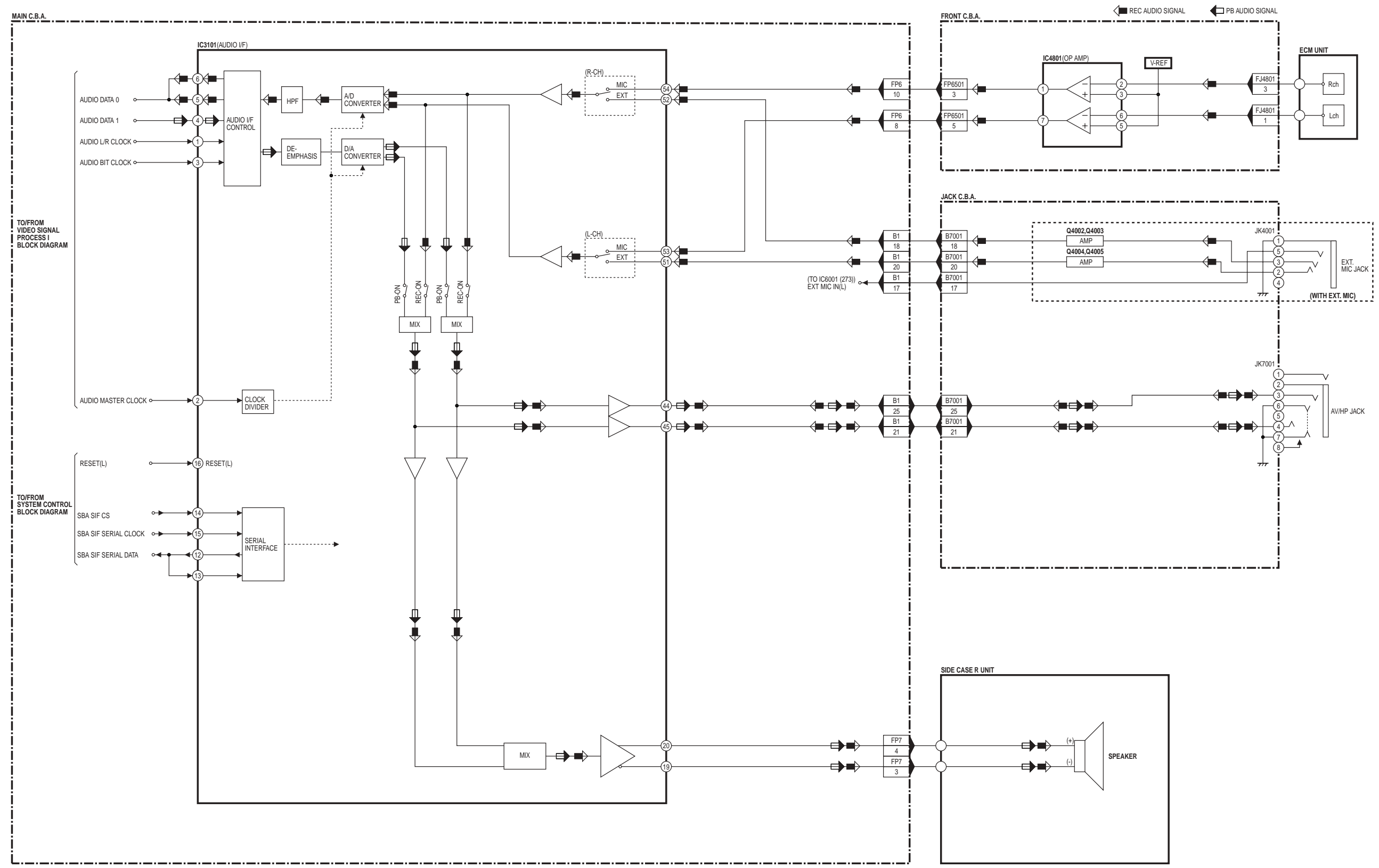

**AUDIO SIGNAL PROCESS BLOCK DIAGRAM**  
 NV-GS6EE/GC, NV-GS17EG/EF/E/EP/EB, NV-GS18E, NV-GS21EG/EK/E/EP/EB,  
 NV-GS25GC/GN, NV-GS28GK, NV-GS35EG/E/EP/EB/GC/GN, NV-GS38GK

# SYSTEM CONTROL BLOCK DIAGRAM

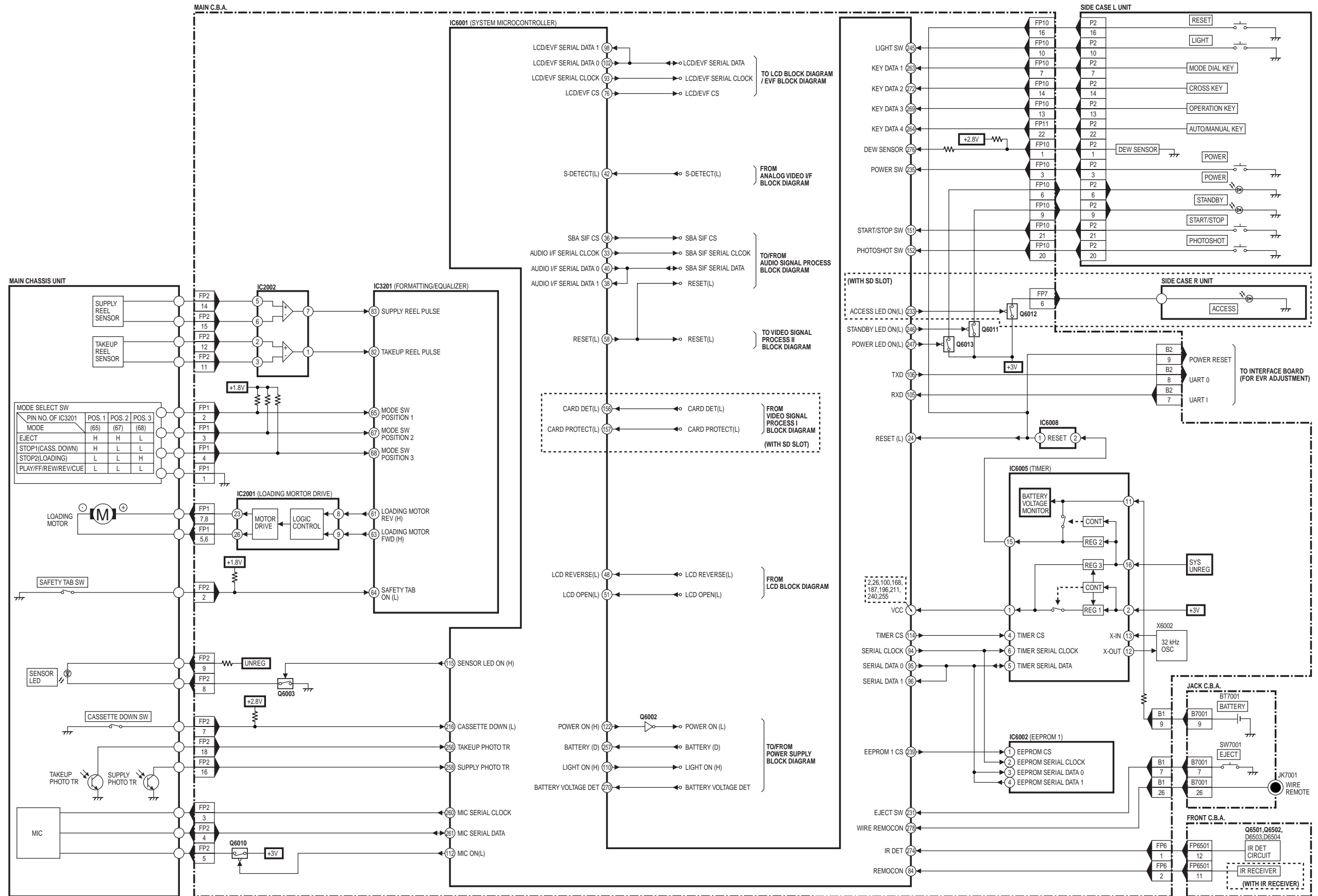

SYSTEM CONTROL BLOCK DIAGRAM  
 NV-GS6EE/GC, NV-GS17EG/EF/E/EP/EB, NV-GS18E, NV-GS21EG/EK/E/EP/EB,  
 NV-GS25GC/GN, NV-GS28GK, NV-GS35EG/E/EP/EB/GC/GN, NV-GS38GK

### SERVO BLOCK DIAGRAM

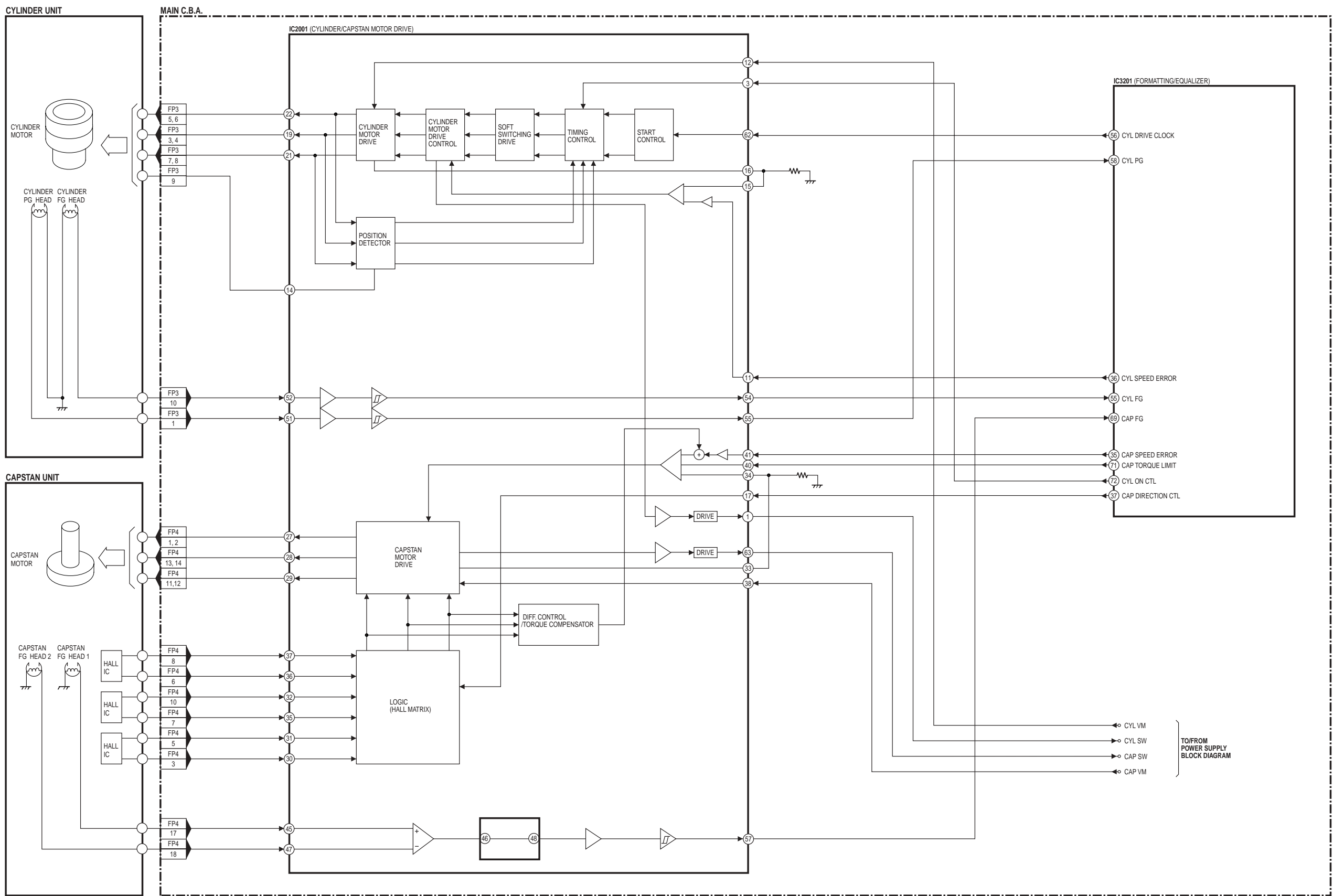

SERVO BLOCK DIAGRAM  
 NV-GS6EE/GC, NV-GS17EG/EF/E/EP/EB, NV-GS18E, NV-GS21EG/EK/E/EP/EB,  
 NV-GS25GC/GN, NV-GS28GK, NV-GS35EG/E/EP/EB/GC/GN, NV-GS38GK

# AF BLOCK DIAGRAM

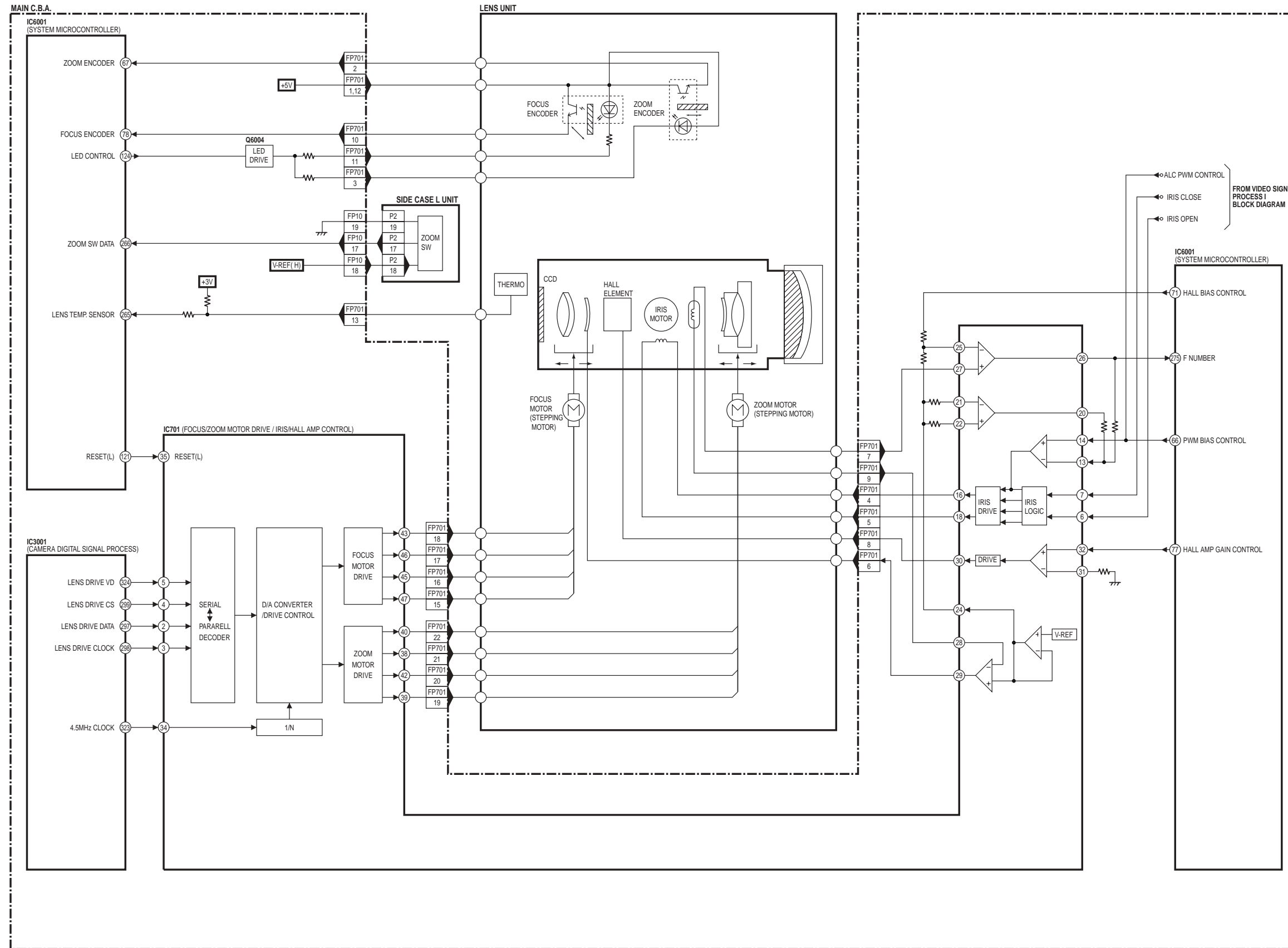

AF BLOCK DIAGRAM  
 NV-GS6EE/GC, NV-GS17EG/EF/E/EP/EB, NV-GS18E, NV-GS21EG/EK/E/EP/EB,  
 NV-GS25GC/GN, NV-GS28GK, NV-GS35EG/E/EP/EB/GC/GN, NV-GS38GK

# LCD DRIVE BLOCK DIAGRAM

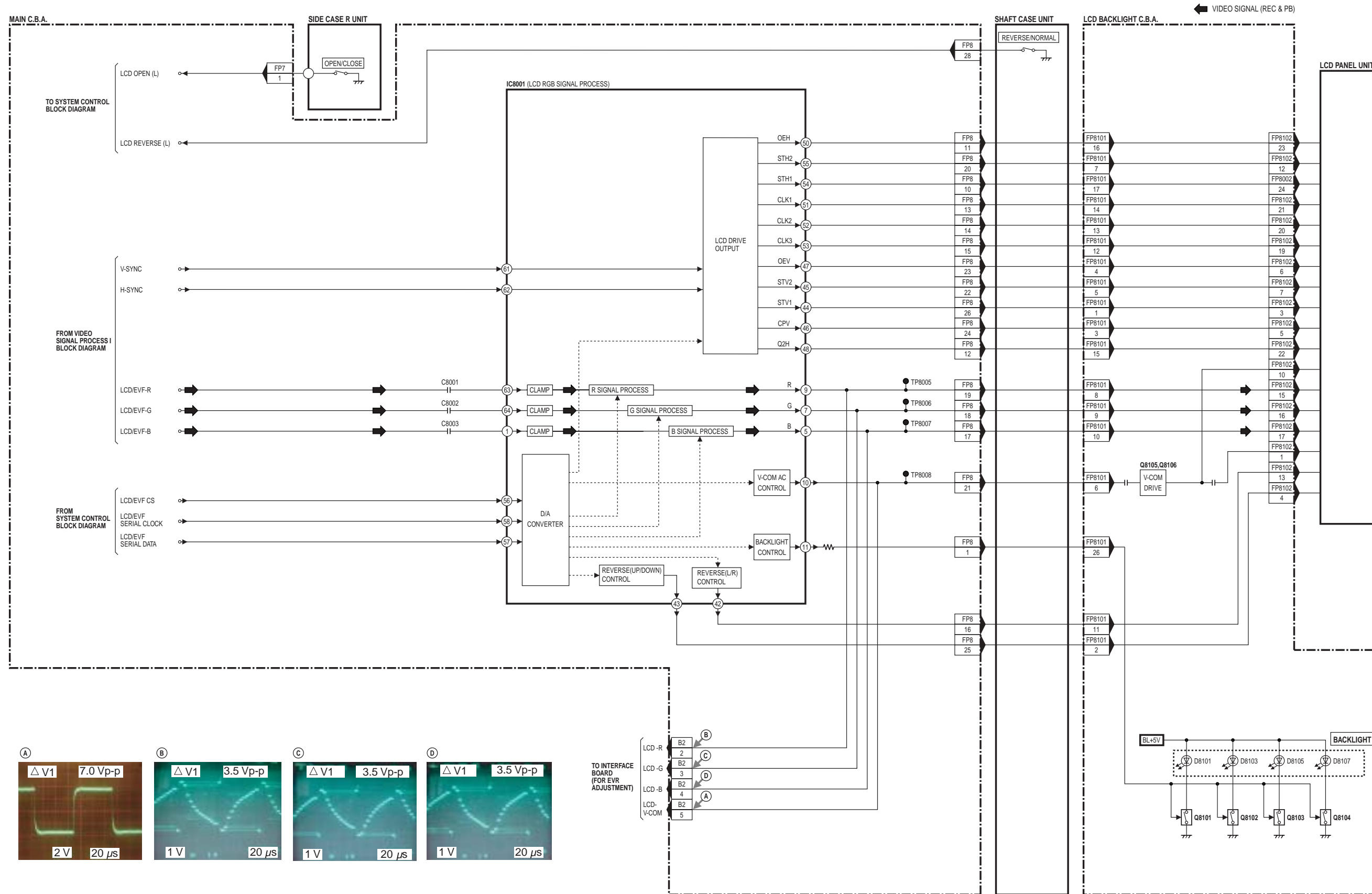

LCD DRIVE BLOCK DIAGRAM  
 NV-GS6EE/GC, NV-GS17EG/EF/E/EP/EB, NV-GS18E, NV-GS21EG/EK/E/EP/EB,  
 NV-GS25GC/GN, NV-GS28GK, NV-GS35EG/E/EP/EB/GC/GN, NV-GS38GK



**EVF BLOCK DIAGRAM (Models: NV-GS6EE/GC, NV-GS17EG/EF/E/EP/EB, NV-GS18E, NV-GS21EG/EK/E/EP/EB, NV-GS25GC/GN, NV-GS28GK)**

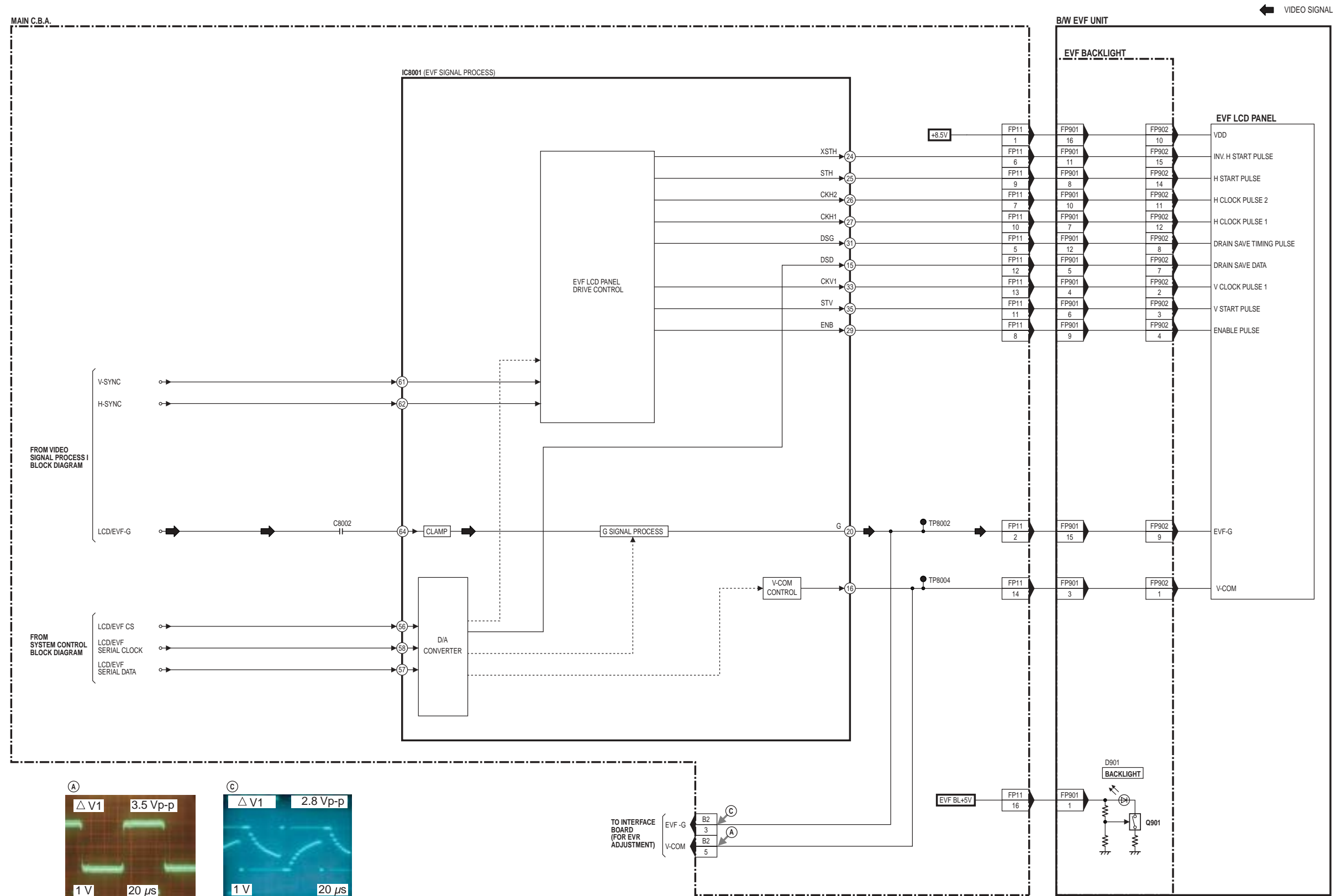

**EVF BLOCK DIAGRAM**  
**NV-GS6EE/GC, NV-GS17EG/EF/E/EP/EB, NV-GS18E,**  
**NV-GS21EG/EK/E/EP/EB, NV-GS25GC/GN, NV-GS28GK**

### EVF BLOCK DIAGRAM (Models: NV-GS35EG/E/EP/EB/GC/GN, NV-GS38GK)

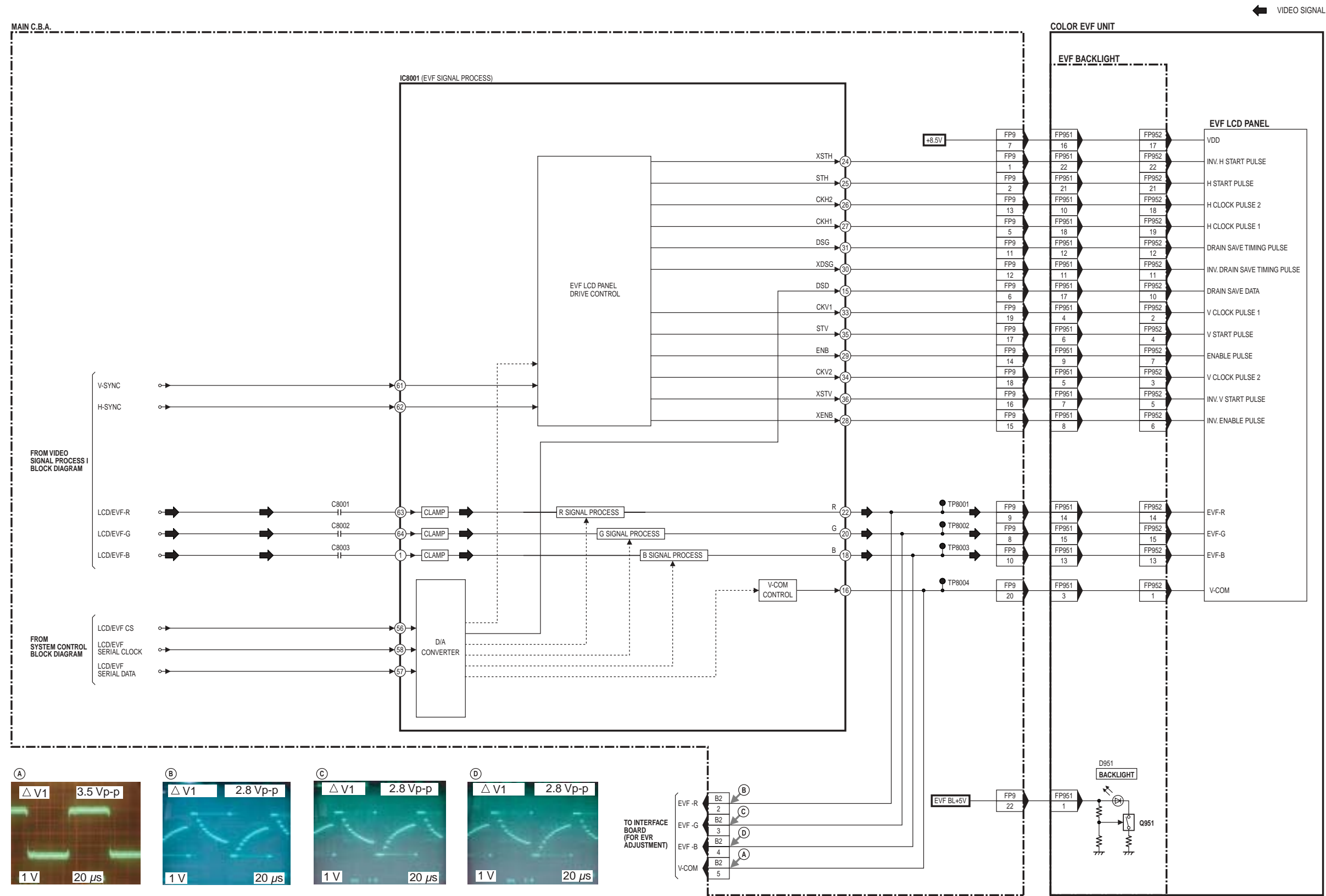

EVF BLOCK DIAGRAM  
NV-GS35EG/E/EP/EB/GC/GN, NV-GS38GK





# 13 EXPLODED VIEWS

## 13.1. MAIN PARTS SECTION

### 1 MAIN PARTS SECTION

**Note:**

1. Parts with no Ref. No. in "EXPLODED VIEW" are not supplied. And some Ref. No. will be skipped. Be sure to make your orders of replacement parts according to the parts list.
2. The parts indicated by the dotted line  are for Ass'y only and are not supplied.
3. Disregard Ref. No. suffixes when ordering parts. They are used to describe parts in "Disassembly/Assembly Procedures" section.

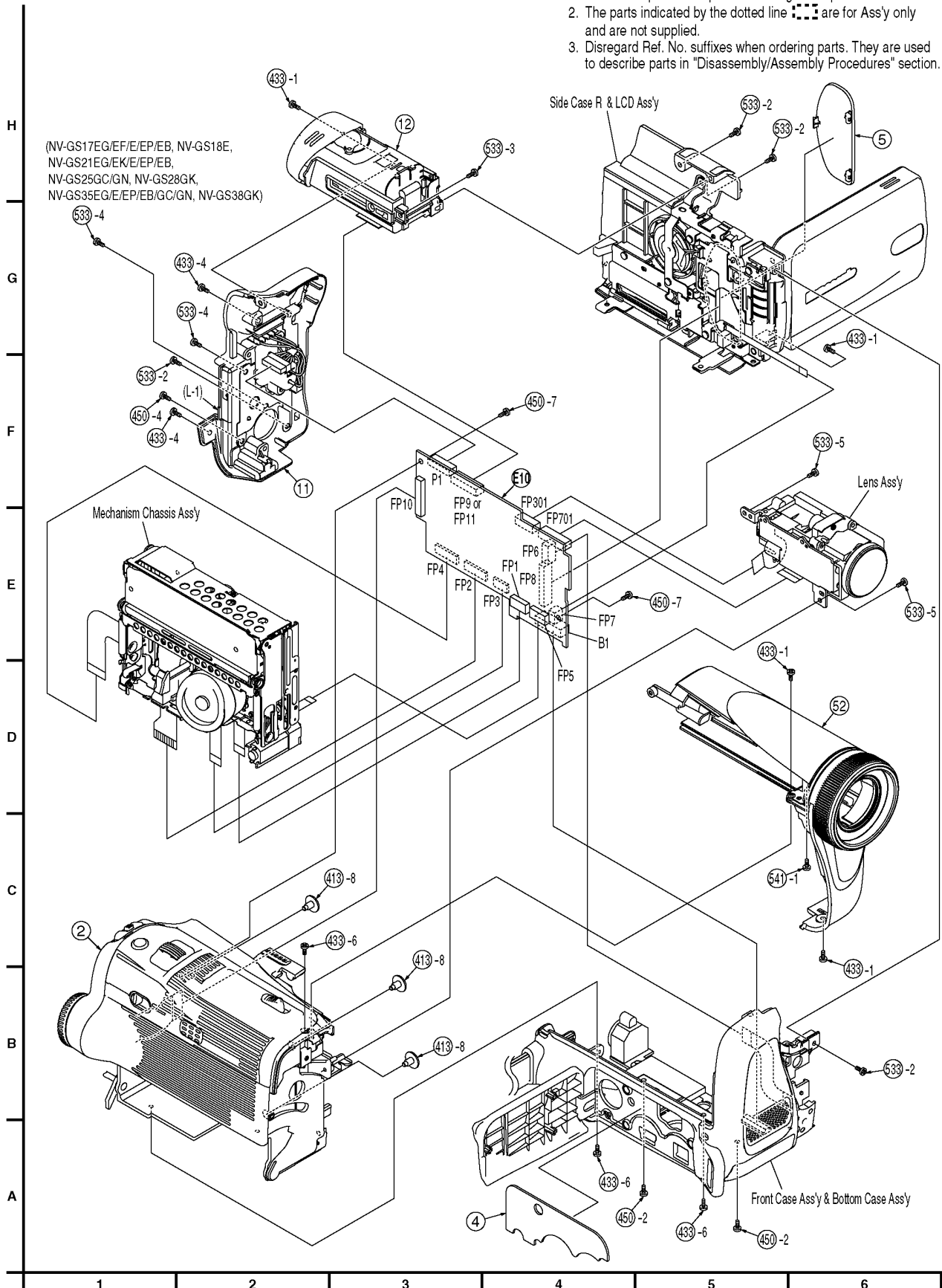

## 13.2. FRONT AND BOTTOM CASE SECTION

### 2 FRONT AND BOTTOM CASE SECTION

**Note:**

1. Parts with no Ref. No. in "EXPLODED VIEW" are not supplied. And some Ref. No. will be skipped. Be sure to make your orders of replacement parts according to the parts list.
2. The parts indicated by the dotted line  are for Ass'y only and are not supplied.
3. Disregard Ref. No. suffixes when ordering parts. They are used to describe parts in "Disassembly/Assembly Procedures" section.

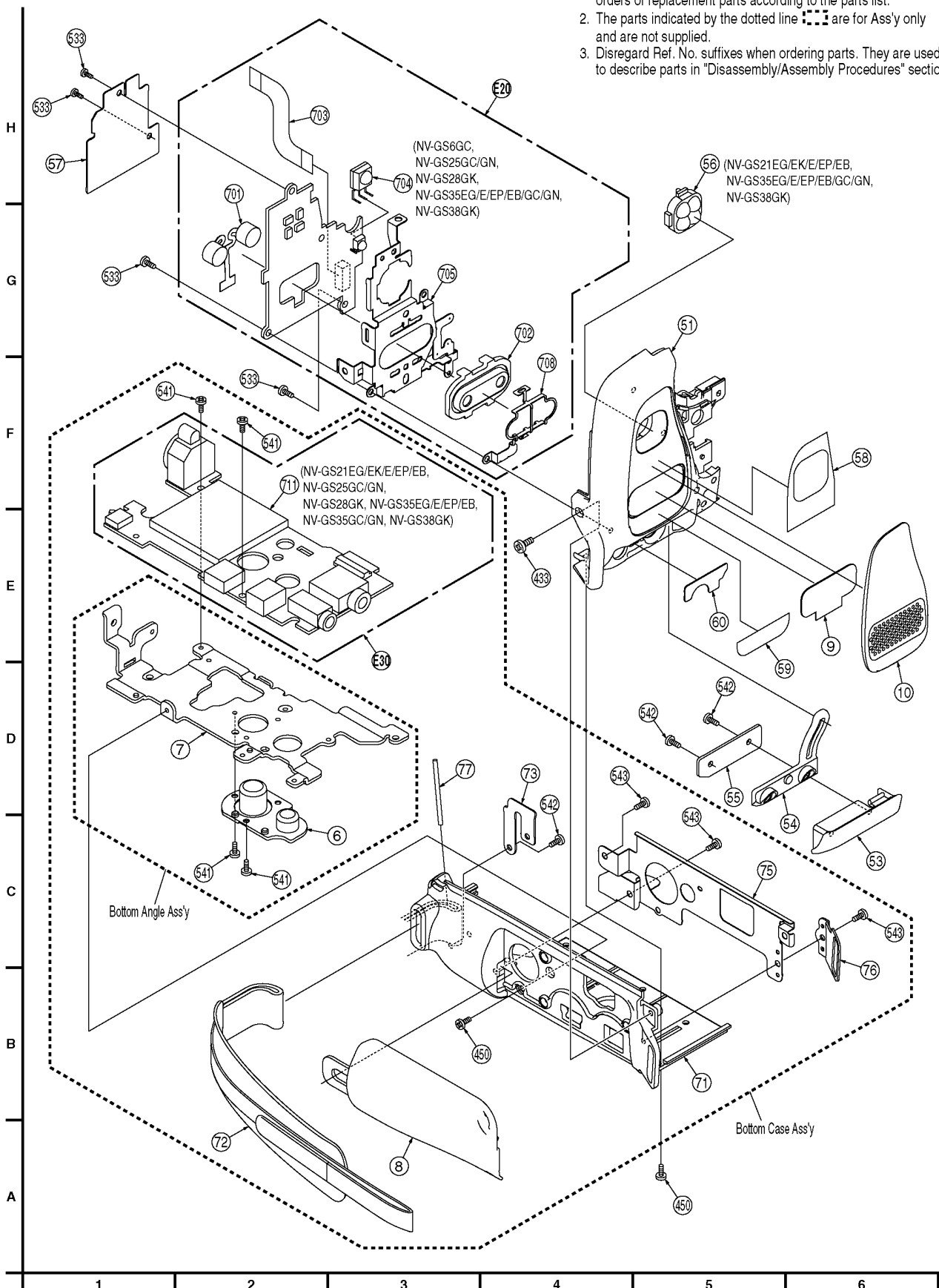

### 13.3. SIDE CASE R AND LCD SECTION

#### ③ SIDE CASE R AND LCD SECTION

**Note:**

1. Parts with no Ref. No. in "EXPLODED VIEW" are not supplied. And some Ref. No. will be skipped. Be sure to make your orders of replacement parts according to the parts list.
2. The parts indicated by the dotted line are for Ass'y only and are not supplied.
3. Disregard Ref. No. suffixes when ordering parts. They are used to describe parts in "Disassembly/Assembly Procedures" section.

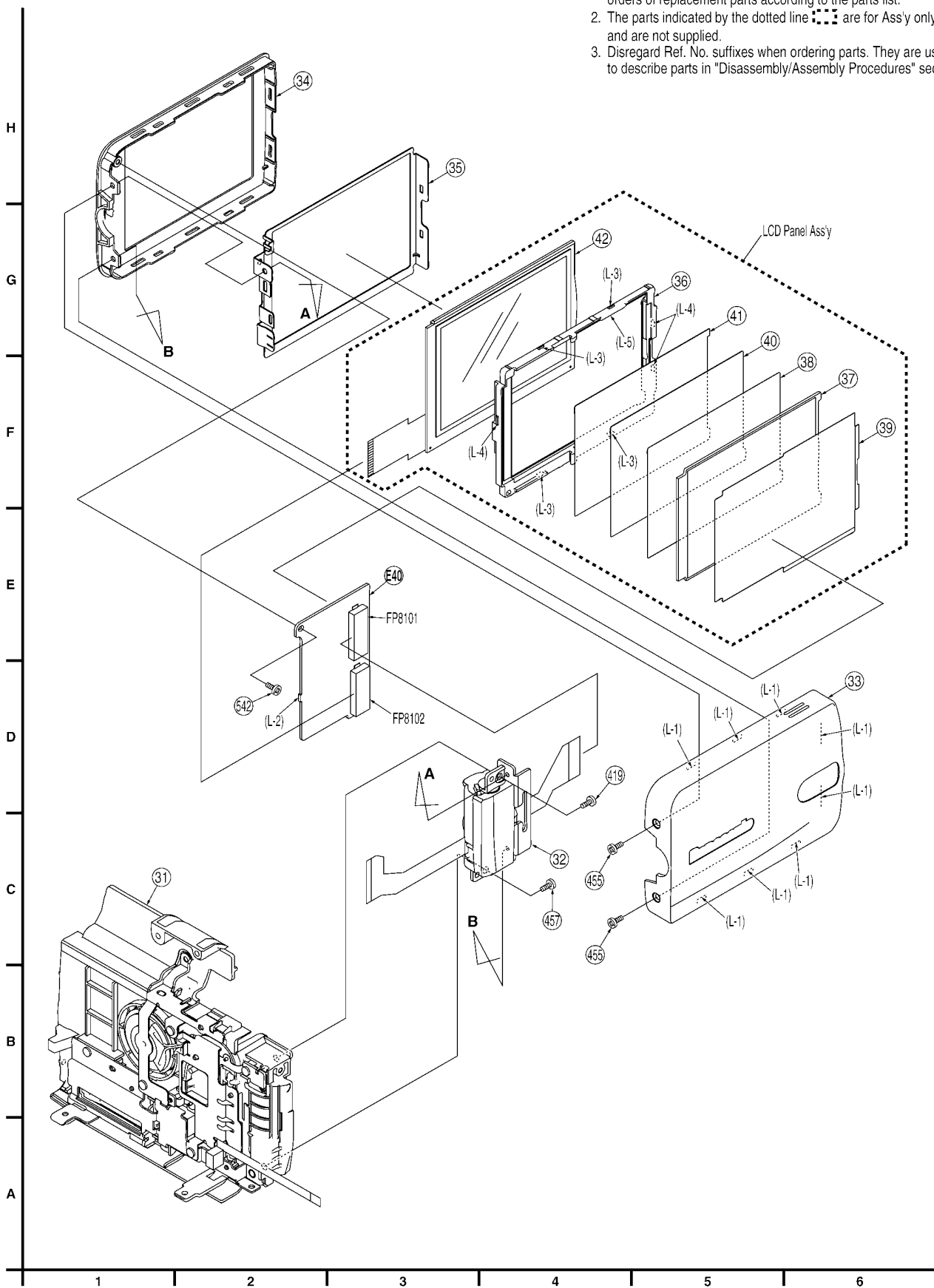

# 13.4. CCD AND LENS SECTION

## 4 CCD AND LENS SECTION

**Note:**

1. Parts with no Ref. No. in "EXPLODED VIEW" are not supplied. And some Ref. No. will be skipped. Be sure to make your orders of replacement parts according to the parts list.
2. The parts indicated by the dotted line  are for Ass'y only and are not supplied.
3. Disregard Ref. No. suffixes when ordering parts. They are used to describe parts in "Disassembly/Assembly Procedures" section.

**LUBRICATION POINTS**

When the marked parts are replaced, apply the recommended lubricants or adhesive for better maintenance of the unit.

Mark	Kind of Lubricant	Availability	Part Number
	Grease	Available from Factory	LSUQ0050

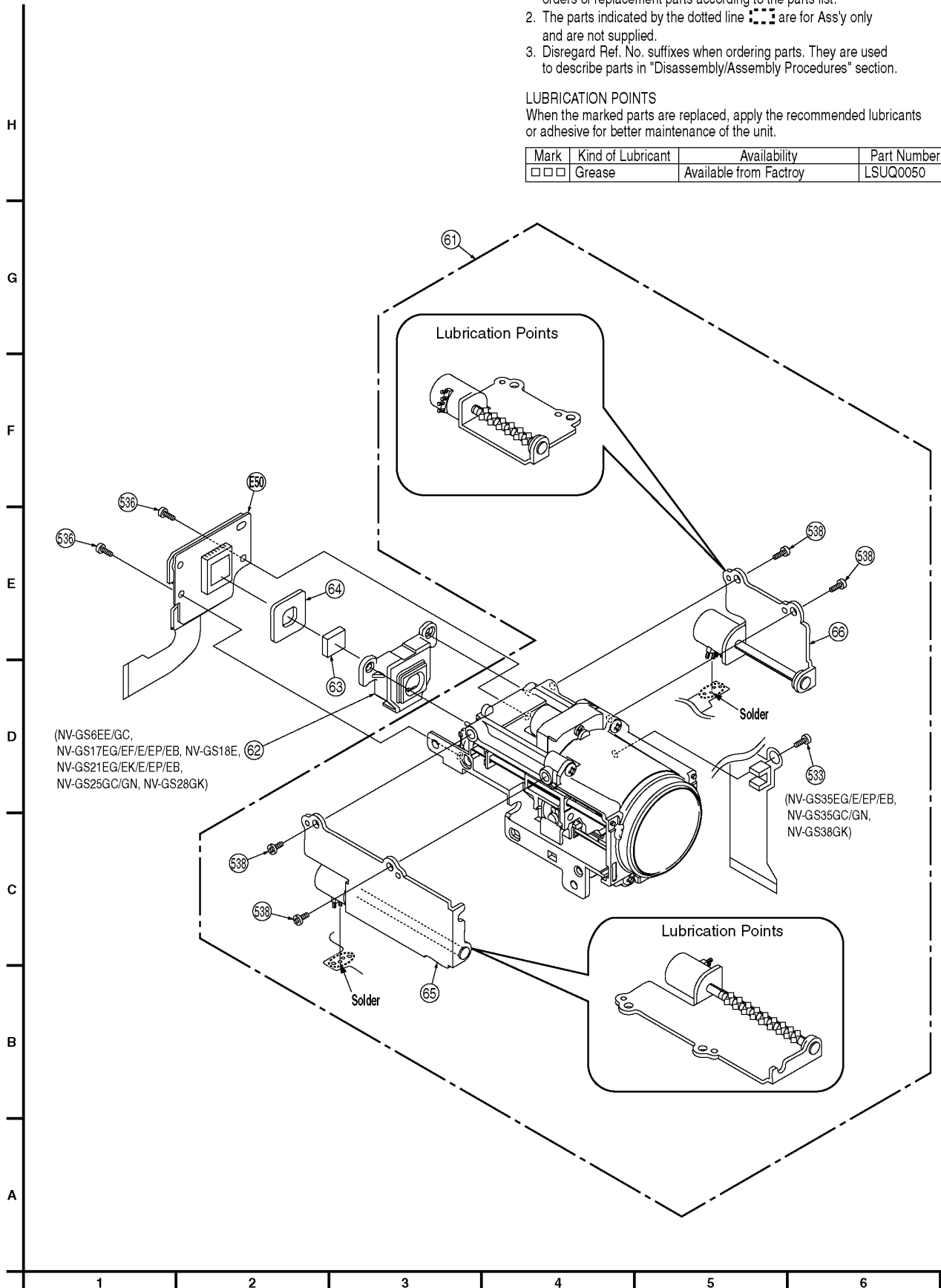

(NV-GS6EE/GC,  
NV-GS17EG/EF/E/EP/EB, NV-GS18E, 62  
NV-GS21EG/EK/E/EP/EB,  
NV-GS25GC/GN, NV-GS28GK)

(NV-GS35EG/E/EP/EB,  
NV-GS35GC/GN,  
NV-GS38GK)





## 13.6. MECHANISM SECTION

### ⑥ MECHANISM SECTION

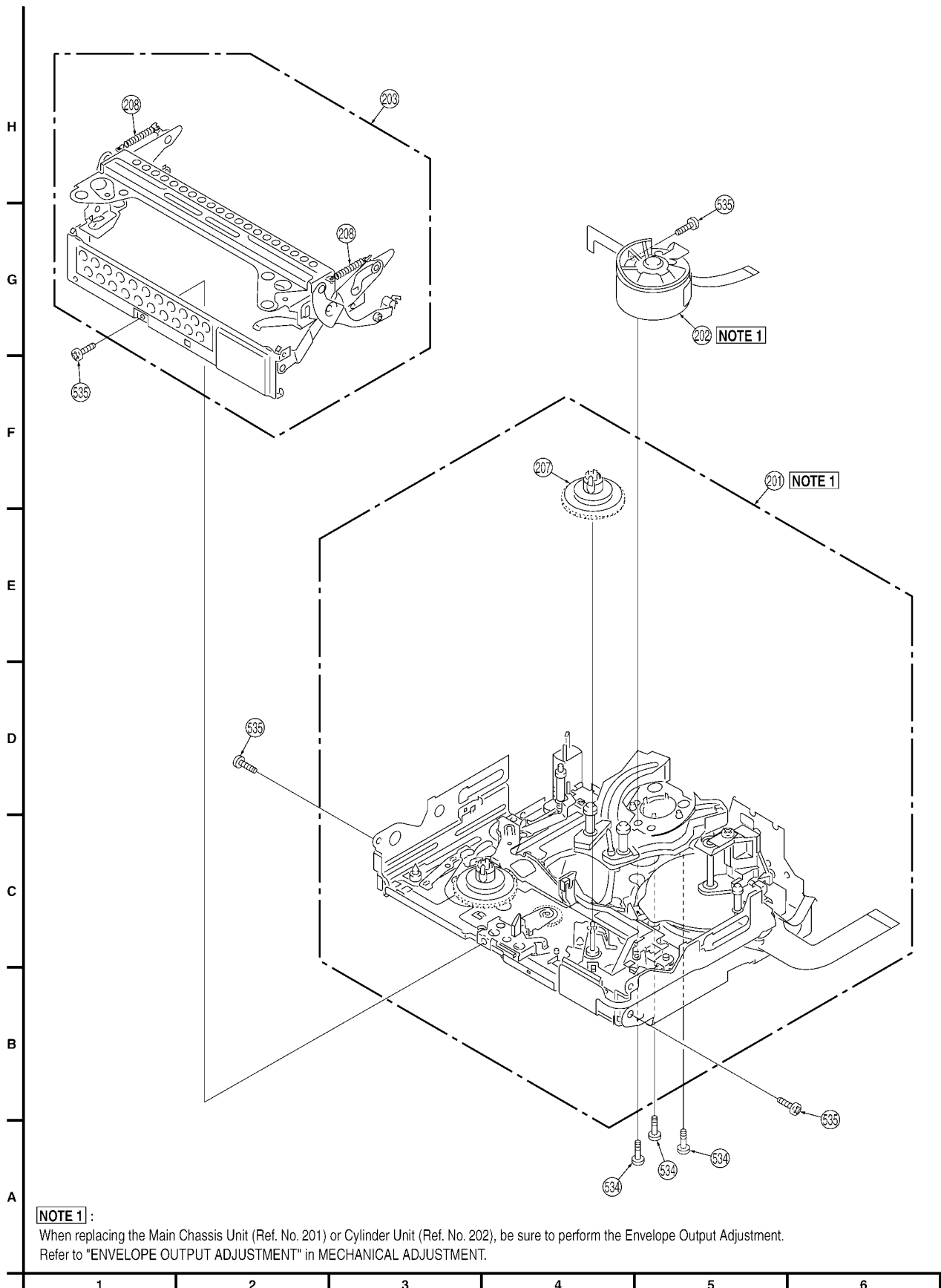

# 13.7. PACKING PARTS AND ACCESSORIES SECTION

## 7 PACKING PARTS AND ACCESSORIES SECTION

**IMPORTANT SAFTY NOTICE:**

COMPONENTS IDENTIFIED BY THE SIGN  HAVE SPECIAL CHARACTERISTICS IMPORTANT FOR SAFETY. WHEN REPLACING ANY OF THESE COMPONENTS, USE ONLY THE SPECIFIED PARTS.

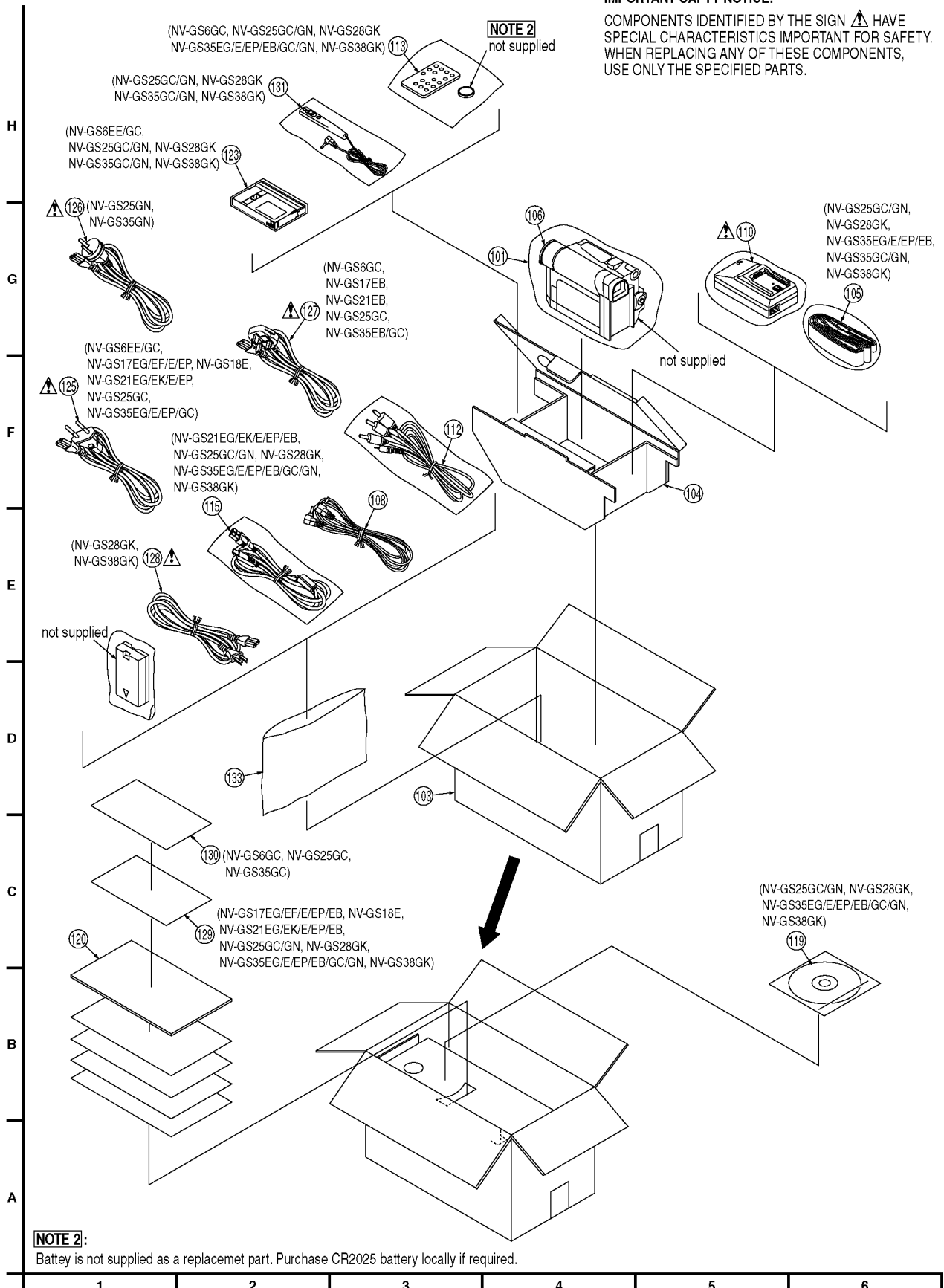

# 14 REPLACEMENT PARTS LISTS

## BEFORE REPLACING PARTS, READ THE FOLLOWING:

1. Use only original replacement parts:

To maintain original function and reliability of repaired units, use only original replacement parts which are listed with their part numbers in the parts list.

### 2. IMPORTANT SAFETY NOTICE

Components identified by the sign  have special characteristics important for safety. When replacing any of these components, use only the specified parts.

3. Definition of Parts supplier:

a. Parts with mark "SPC" in the Remarks column are supplied from Spare Parts Center of Panasonic AVC Company.

b. Parts without mark in the Remarks column are supplied from MKE.

4. Parts whose Ref. Nos. are the same are interchangeable as replacement parts. Any of these parts may be ordered and used as a replacement part.

5. Model Number Indication:

Model numbers are indicated in the Remarks column without "NV-GS."

6. Unless otherwise specified;

All resistors are in  $\Omega$ , K = 1,000  $\Omega$ , M = 1,000 k $\Omega$ .

7. Abbreviation

RTL: Retention Time Limited

This indicates that the retention time is limited for this item. After the discontinuation of this item in production, it will no longer be available.

NR: Non Repairable Board Ass'y

MGF CHIP: Metal Glaze Film Chip

C CHIP: Ceramic Chip

COMPLX CMP: Complex Component

W FLMPRF: Wirewound Flameproof

C.B.A.: Circuit Board Assembly

P.C.B.: Printed Circuit Board

E.S.D.: Electrostatically Sensitive Devices

CSP: Chip Size Package

8. AC Adaptor replacement note:

AC Adaptor used on these movie camera is VSK0651A or VSK0651B.

However, DE-974HA is supplied as a replacement part for VSK0651A. Also, DE-974GA is supplied for VSK0651B. This AC Adaptor is supplied only as a unit.

## 14.1. MECHANICAL REPLACEMENT PARTS LIST

### Definition of Parts supplier:

1. Parts with mark "SPC" in the Remarks column are supplied from Spare Parts Center of Panasonic AVC Company.

2. Parts without mark in the Remarks column are supplied from MKE.

### Notes:

Supply of CD-ROM, in accordance with license protection, is allowable as replacement parts only for customers who accidentally damaged or lost their own.

### MECHANICAL REPLACEMENT PARTS

Ref. No.	Part No.	Part Name & Description	Remarks
2	LSYK1499	CASSETTE COVER UNIT	6EE/GC, 17EG/EF /E/EP/E B,18E
2	LSYK1496	CASSETTE COVER UNIT	21EG/EK /E/EP/E B,35EG/ E/EP/EB /GC/GN, 38GK
2	LSYK1497	CASSETTE COVER UNIT	25GC/GN, 28GK
4	LSQL1827	POST COVER	
5	LSKF0608	EVR COVER	
6	LSHN0019	TRIPOD	
6	LSHN0020	TRIPOD	
7	LSMA0795	BOTTOM ANGLE	
8	LSKF0610	L COVER	
9	LSMF0371	MIC SHEET	
10	LSGF0535	LIGHT PROTECTOR	6EE/GC
10	LSGF0533	LIGHT PROTECTOR	17EG/EF /E/EP/E B,18E,2 5GC/GN, 28GK
10	LSGF0534	LIGHT PROTECTOR	21EG/EK /E/EP/E B,35EG/ E/EP/EB /GC/GN, 38GK
11	LSYK1504	REAR CASE UNIT	6EE/GC
11	LSYK1505	REAR CASE UNIT	17EG/EF /E/EP/E B,18E,2 1EG/EK/ E/EP/EB ,25GC/G N,28GK, 35EG/E/ EP/EB/G C/GN,38 GK
12	LSYK1506	EVF UNIT	RTL 6EE/GC, 17EG/EF /E/EP/E B,18E,2 1EG/EK/ E/EP/EB ,25GC/G N,28GK
12	LSYK1507	EVF UNIT	RTL 35EG/E/ EP/EB/G C/GN,38 GK

Ref. No.	Part No.	Part Name & Description	Remarks
13	LSKM1107	EVF BASE FRAME	
14	LSMA0721	EVF SPRING	
15	LSSC0759	EVF EARTH PLATE	
16	LSMD0799	EVF SLIDE PIECE	
17	LSJB8306	EVF FLEXIBLE PRINTED CIRCUIT	6EE/GC, 17EG/EF /E/EP/E B,18E,2 1EG/EK/E/EP/EB ,25GC/G N,28GK
17	LSJB8305	EVF FLEXIBLE PRINTED CIRCUIT	35EG/E/EP/EB/G C/GN, 38 GK
18	LSGQ0140	EYE CAP	
20	LSYK1532	EVF CASE 1 UNIT,ABS RESIN	6EE/GC, 17EG/EF /E/EP/E B,18E,2 1EG/EK/E/EP/EB ,25GC/G N,28GK
20	LSYK1533	EVF CASE 1 UNIT,ABS RESIN	35EG/E/EP/EB/G C/GN, 38 GK
21	LSKM1024	EVF CASE,ABS RESIN	
22	LSGT0068	EYE SIGHT LEVER	
23	LSYK1415	EVF LENS UNIT	
31	LSYK1501	SIDE CASE R UNIT,ABS RESIN	6EE/GC, 17EG/EF /E/EP/E B,18E
31	LSYK1502	SIDE CASE R UNIT,ABS RESIN	21EG/EK /E/EP/E B,25GC/GN,28GK ,35EG/E /EP/EB/ GC/GN,3 8GK
32	LSXY0763	SHAFT CASE UNIT,ABS RESIN	
33	LSYK1582	LCD CASE A UNIT,ABS RESIN	6EE/GC
33	LSYK1523	LCD CASE A UNIT,ABS RESIN	17EG/EF /E/EP/E B
33	LSYK1587	LCD CASE A UNIT,ABS RESIN	18E
33	LSYK1524	LCD CASE A UNIT,ABS RESIN	21EG/EK /E/EP/E B
33	LSYK1527	LCD CASE A UNIT,ABS RESIN	25GC/GN
33	LSYK1554	LCD CASE A UNIT,ABS RESIN	28GK
33	LSYK1526	LCD CASE A UNIT,ABS RESIN	35EG/E/EP/EB/G C/GN
33	LSYK1541	LCD CASE A UNIT,ABS RESIN	38GK
34	LSKM1086	LCD CASE B,ABS RESIN	
35	LSXY0765	LCD SHIELD CASE UNIT	
36	LSXY0766	PANEL HOLDER UNIT	
37	LSGL0422	LEAD LIGHT PANEL	
38	LSGL0404	DIFFUSION SHEET	
39	LSGL0423	REFLECT SHEET	
40	LSGL0406	BEF SHEET	
41	LSGL0421	BEF SHEET A	
42	L5BDDYH00014	LIQUID CRYSTAL DISPLAY PANEL	
51	LSKM1111	FRONT CASE,ABS RESIN	6EE/GC, 17EG/EF /E/EP/E B,18E,2 1EG/EK/E/EP/EB
51	LSKM1112	FRONT CASE,ABS RESIN	25GC/GN ,28GK,3 5EG/E/EP/EB/GC /GN,38G K
52	LSYK1584	TOP UNIT	6EE/GC

Ref. No.	Part No.	Part Name & Description	Remarks
52	LSYK1558	TOP UNIT	17EG/EF /E/EP/E B,18E,2 1EG/EK/E/EP/EB ,25GC/G N,28GK
52	LSYK1556	TOP UNIT	35EG/E/EP/EB/G C/GN, 38 GK
53	LSKF0609	FRONT JACK COVER	
54	LSMD0814	FRONT COVER HINGE	
55	LSMF0370	FRONT HINGE COVER PIECE	
56	LSFL0200	FOUR EYES LENS	21EG/EK /E/EP/E B,35EG/E/EP/EB /GC/GN, 38GK
57	LSGQ0138	LIGHT SHIELD SHEET	
58	LSMZ0397	MIC BOTH SIDE TAPE A	
59	LSMZ0398	MIC BOTH SIDE TAPE B	
60	LSQL1830	FRONT JACK LABEL	6EE/GC, 17EG/EF /E/EP/E B,18E,2 1EG/EK/E/EP/EB
60	LSQL1821	FRONT JACK LABEL	25GC/GN ,28GK,3 5GC/GN, 38GK
60	LSQL1816	FRONT JACK LABEL	35EG/E/EP/EB
61	LSXN0034	LENS UNIT	6EE/GC, 17EG/EF /E/EP/E B,18E,2 1EG/EK/E/EP/EB ,25GC/G N,28GK
61	LSXN0035	LENS UNIT	35EG/E/EP/EB/G C/GN, 38 GK
62	LSDW0058-K	FILTER HOLDER	6EE/GC, 17EG/EF /E/EP/E B,18E,2 1EG/EK/E/EP/EB ,25GC/G N,28GK
63	VDL1390-B	OPTICAL LOW PASS FILTER	
64	VMX3282	FILTER RUBBER	
65	L6HA66NB0001	ZOOM MOTOR UNIT	6EE/GC, 17EG/EF /E/EP/E B,18E,2 1EG/EK/E/EP/EB ,25GC/G N,28GK
65	L6HA66NB0003	ZOOM MOTOR UNIT	35EG/E/EP/EB/G C/GN, 38 GK
66	L6HA66NB0002	FOCUS MOTOR UNIT	6EE/GC, 17EG/EF /E/EP/E B,18E,2 1EG/EK/E/EP/EB ,25GC/G N,28GK
66	L6HA66NB0004	FOCUS MOTOR UNIT	35EG/E/EP/EB/G C/GN, 38 GK
71	LSKM1106	L-BOTTOM CASE,ABS RESIN	
72	LSGQ0139	HAND STRAP	
73	LSMA0793	STRAP ANGLE R	

Ref. No.	Part No.	Part Name & Description	Remarks
75	LSSC0757	L EARTH PLATE	
76	LSMA0794	STRAP ANGLE F	
77	LSGQ0149	STRAP SHAFT	
101	VPF1129	POLY BAG	
103	LSPG1980	PACKING CASE,PAPER	6EE
103	LSPG1981	PACKING CASE,PAPER	6GC
103	LSPG1914	PACKING CASE,PAPER	17EG/EF /E/EP/E B
103	LSPG1993	PACKING CASE,PAPER	18E
103	LSPG1908	PACKING CASE,PAPER	21EG/EK /E/EP/E B
103	LSPG1910	PACKING CASE,PAPER	25GC/GN
103	LSPG1912	PACKING CASE,PAPER	28GK
103	LSPG1899	PACKING CASE,PAPER	35EG/E/ EP/EB
103	LSPG1901	PACKING CASE,PAPER	35GC/GN
103	LSPG1903	PACKING CASE,PAPER	38GK
104	LSTG1302	DVC PACKING	
105	VFC3506-1A	SHOULDER STRAP	25GC/GN , 28GK, 3 5EG/E/E P/EB/GC /GN, 38G K
106	LSYF0552	LENS CAP UNIT	
108	K2GJ2DC00011	DC CABLE W/PLUG	
110	DE-974GA	AC ADAPTOR UNIT	△ 6EE/GC, 17EG/EF /E/EP/E B, 18E, 2 1EG/EK/ E/EP/EB , 25GC/G N, 35EG/ E/EP/EB /GC/GN
110	DE-974HA	AC ADAPTOR UNIT	△ 28GK, 38 GK
112	K2KC4CB00020	AUDIO VIDEO CABLE W/PLUG	
113	N2QAEC000012	INFRARED REMOTE CONTROL UNIT	6GC, 25G C/GN, 28 GK, 35EG /E/EP/E B/GC/GN , 38GK
115	K1HA05CD0010	USB CABLE W/PLUG	21EG/EK /E/EP/E B, 25GC/ GN, 28GK , 35EG/E /EP/EB/ GC/GN, 3 8GK
119	VFF0264-A	CD-ROM	25GC/GN , 28GK, 3 5EG/E/E P/EB/GC /GN, 38G K
120	LSQT0944-A	INSTRUCTION BOOK	6EE
120	LSQT0945-A	INSTRUCTION BOOK	6GC
120	LSQT0889-B	INSTRUCTION BOOK	17EG, 21 EG/EK, 3 5EG
120	LSQT0890-B	INSTRUCTION BOOK	17E, 21E , 35E
120	LSQT0958-B	INSTRUCTION BOOK	17EF
120	LSQT0910-A	INSTRUCTION BOOK	17EP, 21 EP, 35EP
120	LSQT0891-A	INSTRUCTION BOOK	17EB, 21 EB, 35EB
120	LSQT0955-A	INSTRUCTION BOOK	18E
120	LSQT0892-B	INSTRUCTION BOOK	25GC, 35 GC
120	LSQT0918-B	INSTRUCTION BOOK	25GC, 35 GC
120	LSQT0893-A	INSTRUCTION BOOK	25GN, 35 GN

Ref. No.	Part No.	Part Name & Description	Remarks
120	LSQT0894-A	INSTRUCTION BOOK	28GK, 38 GK
123	VFK1451	CLEANING CASSETTE	6EE/GC, 25GC/GN , 28GK, 3 5GC/GN, 38GK
125	K2CR2DA00004	AC CORD W/PLUG	△ 6EE/GC, 17EG/EF /E/EP, 1 8E, 21EG /EK/E/E P, 25GC, 35EG/E/ EP/GC
126	K2CJ2DA00011	AC CORD W/PLUG	△ 25GN, 35 GN
127	VJA0940	AC CORD W/PLUG	△ 6GC, 17E B, 21EB, 25GC, 35 EB/GC
128	K2CA2CA00020	AC CORD W/PLUG	△ 28GK, 38 GK
129	VQT0N39	INSTRUCTION BOOK FOR PC CONNECTION	17EG/EF , 21EG/E K, 35EG
129	VQT0N42	INSTRUCTION BOOK FOR PC CONNECTION	17E, 18E , 21E, 35 E
129	VQT0P90	INSTRUCTION BOOK FOR PC CONNECTION	17EP, 21 EP, 35EP
129	VQT0N44	INSTRUCTION BOOK FOR PC CONNECTION	17EB, 21 EB, 25GN , 35EB/G N
129	VQT0N48	INSTRUCTION BOOK FOR PC CONNECTION	25GC, 35 GC
129	VQT0P34	INSTRUCTION BOOK FOR PC CONNECTION	28GK, 38 GK
130	VQT0N49	INSTRUCTION BOOK FOR PC CONNECTION	6GC, 25G C, 35GC
131	N2QCAD000002	UNIVERSAL REMOTE CONTROLLER	25GC/GN , 28GK, 3 5GC/GN, 38GK
133	LSPF0107	POLY BAG	
201	VXA8014	MAIN CHASSIS UNIT	
202	VEG1663-M	CYLINDER UNIT	
203	VXA7932-1B	CASSETTE UP UNIT	SPC
207	VXR0403	T-REEL MOTOR	SPC
208	VMB3766	CASSETTE UP SPRING	SPC
413	LSHD0051	SCREW, STEEL	
419	XQN2+BJ5FN	TAPPING SCREW, STEEL	
433	XQN16+BJ6FN	SCREW, STEEL	
450	XQN16+B4FN	SCREW, STEEL	
455	XQN16+B3FN	SCREW, STEEL	
457	XQN2+B5FN	SCREW, STEEL	
524	XQN16+BJ4FNK	SCREW, STEEL	
533	XQN16+BJ4FN	SCREW, STEEL	
534	VHD1757	CYLINDER SET SCREW, STEEL	
535	XQN14+B2FN	SCREW, STEEL	
536	XQN16+AJ4FN	SCREW, STEEL	
538	XQN14+BJ4FN	SCREW, STEEL	
541	XQN16+B2FN	SCREW, STEEL	
542	LSHD0106	SPECIAL SCREW, STEEL	
543	XQN16+BJ4FJK	SCREW, STEEL	
701	LSEK0628	ELECTRIC CONDENSER MICROPHONE UNIT	
702	LSMG0136	MIC DAMPER	
703	LSJB8304	FRONT FLEXIBLE PRINTED CIRCUIT	
704	B3RAB0000024	INFRARED RECEIVER	6GC, 25G C/GN, 28 GK, 35EG /E/EP/E B/GC/GN , 38GK

Ref. No.	Part No.	Part Name & Description	Remarks
705	LSSC0753	FRONT EARTH PLATE A	
708	LSSC0754	MIC SHIELD CASE	
711	K1NA09E00063	SD UNIT	21EG/EK /E/EP/E B, 25GC/GN, 28GK, 35EG/E /EP/EB/GC/GN, 38GK
E10	LSEP8295U1	MAIN C.B.A.	RTL 6EE/GC
E10	LSEP8295P1	MAIN C.B.A.	RTL 17EG/EF /E/EP/E B, 18E, 21EG/E/E P/EB
E10	LSEP8295T1	MAIN C.B.A.	RTL 21EK
E10	LSEP8295Q1	MAIN C.B.A.	RTL 25GC/GN, 28GK
E10	LSEP8295R1	MAIN C.B.A.	RTL 35EG/E/EP/EB
E10	LSEP8295S1	MAIN C.B.A.	RTL 35GC/GN, 38GK
E20	LSEP8296A1	FRONT C.B.A.	RTL 6EE, 17EG/EF/E/EP/EB, 18E
E20	LSEP8296C1	FRONT C.B.A.	RTL 6GC, 25GC/GN, 28GK
E20	LSEP8296B1	FRONT C.B.A.	RTL 21EG/EK /E/EP/E B
E20	LSEP8296D1	FRONT C.B.A.	RTL 35EG/E/EP/EB/GC/GN, 38GK
E30	LSEP8297T1	JACK C.B.A.	RTL 6EE
E30	LSEP8297D1	JACK C.B.A.	RTL 6GC
E30	LSEP8297P1	JACK C.B.A.	RTL 17EG/EF /E/EP/E B, 18E
E30	LSEP8297Q1	JACK C.B.A.	RTL 21EG/EK /E/EP/E B
E30	LSEP8297R1	JACK C.B.A.	RTL 25GC/GN, 35EG/E /EP/EB/GC/GN
E30	LSEP8297S1	JACK C.B.A.	RTL 28GK, 38GK
E40	LSEP8298P1	LIQUID CRYSTAL DISPLAY BACKLIGHT C.B.A. NR	
E50	LSEQ0751	CCD C.B.A. NR	6EE/GC, 17EG/EF /E/EP/E B, 18E, 21EG/EK/E/EP/EB, 25GC/GN, 28GK
E50	LSEQ0753	CCD C.B.A. NR	35EG/E/EP/EB/GC/GN, 38GK

**SERVICE FIXTURES AND TOOLS**

Ref. No.	Part No.	Part Name & Description	Remarks
	VFM3110EDS	COLOR BAR STANDARD TAPE	SPC

Ref. No.	Part No.	Part Name & Description	Remarks
	VFK1451	DVC HEAD CLEANING TAPE	SPC
	LSVQ0028	PLIER FOR NON ZIF CONNECTOR	
	LSUQ0050	GREASE	
	LSUA0019	EXTENSION CABLE 8P	
	LSUA0016	EXTENSION CABLE 10P	
	VUVS0007	EXTENSION CABLE 12P	
	VFKW0124A	EXTENSION CABLE 14P	
	LSUA0017	EXTENSION CABLE 18P	
	VUVS0012	EXTENSION CABLE 22P	
	VFK1164LBX1	LIGHT BOX	SPC
	VFK1164TCM02	INFINITY LENS (WITH FOCUS CHART)	SPC
	VFK1164TAR58	ATTACHMENT RING (58mm)	SPC
	VFK1164TAR55	ATTACHMENT RING (55mm)	SPC
	VFK1164TAR52	ATTACHMENT RING (52mm)	SPC
	VFK1164TAR49	ATTACHMENT RING (49mm)	SPC
	VFK1164TAR46	ATTACHMENT RING (46mm)	SPC
	VFK1164TAR43	ATTACHMENT RING (43mm)	SPC
	VFK1164TAR37	ATTACHMENT RING (37mm)	SPC
	VFK1164TAR3A	ATTACHMENT RING (30.5mm)	SPC
	VFK1164TAR27	ATTACHMENT RING (27mm)	SPC
	VFK1164TFCT2	COLOR CONVERSION FILTER (C14)	SPC
	VFK1395	232C (M3) I/F CABLE	SPC
	VFK1899	POST HEIGHT ADJUSTMENT FIXTURE	SPC
	VJA0941	DC OUTPUT CABLE	SPC
	VFK1164TFWC2	WHITE CHART	SPC
	VFK1164TFCB2	COLOR BAR CHART	SPC
	VFK1164TFGS2	GRAY SCALE CHART	SPC
	VFK1308E	MEASURING BOARD FOR ELECTRICAL ADJUSTMENT	SPC
	VFK1898	CONNECTION ADAPTOR	SPC
	VFK1897	EVR CONNECTOR BOARD	SPC
	VFK1309	EVR CONNECTOR BOARD	SPC
	VFK1317	30PIN FLAT CABLE	SPC

**14.2. ELECTRICAL REPLACEMENT PARTS LIST**

Definition of Parts supplier:

1. All parts are supplied from MKE.

**PRINTED CIRCUIT BOARD ASSEMBLY**

Ref. No.	Part No.	Part Name & Description	Remarks
E10	LSEP8295U1	MAIN C.B.A.	E.S.D. RTL 6EE/GC
E10	LSEP8295P1	MAIN C.B.A.	E.S.D. RTL 17EG/EF /E/EP/E B, 18E, 21EG/E/E P/EB
E10	LSEP8295T1	MAIN C.B.A.	E.S.D. RTL 21EK
E10	LSEP8295Q1	MAIN C.B.A.	E.S.D. RTL 25GC/GN, 28GK
E10	LSEP8295R1	MAIN C.B.A.	E.S.D. RTL 35EG/E/EP/EB
E10	LSEP8295S1	MAIN C.B.A.	E.S.D. RTL 35GC/GN, 38GK
E20	LSEP8296A1	FRONT C.B.A.	RTL 6EE, 17EG/EF/E/EP/EB, 18E

Ref. No.	Part No.	Part Name & Description	Remarks
E20	LSEP8296C1	FRONT C.B.A.	RTL 6GC, 25G C/GN, 28 GK
E20	LSEP8296B1	FRONT C.B.A.	RTL 21EG/EK /E/EP/E B
E20	LSEP8296D1	FRONT C.B.A.	RTL 35EG/E/ EP/EB/G C/GN, 38 GK
E30	LSEP8297T1	JACK C.B.A.	RTL 6EE
E30	LSEP8297D1	JACK C.B.A.	RTL 6GC
E30	LSEP8297P1	JACK C.B.A.	RTL 17EG/EF /E/EP/E B, 18E
E30	LSEP8297Q1	JACK C.B.A.	RTL 21EG/EK /E/EP/E B
E30	LSEP8297R1	JACK C.B.A.	RTL 25GC/GN , 35EG/E /EP/EB/ GC/GN
E30	LSEP8297S1	JACK C.B.A.	RTL 28GK, 38 GK
E40	LSEP8298P1	LIQUID CRYSTAL DISPLAY BACKLIGHT C.B.A. NR	
E50	LSEQ0751	CCD C.B.A. NR	6EE/GC, 17EG/EF /E/EP/E B, 18E, 2 1EG/EK/ E/EP/EB , 25GC/G N, 28GK
E50	LSEQ0753	CCD C.B.A. NR	35EG/E/ EP/EB/G C/GN, 38 GK

### 14.2.1. MAIN C.B.A.

#### FPC CONNECTORS

Ref. No.	Part No.	Part Name & Description	Remarks
FP1	K1MN08BA0089	CONNECTOR 8P	
FP2	K1MN18BA0117	CONNECTOR 18P	
FP3	K1MN10BA0075	CONNECTOR 10P	
FP4	K1MN18BA0117	CONNECTOR 18P	
FP5	K1MN08BA0088	CONNECTOR 8P	
FP6	K1MN12A00075	CONNECTOR 12P	
FP7	K1MN06A00065	CONNECTOR 6P	
FP8	K1MN30AA0018	CONNECTOR 30P	
FP9	K1MN22A00065	CONNECTOR 22P	35EG/E/ EP/EB/G C/GN, 38 GK
FP10	K1MN22BA0063	CONNECTOR 22P	
FP11	K1MN16A00077	CONNECTOR 16P	6EE/GC, 17EG/EF /E/EP/E B, 18E, 2 1EG/EK/ E/EP/EB , 25GC/G N, 28GK
FP301	K1MN14A00088	CONNECTOR 14P	
FP701	K1MN22A00065	CONNECTOR 22P	

### 14.2.2. FRONT C.B.A.

#### INTEGRATED CIRCUITS

Ref. No.	Part No.	Part Name & Description	Remarks
IC4801	COABBB000262	IC, LINEAR	

Ref. No.	Part No.	Part Name & Description	Remarks
or IC4801	COABBB000105	IC, LINEAR	

#### TRANSISTORS

Ref. No.	Part No.	Part Name & Description	Remarks
Q4301	2SD1819ARL	TRANSISTOR SI NPN CHIP	21EG/EK /E/EP/E B, 35EG/ E/EP/EB /GC/GN, 38GK
Q4302	2SD1819ARL	TRANSISTOR SI NPN CHIP	21EG/EK /E/EP/E B, 35EG/ E/EP/EB /GC/GN, 38GK
Q4303	2SD1819ARL	TRANSISTOR SI NPN CHIP	21EG/EK /E/EP/E B, 35EG/ E/EP/EB /GC/GN, 38GK
Q4304	2SD1819ARL	TRANSISTOR SI NPN CHIP	21EG/EK /E/EP/E B, 35EG/ E/EP/EB /GC/GN, 38GK
Q4305	2SB1218ARL	TRANSISTOR SI PNP CHIP	21EG/EK /E/EP/E B, 35EG/ E/EP/EB /GC/GN, 38GK
Q4306	UNR9112J08	TRANSISTOR SI PNP CHIP	21EG/EK /E/EP/E B, 35EG/ E/EP/EB /GC/GN, 38GK
or Q4306	B1GDCFL0019	TRANSISTOR SI PNP CHIP	21EG/EK /E/EP/E B, 35EG/ E/EP/EB /GC/GN, 38GK
or Q4306	B1GDCFL0020	TRANSISTOR SI PNP CHIP	21EG/EK /E/EP/E B, 35EG/ E/EP/EB /GC/GN, 38GK
Q4307	UNR9213J08	TRANSISTOR SI NPN CHIP	21EG/EK /E/EP/E B, 35EG/ E/EP/EB /GC/GN, 38GK
or Q4307	B1GBCFNN0029	TRANSISTOR SI NPN CHIP	21EG/EK /E/EP/E B, 35EG/ E/EP/EB /GC/GN, 38GK
or Q4307	B1GBCFNN0030	TRANSISTOR SI NPN CHIP	21EG/EK /E/EP/E B, 35EG/ E/EP/EB /GC/GN, 38GK
Q4801	2SD2216J08	TRANSISTOR SI NPN CHIP	
or Q4801	B1ABCF000104	TRANSISTOR SI NPN CHIP	
Q6501	2SD10300SL	TRANSISTOR SI NPN CHIP	
Q6502	2SD2216J08	TRANSISTOR SI NPN CHIP	
or Q6502	B1ABCF000104	TRANSISTOR SI NPN CHIP	



DIODES

Ref. No.	Part No.	Part Name & Description	Remarks
D4301	B3AFB0000056	LIGHT EMITTING DIODE	21EG/EK /E/EP/E B, 35EG/E/EP/EB /GC/GN, 38GK
D4302	B3AFB0000056	LIGHT EMITTING DIODE	21EG/EK /E/EP/E B, 35EG/E/EP/EB /GC/GN, 38GK
D4303	B3AFB0000056	LIGHT EMITTING DIODE	21EG/EK /E/EP/E B, 35EG/E/EP/EB /GC/GN, 38GK
D4304	B3AFB0000056	LIGHT EMITTING DIODE	21EG/EK /E/EP/E B, 35EG/E/EP/EB /GC/GN, 38GK
D6503	MA3S132D0L	DIODE SI CHIP	
D6504	B3GA00000041	LIGHT EMITTING DIODE	

RESISTORS

Ref. No.	Part No.	Part Name & Description	Remarks
R4301	D0HB470ZA003	MGF CHIP 1/16W 47	21EG/EK /E/EP/E B, 35EG/E/EP/EB /GC/GN, 38GK
R4302	D0HB470ZA003	MGF CHIP 1/16W 47	21EG/EK /E/EP/E B, 35EG/E/EP/EB /GC/GN, 38GK
R4303	D0HB470ZA003	MGF CHIP 1/16W 47	21EG/EK /E/EP/E B, 35EG/E/EP/EB /GC/GN, 38GK
R4304	D0HB470ZA003	MGF CHIP 1/16W 47	21EG/EK /E/EP/E B, 35EG/E/EP/EB /GC/GN, 38GK
R4305	D0HB222ZA002	MGF CHIP 1/16W 2.2K	21EG/EK /E/EP/E B, 35EG/E/EP/EB /GC/GN, 38GK
R4306	D0HB333ZA002	MGF CHIP 1/16W 33K	21EG/EK /E/EP/E B, 35EG/E/EP/EB /GC/GN, 38GK
R4307	D0HB822ZA002	MGF CHIP 1/16W 8.2K	21EG/EK /E/EP/E B, 35EG/E/EP/EB /GC/GN, 38GK
R4802	ERJ3GEYJ472V	MGF CHIP 1/16W 4.7K	
R4803	ERJ3GEYJ223V	MGF CHIP 1/16W 22K	
R4804	ERJ3GEYJ333V	MGF CHIP 1/16W 33K	
R4805	ERJ3GEYJ124V	MGF CHIP 1/16W 120K	
R4806	ERJ3GEYJ333V	MGF CHIP 1/16W 33K	
R4807	D0HB392ZA002	MGF CHIP 1/16W 3.9K	
R4808	ERJ3GEYJ124V	MGF CHIP 1/16W 120K	
R4809	ERJ3GEYJ333V	MGF CHIP 1/16W 33K	
R4810	D0HB392ZA002	MGF CHIP 1/16W 3.9K	

Ref. No.	Part No.	Part Name & Description	Remarks
R6501	ERJ3GEYJ560V	MGF CHIP 1/16W 56	6GC, 25G C/GN, 28 GK, 35EG /E/EP/E B/GC/GN, 38GK
R6502	ERJ3GEYJ683V	MGF CHIP 1/16W 68K	6GC, 25G C/GN, 28 GK, 35EG /E/EP/E B/GC/GN, 38GK
R6503	ERJ3GEYJ104V	MGF CHIP 1/16W 100K	
R6504	ERJ3GEYJ106V	MGF CHIP 1/16W 10M	
R6505	ERJ3GEYJ225V	MGF CHIP 1/16W 2.2M	
R6506	ERJ3GEYJ334V	MGF CHIP 1/16W 330K	
R6507	ERJ3GEYJ182V	MGF CHIP 1/16W 1.8K	
R6508	ERJ3GEYJ472V	MGF CHIP 1/16W 4.7K	
R6509	ERJ3GEYJ102V	MGF CHIP 1/16W 1K	

CAPACITORS

Ref. No.	Part No.	Part Name & Description	Remarks
C4301	F1H1A105A025	C CHIP 10V 1UF	21EG/EK /E/EP/E B, 35EG/E/EP/EB /GC/GN, 38GK
C4801	F1H1A105A025	C CHIP 10V 1UF	
C4802	F1H1A105A025	C CHIP 10V 1UF	
C4803	F3F1C475A001	TANTALUM CHIP 16V 4.7UF	
C4804	ECJ1VB1H822K	C CHIP 50V 8200PF	
C4805	ECJ1VB1C273K	C CHIP 16V 0.027UF	
C4806	ECJ1VB1C273K	C CHIP 16V 0.027UF	
C4808	ECJ1VB1C273K	C CHIP 16V 0.027UF	
C4809	ECJ1VB1H822K	C CHIP 50V 8200PF	
C4810	ECJ1VB1C273K	C CHIP 16V 0.027UF	
C4812	F3F0J226A032	TANTALUM CHIP 6.3V 22UF	
C6501	F3F0J106A032	TANTALUM CHIP 6.3V 10UF	6GC, 25G C/GN, 28 GK, 35EG /E/EP/E B/GC/GN, 38GK
C6502	F1H1C104A008	C CHIP 16V 0.1UF	6GC, 25G C/GN, 28 GK, 35EG /E/EP/E B/GC/GN, 38GK
C6503	ECJ1VB0J474K	C CHIP 6.3V 0.47UF	
C6504	F1H1C104A041	C CHIP 16V 0.1UF	

FPC CONNECTORS

Ref. No.	Part No.	Part Name & Description	Remarks
FP6501	K1MN12A00075	CONNECTOR 12P	

MISCELLANEOUS

Ref. No.	Part No.	Part Name & Description	Remarks
701	LSEK0628	ELECTRIC CONDENSER MICROPHONE UNIT	
702	LSMG0136	MIC DAMPER	
703	LSJB8304	FRONT FLEXIBLE PRINTED CIRCUIT	
704	B3RAB0000024	INFRARED RECEIVER	6GC, 25G C/GN, 28 GK, 35EG /E/EP/E B/GC/GN, 38GK
705	LSSC0753	FRONT EARTH PLATE A	
708	LSSC0754	MIC SHIELD CASE	

### 14.2.3. JACK C.B.A.

#### TRANSISTORS

Ref. No.	Part No.	Part Name & Description	Remarks
Q4001	2SD2216J08	TRANSISTOR SI NPN CHIP	25GC/GN, 28GK, 35EG/E/E P/EB/GC /GN, 38GK
or Q4001	B1ABCF000104	TRANSISTOR SI NPN CHIP	25GC/GN, 28GK, 35EG/E/E P/EB/GC /GN, 38GK
Q4002	2SB1462J08	TRANSISTOR SI PNP CHIP	25GC/GN, 28GK, 35EG/E/E P/EB/GC /GN, 38GK
or Q4002	B1ADCF000072	TRANSISTOR SI PNP CHIP	25GC/GN, 28GK, 35EG/E/E P/EB/GC /GN, 38GK
Q4003	2SD2216J08	TRANSISTOR SI NPN CHIP	25GC/GN, 28GK, 35EG/E/E P/EB/GC /GN, 38GK
or Q4003	B1ABCF000104	TRANSISTOR SI NPN CHIP	25GC/GN, 28GK, 35EG/E/E P/EB/GC /GN, 38GK
Q4004	2SB1462J08	TRANSISTOR SI PNP CHIP	25GC/GN, 28GK, 35EG/E/E P/EB/GC /GN, 38GK
or Q4004	B1ADCF000072	TRANSISTOR SI PNP CHIP	25GC/GN, 28GK, 35EG/E/E P/EB/GC /GN, 38GK
Q4005	2SD2216J08	TRANSISTOR SI NPN CHIP	25GC/GN, 28GK, 35EG/E/E P/EB/GC /GN, 38GK
or Q4005	B1ABCF000104	TRANSISTOR SI NPN CHIP	25GC/GN, 28GK, 35EG/E/E P/EB/GC /GN, 38GK

#### DIODES

Ref. No.	Part No.	Part Name & Description	Remarks
D4001	B0BC6R200019	DIODE ZENER CHIP 6.2V	25GC/GN, 28GK, 35EG/E/E P/EB/GC /GN, 38GK
D7001	D4ED1120A005	SURGE ABSORBER	25GC/GN, 28GK, 35EG/E/E P/EB/GC /GN, 38GK

Ref. No.	Part No.	Part Name & Description	Remarks
D7008	MAZM068H0L	DIODE ZENER CHIP 6.8V	17EG/EF /E/EP/E B, 18E, 21EG/EK/ E/EP/EB, 25GC/GN, 28GK, 35EG/E/EP/EB/GC /GN, 38GK

#### RESISTORS

Ref. No.	Part No.	Part Name & Description	Remarks
R4001	ERJ3GEYJ222V	MGF CHIP 1/16W 2.2K +-5%	25GC/GN, 28GK, 35EG/E/E P/EB/GC /GN, 38GK
R4002	ERJ3GEYJ562V	MGF CHIP 1/16W 5.6K +-5%	25GC/GN, 28GK, 35EG/E/E P/EB/GC /GN, 38GK
R4003	ERJ3GEYJ151V	MGF CHIP 1/16W 150 +-5%	25GC/GN, 28GK, 35EG/E/E P/EB/GC /GN, 38GK
R4004	ERJ3GEYJ122V	MGF CHIP 1/16W 1.2K +-5%	25GC/GN, 28GK, 35EG/E/E P/EB/GC /GN, 38GK
R4005	ERJ3GEYJ103V	MGF CHIP 1/16W 10K	25GC/GN, 28GK, 35EG/E/E P/EB/GC /GN, 38GK
R4006	D0HB154ZA002	MGF CHIP 150K	25GC/GN, 28GK, 35EG/E/E P/EB/GC /GN, 38GK
R4007	D0HB563ZA002	MGF CHIP 1/16W 56K	25GC/GN, 28GK, 35EG/E/E P/EB/GC /GN, 38GK
R4008	ERJ3GEYJ471V	MGF CHIP 1/16W 470	25GC/GN, 28GK, 35EG/E/E P/EB/GC /GN, 38GK
R4009	ERJ3GEYJ562V	MGF CHIP 1/16W 5.6K +-5%	25GC/GN, 28GK, 35EG/E/E P/EB/GC /GN, 38GK
R4010	ERJ3GEYJ151V	MGF CHIP 1/16W 150 +-5%	25GC/GN, 28GK, 35EG/E/E P/EB/GC /GN, 38GK
R4011	ERJ3GEYJ122V	MGF CHIP 1/16W 1.2K +-5%	25GC/GN, 28GK, 35EG/E/E P/EB/GC /GN, 38GK
R4012	ERJ3GEYJ103V	MGF CHIP 1/16W 10K	25GC/GN, 28GK, 35EG/E/E P/EB/GC /GN, 38GK

Ref. No.	Part No.	Part Name & Description	Remarks
R4013	DOHB154ZA002	MGF CHIP 150K	25GC/GN, 28GK, 35EG/E/EP/EB/GC/GN, 38GK
R4014	DOHB563ZA002	MGF CHIP 1/16W 56K	25GC/GN, 28GK, 35EG/E/EP/EB/GC/GN, 38GK
R4015	ERJ3GEYJ471V	MGF CHIP 1/16W 470	25GC/GN, 28GK, 35EG/E/EP/EB/GC/GN, 38GK
R4016	ERJ3GEYOR00V	MGF CHIP 1/16W 0	25GC/GN, 28GK, 35EG/E/EP/EB/GC/GN, 38GK
R4017	ERJ3GEYJ102V	MGF CHIP 1/16W 1K	25GC/GN, 28GK, 35EG/E/EP/EB/GC/GN, 38GK
R6301	ERJ3GEYJ220V	MGF CHIP 1/16W 22 +-5%	21EG/EK/E/EP/EB, 25GC/GN, 28GK, 35EG/E/EP/EB/GC/GN, 38GK
R6302	ERJ3GEYJ220V	MGF CHIP 1/16W 22 +-5%	21EG/EK/E/EP/EB, 25GC/GN, 28GK, 35EG/E/EP/EB/GC/GN, 38GK
R6303	ERJ3GEYJ220V	MGF CHIP 1/16W 22 +-5%	21EG/EK/E/EP/EB, 25GC/GN, 28GK, 35EG/E/EP/EB/GC/GN, 38GK
R6304	ERJ3GEYJ220V	MGF CHIP 1/16W 22 +-5%	21EG/EK/E/EP/EB, 25GC/GN, 28GK, 35EG/E/EP/EB/GC/GN, 38GK
R6305	ERJ3GEYJ220V	MGF CHIP 1/16W 22 +-5%	21EG/EK/E/EP/EB, 25GC/GN, 28GK, 35EG/E/EP/EB/GC/GN, 38GK
R6306	ERJ3GEYJ472V	MGF CHIP 1/16W 4.7K	21EG/EK/E/EP/EB, 25GC/GN, 28GK, 35EG/E/EP/EB/GC/GN, 38GK
R6307	ERJ3GEYJ472V	MGF CHIP 1/16W 4.7K	21EG/EK/E/EP/EB, 25GC/GN, 28GK, 35EG/E/EP/EB/GC/GN, 38GK

Ref. No.	Part No.	Part Name & Description	Remarks
R6308	ERJ3GEYJ472V	MGF CHIP 1/16W 4.7K	21EG/EK/E/EP/EB, 25GC/GN, 28GK, 35EG/E/EP/EB/GC/GN, 38GK
R6309	ERJ3GEYJ472V	MGF CHIP 1/16W 4.7K	21EG/EK/E/EP/EB, 25GC/GN, 28GK, 35EG/E/EP/EB/GC/GN, 38GK
R6310	ERJ3GEYJ472V	MGF CHIP 1/16W 4.7K	21EG/EK/E/EP/EB, 25GC/GN, 28GK, 35EG/E/EP/EB/GC/GN, 38GK
R6311	ERJ3GEYJ220V	MGF CHIP 1/16W 22 +-5%	21EG/EK/E/EP/EB, 25GC/GN, 28GK, 35EG/E/EP/EB/GC/GN, 38GK
R6312	ERJ3GEYJ220V	MGF CHIP 1/16W 22 +-5%	21EG/EK/E/EP/EB, 25GC/GN, 28GK, 35EG/E/EP/EB/GC/GN, 38GK
R6313	ERJ3GEYJ220V	MGF CHIP 1/16W 22 +-5%	21EG/EK/E/EP/EB, 25GC/GN, 28GK, 35EG/E/EP/EB/GC/GN, 38GK
R6314	ERJ3GEYJ220V	MGF CHIP 1/16W 22 +-5%	21EG/EK/E/EP/EB, 25GC/GN, 28GK, 35EG/E/EP/EB/GC/GN, 38GK
R6315	ERJ3GEYJ220V	MGF CHIP 1/16W 22 +-5%	21EG/EK/E/EP/EB, 25GC/GN, 28GK, 35EG/E/EP/EB/GC/GN, 38GK
R6316	ERJ3GEYJ101V	MGF CHIP 1/16W 100 +-5%	21EG/EK/E/EP/EB, 25GC/GN, 28GK, 35EG/E/EP/EB/GC/GN, 38GK
R7001	ERJ3GEYJ562V	MGF CHIP 1/16W 5.6K +-5%	6EE, 17EG/EP/EB, 18E
R7001	ERJ3GEYJ103V	MGF CHIP 1/16W 10K	21EG/EK/E/EP/EB
R7001	ERJ3GEYJ183V	MGF CHIP 1/16W 18K	25GC/GN, 35EG/E/EP/EB/GC/GN
R7001	ERJ3GEYJ473V	MGF CHIP 1/16W 47K	28GK, 38GK

Ref. No.	Part No.	Part Name & Description	Remarks
R7002	ERJ3GEYJ331V	MGF CHIP 1/16W 330 +-5%	17EG/EF /E/EP/E B,18E,2 1EG/EK/ E/EP/EB ,25GC/G N,28GK, 35EG/E/ EP/EB/G C/GN,38 GK
R7004	ERJ3GEY0R00V	MGF CHIP 1/16W 0	6EE/GC, 17EG/EF /E/EP/E B,18E,2 1EG/EK/ E/EP/EB
R7005	ERJ3GEY0R00V	MGF CHIP 1/16W 0	6EE/GC, 17EG/EF /E/EP/E B,18E,2 1EG/EK/ E/EP/EB
R7006	ERJ3GEYJ122V	MGF CHIP 1/16W 1.2K +-5%	
R7007	ERJ3GEY0R00V	MGF CHIP 1/16W 0	6EE/GC, 17EG/EF /E/EP/E B,18E,2 1EG/EK/ E/EP/EB

CAPACITORS

Ref. No.	Part No.	Part Name & Description	Remarks
C4001	ECJ1VB1H103K	C CHIP 50V 0.01UF	25GC/GN ,28GK,3 5EG/E/E P/EB/GC /GN,38G K
C4002	F3F0J226A032	TANTALUM CHIP 6.3V 22UF	25GC/GN ,28GK,3 5EG/E/E P/EB/GC /GN,38G K
C4003	F1H1A105A025	C CHIP 10V 1UF	25GC/GN ,28GK,3 5EG/E/E P/EB/GC /GN,38G K
C4004	F3F0G226A030	TANTALUM CHIP 4V 220UF	25GC/GN ,28GK,3 5EG/E/E P/EB/GC /GN,38G K
C4006	F1H1A105A025	C CHIP 10V 1UF	25GC/GN ,28GK,3 5EG/E/E P/EB/GC /GN,38G K
C4007	F1H1H332A219	C CHIP 50V 3300PF	25GC/GN ,28GK,3 5EG/E/E P/EB/GC /GN,38G K
C4008	F1H1A105A025	C CHIP 10V 1UF	25GC/GN ,28GK,3 5EG/E/E P/EB/GC /GN,38G K
C4009	F3F0G226A030	TANTALUM CHIP 4V 220UF	25GC/GN ,28GK,3 5EG/E/E P/EB/GC /GN,38G K

Ref. No.	Part No.	Part Name & Description	Remarks
C4011	F1H1A105A025	C CHIP 10V 1UF	25GC/GN ,28GK,3 5EG/E/E P/EB/GC /GN,38G K
C4012	F1H1H332A219	C CHIP 50V 3300PF	25GC/GN ,28GK,3 5EG/E/E P/EB/GC /GN,38G K
C6301	F3F0J226A032	TANTALUM CHIP 6.3V 22UF	21EG/EK /E/EP/E B,25GC/ GN,28GK ,35EG/E /EP/EB/ GC/GN,3 8GK
C6302	F1H1C104A041	C CHIP 16V 0.1UF	21EG/EK /E/EP/E B,25GC/ GN,28GK ,35EG/E /EP/EB/ GC/GN,3 8GK
C6303	F1H1C104A041	C CHIP 16V 0.1UF	21EG/EK /E/EP/E B,25GC/ GN,28GK ,35EG/E /EP/EB/ GC/GN,3 8GK
C6304	ECJ1VC1H050C	C CHIP 50V 5PF	21EG/EK /E/EP/E B,25GC/ GN,28GK ,35EG/E /EP/EB/ GC/GN,3 8GK
C6305	ECJ1VC1H050C	C CHIP 50V 5PF	21EG/EK /E/EP/E B,25GC/ GN,28GK ,35EG/E /EP/EB/ GC/GN,3 8GK
C6306	ECJ1VC1H050C	C CHIP 50V 5PF	21EG/EK /E/EP/E B,25GC/ GN,28GK ,35EG/E /EP/EB/ GC/GN,3 8GK
C6307	ECJ1VC1H050C	C CHIP 50V 5PF	21EG/EK /E/EP/E B,25GC/ GN,28GK ,35EG/E /EP/EB/ GC/GN,3 8GK
C6308	ECJ1VC1H050C	C CHIP 50V 5PF	21EG/EK /E/EP/E B,25GC/ GN,28GK ,35EG/E /EP/EB/ GC/GN,3 8GK
C7001	F1H1H472A219	C CHIP 50V 4700PF	
C7002	F1H1H472A219	C CHIP 50V 4700PF	
C7005	F1H1A105A025	C CHIP 10V 1UF	

**FILTERS**

Ref. No.	Part No.	Part Name & Description	Remarks
FL7001	J0MAB0000116	COIL OTHER FILTERS FOR EM	25GC/GN, 28GK, 35EG/E/E P/EB/GC/GN, 38GK
FL7002	J0MAB0000116	COIL OTHER FILTERS FOR EM	
FL7003	J0MAB0000116	COIL OTHER FILTERS FOR EM	

**COILS**

Ref. No.	Part No.	Part Name & Description	Remarks
L4001	J0JBC0000036	FERRITE CORE	25GC/GN, 28GK, 35EG/E/E P/EB/GC/GN, 38GK
L4002	J0JBC0000036	FERRITE CORE	25GC/GN, 28GK, 35EG/E/E P/EB/GC/GN, 38GK
L6301	G1C100M00010	COIL CHIP 10UH	21EG/EK/E/EP/EB, 25GC/GN, 28GK, 35EG/E/EP/EB/GC/GN, 38GK
L6302	ERJ3GEY0R00X	MGF CHIP 1/16W 0	21EG/EK/E/EP/EB, 25GC/GN, 28GK, 35EG/E/EP/EB/GC/GN, 38GK
L7001	J0JBC0000027	FERRITE BEAD CHIP	
L7002	J0JBC0000027	FERRITE BEAD CHIP	
L7003	J0JBC0000027	FERRITE BEAD CHIP	
L7004	J0JBC0000027	FERRITE BEAD CHIP	25GC/GN, 28GK, 35EG/E/E P/EB/GC/GN, 38GK
L7008	J0JBC0000027	FERRITE BEAD CHIP	17EG/EF/E/EP/EB, 18E, 21EG/EK/E/EP/EB, 25GC/GN, 28GK, 35EG/E/EP/EB/GC/GN, 38GK
L7009	J0JBC0000027	FERRITE BEAD CHIP	17EG/EF/E/EP/EB, 18E, 21EG/EK/E/EP/EB, 25GC/GN, 28GK, 35EG/E/EP/EB/GC/GN, 38GK

**PIN HEADERS**

Ref. No.	Part No.	Part Name & Description	Remarks
B7001	K1KB40AA0021	BOARD TO BOARD 40P	

**SWITCHES**

Ref. No.	Part No.	Part Name & Description	Remarks
SW7001	ESE22MH22	SWITCH	

**JACKS**

Ref. No.	Part No.	Part Name & Description	Remarks
JK4001	K2HC104E0009	MIC JACK SOCKET	25GC/GN, 28GK, 35EG/E/E P/EB/GC/GN, 38GK
JK7001	K2HC107B0004	A/V JACK SOCKET	6EE, 17EG/EF/E/EP/EB, 18E, 21EG/EK/E/EP/EB, 25GC/GN, 35EG/E/E P/EB/GC/GN
JK7001	K2HC107B0003	A/V JACK SOCKET	6GC, 28GK, 38GK
JK7002	K2YZ04000021	MINI DV JACK SOCKET	
JK7003	K2HZ105E0009	USB MINI JACK SOCKET	
JK7004	K2YZ06000022	S-VIDEO JACK SOCKET	17EG/EF/E/EP/EB, 18E, 21EG/EK/E/EP/EB, 25GC/GN, 28GK, 35EG/E/EP/EB/GC/GN, 38GK

**BATTERY**

Ref. No.	Part No.	Part Name & Description	Remarks
BT7001	ML-621S/F9DE	BATTERY	

**MISCELLANEOUS**

Ref. No.	Part No.	Part Name & Description	Remarks
711	K1NA09E00063	SD UNIT	21EG/EK/E/EP/EB, 25GC/GN, 28GK, 35EG/E/EP/EB/GC/GN, 38GK

**14.2.4. LIQUID CRYSTAL DISPLAY BACKLIGHT C.B.A. NR**

**TRANSISTORS**

Ref. No.	Part No.	Part Name & Description	Remarks
Q8101	2SD1819ARL	TRANSISTOR SI NPN CHIP	
Q8102	2SD1819ARL	TRANSISTOR SI NPN CHIP	
Q8103	2SD1819ARL	TRANSISTOR SI NPN CHIP	
Q8104	2SD1819ARL	TRANSISTOR SI NPN CHIP	
Q8105	XP0450100L	TRANSISTOR COMPLX CMP SI NPN CHIP	
Q8106	XP0440100L	TRANSISTOR COMPLX CMP SI PNP CHIP	

**DIODES**

Ref. No.	Part No.	Part Name & Description	Remarks
D8101	LSEP8298P1	LIQUID CRYSTAL DISPLAY BACKLIGHT C.B.A.	
D8103	LSEP8298P1	LIQUID CRYSTAL DISPLAY BACKLIGHT C.B.A.	
D8105	LSEP8298P1	LIQUID CRYSTAL DISPLAY BACKLIGHT C.B.A.	
D8107	LSEP8298P1	LIQUID CRYSTAL DISPLAY BACKLIGHT C.B.A.	
D8109	MA2S728008	DIODE SI CHIP	
or D8109	B0JCDD000002	DIODE SI CHIP	
or D8109	MA2S72800L	DIODE SI CHIP	
D8110	MA2S728008	DIODE SI CHIP	

Ref. No.	Part No.	Part Name & Description	Remarks
or D8110	B0JCDD000002	DIODE SI CHIP	
or D8110	MA2S72800L	DIODE SI CHIP	

RESISTORS

Ref. No.	Part No.	Part Name & Description	Remarks
R8101	ERJ3GEY0R00V	MGF CHIP 1/16W 0	
R8102	ERJ3GEY0R00V	MGF CHIP 1/16W 0	
R8103	ERJ3GEY0R00V	MGF CHIP 1/16W 0	
R8104	ERJ3GEY0R00V	MGF CHIP 1/16W 0	
R8105	ERJ3GEY0R00V	MGF CHIP 1/16W 0	
R8106	ERJ3GEY0R00V	MGF CHIP 1/16W 0	
R8107	ERJ3GEY0R00V	MGF CHIP 1/16W 0	
R8108	D0HB470ZA003	MGF CHIP 1/16W 47	
R8109	D0HB470ZA003	MGF CHIP 1/16W 47	
R8110	D0HB470ZA003	MGF CHIP 1/16W 47	
R8111	D0HB470ZA003	MGF CHIP 1/16W 47	
R8112	ERJ3GEYJ103V	MGF CHIP 1/16W 10K	
R8113	ERJ3GEYJ103V	MGF CHIP 1/16W 10K	
R8114	ERA3YKD104V	MGF CHIP 1/16W 100K	
R8115	ERA3YED123V	MGF CHIP 1/16W 12K	
R8116	ERA3YKD184V	MGF CHIP 1/16W 180K	
R8117	ERJ3GEYJ393V	MGF CHIP 1/16W 39K	
R8118	ERJ3GEYJ393V	MGF CHIP 1/16W 39K	
R8119	ERJ3GEYJ153V	MGF CHIP 1/16W 15K	
R8120	ERJ3GEYJ113V	MGF CHIP 1/16W 11K	

CAPACITORS

Ref. No.	Part No.	Part Name & Description	Remarks
C8101	ECJ1VC1H471J	C CHIP 50V 470PF	
C8102	ECJ1VC1H471J	C CHIP 50V 470PF	
C8103	ECJ1VC1H471J	C CHIP 50V 470PF	
C8104	ECJ2YF1C225Z	C CHIP 16V 2.2UF	
C8105	ECJ2YF1C225Z	C CHIP 16V 2.2UF	
C8106	F1H1C104A041	C CHIP 16V 0.1UF	
C8107	ECJ3YB1C475K	C CHIP 16V 4.7UF	
C8108	F1J1C1050011	C CHIP 16V 1UF	
C8109	F1J1C1050011	C CHIP 16V 1UF	
C8110	F1J1C1050011	C CHIP 16V 1UF	

COILS

Ref. No.	Part No.	Part Name & Description	Remarks
L8101	G1C100M00010	COIL CHIP 10UH	
L8102	G1C100M00010	COIL CHIP 10UH	
L8103	G1C100M00010	COIL CHIP 10UH	
L8104	G1C100M00010	COIL CHIP 10UH	

FPC CONNECTORS

Ref. No.	Part No.	Part Name & Description	Remarks
FP8101	K1MN26BA0059	CONNECTOR 26P	
FP8102	K1MN24BA0059	CONNECTOR 24P	