

**NAD**

**SERVICE  
MANUAL**

**MONITOR SERIES**

**4300**  
**STEREO TUNER**

# NAD 4300 SERVICE MANUAL

NOTE: This manual covers all versions.

A: U.S.A.

A1: Canada

B: U.K.

B1: Australia

C: EUROPE and others

C1: W-Germany

TABLE OF CONTENTS	PAGE
LOCATION MAP	2
SPECIFICATION	3
INTERNAL VIEW	4
SUGGESTED INSTRUMENTATION HOOKUP	5
FM ALIGNMENTS	6-9
AM ALIGNMENTS	10-11
WIRING DIAGRAM	12-13
P.C.B. LAYOUT DIAGRAM	14-15
SCHEMATIC DIAGRAM	16-17
EXPLODED VIEW PARTS LIST	18-19
EXPLODED VIEW	20
ELECTRICAL PARTS LIST	21-23

**REAR PANEL**

- 1. AM Rod Antenna.
- 2. AM Antenna Terminals.
- 3. FM Antenna Input.
- 4. Output Level Control.
- 5. Output Jacks.
- 6. AC Convenience Outlet (not in U.K. model).
- 7. AC Line Cord.

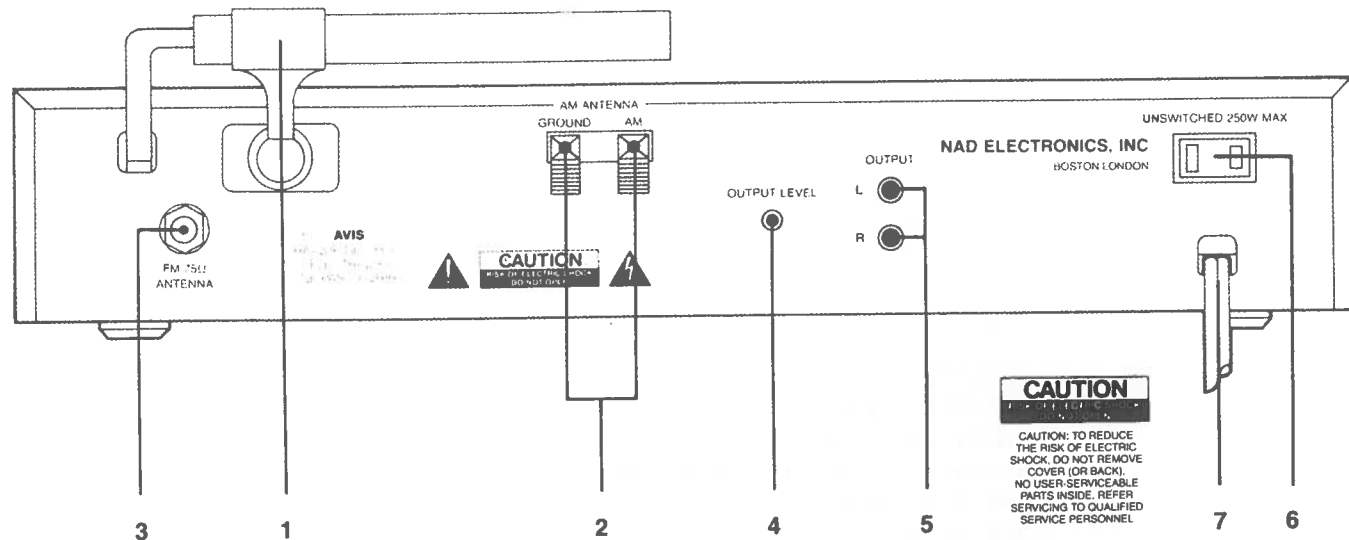

**FRONT PANEL**

- 1. Power.
- 2. Station Pre-sets.
- 3. Memory Enter.
- 4. Tuning Display.
- 5. FM Stereo Indicator.
- 6. IF Narrow Indicator.
- 7. AM/FM.
- 8. IF Narrow.
- 9. FM NR Off.
- 10. Mono.
- 11. Tuning.

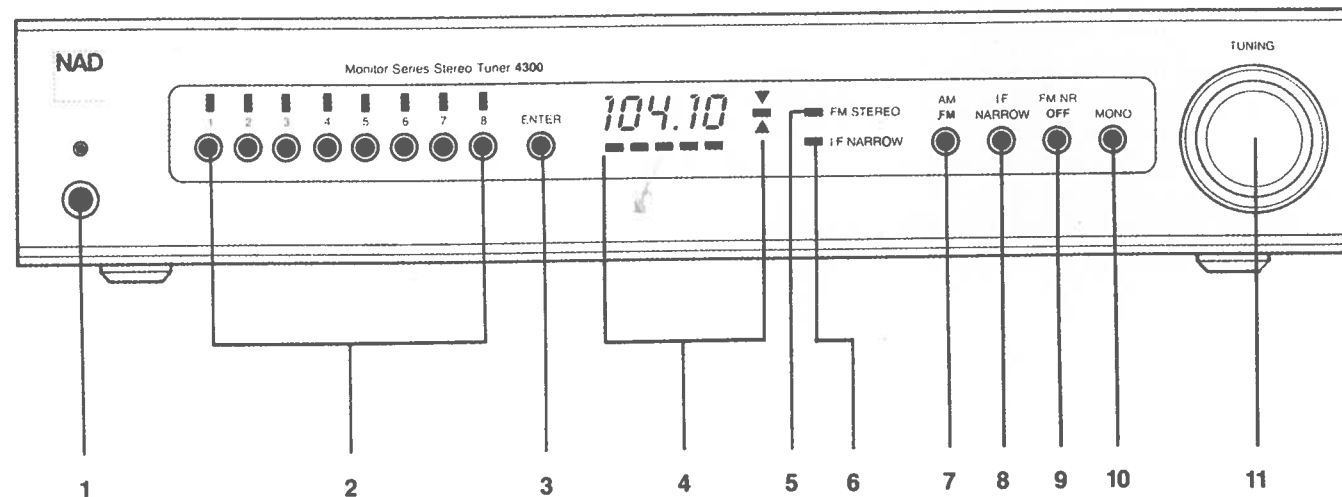

**SPECIFICATIONS**

FM Tuner Section

Input sensitivity (300 Ω)	Mono, -30 dB THD + N:	All versions except USA. 50 μsec. de-emphasis	USA version only.
	Mono, 50 dB S/N:	0.83 μV	75 μsec.
	Stereo, 50 dB S/N:	1.3 μV	0.8 μV
	Mono, 60 dB S/N:	14.5 μV	1.0 μV
	Stereo, 60 dB S/N:	3.2 μV	13 μV
		48 μV	2.5 μV
			42 μV
Capture ratio at 25, 45 & 65 dBf.		< 2.1 dB.	< 2.1 dB.
AM rejection.		> 70 dB.	> 70 dB.
Selectivity	Alternate channel:	76 dB.	76 dB.
	Adjacent channel:	8 dB.	8 dB.
Image rejection.		110 dB.	110 dB.
R. F. intermodulation.		73 dB.	73 dB.
I. F. rejection.		102 dB.	102 dB.
SCA rejection.		80 dB.	80 dB.
Pilot suppression (19 + 38 kHz).		69 dB.	72 dB.
THD at 100 % modulation,		1 kHz	100 Hz - 6 kHz
	Mono:	0.08 %	0.15 %
	Stereo:	0.07 %	0.35 %
		1 kHz	100 Hz - 6 kHz
	Mono:	0.07 %	0.15 %
	Stereo:	0.05 %	0.35 %
S/N ratio, A-weighted, 65 dBf.		Mono: 84 dB.	85 dB.
		Stereo: 77 dB.	78 dB.
Frequency response, 15 - 15 kHz.		± 0.5 dB.	± 0.5 dB.
Stereo separation (FM NR off),		1 kHz: 50 dB.	50 dB.
		30 Hz - 15 kHz: 35 dB.	35 dB.

AM Tuner Section

Usable sensitivity.	250 μV/meter.	250 μV/meter.
Selectivity.	55 dB. at ± 9 kHz	60 dB. at ± 10 kHz
Image rejection.	45 dB.	45 dB.

Physical Specifications

Dimensions (width x height x depth)	43.5 x 8.7 x 29.3 cm.
	17.1 x 3.4 x 11.5 in.
Net weight	4.55 Kg./10 lb.
Shipping weight	5.75 Kg./12 lb. 10 oz.
Power requirements	50/60 Hz at 110, 120, 220 or 240 VAC. 24 W.

# INTERNAL VIEW

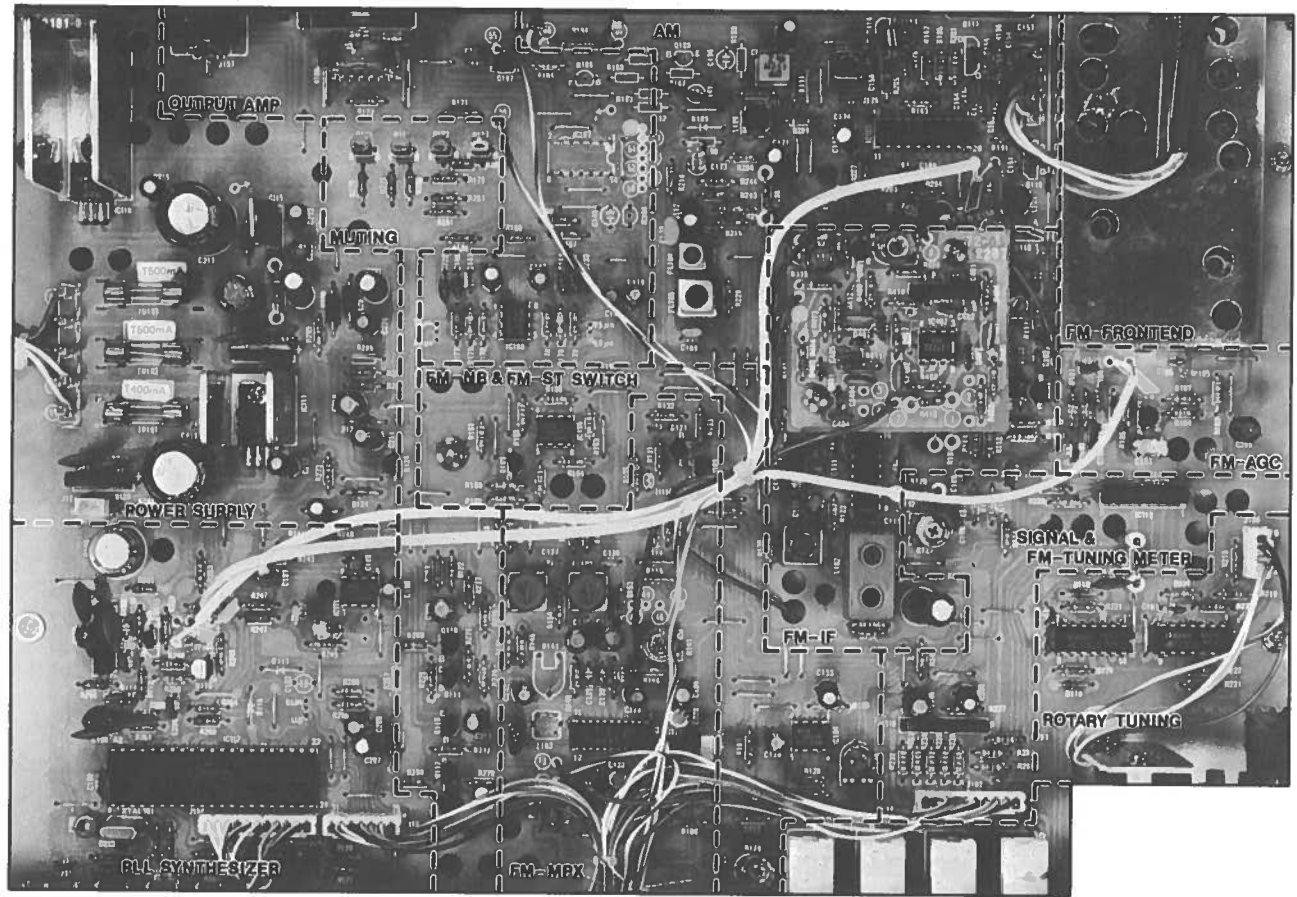

## SUGGESTED INSTRUMENTATION HOOKUP

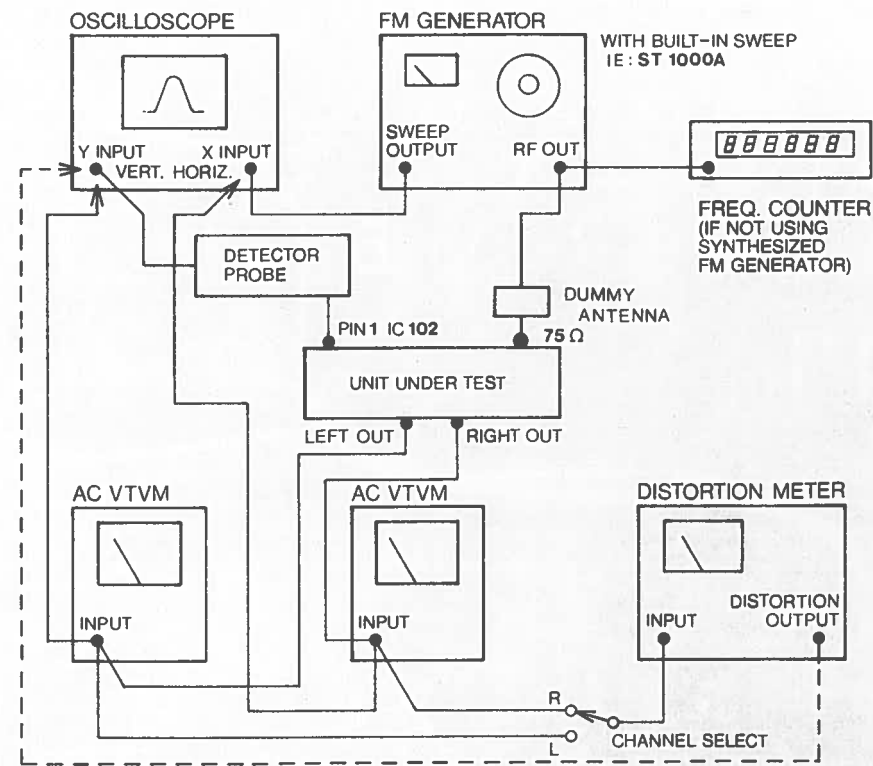
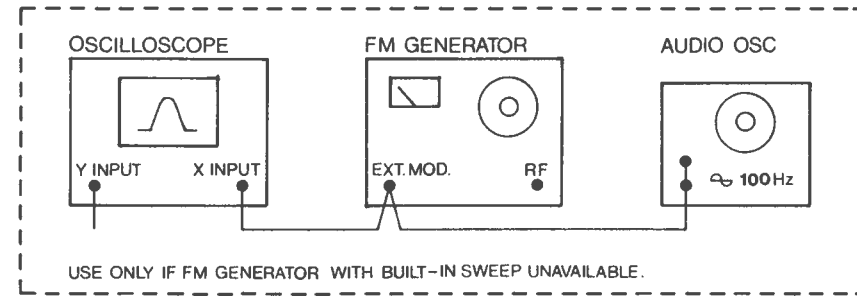

**SCHEMATIC DIAGRAM OF DETECTOR PROBE**

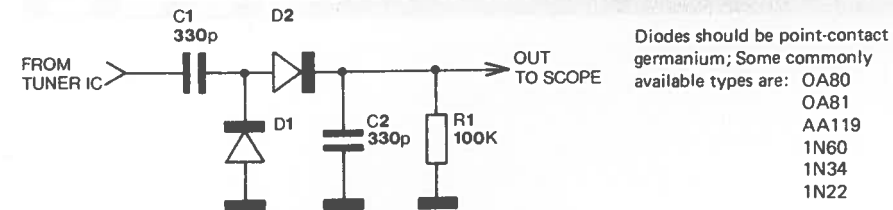

**PICTORIAL DIAGRAM OF DETECTOR PROBE**

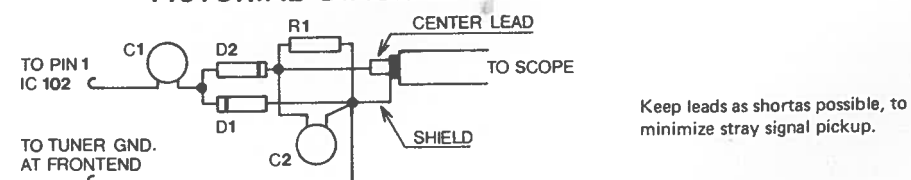

## FM ALIGNMENT

### NECESSARY INSTRUMENTATION

- FM Generator (less than 0.05% THD.)
- Stereo Modulator (less than 0.05% THD., more than 50dB Sep.)
- Audio Generator (not necessary if FM Generator has built-in sweep, e.g., SOUND TECHNOLOGY ST 1000A and ST 1020A)
- AC VTVM's (or one with a Left/Right switch)
- THD Analyzer (resolution less than 0.1%)
- Oscilloscope (5mV or better sensitivity, X input capability)
- Frequency Counter
- VOM or DMM (high impedance, must read in mV)
- 75 ohm Dummy Antenna

### IMPORTANT

- 1) Before alignments commence, release IF NARROW and MONO switches (out), Switch FM NR off (in).
- 2) IF FM Generator is not synthesizer-type, be sure to check its frequency with FREQ counter when adjusting detector and multiplex decoder circuits.

#### A. SYNTHESIZER FREQUENCY

1. Connect Frequency Counter between TP-104 and ground.
2. Tune to 98MHz (No RF input needed).
3. Adjust C-201 so that the local oscillator frequency shown by the frequency counter reads 108.700MHz.  
TOLERANCE: 108.700MHz +/- 2KHz

#### B. FRONT-END ALIGNMENTS

Alignment of the front-end should only be necessary after repair to the front-end or crystal oscillator circuits.

##### a) TUNING VOLTAGE

It is essential to check tuning voltage before aligning the rest of front-end.

1. Connect DMM between TP-105 and ground.
2. Tune to 88MHz, and adjust L-6 if the voltage is incorrect.  
TOLERANCE: 3.6V +/- 0.5V.
3. Tune to 108MHz and confirm that the voltage is within the following specification.  
SPECIFICATION: 21-25V.

##### b) TRACKING

1. Connect FM Generator (150KHz sweep, 100µV output) to 75ohm antenna input and Detector Probe to Pin 1 of IC 102 with ground to the tunershield.
2. Set tuner to 106MHz, enter into Preset 8, and tune the generator so that curve appears on Oscilloscope.
3. Adjust C-2, C-9, C-11 and C-14 for maximum curve height on the oscilloscope while reducing RF input to keep entire curve on display.
4. Set tuner to 90MHz, enter into Preset 1, and tune the generator so that curve appears on the oscilloscope.
5. Adjust L-1, L-2, L-3 and L-4 for maximum curve height.
6. Repeat above steps 2, 3, 4 and 5 (use Preset 1 and 8) till both frequencies are at maximum curve height.

### C. IF ADJUSTMENT

1. Set tuner to 98MHz approx. (the tuner must be tuned to an unoccupied frequency), and tune FM Generator to display a curve on Oscilloscope.
2. Adjust L-5 and L-101 for maximum and symmetrical output curve on the oscilloscope display, using as little input as possible.

### D. DETECTOR ALIGNMENT

1. Disconnect Detector Probe from tuner and Oscilloscope, and connect tuner output to the oscilloscope and Distortion Analyzer.
2. Connect DMM across TP-101 (-) and TP-102 (+).
3. Tune to 98MHz and feed 1mV from FM Generator (Modulate 1KHz 100%) to 75ohm antenna input.
4. Adjust L-102 Secondary for lowest THD.

SPECIFICATION: less than 0.12% (in MONO).

5. Adjust L-102 Primary for 0V reading on DMM.

TOLERANCE: +/- 50mV.

6. Repeat above steps 4 & 5 till no further improvements.

### E. SIGNAL METER LEVEL

1. Tune to 98MHz and feed 5 $\mu$ V from FM Generator to 75ohm antenna input.
2. Adjust R-127 so that the second LED of signal strength indicator is just lit up.

### F. STEREO SWITCHING THRESHOLD

1. Modulate FM Generator 1KHz 100% Left only, plus 19KHz pilot 8-10%.
2. Increase FM Generator level upwards from 0 and adjust R-126 so that stereo light turns on and audio outputs, as watched on VTVM's and Oscilloscope, switches to one channel only at 5 $\mu$ V input level.

TOLERANCE: +3 $\mu$ V.

Note that, when turning input level down, the unit will switch into mono at a lower level, typically 3.5 $\mu$ V.

### G. STEREO DISTORTION AND SEPARATION (WIDE/NARROW IF BANDWIDTH)

1. Tune to 98MHz and feed 1mV from FM Generator to 75ohm antenna input.
2. Modulate Left (or Right) channel only, and adjust L-5 and L-101 slightly, so that the distortion on Left (or Right) channel becomes minimum.
3. Check distortion at stereo operation under wide IF band-width.

SPECIFICATION: less than 0.12%, stereo L+R.  
less than 0.08%, stereo L only.  
less than 0.08%, stereo R only.  
less than 0.08%, stereo L-R.

4. Next, switch IF NARROW button (in) and check distortion under stereo signal input.

SPECIFICATION: less than 0.8%, stereo L only.  
less than 0.8%, stereo R only.  
less than 0.8%, stereo L-R.

5. Reset IF bandwidth to wide position again and modulate Left channel only. Adjust R-141 for minimum output on Right channel VTVM and oscilloscope.

Next, modulate Right channel only and adjust R-141 for minimum output on Left channel VTVM and oscilloscope.

If the leak outputs on opposite channels are different, readjust R-141 so that readings become same in both channels.

6. Check and confirm that separation under wide IF bandwidth is within the following specification.

SPECIFICATION: more than 50dB.

7. Switch IF NARROW button (in), and modulate Left (or Right) channel only. Adjust R-403 for minimum output on Right (or Left) channel VTVM and oscilloscope.

If the leak outputs on opposite channels are different, readjust R-403 so that readings become same in both left and right channels.

8. Check separation under narrow IF bandwidth and confirm it is within the following specification.

SPECIFICATION: more than 40dB.

### H. FM NR CIRCUIT

Confirm that FM NR button is at OFF position (in), at first.

1. Tune to 98MHz and feed 1mV with 100% modulation into 75ohm antenna input and set reference for S/N measurement.

With reference set, cancell the stereo modulation and leave pilot tone only.

2. Adjust the attenuator of FM Generator so that S/N ratio reads 50dB.
3. Switch FM NR on, and adjust R-148 so that S/N is improved by 8dB.
4. Switch FM NR off, and adjust attenuator of FM Generator so that S/N ratio reads 60dB.
5. Switch FM NR on, and confirm that S/N is improved by approx. 2dB.

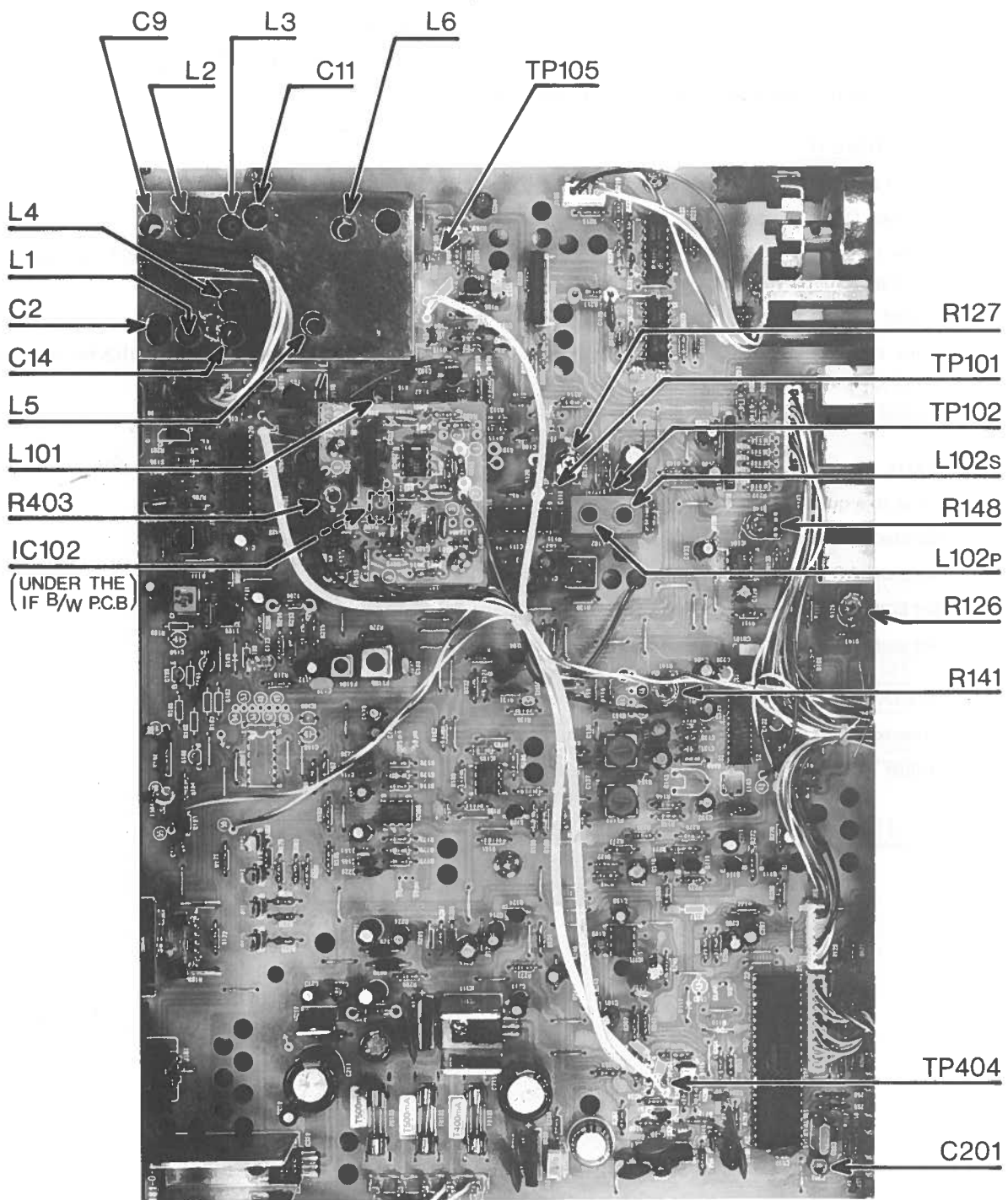

## AM ALIGNMENTS

### A OSCILLATOR.

- 1 Connect DMM to TP-103 and ground.
- 2 Tune to 1710 kHz. Enter into preset 1. Adjust C-158 for reading of  $31 \pm 0.5$  VDC.
- 3 Tune to 520 kHz. Enter into preset 2. Adjust L-105 for reading of  $1.8 \pm 0.1$  VDC.
- 4 Repeat above steps 2 and 3 until within tolerances.

### B ANTENNA, IF

- 1 Swing antenna away from chassis.
- 2 Connect DC voltmeter to centertap, R-210 and ground.
- 3 Tune to station of moderate strength, near 600 kHz. Enter into Preset 3. Adjust L-901 for maximum reading on meter (Use non-interactive tool, such as plastic or wooden stick).
- 4 Adjust L-106 and L-107 for maximum reading on meter.
- 5 Tune to a station of moderate strength near 1400 kHz. Enter into Preset 4. Adjust C-153 for maximum reading on meter.
- 6 Repeat above steps 3 and 5 until no further improvement is seen.

### C 9 kHz, 10 kHz WHISTLE FILTERS

- 1 Tune to a quiet spot (a clear frequency).
- 2 Connect audio oscillator to base, Q-112 (isolate with 0.1 - 1.0  $\mu$ F capacitor).
- 3 Connect AC VTVM (or Scope) to R-220 and ground.
- 4 Set audio oscillator to 10 kHz ( $\pm 50$  Hz) 1 V. Adjust FL-104 for minimum meter reading.
- 5 Set audio oscillator to 9 kHz ( $\pm 50$  Hz) 1 V. Adjust FL-105 for minimum meter reading.

### D SIGNAL METER

- 1 Tune to 1,000 kHz and feed 2.5 mV to the antenna terminals.
- 2 Adjust R-210 so that the fifth LED of signal strength meter lights up.

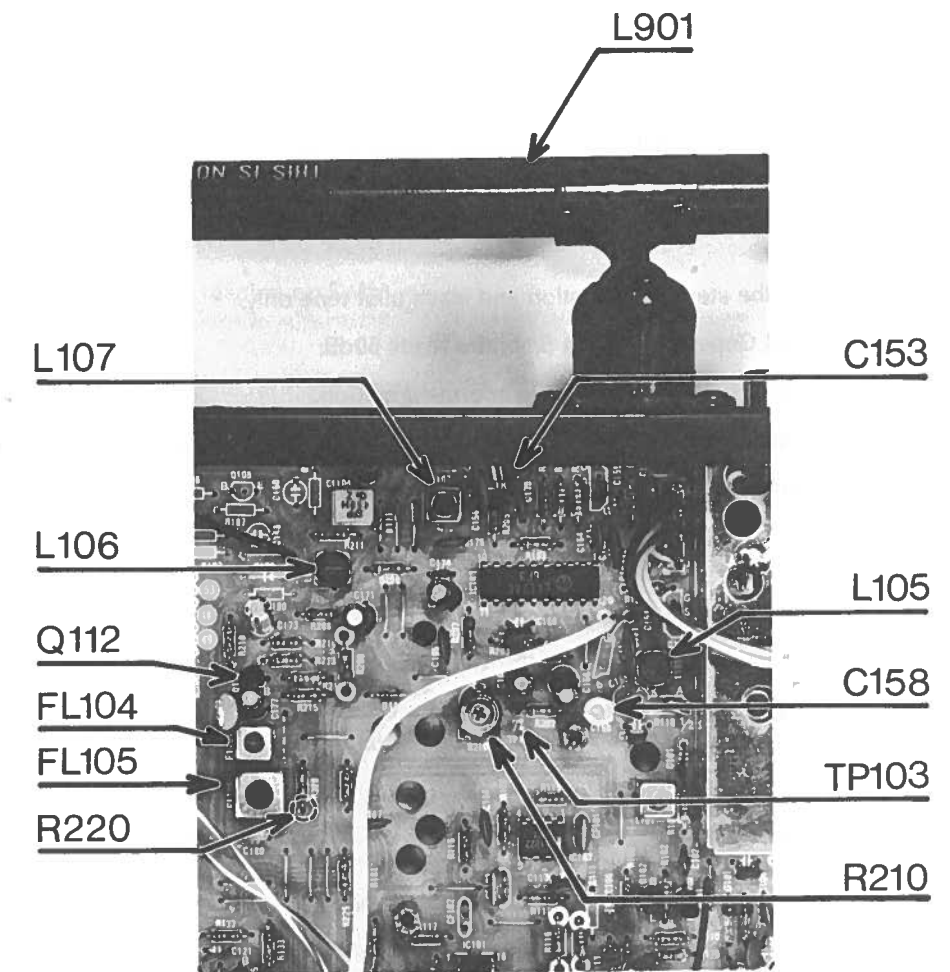





# WIRING DIAGRAM

(B, B1, C & C1 Versions, 220/240V AC less AC outlet)

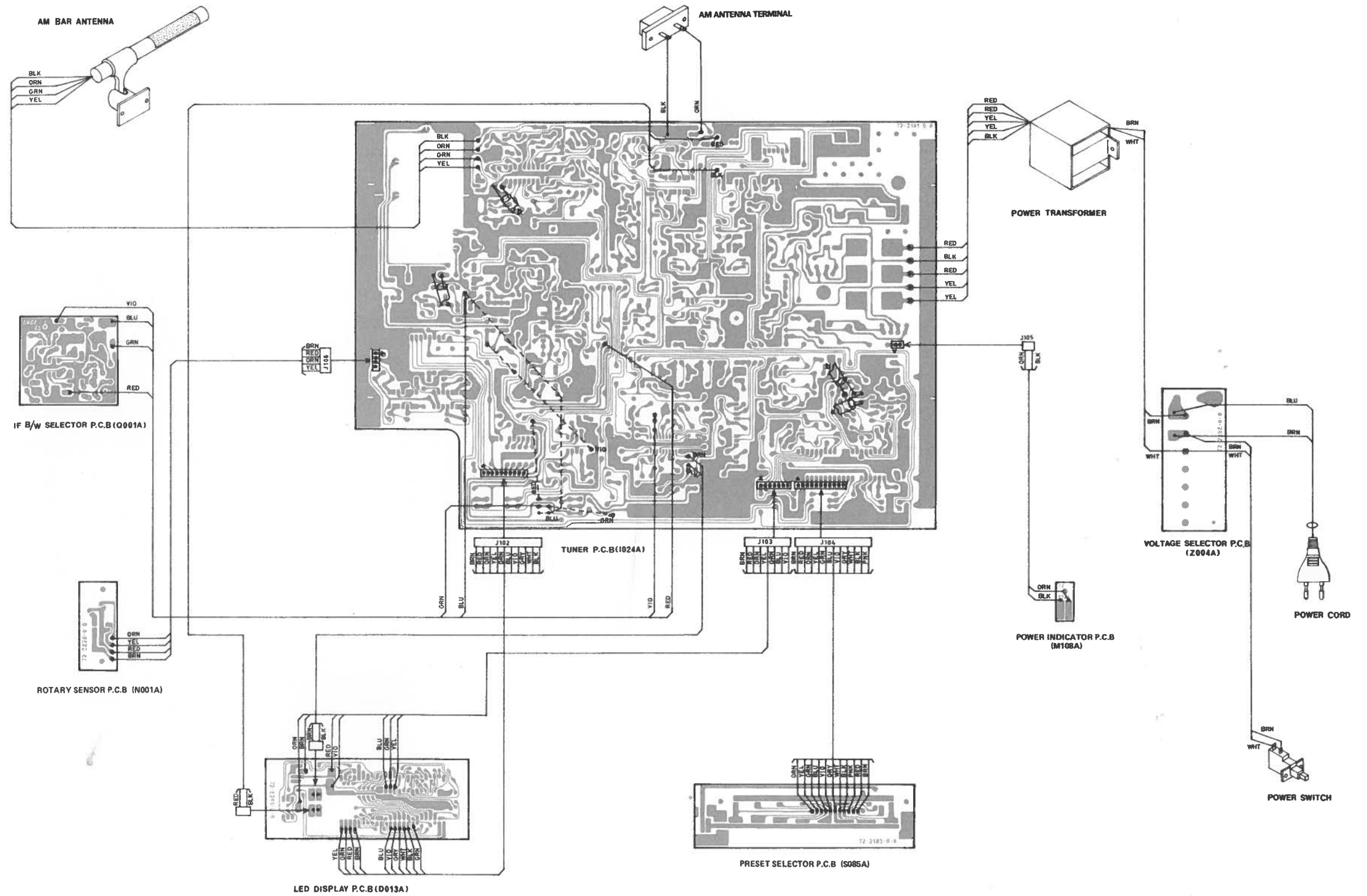

# P.C.B. LAYOUT DIAGRAM

FM FRONTEND P.C.B. ASS'Y  
(F109A)

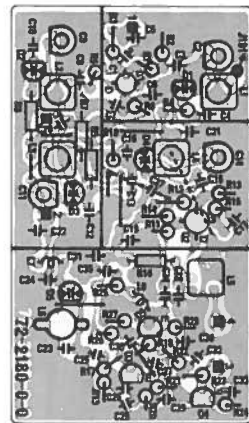

IF B/W SELECTOR P.C.B. ASS'Y  
(Q001A)

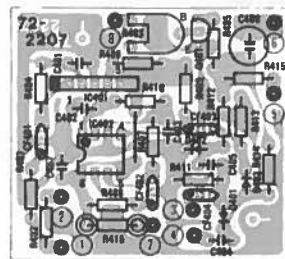

ROTARY SENSOR P.C.B. ASS'Y  
(N001A)



TUNER P.C.B. ASS'Y (I024A)

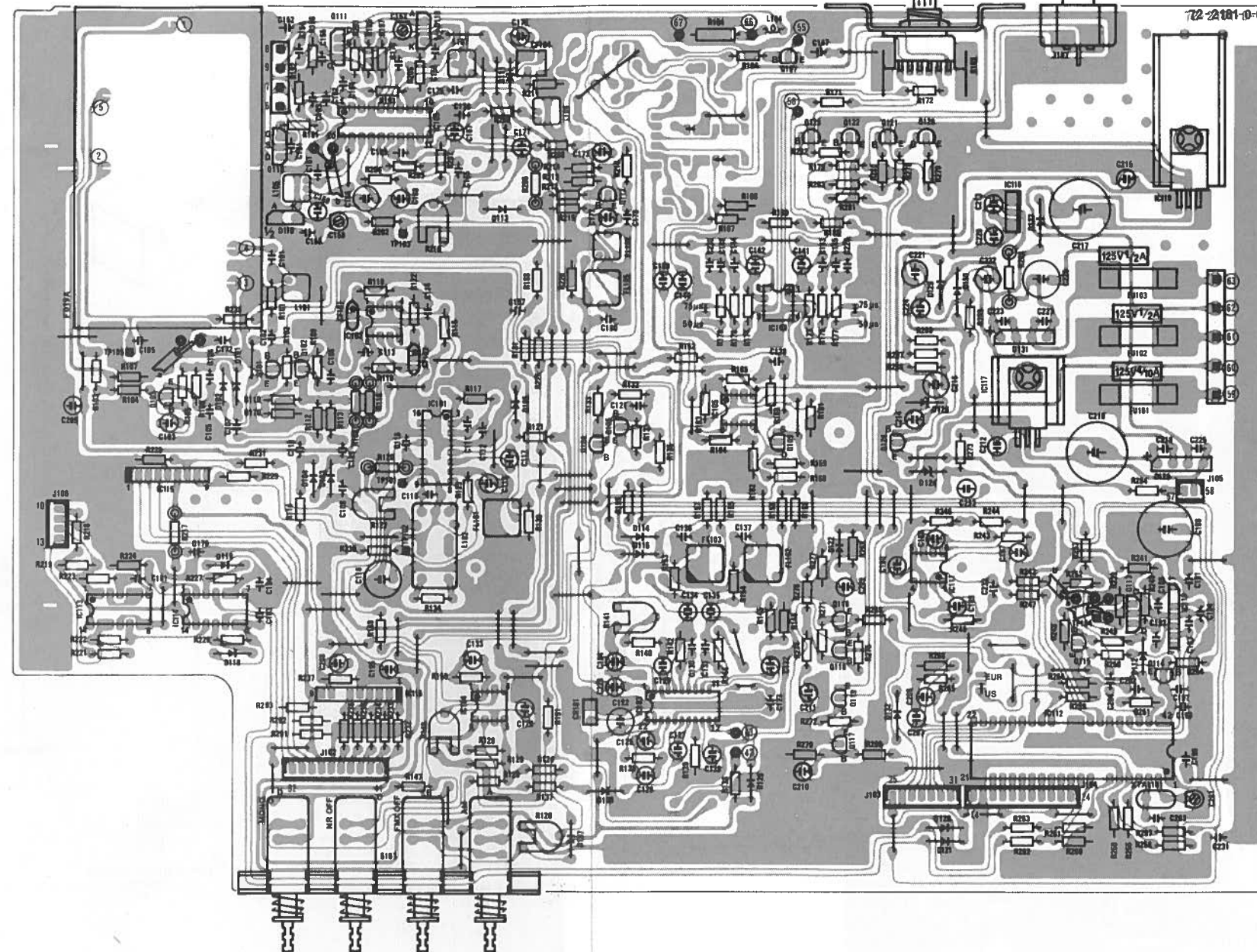

LED DISPLAY P.C.B. ASS'Y (D013A)

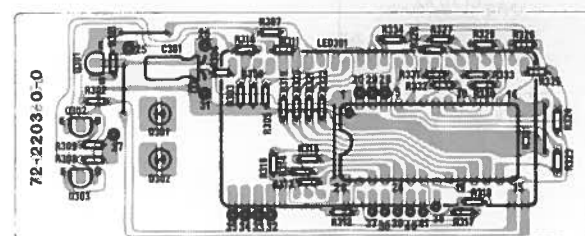

PRESET SELECTOR P.C.B. ASS'Y (S085A)

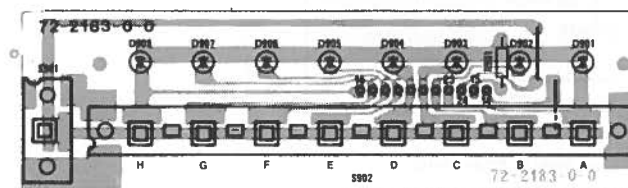

VOLTAGE SELECTOR P.C.B. ASS'Y  
(Z004A)

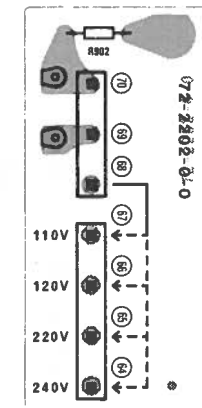

POWER INDICATOR  
P.C.B. ASS'Y  
(M108A)



# SCHEMATIC DIAGRAM NAD 4300 TUNER

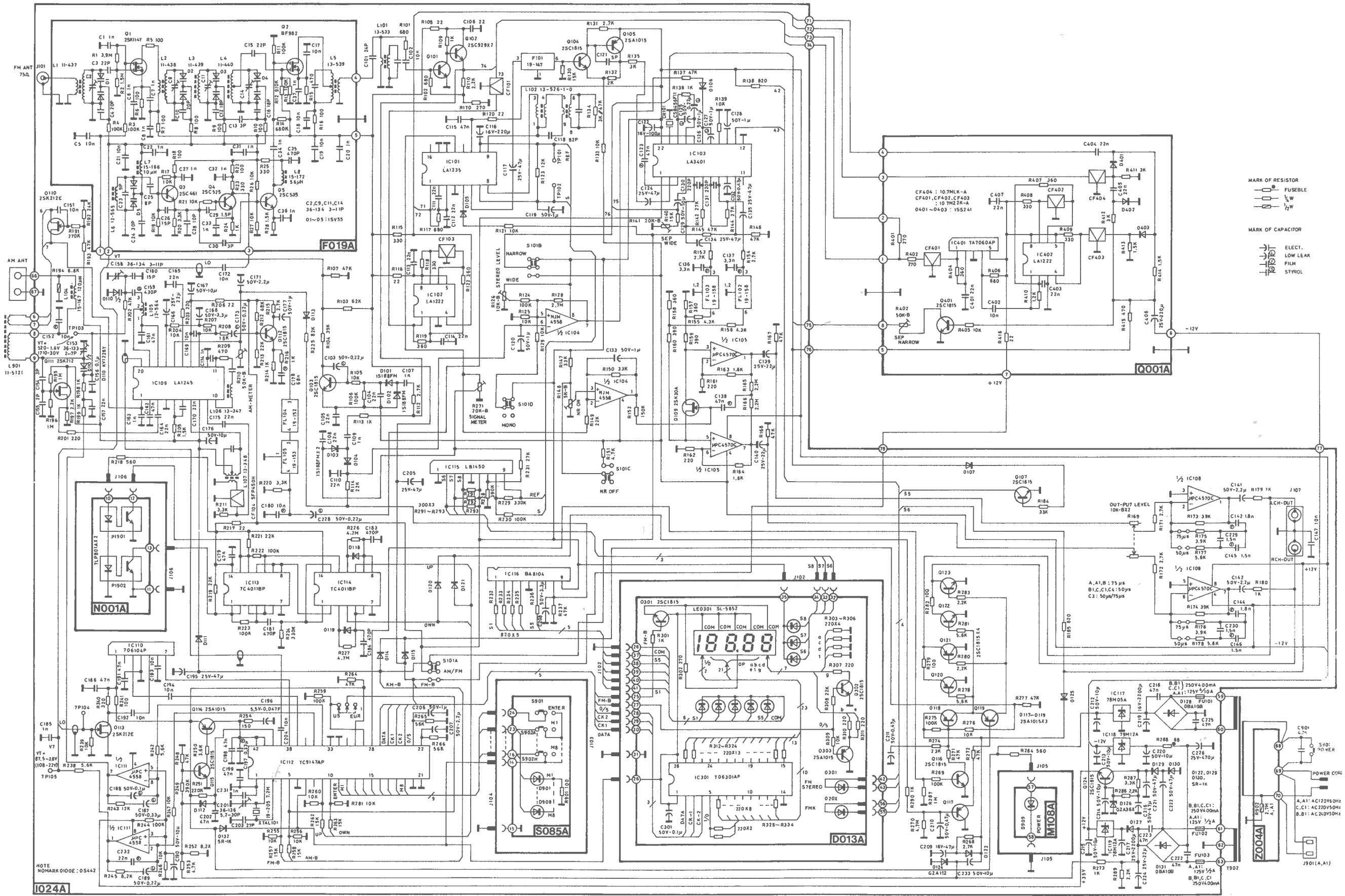

## EXPLODED VIEW PARTS LIST

Ref. No.	Parts No.	Description
1	63-6280-0-0	FRONT PANEL
2	62-1111-0-0	PUSH BUTTON - SELECTORS (BLACK)
3	62-1111-1-0	PUSH BUTTON - ON/OFF (GREEN)
4	62-3480-0-0	PUSH BUTTON FRAME - SINGLE HOLE
5	63-5170-0-0	TUNER WINDOW
6	62-1110-0-0	PUSH BUTTON - MEMORY (BLACK)
7	62-1110-1-0	PUSH BUTTON - ENTER (RED)
8	62-2320-0-0	TUNING KNOB
9	92-2103-0-0	FOOT
10	63-1844-0-0	LABEL: THIS IS NOT A HANDLE
11	71-2625-0-0	FRONT CHASSIS
12	71-2622-0-0	SIDE CHASSIS (L)
13	71-2621-0-0	SIDE CHASSIS (R)
14	71-2623-0-0	SUBCHASSIS (FRONT TO REAR SUPPORT)
15	71-2619-0-0	REAR PANEL (A, A1)
	71-2620-0-0	REAR PANEL (B, B1, C, C1)
16	71-1912-0-0	LED INTERRUPTER
17	71-3111-0-0	CABINET
18	71-3110-0-0	BOTTOM COVER
19	71-1892-0-0	BRACKET - OUTPUT LEVEL CONTROL
20	11-5121-0-0	AM BAR ANTENNA
21	23-1327-0-0	POWER TRANSFORMER (A)
	23-1327-3-0	POWER TRANSFORMER (A1)
	23-1327-2-0	POWER TRANSFORMER (B, B1)
	23-1327-1-0	POWER TRANSFORMER (C, C1)
22	85- 258-0-0	POWER CORD (A)
	85- 260-0-0	POWER CORD (A1)
	85- 240-0-0	POWER CORD (B)
	85- 259-0-0	POWER CORD (B1)
	85- 235-0-0	POWER CORD (C, C1)
23	62-3332-0-0	BUSHING - AC POWER CORD/AM ANTENNA
24	63-1843-0-0	LABEL - CAUTION FOR FUSE (A, A1)
25	63-1872-0-0	MASKING PLATE
26	87- 289-0-0	TUNING SHAFT
27	87-3247-0-0	HEXAGON STUD
28	87-3251-0-0	P.C.B. SUPPORT
29	82-2171-0-0	AM ANTENNA TERMINAL
29-1	87-3249-0-0	PLASTIC RIVET
30	82-2161-0-0	RECEPTACLE (A, A1)
31	81-2320-0-0	POWER SWITCH
32	M108A	POWER INDICATOR P.C.B. ASSEMBLY
33	S085A	PRESET SELECTOR P.C.B. ASSEMBLY
33-1	71-1911-0-0	LED GUIDE
33-2	81-2336-0-0	MEMORY SWITCH BANK (8 SWITCHES)
33-3	81-2335-0-0	ENTER SWITCH
34	D013A	LED DISPLAY P.C.B. ASSEMBLY
34-1	SL-5653	LED INDICATOR
35	Z004A	VOLTAGE SELECTOR P.C.B. ASSEMBLY
36	N001A	ROTARY SENSOR P.C.B. ASSEMBLY
36-1	TLP801	PHOTO INTERRUPTER

Ref. No.	Parts No.	Description
37	Q001A	IF <sup>B/W</sup> SELECTOR P.C.B. ASSEMBLY
38	I024A	TUNER P.C.B. ASSEMBLY
38-1	81-2334-0-0	FUNCTION SWITCH BANK (4 SWITCHES)
38-2	74-3111-0-0	HEAT SINK
38-3	74-3112-0-0	HEAT SINK
38-4	82-2130-0-0	RCA CONNECTOR - SINGLE
38-5	41- 689-0-0	ROTARY POTENTIOMETER - OUTPUT LEVEL CONTROL
39	<del>F108A</del> F019A	FM FRONTEND P.C.B. ASSEMBLY
40		TAPPING SCREW (PHILLIPS HEAD 3×6 BLK)
41		TAPPING SCREW (PHILLIPS HEAD 3×8 BLK)
42		MACHINE SCREW (PHILLIPS HEAD 3×6 BLK)
43		TAPPING SCREW (PHILLIPS HEAD 3×6 Cr)
44		TAPPING SCREW (WASHER HEAD 3×6 Cr)
45		MACHINE SCREW (PAN 3×6 Cr)
46		MACHINE SCREW S (WASHER HEAD 3×6 Cr)
47		MACHINE SCREW (WASHER HEAD 3×6 Cr)
48		MACHINE SCREW (PHILLIPS HEAD 3×6)
49		TAPPING SCREW (PHILLIPS HEAD 3×8 Cr)
50		CABINET SCREW WITH WASHER (4×6 BLK)
51		TAPPING SCREW (FLAT HEAD 3×6 Cr)
52		OUTPUT CONTROL NUT (HEXAGON 9-11-2)
53		HEXAGON FLANGE NUT (4-7-4.2)
54		HEXAGON NUT (10-14-2)
55		WASHER (TOOTHED LOCK B 10)
56		WASHER (PLAIN 9-14-0.5)

# EXPLODED VIEW

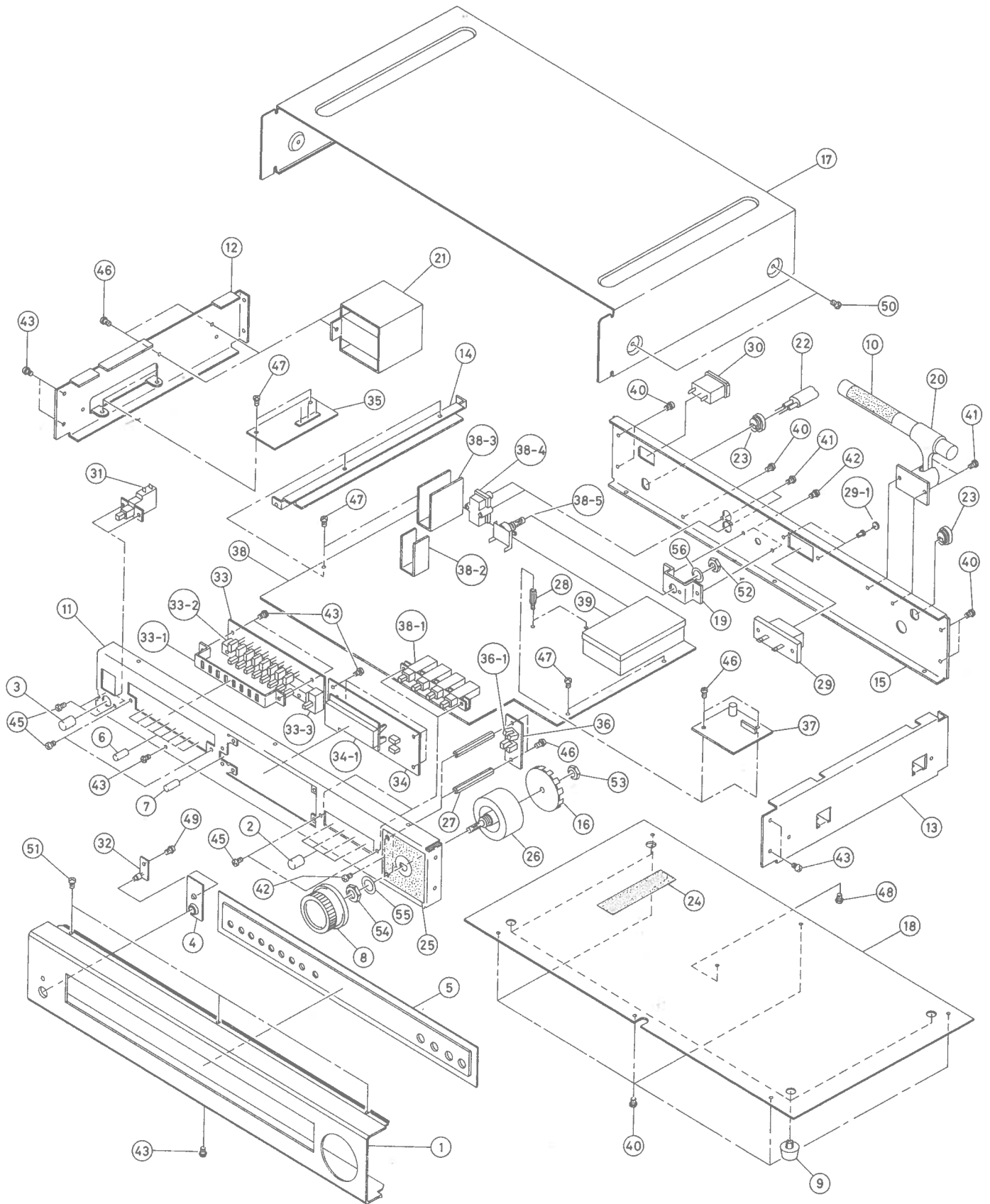

# ELECTRICAL PARTS LIST

NOTE: This is not a complete electrical parts list.

## POWER INDICATOR P.C.B. ASSEMBLY: M108A (EXPLODED VIEW REF. NO. 32)

SYMBOL NO.	PARTS NO.	DESCRIPTIONS
D909	SLP246B	LED (GREEN)

## PRESET SELECTOR P.C.B. ASSEMBLY: S085A (EXPLODED VIEW REF. No. 33)

SYMBOL NO.	PARTS NO.	DESCRIPTIONS
D901-D908	LN349GPH	LED (GREEN)

## LED DISPLAY P.C.B. ASSEMBLY: D013A (EXPLODED VIEW REF. NO. 34)

SYMBOL NO.	PARTS NO.	DESCRIPTIONS
IC301	TD6301AP	INTEGRATED CIRCUIT
Q301, Q302	2SC1815	TRANSISTOR
Q303	2SA1015	"
LED301	SL-5653	LED INDICATOR
D301, D302	LN449YPH	LED (AMBER)

## VOLTAGE SELECTOR P.C.B. ASSEMBLY: Z004A (EXPLODED VIEW REF. NO. 35)

SYMBOL NO.	PARTS NO.	DESCRIPTIONS
R902	2.7M $\Omega$ , 1/2W	CARBON RESISTOR

## ROTARY SENSOR P.C.B. ASSEMBLY: N001A (EXPLODED VIEW REF. NO. 36)

SYMBOL NO.	PARTS NO.	DESCRIPTIONS
PI901, PI902	TLP801A	PHOTO INTERRUPTER

## IF B/W SELECTOR P.C.B. ASSEMBLY: Q001A (EXPLODED VIEW REF. NO. 37)

SYMBOL NO.	PARTS NO.	DESCRIPTIONS
IC401	TA7060AP	INTEGRATED CIRCUIT
IC402	LA1222	"
Q401	2SC1815	TRANSISTOR
D401-D403	1SS241	DIODE
R403	41-791	VARIABLE RESISTOR, 5K $\Omega$ -B
CF401-CF403	19-159 (SFE10.7MZ2K-A)	CERAMIC FILTER
CF404	19-157 (SFE10.7MLK-A)	"

TUNER P.C.B. ASSEMBLY: 1024A (EXPLODED VIEW REF. NO. 38)

SYMBOL NO.	PARTS NO.	DESCRIPTIONS
IC101	LA1235	INTEGRATED CIRCUIT
IC102	LA1222	"
IC103	LA3401	"
IC104, IC111	uPC4558C	"
IC105, IC108	uPC4570C	"
IC109	LA1245	"
IC110	TD6104P	"
IC112	TC9147BP	"
IC113, IC114	TC4011BP	"
IC115	LB1450	"
IC116	BA6104	"
IC117	78M05A	"
IC118	79M12A	"
IC119	78M12A	"
Q101, Q102	2SC929	TRANSISTOR
Q103, Q104, Q107, Q112	2SC1815	"
Q115, Q116, Q120, Q121		
Q122, Q123, Q124		
Q105, Q114, Q117, Q118	2SA1015	"
Q119		
Q109	2SK30A	"
Q110, Q111, Q113	2SK212	"
D101, D102, D103, D104	1S188FM	DIODE
D105-D107, D111-D115	DS442BT	"
D118-D122, D125		
D110	KV1226Y	"
D124	GZA11Z	"
D126	GZA36X	"
D127, D129, D130, D132	SR1K	"
D128, D131	DBA10B	"
L101	13-533	IFT
L102	13-536-1-0	FM DETECTOR COIL
L104	15-167	CHOKE COIL, 120uH
L105	12-564	AM OSC COIL
L106	13-347	IFT COIL (455KHz)
L107	13-348	450KHz MATCHING COIL
C103, C125, C173, C189	50V, 0.22uF	ELCTROLYTIC CAPACITOR LOW LEAKAGE
C228		
C126, C127	50V, 1uF	"
C153	36-133	TRIMMER CAPACITOR, 2-7pF
C158	36-134	" , 3-11pF
C187	50V, 0.33uF	ELECTROLYTIC CAPACITOR LOW LEAKAGE
C188	50V, 0.1uF	"
C196	5.5V, 0.047F	MEMORY BACKUP CAPACITOR
C201	36-136	TRIMMER CAPACITOR, 5.2-30pF
R126	41-788	VARIABLE RESISTOR, 10KΩ-B
R127, R141	41-789	" , 20KΩ-B
R148	41-787	" , 5KΩ-B
R210	41-791	" , 50KΩ-B
R288	68Ω, 1/4W	FUSIBLE RESISTOR

SYMBOL NO.	PARTS NO.	DESCRIPTIONS
C118	50V, 82pF	CERAMIC DISC CAPACITOR, FK11 COG1H
CF101, CF103	19-157	CERAMIC FILTER, SFE10.7MLK-A
CF104	19-140	" , SFP450H
FL101	19-146	ANTIBIRDIE FILTER
FL102, FL103	19-158	LOW PASS FILTER, 19KHz/38KHz
FL104	19-152	" , 10KHz
FL105	19-153	" , 9KHz
XTAL101	19-205	CRYSTAL OSCILLATOR, 7.2MHz
CR101	19-156	CERAMIC RESONATOR, CSB456F11
FU101	5TT400	FUSE, 125V, 400mA (A, A1)
	173000	FUSE, 250V, 400mA (B, C)
FU102, FU103	5TT400	FUSE, 125V, 500mA (A, A1)
	173000	FUSE, 250V, 500mA (B, C)

*F019A*

FM FRONT END P.C.B. ASSEMBLY: ~~F109A~~ (EXPLODED VIEW REF. NO. 39)

SYMBOL NO.	PARTS NO.	DESCRIPTIONS
Q1	3SK114V	TRANSISTOR
Q2	BF982	"
Q3	2SC461	"
Q4, Q5	2SC535B	"
D1-D5	1SV55	DIODE
L1	11-437	FM ANTENNA COIL
L2	11-438	FM RF COIL
L3	11-439	"
L4	11-440	"
L5	13-539	IFT COIL
L6	12-565	OSC COIL
L7	15-166	CHOKE COIL, 10uH
L8	15-172	" , 0.56uH
C2, C9, C11, C14	36-134	TRIMMER CAPACITOR, 3-11pF
J101	82-2162	ANTENNA CONNECTOR, YKV11-0065 (A, A1)
	82-2174	" , YKV11-0096 (B, C)



