MOFFAT

E87 PROOFER

SERVICE MANUAL





 **WARNING: ALL INSTALLATION AND SERVICE REPAIR WORK MUST BE CARRIED OUT BY QUALIFIED PERSONS ONLY.**

CONTENTS

This manual is designed to take a more in depth look at the E87 prover for the purpose of making the unit more understandable to service people.

There are settings explained in this manual that should never require to be adjusted, but for completeness and those special cases where these settings are required to change, this manual gives a full explanation as to how, and what effects will result.

SECTION	PAGE NO.
1. SPECIFICATIONS	5
2. INSTALLATION	7
3. OPERATION.....	8
3.1 Description of Controls	
3.2 Explanation of Control System	
4. MAINTENANCE	10
4.1 Cleaning	
4.2 Routine Procedures	
5. TROUBLE SHOOTING GUIDE.....	12
6. SERVICE PROCEDURES.....	14
6.1 Fault Diagnosis	
6.2 Access	
6.3 Replacement	
7. ELECTRICAL SCHEMATICS	20
8. ELECTRICAL WIRING DIAGRAMS	21
9. SPARE PARTS	22
10. ACCESSORIES / OPTIONS	23
11. PARTS DIAGRAM	24
11.1 Main Assembly	
11.2 Control Panel Assembly	
12. SERVICE CONTACTS	27



IMPORTANT: MAKING ALTERATIONS MAY VOID WARRANTIES AND APPROVALS.

1. SPECIFICATIONS

MODEL: E87

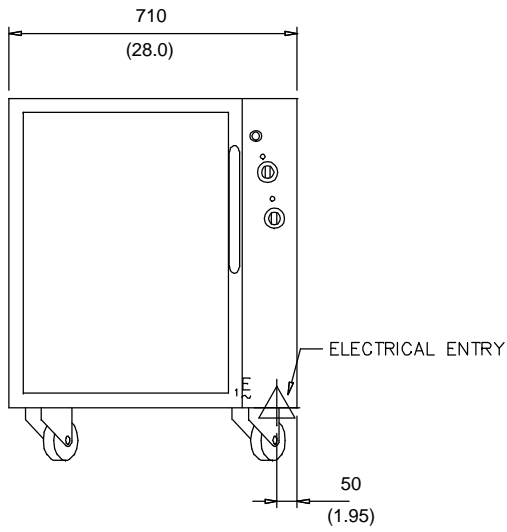

FRONT

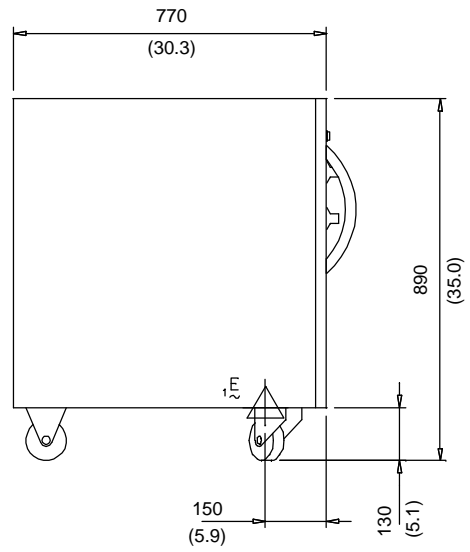

SIDE

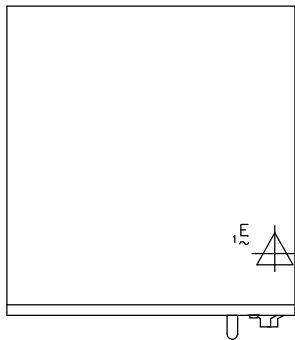

PLAN

LEGEND



- Electrical connection entry point

Dimensions shown in millimetres.
Dimensions in inches shown in brackets.

LOCATION

To ensure correct operation the following minimum installation clearances are to be adhered to:

Rear: 25 mm / 1"
Left-hand side: 25 mm / 1"
Right-hand side: 25 mm / 1"

PROVER INTERNAL DIMENSIONS

Width: 460 mm / 18"
Height: 610 mm / 24"
Depth: 660 mm / 26"
Oven Volume: 0.19 m³ / 6.5 ft³

PROVER RACK SIZE

Width: 460 mm / 18"
Depth: 660 mm / 26"

No. of rack positions: 8

Rack position spacing: 75 mm / 3"

ELECTRICAL SUPPLY SPECIFICATION OPTIONS

100-120 V AC 60 Hz, 12.5 A, 1.5 kW @ 120 V
220-240 V AC 50 Hz, 7.5 A, 1.8 kW @ 240 V

ELECTRICAL PLUG SPECIFICATION REQUIREMENTS

Australia 3-pin 250V 10A, AS/NZ 3112
Canada 3-pin 250V 15A, NEMA 6-15
New Zealand 3-pin 250V 10A, AS/NZ 3112
United Kingdom 3-pin 250V 13A fused, BS
1363A
United States 3-pin 250V 15A, NEMA 6-15
Other Countries 3-pin 250V 10A minimum, type
to meet country standards

2. INSTALLATION

 **WARNING: THIS APPLIANCE MUST BE GROUNDED.**

 **WARNING: ALL INSTALLATION AND SERVICE REPAIR WORK MUST BE CARRIED OUT BY QUALIFIED PERSONS ONLY.**

It is most important that the prover is installed correctly and that the operation is correct before use. Installation shall comply with local electrical, health and safety requirements.

BEFORE CONNECTION TO POWER SUPPLY

Unpack and check unit for damage and report any damage to the carrier and dealer. Report any deficiencies to your dealer. Fit the castors which are packed inside the unit. Check that the available power supply is correct to that shown on the rating plate located on the right-hand side panel.

220-240 V AC 50 Hz, 7.5 A, 1.8 kW @ 240 V
100-120 V AC 60 Hz, 12.5 A, 1.5 kW @ 120 V

LOCATION

To ensure correct operation the following minimum installation clearances are to be adhered to:

Rear	25mm / 1"
Left-hand side	25mm / 1"
Right-hand side	25mm / 1"

ELECTRICAL CONNECTION

E87 provers are supplied with pre-fitted cords. Ensure unit is fitted with correct cord and plug for the installation (refer to the specifications section).

Should changing of the cord be necessary, gain access to the electrical connection terminal block and strain relief clamp by removing the control panel.



Figure 2.1

ASSEMBLY OF CASTORS

1. Remove the castors from inside the prover.
2. Remove side racks and water trough.
3. Lift and place the prover onto its back. Attach the two swivel castors (with brake) to the front of the prover with the screws provided. Attach the two rigid castors to the rear.
4. Lift the prover onto its castors and refit the water trough and side racks.

DOUBLE STACKING UNITS

When it is desired to mount a Turbofan Countertop Convection Oven on an E87 prover, a double stacking kit may be used. Available from your dealer or Turbofan distributor (see Spare Parts).

When mounting one prover on top of another, a double stacking kit is also required.

RATING PLATE LOCATION

The rating plate for the E87 prover is located at the bottom left corner of the RH side panel.

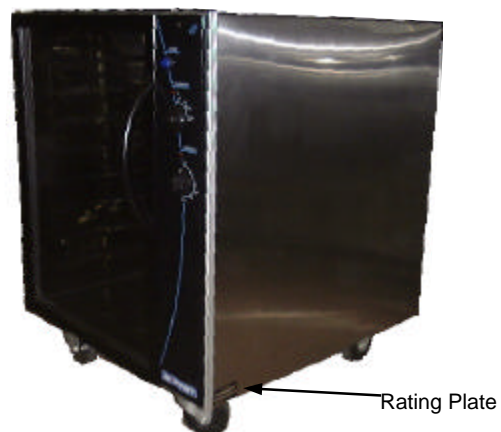
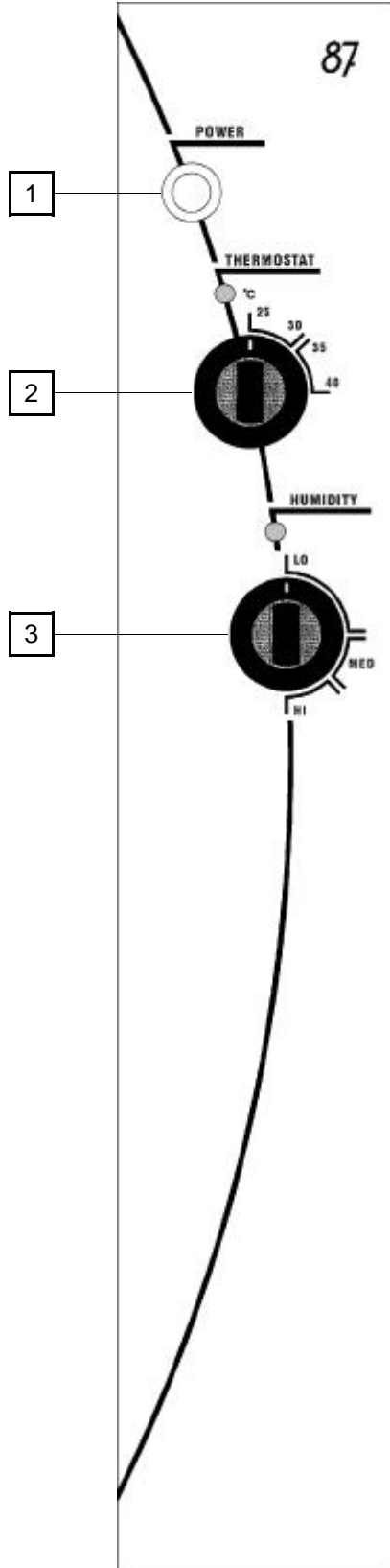

Figure 2.2

3. OPERATION

NOTE: A full user's operation manual is supplied with the product and can be used for further referencing of installation, operation and service.

3.1 DESCRIPTION OF CONTROLS



1. POWER

Depress to switch power on or off (switch illuminates when power is on).

2. THERMOSTAT

Temperature range 25 - 40°C (75 - 105°F).
Light illuminates when elements are cycling ON to maintain set temperature.
Controls the prover air temperature.

3. HUMIDITY CONTROL

(Light illuminates when elements are cycling ON to maintain set humidity).
Controls prover humidity.
LO - Humidity setting for butter based pastries (croissants, Danish pastries etc).
MED / HI - Humidity setting for yeast based breads and dough.

WATER

Open the prover door. Fill the water trough to the halfway level in the trough front filling snout, located on the right hand side. Remember to top up the water trough when the level is below the front snout.

3.2 EXPLANATION OF CONTROL SYSTEM

The E87 Prover has a power On/Off switch on the control panel and isolates power to the humidity and heating fan and light circuits when switched Off. When switched On the switch will illuminate to indicate that the unit is On and operational. The air circulation fan is On continuously on all E87 models when the power switch is in an On position.

The proofing system operates on all models, controls air temperature and humidity levels by way of an air heating element controlled by a mechanical bulb and capillary thermostat and a water tank heating element controlled by a mechanical bulb and capillary thermostat.

The air heating element is positioned in the bottom of the air circulation ducting inside the cabinet and is directly controlled by the user-adjustable thermostat mounted to the control panel. The thermostat sensing bulb is mounted inside the cabinet to control the cabinet air temperature to the control panel setting. An indicator light on the control panel above this thermostat will illuminate when the thermostat has the air heating element operating and will cycling Off with the thermostat to indicate when the temperature reaches set point.

The water tank heating element controlled by the humidity level thermostat mounted to the control panel is used to heat the water tank water and maintain water tank temperature between 50°C (122°F) and 80°C (176°F). This water tank temperature is controlled by the humidity level thermostat setting between the adjustments of low and high humidity. The evaporation rate of the water in the water tank dependent on its temperature, provides humidity into the cabinet and accordingly the setting of the humidity thermostat controls the rate of evaporation and therefore the humidity level in the cabinet.

An indicator light on the control panel above the humidity dial illuminates when the water tank element is On, and cycles Off when the thermostat switches the heating element Off to provide an indication of the humidity control. The sensing bulb of the humidity thermostat is mounted directly on the water tank heating element which are both

immersed in the water tank. Should the water tank level drop below the heating element the humidity thermostat will cycle Off due to the sensing bulb reacting to the radiated heat off the heating element and will prevent the humidity water tank heating element burning out through excessive temperature.

E87 models require the operator to manually fill the water tank and maintain the water tank level as the water evaporates through operation.

With all E87 models butter based products such as croissants and danish pastries should have the cabinet proofing temperature set around 25°C (77°F) as higher proofing temperatures will cause the butter to melt out of the product, and for yeast based doughs and breads the proofing temperature should be set higher at around 40°C (105°F) in order to activate the yeast in these products.

On all models the air circulation fan mounted at the top of the air delivery ducting ensures that the temperature and humidity throughout the cabinet is even by creating a low velocity air circulation system throughout the prover cabinet. This system overcomes the natural occurrence of hot air rising and therefore higher humidity and temperature in the upper positions of the cabinet as found with proofing units without forced air circulation.

The user-adjustable thermostat and humidity controls are required to allow adjustment of cabinet temperature and humidity levels for the variations of temperature and humidity that different product types require.

Two cabinet illumination lights are provided in the E87 models and these 15 watt each incandescent filament lamps are On whenever the control panel power switch is switched on.

To prevent the formation of condensation on the aluminium frame around the front of the cabinet and to assist in minimising the condensation occurring on the door frame and door glass inner face a resistance wire heating element is fitted into the cabinet aluminium extrusion frame. This heating wire is on whenever the power switch is switched on and will heat the aluminium frame to a warm-to-touch temperature.

4. MAINTENANCE

 **WARNING:** ALL INSTALLATION AND SERVICE REPAIR WORK MUST BE CARRIED OUT BY QUALIFIED PERSONS ONLY.

4.1 CLEANING

 **WARNING:** ALWAYS TURN THE POWER SUPPLY OFF BEFORE CLEANING.

 **IMPORTANT:** THIS UNIT IS NOT WATER PROOF. DO NOT USE A WATER JET SPRAY TO CLEAN INTERIOR OR EXTERIOR OF THIS UNIT.

This procedure is recommended to be done once a week. Frequency of cleaning the element may be increased or decreased depending on the lime depositing on the element.

CABINET

A good quality stainless steel cleaning compound is recommended for cleaning the inside and outside of the cabinet. Harsh abrasive cleaners may damage the surface.

SIDE RACKS

To remove, take hold of the centre rung and lift towards the prover top. To replace, hold horizontally, engage in holes and push down.

DOOR

Open the door and lift up off its hinges. Wash with warm water and detergent solution using a soft sponge.

To refit the door, simply fit onto its hinges.

WATER TROUGH

Remove right hand side rack and remove trough. Clean with warm, soapy water. Rinse thoroughly.

WATER TROUGH ELEMENT

When the element becomes limed / scaled, remove water trough and clean. Replace water trough and half fill with white vinegar or acetic acid then fill to the normal level with water. Switch unit on. Set humidity control to 'Hi' and run for approximately 30 minutes. Remove trough and clean element with damp cloth when cooled. Wash out trough and refit to unit.

4.2 ROUTINE PROCEDURES

	PROCEDURE	INTERVAL
DOOR HINGES	Check for wear.	12 months
DOOR CATCH	Ensure that catch is adjusted such that the door closes properly.	12 months
ELEMENTS	Check that element resistances are correct to their ratings. (refer 6.3.6, 6.3.7).	12 months
WET ELEMENT	Remove scaling (refer section 4.1).	As required
HOTWIRE	Check that hotwire is working.	12 months

5. TROUBLE SHOOTING

⚠ WARNING: ALL INSTALLATION AND SERVICE REPAIR WORK MUST BE CARRIED OUT BY QUALIFIED PERSONS ONLY.

FAULT	POSSIBLE CAUSE	REMEDY
THE PROVER DOES NOT OPERATE / START	<p>The prover is not plugged into the wall socket.</p> <p>The mains isolating switch on the wall, circuit breaker or fuses are "off" at the power board.</p> <p>The power switch on the prover is off.</p> <p>Incorrect electrical supply. (Refer fault diagnosis 6.1.1)</p> <p>Power switch on unit faulty. (Refer fault diagnosis 6.1.1)</p>	<p>Plug in.</p> <p>Turn on.</p> <p>Depress switch. Switch will illuminate.</p> <p>Ensure electrical supply correct.</p> <p>Replace. (Refer service section 6.3.3)</p>
OVEN LIGHT NOT ILLUMINATING	<p>Blown bulb.</p> <p>No power to light. (Refer fault diagnosis 6.1.2)</p>	<p>Replace. (Refer service section 6.3.1)</p> <p>Correct fault.</p>
FAN DOES NOT OPERATE	<p>Faulty fan. (Refer fault diagnosis 6.1.3)</p>	<p>Replace. (Refer service section 6.3.8)</p>
NO HEAT	<p>Thermostat faulty. (Refer fault diagnosis 6.1.4)</p> <p>Element blown. (Refer fault diagnosis 6.1.4)</p>	<p>Replace. (Refer service section 6.3.4)</p> <p>Replace. (Refer service section 6.3.6)</p>
NO TEMPERATURE CONTROL	<p>Faulty thermostat. (Refer fault diagnosis 6.1.5)</p>	<p>Replace. Refer service section 6.3.4)</p>
NO HUMIDITY	<p>No water in trough.</p> <p>Faulty thermostat. (Refer fault diagnosis 6.1.6)</p> <p>Element blown. (Refer fault diagnosis 6.1.6)</p>	<p>Fill trough with water.</p> <p>Replace. (Refer service section 6.3.5)</p> <p>Replace. (Refer service section 6.3.7)</p>
NO HUMIDITY CONTROL	<p>Faulty thermostat. (Refer fault diagnosis 6.1.7)</p>	<p>Replace. (Refer service section 6.3.5)</p>
SLOW RECOVERY	<p>Overloading of prover.</p> <p>Door opened unnecessarily.</p> <p>Electrical supply incorrect.</p> <p>Fan faulty. (Refer fault diagnosis 6.1.3)</p>	<p>Reduce batch size.</p> <p>Do not open unnecessarily.</p> <p>Check supply voltage is as per rating plate voltage.</p> <p>Replace. (Refer service section 6.3.8)</p>

FAULT	POSSIBLE CAUSE	REMEDY
NO HEATING / HUMIDITY INDICATOR	Indicator faulty. (Refer fault diagnosis 6.1.8)	Replace. (Refer service section 6.3.2)
CONDENSATION ON TOP OF FRAME	Hot wire faulty. (Refer fault diagnosis 6.1.9)	Replace. (Refer service section 6.3.12)
DOOR DOES NOT CLOSE	Tray in way of door. Damaged door magnet.	Correctly position tray in rack. Replace. (Refer service section 6.3.11)

6. SERVICE PROCEDURES

 **WARNING:** ENSURE POWER SUPPLY IS SWITCHED OFF BEFORE SERVICING.

 **WARNING:** ALL INSTALLATION AND SERVICE REPAIR WORK MUST BE CARRIED OUT BY QUALIFIED PERSONS ONLY.

SECTION	PAGE NO.
6.1 FAULT DIAGNOSIS.....	15
6.1.1 Prover Does Not Operate / Start	15
6.1.2 Prover Lights Not Illuminating	15
6.1.3 Fan Does Not Operate	15
6.1.4 No Heat	15
6.1.5 No Temperature Control.....	15
6.1.6 No Humidity	15
6.1.7 No Humidity Control	15
6.1.8 No Heating / Humidity Indicator.....	15
6.1.9 Condensation On Top Of Frame.....	15
6.2 ACCESS.....	16
6.2.1 Control Panel.....	16
6.2.2 Control Panel (Rear).....	16
6.3 REPLACEMENT	16
6.3.1 Light Bulb / Glass	16
6.3.2 Indicator Light	16
6.3.3 Power Switch.....	16
6.3.4 Thermostat.....	17
6.3.5 Humidity Thermostat	17
6.3.6 Dry Element.....	18
6.3.7 Wet Element	18
6.3.8 Fan Motor	18
6.3.9 Door	19
6.3.10 Door Hinges.....	19
6.3.11 Magnetic Catch.....	19
6.3.12 Hotwire.....	19

6.1 FAULT DIAGNOSIS

6.1.1 PPOVER DOES NOT OPERATE

Incorrect electrical supply

Check that the voltage across phase and neutral (L1 and L2) terminals of terminal block is the voltage as stated on the unit's electrical rating plate.

If incorrect, check electrical connection of supply wiring and / or check electrical supply.

Power switch faulty

Check if power switch latches. If the switch does not latch, then switch is faulty—replace.

With switch latched, check voltage across terminal 1 to terminal 3. If there is no voltage, check for fault in wiring.

Check voltage across terminal 2 to terminal 3. If there is no voltage, then switch is faulty—replace.

NOTE: When power switch is latched, it should illuminate if operating correctly.

6.1.2 PROVER LIGHTS NOT ILLUMINATING

No power to light

Check voltage across light bulb terminals. If there is no voltage then check wiring. If there is voltage then the lamp is faulty - replace.

6.1.3 FAN DOESN'T OPERATE

Fan motor faulty

Check the supply voltage across the motor terminals. If there is no voltage then check the electrical connections of supply wiring.

If voltage is correct then check the oven fan for free rotation. Remove any obstruction.

If fan is free to spin and the voltage supply is correct, then the motor is faulty—replace.

6.1.4 NO HEAT

Thermostat faulty

With cold prover, set thermostat to 40°C / 105°F. Check power to terminal 1 of top thermostat. If there is no power then check wiring.

Check power at terminal 2. If there is no power then the thermostat is faulty - replace.

Element blown

With thermostat on and heating check voltage across dry element terminals. If there is no voltage check wiring. If voltage is correct, element is faulty - replace.

6.1.5 NO TEMPERATURE CONTROL

Thermostat faulty

With thermostat in off position (fully counter-clockwise), the heating indicator should be off. If not, then the thermostat is faulty - replace.

6.1.6 NO HUMIDITY

Thermostat faulty

With cold prover, set humidity to 'HI'. Check power to terminal 1 of bottom thermostat. If there is no power then check wiring.

Check power at terminal 2. If there is no power then the thermostat is faulty - replace.

Element blown

With humidity thermostat on and heating check voltage across wet element terminals. If there is no voltage check wiring. If voltage is correct, element is faulty - replace.

6.1.7 NO HUMIDITY CONTROL

Humidity thermostat faulty

Switch the prover on and set the humidity to 'LO'. Check that the humidity thermostat cycles on/off, and using a suitable probe measure the temperature of the water in the trough. The water temperature should be 50° C/120°F ± 10%. If the temperature continues to rise above this then the humidity thermostat is faulty - replace.

6.1.8 NO HEATING / HUMIDITY INDICATOR

Indicator faulty

Check voltage across indicator terminals with controls on and appropriate thermostat turned on fully. If the voltage is correct, and the indicator is not illuminating then the indicator is faulty - replace. If there is no voltage then check wiring.

6.1.9 CONDENSATION ON TOP OF FRAME

Hotwire faulty

Check voltage across hotwire. If there is no voltage then the hotwire is faulty - replace.

6.2 ACCESS

6.2.1 CONTROL PANEL

- 1) Undo the one screw on top of control panel.



Figure 6.2.1

- 2) Panel is now free to hinge at bottom. When closing the panel ensure wires and capillary tube are clear of metal or other terminals.

6.2.2 CONTROL PANEL—REAR

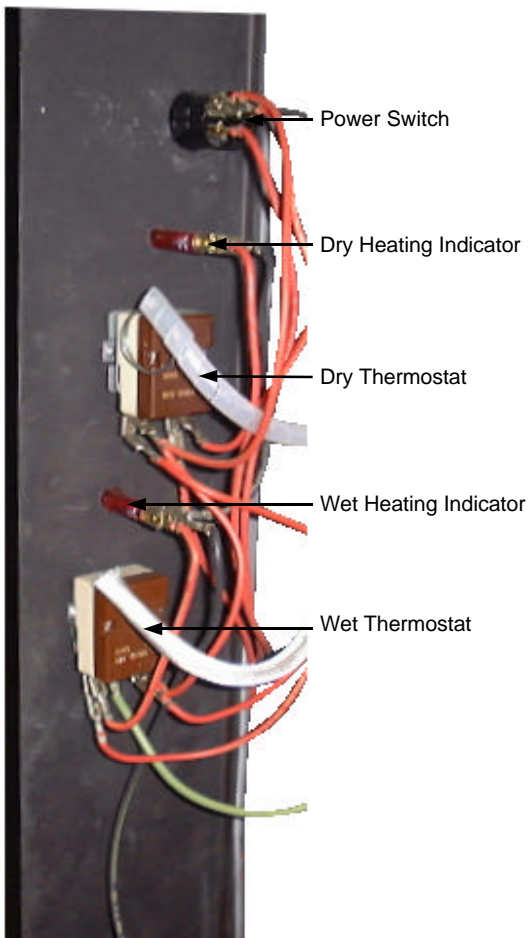

Figure 6.2.2

6.3 REPLACEMENT

6.3.1 LIGHT BULB / GLASS

- 1) Open the prover door.
- 2) Pull off lamp cover.

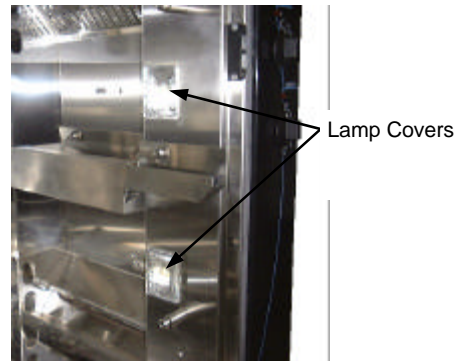

Figure 6.3.1

- 3) Unscrew bulb out of fitting.
- 4) Screw in replacement bulb.
- 5) Refit lamp cover.

6.3.2 INDICATOR LIGHT

- 1) With control panel open (refer 6.2.1) remove the wires from the back of the neon.

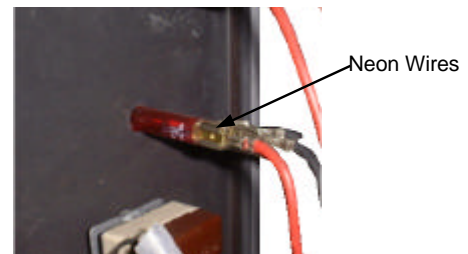

Figure 6.3.2

- 2) From back push neon through front of panel rotating clockwise.
- 3) Push new neon in from front of panel, and reconnect wires.

6.3.3 POWER SWITCH

- 1) With control panel open (refer 6.2.1) remove the wires from the back of the switch, noting their positions.

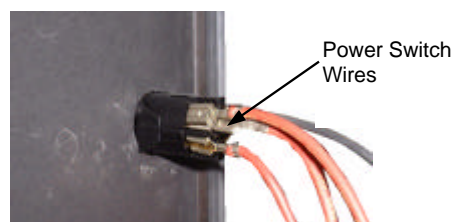

Figure 6.3.3

- 2) From back push switch through front of panel.
- 3) Push new switch in from front of panel, and reconnect wires.

6.3.4 THERMOSTAT

- 1) Pull knob off front of thermostat
- 2) Open control panel (refer 6.2.1) and undo 2 screws securing thermostat.

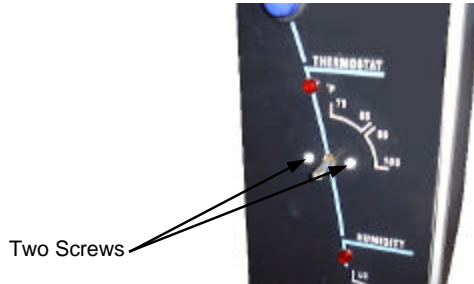

Figure 6.3.4

- 3) Transfer wires to new thermostat.
- 4) With door open, remove right hand side rack. Undo thermostat support bracket screw and remove bracket.

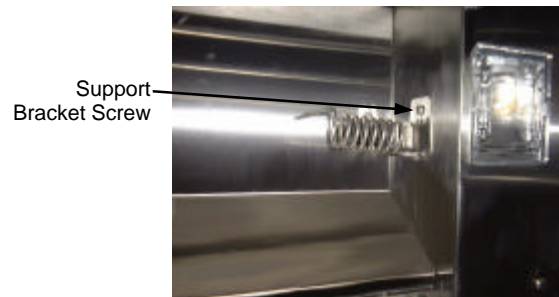

Figure 6.3.5

- 5) Withdraw old thermostat phial through side of prover.
- 6) Remove plastic sleeving from old thermostat and fit to replacement thermostat.

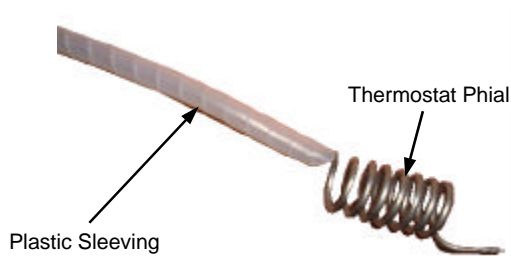

Figure 6.3.6

- 7) Insert new thermostat.
- 8) Re-assemble in reverse order.

6.3.5 HUMIDITY THERMOSTAT

- 1) Pull knob off front of thermostat
- 2) Open control panel (refer 6.2.1.) and undo 2 screws securing thermostat.

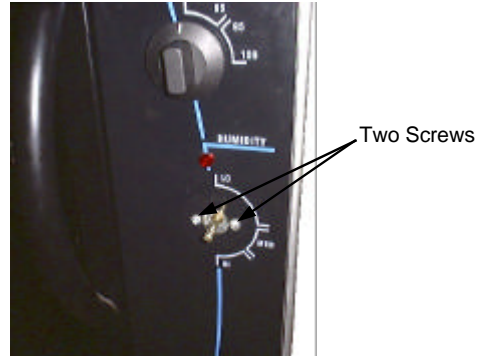

Figure 6.3.7

- 3) Transfer wires to new thermostat.
- 4) With door open, remove right hand side rack and water trough. Undo thermostat support bracket screw and remove bracket. Remove clips holding capillary to element.

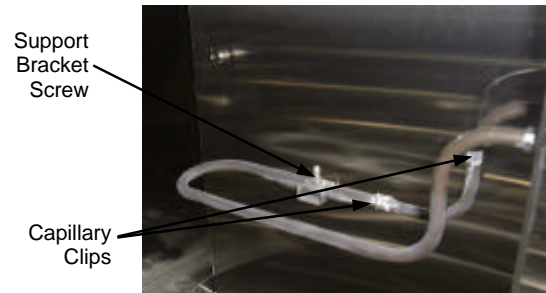

Figure 6.3.8

- 5) Remove rubber bush in side wall, withdraw old thermostat phial through side of prover.
- 6) Remove fibreglass sleeving from old thermostat and fit to replacement thermostat

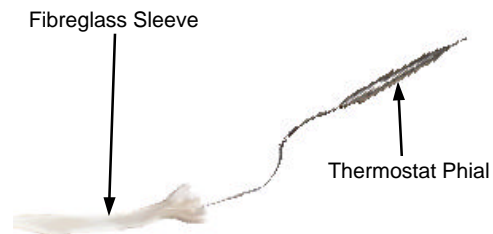

Figure 6.3.9

- 7) Insert new thermostat.
- 8) Re-assemble in reverse order.

6.3.6 DRY ELEMENT

- 1) Open control panel (refer 6.2.1), remove wires from element terminals noting position.

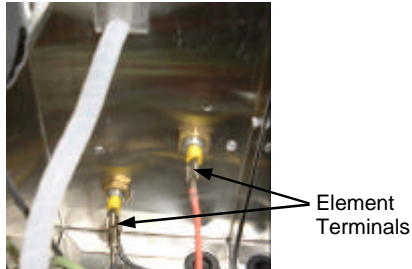

Figure 6.3.10

- 2) With door open, remove right hand side rack
- 3) Unscrew the element from inside control housing. Pull element carefully to remove from inside of prover.

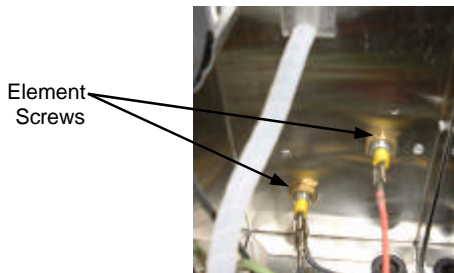

Figure 6.3.11

- 4) Replace and re-assemble in reverse order.

Dry Element Ratings

110 - 120 Volt	20.5 ohms
220 - 240 Volt	70.5 ohms.

6.3.7 WET ELEMENT

- 1) With door open, remove right hand side rack and water trough.
- 2) Undo thermostat support bracket screw and remove bracket.
- 3) Remove clips holding capillary to element.

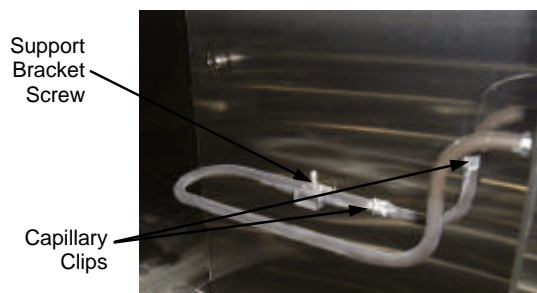

Figure 6.3.12

- 4) Open control panel (refer 6.2.1) and remove wires from element terminals, noting their positions.
- 5) Unscrew the element from inside control housing.

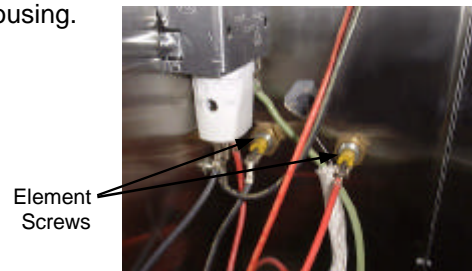

Figure 6.3.13

- 6) Pull element carefully from the inside of prover to remove .
- 7) Replace and re-assemble in reverse order.

Wet Element Ratings

110 - 120 Volt	20.1 ohms
220 - 240 Volt	71.5 ohms

6.3.8 FAN MOTOR

- 1) Open control panel (refer 6.2.1), and remove wires from fan motor terminals, noting positions.

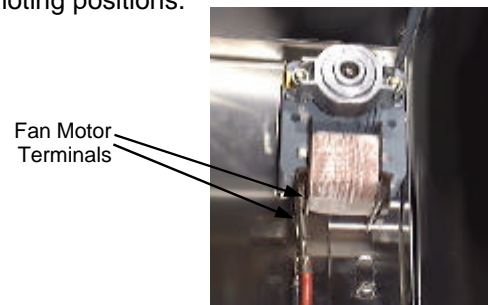

Figure 6.3.14

- 2) Loosen retaining bracket screw. Slide bracket down to bottom position.

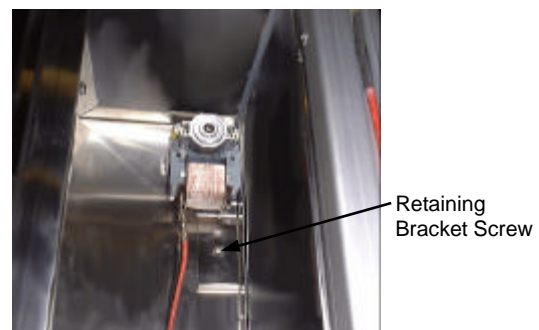

Figure 6.3.15

- 3) Slide out motor.
- 4) Replace and re-assemble in reverse order, ensuring bracket is secured in highest position.

6.3.9 DOOR

- 1) Open prover door.
- 2) Lift door vertically off hinges.
- 3) Remove door handle and door catch plate (two bolts).

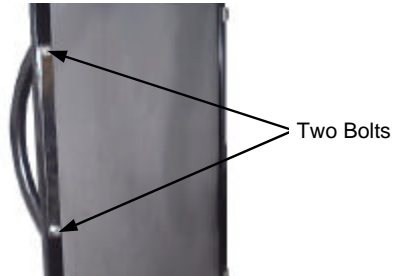

Figure 6.3.16

- 4) Drill out rivets securing hinges to old door frame (two per hinge).

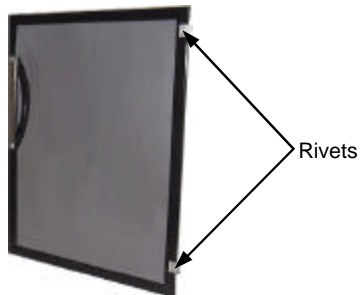

Figure 6.3.17

- 5) Secure door handle and catch plate to new door.
- 6) Rivet hinges to new door frame.
- 7) Re-hang door on E87 prover.

6.3.10 DOOR HINGES

- 1) Open prover door.
- 2) Lift door vertically off hinges.
- 3) Drill out rivets securing hinges to door and E87 prover (two rivets per hinge), and remove hinges.

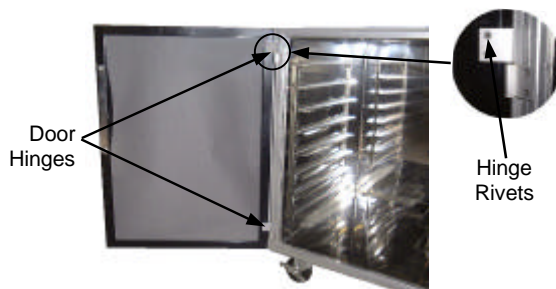

Figure 6.3.18

- 4) Rivet new hinges to door and E87 prover.
- 5) Re-hang door on prover.

6.3.11 MAGNETIC CATCH

- 1) Open prover door.
- 2) Open control panel.
- 3) Unscrew two screws securing magnetic door catch to prover.

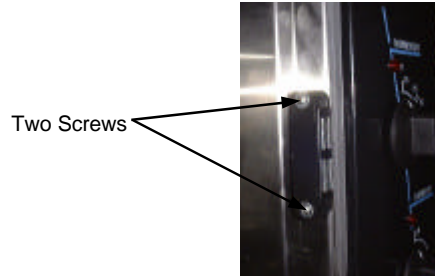

Figure 6.3.19

NOTE: A spanner may be required to hold the nuts located inside the control panel, behind the magnetic catch.

- 4) Replace magnetic catch and re-assemble in reverse order.

6.3.12 HOTWIRE

- 1) Open control panel (refer 6.2.1) and prover door.
- 2) Remove silicone extrusion seal strips from prover door frame.

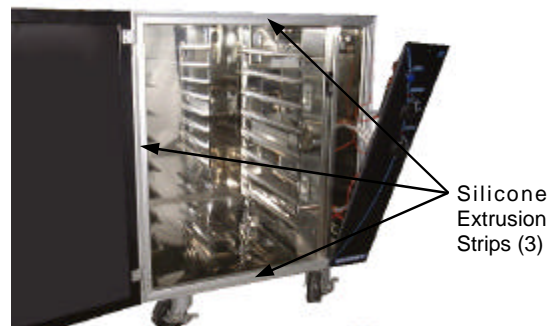

Figure 6.3.20

- 3) Remove hotwire retaining sleeves (9) from prover frame.

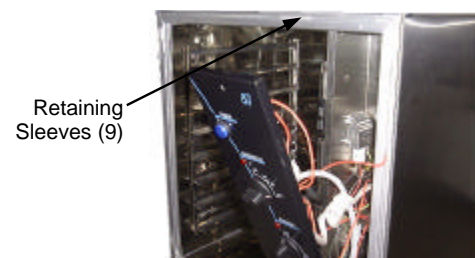
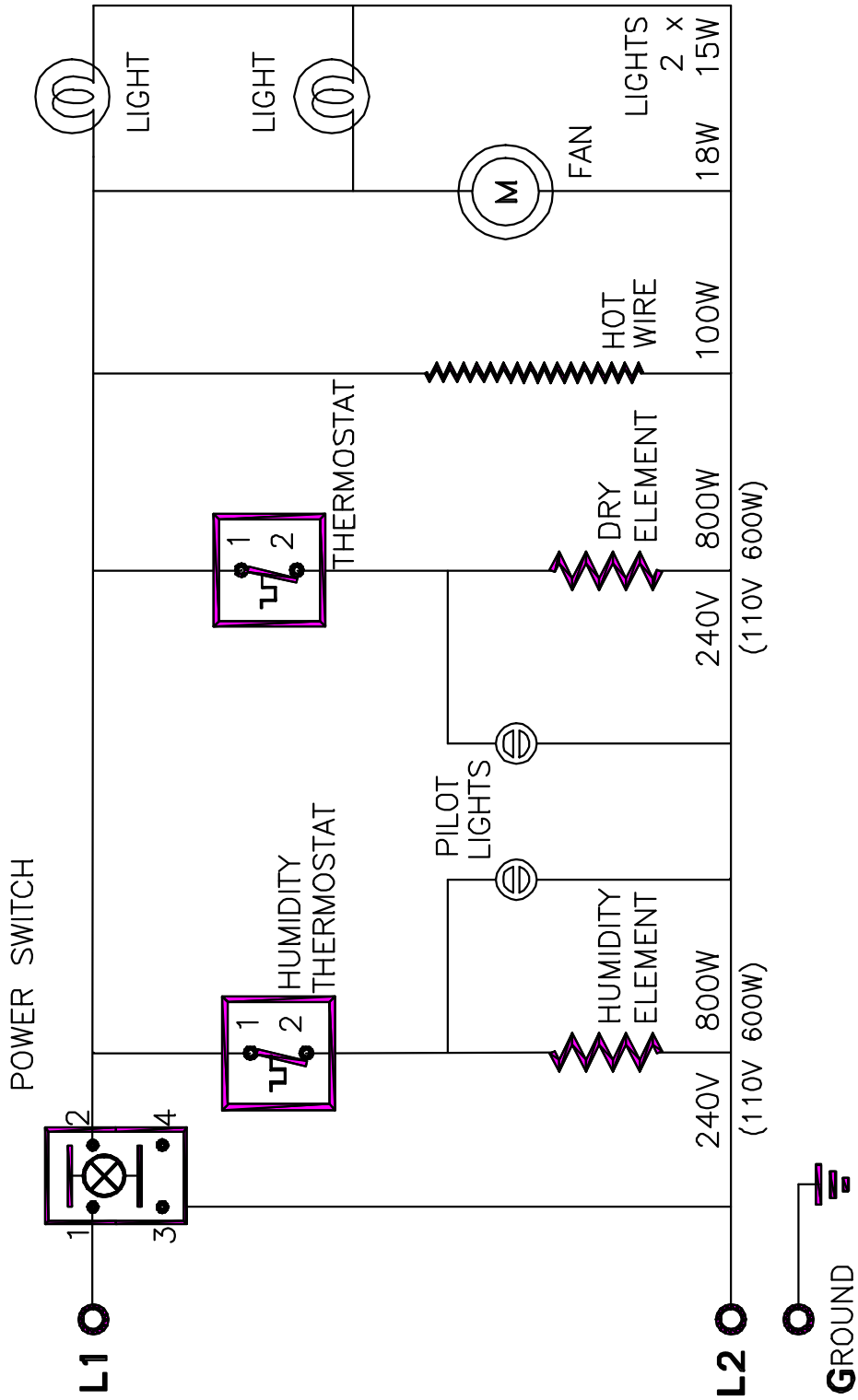

Figure 6.3.21

- 4) Remove hotwire from prover, noting wiring positions.
- 5) Replace and re-assemble in reverse order.

7. ELECTRICAL CIRCUIT SCHEMATIC



8. ELECTRICAL WIRING DIAGRAM

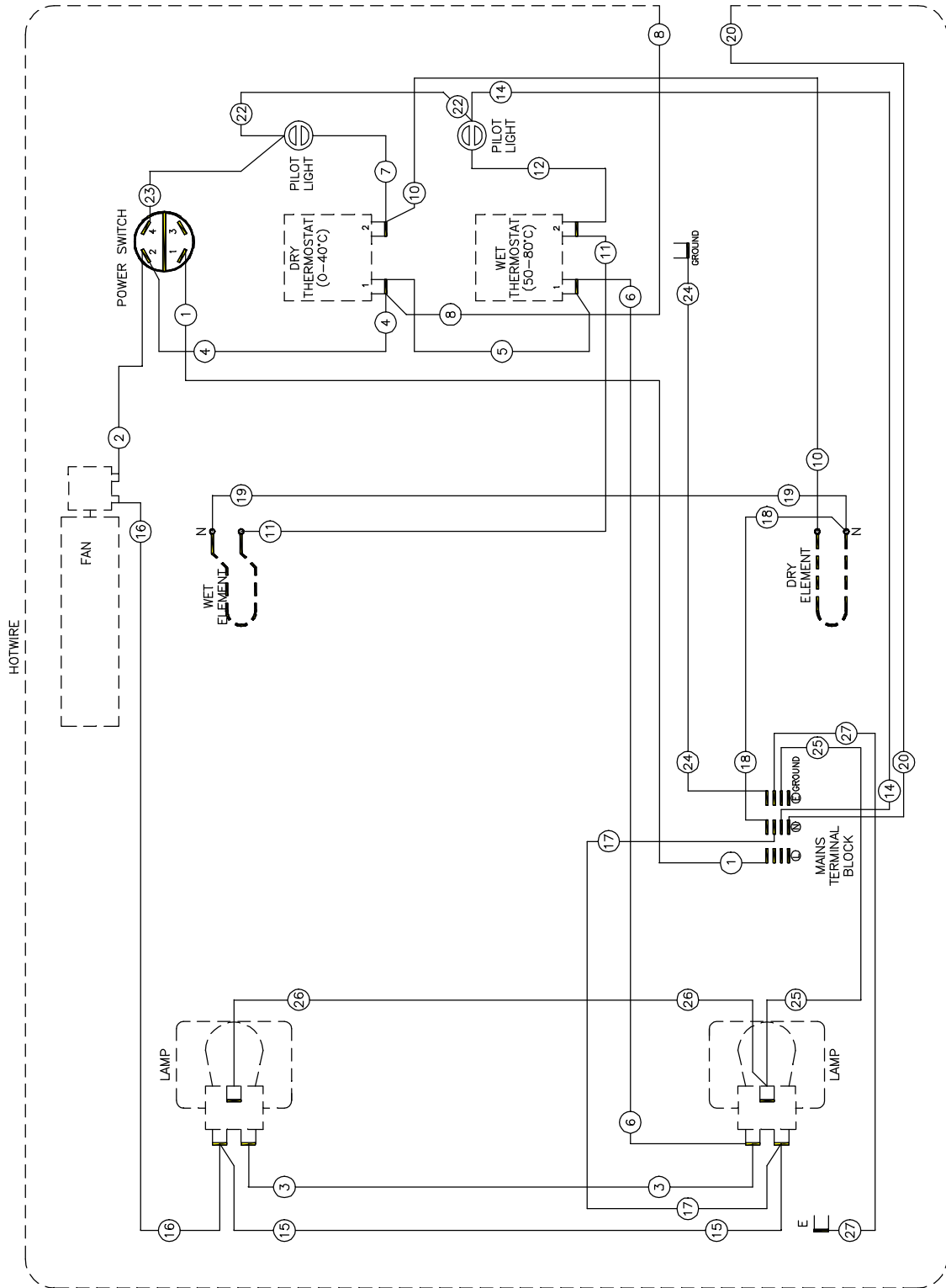

9. SPARE PARTS

PART NO	DESCRIPTION
----------------	--------------------

CONTROLS

021473	Switch - Power (220-240V)
021514	Switch - Power (110V)
014233	Thermostat (Temperature)
015485	Thermostat (Humidity)
020823	Knob - Thermostats
020849	Neon Indicator
014218	Oven Lamp Bulb - 15W (220-240V)
014219	Oven Lamp Bulb - 15W (110V)
015539	Heating Wire - 100W (220-240V)
015538	Heating Wire - 100W (110V)

MOTOR & ELEMENTS

013998	Motor and Fan (220-240V)
013999	Motor and Fan (110V)
014001	Dry Element (220-240V)
015759	Dry Element (110V)
015224	Wet Element (220-240V)
015230	Wet Element (110V)

DOOR

021461	Door Assembly
021468	Handle
017575	Hinge
018947	Magnetic catch

RACKS

015477	Side Rack
--------	-----------

STACKING KIT

21547	Double Stacking Kit
-------	---------------------

10. ACCESSORIES

DOUBLE STACKING KIT (PART NO 021547) - For use with E32 / G32 convection ovens



6" LEG OPTION (PART NO 15274)



DRIP TROUGH (PART NO 15295)



STANDOFF KIT (PART NO 21336) - Enables prover to take 16" wide trays



11. PARTS DIAGRAMS

11.1 MAIN ASSEMBLY

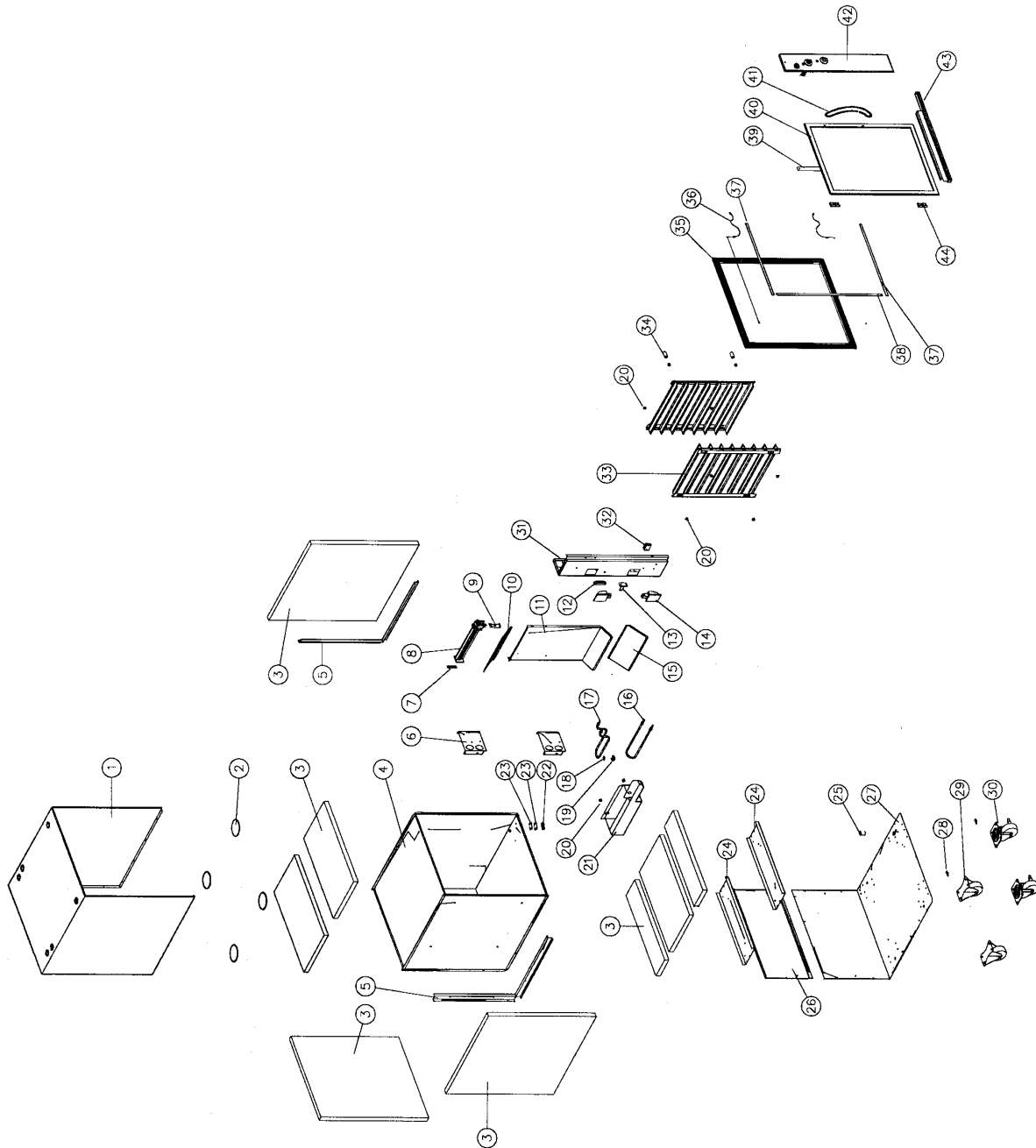

Pos	Part No.	Description
1	015236	WRAPPER
2	015253	SUPPORT DISC
3	-----	INSULATION
4	015483	LINER
5	018738	LINER SUPPORT
6	015244	RACK MOUNTING PLATE
7	015278	FAN LOCATING BRACKET
8	013998	FAN/MOTOR ASSEMBLY - 240V
	013999	FAN/MOTOR ASSEMBLY - 110V
9	015243	FAN CLAMP BRACKET
10	015242	FAN COVER
11	015241	DUCTING
12	018947	MAGNETIC CATCH
13	015249	CAPILLARY BRACKET
14	021342	LAMP HOLDER ASSEMBLY
	014218	BULB (15w, 240V)
	014219	BULB (15w, 110V)
15	015248	DUCTING HEAT SHIELD
16	014001	DRY ELEMENT (600w, 240V)
	015759	DRY ELEMENT (600w, 110V)
17	015224	WET ELEMENT (800w, 240V)
	015230	WET ELEMENT (800w, 110V)
18	012272	CLAMP TOP
19	012271	CLAMP BOTTOM
20	014725	HANGER STUD
21	015474	WATER TROUGH
22	002138	CABLE CLAMP
23	002441	INSULATOR
24	018737	BASE STIFFENER
25	015237	SPACER TUBE
26	015235	BACK PANEL
27	015234	BASE PANEL
28	017858	CABLE CLAMP
29	013885	CASTOR - 5" RIGID
30	013890	CASTOR - 5" SWIVEL
31	015240	CONTROL HOUSING
32	013586	MAINS TERMINAL BLOCK
33	015477	SIDE RACK
34	015481	HANGER SPACER
35	016650	FRAME
36	015539	HEATING WIRE (100w, 240V)
	015538	HEATING WIRE (100w, 110V)
37	015238	STRIP INSERT - SHORT
38	015239	STRIP INSERT - LONG
39	021464	CATCH PLATE
40	021461	DOOR ASSEMBLY
41	021468	DOOR HANDLE
42	-----	CONTROL PANEL ASSEMBLY (REFER TO SECTION 11.2)
43	015295	DRIP TROUGH (OPTIONAL EXTRA)
44	017575	DOOR HINGE

11.2 CONTROL PANEL ASSEMBLY

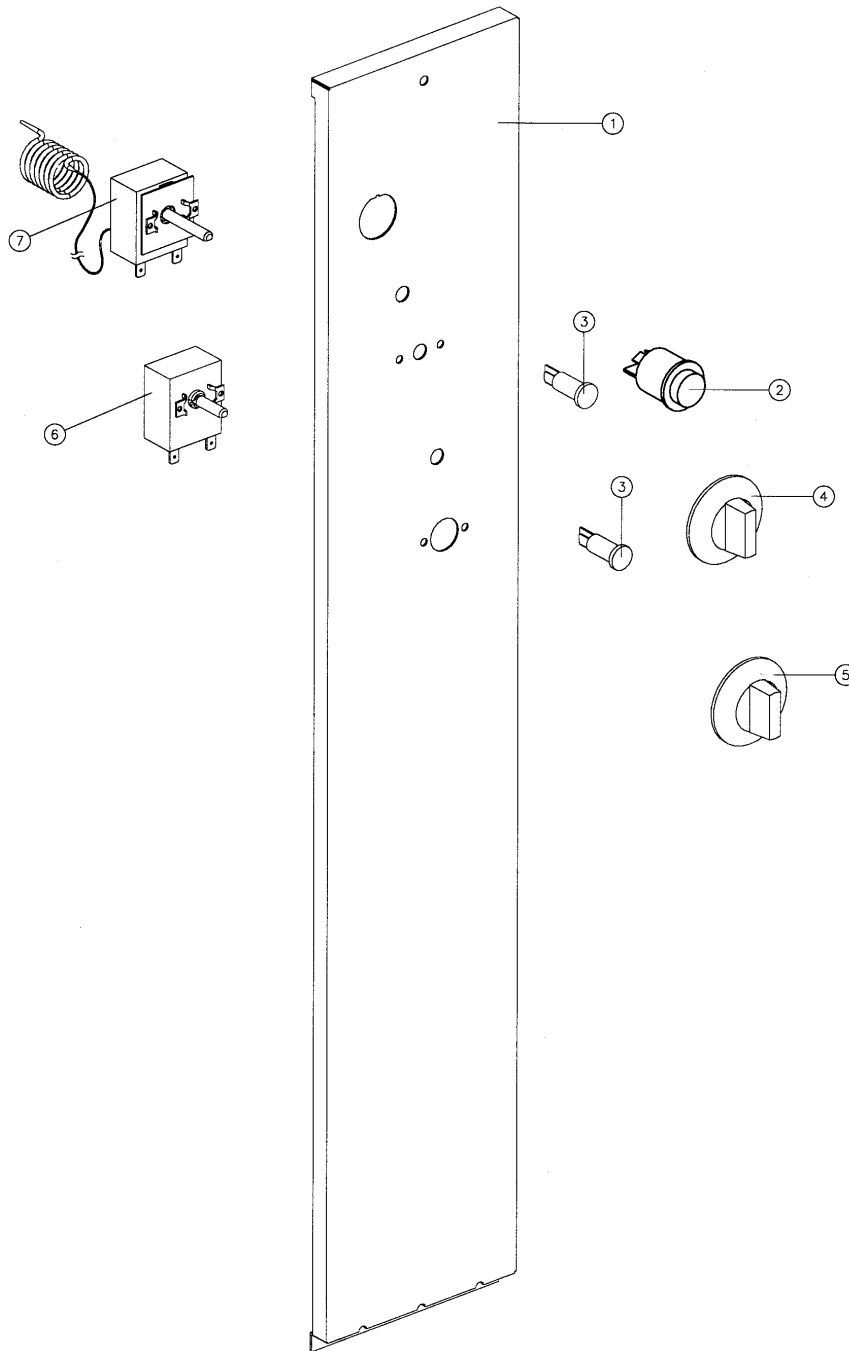

Pos	Part No.	Description
1	004726	CONTROL PANEL BAKBAR °C
	004805	CONTROL PANEL BLUE SEAL °C
	004724	CONTROL PANEL MOFFAT °F
2	021473	POWER SWITCH (240V)
	021514	POWER SWITCH (110V)
3	020849	PILOT LIGHT (240V)
	023857	PILOT LIGHT (110V)
4	021472	KNOB - HUMIDITY
5	020823	KNOB - THERMOSTAT
6	015485	THERMOSTAT 50-80°C (120-175°F)
7	014233	THERMOSTAT 0-40°C (32 - 105°F)

11. SERVICE CONTACTS

AUSTRALIA

VICTORIA - MOFFAT PTY

HEAD OFFICE AND MAIN WAREHOUSE
740 Springvale Road
Mulgrave VIC 3170
Spare Parts Department

Tel (03) 9518 3888
Fax (03) 9518 3838
Free Call 1800 337 963
Fax (03) 9518 3895

NEW SOUTH WALES - MOFFAT PTY

Unit 8/142 James Ruse Drive
Rosehill NSW 2142
Spare Parts

Free Call 1800 337 963
Fax (03) 9518 3895

QUEENSLAND - MOFFAT PTY

30 Prosperity Place
Geebung QLD 4034
Spare Parts

Free Call 1800 337 963
Fax (03) 9518 3895

SOUTH AUSTRALIA - MOFFAT PTY

Suite 8/71 Fullarton Rd
Kent Town SA 5067
Spare Parts

Tel (08) 8431 0522
Free Call 1800 337 963

WESTERN AUSTRALIA - MOFFAT PTY

PO Box 689
Joondalup Business Centre WA 6027
Spare Parts

Tel (08) 9305 8855
Free Call 1800 337 963

**NATIONAL COVERAGE FOR 24 HOUR SERVICE OR MAINTENANCE DIAL
FREE CALL 1800 622 216 (AUSTRALIA ONLY)**

CANADA

Lessard Agencies Limited
PO Box 97
Stn "D"
Toronto, ONT M6P 3J5

Tel (416) 766 2764
Fax (416) 760 0394
Free Call 1 888 537 7273

NEW ZEALAND

CHRISTCHURCH - MOFFAT LTD

16 Osborne St
PO Box 10-001
Christchurch
Spare Parts

Free Call 0800 Moffat
(0800 663 328)

Tel (03) 389 1007
Fax (03) 389 1276

AUCKLAND - MOFFAT LTD

4 Waipuna Road
Mt Wellington
Auckland
Spare Parts

Tel (09) 574 3150
Fax (09) 574 3159

Free Call 0800 Moffat
(0800 663 328)

UNITED KINGDOM

BLUESEAL LTD
Units 6-7 Mount St
Business Park
Birmingham B7 5QU
England

Tel 0121-327 5575
Fax 0121-327 9711

UNITED STATES OF AMERICA

MOFFAT INC.
3765 Champion Blvd
Winston-Salem
NC27115

Tel 1-800-551 8795
Fax 336 661 9546

**NATIONAL COVERAGE FOR SERVICE OR MAINTENANCE DIAL
FREE CALL 1800 551 8795 (USA ONLY)**