

2006 Chevrolet Monte Carlo Owner Manual

Seats and Restraint Systems	1-1	Driving Your Vehicle	4-1
Front Seats	1-2	Your Driving, the Road, and Your Vehicle	4-2
Rear Seats	1-10	Towing	4-34
Safety Belts	1-12	Service and Appearance Care	5-1
Child Restraints	1-30	Service	5-3
Airbag System	1-52	Fuel	5-4
Restraint System Check	1-67	Checking Things Under the Hood	5-10
Features and Controls	2-1	Headlamp Aiming	5-47
Keys	2-2	Bulb Replacement	5-47
Doors and Locks	2-9	Windshield Wiper Blade Replacement	5-52
Windows	2-13	Tires	5-54
Theft-Deterrent Systems	2-15	Appearance Care	5-85
Starting and Operating Your Vehicle	2-18	Vehicle Identification	5-93
Mirrors	2-30	Electrical System	5-94
OnStar [®] System	2-32	Capacities and Specifications	5-100
Universal Home Remote System	2-34	Maintenance Schedule	6-1
Storage Areas	2-39	Maintenance Schedule	6-2
Sunroof	2-40	Customer Assistance and Information	7-1
Instrument Panel	3-1	Customer Assistance and Information	7-2
Instrument Panel Overview	3-4	Reporting Safety Defects	7-14
Climate Controls	3-19	Index	1
Warning Lights, Gages, and Indicators	3-24		
Driver Information Center (DIC)	3-39		
Audio System(s)	3-59		



GENERAL MOTORS, GM, the GM Emblem, CHEVROLET, the CHEVROLET Emblem, and the name MONTE CARLO are registered trademarks of General Motors Corporation.

This manual includes the latest information at the time it was printed. We reserve the right to make changes after that time without further notice. For vehicles first sold in Canada, substitute the name "General Motors of Canada Limited" for Chevrolet Motor Division whenever it appears in this manual.

Keep this manual in the vehicle, so it will be there if it is needed while you are on the road. If the vehicle is sold, leave this manual in the vehicle.

Canadian Owners

A French language copy of this manual can be obtained from your dealer or from:

Helm, Incorporated
P.O. Box 07130
Detroit, MI 48207

How to Use This Manual

Many people read the owner manual from beginning to end when they first receive their new vehicle. If this is done, it can help you learn about the features and controls for the vehicle. Pictures and words work together in the owner manual to explain things.

Index

A good place to quickly locate information about the vehicle is the Index in the back of the manual. It is an alphabetical list of what is in the manual and the page number where it can be found.

Safety Warnings and Symbols

There are a number of safety cautions in this book. We use a box and the word CAUTION to tell about things that could hurt you if you were to ignore the warning.

 **CAUTION:**

These mean there is something that could hurt you or other people.

In the caution area, we tell you what the hazard is. Then we tell you what to do to help avoid or reduce the hazard. Please read these cautions. If you do not, you or others could be hurt.

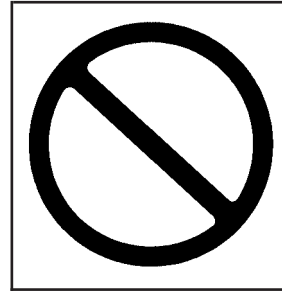

You will also find a circle with a slash through it in this book. This safety symbol means “Do Not,” “Do Not do this” or “Do Not let this happen.”

Vehicle Damage Warnings

Also, in this manual you will find these notices:

Notice: These mean there is something that could damage your vehicle.

A notice tells about something that can damage the vehicle. Many times, this damage would not be covered by your vehicle's warranty, and it could be costly. But the notice will tell what to do to help avoid the damage.

When you read other manuals, you might see CAUTION and NOTICE warnings in different colors or in different words.

There are also warning labels on the vehicle. They use the same words, CAUTION or NOTICE.





























Vehicle Symbols

The vehicle has components and labels that use symbols instead of text. Symbols are shown along with the text describing the operation or information relating to a specific component, control, message, gage, or indicator.

If you need help figuring out a specific name of a component, gage, or indicator, reference the following topics:

- Seats and Restraint Systems in Section 1
- Features and Controls in Section 2
- Instrument Panel Overview in Section 3
- Climate Controls in Section 3
- Warning Lights, Gages, and Indicators in Section 3
- Audio System(s) in Section 3
- Engine Compartment Overview in Section 5

These are some examples of symbols that may be found on the vehicle:

CAUTION POSSIBLE INJURY		LATCH BOTH LAP AND SHOULDER BELTS TO PROTECT OCCUPANT DO NOT TWIST SAFETY BELT WHEN ATTACHING	 	MASTER LIGHTING SWITCH		ENGINE COOLANT TEMP		TIRE PRESSURE	
PROTECT EYES BY SHIELDING		FASTEN SEAT BELTS	 AIRBAG	TURN SIGNALS		BATTERY CHARGING SYSTEM		FUSE BOX ACCESS	
CAUSTIC BATTERY ACID COULD CAUSE BURNS		MOVE SEAT FULLY REARWARD SECURE CHILD SEAT	 DO NOT INSTALL A REAR-FACING CHILD RESTRAINT IN THIS SEATING POSITION	PARKING LAMPS		HAZARD WARNING FLASHER		ENGINE COOLANT FAN	
AVOID SPARKS OR FLAMES		PULL BELT OUT COMPLETELY THEN SECURE CHILD SEAT	 DO NOT INSTALL A FORWARD-FACING CHILD RESTRAINT IN THIS SEATING POSITION	HAZARD WARNING FLASHER		COOLANT		FUEL	
SPARK OR FLAME COULD EXPLODE BATTERY		POWER WINDOW	 DO NOT INSTALL A FORWARD-FACING CHILD RESTRAINT IN THIS SEATING POSITION	DAYTIME RUNNING LAMPS		ENGINE OIL PRESSURE		OWNER'S MANUAL	
			DOOR LOCK UNLOCK	FOG LAMPS		ANTI-LOCK BRAKES		SERVICE MANUAL	



NOTES

Section 1 Seats and Restraint Systems

Front Seats	1-2	Child Restraints	1-30
Manual Passenger Seat	1-2	Older Children	1-30
Power Seat	1-2	Infants and Young Children	1-32
Manual Lumbar	1-3	Child Restraint Systems	1-36
Heated Seats	1-4	Where to Put the Restraint	1-39
Reclining Seatbacks	1-4	Lower Anchors and Tethers for Children (LATCH)	1-41
Head Restraints	1-7	Securing a Child Restraint in a Rear Seat Position	1-46
Seatback Latches	1-8	Securing a Child Restraint in the Right Front Seat Position	1-48
Easy Entry Seat	1-9	Airbag System	1-52
Rear Seats	1-10	Where Are the Airbags?	1-55
Split Folding Rear Seat	1-10	When Should an Airbag Inflate?	1-57
Safety Belts	1-12	What Makes an Airbag Inflate?	1-58
Safety Belts: They Are for Everyone	1-12	How Does an Airbag Restrain?	1-58
Questions and Answers About Safety Belts	1-16	What Will You See After an Airbag Inflates?	1-59
How to Wear Safety Belts Properly	1-17	Passenger Sensing System	1-60
Driver Position	1-18	Servicing Your Airbag-Equipped Vehicle	1-65
Safety Belt Use During Pregnancy	1-24	Adding Equipment to Your Airbag-Equipped Vehicle	1-66
Right Front Passenger Position	1-25	Restraint System Check	1-67
Rear Seat Passengers	1-25	Checking the Restraint Systems	1-67
Rear Safety Belt Comfort Guides	1-27	Replacing Restraint System Parts After a Crash	1-68
Safety Belt Pretensioners	1-29		
Safety Belt Extender	1-30		

Front Seats

Manual Passenger Seat

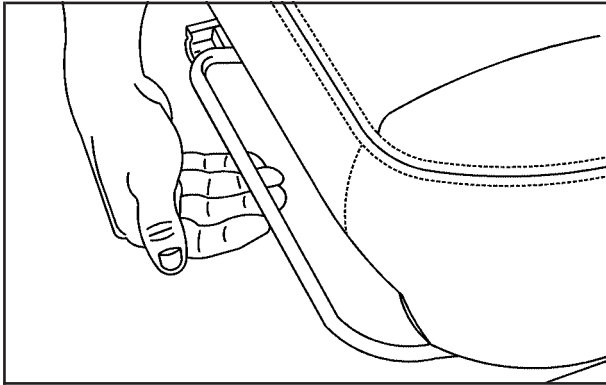

Lift the bar located under the front of the seat to unlock it. Slide the seat to where you want it and release the bar. Try to move the seat with your body to be sure the seat is locked in place.

Power Seat

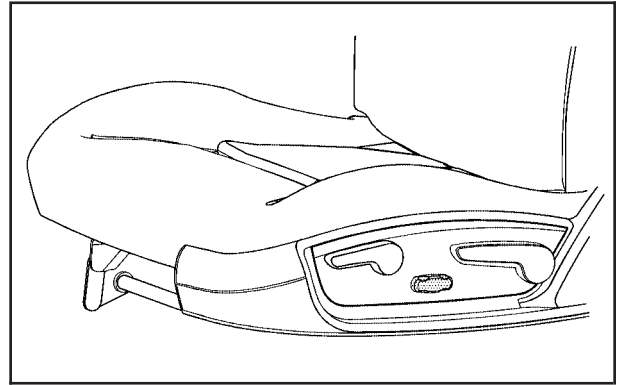

Driver's Seat with Manual Lumbar, Power Seat Control and Manual Recline shown

Your vehicle has a power driver's seat. The control is located on the outboard side of the seat cushion.

To adjust the seat, do any of the following:

- Move the seat forward or rearward by sliding the control forward or rearward.
- Raise or lower the front part of the seat cushion by moving the front of the control up or down.
- Raise or lower the rear part of the seat cushion by moving the rear of the control up or down.

Manual Lumbar

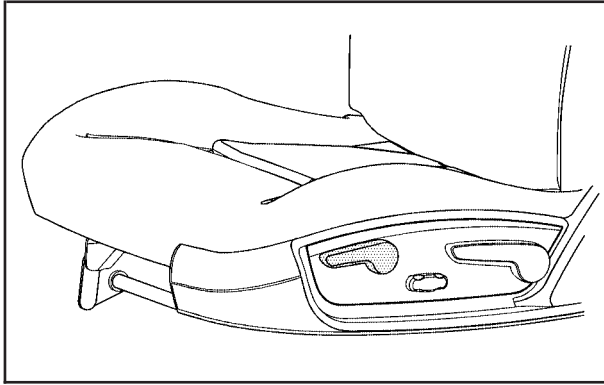

Driver's Seat with Manual Lumbar, Power Seat Control, and Manual Recline shown

The driver's seat has manual lumbar. The lever is located on the outboard side of the seat near the front of the seat cushion. Lift up on the lever repeatedly to increase lumbar support. Push down on the lever repeatedly to decrease lumbar support.

Heated Seats

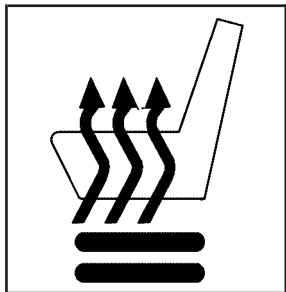

If your vehicle has this feature, the buttons that control temperature for the driver's and front passenger's seats are located on the climate control panel. See *Climate Control System* on page 3-19.

Press the button once to warm the seat to a high temperature. Both lights below the heated seat symbol will come on. Press the button a second time to reduce the seat to a lower temperature. The bottom light will be lit. Press the button a third time to turn the heated seat off.

The heated seat feature will need to be turned on each time the ignition is turned off and back on again.

Reclining Seatbacks

CAUTION:

If the seatback is not locked, it could move forward in a sudden stop or crash. That could cause injury to the person sitting there. Always push and pull on the seatback to be sure it is locked.

Your seats have manual reclining seatbacks. The lever used to operate them is located on the outboard side of the seats.

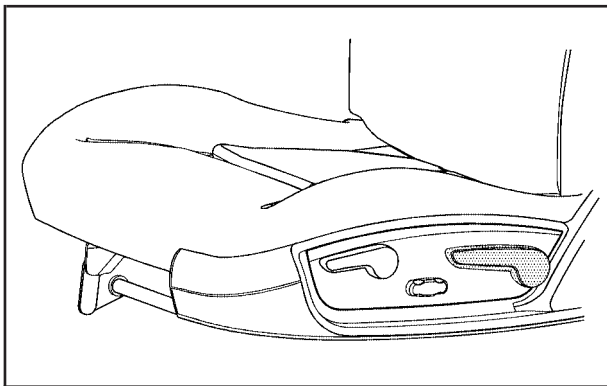

Driver's Seat with Manual Lumbar, Power Seat Control, and Manual Recline shown

To recline the seatback, do the following:

1. Lift the recline lever.
2. Move the seatback to the desired position, then release the lever to lock the seatback in place.
3. Push and pull on the seatback to make sure it is locked.

To return the seatback to an upright position, do the following:

1. Lift the lever fully without applying pressure to the seatback and the seatback will return to the upright position.

⚠ CAUTION:

If the seatback is not locked, it could move forward in a sudden stop or crash. That could cause injury to the person sitting there. Always push and pull on the seatback to be sure it is locked.

2. Push and pull on the seatback to make sure it is locked.

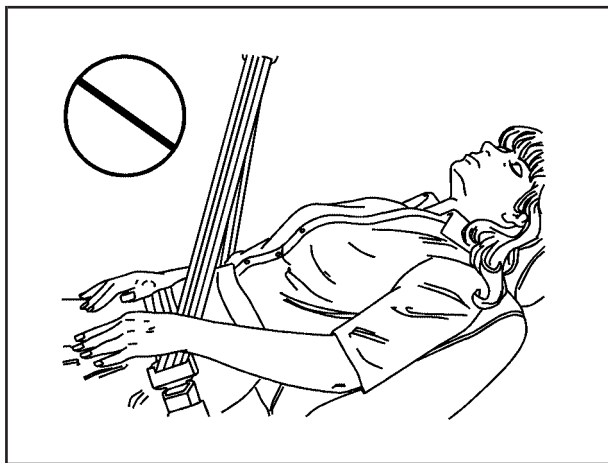

⚠ CAUTION:

Sitting in a reclined position when your vehicle is in motion can be dangerous. Even if you buckle up, your safety belts cannot do their job when you are reclined like this.

The shoulder belt cannot do its job because it will not be against your body. Instead, it will be in front of you. In a crash, you could go into it, receiving neck or other injuries.

The lap belt cannot do its job either. In a crash, the belt could go up over your abdomen. The belt forces would be there, not at your pelvic bones. This could cause serious internal injuries.

For proper protection when the vehicle is in motion, have the seatback upright. Then sit well back in the seat and wear your safety belt properly.

Do not have a seatback reclined if your vehicle is moving.

Head Restraints

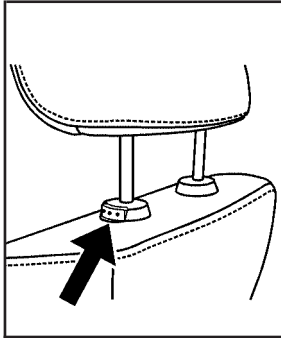

Press the button on the side of the head restraint to lower it.

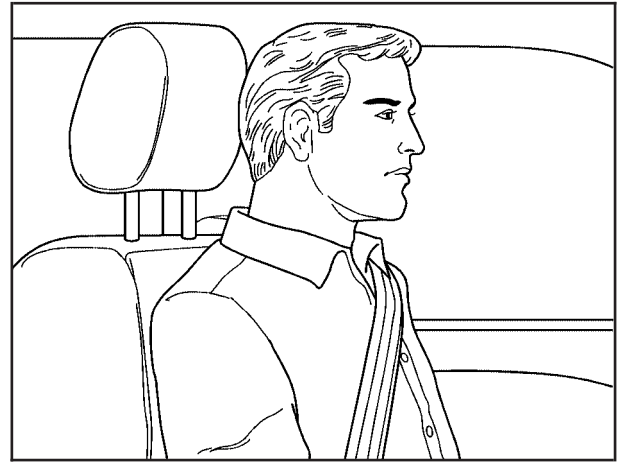

Adjust your head restraint so that the top of the restraint is closest to the top of your head. This position reduces the chance of a neck injury in a crash.

Seatback Latches

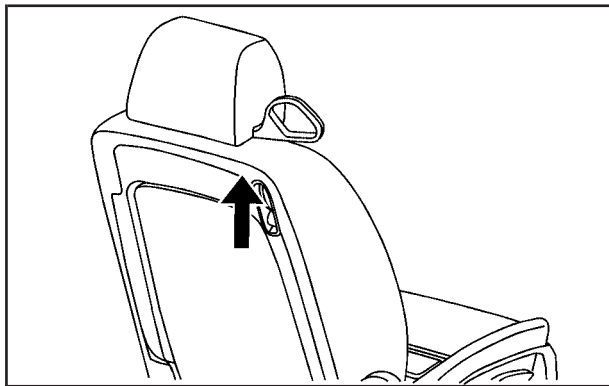

Passenger's Seat shown, Driver's Seat similar

There is a lever located on the back of both front seats near the top on the outboard side.

These are used to fold the seatbacks forward for easy entry and exit of the rear seats. The front passenger's seat has an easy entry feature which allows the entire seat to move forward. See *Easy Entry Seat on page 1-9*.

To fold the seatback forward, lift the lever and push the seatback forward.

CAUTION:

If the seatback is not locked, it could move forward in a sudden stop or crash. That could cause injury to the person sitting there. Always push and pull on the seatback to be sure it is locked.

To return the seatback to the upright position, push the seatback rearward until it locks in place. Push and pull on the seatback to make sure it is locked.

Easy Entry Seat

The front passenger seat is designed to make it easy to get into and out of the rear seat.

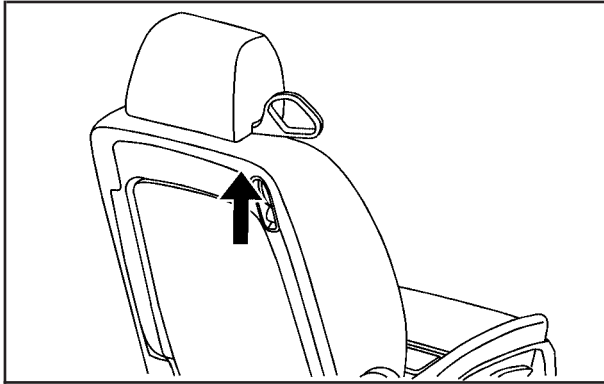

1. Lift the lever on the back of the right front seat and tilt the seatback forward.
2. Push on the seatback to slide the seat forward. The seat is now in the position for easy entry/exit.
3. Return the seatback to the upright position to lock it. Slide the seat fully rearward to lock it into its original position.

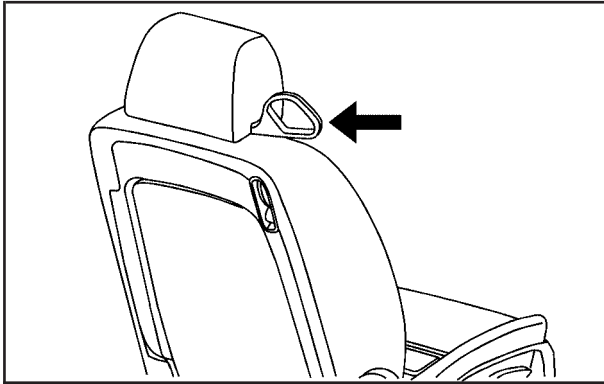

4. Make sure the safety belt is routed correctly through the front safety belt guide.

CAUTION:

If the easy entry right front seat is not locked, it can move. In a sudden stop or crash, the person sitting there could be injured. After you have used it, be sure to push rearward on an easy entry seat to be sure it is locked.

5. Try to slide the entire seat back and forth to make sure the seat is locked into place.

Rear Seats

Split Folding Rear Seat

If your vehicle has this feature, you can fold either side of the seatback down for more cargo space. Make sure the front seat is not reclined. If it is, the rear seatback will not fold down all the way.

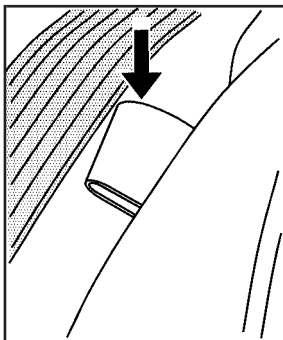

To lower the rear seatback, pull forward on the seat tab located on the outboard side of the seatback cushion and fold the seatback down. This will allow you direct access to the trunk.

To raise the rear seatback, follow these steps:

1. Raise the seatback up and make sure it latches.
2. Push and pull on the seatback to be sure it is locked in position.
3. Ensure that the safety belts are properly stowed over the seatback in all three positions.

⚠ CAUTION:

A safety belt that is improperly routed, not properly attached, or twisted will not provide the protection needed in a crash. The person wearing the belt could be seriously injured. After raising the rear seatback, always check to be sure that the safety belts are properly routed and attached, and are not twisted.

⚠ CAUTION:

If the seatback is not locked, it could move forward in a sudden stop or crash. That could cause injury to the person sitting there. Always push and pull on the seatback to be sure it is locked.

When the seat is not in use, it should be kept in the upright locked position.

Safety Belts

Safety Belts: They Are for Everyone

This part of the manual tells you how to use safety belts properly. It also tells you some things you should not do with safety belts.

CAUTION:

Do not let anyone ride where he or she cannot wear a safety belt properly. If you are in a crash and you are not wearing a safety belt, your injuries can be much worse. You can hit things inside the vehicle or be ejected from it. You can be seriously injured or killed. In the same crash, you might not be, if you are buckled up. Always fasten your safety belt, and check that your passengers' belts are fastened properly too.

CAUTION:

It is extremely dangerous to ride in a cargo area, inside or outside of a vehicle. In a collision, people riding in these areas are more likely to be seriously injured or killed. Do not allow people to ride in any area of your vehicle that is not equipped with seats and safety belts. Be sure everyone in your vehicle is in a seat and using a safety belt properly.

Your vehicle has indicators to remind you and your passengers to buckle your safety belts. See *Safety Belt Reminder Light* on page 3-26 and *Passenger Safety Belt Reminder Light* on page 3-27.

In most states and in all Canadian provinces, the law says to wear safety belts. Here is why: *They work.*

You never know if you will be in a crash. If you do have a crash, you do not know if it will be a bad one.

A few crashes are mild, and some crashes can be so serious that even buckled up, a person would not survive. But most crashes are in between. In many of them, people who buckle up can survive and sometimes walk away. Without belts they could have been badly hurt or killed.

After more than 30 years of safety belts in vehicles, the facts are clear. In most crashes buckling up does matter...a lot!

Why Safety Belts Work

When you ride in or on anything, you go as fast as it goes.

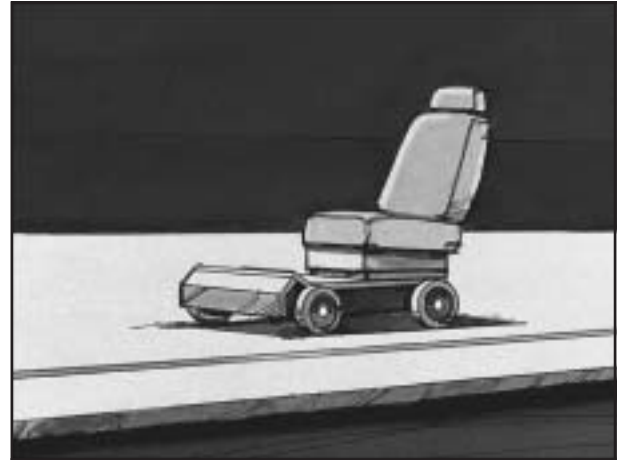

Take the simplest vehicle. Suppose it is just a seat on wheels.



Put someone on it.

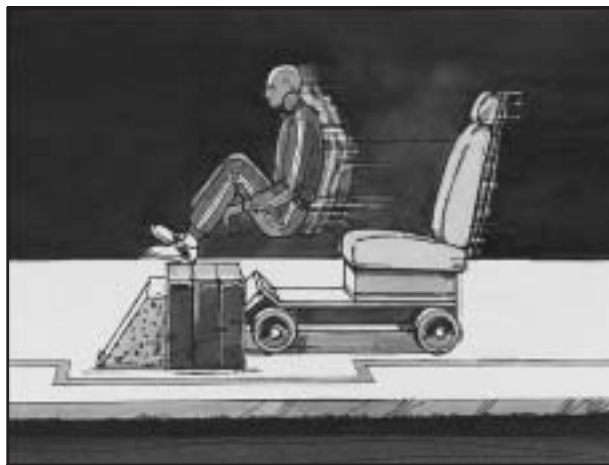

Get it up to speed. Then stop the vehicle. The rider does not stop.



The person keeps going until stopped by something. In a real vehicle, it could be the windshield...



or the instrument panel...



Questions and Answers About Safety Belts

- Q:** Will I be trapped in the vehicle after an accident if I am wearing a safety belt?
- A:** You *could* be — whether you are wearing a safety belt or not. But you can unbuckle a safety belt, even if you are upside down. And your chance of being conscious during and after an accident, so you *can* unbuckle and get out, is *much* greater if you are belted.

or the safety belts!

With safety belts, you slow down as the vehicle does. You get more time to stop. You stop over more distance, and your strongest bones take the forces. That is why safety belts make such good sense.

Q: If my vehicle has airbags, why should I have to wear safety belts?

A: Airbags are in many vehicles today and will be in most of them in the future. But they are supplemental systems only; so they work *with* safety belts — not instead of them. Every airbag system ever offered for sale has required the use of safety belts. Even if you are in a vehicle that has airbags, you still have to buckle up to get the most protection. That is true not only in frontal collisions, but especially in side and other collisions.

Q: If I am a good driver, and I never drive far from home, why should I wear safety belts?

A: You may be an excellent driver, but if you are in an accident — even one that is not your fault — you and your passengers can be hurt. Being a good driver does not protect you from things beyond your control, such as bad drivers.

Most accidents occur within 25 miles (40 km) of home. And the greatest number of serious injuries and deaths occur at speeds of less than 40 mph (65 km/h).

Safety belts are for everyone.

How to Wear Safety Belts Properly

This part is only for people of adult size.

Be aware that there are special things to know about safety belts and children. And there are different rules for smaller children and babies. If a child will be riding in your vehicle, see *Older Children on page 1-30* or *Infants and Young Children on page 1-32*. Follow those rules for everyone's protection.

First, you will want to know which restraint systems your vehicle has.

We will start with the driver position.

Driver Position

Lap-Shoulder Belt

The driver has a lap-shoulder belt. Here is how to wear it properly.

1. Close and lock the door.
2. Adjust the seat so you can sit up straight. To see how, see “Seats” in the Index.

If the safety belt is not routed through the guide on the head restraint, slide the edge of the belt webbing through the opening on the guide. Be sure the belt is not twisted.

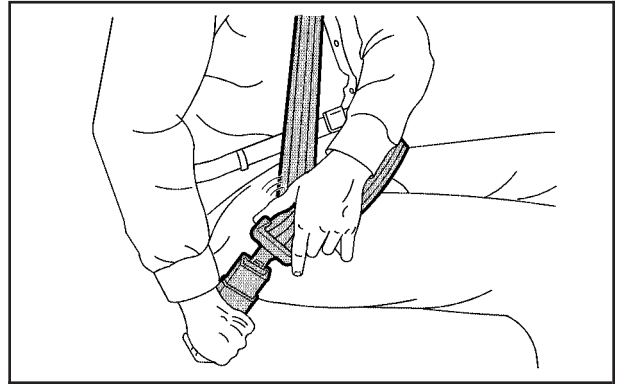

3. Pick up the latch plate and pull the belt across you. Do not let it get twisted.

The shoulder belt may lock if you pull the belt across you very quickly. If this happens, let the belt go back slightly to unlock it. Then pull the belt across you more slowly.

4. Push the latch plate into the buckle until it clicks.

Pull up on the latch plate to make sure it is secure. If the belt is not long enough, see *Safety Belt Extender* on page 1-30.

Make sure the release button on the buckle is positioned so you would be able to unbuckle the safety belt quickly if you ever had to.

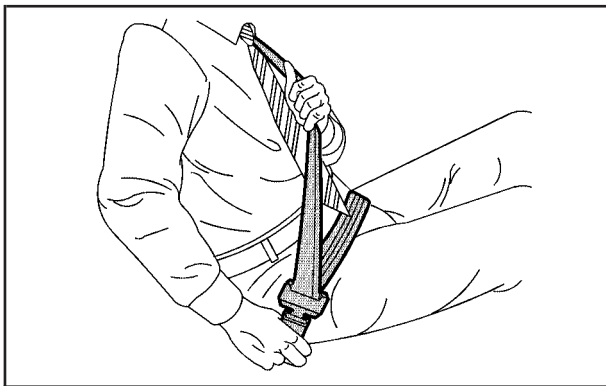

5. To make the lap part tight, pull up on the shoulder belt.

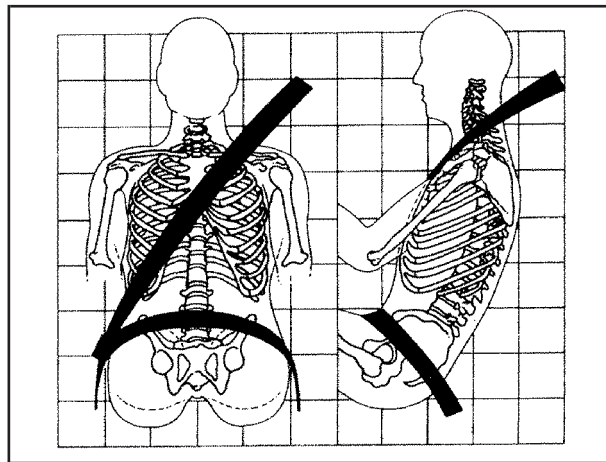

The lap part of the belt should be worn low and snug on the hips, just touching the thighs. In a crash, this applies force to the strong pelvic bones. And you would be less likely to slide under the lap belt. If you slid under it, the belt would apply force at your abdomen. This could cause serious or even fatal injuries. The shoulder belt should go over the shoulder and across the chest. These parts of the body are best able to take belt restraining forces.

The safety belt locks if there is a sudden stop or crash, or if you pull the belt very quickly out of the retractor.

Q: What is wrong with this?

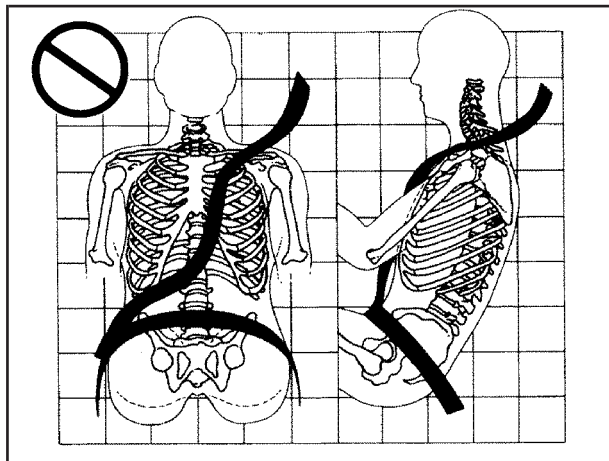

A: The shoulder belt is too loose. It will not give nearly as much protection this way.

⚠ CAUTION:

You can be seriously hurt if your shoulder belt is too loose. In a crash, you would move forward too much, which could increase injury. The shoulder belt should fit against your body.

Q: What is wrong with this?

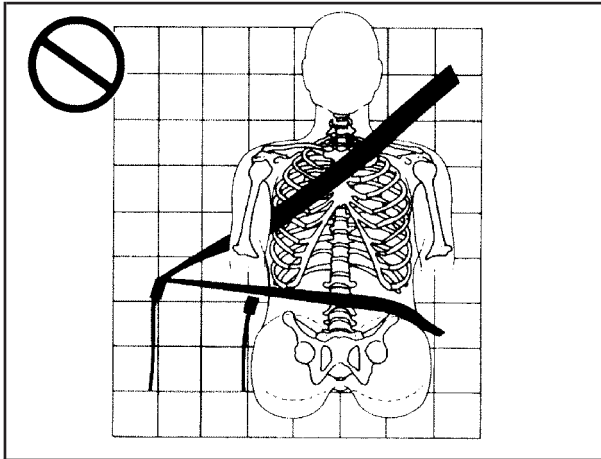

A: The belt is buckled in the wrong place.

⚠ CAUTION:

You can be seriously injured if your belt is buckled in the wrong place like this. In a crash, the belt would go up over your abdomen. The belt forces would be there, not at the pelvic bones. This could cause serious internal injuries. Always buckle your belt into the buckle nearest you.

Q: What is wrong with this?

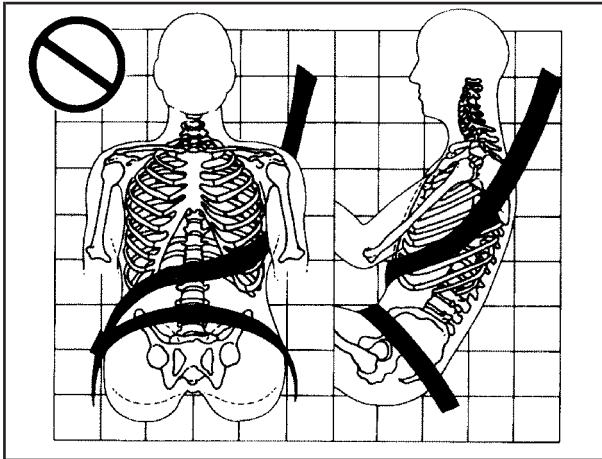

A: The shoulder belt is worn under the arm. It should be worn over the shoulder at all times.

⚠ CAUTION:

You can be seriously injured if you wear the shoulder belt under your arm. In a crash, your body would move too far forward, which would increase the chance of head and neck injury. Also, the belt would apply too much force to the ribs, which are not as strong as shoulder bones. You could also severely injure internal organs like your liver or spleen.

Q: What is wrong with this?

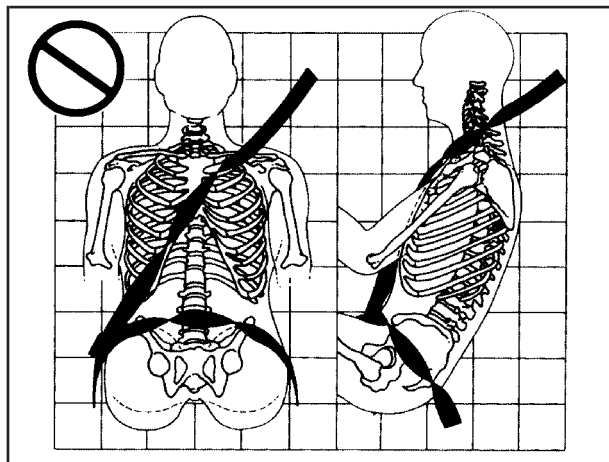

A: The belt is twisted across the body.

⚠ CAUTION:

You can be seriously injured by a twisted belt. In a crash, you would not have the full width of the belt to spread impact forces. If a belt is twisted, make it straight so it can work properly, or ask your dealer to fix it.

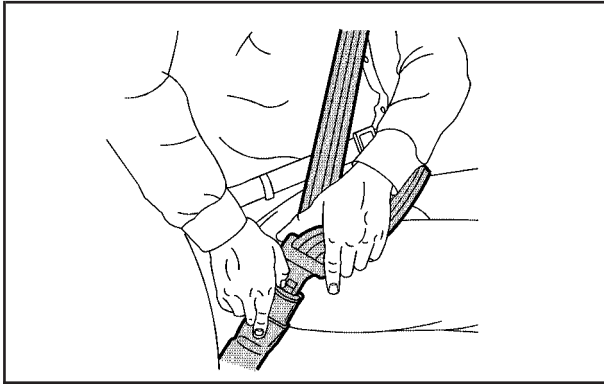

To unlatch the belt, just push the button on the buckle. The belt should go back out of the way.

Before you close the door, be sure the belt is out of the way. If you slam the door on it, you can damage both the belt and your vehicle.

Safety Belt Use During Pregnancy

Safety belts work for everyone, including pregnant women. Like all occupants, they are more likely to be seriously injured if they do not wear safety belts.

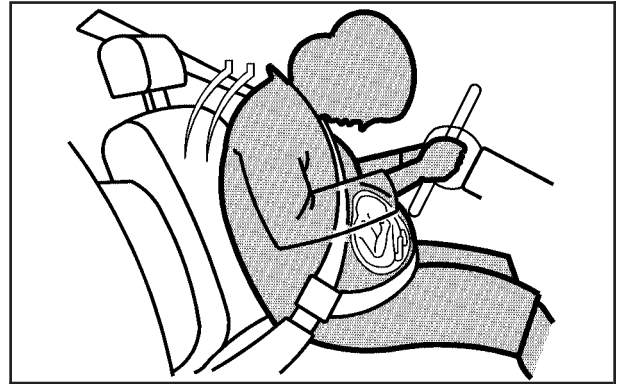

A pregnant woman should wear a lap-shoulder belt, and the lap portion should be worn as low as possible, below the rounding, throughout the pregnancy.

The best way to protect the fetus is to protect the mother. When a safety belt is worn properly, it is more likely that the fetus will not be hurt in a crash. For pregnant women, as for anyone, the key to making safety belts effective is wearing them properly.

Right Front Passenger Position

To learn how to wear the right front passenger's safety belt properly, see *Driver Position on page 1-18*.

The right front passenger's safety belt works the same way as the driver's safety belt — except for one thing. If you ever pull the shoulder portion of the belt out all the way, you will engage the child restraint locking feature. If this happens, just let the belt go back all the way and start again.

Rear Seat Passengers

It is very important for rear seat passengers to buckle up! Accident statistics show that unbelted people in the rear seat are hurt more often in crashes than those who are wearing safety belts.

Rear passengers who are not safety belted can be thrown out of the vehicle in a crash. And they can strike others in the vehicle who are wearing safety belts.

Lap-Shoulder Belt

All rear seat positions have lap-shoulder belts. Here is how to wear one properly.

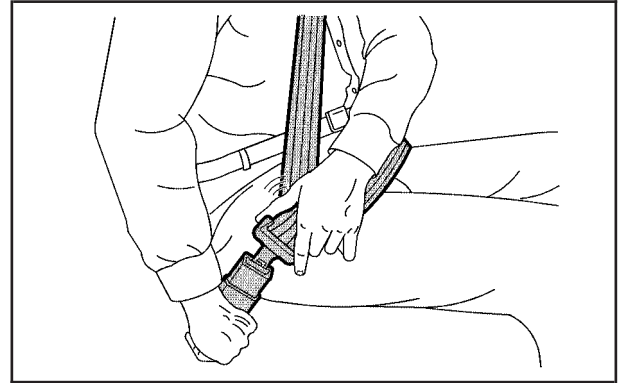

1. Pick up the latch plate and pull the belt across you. Do not let it get twisted.

The shoulder belt may lock if you pull the belt across you very quickly. If this happens, let the belt go back slightly to unlock it. Then pull the belt across you more slowly.

2. Push the latch plate into the buckle until it clicks.
Pull up on the latch plate to make sure it is secure.
When the shoulder belt is pulled out all the way, it will lock. If it does, let it go back all the way and start again.

If the belt is not long enough, see *Safety Belt Extender* on page 1-30.

Make sure the release button on the buckle is positioned so you would be able to unbuckle the safety belt quickly if you ever had to.

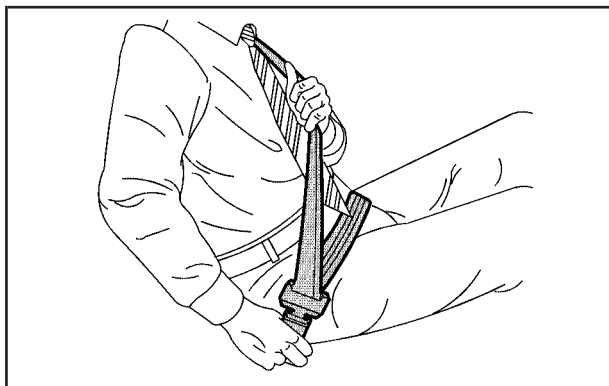

3. To make the lap part tight, pull up on the shoulder part.

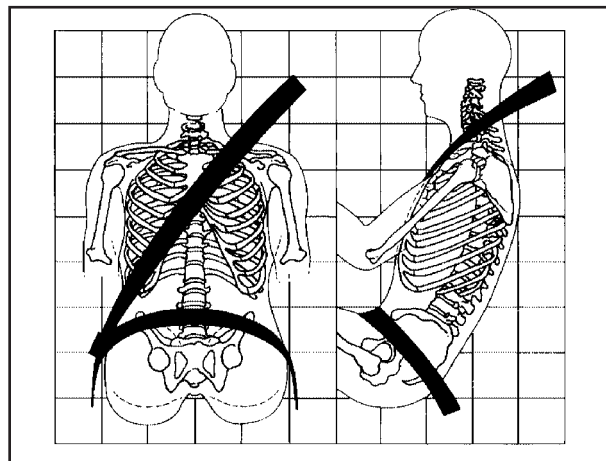

The lap part of the belt should be worn low and snug on the hips, just touching the thighs. In a crash, this applies force to the strong pelvic bones. And you would be less likely to slide under the lap belt. If you slid under it, the belt would apply force at your abdomen. This could cause serious or even fatal injuries. The shoulder belt should go over the shoulder and across the chest. These parts of the body are best able to take belt restraining forces.

The safety belt locks if there is a sudden stop or a crash, or if you pull the belt very quickly out of the retractor.

⚠ CAUTION:

You can be seriously hurt if your shoulder belt is too loose. In a crash, you would move forward too much, which could increase injury. The shoulder belt should fit against your body.

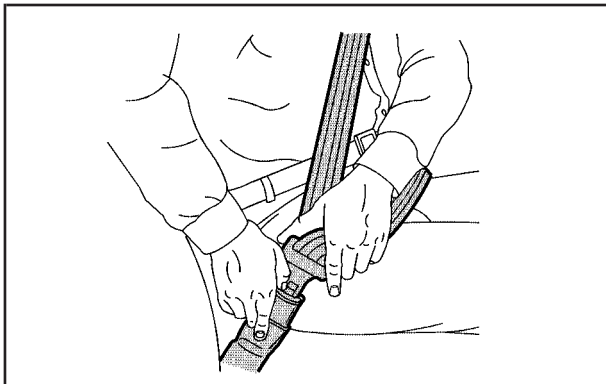

To unlatch the belt, push the button on the buckle.

Rear Safety Belt Comfort Guides

Rear shoulder belt comfort guides may provide added safety belt comfort for older children who have outgrown booster seats and for some adults. When installed on a shoulder belt, the comfort guide positions the belt away from the neck and head.

There is one guide for each outside passenger position in the rear seat. Here is how to install a comfort guide and use the safety belt:

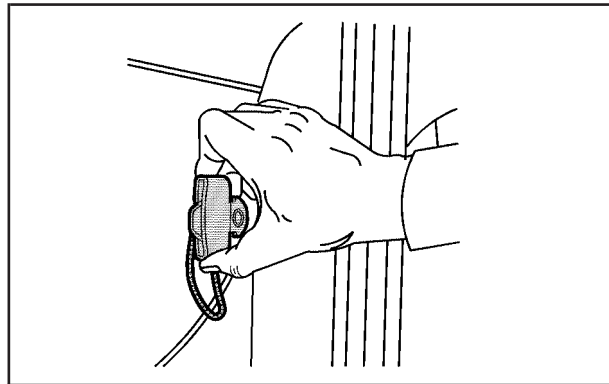

1. Pull the elastic cord out from between the edge of the seatback and the interior body to remove the guide from its storage clip.

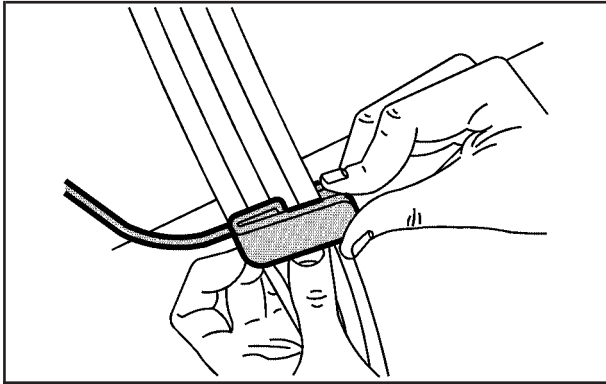

2. Slide the guide under and past the belt. The elastic cord must be under the belt. Then, place the guide over the belt, and insert the two edges of the belt into the slots of the guide.

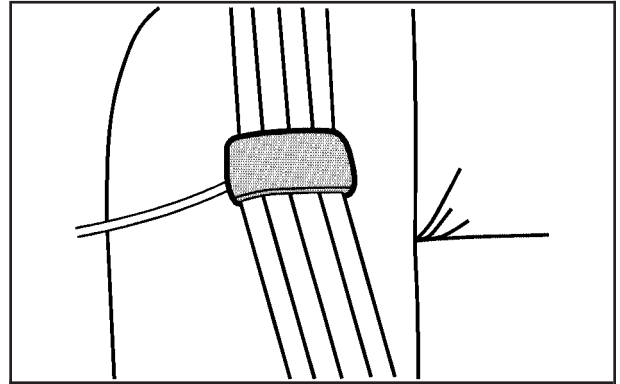

3. Be sure that the belt is not twisted and it lies flat. The elastic cord must be under the belt and the guide on top.

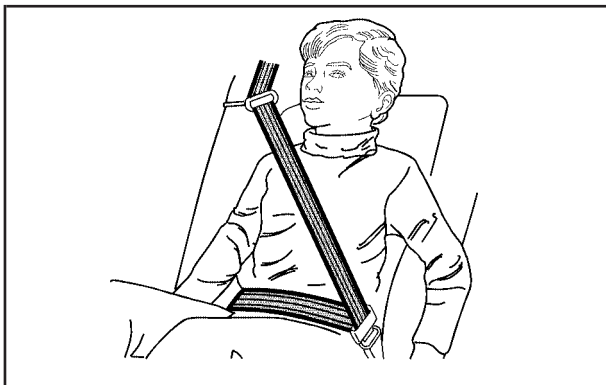

⚠ CAUTION:

A safety belt that is not properly worn may not provide the protection needed in a crash. The person wearing the belt could be seriously injured. The shoulder belt should go over the shoulder and across the chest. These parts of the body are best able to take belt restraining forces.

4. Buckle, position, and release the safety belt as described in *Rear Seat Passengers* on page 1-25. Make sure that the shoulder belt crosses the shoulder.

To remove and store the comfort guides, squeeze the belt edges together so that you can take them out of the guides. Pull the guide upward to expose its storage clip, and then slide the guide onto the clip. Turn the guide and clip inward and in between the seatback and interior body, leaving only the loop of elastic cord exposed.

Safety Belt Pretensioners

Your vehicle has safety belt pretensioners for the driver and right front passenger. Although you cannot see them, they are located on the retractor part of the safety belts. They help the safety belts reduce a person's forward movement in a moderate to severe frontal or near frontal crash.

Pretensioners work only once. If they activate in a crash, you will need to get new ones, and probably other new parts for your safety belt system. See *Replacing Restraint System Parts After a Crash* on page 1-68.

Safety Belt Extender

If the vehicle's safety belt will fasten around you, you should use it.

But if a safety belt is not long enough, your dealer will order you an extender. It is free. When you go in to order it, take the heaviest coat you will wear, so the extender will be long enough for you. To help avoid personal injury, do not let someone else use it, and use it only for the seat it is made to fit. The extender has been designed for adults. Never use it for securing child seats. To wear it, just attach it to the regular safety belt. For more information, see the instruction sheet that comes with the extender.

Child Restraints

Older Children

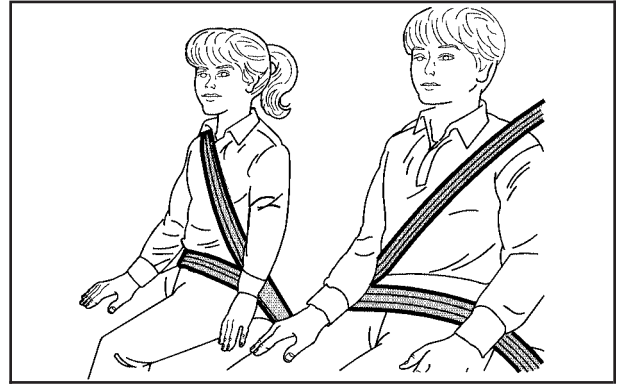

Older children who have outgrown booster seats should wear the vehicle's safety belts.

Q: What is the proper way to wear safety belts?

A: An older child should wear a lap-shoulder belt and get the additional restraint a shoulder belt can provide. The shoulder belt should not cross the face or neck. The lap belt should fit snugly below the hips, just touching the top of the thighs. It should never be worn over the abdomen, which could cause severe or even fatal internal injuries in a crash.

Accident statistics show that children are safer if they are restrained in the rear seat.

In a crash, children who are not buckled up can strike other people who are buckled up, or can be thrown out of the vehicle. Older children need to use safety belts properly.



⚠ CAUTION:

Never do this.

Here two children are wearing the same belt. The belt can not properly spread the impact forces. In a crash, the two children can be crushed together and seriously injured. A belt must be used by only one person at a time.

Q: What if a child is wearing a lap-shoulder belt, but the child is so small that the shoulder belt is very close to the child's face or neck?

A: If the child is sitting in a seat next to a window, move the child toward the center of the vehicle. Also see *Rear Safety Belt Comfort Guides on page 1-27*. If the child is sitting in the center rear seat passenger position, move the child toward the safety belt buckle. In either case, be sure that the shoulder belt still is on the child's shoulder, so that in a crash the child's upper body would have the restraint the belts provide.



CAUTION:

Never do this.

Here a child is sitting in a seat that has a lap-shoulder belt, but the shoulder part is behind the child. If the child wears the belt in this way, in a crash the child might slide under the belt. The belt's force would then be applied right on the child's abdomen. That could cause serious or fatal injuries.

Wherever the child sits, the lap portion of the belt should be worn low and snug on the hips, just touching the child's thighs. This applies belt force to the child's pelvic bones in a crash.

Infants and Young Children

Everyone in a vehicle needs protection! This includes infants and all other children. Neither the distance traveled nor the age and size of the traveler changes the need, for everyone, to use safety restraints. In fact, the law in every state in the United States and in every Canadian province says children up to some age must be restrained while in a vehicle.

Every time infants and young children ride in vehicles, they should have the protection provided by appropriate restraints. Young children should not use the vehicle's adult safety belts alone, unless there is no other choice. Instead, they need to use a child restraint.

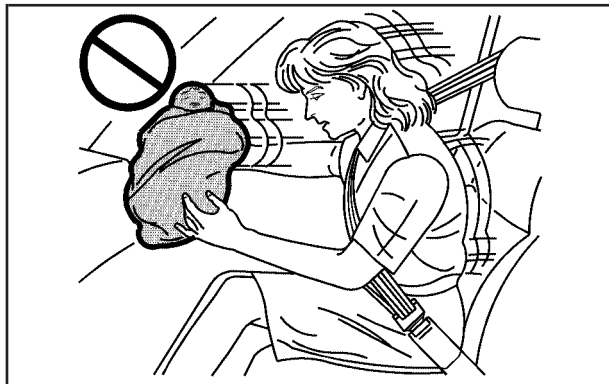

CAUTION:

People should never hold a baby in their arms while riding in a vehicle. A baby does not weigh much — until a crash. During a crash a baby will become so heavy it is not possible to hold it. For example, in a crash at only 25 mph (40 km/h), a 12 lb (5.5 kg) baby will suddenly become a 240 lb (110 kg) force on a person's arms. A baby should be secured in an appropriate restraint.

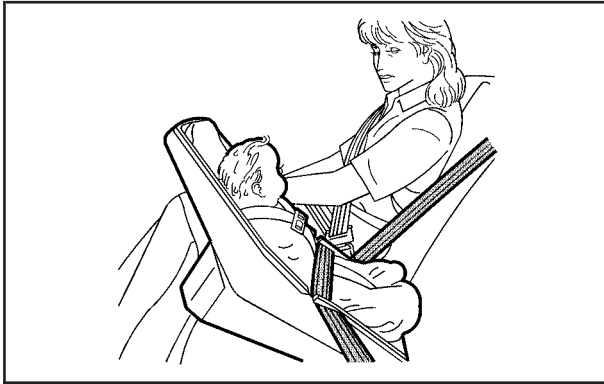

⚠ CAUTION:

Children who are up against, or very close to, any airbag when it inflates can be seriously injured or killed. Airbags plus lap-shoulder belts offer protection for adults and older children, but not for young children and infants. Neither the vehicle's safety belt system nor its airbag system is designed for them. Young children and infants need the protection that a child restraint system can provide.

Q: What are the different types of add-on child restraints?

A: Add-on child restraints, which are purchased by the vehicle's owner, are available in four basic types. Selection of a particular restraint should take into consideration not only the child's weight, height and age but also whether or not the restraint will be compatible with the motor vehicle in which it will be used.

For most basic types of child restraints, there are many different models available. When purchasing a child restraint, be sure it is designed to be used in a motor vehicle. If it is, the restraint will have a label saying that it meets federal motor vehicle safety standards.

The restraint manufacturer's instructions that come with the restraint, state the weight and height limitations for a particular child restraint. In addition, there are many kinds of restraints available for children with special needs.

 **CAUTION:**

Newborn infants need complete support, including support for the head and neck. This is necessary because a newborn infant's neck is weak and its head weighs so much compared with the rest of its body. In a crash, an infant in a rear-facing seat settles into the restraint, so the crash forces can be distributed across the strongest part of an infant's body, the back and shoulders. Infants always should be secured in appropriate infant restraints.

 **CAUTION:**

The body structure of a young child is quite unlike that of an adult or older child, for whom the safety belts are designed. A young child's hip bones are still so small that the vehicle's regular safety belt may not remain low on the hip bones, as it should. Instead, it may settle up around the child's abdomen. In a crash, the belt would apply force on a body area that is unprotected by any bony structure. This alone could cause serious or fatal injuries. Young children always should be secured in appropriate child restraints.

Child Restraint Systems

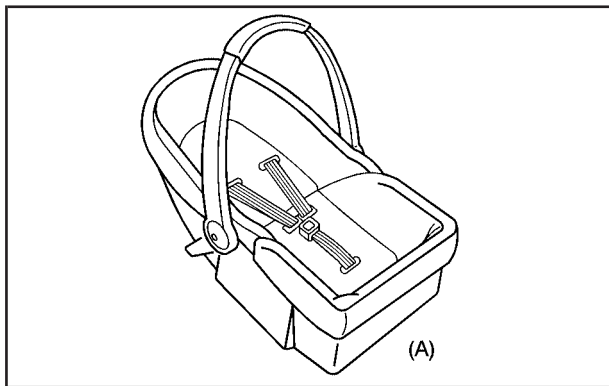

An infant car bed (A), a special bed made for use in a motor vehicle, is an infant restraint system designed to restrain or position a child on a continuous flat surface. Make sure that the infant's head rests toward the center of the vehicle.

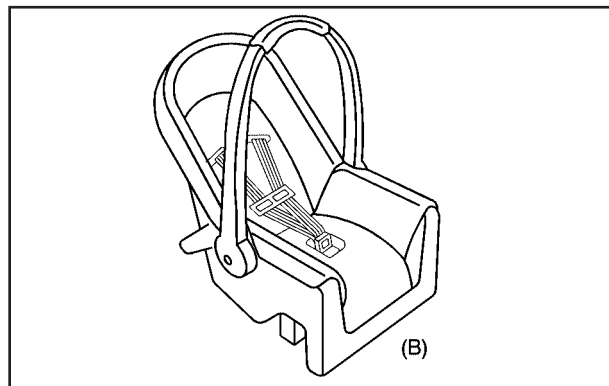

A rear-facing infant seat (B) provides restraint with the seating surface against the back of the infant. The harness system holds the infant in place and, in a crash, acts to keep the infant positioned in the restraint.

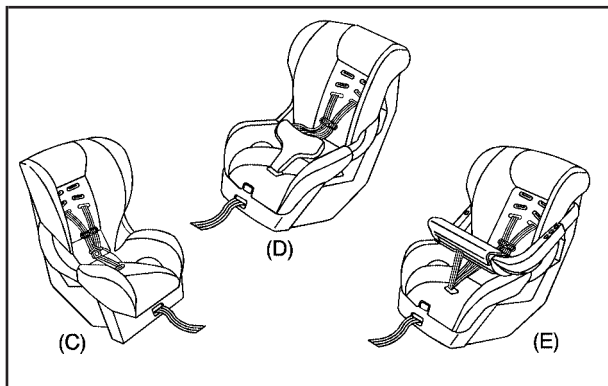

A forward-facing child seat (C-E) provides restraint for the child's body with the harness and also sometimes with surfaces such as T-shaped or shelf-like shields.

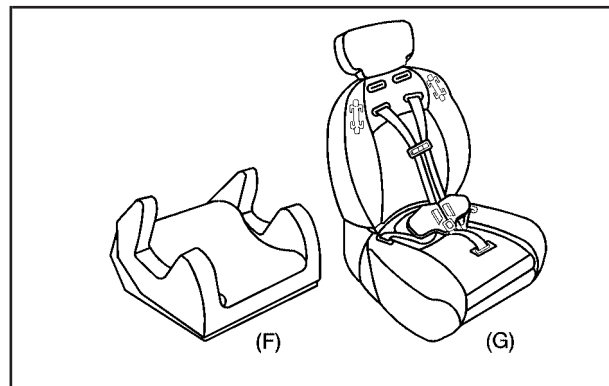

A booster seat (F-G) is a child restraint designed to improve the fit of the vehicle's safety belt system. Some booster seats have a shoulder belt positioner, and some high-back booster seats have a five-point harness. A booster seat can also help a child to see out the window.

Q: How Should I Use a Child Restraint?

A: A child restraint system is any device designed for use in a motor vehicle to restrain, seat, or position children. A built-in child restraint system is a permanent part of the motor vehicle. An add-on child restraint system is a portable one, which is purchased by the vehicle's owner. To help reduce injuries, an add-on child restraint must be secured in the vehicle. With built-in or add-on child restraints, the child has to be secured within the child restraint.

When choosing an add-on child restraint, be sure the child restraint is designed to be used in a vehicle. If it is, it will have a label saying that it meets federal motor vehicle safety standards. Then follow the instructions for the restraint. You may find these instructions on the restraint itself or in a booklet, or both.

Securing an Add-on Child Restraint in the Vehicle

CAUTION:

A child can be seriously injured or killed in a crash if the child restraint is not properly secured in the vehicle. Make sure the child restraint is properly installed in the vehicle using the vehicle's safety belt or LATCH system, following the instructions that came with that restraint, and also the instructions in this manual.

To help reduce the chance of injury, the child restraint must be secured in the vehicle. Child restraint systems must be secured in vehicle seats by lap belts or the lap belt portion of a lap-shoulder belt, or by the LATCH system. See *Lower Anchors and Tethers for Children (LATCH)* on page 1-41 for more information. A child can be endangered in a crash if the child restraint is not properly secured in the vehicle.

When securing an add-on child restraint, refer to the instructions that come with the restraint which may be on the restraint itself or in a booklet, or both, and to this manual. The child restraint instructions are important, so if they are not available, obtain a replacement copy from the manufacturer.

Keep in mind that an unsecured child restraint can move around in a collision or sudden stop and injure people in the vehicle. Be sure to properly secure any child restraint in your vehicle — even when no child is in it.

Securing the Child Within the Child Restraint

There are several systems for securing the child within the child restraint. One system, the three-point harness, has straps that come down over each of the infant's shoulders and buckle together at the crotch. The five-point harness system has two shoulder straps, two hip straps, and a crotch strap. A shield may take the place of hip straps. A T-shaped shield has shoulder straps that are attached to a flat pad which rests low against the child's body. A shelf- or armrest-type shield has straps that are attached to a wide, shelf-like shield that swings up or to the side.

CAUTION:

A child can be seriously injured or killed in a crash if the child is not properly secured in the child restraint. Make sure the child is properly secured, following the instructions that came with that restraint.

Because there are different systems, it is important to refer to the instructions that come with the restraint. A child can be endangered in a crash if the child is not properly secured in the child restraint.

Where to Put the Restraint

Accident statistics show that children are safer if they are restrained in the rear rather than the front seat. We, therefore, recommend that child restraints be secured in a rear seat, including an infant riding in a rear-facing infant seat, a child riding in a forward-facing child seat and an older child riding in a booster seat.

Your vehicle has a rear seat that will accommodate a rear-facing child restraint. A label on your sun visor says, "Never put a rear-facing child seat in the front." This is because the risk to the rear-facing child is so great, if the airbag deploys.

 **CAUTION:**

A child in a rear-facing child restraint can be seriously injured or killed if the right front passenger's airbag inflates. This is because the back of the rear-facing child restraint would be very close to the inflating airbag.

Even though the passenger sensing system is designed to turn off the passenger's frontal airbag and side airbag (if equipped) if the system detects a rear-facing child restraint, no system is fail-safe, and no one can guarantee that an airbag will not deploy under some unusual circumstance, even though it is turned off. General Motors recommends that

CAUTION: (Continued)

CAUTION: (Continued)

rear-facing child restraints be secured in the rear seat, even if the airbag or airbags are off.

If you need to secure a forward-facing child restraint in the right front seat, always move the front passenger seat as far back as it will go. It is better to secure the child restraint in a rear seat.

 **CAUTION:**

A child in a child restraint in the center front seat can be badly injured or killed by the right front passenger's airbag if it inflates. Never secure a child restraint in the center front seat. It is always better to secure a child restraint in the rear seat.

Wherever you install a child restraint, be sure to secure the child restraint properly.

Keep in mind that an unsecured child restraint can move around in a collision or sudden stop and injure people in the vehicle. Be sure to properly secure any child restraint in your vehicle — even when no child is in it.

Lower Anchors and Tethers for Children (LATCH)

Your vehicle has the LATCH system. The LATCH system holds a child restraint during driving or in a crash. This system is designed to make installation of a child restraint easier. The LATCH system uses anchors in the vehicle and attachments on the child restraint that are made for use with the LATCH system

Make sure that a LATCH-compatible child restraint is properly installed using the anchors, or use the vehicle's safety belts to secure the restraint, following the instructions that came with that restraint, and also the instructions in this manual. When installing a

child restraint with a top tether, you must also use either the lower anchors or the safety belts to properly secure the child restraint. A child restraint must never be installed using only the top tether and anchor.

In order to use the LATCH system in your vehicle, you need a child restraint equipped with LATCH attachments. The child restraint manufacturer will provide you with instructions on how to use the child restraint and its attachments. The following explains how to attach a child restraint with these attachments in your vehicle.

Your vehicle has lower anchors and top tether anchors. Your child restraint may have lower attachments and a top tether.

Not all vehicle seating positions or child restraints have lower anchors and attachments or top tether anchors and attachments.

Lower Anchors

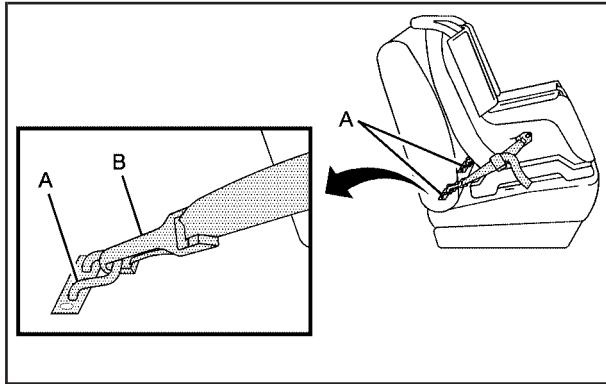

Lower anchors (A) are metal bars built into the vehicle. There are two lower anchors for each LATCH seating position that will accommodate a child restraint with lower attachments (B).

Top Tether Anchor

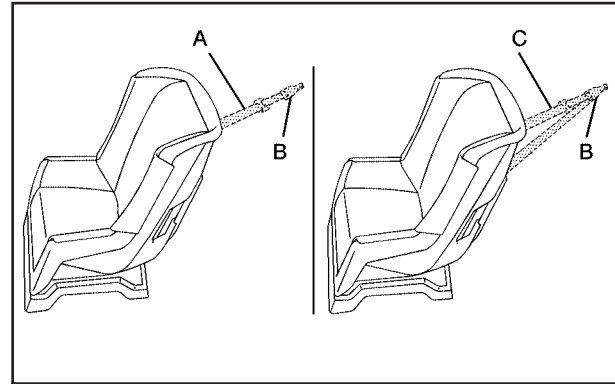

A top tether (A, C) anchors the top of the child restraint to the vehicle. A top tether anchor is built into the vehicle. The top tether attachment (B) on the child restraint connects to the top tether anchor in the vehicle in order to reduce the forward movement and rotation of the child restraint during driving or in a crash.

Your child restraint may have a single tether (A) or a dual tether (C). Either will have a single attachment (B) to secure the top tether to the anchor.

Some top tether-equipped child restraints are designed for use with or without the top tether being attached. Others require the top tether always to be attached. In Canada, the law requires that forward-facing child restraints have a top tether, and that the tether be attached. In the United States, some child restraints also have a top tether. Be sure to read and follow the instructions for your child restraint.

If the child restraint does not have a top tether, one can be obtained, in kit form, for many child restraints. Ask the child restraint manufacturer whether or not a kit is available.

Lower Anchor and Top Tether Anchor Locations

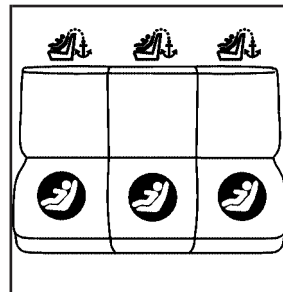

 (Top Tether Anchor):
Seating positions with top
tether anchors.

 (Lower Anchor):
Seating positions with
two lower anchors.

Rear Seat

Each rear seating position has exposed metal lower anchors in the crease between the seatback and the seat cushion.

Securing a Child Restraint Designed for the LATCH System

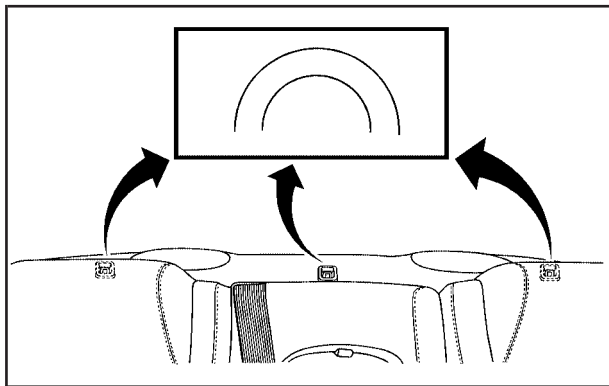

The top tether anchors are located on the rear seatback filler panel. Be sure to use an anchor located on the same side of the vehicle as the seating position where the child restraint will be placed.

Do not secure a child restraint in the right front passenger's position if a national or local law requires that the top tether be attached, or if the instructions that come with the child restraint say that the top tether must be attached. There is no place to attach the top tether in this position.

Accident statistics show that children are safer if they are restrained in the rear rather than the front seat. See *Where to Put the Restraint on page 1-39* for additional information.

CAUTION:

If a LATCH-type child restraint is not attached to anchors, the restraint will not be able to protect the child correctly. In a crash, the child could be seriously injured or killed. Make sure that a LATCH-type child restraint is properly installed using the anchors, or use the vehicle's safety belts to secure the restraint, following the instructions that came with that restraint, and also the instructions in this manual.

⚠ CAUTION:

Each top tether anchor and lower anchor in the vehicle is designed to hold only one child restraint. Attaching more than one child restraint to a single anchor could cause the anchor or attachment to come loose or even break during a crash. A child or others could be injured if this happens. To help prevent injury to people and damage to your vehicle, attach only one child restraint per anchor.

1. Attach and tighten the lower attachments to the lower anchors. If the child restraint does not have lower attachments or the desired seating position does not have lower anchors, secure the child restraint with the top tether and the safety belts. Refer to your child restraint manufacturer instructions and the instructions in this manual.
 - 1.1. Find the lower anchors for the desired seating position.
 - 1.2. Put the child restraint on the seat.
 - 1.3. Attach and tighten the lower attachments on the child restraint to the lower anchors.

2. If the child restraint manufacturer recommends that the top tether be attached, attach and tighten the top tether to the top tether anchor, if equipped. Refer to the child restraint instructions and the following steps:

- 2.1. Find the top tether anchor.
- 2.2. Route, attach, and tighten the top tether according to your child restraint instructions and the following instructions:

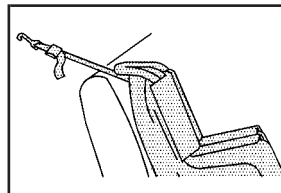

If the position you are using does not have a head restraint and you are using a single tether, route the tether over the seatback.

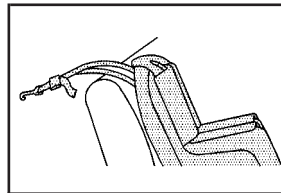

If the position you are using does not have a head restraint and you are using a dual tether, route the tether over the seatback.

3. Push and pull the child restraint in different directions to be sure it is secure.

Securing a Child Restraint in a Rear Seat Position

If your child restraint is equipped with the LATCH system, see *Lower Anchors and Tethers for Children (LATCH)* on page 1-41.

If your child restraint does not have the LATCH system, you will be using the lap-shoulder belt to secure the child restraint in this position. Be sure to follow the instructions that came with the child restraint. Secure the child in the child restraint when and as the instructions say.

1. Put the child restraint on the seat.
2. Pick up the latch plate, and run the lap and shoulder portions of the vehicle's safety belt through or around the restraint. The child restraint instructions will show you how.

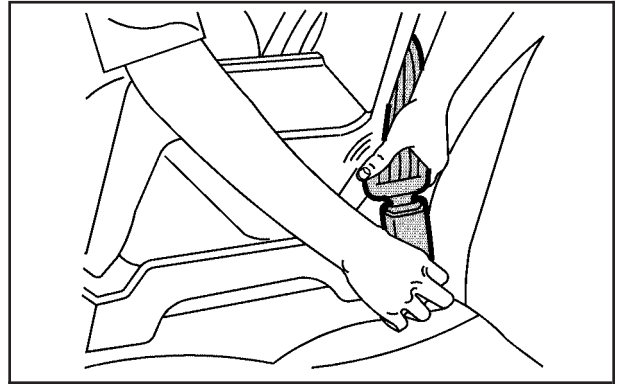

3. Buckle the belt. Make sure the release button is positioned so you would be able to unbuckle the safety belt quickly if you ever had to.

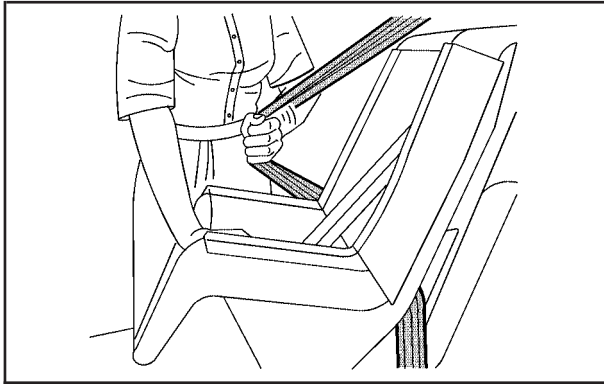

4. Pull the rest of the shoulder belt all the way out of the retractor to set the lock.

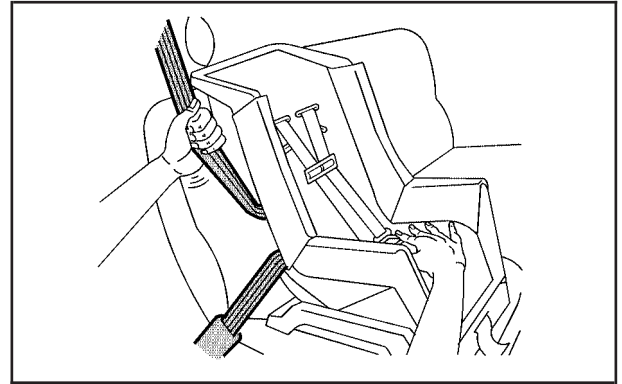

5. To tighten the belt, push down on the child restraint, pull the shoulder portion of the belt to tighten the lap portion of the belt and feed the shoulder belt back into the retractor. If you are using a forward-facing child restraint, you may find it helpful to use your knee to push down on the child restraint as you tighten the belt.

6. If your child restraint manufacturer recommends using a top tether, attach and tighten the top tether to the top tether anchor. Refer to the instructions that came with the child restraint and see *Lower Anchors and Tethers for Children (LATCH)* on page 1-41.
7. Push and pull the child restraint in different directions to be sure it is secure.

To remove the child restraint, if the top tether is attached to the top tether anchor, disconnect it. Unbuckle the vehicle's safety belt and let it go back all the way. The safety belt will move freely again and be ready to work for an adult or larger child passenger.

Securing a Child Restraint in the Right Front Seat Position

Your vehicle has airbags. A rear seat is a safer place to secure a forward-facing child restraint. See *Where to Put the Restraint* on page 1-39.

In addition, your vehicle has the passenger sensing system. The passenger sensing system is designed to turn off the right front passenger's frontal airbag and side impact airbag (if equipped) when an infant in a rear-facing infant seat or a small child in a forward-facing child restraint or booster seat is detected. See *Passenger Sensing System* on page 1-60 and *Passenger Airbag Status Indicator* on page 3-28 for more information on this including important safety information.

A label on your sun visor says, "Never put a rear-facing child seat in the front." This is because the risk to the rear-facing child is so great, if the airbags deploy.

 **CAUTION:**

A child in a rear-facing child restraint can be seriously injured or killed if the right front passenger's airbag inflates. This is because the back of the rear-facing child restraint would be very close to the inflating airbag.

Even though the passenger sensing system is designed to turn off the passenger's frontal airbag and side airbag (if equipped), if the system detects a rear-facing child restraint, no system is fail-safe, and no one can guarantee that an airbag or airbags will not deploy under some unusual circumstance, even though it is turned off. General Motors recommends that rear-facing child restraints be secured in the rear seat, even if the airbag or airbags are off.

If you need to secure a forward-facing child restraint in the right front seat position, move the seat as far back as it will go before securing the forward-facing child restraint. See *Manual Passenger Seat on page 1-2* or *Power Seat on page 1-2*.

If your child restraint is equipped with the LATCH system, see *Lower Anchors and Tethers for Children (LATCH) on page 1-41*.

There is no top tether anchor in the right front passenger's position. Do not secure a child seat in this position if a national or local law requires that the top tether be anchored, or if the instructions that come with the child restraint say that the top tether must be anchored. See *Lower Anchors and Tethers for Children (LATCH) on page 1-41* if the child restraint has a top tether.

You will be using the lap-shoulder belt to secure the child restraint in this position. Be sure to follow the instructions that came with the child restraint. Secure the child in the child restraint when and as the instructions say.

1. Your vehicle has airbags. See *Passenger Sensing System on page 1-60*. General Motors recommends that rear-facing child restraints be secured in a rear seat, even if the airbag or airbags are off. If your child restraint is forward-facing, move the seat as far back as it will go before securing the child restraint in this seat. See *Manual Passenger Seat on page 1-2* or *Power Seat on page 1-2*.

When the passenger sensing system has turned off the right front passenger's frontal airbag and side impact airbag (if equipped), the off indicator in the passenger airbag status indicator should light and stay lit when you turn the ignition to RUN or START. See *Passenger Airbag Status Indicator on page 3-28*.

2. Put the child restraint on the seat.
3. Remove the safety belt from the guide on the head restraint by sliding the webbing through the opening on the guide. Do not secure the child restraint with the safety belt routed through the guide.

4. Pick up the latch plate, and run the lap and shoulder portions of the vehicle's safety belt through or around the restraint. The child restraint instructions will show you how.

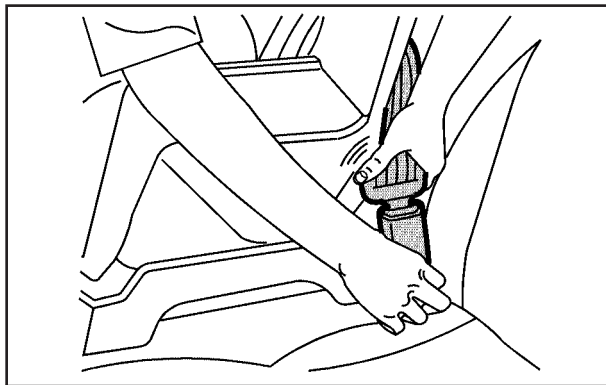

5. Buckle the belt. Make sure the release button is positioned so you would be able to unbuckle the safety belt quickly if you ever had to.

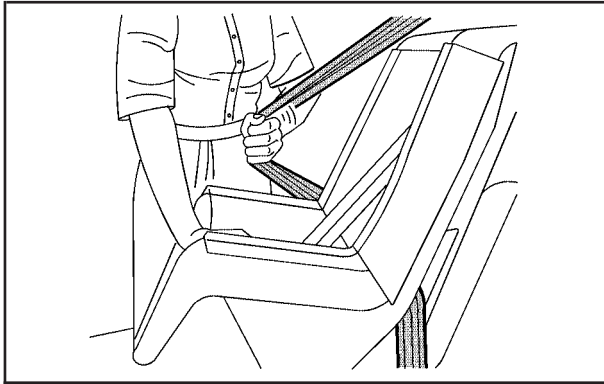

6. Pull the rest of the shoulder belt all the way out of the retractor to set the lock.

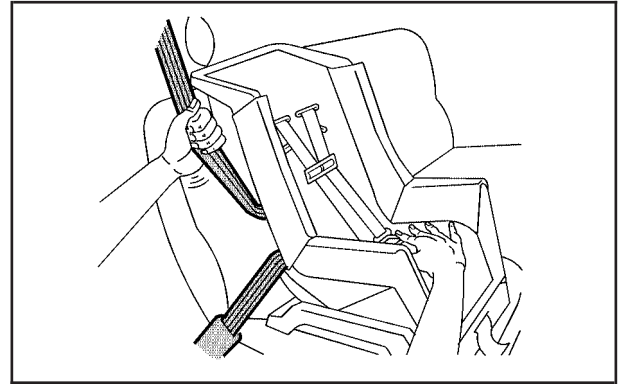

7. To tighten the belt, push down on the child restraint, pull the shoulder portion of the belt to tighten the lap portion of the belt and feed the shoulder belt back into the retractor. If you are using a forward-facing child restraint, you may find it helpful to use your knee to push down on the child restraint as you tighten the belt. You should not be able to pull more of the belt from the retractor once the lock has been set.
8. Push and pull the child restraint in different directions to be sure it is secure.
9. If the airbag or airbags are off, the off indicator on the overhead console will be lit and stay lit when the key is turned to RUN or START.

If a child restraint has been installed and the on indicator is lit, turn the vehicle off. Remove the child restraint from the vehicle and reinstall the child restraint.

If after reinstalling the child restraint and restarting the vehicle, the on indicator is still lit, check to make sure that the vehicle's seatback is not pressing the child restraint into the seat cushion. If this happens, slightly recline the vehicle's seatback and adjust the seat cushion if possible. Also make sure the child restraint is not trapped under the vehicle head restraint. If this happens, adjust the head restraint.

If the on indicator is still lit, secure the child in the child restraint in a rear seat position in the vehicle and check with your dealer.

To remove the child restraint, just unbuckle the vehicle's safety belt and let it go back all the way. The safety belt will move freely again and be ready to work for an adult or larger child passenger.

Insert the safety belt into the guide on the head restraint by sliding the webbing through the opening on the guide.

Airbag System

Your vehicle has a frontal airbag for the driver and a frontal airbag for the right front passenger. Your vehicle may also have side impact airbags. Side impact airbags are available for the driver and right front passenger.

If your vehicle has a side impact airbag for the driver and the right front passenger, the word AIRBAG will appear on the airbag covering on the side of the seatback closest to the door.

Frontal airbags are designed to help reduce the risk of injury from the force of an inflating frontal airbag. But these airbags must inflate very quickly to do their job and comply with federal regulations.

Here are the most important things to know about the airbag system:

 **CAUTION:**

You can be severely injured or killed in a crash if you are not wearing your safety belt — even if you have airbags. Wearing your safety belt during a crash helps reduce your chance of hitting things inside the vehicle or being ejected from it. Airbags are “supplemental restraints” to the safety belts. Airbags are designed to work with safety belts but do not replace them.

CAUTION: (Continued)

CAUTION: (Continued)

Frontal airbags for the driver and right front passenger are designed to deploy in moderate to severe frontal and near frontal crashes. They are not designed to inflate in rollover, rear crashes, or in many side crashes. And, for some unrestrained occupants, frontal airbags may provide less protection in frontal crashes than more forceful airbags have provided in the past.

Side impact airbags are designed to inflate in moderate to severe crashes where something hits the side of your vehicle. They are not designed to inflate in frontal, in rollover or in rear crashes.

Everyone in your vehicle should wear a safety belt properly — whether or not there is an airbag for that person.

⚠ CAUTION:

Both frontal and side impact airbags inflate with great force, faster than the blink of an eye. If you are too close to an inflating airbag, as you would be if you were leaning forward, it could seriously injure you. Safety belts help keep you in position for airbag inflation before and during a crash. Always wear your safety belt, even with frontal airbags. The driver should sit as far back as possible while still maintaining control of the vehicle. Front occupants should not lean on or sleep against the door.

⚠ CAUTION:

Anyone who is up against, or very close to, any airbag when it inflates can be seriously injured or killed. Airbags plus lap-shoulder

CAUTION: (Continued)

CAUTION: (Continued)

belts offer the best protection for adults, but not for young children and infants. Neither the vehicle's safety belt system nor its airbag system is designed for them. Young children and infants need the protection that a child restraint system can provide. Always secure children properly in your vehicle. To read how, see *Older Children on page 1-30* or *Infants and Young Children on page 1-32*.



There is an airbag readiness light on the instrument panel cluster, which shows the airbag symbol.

The system checks the airbag electrical system for malfunctions. The light tells you if there is an electrical problem. See *Airbag Readiness Light on page 3-27* for more information.

Where Are the Airbags?



The driver's frontal airbag is in the middle of the steering wheel.



The right front passenger's frontal airbag is in the instrument panel on the passenger's side.



If your vehicle has one, the driver's side impact airbag is in the side of the driver's seatback closest to the door.



If your vehicle has one, the right front passenger's side impact airbag is in the side of the passenger's seatback closest to the door.

 **CAUTION:**

If something is between an occupant and an airbag, the airbag might not inflate properly or it might force the object into that person causing severe injury or even death. The path of an inflating airbag must be kept clear. Do not put anything between an occupant and an airbag, and do not attach or put anything on the steering wheel hub or on or near any other airbag covering. Do not let seat covers block the inflation path of a side impact airbag.

When Should an Airbag Inflate?

The driver's and right front passenger's frontal airbags are designed to inflate in moderate to severe frontal or near-frontal crashes. But they are designed to inflate only if the impact exceeds a predetermined deployment threshold. Deployment thresholds take into account a variety of desired deployment and non-deployment events and are used to predict how severe a crash is likely to be in time for the airbags to inflate and help restrain the occupants.

Whether your frontal airbags will or should deploy is not based on how fast your vehicle is traveling. It depends largely on what you hit, the direction of the impact and how quickly your vehicle slows down.

In addition, your vehicle has "dual-stage" frontal airbags, which adjust the restraint according to crash severity. Your vehicle is equipped with electronic frontal sensors which help the sensing system distinguish between a moderate frontal impact and a more severe frontal impact. For moderate frontal impacts, these airbags inflate at a level less than full deployment. For more severe frontal impacts, full deployment occurs. If the front of your vehicle goes straight into a wall that does not move or deform, the threshold level for the reduced deployment is about 12 to 18 mph (19 to 29 km/h), and the threshold level for a full deployment is about 18 to 22 mph (29 to 35.4 km/h). The threshold level can vary, however, with specific vehicle design, so that it can be somewhat above or below this range.

Frontal airbags may inflate at different crash speeds. For example:

- If the vehicle hits a stationary object, the airbags could inflate at a different crash speed than if the vehicle hits a moving object.
- If the vehicle hits an object that deforms, the airbags could inflate at a different crash speed than if the vehicle hits an object that does not deform.

- If the vehicle hits a narrow object (like a pole) the airbags could inflate at a different crash speed than if the vehicle hits a wide object (like a wall).
- If the vehicle goes into an object at an angle the airbags could inflate at a different crash speed than if the vehicle goes straight into the object.

Frontal airbags (driver and right front passenger) are not intended to inflate during vehicle rollovers, rear impacts, or in many side impacts.

Your vehicle may or may not have side impact airbags. See *Airbag System on page 1-52*. Side impact airbags are intended to inflate in moderate to severe side crashes. A side impact airbag will inflate if the crash severity is above the system's designed threshold level. The threshold level can vary with specific vehicle design. Side impact airbags are not intended to inflate in frontal or near-frontal impacts, rollovers or rear impacts.

In any particular crash, no one can say whether an airbag should have inflated simply because of the damage to a vehicle or because of what the repair costs were. For frontal airbags, inflation is determined by what the vehicle hits, the angle of the impact, and how quickly the vehicle slows down in frontal or near-frontal impacts. For side impact airbags, inflation is determined by the location and severity of the impact.

What Makes an Airbag Inflate?

In an impact of sufficient severity, the airbag sensing system detects that the vehicle is in a crash. The sensing system triggers a release of gas from the inflator, which inflates the airbag. The inflator, the airbag and related hardware are all part of the airbag modules. Frontal airbag modules are located inside the steering wheel and instrument panel. For seating positions with side impact airbags, there are also airbag modules in the side of the seatbacks closest to the door.

How Does an Airbag Restrain?

In moderate to severe frontal or near frontal collisions, even belted occupants can contact the steering wheel or the instrument panel. In moderate to severe side collisions, even belted occupants can contact the inside of the vehicle. The airbag supplements the protection provided by safety belts. Airbags distribute the force of the impact more evenly over the occupant's upper body, stopping the occupant more gradually. But the frontal airbags would not help you in many types of collisions, including rollovers, rear impacts, and many side impacts, primarily because an occupant's motion is not toward the airbag. Side impact airbags would not help you in many types of collisions, including many frontal or near frontal collisions, and rear impacts, primarily because an occupant's motion is not toward those airbags.

Airbags should never be regarded as anything more than a supplement to safety belts, and then only in moderate to severe frontal or near-frontal collisions for the driver's and right front passenger's frontal airbags, and only in moderate to severe side collisions for side impact airbags.

What Will You See After an Airbag Inflates?

After an inflates, it quickly deflates, so quickly that some people may not even realize the airbag inflated. Some components of the airbag module may be hot for a short time. These components include the steering wheel hub for the driver's frontal airbag and the instrument panel for the right front passenger's frontal airbag. For seating positions with side impact airbags, the side of the seatback closest to the door may be warm. The parts of the airbag that come into contact with you may be warm, but not too hot to touch. There will be some smoke and dust coming from the vents in the deflated airbags. Airbag inflation does not prevent the driver from seeing out of the windshield or being able to steer the vehicle, nor does it stop people from leaving the vehicle.

CAUTION:

When an airbag inflates, there is dust in the air. This dust could cause breathing problems for people with a history of asthma or other breathing trouble. To avoid this, everyone in the vehicle should get out as soon as it is safe to do so. If you have breathing problems but cannot get out of the vehicle after an airbag inflates, then get fresh air by opening a window or a door. If you experience breathing problems following an airbag deployment, you should seek medical attention.

In many crashes severe enough to inflate an airbag, windshields are broken by vehicle deformation. Additional windshield breakage may also occur from the right front passenger airbag.

Your vehicle has a feature that may automatically unlock the doors and turn on the interior lamps and hazard warning flashers when the airbags inflate. You can lock the doors again and turn the interior lamps and hazard warning flashers off by using the door lock and interior lamp control and hazard warning flasher control.

- Airbags are designed to inflate only once. After an airbag inflates, you will need some new parts for your airbag system. If you do not get them, the airbag system will not be there to help protect you in another crash. A new system will include airbag modules and possibly other parts. The service manual for your vehicle covers the need to replace other parts.
- Your vehicle is equipped with a crash sensing and diagnostic module which records information after a crash. See *Vehicle Data Collection and Event Data Recorders* on page 7-9
- Let only qualified technicians work on your airbag system. Improper service can mean that your airbag system will not work properly. See your dealer for service.

Passenger Sensing System

Your vehicle has a passenger sensing system. The passenger airbag status indicator on the overhead console will be visible when you turn your ignition key to RUN or START. The words ON and OFF or the symbol for on and off, will be visible during the system check. If you use remote start to start your vehicle from a distance, if equipped, you may not see the system check. When the system check is complete, either the word ON or the word OFF, or the symbol for on or the symbol for off will be visible. See *Passenger Airbag Status Indicator* on page 3-28.



**Passenger
Airbag Status
Indicator – United
States**

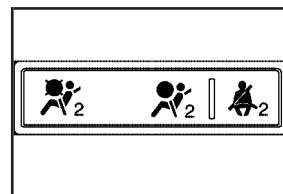

**Passenger
Airbag Status
Indicator – Canada**

The passenger sensing system will turn off the right front passenger's frontal airbag and side impact airbag (if equipped) under certain conditions. The driver's frontal airbag and side impact airbag (if equipped) are not part of the passenger sensing system.

The passenger sensing system works with sensors that are part of the right front passenger's seat. The sensors are designed to detect the presence of a properly-seated occupant and determine if the passenger's airbag or airbags should be enabled (may inflate) or not.

Accident statistics show that children are safer if they are restrained in the rear rather than the front seat. General Motors recommends that child restraints be secured in a rear seat, including an infant riding in a rear-facing infant seat, a child riding in a forward-facing child seat, and an older child riding in a booster seat.

Your vehicle has a rear seat that will accommodate a rear-facing child restraint. A label on your sun visor says, "Never put a rear-facing child seat in the front." This is because the risk to the rear-facing child is so great, if the airbags deploy.

CAUTION:

A child in a rear-facing child restraint can be seriously injured or killed if the right front passenger's airbag inflates. This is because the back of the rear-facing child restraint would be very close to the inflating airbag.

Even though the passenger sensing system is designed to turn off the passenger's frontal airbag and side airbag (if equipped) if the system detects a rear-facing child restraint, no system is fail-safe, and no one can guarantee that an airbag will not deploy under some unusual circumstance, even though it is turned off. General Motors recommends that rear-facing child restraints be secured in the rear seat, even if the airbag or airbags are off.

If you need to secure a forward-facing child restraint in the right front seat, always move the front passenger seat as far back as it will go. It is better to secure the child restraint in a rear seat.

The passenger sensing system is designed to turn off the right front passenger's frontal airbag and side impact airbag (if equipped) if:

- the right front passenger seat is unoccupied
- the system determines that an infant is present in a rear-facing infant seat
- the system determines that a small child is present in a forward-facing child restraint
- the system determines that a small child is present in a booster seat
- a right front passenger takes his/her weight off of the seat for a period of time
- the right front passenger seat is occupied by a smaller person, such as a child who has outgrown child restraints
- or if there is a critical problem with the airbag system or the passenger sensing system.

When the passenger sensing system has turned off the right front passenger's airbag or airbags, the off indicator in the overhead console will light and stay lit to remind you that the airbag or airbags are off.

If a child restraint has been installed and the on indicator is lit, turn the vehicle off. Remove the child restraint from the vehicle and reinstall the child restraint following the child restraint manufacturer's directions and refer to *Securing a Child Restraint in the Right Front Seat Position on page 1-48*.

If after reinstalling the child restraint and restarting the vehicle, the on indicator is still lit, check to make sure that the vehicle's seatback is not pressing the child restraint into the seat cushion. If this happens, slightly recline the vehicle's seatback and adjust the seat cushion if possible. Also make sure the child restraint is not trapped under the vehicle head restraint. If this happens, adjust the head restraint.

If the on indicator is still lit, secure the child in the child restraint in a rear seat position in the vehicle and check with your dealer.

The passenger sensing system is designed to enable (may inflate) the right front passenger's airbag or airbags anytime the system senses that a person of adult size is sitting properly in the right front passenger's seat. When the passenger sensing system has allowed the airbag or airbags to be enabled, the on indicator will light and stay lit to remind you that the airbag or airbags are active.

For some children who have outgrown child restraints and for very small adults, the passenger sensing system may or may not turn off the right front passenger's airbag or airbags, depending upon the person's seating posture and body build. Everyone in your vehicle who has outgrown child restraints should wear a safety belt properly — whether or not there is an airbag for that person.

If a person of adult-size is sitting in the right front passenger's seat, but the off indicator is lit, it could be because that person is not sitting properly in the seat. If this happens, turn the vehicle off and ask the person to place the seatback in the fully upright position, then sit upright in the seat, centered on the seat cushion, with the person's legs comfortably extended. Restart the vehicle and have the person remain in this position for about two minutes. This will allow the system to detect that person and then enable the passenger's airbag or airbags.



⚠ CAUTION:

If the airbag readiness light in the instrument panel cluster ever comes on and stays on, it means that something may be wrong with the airbag system. If this ever happens, have the vehicle serviced promptly, because an adult-size person sitting in the right front passenger's seat may not have the protection of an airbag. See *Airbag Readiness Light on page 3-27* for more on this, including important safety information.

Aftermarket equipment, such as seat covers, can affect how well the passenger sensing system operates. You may want to consider not using seat covers or other aftermarket equipment if your vehicle has the passenger sensing system. See *Adding Equipment to Your Airbag-Equipped Vehicle on page 1-66*.

 **CAUTION:**

Stowing of articles under the passenger's seat or between the passenger's seat cushion and seatback may interfere with the proper operation of the passenger sensing system.

Servicing Your Airbag-Equipped Vehicle

Airbags affect how your vehicle should be serviced. There are parts of the airbag system in several places around your vehicle. You do not want the system to inflate while someone is working on your vehicle. Your dealer and the service manual have information about servicing your vehicle and the airbag system. To purchase a service manual, see *Service Publications Ordering Information* on page 7-15.

 **CAUTION:**

For up to 10 seconds after the ignition key is turned off and the battery is disconnected, an airbag can still inflate during improper service. You can be injured if you are close to an airbag when it inflates. Avoid yellow connectors. They are probably part of the airbag system. Be sure to follow proper service procedures, and make sure the person performing work for you is qualified to do so.

The airbag system does not need regular maintenance.

Adding Equipment to Your Airbag-Equipped Vehicle

Q: Is there anything I might add to the front or sides of the vehicle that could keep the airbags from working properly?

A: Yes. If you add things that change your vehicle's frame, bumper system, front end or side sheet metal or height, they may keep the airbag system from working properly. Also, the airbag system may not work properly if you relocate any of the airbag sensors. If you have any questions about this, you should contact Customer Service before you modify your vehicle. The phone numbers and addresses for Customer Assistance are in Step Two of the Customer Satisfaction Procedure in this manual. See *Customer Satisfaction Procedure on page 7-2*.

Q: Because I have a disability, I have to get my vehicle modified. How can I find out whether this will affect my airbag system?

A: Changing or moving any parts of the front seats, safety belts, the airbag sensing and diagnostic module (located under the right front passenger's seat), or the overhead console can affect the operation of the airbag system. If you have questions, call Customer Assistance. The phone numbers and addresses for Customer Assistance are in Step Two of the Customer Satisfaction Procedure in this manual. See *Customer Satisfaction Procedure on page 7-2*.

Restraint System Check

Checking the Restraint Systems

Now and then, make sure the safety belt reminder light and all your belts, buckles, latch plates, retractors and anchorages are working properly. Look for any other loose or damaged safety belt system parts. If you see anything that might keep a safety belt system from doing its job, have it repaired.

Torn or frayed safety belts may not protect you in a crash. They can rip apart under impact forces. If a belt is torn or frayed, get a new one right away.

Also look for any opened or broken airbag covers, and have them repaired or replaced. (The airbag system does not need regular maintenance.)

Notice: If you damage the covering for the driver's or the right front passenger's frontal airbag, or an airbag covering (if equipped) on a seatback, the airbag may not work properly. You may have to replace the airbag module in the steering wheel, both the airbag module and the instrument panel for the right front passenger's frontal airbag, or both the airbag module and the seatback for seating positions with a side impact airbag (if equipped.) Do not open or break the airbag coverings.

Replacing Restraint System Parts After a Crash

CAUTION:

A crash can damage the restraint systems in your vehicle. A damaged restraint system may not properly protect the person using it, resulting in serious injury or even death in a crash. To help make sure your restraint systems are working properly after a crash, have them inspected and any necessary replacements made as soon as possible.

If you have had a crash, do you need new belts or LATCH system parts?

After a very minor collision, nothing may be necessary. But if the belts were stretched, as they would be if worn during a more severe crash, then you need new parts.

If the LATCH system was being used during a more severe crash, you may need new LATCH system parts.

If belts are cut or damaged, replace them. Collision damage also may mean you will need to have LATCH system, safety belt or seat parts repaired or replaced. New parts and repairs may be necessary even if the belt or LATCH system was not being used at the time of the collision.

If an airbag inflates, you will need to replace airbag system parts. See the part on the airbag system earlier in this section.

If an airbag inflates you will also need to replace the driver and front passenger's safety belt retractor assembly. Be sure to do so. Then the new retractor assembly will be there to help protect you in a collision.

After a crash you may need to replace the driver and front passenger's safety belt retractor assemblies, even if an airbag has not deployed. The driver and front passenger's safety belt retractor assemblies contain the safety belt pretensioners. Have your safety belt pretensioners checked if your vehicle has been in a collision, or if your airbag readiness light stays on after you start your vehicle or while you are driving. See *Airbag Readiness Light* on page 3-27.

Section 2 Features and Controls

Keys	2-2	Parking Brake	2-25
Remote Keyless Entry System	2-3	Shifting Into Park (P)	2-26
Remote Keyless Entry System Operation	2-4	Shifting Out of Park (P)	2-27
Doors and Locks	2-9	Parking Over Things That Burn	2-28
Door Locks	2-9	Engine Exhaust	2-28
Power Door Locks	2-10	Running the Engine While Parked	2-29
Automatic Door Lock	2-10	Mirrors	2-30
Programmable Automatic Door Unlock	2-11	Manual Rearview Mirror	2-30
Lockout Protection	2-11	Manual Rearview Mirror with OnStar®	2-30
Trunk	2-11	Automatic Dimming Rearview Mirror	2-30
Windows	2-13	Automatic Dimming Rearview Mirror with OnStar®	2-31
Power Windows	2-14	Outside Power Mirrors	2-31
Sun Visors	2-14	Outside Convex Mirror	2-32
Theft-Deterrent Systems	2-15	Outside Heated Mirrors	2-32
Content Theft-Deterrent	2-15	OnStar® System	2-32
PASS-Key® III+	2-16	Universal Home Remote System	2-34
PASS-Key® III+ Operation	2-16	Universal Home Remote System Operation	2-35
Starting and Operating Your Vehicle	2-18	Storage Areas	2-39
New Vehicle Break-In	2-18	Glove Box	2-39
Ignition Positions	2-18	Cupholder(s)	2-39
Retained Accessory Power (RAP)	2-19	Center Console Storage Area	2-39
Starting the Engine	2-19	Rear Seat Armrest	2-39
Engine Coolant Heater	2-20	Convenience Net	2-39
Displacement on Demand™ (DoD™) (5.3L V8 Engine)	2-21	Sunroof	2-40
Automatic Transaxle Operation	2-22		

Keys

CAUTION:

Leaving children in a vehicle with the ignition key is dangerous for many reasons. They could operate the power windows or other controls or even make the vehicle move. The children or others could be badly injured or even killed. Do not leave the keys in a vehicle with children.

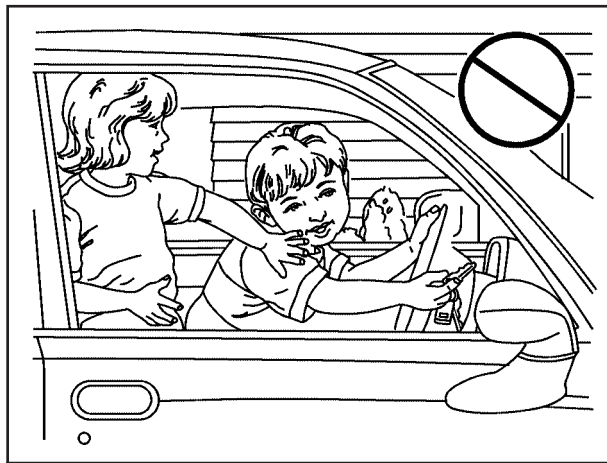

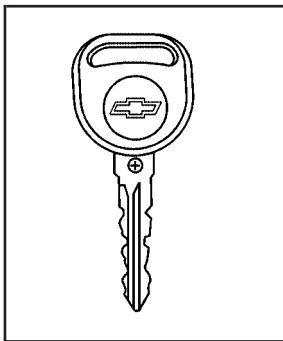

One key is used for the ignition and the driver's door.

If you need a new key, contact your dealer for assistance. In an emergency, contact Roadside Assistance. See *Roadside Assistance Program on page 7-5* for more information.

Notice: If you ever lock your keys in your vehicle, you may have to damage the vehicle to get in. Be sure you have spare keys.

If your vehicle is equipped with the OnStar® system, with an active subscription and you lock your keys inside the vehicle, OnStar® may be able to send a command to unlock your vehicle. See *OnStar® System on page 2-32* for more information.

Remote Keyless Entry System

The remote keyless entry system operates on a radio frequency subject to Federal Communications Commission (FCC) Rules and with Industry Canada.

This device complies with Part 15 of the FCC Rules. Operation is subject to the following two conditions:

- This device may not cause interference.
- This device must accept any interference received, including interference that may cause undesired operation of the device.

This device complies with RSS-210 of Industry Canada. Operation is subject to the following two conditions:

- This device may not cause interference.
- This device must accept any interference received, including interference that may cause undesired operation of the device.

Changes or modifications to this system by other than an authorized service facility could void authorization to use this equipment.

At times you may notice a decrease in range. This is normal for any remote keyless entry system. If the transmitter does not work or if you have to stand closer to your vehicle for the transmitter to work, try this:

- Check the distance. You may be too far from your vehicle. You may need to stand closer during rainy or snowy weather.
- Check the location. Other vehicles or objects may be blocking the signal. Take a few steps to the left or right, hold the transmitter higher, and try again.
- Check to determine if battery replacement is necessary. See "Battery Replacement" under *Remote Keyless Entry System Operation on page 2-4*.
- If you are still having trouble, see your dealer or a qualified technician for service.

Remote Keyless Entry System Operation

The vehicle's doors can be locked and unlocked, and the trunk can be unlatched from about 3 feet (1 m) up to 65 feet (20 m) away with the remote keyless entry transmitter.

If your vehicle has the remote start feature you can also start your vehicle with the remote keyless entry transmitter. Your remote keyless entry transmitter, with the remote start button, provides an increased range of 195 feet (60 m) away. However, the range may be less while the vehicle is running. As a result, you may need to be closer to your vehicle to turn it off than you were to turn it on.

There are other conditions which can affect the performance of the transmitter. See *Remote Keyless Entry System on page 2-3*.

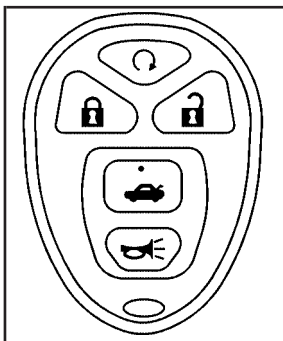

**Remote Keyless Entry
with Remote Start**

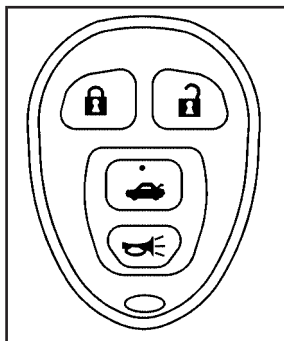

**Remote Keyless Entry
without Remote Start**

The following functions may be available if your vehicle has the remote keyless entry system:

⌚ (Remote Vehicle Start): If your vehicle has this feature, it may be started from outside the vehicle using the remote keyless entry transmitter. See “Remote Vehicle Start” following for more detailed information.

🔒 (Lock): Press the lock button to lock all the doors. If enabled through the Driver Information Center (DIC), the parking lamps will flash once to indicate locking has occurred. If enabled through the DIC, the horn will chirp when the lock button is pressed again within five seconds of the previous press of the lock button.

See *DIC Vehicle Customization on page 3-53* for additional information. Pressing the lock button may arm the content theft-deterrent system. See *Content Theft-Deterrent on page 2-15*.

🔓 (Unlock): Press the unlock button to unlock the driver's door. If the button is pressed again within five seconds, all remaining doors will unlock. The interior lamps will come on and stay on for 20 seconds or until the ignition is turned on. If enabled through the DIC, the parking lamps will flash once to indicate unlocking has occurred. See *DIC Vehicle Customization on page 3-53*. Pressing the unlock button on the remote keyless entry transmitter will disarm the content theft-deterrent system. See *Content Theft-Deterrent on page 2-15*.

🚗 (Remote Trunk Release): Press and hold this button for approximately one second to release the trunk lid. The transaxle must be in PARK (P) for this feature to operate.

📶 (Vehicle Locator/Panic Alarm): Press and release this button to locate your vehicle. The turn signal lamps will flash and the horn will sound three times. Press and hold this button for more than two seconds to activate the panic alarm. The turn signal lamps will flash and the horn will sound repeatedly for 30 seconds. The alarm will turn off when the ignition is moved to RUN or the alarm button is pressed again. The ignition must be in OFF for the panic alarm to work.

Matching Transmitter(s) to Your Vehicle

Each remote keyless entry transmitter is coded to prevent another transmitter from unlocking your vehicle. If a transmitter is lost or stolen, a replacement can be purchased through your GM dealer. Remember to bring any additional transmitters so they can also be re-coded to match the new transmitter. Once your dealer has coded the new transmitter, the lost transmitter will not unlock your vehicle. The vehicle can have a maximum of eight transmitters matched to it. See Remote Key under *DIC Operation and Displays on page 3-40*.

Battery Replacement

Under normal use, the battery in your remote keyless entry transmitter should last about four years.

You can tell the battery is weak if the transmitter will not work at the normal range in any location. If you have to get close to your vehicle before the transmitter works, it is probably time to change the battery.

The REPLACE BATTERY IN REMOTE KEY message in the vehicle's DIC will display if the remote keyless entry transmitter battery is low. See "REPLACE BATTERY IN REMOTE KEY" under *DIC Warnings and Messages on page 3-46* for additional information.

Notice: When replacing the battery, use care not to touch any of the circuitry. Static from your body transferred to these surfaces may damage the transmitter.

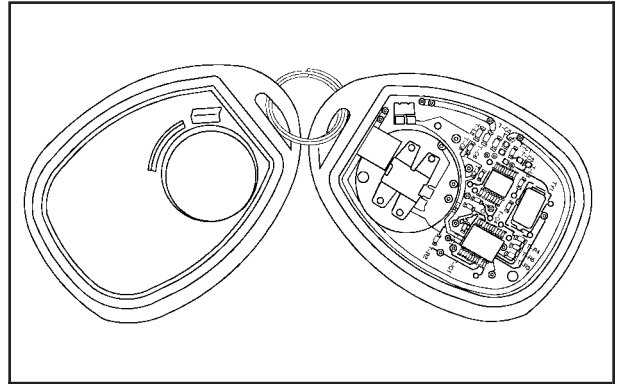

To replace the battery in the remote keyless entry transmitter do the following:

1. Use a flat object with a thin edge into the notch, located below the trunk release button, and separate the bottom half from the top half of the transmitter.
2. Remove the old battery, but do not use a metal object to do this.

3. Slide the new battery into the transmitter with the positive side of the battery facing down. Use a type CR2032 battery, or equivalent type. Make sure the cover is on tightly, so water will not get in.
4. Snap the front and the back of the transmitter together.
5. Test the operation of the transmitter with the vehicle.

Remote Vehicle Start

Your vehicle may have a remote starting feature. This feature allows you to start the engine from outside of the vehicle.

If your vehicle has an outside temperature display, during remote start this feature allows the climate control system to default to a heating mode during colder outside temperatures and a cooling mode during warmer outside temperatures. If your vehicle does not have an outside temperature display, during remote start the climate control system will turn on at the setting the vehicle was set to when the vehicle was last turned off.

Laws in some communities may restrict the use of remote starters. For example, requiring a person using remote start to have the vehicle in view when doing so. Check local regulations for any requirements on remote starting of vehicles.

Do not use the remote start feature if your vehicle is low on fuel. Your vehicle may run out of fuel.

Your remote keyless entry transmitter, with the remote start button, provides an increased range of operation. However, the range may be less while the vehicle is running. As a result, you may need to be closer to your vehicle to turn it off, than you were to turn it on.

There are other conditions which can affect the performance of the transmitter, see *Remote Keyless Entry System on page 2-3* for additional information.

🔑 (Remote Start): Press and release the lock button and then press and hold this button to use the remote start feature.

To start the vehicle using the remote start feature, do the following:

1. Aim the transmitter at the vehicle.
2. Press and release the transmitter's lock button, then immediately press and hold the transmitter's remote start button until the turn signal lights flash or if the vehicle's lights are not visible, press and hold the remote start button for at least four seconds. The vehicle's doors will lock. Pressing the remote start button again after the vehicle has started will turn off the ignition.

3. When the vehicle starts, the parking lamps will turn on and remain on while the vehicle is running.
4. If it is your first remote start since last driving, repeat these steps while the engine is still running for a 10 minute time extension.

When you enter the vehicle during a remote start, and the engine is still running, turn the key to the RUN position to drive the vehicle.

If the vehicle is left running it will automatically shut off after 10 minutes unless a time extension has been done.

To manually shut off a remote start, do any of the following:

- Aim the remote keyless entry transmitter at the vehicle and press the remote start button until the parking lamps turn off.
- Turn on the hazards warning flashers.
- Turn the ignition switch on and then off.

The remote vehicle start feature provides two separate starts, each with 10 minutes of engine running, or it provides one start with 10 minutes of engine running that may be extended with 10 more minutes. If you press and release the transmitter lock button and then press and hold the remote start button, on the remote keyless entry transmitter, again before the first 10 minutes of engine running time has expired,

10 minutes are added to the remaining minutes. For example, if the lock button and then the remote start buttons are pressed again after five minutes of the engine run time, 10 minutes are added and you now have 15 minutes of engine running. The added ten minutes are considered a second remote vehicle start. Once two remote starts or a single start with a time extension have been provided, the vehicle must be started normally with the ignition key to get more remote vehicle starts.

The remote vehicle start feature will not operate if the key is in the ignition, the hood is not closed or if there is an emission control system malfunction.

Also, the engine will turn off during a remote vehicle start if the coolant temperature gets too high or if the oil pressure gets low.

Vehicles equipped with the remote vehicle start feature are shipped from the factory with the remote vehicle start system enabled. The system may be enabled or disabled through the DIC. See "REMOTE START" under *DIC Vehicle Customization on page 3-53* for additional information.

Remote Start Ready

If your vehicle does not have the remote vehicle start feature, it may have the remote start ready feature. This feature allows your dealer to add the manufacturer's remote vehicle start feature.

If your vehicle has the remote start ready feature, your remote keyless entry transmitter will have extended range that will allow you to lock or unlock your vehicle from approximately 195 feet (60 m) away.

See your dealer if you would like to add the manufacturer's remote vehicle start feature to your vehicle.

Doors and Locks

Door Locks

CAUTION:

Unlocked doors can be dangerous.

- **Passengers — especially children — can easily open the doors and fall out of a moving vehicle. When a door is locked, the handle will not open it. You increase the chance of being thrown out of the vehicle in a crash if the doors are not locked. So, wear safety belts properly and lock the doors whenever you drive.**
- **Young children who get into unlocked vehicles may be unable to get out. A child can be overcome by extreme heat and can suffer permanent injuries or even death from heat stroke. Always lock your vehicle whenever you leave it.**
- **Outsiders can easily enter through an unlocked door when you slow down or stop your vehicle. Locking your doors can help prevent this from happening.**

There are several ways to lock and unlock the vehicle.

From the outside, use your key in the driver's door or the remote keyless entry transmitter, if equipped. See *Remote Keyless Entry System Operation on page 2-4*. From the inside, use the manual or power door locks.

To manually unlock the driver's door from the outside, insert the key and turn it toward the front of the vehicle.

To manually lock the driver's door from the outside, insert the key and turn it toward the rear of the vehicle.

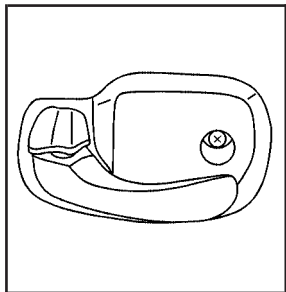

To lock a door from the inside, push the manual lock lever forward. To unlock a door, push the lever rearward.

Power Door Locks



A power door lock switch is located on each door above the armrest.

Press the top of the switch to unlock both doors, or press the bottom of the switch to lock both doors.

If your vehicle has the optional content theft-deterrent system and it is armed, the power door lock switches will be disabled. You must use your remote keyless entry transmitter, if equipped, or your key to unlock the doors while the system is armed.

Automatic Door Lock

The doors will automatically lock when the shift lever is moved out of PARK (P). The automatic door locking feature cannot be disabled.

Programmable Automatic Door Unlock

Your vehicle is programmed so that when the shift lever is moved into PARK (P) all doors will unlock.

With the vehicle stopped and the engine running, door unlocking can be programmed through prompts displayed on the Driver Information Center (DIC). These prompts allow the driver to choose various unlock settings. For programming information, see *DIC Vehicle Customization* on page 3-53.

Lockout Protection

To protect you from locking your key in the vehicle, this feature stops the power door locks from locking while the key is in the ignition and a door is open.

If a power lock switch is pressed while a door is open and the key is in the ignition, both doors will lock and then the driver's door will unlock. A chime will sound continuously until both doors are closed.

Trunk

CAUTION:

It can be dangerous to drive with the trunk lid open because carbon monoxide (CO) gas can come into your vehicle. You cannot see or smell CO. It can cause unconsciousness and even death. If you must drive with the trunk lid open or if electrical wiring or other cable connections must pass through the seal between the body and the trunk lid:

- **Make sure all other windows are shut.**
- **Turn the fan on your heating or cooling system to its highest speed and select the control setting that will force outside air into your vehicle. See Climate Control System.**
- **If you have air outlets on or under the instrument panel, open them all the way.**

See *Engine Exhaust* on page 2-28.

Trunk Release

To open the trunk from the outside, press the open trunk button on the remote keyless entry transmitter, if equipped.

Remote Trunk Release

You can also open the trunk from inside the vehicle.

 **(Remote Trunk Release):** Press the button with the open trunk symbol on it. The button is located next to the exterior lamps control on the left side of the instrument panel. The shift lever must be in PARK (P) for the remote trunk release button to work.

If your vehicle ever loses power, you can open the trunk by lowering the rear seat and pulling the emergency trunk release handle located inside the trunk. See *Split Folding Rear Seat* on page 1-10 and “Emergency Trunk Release Handle” following.

Emergency Trunk Release Handle

Notice: Do not use the emergency trunk release handle as a tie-down or anchor point when securing items in the trunk as it could damage the handle. The emergency trunk release handle is only intended to aid a person trapped in a latched trunk, enabling them to open the trunk from the inside.

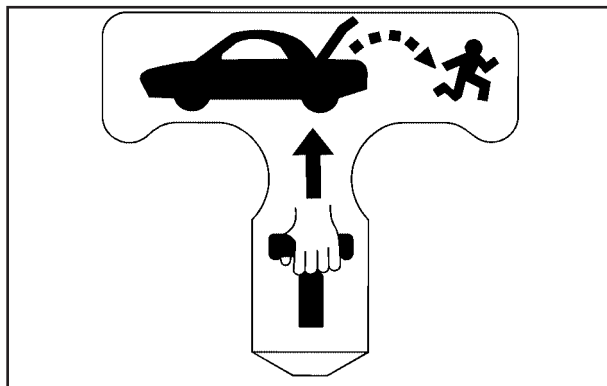

There is a glow-in-the-dark trunk release handle located on the latch inside the trunk. This handle will glow following exposure to light. Pull the release handle to open the trunk from the inside.

Windows

CAUTION:

Leaving children, helpless adults, or pets in a vehicle with the windows closed is dangerous. They can be overcome by the extreme heat and suffer permanent injuries or even death from heat stroke. Never leave a child, a helpless adult, or a pet alone in a vehicle, especially with the windows closed in warm or hot weather.

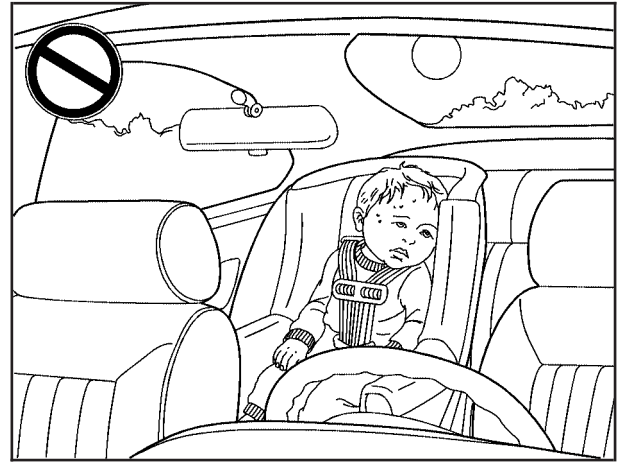

Power Windows

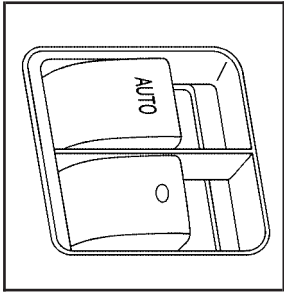

**Driver's Switches
shown**

The switches on the driver's door are used to control both windows. The passenger's window has a switch also.

The power window switches work while the ignition is in RUN, ACCESSORY, or while Retained Accessory Power (RAP) is active. See *Retained Accessory Power (RAP)* on page 2-19.

To lower the window, press and hold the front of the switch to the first position until the window is at the desired level. To raise the window, pull up and hold the front of the switch.

Express-Down Window

The driver's window switch has an express-down feature labeled AUTO. This allows you to lower the window completely without holding the switch. Press the front of the switch all the way down and release.

To stop the window while it is lowering, briefly pull up on the switch.

Sun Visors

To block out glare, swing down the sun visors. They can be detached from the center retainer and slid along the rod to cover different areas of the front window and rotated to cover the side windows.

Visor Vanity Mirror

Swing down the sun visors and lift the cover to expose the vanity mirror. If your vehicle has lighted vanity mirrors, the lamps come on when you open the cover. Do not drive with the cover lifted due to possible glare to other drivers behind or to the side of the vehicle.

Theft-Deterrent Systems

Vehicle theft is big business, especially in some cities. Although your vehicle has a number of theft-deterrent features, we know that nothing we put on it can make it impossible to steal.

Content Theft-Deterrent

Your vehicle may have the optional content theft-deterrent alarm system.

To activate the theft-deterrent system:

1. Open the door.
2. Lock the door with the power door lock switch or the remote keyless entry transmitter. If you are using the remote keyless entry transmitter, the door does not need to be open.
3. Close all doors.

Once armed, the alarm will go off if someone tries to enter the vehicle without using the remote keyless entry transmitter or a key or turns the ignition on with an incorrect key. The horn will sound and the turn signal lamps will flash for approximately two minutes.

When the alarm is armed, the trunk may be opened with the remote keyless entry transmitter. The power door lock switches are disabled and the doors remain locked. You must use your remote keyless entry transmitter or your key to unlock the doors when the system is armed.

Arming with the Power Lock Switch

The alarm system will arm when you use either power lock switch to lock the doors while any door or the trunk is open and the key is removed from the ignition.

Arming with the Remote Keyless Entry Transmitter

The alarm system will arm when you use your remote keyless entry transmitter to lock the doors, if the key is not in the ignition.

Disarming with the Remote Keyless Entry Transmitter

The alarm system will disarm when you use your remote keyless entry transmitter to unlock the doors.

The first time a remote UNLOCK command is received, three flashes will be seen and three horn chirps heard to indicate an alarm condition has occurred since last arming.

Disarming with Your Key

The alarm system will disarm when you use your key to unlock the doors or insert your key in ignition and turn it from the OFF position.

PASS-Key® III+

The PASS-Key® III+ system operates on a radio frequency subject to Federal Communications Commission (FCC) Rules and with Industry Canada.

This device complies with Part 15 of the FCC Rules. Operation is subject to the following two conditions:

1. This device may not cause harmful interference.
2. This device must accept any interference received, including interference that may cause undesired operation.

This device complies with RSS-210 of Industry Canada. Operation is subject to the following two conditions:

1. This device may not cause interference.
2. This device must accept any interference received, including interference that may cause undesired operation of the device.

Changes or modifications to this system by other than an authorized service facility could void authorization to use this equipment.

PASS-Key® III+ uses a radio frequency transponder in the key that matches a decoder in your vehicle.

PASS-Key® III+ Operation

Your vehicle has PASS-Key® III+ (Personalized Automotive Security System) theft-deterrent system. PASS-Key® III+ is a passive theft-deterrent system. This means you do not have to do anything special to arm or disarm the system. It works when you transition the key to RUN, ACCESSORY or START from the OFF position.

When the PASS-Key® III+ system senses that someone is using the wrong key, it prevents the vehicle from starting. Anyone using a trial-and-error method to start the vehicle will be discouraged because of the high number of electrical key codes.

If the engine does not start and the security light on the instrument panel comes on when trying to start the vehicle, the key may have a damaged transponder. Turn the ignition off and try again.

If the engine still does not start, and the key appears to be undamaged, try another ignition key. At this time, you may also want to check the fuse, see *Fuses and Circuit Breakers on page 5-95*. If the engine still does not start with the other key, your vehicle needs service. If your vehicle does start, the first key may be faulty. See your dealer who can service the PASS-Key® III+ to have a new key made. In an emergency, contact Roadside Assistance.

It is possible for the PASS-Key® III+ decoder to “learn” the transponder value of a new or replacement key. Up to nine additional keys may be programmed for the vehicle. The following procedure is for programming additional keys only. If all the currently programmed keys are lost or do not operate, you must see your dealer or a locksmith who can service PASS-Key® III+ to have keys made and programmed to the system.

See your dealer or a locksmith who can service PASS-Key® III+ to get a new key blank that is cut exactly as the ignition key that operates the system.

To program the new additional key do the following:

1. Verify that the new key has a + stamped on it.
2. Insert the original, already programmed, key in the ignition and start the engine. If the engine will not start, see your dealer for service.
3. After the engine has started, turn the key to OFF, and remove the key.

4. Insert the new key to be programmed and turn it to the RUN position within five seconds of removing the original key.
5. The security light will turn off once the key has been programmed.
6. Repeat Steps 1 through 5 if additional keys are to be programmed.

If you are driving and the security light comes on and stays on, you may be able to restart your engine. Your PASS-Key® III+ system, however, may not be working properly and must be serviced by your dealer.

If you lose or damage your PASS-Key® III+ key, see your dealer or a locksmith who can service PASS-Key® III+ to have a new key made.

Starting and Operating Your Vehicle

New Vehicle Break-In

Notice: Your vehicle does not need an elaborate break-in. But it will perform better in the long run if you follow these guidelines:

- Do not drive at any one constant speed, fast or slow, for the first 500 miles (805 km). Do not make full-throttle starts. Avoid downshifting to brake, or slow, the vehicle.
- Avoid making hard stops for the first 200 miles (322 km) or so. During this time your new brake linings are not yet broken in. Hard stops with new linings can mean premature wear and earlier replacement. Follow this breaking-in guideline every time you get new brake linings.
- Do not tow a trailer during break-in. See *Towing a Trailer* on page 4-36 for the trailer towing capabilities of your vehicle and more information.

Following break-in, engine speed and load can be gradually increased.

Ignition Positions

With the ignition key in the ignition, the key can be turned to four different positions:

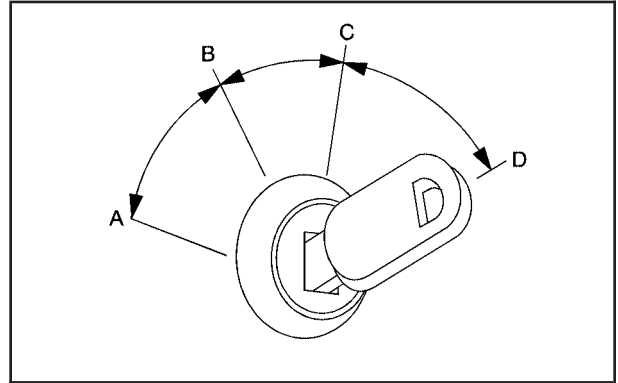

Notice: Using a tool to force the key from the ignition switch could cause damage or break the key. Use the correct key and turn the key only with your hand. Make sure the key is in all the way. If none of this works, then your vehicle needs service.

A (OFF): This is the only position in which the ignition key can be inserted or removed. This position locks the ignition and transaxle. It is a theft-deterrent feature.

B (ACCESSORY): This position lets the radio and windshield wipers operate while the engine is off. To use ACCESSORY, turn the key clockwise.

C (RUN): This position is where the key returns to after the vehicle is started. This position displays some of the warning and indicator lights.

D (START): This position starts the engine.

A warning chime will sound and the Driver Information Center (DIC) will display DRIVER'S DOOR OPEN when the driver's door is opened if the ignition is in OFF, ACCESSORY and the key is in the ignition. See *DIC Warnings and Messages on page 3-46* for more information.

Retained Accessory Power (RAP)

The vehicle has Retained Accessory Power (RAP), which will allow your vehicle's radio to work when the ignition key is in the RUN or ACCESSORY position. Once the key is turned from RUN to OFF the radio will continue to work 10 minutes or until the driver's door is opened. Also, the power windows will continue to work for up to 10 minutes or until any door is opened.

Starting the Engine

Move your shift lever to PARK (P) or NEUTRAL (N). Your engine will not start in any other position — that is a safety feature. To restart when you are already moving, use NEUTRAL (N) only.

Notice: Shifting into PARK (P) with the vehicle moving could damage the transaxle. Shift into PARK (P) only when your vehicle is stopped.

Starting Your Engine

1. With your foot off the accelerator pedal, turn your ignition key to START. When the engine starts, let go of the key. The idle speed will go down as your engine gets warm.

Notice: Holding your key in START for longer than 15 seconds at a time will cause your battery to be drained much sooner. And the excessive heat can damage your starter motor. Wait about 15 seconds between each try to help avoid draining your battery or damaging your starter.

2. If your vehicle does not start within 10 seconds, hold the key in START for about 10 seconds at a time until the engine starts. Wait about 15 seconds between each try.

3. If the engine still will not start, or starts but then stops, it could be flooded with too much gasoline. Try pushing your accelerator pedal all the way to the floor and holding it there as you hold the key in START for about three seconds. If the vehicle starts briefly but then stops again, do the same thing. This time keep the pedal down for five or six seconds to clear the extra gasoline from the engine. After waiting about 15 seconds, repeat the normal starting procedure.

Notice: Your engine is designed to work with the electronics in your vehicle. If you add electrical parts or accessories, you could change the way the engine operates. Before adding electrical equipment, check with your dealer. If you do not, your engine might not perform properly. Any resulting damage would not be covered by your vehicle's warranty.

Engine Coolant Heater

Your vehicle may have this feature. In very cold weather, 0°F (-18°C) or colder, the engine coolant heater can help. You will get easier starting and better fuel economy during engine warm-up. Usually, the coolant heater should be plugged in a minimum of four hours prior to starting your vehicle. At temperatures above 32°F (0°C), use of the coolant heater is not required.

To Use the Engine Coolant Heater

1. Turn off the engine.
2. Open the hood and unwrap the electrical cord. The cord is attached to the underside of the diagonal brace, which is located above the engine air cleaner/filter assembly.
3. Plug it into a normal, grounded 110-volt AC outlet.

 **CAUTION:**

Plugging the cord into an ungrounded outlet could cause an electrical shock. Also, the wrong kind of extension cord could overheat and cause a fire. You could be seriously injured. Plug the cord into a properly grounded three-prong 110-volt AC outlet. If the cord will not reach, use a heavy-duty three-prong extension cord rated for at least 15 amps.

4. Before starting the engine, be sure to unplug and store the cord as it was before to keep it away from moving engine parts. If you do not, it could be damaged.

How long should you keep the coolant heater plugged in? The answer depends on the outside temperature, the kind of oil you have, and some other things. Instead of trying to list everything here, we ask that you contact your dealer in the area where you will be parking your vehicle. The dealer can give you the best advice for that particular area.

Displacement on Demand™ (DoD™) (5.3L V8 Engine)

Your vehicle's engine may be equipped with Displacement on Demand™ (DoD™). This system allows the engine to operate on either all or half of its cylinders, depending on your driving conditions.

When less power is required, such as cruising at a constant vehicle speed, the system will operate in the half cylinder mode, allowing your vehicle to achieve better fuel economy. When greater power demands are required, such as accelerating from a stop, passing, or merging onto a freeway, the system will maintain full-cylinder operation.

Automatic Transaxle Operation

Your automatic transaxle has a shift lever on the console between the seats.

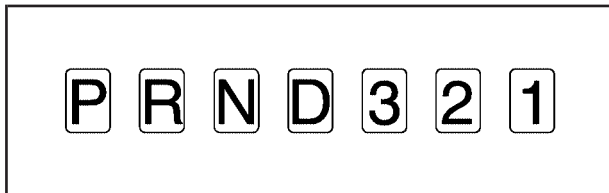

There is a display, located on the instrument panel cluster that will indicate the gear the vehicle is in.

Maximum engine speed is limited on automatic transaxle vehicles while you are in PARK (P) or NEUTRAL (N) to protect driveline components from improper operation.

There are several different positions for the shift lever.

PARK (P): This position locks your front wheels. It is the best position to use when the engine is started because your vehicle cannot move easily.

CAUTION:

It can be dangerous to get out of your vehicle if the shift lever is not fully in PARK (P) with the parking brake firmly set. Your vehicle can roll. If you have left the engine running, the vehicle can move suddenly. You or others could be injured. To be sure your vehicle will not move, even when you are on fairly level ground, use the steps that follow. If you are pulling a trailer, see *Towing a Trailer on page 4-36*.

Make sure the shift lever is fully in PARK (P) before starting the engine. Your vehicle has an automatic transaxle shift lock control system. You must fully apply your regular brakes before you can shift from PARK (P) while the ignition is in RUN. If you cannot shift out of PARK (P), ease pressure on the shift lever by pushing it all the way into PARK (P) while keeping the brake pedal pushed down. Release the shift lever button if you have a console shift. Then move the shift lever out of PARK (P). See *Shifting Out of Park (P) on page 2-27*.

REVERSE (R): Use this gear to back up.

Notice: Shifting to REVERSE (R) while your vehicle is moving forward could damage the transaxle. The repairs would not be covered by your warranty. Shift to REVERSE (R) only after your vehicle is stopped.

To rock your vehicle back and forth to get out of snow, ice or sand without damaging your transaxle, see *If Your Vehicle is Stuck in Sand, Mud, Ice or Snow* on page 4-28.

NEUTRAL (N): In this position, your engine does not connect with the wheels. To restart when you are already moving, use NEUTRAL (N) only. Also, use NEUTRAL (N) when your vehicle is being towed.

 **CAUTION:**

Shifting into a drive gear while your engine is running at high speed is dangerous. Unless your foot is firmly on the brake pedal, your vehicle could move very rapidly. You could lose control and hit people or objects. Do not shift into a drive gear while your engine is running at high speed.

Notice: Shifting out of PARK (P) or NEUTRAL (N) while the engine is running at high speed may damage the transaxle. The repairs would not be covered by your warranty. Be sure the engine is not running at high speeds when shifting your vehicle.

AUTOMATIC OVERDRIVE (D): This position is for normal driving. If you need more power for passing, and you are:

- Going less than 35 mph (55 km/h), push the accelerator pedal about halfway down.
- Going about 35 mph (55 km/h) or more, push the accelerator pedal all the way down.

You will shift down to the next gear and have more power.

Notice: If your vehicle seems to start up rather slowly or not shift gears when you go faster, and you continue to drive your vehicle that way, you could damage the transaxle. Have your vehicle serviced right away. You can drive in SECOND (2) when you are driving less than 35 mph (55 km/h) and AUTOMATIC OVERDRIVE (D) for higher speeds until then.

THIRD (3): This position is also used for normal driving, but it offers more power and lower fuel economy than AUTOMATIC OVERDRIVE (D).

Here are some times you might choose THIRD (3) instead of AUTOMATIC OVERDRIVE (D):

- When driving on hilly, winding roads
- When towing a trailer, so there is less shifting between gears
- When going down a steep hill. For more information, see *Hill and Mountain Roads* on page 4-22.

SECOND (2): This position gives you more power but lower fuel economy than THIRD (3). You can use SECOND (2) on hills. It can help control your speed as you go down steep mountain roads. You would also then want to use your brakes off and on.

Notice: Driving in SECOND (2) for more than 25 miles (40 km) or at speeds over 55 mph (90 km/h) may damage the transaxle. Also, shifting into SECOND (2) at speeds above 65 mph (105 km/h) can cause damage. Drive in THIRD (3) or AUTOMATIC OVERDRIVE (D) instead of SECOND (2).

FIRST (1): This position gives you even more power, but lower fuel economy than SECOND (2). You can use it on very steep hills, or in deep snow or mud. If the shift lever is in FIRST (1), the transaxle will not shift into first gear until the vehicle is going slowly enough.

Notice: Spinning the tires or holding the vehicle in one place on a hill using only the accelerator pedal may damage the transaxle. If you are stuck, do not spin the tires. When stopping on a hill, use the brakes, or parking brake to hold the vehicle in place.

Parking Brake

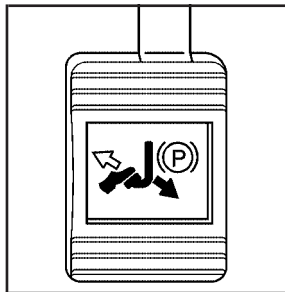

The parking brake is located to the left of the brake pedal, near the driver's door.

To set the parking brake, hold the brake pedal down with your right foot. Push down the parking brake pedal with your left foot.

To release the parking brake, hold the brake pedal down with your right foot and push the parking brake pedal with your left foot. When you lift your left foot, the parking brake pedal will follow it to the released position.

A warning chime will sound and a brake warning light located on the instrument panel cluster will come on, if the parking brake is set, the ignition is on and the shift lever is not in PARK (P).

Notice: Driving with the parking brake on can overheat the brake system and cause premature wear or damage to brake system parts. Verify that the parking brake is fully released and the brake warning light is off before driving.

If you are towing a trailer and parking on any hill, see *Towing a Trailer on page 4-36*.

Shifting Into Park (P)

CAUTION:

It can be dangerous to get out of your vehicle if the shift lever is not fully in PARK (P) with the parking brake firmly set. Your vehicle can roll. If you have left the engine running, the vehicle can move suddenly. You or others could be injured. To be sure your vehicle will not move, even when you are on fairly level ground, use the steps that follow. If you are pulling a trailer, see *Towing a Trailer on page 4-36*.

1. Hold the brake pedal down with your right foot and set the parking brake.
2. Move the shift lever into PARK (P) by holding in the button on the shift lever and pushing the shift lever all the way toward the front of the vehicle.
3. Turn the ignition key to OFF.
4. Remove the key and take it with you. If you can leave your vehicle with the ignition key in your hand, your vehicle is in PARK (P).

Leaving Your Vehicle With the Engine Running

CAUTION:

It can be dangerous to leave your vehicle with the engine running. Your vehicle could move suddenly if the shift lever is not fully in PARK (P) with the parking brake firmly set. And, if you leave the vehicle with the engine running, it could overheat and even catch fire. You or others could be injured. Do not leave your vehicle with the engine running.

If you have to leave your vehicle with the engine running, be sure your vehicle is in PARK (P) and your parking brake is firmly set before you leave it. After you have moved the shift lever into PARK (P), hold the regular brake pedal down. Then, see if you can move the shift lever away from PARK (P) without first pushing the button.

If you can, it means that the shift lever was not fully locked in PARK (P).

Torque Lock

If you are parking on a hill and you do not shift your transaxle into PARK (P) properly, the weight of the vehicle may put too much force on the parking pawl in the transaxle. You may find it difficult to pull the shift lever out of PARK (P). This is called torque lock. To prevent torque lock, set the parking brake and then shift into PARK (P) properly before you leave the driver's seat. To find out how, see *Shifting Into Park (P)* on page 2-26.

When you are ready to drive, move the shift lever out of PARK (P) *before* you release the parking brake.

If torque lock does occur, you may need to have another vehicle push your vehicle a little uphill to take some of the pressure from the parking pawl in the transaxle, so you can pull the shift lever out of PARK (P).

Shifting Out of Park (P)

Your vehicle has an automatic transaxle shift lock control system. You must fully apply your regular brakes before you can shift from PARK (P) when the ignition is in RUN. See *Automatic Transaxle Operation* on page 2-22.

If you cannot shift out of PARK (P), ease pressure on the shift lever by pushing it all the way into PARK (P) while keeping the brake pedal pushed down. Release the shift lever button if you have a console shift. Then move the shift lever out of PARK (P), being sure to press the shift lever button if you have a console shift.

If you ever hold the brake pedal down but still cannot shift out of PARK (P), try this:

1. Turn the ignition key to ACCESSORY.
2. Apply and hold the brake pedal down until the end of Step 4.
3. Shift to NEUTRAL (N).
4. Start the engine and shift to the drive gear you want.
5. Have the vehicle fixed as soon as you can.

Parking Over Things That Burn

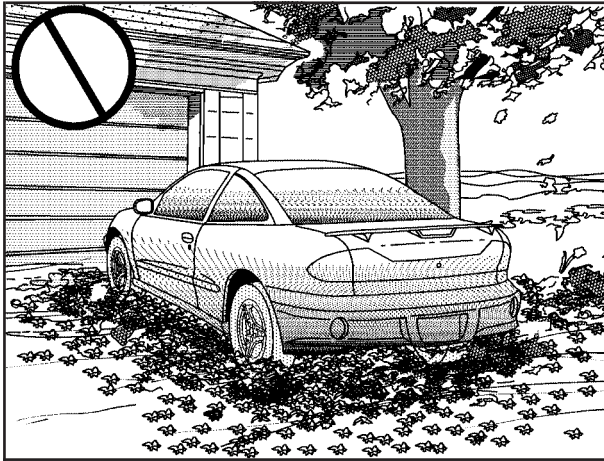

CAUTION:

Things that can burn could touch hot exhaust parts under your vehicle and ignite. Do not park over papers, leaves, dry grass, or other things that can burn.

Engine Exhaust

CAUTION:

Engine exhaust can kill. It contains the gas carbon monoxide (CO), which you cannot see or smell. It can cause unconsciousness and death.

You might have exhaust coming in if:

- Your exhaust system sounds strange or different.
- Your vehicle gets rusty underneath.
- Your vehicle was damaged in a collision.
- Your vehicle was damaged when driving over high points on the road or over road debris.
- Repairs were not done correctly.
- Your vehicle or exhaust system had been modified improperly.

If you ever suspect exhaust is coming into your vehicle:

- Drive it only with all the windows down to blow out any CO; and
- Have your vehicle fixed immediately.

Running the Engine While Parked

It is better not to park with the engine running. But if you ever have to, here are some things to know.

CAUTION:

Idling the engine with the climate control system off could allow dangerous exhaust into your vehicle. See the earlier caution under *Engine Exhaust on page 2-28*.

Also, idling in a closed-in place can let deadly carbon monoxide (CO) into your vehicle even if the climate control fan is at the highest setting. One place this can happen is a garage. Exhaust — with CO — can come in easily. **NEVER** park in a garage with the engine running.

Another closed-in place can be a blizzard. See *Winter Driving on page 4-24*.

CAUTION:

It can be dangerous to get out of your vehicle if the shift lever is not fully in PARK (P) with the parking brake firmly set. Your vehicle can roll. Do not leave your vehicle when the engine is running unless you have to. If you have left the engine running, the vehicle can move suddenly. You or others could be injured. To be sure your vehicle will not move, even when you are on fairly level ground, always set your parking brake and move the shift lever to PARK (P).

Follow the proper steps to be sure your vehicle will not move. See *Shifting Into Park (P) on page 2-26*.

If you are parking on a hill and if you are pulling a trailer, also see *Towing a Trailer on page 4-36*.

Mirrors

Manual Rearview Mirror

Adjust all the mirrors so you can see clearly when you are sitting in a comfortable driving position.

To reduce glare from headlamps behind you, pull the lever at the bottom of the mirror toward you (to the night position). To return the mirror back to the day position, push the lever away from you.

There are two lamps located on the bottom of the mirror. Press the button next to each lamp to turn it on and off.

Manual Rearview Mirror with OnStar[®]

If the vehicle has this mirror, it has a lever located at the bottom of the mirror between the two lamps. The lever is used to change the mirror from the day to the night position. To reduce glare from headlamps behind you while driving at night, pull the lever toward you. To return the mirror to the day position, return the lever to its original position.

There are two map lamps located on the bottom of the mirror. Press the button next to each lamp to turn it on and off.

There are also OnStar[®] buttons located at the bottom of the mirror face. See your dealer for more information on the system and how to subscribe to OnStar[®]. See *OnStar[®] System on page 2-32* for more information about the services OnStar[®] provides.

Automatic Dimming Rearview Mirror

Your vehicle may be equipped with an automatic dimming rearview mirror. Push the center button on the bottom of the mirror to turn this feature on. The mirror will darken gradually to reduce glare from headlamps behind you. This may take a few moments. The mirror will lighten whenever you shift to REVERSE (R).

There are two lamps located on the bottom of the mirror. Press the button next to each lamp to turn it on and off.

One photocell on the front of the mirror senses when it is becoming dark outside. Another photocell, facing rearward, senses headlamps behind you. To turn the automatic dimming feature off, press the center button again.

To keep the photocells operating well, occasionally clean them with a cotton swab and glass cleaner.

Automatic Dimming Rearview Mirror with OnStar®

Your vehicle may have an automatic dimming rearview mirror with the OnStar® System.

Press the button located below the mirror, on the far left, for up to three seconds to turn the automatic dimming feature off and on. While turned on, this mirror functions exactly like the automatic dimming mirror described previously.

There are two lamps located on the bottom of the mirror. Press the button next to each lamp to turn it on and off.

There are also OnStar® buttons located at the bottom of the mirror. See your dealer for more information on the system and how to subscribe to OnStar®. See *OnStar® System on page 2-32* for more information about the service OnStar® provides.

Outside Power Mirrors

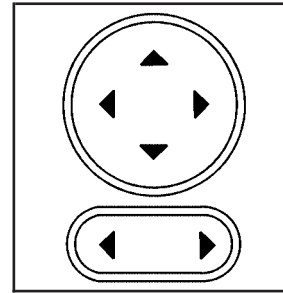

The controls for the outside power mirrors are located on the driver's door armrest.

Use the selector switch located below the four-way control panel to choose either the left or right outside mirror. Then press any of the four arrows located on the control pad to move each mirror in the desired direction.

Adjust each mirror so you can see the side of your vehicle and the area beside and behind your vehicle.

Outside Convex Mirror

Your passenger's side mirror is convex. A convex mirror's surface is curved so you can see more from the driver's seat.

CAUTION:

A convex mirror can make things (like other vehicles) look farther away than they really are. If you cut too sharply into the right lane, you could hit a vehicle on your right. Check your inside mirror or glance over your shoulder before changing lanes.

Outside Heated Mirrors

If your vehicle has this option, the surface of both outside mirrors will heat when you activate the rear window defogger. See "Rear Window Defogger" under *Climate Control System on page 3-19.*

OnStar[®] System



OnStar[®] uses global positioning system (GPS) satellite technology, wireless communications, and live advisors to provide you with a wide range of safety, security, information, and convenience services. If your airbags deploy, the system is designed to make an automatic call to OnStar[®] Emergency where we can request emergency services be sent to your location. If you lock your keys in the car, call OnStar[®] at 1-888-4-ONSTAR and they can send a signal to unlock your doors. If you need roadside assistance, press the OnStar[®] button and they will get you the help you need.

A complete OnStar[®] User's Guide and the Terms and Conditions of the OnStar[®] Subscription Service Agreement are included in the vehicle's glove box literature. For more information, visit www.onstar.com or www.onstar.ca, contact OnStar[®] at 1-888-4-ONSTAR (1-888-466-7827), or press the OnStar[®] button to speak to an OnStar[®] advisor 24 hours a day, 7 days a week.

Terms and conditions of the Subscription Service Agreement can be found at www.onstar.com or www.onstar.ca.

OnStar® Services

For new vehicles equipped with OnStar®, the Safe and Sound Plan is included for one year from the date of purchase. You can extend this plan beyond the first year, or upgrade to the Directions and Connections Plan to meet your needs. For more information, press the OnStar® button to speak to an advisor.

Safe and Sound Plan

- Advanced Automatic Collision Notification
- Automatic Notification of Airbag Deployment
- Emergency Services
- Roadside Assistance
- Stolen Vehicle Tracking
- AccidentAssist
- Remote Door Unlock/Vehicle Alert
- Remote Diagnostics
- Online Concierge

Directions and Connections® Plan

- All Safe and Sound Plan Services
- Driving Directions
- RideAssist
- Information and Convenience Services

OnStar® Personal Calling

As an OnStar® subscriber, the Personal Calling capability allows you to make hands-free calls using a wireless system that is integrated into the vehicle. Calls can be placed nationwide using simple voice commands with no additional contracts and no additional roaming charges. To find out more about OnStar® Personal Calling, refer to the OnStar® User's Guide in the vehicle's glove box, visit www.onstar.com or www.onstar.ca, or speak to an OnStar® advisor by pressing the OnStar® button or calling 1-888-4-ONSTAR (1-888-466-7827).

OnStar® Virtual Advisor

Your vehicle may have Virtual Advisor. It is a feature of OnStar® Personal Calling that uses your minutes to access weather, local traffic reports, and stock quotes. By pressing the phone button and giving a few simple voice commands, you can browse through the various topics. Customize your information profile at www.myonstar.com. See the OnStar® User's Guide for more information.

OnStar® Steering Wheel Controls

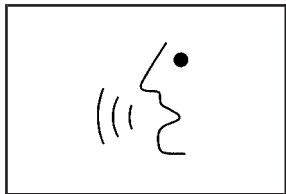

Your vehicle may be equipped with a Talk/Mute button that can be used to interact with OnStar®. See *Audio Steering Wheel Controls* on page 3-83 for more information.

When calling into voice-mail systems, or to dial directory numbers, press this button once, wait for the response, say the number(s) to be dialed, wait for the number(s) to be repeated and then say “dial”. See the OnStar® User’s Guide for more information.

Universal Home Remote System

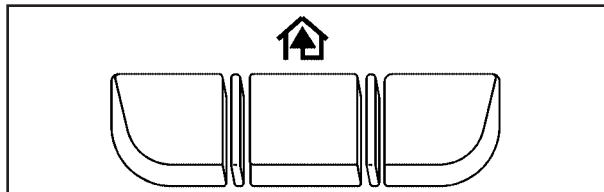

The Universal Home Remote System, provides a way to replace up to three hand-held transmitters used to activate devices such as gate operators, garage door openers, entry door locks, security systems, and home lighting.

If your vehicle has the Universal Home Remote Transmitter, it complies with Part 15 of the FCC Rules. Operation is subject to the following two conditions: (1) this device may not cause harmful interference, and (2) this device must accept any interference received, including interference that may cause undesired operation.

This device complies with RSS-210 of Industry Canada. Operation is subject to the following two conditions: (1) this device may not cause interference, and (2) this device must accept any interference, including interference that may cause undesired operation of the device.

Changes and modifications to this system by other than an authorized service facility could void authorization to use this equipment.

Universal Home Remote System Operation

Do not use the Universal Home Remote with any garage door opener that does not have the stop and reverse feature. This includes any garage door opener model manufactured before April 1, 1982. If you have a newer garage door opener with rolling codes, please be sure to follow Steps 6 through 8 to complete the programming of your Universal Home Remote Transmitter.

Read the instructions completely before attempting to program the Universal Home Remote. Because of the steps involved, it may be helpful to have another person available to assist you in the programming steps.

Keep the original hand-held transmitter for use in other vehicles as well as for future Universal Home Remote programming. It is also recommended that upon the sale of the vehicle, the programmed Universal Home Remote buttons should be erased for security purposes. See "Erasing Universal Home Remote Buttons" later in this section or, for assistance, see *Customer Assistance Offices on page 7-4*.

Be sure that people and objects are clear of the garage door or gate operator you are programming. When programming a garage door, it is advised to park outside of the garage.

It is recommended that a new battery be installed in your hand-held transmitter for quicker and more accurate transmission of the radio-frequency signal.

Programming Universal Home Remote

Follow these steps to program up to three channels:

1. Press and hold down the two outside Universal Home Remote buttons, releasing only when the Universal Home Remote indicator light begins to flash, after 20 seconds. Do not hold down the buttons for longer than 30 seconds and do not repeat this step to program a second and/or third hand-held transmitter to the remaining two Universal Home Remote buttons.
2. Position the end of your hand-held transmitter about 1 to 3 inches (3 to 8 cm) away from the Universal Home Remote buttons while keeping the indicator light in view.
3. Simultaneously press and hold both the desired Universal Home Remote button and the hand-held transmitter button. Do not release the buttons until Step 4 has been completed.

Some entry gates and garage door openers may require you to substitute Step 3 with the procedure noted in "Gate Operator and Canadian Programming" later in this section.

4. The indicator light will flash slowly at first and then rapidly after Universal Home Remote successfully receives the frequency signal from the hand-held transmitter. Release both buttons.
5. Press and hold the newly-trained Universal Home Remote button and observe the indicator light. If the indicator light stays on constantly, programming is complete and your device should activate when the Universal Home Remote button is pressed and released.

To program the remaining two Universal Home Remote buttons, begin with Step 2 under "Programming Universal Home Remote." Do not repeat Step 1 as this will erase all of the programmed channels.

If the indicator light blinks rapidly for two seconds and then turns to a constant light, continue with Steps 6 through 8 following to complete the programming of a rolling-code equipped device, most commonly, a garage door opener.

6. Locate in the garage, the garage door opener receiver (motor-head unit). Locate the "Learn" or "Smart" button. This can usually be found where the hanging antenna wire is attached to the motor-head unit.

7. Firmly press and release the “Learn” or “Smart” button. The name and color of the button may vary by manufacturer.

You will have 30 seconds to start Step 8.

8. Return to the vehicle. Firmly press and hold the programmed Universal Home Remote button for two seconds, then release. Repeat the press/hold/release sequence a second time, and depending on the brand of the garage door opener, or other rolling code device, repeat this sequence a third time to complete the programming.

The Universal Home Remote should now activate your rolling-code equipped device.

To program the remaining two Universal Home Remote buttons, begin with Step 2 of “Programming Universal Home Remote.” You do not want to repeat Step 1, as this will erase all previous programming from the Universal Home Remote buttons.

Gate Operator and Canadian Programming

Canadian radio-frequency laws require transmitter signals to time out or quit after several seconds of transmission. This may not be long enough for Universal Home Remote to pick up the signal during programming. Similarly, some U.S. gate operators are manufactured to time out in the same manner.

If you live in Canada, or you are having difficulty programming a gate operator or garage door opener by using the “Programming Universal Home Remote” procedures, regardless of where you live, replace Step 3 under “Programming Universal Home Remote” with the following:

Continue to press and hold the Universal Home Remote button while you press and release every two seconds (cycle) the hand-held transmitter button until the frequency signal has been successfully accepted by the Universal Home Remote. The Universal Home Remote indicator light will flash slowly at first and then rapidly. Proceed with Step 4 under “Programming Universal Home Remote” to complete.

Using Universal Home Remote

Press and hold the appropriate Universal Home Remote button for at least half of a second. The indicator light will come on while the signal is being transmitted.

Erasing Universal Home Remote Buttons

To erase programming from the three Universal Home Remote buttons do the following:

1. Press and hold down the two outside buttons until the indicator light begins to flash, after 20 seconds. Do not hold the two outside buttons for longer than 30 seconds.
2. Release both buttons.

The Universal Home Remote is now in the training (learning) mode and can be programmed at any time beginning with Step 2 under “Programming Universal Home Remote” shown earlier in this section.

Individual buttons cannot be erased, but they can be reprogrammed. See “Reprogramming a Single Universal Home Remote Button” following this section.

Reprogramming a Single Universal Home Remote Button

To program a device to Universal Home Remote using a Universal Home Remote button previously trained, follow these steps:

1. Press and hold the desired Universal Home Remote button. Do not release the button.
2. The indicator light will begin to flash after 20 seconds. While still holding the Universal Home Remote button, proceed with Step 2 under “Programming Universal Home Remote” shown earlier in this section.

For additional information on Universal Home Remote, see *Customer Assistance Offices on page 7-4*.

Storage Areas

Glove Box

To open the glove box, lift up on the lever.

Cupholder(s)

Your vehicle is equipped with cupholders located between the front seats and in the rear seat armrest.

Center Console Storage Area

The console has cupholders and a storage area. To open the console's storage area, press the latch located toward the front of the console lid on the driver's side of the vehicle.

Rear Seat Armrest

Your vehicle has a rear seat armrest with cupholders. To access, pull the tab on the armrest forward.

Convenience Net

The vehicle may have a convenience net located on the back wall of the trunk.

The net is not for larger, heavier loads. Store those in the trunk as far forward as possible.

Unhook the net so that it will lie flat when not in use.

Sunroof

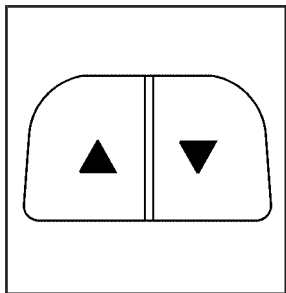

If your vehicle is equipped with a sunroof, the sunroof switches are located on the overhead console.

The sunroof can only be operated when the ignition is in ACCESSORY, RUN, or when Retained Accessory Power (RAP) is active. See *Retained Accessory Power (RAP)* on page 2-19.

▲ (Vent/Express-Open): To vent the sunroof when it is closed, press this switch once. When using the vent, the sunshade should be fully opened. The sunshade can be opened or closed manually by sliding it rearward or forward.

From the vent position, press this switch again to activate the express-open feature. Press the close switch to stop movement of the sunroof. The sunshade will automatically open when using express-open.

A deflector will automatically pop up when the sunroof is opened. The deflector will retract when the sunroof is closed.

▼ (Close): To close the sunroof, press and hold this switch until the sunroof motor stops, or release the switch when the desired position has been reached.

Section 3 Instrument Panel

Instrument Panel Overview	3-4	Parade Dimming	3-17
Hazard Warning Flashers	3-6	Reading Lamps	3-17
Other Warning Devices	3-6	Battery Run-Down Protection	3-17
Horn	3-6	Accessory Power Outlet(s)	3-17
Tilt Wheel	3-6	Ashtray(s) and Cigarette Lighter	3-18
Turn Signal/Multifunction Lever	3-7	Climate Controls	3-19
Turn and Lane-Change Signals	3-7	Climate Control System	3-19
Headlamp High/Low-Beam Changer	3-8	Outlet Adjustment	3-22
Flash-to-Pass	3-8	Passenger Compartment Air Filter	3-23
Windshield Wipers	3-8	Warning Lights, Gages, and Indicators	3-24
Windshield Washer	3-9	Instrument Panel Cluster	3-25
Cruise Control	3-10	Speedometer and Odometer	3-26
Exterior Lamps	3-13	Tachometer	3-26
Delayed Headlamps	3-14	Safety Belt Reminder Light	3-26
Daytime Running Lamps (DRL)/Automatic Headlamp System	3-14	Passenger Safety Belt Reminder Light	3-27
Fog Lamps	3-15	Airbag Readiness Light	3-27
Instrument Panel Brightness	3-15	Passenger Airbag Status Indicator	3-28
Courtesy Lamps	3-15	Charging System Light	3-30
Dome Lamp	3-15	Brake System Warning Light	3-31
Entry Lighting	3-16	Anti-Lock Brake System Warning Light	3-32
Delayed Entry Lighting	3-16	Traction Control System (TCS) Warning Light	3-32
Delayed Exit Lighting	3-16	Engine Coolant Temperature Warning Light	3-33

Section 3 Instrument Panel

Engine Coolant Temperature Gage	3-33	Audio System(s)	3-59
Tire Pressure Light	3-34	Setting the Time (Without Date Display)	3-60
Malfunction Indicator Lamp	3-34	Setting the Time (With Date Display)	3-61
Oil Pressure Light	3-37	Radio with CD (Base)	3-62
Security Light	3-37	Radio with CD (MP3)	3-67
Fog Lamp Light	3-38	Theft-Deterrent Feature	3-82
Cruise Control Light	3-38	Audio Steering Wheel Controls	3-83
Highbeam On Light	3-38	Radio Reception	3-83
Fuel Gage	3-38	Care of Your CDs	3-84
Driver Information Center (DIC)	3-39	Care of the CD Player	3-84
DIC Operation and Displays	3-40	Backglass Antenna	3-85
DIC Warnings and Messages	3-46	XM™ Satellite Radio Antenna System	3-85
DIC Vehicle Customization	3-53		

Instrument Panel Overview

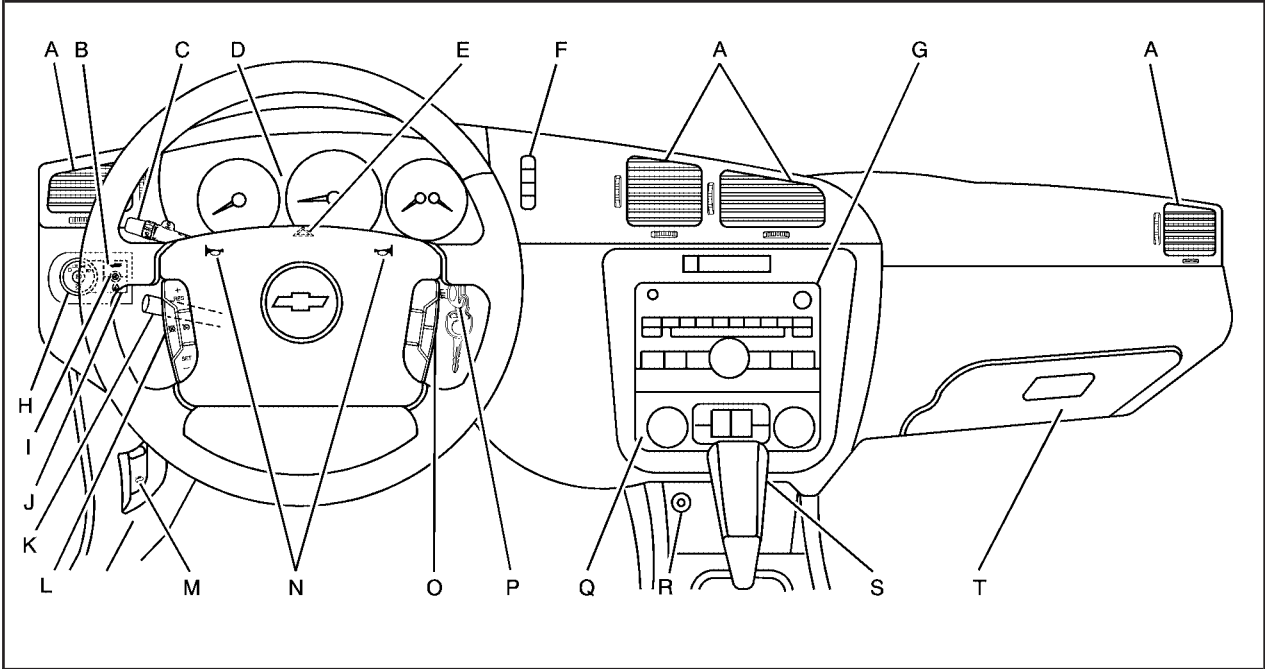

The main components of your instrument panel are listed here:

- A. Air Vent. See *Outlet Adjustment on page 3-22.*
- B. Remote Trunk Release Button. See “Remote Trunk Release” under *Trunk on page 2-11.*
- C. Multifunction Lever. See *Turn Signal/Multifunction Lever on page 3-7.*
- D. Instrument Panel Cluster. See *Instrument Panel Cluster on page 3-25.*
- E. Hazard Warning Flasher Button. See *Hazard Warning Flashers on page 3-6.*
- F. Driver Information Center (DIC) Buttons. See *Driver Information Center (DIC) on page 3-39.*
- G. Audio System. See *Audio System(s) on page 3-59.*
- H. Exterior Lamps Control. See *Exterior Lamps on page 3-13.*
- I. Instrument Panel Brightness. See *Instrument Panel Brightness on page 3-15.*
- J. Traction Control On/Off Button (If Equipped). See *Traction Control System (TCS) on page 4-9.*
- K. Tilt Steering Wheel Lever. See *Tilt Wheel on page 3-6.*
- L. Steering Wheel Cruise Control (If Equipped). See *Cruise Control on page 3-10.*
- M. Hood Release. See *Hood Release on page 5-11.*
- N. Horn. See *Horn on page 3-6.*
- O. Audio Steering Wheel Controls (If Equipped). See *Audio Steering Wheel Controls on page 3-83.*
- P. Ignition Switch. See *Ignition Positions on page 2-18.*
- Q. Climate Controls. See *Climate Control System on page 3-19.*
- R. Accessory Power Outlet. See *Accessory Power Outlet(s) on page 3-17.*
- S. Automatic Transaxle Shift Lever. See *Automatic Transaxle Operation on page 2-22.*
- T. Glove Box. See *Glove Box on page 2-39.*

Hazard Warning Flashers

The hazard warning flashers let you warn others. They also let police know you have a problem. Your front and rear turn signal lamps will flash on and off.

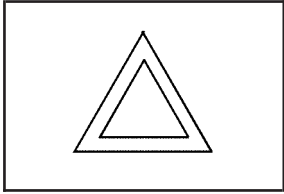

The hazard warning flasher button is located on top of the steering column.

The hazard warning flashers work no matter what position the key is in, and even if the key is not in.

Press the button to make the front and rear turn signal lamps flash. Press the button again to turn the flashers off.

When the hazard warning flashers are on, the turn signals will not work.

Other Warning Devices

If you carry reflective triangles, you can set them up at the side of the road about 300 feet (100 m) behind your vehicle.

Horn

Press near or on the horn symbols on your steering wheel pad to sound the horn.

Tilt Wheel

A tilt wheel allows you to adjust the steering wheel before you drive. You can raise the steering wheel to the highest level to give your legs more room when you enter and exit the vehicle.

The lever that allows you to tilt the steering wheel is located on the left side of the steering column.

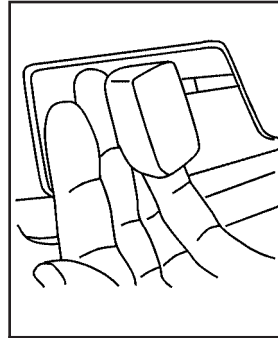



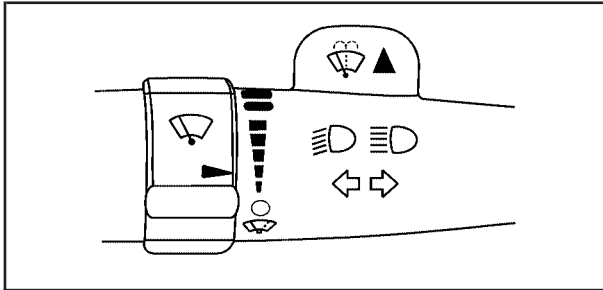

To tilt the wheel, hold the wheel and pull the lever. Then move the wheel to a comfortable position and release the lever to lock the wheel in place.

Turn Signal/Multifunction Lever



The lever on the left side of the steering column includes the following:

-  Turn and Lane Change Signals. See *Turn and Lane-Change Signals* on page 3-7.
-  Headlamp High/Low-Beam Changer. See *Headlamp High/Low-Beam Changer* on page 3-8.
- Flash-to-Pass. See *Flash-to-Pass* on page 3-8.
-  Windshield Wipers. See *Windshield Wipers* on page 3-8.
-  Windshield Washer. See *Windshield Washer* on page 3-9.

For information on the headlamps, see *Exterior Lamps* on page 3-13.

Turn and Lane-Change Signals

The turn signal has two upward (for right) and two downward (for left) positions. These positions allow you to signal a turn or a lane change.

To signal a turn, move the lever all the way up or down. When the turn is finished, the lever will return automatically.

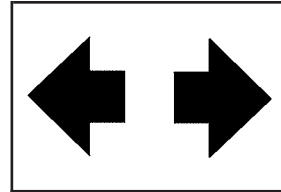

An arrow on the instrument panel cluster will flash in the direction of the turn or lane change.

To signal a lane change, raise or lower the lever until the arrow starts to flash. Hold it there until you complete your lane change. The lever will return by itself when you release it.

If the arrow flashes faster than normal as you signal a turn or a lane change, a signal bulb may be burned out and other drivers won't see your turn signal.

If a bulb is burned out, replace it to help avoid an accident. If the arrows don't go on at all when you signal a turn, check for burned-out bulbs and then check the fuse. See *Fuses and Circuit Breakers* on page 5-95.

Turn Signal On Chime

If you leave either one of your turn signals on and drive more than three-quarters of a mile (1.2 km), a chime will sound to alert you.

Headlamp High/Low-Beam Changer

To change your headlamps from low beams to high beams, or from high to low, pull the multifunction lever all the way toward you. Then release it.

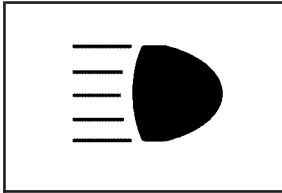

While the high beams are on, this light will appear on the instrument panel cluster.

This light works only while the key is in RUN. The fog lamps (if equipped) are not illuminated when the high beams are on.

Flash-to-Pass

With the turn signal lever in the low-beam position, pull the lever toward you momentarily to switch to high-beam, (to signal you are going to pass).

If the headlamps are on, they will return to low-beam when the lever is released.

This feature operates even if the headlamps are off.

Windshield Wipers

Be sure to clear ice and snow from the wiper blades before using them. If they are frozen to the windshield, gently loosen or thaw them. Damaged wiper blades may not clear the windshield well, making it harder to see and drive safely. If the blades do become damaged, install new blades or blade inserts. For more information, see *Windshield Wiper Blade Replacement on page 5-52*

Heavy snow or ice can overload the wiper motor. A circuit breaker will stop the motor until it cools down. Clear away snow or ice to prevent an overload.

You control the windshield wipers by turning the band with the wiper symbol on it.

 **(Mist):** For a single wiping cycle, turn the band to mist. Hold it there until the wipers start. Then let go. The wipers will stop after one wipe. If you want more wipes, hold the band on mist longer.

 **(Delay):** You can set the wiper speed for a long or short delay between wipes. This can be very useful in light rain or snow. Turn the band to choose the delay time. The closer to the top of the lever, the shorter the delay.

 **(Low Speed):** For steady wiping at low speed, turn the band away from you to the first solid band past the delay settings. For high-speed wiping, turn the band further, to the second solid band past the delay settings. To stop the wipers, move the band to off.

 **(High Speed):** For high-speed wiping, turn the band further, to the second solid band past the delay settings.

 **(Off):** To stop the wipers, move the band to off.

Windshield Washer

At the top of the multifunction lever, there's a paddle with the windshield washer symbol on it. To spray washer fluid on the windshield, push the paddle. The wipers will run for several sweeps and then either stop or return to your preset speed. The ignition key must be in ACCESSORY or RUN for this to work. See *Windshield Washer Fluid on page 5-39*.

CAUTION:

In freezing weather, do not use your washer until the windshield is warmed. Otherwise the washer fluid can form ice on the windshield, blocking your vision.

When you are low on washer fluid, a message will be illuminated in the Driver Information Center (DIC) for 60 seconds. When the ignition is turned off, a message will appear again for three seconds as a reminder that the fluid level is low. For more information on DIC messages, see *DIC Warnings and Messages on page 3-46*.

The washer fluid message will no longer display when the washer fluid reservoir has been filled.

Cruise Control

With cruise control, you can maintain a speed of about 25 mph (40 km/h) or more without keeping your foot on the accelerator. This can really help on long trips. Cruise control does not work at speeds below about 25 mph (40 km/h).

When you apply your brakes, cruise control is turned off.

CAUTION:

Cruise control can be dangerous where you cannot drive safely at a steady speed. So, do not use your cruise control on winding roads or in heavy traffic.

Cruise control can be dangerous on slippery roads. On such roads, fast changes in tire traction can cause excessive wheel slip, and you could lose control. Do not use cruise control on slippery roads.

If your vehicle is in cruise control when the traction control system (if equipped) begins to limit wheel spin, the cruise control will automatically disengage.

See *Traction Control System (TCS)* on page 4-9. When road conditions allow you to safely use it again, you may turn the cruise control back on.

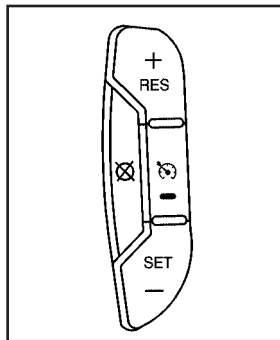

The cruise control buttons are located on left side of the steering wheel.

 **(On/Off):** Press this button to turn cruise control on and off. The indicator will be lit when cruise control is on.

+ RES (Resume/Accelerate): Press this button to make the vehicle accelerate or resume to a previously set speed.

SET-: Press this button to set the speed or make the vehicle decelerate.

 **(Cancel):** Press this button to cancel cruise control.

Setting Cruise Control

Cruise control will not work if your parking brake is set, or if the master cylinder brake fluid level is low.

The cruise control light on the instrument panel cluster will come on after the cruise control has been set to the desired speed.

CAUTION:

If you leave your cruise control on when you are not using cruise, you might hit a button and go into cruise when you do not want to. You could be startled and even lose control. Keep the cruise control switch off until you want to use cruise control.

1. Press the cruise control On/Off button.
2. Get up to the speed you want.
3. Press and release the SET- button located on the steering wheel.
4. Take your foot off the accelerator.

Resuming a Set Speed

Suppose you set your cruise control at a desired speed and then you apply the brake. This shuts off the cruise control. But you do not need to reset it.

Once you are driving about 25 mph (40 km/h) or more, press the +RES button on your steering wheel. The vehicle will go back to your chosen speed and stay there.

Increasing Speed While Using Cruise Control

To increase the cruise speed while using cruise control:

- Press and hold the +RES button on the steering wheel until you reach your new desired speed, then release it.
- To increase vehicle speed in small increments, press the +RES button.

Reducing Speed While Using Cruise Control

To reduce your speed while using cruise control:

- Press and hold the SET- button on the steering wheel until you reach the lower speed you want, then release it.
- To slow down in very small amounts, press the SET- button on the steering wheel briefly. Each time you do this, you will go about 1 mph (1.6 km/h) slower.

Passing Another Vehicle While Using Cruise Control



Use the accelerator pedal to increase vehicle speed. When you take your foot off the pedal, your vehicle will slow down to the cruise speed you set earlier.

Using Cruise Control on Hills

How well your cruise control will work on hills depends upon your speed, load and the steepness of the hills. When going up steep hills, you may have to step on the accelerator pedal to maintain your speed. When going downhill, you may have to brake or shift to a lower gear to keep your speed down. Of course, applying the brake takes you out of cruise control. Many drivers find this to be too much trouble and do not use cruise control on steep hills.

Ending Cruise Control

There are three ways to end cruise control:

- Step lightly on the brake pedal.
- Press the  (cancel) button on the steering wheel.
- Press the  (on/off) button on the steering wheel.

Erasing Speed Memory

When you turn off the cruise control or the ignition, your cruise control set speed memory is erased.

Exterior Lamps

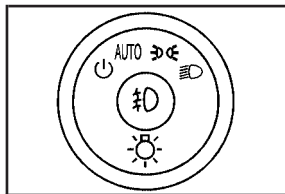

The exterior lamps control is located on the instrument panel to the left of the steering wheel.

It controls the following systems:

- Headlamps
- Taillamps
- Parking Lamps
- License Plate Lamps
- Instrument Panel Lights
- Fog Lamps (if equipped)

The exterior lamps control has four positions:

⏻ (Off): Momentarily turn the control to this position to turn off the automatic light control. Momentarily turn to this position again to turn automatic light control on again.

AUTO (Automatic): Turn the control to this position to automatically turn on the headlamps at normal brightness, together with the following:

- Parking Lamps
- Taillamps

- License Plate Lamps
- Instrument Panel Lights

🚗 (Parking Lamps): Turn the control to this position to turn on the parking lamps together with the following:

- Taillamps
- License Plate Lamps
- Instrument Panel Lights

🚗 (Headlamps): Turn the control to this position to turn on the headlamps together with the following lamps listed below. A warning chime will sound if you open the driver's door when the ignition switch is off and the headlamps are on.

- Parking Lamps
- Taillamps
- License Plate Lamps
- Instrument Panel Lights

🚗 (Fog Lamps, If Equipped): Push the fog lamps control in to turn on the fog lamps.

See *Fog Lamps on page 3-15*.

Delayed Headlamps

The delayed headlamps feature provides a period of exterior lighting as you leave the area around your vehicle. The feature is activated when the headlamps are on due to the automatic headlamps control feature later described in this section, and when the ignition is turned off. Your headlamps will then remain on until the exterior lamps control is moved to the parking lamps position or until either a 30 second or 60 second lighting period has ended.

If you turn off the ignition with the headlamps switch in the parking lamps or headlamps position, the delayed headlamps cycle will not occur.

To disable the delayed headlamps feature or change the time of delay, see “Exit Lighting” under *DIC Vehicle Customization on page 3-53*.

Daytime Running Lamps (DRL)/ Automatic Headlamp System

Daytime Running Lamps (DRL) can make it easier for others to see the front of your vehicle during the day. DRL can be helpful in many different driving conditions, but they can be especially helpful in the short periods after dawn and before sunset. Fully functional daytime running lamps are required on all vehicles first sold in Canada.

A light sensor on top of the instrument panel makes the DRL work, so be sure it is not covered.

The DRL system’s automatic headlamp control will make the low-beam headlamps come on at a reduced brightness when the following conditions are met:

- The ignition is in RUN.
- The exterior lamps control is in AUTO.
- The engine is running.

When the DRL are on, only the low-beam headlamps, at a reduced level of brightness, will be on. The headlamps, taillamps, sidemarker, and other lamps will not be on. The instrument panel and cluster will also not be lit.

When it is dark enough outside, your low-beam headlamps will turn off and the headlamps and parking lamps will turn on. The other lamps that come on with the headlamps will also come on.

When it is bright enough outside, the headlamps will go off and the DRL will come on.

As with any vehicle, you should turn on the regular headlamp system when you need it.

Fog Lamps

 **(Fog Lamps):** If your vehicle is equipped with fog lamps, it is located on the exterior lamps control. The exterior lamps control is located on the instrument panel to the left of the steering column.

Your ignition must be in RUN for the fog lamps to illuminate.

To turn the fog lamps on, press exterior lamps button. A light will come on in the button to let you know that the fog lamps are on. Press the exterior lamps button again to turn the fog lamps off.

The ignition must be in RUN and the parking lamps must be on for your fog lamps to work. The parking lamps will turn on automatically when you turn on the fog lamps.

The fog lamps will go off while you change to high-beam headlamps.

Some localities have laws that require the headlamps to be on along with the fog lamps.

Instrument Panel Brightness

 **(Instrument Panel Brightness):** The knob with this symbol on it is located next to the exterior lamps control. Push and pull the knob out halfway and then turn the knob clockwise to brighten or counterclockwise to dim the lights.

Courtesy Lamps

When a door is opened, the courtesy lamps automatically come on. They make it easy for you to enter and leave your vehicle. You can also manually turn these lamps on by turning the instrument panel brightness control clockwise all the way.

The reading lamps, located on the rearview mirror, can be turned on or off independent of the automatic courtesy lamps, when the doors are closed.

Dome Lamp

The dome lamp will come on when you open a door. You can also turn this lamp on by turning the instrument panel brightness control clockwise.

Entry Lighting

Your vehicle may have the entry lighting feature. Your courtesy lamps will come on and stay on for a set time whenever you press UNLOCK on the remote keyless entry transmitter, if equipped.

If you open a door, the lamps will stay on while it's open and then turn off automatically about 25 seconds after you close it. If you press UNLOCK and don't open a door, the lamps will turn off after about 40 seconds.

Illuminated entry includes a feature called theater dimming. With theater dimming, the lamps don't just turn off at the end of the delay time. Instead, they slowly dim after the delay time until they go out. The delay time is canceled if you turn the ignition key to RUN or press the power door lock switch.

When the ignition is on, illuminated entry is inactive, which means the courtesy lamps won't come on unless a door is opened.

Delayed Entry Lighting

Delayed entry lighting illuminates the interior for a period of time after all the doors have been closed.

The ignition must be off for delayed entry lighting to work. Immediately after both doors have been closed, the delayed entry lighting feature will continue to work until one of the following occurs:

- The ignition is in RUN.
- The doors are locked.
- An illumination period of 20 seconds has elapsed.

If during the illumination period a door is opened, the timed illumination period will be canceled and the interior lamps will remain on.

Delayed Exit Lighting

This feature illuminates the interior for a period of time after the key is removed from the ignition.

The ignition must be off for delayed exit lighting to work. When the key is removed, interior illumination will activate and remain on until one of the following occurs:

- The ignition is in RUN.
- The power door locks are activated.
- An illumination period of 20 seconds has elapsed.

If during the illumination period a door is opened, the timed illumination period will be canceled and the interior lamps will remain on because a door is open.

Parade Dimming

The instrument panel has an added feature called parade dimming. This feature prohibits the dimming of your instrument panel displays during the daylight while the headlamps are on so that you'll still be able to see the displays.

Reading Lamps

The reading lamps are located on the rearview mirror. Press the button to turn them on and off.

Battery Run-Down Protection

Your vehicle has a feature to help prevent you from draining the battery in case you accidentally leave on the interior courtesy lamps, reading/map lamps, visor vanity lamps, trunk lamp or glove box lamps. If you leave any of these lamps on, they will automatically turn off after 10 minutes, if the ignition is off. The lamps won't come back on again until you do the following:

- Turn the ignition on.
- Turn the exterior lamps control off, then on again.

If your vehicle has less than 15 miles (25 km) on the odometer, the battery saver will turn off the lamps after only three minutes.

Battery rundown protection will also work if the headlamps are left on. After having been left on for 10 minutes, the headlamps and the parking lamps will flash three times. They will remain on for one more minute before turning off automatically.

Accessory Power Outlet(s)

Your vehicle has a two 12-volt outlets which can be used to plug in electrical equipment such as a cellular telephone, a compact disc player, etc.

One is located at the front of the console and the other is located at the rear of the console. Lift the cover to access the outlet. When not using the outlet, make sure the protective cover is in place.

Notice: Leaving electrical equipment on for extended periods will drain the battery. Always turn off electrical equipment when not in use and do not plug in equipment that exceeds the maximum amperage rating.

Certain accessory power plugs may not be compatible with the accessory power outlet and could result in blown vehicle or adapter fuses. If you experience a problem see your dealer for additional information on the accessory power plugs.

Notice: Adding any electrical equipment to your vehicle may damage it or keep other components from working as they should. The repairs would not be covered by your warranty. Do not use equipment exceeding maximum amperage rating. Check with your dealer before adding electrical equipment.

When adding electrical equipment, be sure to follow the proper installation instructions included with the equipment. Check with your dealer before adding electrical equipment, and never use anything that exceeds the amperage rating.

Notice: Improper use of the power outlet can cause damage not covered by your warranty. Do not hang any type of accessory or accessory bracket from the plug because the power outlets are designed for accessory power plugs only.

Ashtray(s) and Cigarette Lighter

Notice: If you put papers, pins, or other flammable items in the ashtray, hot cigarettes or other smoking materials could ignite them and possibly damage your vehicle. Never put flammable items in the ashtray.

Your vehicle may have a cigarette lighter and ashtray located on the console. The ashtray is removable and has a cupholder and liner underneath. To remove the ashtray, lift it up with the liner and pull it out.

Notice: Holding a cigarette lighter in while it is heating will not allow the lighter to back away from the heating element when it is hot. Damage from overheating may occur to the lighter or heating element, or a fuse could be blown. Do not hold a cigarette lighter in while it is heating.

To activate the cigarette lighter, push it into the heating element and let go. When the lighter is ready it will pop out by itself.

Climate Controls

Climate Control System

Your vehicle may be equipped with a dual or single climate control system. With this system you can control the heating, cooling, defrost, defog, and ventilation for your vehicle.

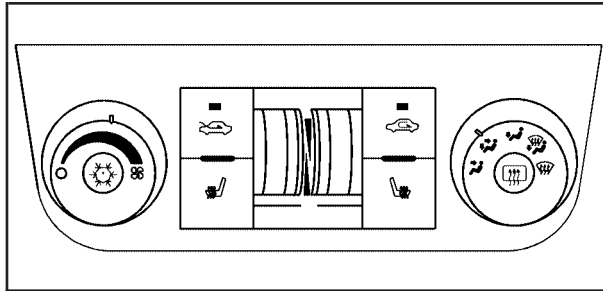

Dual Zone with Optional Heated Seat Controls

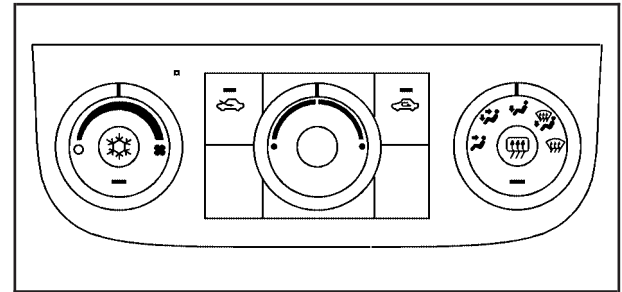



Single Zone

Manual Operation

Turn the right knob clockwise or counterclockwise to direct the airflow inside of your vehicle.

To change the current mode, select one of the following:

 **(Vent):** This mode directs air to the instrument panel outlets.

 **(Bi-Level):** This mode directs approximately half of the of air to the instrument panel outlets and the other half to the floor outlets.

 **(Floor):** This mode directs most of the air to the floor outlets, with some of the air directed to the windshield and side window outlets. In this mode, the system will automatically select Outside Air.

The right knob can also be used to select defog or defrost mode. For more information, see “Defogging and Defrosting” later in this section.

By positioning the right knob between two modes, a combination of those two modes is selected.

The air conditioning compressor will be engaged unless the outside temperature is 40°F (4°C) or below. Recirculation cannot be selected when in Floor mode.

 **(Fan):** Turn the left knob clockwise or counterclockwise to increase or decrease the fan speed. If the airflow seems low when the fan is at the highest setting, the passenger compartment air filter, if equipped, may need to be replaced. For more information, see *Passenger Compartment Air Filter on page 3-23* and *Scheduled Maintenance on page 6-4*.

 **(Outside Air):** When this mode is on, outside air will circulate throughout your vehicle. When the button is pressed, an indicator light in the button will come on to let you know that it is activated. Outside air cannot be used with the recirculation mode.

 **(Recirculation):** When the button is pressed, an indicator light will come on.

This mode keeps outside air from entering the vehicle. It can be used to prevent outside air and odors from entering your vehicle. Recirculation may also help heat or cool the air inside your vehicle more quickly once the temperature inside the vehicle is equal to or better than the outside temperature. The recirculation mode cannot be used with outside air, floor, defrost, or defog modes.

Temperature Control: Rotate the thumbwheels up or down to increase or decrease the temperature on the driver's side or the passenger side of the vehicle for the dual zone system. Turn the center knob clockwise or counterclockwise to increase or decrease the temperature for the single zone system.

 **(Air Conditioning):** Press this button to turn the air conditioning system on or off. When A/C is pressed, an indicator light will come on to let you know that the air conditioning has been activated.

On hot days, open the windows to let hot inside air escape; then close them. This helps to reduce the time it takes for your vehicle to cool down. It also helps the system to operate more efficiently.

For quick cool down on hot days, do the following:

1. Select the vent mode.
2. Select the outside air.
3. Select A/C.
4. Select the coolest temperature for both zones.
5. Select the highest fan speeds.
6. Once the vehicle's interior temperature is below the outside temperature, select recirculation mode for enhanced cooling.

Using these settings together for long periods of time may cause the air inside of your vehicle to become too dry. To prevent this from happening, after the air inside of your vehicle has cooled, turn the recirculation mode off.

The air conditioning system removes moisture from the air, so you may sometimes notice a small amount of water dripping underneath your vehicle while idling or after turning off the engine. This is normal.

Defogging and Defrosting

Fog on the inside of the windows is a result of high humidity (moisture) condensing on the cool window glass. This can be minimized if the climate control system is used properly. There are two modes to clear fog or frost from your windshield. Use the defog mode to clear the windows of fog or moisture and warm the passengers. Use the defrost mode to remove fog or frost from the windshield more quickly.

Turn the right knob clockwise to select the defog or defrost mode. Do not drive the vehicle until all the windows are clear.

 **(Defog):** This mode directs air equally to the windshield and the floor outlets. When you select this mode, the system turns off recirculation and runs the air conditioning compressor unless the outside temperature is below 40°F (4°C). The recirculation mode cannot be selected while in the defog mode.

 **(Defrost):** This mode directs most of the air to the windshield, side window vents, and to the floor vents. In this mode, the system will automatically force outside air into your vehicle. The recirculation mode cannot be selected while in the defog mode. The air conditioning compressor will run automatically in this setting, unless the outside temperature is below 40°F (4°C).

Rear Window Defogger

The rear window defogger uses a warming grid to remove fog from the rear window.

 : The rear window defogger will turn off automatically after it has been activated. The duration the rear window defogger is on will be longer if the vehicle is being driven. The defogger can also be turned off by pressing the button again or by turning off the engine.

The heated outside rearview mirrors will heat to help clear fog or frost from the surface of the mirror when the rear window defogger button is on.

Notice: Do not use anything sharp on the inside of the rear window. If you do, you could cut or damage the warming grid, and the repairs would not be covered by your warranty. Do not attach a temporary vehicle license, tape, a decal or anything similar to the defogger grid.

Outlet Adjustment

Use the knob located below or to the side of the outlet, to change the direction of the air flow.

Operation Tips

- Clear away any ice, snow or leaves from the air inlets at the base of the windshield that may block the flow of air into your vehicle.
- Use of non-GM approved hood deflectors may adversely affect the performance of the system.
- Keep the path under the front seats clear of objects to help circulate the air inside your vehicle more effectively.
- If the airflow seems low when the fan is at the highest setting, the passenger compartment air filter, if equipped, may need to be replaced. For more information, see *Passenger Compartment Air Filter* on page 3-23 and *Scheduled Maintenance* on page 6-4.

Passenger Compartment Air Filter

Your vehicle has a passenger compartment particulate air filter. It is located underneath the hood just below the windshield wiper arm on the passenger's side of the vehicle, underneath the air inlet grille.

The filter traps most of the pollen from air entering the climate control system. Like the engine's air cleaner/filter, it may need to be changed periodically to ensure system performance. For information on how often to change the passenger compartment air filter, see *Scheduled Maintenance on page 6-4*.

To change the passenger compartment air filter, use the following steps:

1. Turn off the ignition when the windshield wipers are in the up position.
2. Raise the vehicle hood.
3. Disconnect the windshield washer pump hose from the fender rail and air inlet grille.
4. Peel back the hood weatherstrip from the passenger's side of the vehicle halfway to center.
5. Remove the air inlet grille retainers.
6. Remove the air inlet grille.
7. Remove the water deflector plate.
8. Remove the old passenger compartment air filter.
9. Reverse the steps to install the new air filter.

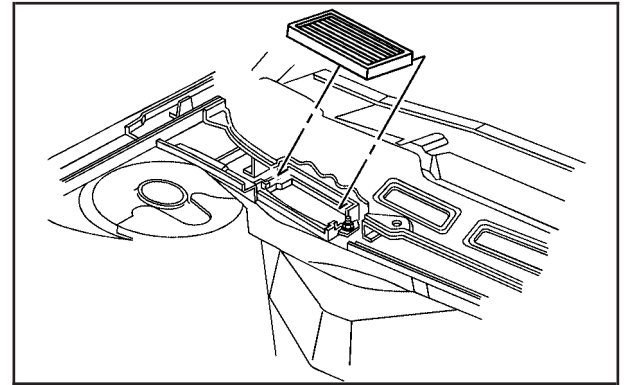

For the type of filter to use, see *Normal Maintenance Replacement Parts on page 6-13*.

Warning Lights, Gages, and Indicators

This part describes the warning lights and gages that may be on your vehicle. The pictures will help you locate them.

Warning lights and gages can signal that something is wrong before it becomes serious enough to cause an expensive repair or replacement. Paying attention to your warning lights and gages could also save you or others from injury.

Warning lights come on when there may be or is a problem with one of your vehicle's functions. As you will see in the details on the next few pages, some warning lights come on briefly when you start the engine just to let you know they're working. If you are familiar with this section, you should not be alarmed when this happens.

Gages can indicate when there may be or is a problem with one of your vehicle's functions. Often gages and warning lights work together to let you know when there's a problem with your vehicle.

When one of the warning lights comes on and stays on when you are driving, or when one of the gages shows there may be a problem, check the section that tells you what to do about it. Please follow this manual's advice. Waiting to do repairs can be costly – and even dangerous. So please get to know your warning lights and gages. They're a big help.

Your vehicle may also have a Driver Information Center (DIC) that works along with the warning lights and gages. See *Driver Information Center (DIC)* on page 3-39.

Instrument Panel Cluster

Your instrument panel cluster is designed to let you know at a glance how your vehicle is running. You will know how fast you are going, about how much fuel is in your tank and many other things you need to drive safely and economically.

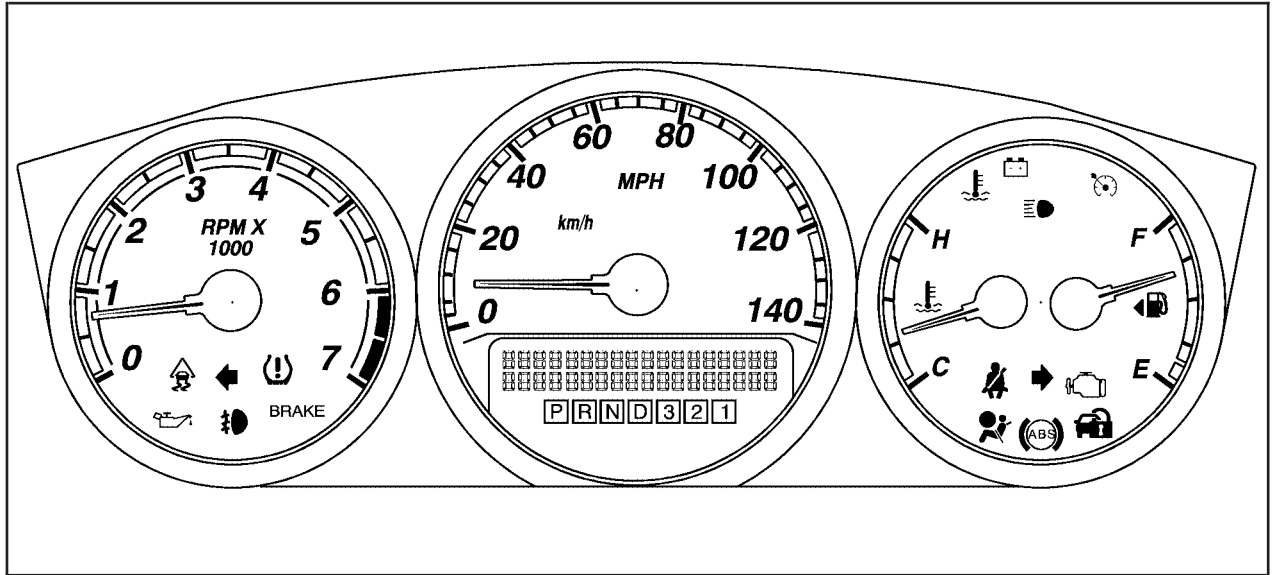

United States Uplevel shown, Base and Canada similar

Speedometer and Odometer

Your speedometer lets you see your speed in both miles per hour (mph) and kilometers per hour (km/h). Your odometer shows how far your vehicle has been driven in either miles (used in the United States) or in kilometers (used in Canada).

Your vehicle has a tamper-resistant odometer. If you see ERROR, you'll know someone has probably tampered with it and the numbers may not be accurate.

You may wonder what happens if your vehicle needs a new odometer installed. If the new one can be set to the mileage total of the old odometer, then that will be done. But if it can't, then it will be set at zero and a label must be put on the driver's door to show the old mileage reading when the new odometer was installed.

Tachometer

Notice: If you operate the engine with the tachometer in the shaded warning area, your vehicle could be damaged, and the damages would not be covered by your warranty. Do not operate the engine with the tachometer in the shaded warning area.

The tachometer displays the engine speed in revolutions per minute (rpm).

Safety Belt Reminder Light

When the key is turned to RUN, a chime will come on for several seconds to remind people to fasten their safety belts, unless the driver's safety belt is already buckled.



This chime and light will be repeated if the passenger remains unbuckled and the vehicle is in motion.

The safety belt light will also come on and stay on for several seconds, then it will flash for several more.

Passenger Safety Belt Reminder Light

Several seconds after the key is turned to RUN or START, a chime will sound for several seconds to remind the front passenger to buckle their safety belt. This would only occur if the passenger airbag is enabled. See *Passenger Sensing System on page 1-60* for more information. The passenger safety belt light will also come on and stay on for several seconds, then it will flash for several more.



This chime and light will be repeated if the passenger remains unbuckled and the vehicle is in motion.

If the passenger's safety belt is buckled, neither the chime nor the light will come on.

Airbag Readiness Light

There is an airbag readiness light on the instrument panel, which shows the airbag symbol. The system checks the airbag's electrical system for malfunctions. The light tells you if there is an electrical problem. The system check includes the airbag sensors, the airbag modules, the wiring and the crash sensing and diagnostic module. For more information on the airbag system, see *Airbag System on page 1-52*.



This light will come on when you start your vehicle, and it will flash for a few seconds. Then the light should go out. This means the system is ready.

If the airbag readiness light stays on after you start the vehicle or comes on when you are driving, your airbag system may not work properly. Have your vehicle serviced right away.

CAUTION:

If the airbag readiness light stays on after you start your vehicle, it means the airbag system may not be working properly. The airbags in your vehicle may not inflate in a crash, or they could even inflate without a crash. To help avoid injury to yourself or others, have your vehicle serviced right away if the airbag readiness light stays on after you start your vehicle.

The airbag readiness light should flash for a few seconds when you turn the ignition key to RUN. If the light does not come on then, have it fixed so it will be ready to warn you if there is a problem.

Passenger Airbag Status Indicator

Your vehicle has the passenger sensing system. Your overhead console has a passenger airbag status indicator.



United States

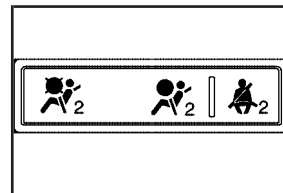

Canada

When the ignition key is turned to RUN or START, the passenger airbag status indicator will light ON and OFF, or the symbol for on and off, for several seconds as a system check. If you use remote start to start your vehicle from a distance (if equipped), you may not see the system check. Then, after several more seconds, the status indicator will light either ON or OFF, or either the on or off symbol to let you know the status of the right front passenger's frontal airbag and side impact airbag (if equipped).

Your vehicle has a rear seat that will accommodate a rear-facing child restraint. A label on your sun visor says, “Never put a rear-facing child seat in the front.” This is because the risk to the rear-facing child is so great, if the airbags deploy.

 **CAUTION:**

Even though the passenger sensing system is designed to turn off the right front passenger’s frontal airbag and side impact airbag (if equipped) if the system detects a rear-facing child restraint, no system is fail-safe, and no one can guarantee that an airbag will not deploy under some unusual circumstance, even though it is turned off. We recommend that rear-facing child restraints be transported in vehicles with a rear seat that will accommodate a rear-facing child restraint, whenever possible.

If the word ON or the on symbol is lit on the passenger airbag status indicator, it means that the right front passenger’s airbag or airbags are enabled (may inflate).

 **CAUTION:**

If the on indicator comes on when you have a rear-facing child restraint installed in the right front passenger’s seat, it means that the passenger sensing system has not turned off the passenger’s frontal airbag and seat-mounted side impact airbag (if equipped). A child in a rear-facing child restraint can be seriously injured or killed if the right front passenger’s airbag inflates. This is because the back of the rear-facing child restraint would be very close to the inflating airbag. Do not use a rear-facing child restraint in the right front passenger’s seat if the airbag is turned on.

If the word OFF or the off symbol is lit on the passenger airbag status indicator, it means that the passenger sensing system has turned off the right front passenger’s airbag or airbags. See *Passenger Sensing System on page 1-60* for more on this, including important safety information.

If, after several seconds, all status indicator lights remain on, or if there are no lights at all, there may be a problem with the lights or the passenger sensing system. See your dealer for service.



CAUTION:

If the off indicator and the airbag readiness light ever come on together, it means that something may be wrong with the airbag system. If this ever happens, have the vehicle serviced promptly, because an adult-size person sitting in the right front passenger seat may not have the protection of an airbag. See *Airbag Readiness Light on page 3-27.*

Charging System Light

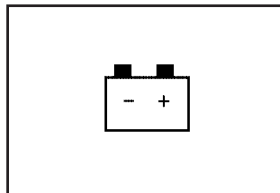

The charging system light will come on briefly when you turn on the ignition, but the engine is not running, as a check to show you it is working.

It should go out once the engine is running. If it stays on, or comes on while you are driving, you may have a problem with the charging system. It could indicate that you have problems with a generator drive belt, or another electrical problem. Have it checked right away. Driving while this light is on could drain your battery.

If you must drive a short distance with the light on, be certain to turn off all your accessories, such as the radio and air conditioner.

Brake System Warning Light

Your vehicle's hydraulic brake system is divided into two parts. If one part is not working, the other part can still work and stop you. For good braking, though, you need both parts working well.

If the warning light comes on, there is a brake problem. Have your brake system inspected right away.



United States

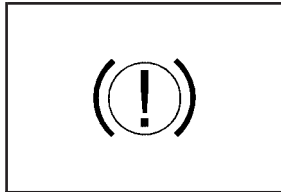

Canada

This light should come on briefly when you turn the ignition key to RUN. If it does not come on then, have it fixed so it will be ready to warn you if there is a problem.

When the ignition is on, the brake system warning light will also come on when you set your parking brake. The light will stay on if your parking brake does not release fully. If it stays on after your parking brake is fully released, it means you have a brake problem.

If the light comes on while you are driving, pull off the road and stop carefully. You may notice that the pedal is harder to push or, the pedal may go closer to the floor. It may take longer to stop. If the light is still on, have the vehicle towed for service. See *Brake System Warning Light* on page 3-31 and *Towing Your Vehicle* on page 4-34.

CAUTION:

Your brake system may not be working properly if the brake system warning light is on. Driving with the brake system warning light on can lead to an accident. If the light is still on after you have pulled off the road and stopped carefully, have the vehicle towed for service.

Anti-Lock Brake System Warning Light

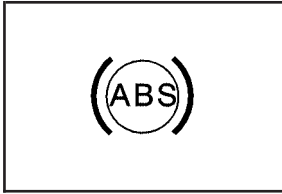

If your vehicle is equipped with anti-lock brakes, the anti-lock brake system warning light should come on for a few seconds when you turn the ignition key to RUN.

If the anti-lock brake system warning light stays on longer than normal after you've started your engine, turn the ignition off or, if the light comes on and stays on when you are driving, stop as soon as possible and turn the ignition off. Then start the engine again to reset the system. If the light still stays on, or comes on again while you are driving, the anti-lock brake system needs service and you do not have anti-lock brakes.

The anti-lock brake system warning light should come on briefly when you turn the ignition key to RUN. This is normal. If the light does not come on then, have it fixed so it will be ready to warn you if there is a problem.

Traction Control System (TCS) Warning Light



For vehicles equipped with the traction control system, this warning light should come on briefly when the engine is started.

If the warning light does not come on then, have it fixed so it will be ready to warn you if there is a problem. If it stays on, or comes on when you are driving, there may be a problem with your traction control system and your vehicle may need service. When this warning light is on, the system will not limit wheel spin. Adjust your driving accordingly.

If the traction control system warning light comes on and stays on for an extended period of time when the system is turned on, your vehicle needs service. See *Traction Control System (TCS)* on page 4-9 for more information.

Engine Coolant Temperature Warning Light

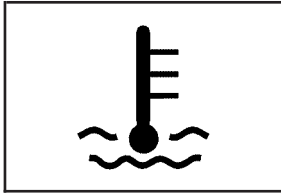

The engine coolant temperature warning light will come on when the engine has overheated.

If this happens you should pull over and turn off the engine as soon as possible. See *Engine Overheating* on page 5-29 for more information.

Notice: Driving with the engine coolant temperature warning light on could cause your vehicle to overheat. See *Engine Overheating* on page 5-29. Your vehicle could be damaged, and it might not be covered by your warranty. Never drive with the engine coolant temperature warning light on.

This light will also come on when starting your vehicle. If it doesn't, have your vehicle serviced.

Engine Coolant Temperature Gage

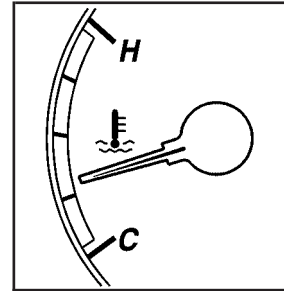

United States

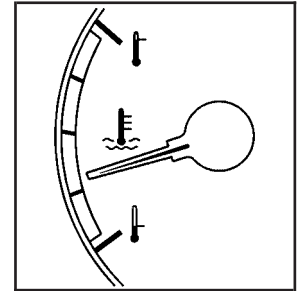

Canada

This gage shows the engine coolant temperature. If the gage pointer moves towards the “H” (United States) or the shaded in thermostat (Canada), it means that your engine coolant has overheated. If you have been operating your vehicle under normal driving conditions, you should pull off the road, stop your vehicle and turn off the engine as soon as possible.

See *Engine Overheating* on page 5-29 for more information.

Tire Pressure Light

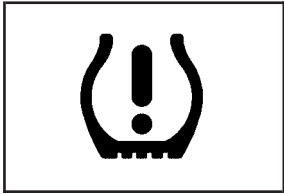

If equipped, this light should come on briefly as you start the engine. It will then come on only when a flat or low tire pressure condition exists.

See *Tire Pressure Monitor System* on page 5-62 for more information.

Malfunction Indicator Lamp

Check Engine Light

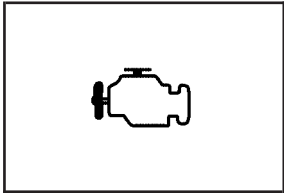

Your vehicle is equipped with a computer which monitors operation of the fuel, ignition, and emission control systems.

This system is called OBD II (On-Board Diagnostics-Second Generation) and is intended to assure that emissions are at acceptable levels for the life of the vehicle, helping to produce a cleaner environment. The check engine light comes on to indicate that there is a problem and service is required. Malfunctions often will be indicated by the system before any problem is apparent. This may prevent more serious damage to your vehicle. This system is also designed to assist your service technician in correctly diagnosing any malfunction.

Notice: If you keep driving your vehicle with this light on, after awhile, your emission controls may not work as well, your fuel economy may not be as good, and your engine may not run as smoothly. This could lead to costly repairs that may not be covered by your warranty.

Notice: Modifications made to the engine, transaxle, exhaust, intake, or fuel system of your vehicle or the replacement of the original tires with other than those of the same Tire Performance Criteria (TPC) can affect your vehicle's emission controls and may cause this light to come on. Modifications to these systems could lead to costly repairs not covered by your warranty. This may also result in a failure to pass a required Emission Inspection/Maintenance test. See *Accessories and Modifications* on page 5-3.

This light should come on, as a check to show you it is working, when the ignition is on and the engine is not running. If the light does not come on, have it repaired. This light will also come on during a malfunction in one of two ways:

- **Light Flashing** — A misfire condition has been detected. A misfire increases vehicle emissions and may damage the emission control system on your vehicle. Diagnosis and service may be required.
- **Light On Steady** — An emission control system malfunction has been detected on your vehicle. Diagnosis and service may be required.

If the Light is Flashing

The following may prevent more serious damage to your vehicle:

- Reducing vehicle speed
- Avoiding hard accelerations
- Avoiding steep uphill grades
- If you are towing a trailer, reduce the amount of cargo being hauled as soon as it is possible

If the light stops flashing and remains on steady, see “If the Light Is On Steady” following.

If the light continues to flash, when it is safe to do so, stop the vehicle.

Find a safe place to park your vehicle. Turn the key off, wait at least 10 seconds and restart the engine. If the light remains on steady, see “If the Light Is On Steady” following. If the light is still flashing, follow the previous steps, and see your dealer for service as soon as possible.

If the Light Is On Steady

You may be able to correct the emission system malfunction by considering the following:

Did you recently put fuel into your vehicle?

If so, reinstall the fuel cap, making sure to fully install the cap. See *Filling the Tank on page 5-8*. The diagnostic system can determine if the fuel cap has been left off or improperly installed. A loose or missing fuel cap will allow fuel to evaporate into the atmosphere. A few driving trips with the cap properly installed should turn the light off.

Did you just drive through a deep puddle of water?

If so, your electrical system may be wet. The condition will usually be corrected when the electrical system dries out. A few driving trips should turn the light off.

Have you recently changed brands of fuel?

If so, be sure to fuel your vehicle with quality fuel. See *Gasoline Octane on page 5-5*. Poor fuel quality will cause your engine not to run as efficiently as designed. You may notice this as stalling after start-up, stalling when you put the vehicle into gear, misfiring, hesitation on acceleration, or stumbling on acceleration. (These conditions may go away once the engine is warmed up.) This will be detected by the system and cause the light to turn on.

If you experience one or more of these conditions, change the fuel brand you use. It will require at least one full tank of the proper fuel to turn the light off.

If none of the above steps have made the light turn off, your dealer can check the vehicle. Your dealer has the proper test equipment and diagnostic tools to fix any mechanical or electrical problems that may have developed.

Emissions Inspection and Maintenance Programs

Some state/provincial and local governments have or may begin programs to inspect the emission control equipment on your vehicle. Failure to pass this inspection could prevent you from getting a vehicle registration.

Here are some things you need to know to help your vehicle pass an inspection:

Your vehicle will not pass this inspection if the check engine light is on or not working properly.

Your vehicle will not pass this inspection if the OBD (on-board diagnostic) system determines that critical emission control systems have not been completely diagnosed by the system. The vehicle would be considered not ready for inspection. This can happen if you have recently replaced your battery or if your battery has run down. The diagnostic system is designed to evaluate critical emission control systems during normal driving. This may take several days of routine driving. If you have done this and your vehicle still does not pass the inspection for lack of OBD system readiness, your GM dealer can prepare the vehicle for inspection.

Oil Pressure Light

CAUTION:

Do not keep driving if the oil pressure is low. If you do, your engine can become so hot that it catches fire. You or others could be burned. Check your oil as soon as possible and have your vehicle serviced.

Notice: Lack of proper engine oil maintenance may damage the engine. The repairs would not be covered by your warranty. Always follow the maintenance schedule in this manual for changing engine oil.

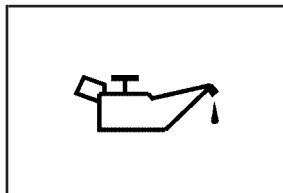

This light tells you if there could be a problem with your engine oil pressure.

The light goes on when you turn your key to RUN or START. It goes off once you start your engine. That is a check to be sure the light works. If it does not come on, be sure to have it fixed so it will be there to warn you if something goes wrong.

When the light comes on and stays on, it means that oil is not flowing through your engine properly. You could be low on oil and you might have some other system problem.

Security Light

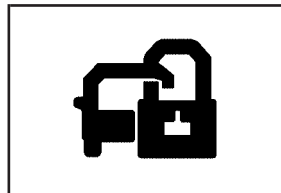

For information regarding this light, see *Theft-Deterrent Systems* on page 2-15.

Fog Lamp Light

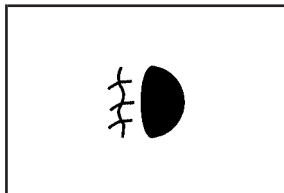

The fog lamps light will come on when the fog lamps are in use.

The light will go out when the fog lamps are turned off. See *Fog Lamps* on page 3-15 for more information.

Cruise Control Light

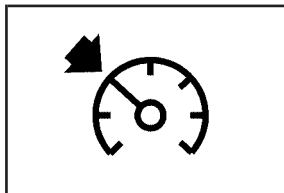

This light comes on whenever you set your cruise control.

The light will go out when the cruise control is turned off. See *Cruise Control* on page 3-10 for more information.

Highbeam On Light

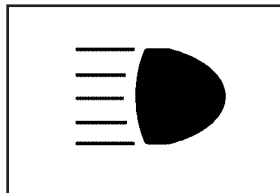

This light will come on when the high-beam headlamps are in use.

See *Headlamp High/Low-Beam Changer* on page 3-8.

Fuel Gage

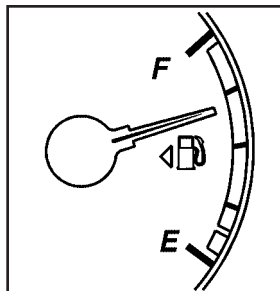

United States

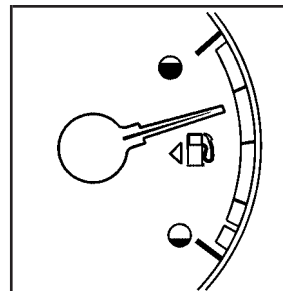

Canada

When the ignition is on, the fuel gage tells you about how much fuel you have remaining.

Here are four things that some owners ask about. None of these show a problem with your fuel gage:

- At the gas station, the gas pump shuts off before the gage reads full.
- It takes a little more or less fuel to fill up than the gage indicated. For example, the gage may have indicated the tank was half full, but it actually took a little more or less than half the tank's capacity to fill the tank.
- The gage moves a little when you turn a corner or speed up.
- The gage doesn't go back to empty when you turn off the ignition.

Driver Information Center (DIC)

Your vehicle has a Driver Information Center (DIC).

All messages will appear in the DIC display located below the speedometer in the instrument panel cluster. The DIC buttons are located on the instrument panel, to the right of the instrument panel cluster.

The DIC comes on when the ignition is on. After a short delay, the DIC will display the information that was last displayed before the engine was turned off.

The DIC displays trip, fuel, and vehicle system information, and warning messages if a system problem is detected. The bottom line of the DIC shows the shift lever position indicator. See *Automatic Transaxle Operation on page 2-22* for more information.

If your vehicle has these features, the DIC also displays the compass direction and the outside air temperature when viewing the trip and fuel information. The compass direction appears on the top right corner of the DIC display. The outside air temperature automatically appears in the bottom right corner of the DIC display. If there is a problem with the system that controls the temperature display, the numbers will be replaced with dashes. If this occurs, have the vehicle serviced by your GM dealer.

The DIC also allows some features to be customized. See *DIC Vehicle Customization on page 3-53* for more information.

DIC Operation and Displays

The DIC has different displays which can be accessed by pressing the DIC buttons located on the instrument panel, to the right of the instrument panel cluster.

DIC Buttons

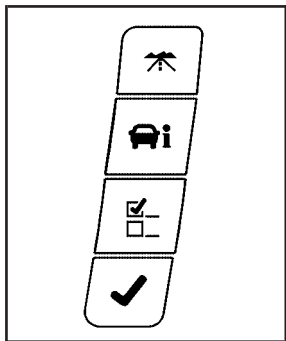

The buttons are the trip/fuel, vehicle information, customization, and set/reset buttons. The button functions are detailed in the following pages.

 **(Trip/Fuel):** Press this button to display the odometer, trip odometers, fuel range, average economy, instantaneous economy, Displacement on Demand™ (DoD™) indicator on vehicles with this feature, and average speed.

 **(Vehicle Information):** Press this button to display the oil life, units, tire pressure readings and Tire Pressure Monitor (TPM) system programming on vehicles with a Tire Pressure Monitor (TPM) system, compass zone and compass calibration on vehicles with this feature, and remote keyless entry transmitter programming.

 **(Customization):** Press this button to customize the feature settings on your vehicle. See *DIC Vehicle Customization on page 3-53* for more information.

✓ **(Set/Reset):** Press this button to set or reset certain functions and to turn off or acknowledge messages on the DIC.

Trip/Fuel Menu Items

 **(Trip/Fuel):** Press this button to scroll through the following menu items:

Odometer

Press the trip/fuel button until ODOMETER displays. This display shows the distance the vehicle has been driven in either miles (mi) or kilometers (km).

Trip A and Trip B

Press the trip/fuel button until TRIP A or TRIP B displays. This display shows the current distance traveled in either miles (mi) or kilometers (km) since the last reset for each trip odometer. Both trip odometers can be used at the same time.

Each trip odometer can be reset to zero separately by pressing the set/reset button while the desired trip odometer is displayed.

The trip odometer has a feature called the retro-active reset. This can be used to set the trip odometer to the number of miles (kilometers) driven since the ignition was last turned on. This can be used if the trip odometer is not reset at the beginning of the trip.

To use the retro-active reset feature, press and hold the set/reset button for at least two seconds. The trip odometer will display the number of miles (mi) or kilometers (km) driven since the ignition was last turned on and the vehicle was moving. Once the vehicle begins moving, the trip odometer will accumulate mileage. For example, if the vehicle was driven 5 miles (8 km) before it is started again, and then the retro-active reset feature is activated, the display will show 5 miles (8 km). As the vehicle begins moving, the display will then increase to 5.1 miles (8.2 km), 5.2 miles (8.4 km), etc.

If the retro-active reset feature is activated after the vehicle is started, but before it begins moving, the display will show the number of miles (mi) or kilometers (km) that were driven during the last ignition cycle.

Fuel Range

Press the trip/fuel button until FUEL RANGE displays. This display shows the approximate number of remaining miles (mi) or kilometers (km) the vehicle can be driven without refueling.

The fuel range estimate is based on an average of the vehicle's fuel economy over recent driving history and the amount of fuel remaining in the fuel tank. This estimate will change if driving conditions change. For example, if driving in traffic and making frequent stops, this display may read one number, but if the vehicle is driven on a freeway, the number may change even though the same amount of fuel is in the fuel tank. This is because different driving conditions produce different fuel economies. Generally, freeway driving produces better fuel economy than city driving.

If your vehicle is low on fuel, the FUEL LEVEL LOW message will be displayed. See "FUEL LEVEL LOW" under *DIC Warnings and Messages on page 3-46* for more information.

Average Economy

Press the trip/fuel button until AVG ECONOMY displays. This display shows the approximate average miles per gallon (mpg) or liters per 100 kilometers (L/100 km). This number is calculated based on the number of mpg (L/100 km) recorded since the last time this menu item was reset. To reset AVG ECONOMY, press and hold the set/reset button. The display will return to zero.

Instantaneous Economy and Displacement on Demand™ (DoD™) Indicator

Press the trip/fuel button until INST ECONOMY displays. If your vehicle has a V8 engine, INST ECONOMY 8CYL MODE will display. This display shows the current fuel economy at a particular moment and will change frequently as driving conditions change. This display shows the instantaneous fuel economy in miles per gallon (mpg) or liters per 100 kilometers (L/100 km). Unlike average economy, this screen cannot be reset.

If your vehicle has a V8 engine, a Displacement on Demand™ (DoD™) indicator will display on the right side of the DIC, while INST ECONOMY displays on the left side. DoD™ allows the engine to operate on either four or eight cylinders, depending on your driving demands. When DoD™ is active, 4CYL MODE will display on the DIC. When DoD™ is inactive, 8CYL MODE will display. See *Displacement on Demand™ (DoD™) (5.3L V8 Engine)* on page 2-21 for more information.

Average Speed

Press the trip/fuel button until AVERAGE SPEED displays. This display shows the average speed of the vehicle in miles per hour (mph) or kilometers per hour (km/h). This average is calculated based on the various vehicle speeds recorded since the last reset of this value. To reset the value, press and hold the set/reset button. The display will return to zero.

Blank Display

This display shows no information.

Vehicle Information Menu Items

 **(Vehicle Information):** Press this button to scroll through the following menu items:

Oil Life

Press the vehicle information button until OIL LIFE REMAINING displays. This display shows an estimate of the oil's remaining useful life. If you see 99% OIL LIFE REMAINING on the display, that means 99% of the current oil life remains. The engine oil life system will alert you to change your oil on a schedule consistent with your driving conditions.

When the remaining oil life is low, the CHANGE ENGINE OIL SOON message will appear on the display. See "CHANGE ENGINE OIL SOON" under *DIC Warnings and Messages on page 3-46*. You should change your oil as soon as possible. See *Engine Oil on page 5-17*. In addition to the engine oil life system monitoring the oil life, additional maintenance is recommended in the Maintenance Schedule in this manual. See *Scheduled Maintenance on page 6-4* for more information.

Remember, you must reset the OIL LIFE yourself after each oil change. It will not reset itself. Also, be careful not to reset the OIL LIFE accidentally at any time other than when the oil has just been changed.

It cannot be reset accurately until the next oil change. To reset the engine oil life system, see *Engine Oil Life System on page 5-20*.

Units

Press the vehicle information button until UNITS displays. This display allows you to select between English or Metric units of measurement. Once in this display, press the set/reset button to select between ENGLISH or METRIC units.

Tire Pressure

If your vehicle has a Tire Pressure Monitor (TPM) system, the pressure for each tire can be viewed in the DIC. The tire pressure will be shown in either pounds per square inch (psi) or kilopascals (kPa). Press the vehicle information button until the DIC shows the tire pressure for the front tires. Press the vehicle information button again to view the pressure for the rear tires.

If a low or high tire pressure condition is detected by the system while driving, a message advising you to check the pressure in a specific tire will appear in the display. See *Inflation - Tire Pressure on page 5-60* and *DIC Warnings and Messages on page 3-46* for more information.

Learn Tire Positions

If your vehicle has a Tire Pressure Monitor (TPM) system, after rotating the tires or after replacing a tire or sensor, the system must re-learn the tire positions. To re-learn the tire positions, see *Tire Pressure Monitor System* on page 5-62. See *Tire Inspection and Rotation* on page 5-66 and *DIC Warnings and Messages* on page 3-46 for more information.

Compass Zone

Your vehicle may have this feature. Under certain circumstances, such as during a long distance cross-country trip, it will be necessary to compensate for compass variance and reset the zone through the DIC.

Compass variance is the difference between the earth's magnetic north and true geographic north. If not adjusted to account for compass variance, the compass in the vehicle could give false readings.

In order to do this, the compass must be set or calibrated to the variance zone in which the vehicle is traveling.

To adjust for compass variance, use the following procedure:

Compass Variance Procedure

1. Press the vehicle information button until **PRESS ✓ TO CHANGE COMPASS ZONE** displays.

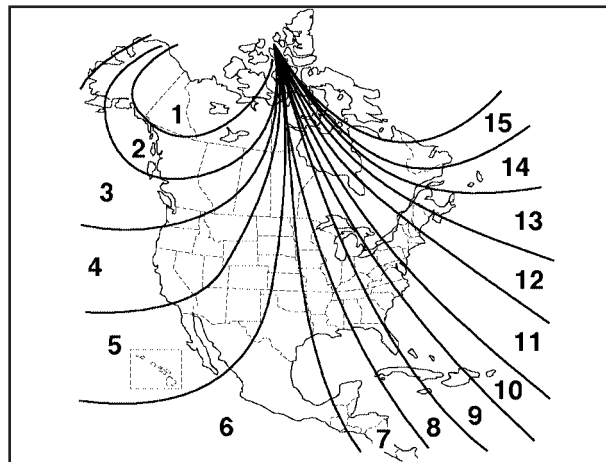

2. Find the vehicle's current location and variance zone number on the map.
Zones 1 through 15 are available.

3. Press the set/reset button to scroll through and select the appropriate variance zone.

Navigate to one of the trip/fuel menu screens to view the direction the vehicle is moving. This will be shown in the top right corner of the DIC display.

4. If you need to calibrate the compass, use the compass calibration procedure. See “Compass Calibration Procedure” following.

Compass Calibration

The compass can be manually calibrated. Only calibrate the compass in a safe location where driving the vehicle in circles is not a problem.

To calibrate the compass, use the following procedure:

Compass Calibration Procedure

1. Before calibrating the compass, make sure the compass zone is set to the variance zone in which the vehicle is traveling. See “Compass Variance Procedure” earlier in this section.
2. Press the vehicle information button until the PRESS ✓ TO CALIBRATE COMPASS screen is displayed.
3. Press the set/reset button to start the compass calibration.

4. The DIC will display CALIBRATING: DRIVE IN CIRCLES. Drive the vehicle in circles at less than 5 mph (8 km/h) to complete the calibration. The DIC will display CALIBRATION COMPLETE when the calibration is complete.

Remote Key

This display allows you to match the remote keyless entry transmitter to your vehicle. To match a remote keyless entry transmitter to your vehicle, do the following:

1. Press the vehicle information button until PRESS ✓ TO RELEARN REMOTE KEY displays.
2. Press the set/reset button.
The message REMOTE KEY LEARNING ACTIVE will display.
3. Press and hold the lock and unlock buttons on the first transmitter at the same time for approximately 15 seconds.
A chime will sound indicating that the transmitter is matched.
4. To match additional transmitters at this time, repeat Step 3.
Each vehicle can have a maximum of eight transmitters matched to it.
5. To exit the programming mode, you must cycle the key to OFF.

Blank Display

This display shows no information.

Customization Menu Items

 **(Customization):** Press this button to enter the feature settings menu. This display allows you to customize the feature settings on your vehicle. See *DIC Vehicle Customization on page 3-53* for more information.

DIC Warnings and Messages

Messages are displayed on the DIC to notify the driver that the status of the vehicle has changed and that some action may be needed by the driver to correct the condition. Multiple messages may appear one after another. Some messages may not require immediate action, but you can press the set/reset button to acknowledge that you received the message and clear it from the DIC display. Pressing any of the DIC buttons will also acknowledge and clear any messages. Some messages cannot be cleared from the DIC display because they are more urgent. These messages require action before they can be cleared. You should take any messages that appear on the display seriously and remember that clearing the messages will only make the messages disappear, not correct the problem. The following are the possible messages that can be displayed and some information about them.

AUTOMATIC LIGHT CONTROL OFF

This message will display when the automatic headlamps are turned off. See *Daytime Running Lamps (DRL)/Automatic Headlamp System on page 3-14* for more information.

AUTOMATIC LIGHT CONTROL ON

This message will display when the automatic headlamps are turned on. See *Daytime Running Lamps (DRL)/Automatic Headlamp System on page 3-14* for more information.

CHANGE ENGINE OIL SOON

This message will display when service is required for the vehicle. See your GM dealer. See *Engine Oil on page 5-17* and *Scheduled Maintenance on page 6-4* for more information.

Acknowledging the CHANGE ENGINE OIL SOON message will not reset the OIL LIFE REMAINING. That must be done at the OIL LIFE screen under the vehicle information menu. See "Oil Life" under *DIC Operation and Displays on page 3-40* and *Engine Oil Life System on page 5-20*.

CHECK TIRE PRESSURE

If your vehicle has a Tire Pressure Monitor (TPM) system, this message will display when the tire pressure in one of the tires needs to be checked. This message will also display LEFT FRONT, RIGHT FRONT, LEFT REAR, or RIGHT REAR to indicate which tire needs to be checked. You can receive more than one tire pressure message at a time. To read the other messages that may have been sent at the same time, press the set/reset button. If a tire pressure message appears on the DIC, stop as soon as you can. Have the tire pressures checked and set to those shown on your Tire Loading Information Label. See *Tires* on page 5-54, *Loading Your Vehicle* on page 4-29, and *Inflation - Tire Pressure* on page 5-60. The DIC display also shows the tire pressure values for the front and rear tires by pressing the vehicle information button. See *DIC Operation and Displays* on page 3-40. If the tire pressure is low, the low tire pressure warning light will come on. See *Tire Pressure Light* on page 3-34.

DRIVER DOOR OPEN

This message will display when the driver's door is not closed properly. When this message appears, you should make sure that the driver's door is closed completely.

ENGINE HOT A/C (Air Conditioning) OFF

This message will display when the engine coolant becomes hotter than the normal operating temperature. To avoid added strain on a hot engine, the air conditioning compressor is automatically turned off. When the coolant temperature returns to normal, the A/C operation will automatically resume. You can continue to drive your vehicle. If this message continues to appear, have the system repaired by your GM dealer as soon as possible to avoid compressor damage.

ENGINE OIL LOW ADD OIL

This message will display when the vehicle's engine oil is low. Fill the oil to the proper level as soon as possible. See *Engine Compartment Overview* on page 5-12 for the engine oil fill location. Also, see *Engine Oil* on page 5-17 for information on the kind of oil to use and the proper oil level.

ENGINE OVERHEATED IDLE ENGINE

Notice: If you drive your vehicle while the engine is overheating, severe engine damage may occur. If an overheat warning appears on the instrument panel cluster and/or DIC, stop the vehicle as soon as possible. Do not increase the engine speed above normal idling speed. See *Engine Overheating on page 5-29* for more information.

This message will display when the engine coolant temperature is too hot. Stop and allow the vehicle to idle until it cools down.

ENGINE OVERHEATED STOP ENGINE

Notice: If you drive your vehicle while the engine is overheating, severe engine damage may occur. If an overheat warning appears on the instrument panel cluster and/or DIC, stop the vehicle as soon as possible. Do not increase the engine speed above normal idling speed. See *Engine Overheating on page 5-29* for more information.

This message will display along with a continuous chime when the engine has overheated. Stop and turn the engine off immediately to avoid severe engine damage. See *Engine Overheating on page 5-29*.

ENGINE POWER IS REDUCED

This message will display when the vehicle's engine power is reduced. Reduced engine power can affect the vehicle's ability to accelerate. If this message is on, but there is no reduction in performance, proceed to your destination. The performance may be reduced the next time the vehicle is driven. The vehicle may be driven at a reduced speed while this message is on, but acceleration and speed may be reduced. Anytime this message stays on, the vehicle should be taken to your GM dealer for service as soon as possible.

ERROR

This message will display while viewing the odometer or trip odometers if there is a problem with the instrument panel cluster. See your GM dealer for service.

FUEL LEVEL LOW

This message will display when your vehicle is low on fuel. You should refill the fuel tank as soon as possible. See *Fuel Gage on page 3-38* and *Filling the Tank on page 5-8* for more information.

HOOD OPEN

If your vehicle has the remote start feature, this message will display when the hood is not closed properly. When this message appears, you should make sure that the hood is closed completely. See *Hood Release on page 5-11*.

ICE POSSIBLE DRIVE WITH CARE

This message will display when the outside air temperature is cold enough to create icy road conditions. Adjust your driving accordingly.

OIL PRESSURE LOW STOP ENGINE

Notice: If you drive your vehicle while the engine oil pressure is low, severe engine damage may occur. If a low oil pressure warning appears on the Driver Information Center (DIC), stop the vehicle as soon as possible. Do not drive the vehicle until the cause of the low oil pressure is corrected. See *Engine Oil on page 5-17* for more information.

This message will display when the vehicle's engine oil pressure is low. The oil pressure light will also appear on the instrument panel cluster. See *Oil Pressure Light on page 3-37*.

Stop the vehicle immediately, as engine damage can result from driving a vehicle with low oil pressure. Have the vehicle serviced by your GM dealer as soon as possible when this message is displayed.

PASSENGER DOOR OPEN

This message will display when the passenger's door is not closed properly. When this message appears, you should make sure that the passenger's door is closed completely.

REMOTE KEY LEARNING ACTIVE

This message will display while you are matching a remote keyless entry transmitter to your vehicle. See "Matching Transmitter(s) to Your Vehicle" under *Remote Keyless Entry System Operation on page 2-4* and *DIC Operation and Displays on page 3-40* for more information.

REPLACE BATTERY IN REMOTE KEY

This message will display when the battery in the remote keyless entry transmitter needs to be replaced. To replace the battery, see "Battery Replacement" under *Remote Keyless Entry System Operation on page 2-4*.

SERVICE A/C (Air Conditioning) SYSTEM

This message will display when the electronic sensors that control the air conditioning and heating systems are no longer working. Have the climate control system serviced by your GM dealer if you notice a drop in heating and air conditioning efficiency.

SERVICE AIR BAG

This message will display when there is a problem with the airbag system. Have your vehicle serviced by your GM dealer immediately. See *Airbag Readiness Light on page 3-27* for more information.

SERVICE BATTERY CHARGING SYSTEM

This message will display when there is a problem with the generator and battery charging systems. Driving with this problem could drain your battery. Turn off all unnecessary accessories. Stop and turn off the vehicle as soon as it is safe to do so. Have the electrical system checked by your GM dealer immediately.

SERVICE BRAKE SYSTEM

This message will display when service is required on the brake system. Have the brake system serviced by your GM dealer as soon as possible. The brake system warning light will also appear on the instrument panel cluster when this message appears on the DIC. See *Brake System Warning Light on page 3-31*.

SERVICE POWER STEERING

This message will display when a problem is detected with the power steering system. When this message is displayed, you may notice that the effort required to steer the vehicle increases or feels heavier, but you will still be able to steer the vehicle. Have your vehicle serviced by your GM dealer immediately.

SERVICE THEFT SYSTEM

This message will display when there is a problem with the theft-deterrent system programmed in the key. A fault has been detected in the system which means that the system is disabled and it is not protecting the vehicle. The vehicle usually restarts; however, you may want to take the vehicle to your GM dealer before turning off the engine. See *PASS-Key[®] III+ Operation on page 2-16* for more information.

SERVICE TIRE MONITOR SYSTEM

If your vehicle has a Tire Pressure Monitor (TPM) system, this message will display if a part on the system is not working properly. If you drive your vehicle while any of the four sensors are missing or inoperable, the warning will come on in about 10 minutes. A sensor would be missing, for example, if you put different wheels on your vehicle without transferring the sensors. If the warning comes on and stays on, there may be a problem with the TPM. See your GM dealer.

SERVICE TRACTION CONTROL

If your vehicle has the traction control system, this message will display when the system is not functioning properly. A warning light will also appear on the instrument panel cluster. See *Traction Control System (TCS) Warning Light on page 3-32*. See *Traction Control System (TCS) on page 4-9* for more information. Have the traction control system serviced by your GM dealer as soon as possible.

SERVICE TRANSMISSION

This message will display when there is a problem with the transaxle. See your GM dealer for service.

SERVICE VEHICLE SOON

This message will display when a non-emissions related malfunction occurs. Have the vehicle serviced by your GM dealer as soon as possible.

STARTING DISABLED SERVICE THROTTLE

This message will display if the starting of the engine is disabled due to the electronic throttle control system. Have your vehicle serviced by your GM dealer immediately.

This message will only appear while the ignition is in RUN, and will not disappear until the problem is resolved.

This message cannot be acknowledged.

THEFT ATTEMPTED

This message will display if the content theft-deterrent system has detected a break-in attempt while you were away from your vehicle. See *Content Theft-Deterrent on page 2-15* for more information.

TIGHTEN GAS CAP

This message may be displayed if the gas cap is not on, or is not fully tightened. Check the gas cap to ensure that it is on properly. See *Filling the Tank on page 5-8* for more information.

TIRE LEARNING ACTIVE

If your vehicle has a Tire Pressure Monitor (TPM) system, this message will display when the system is re-learning the tire positions. See *Tire Pressure Monitor System on page 5-62*. The tire positions must be re-learned after rotating the tires or after replacing a tire or sensor. See *Tire Inspection and Rotation on page 5-66* and *Inflation - Tire Pressure on page 5-60* for more information.

TRACTION CONTROL OFF

If your vehicle has the traction control system, this message will display when the traction control system turns off. See *Traction Control System (TCS) on page 4-9* for more information.

This message will only display while the ignition is in RUN and will disappear after 10 seconds, unless it is acknowledged or an urgent warning appears.

Any of the following conditions may cause the traction control system to turn off:

- The traction control system is turned off by pressing the traction control button. See *Traction Control System (TCS) on page 4-9* for more information.
- The battery is low.
- There is a traction control system failure. See your GM dealer for service.

TRANSMISSION HOT IDLE ENGINE

This message will display when the transaxle fluid in your vehicle is too hot. Stop the vehicle and allow it to idle until it cools down. If the warning message continues to display, have the vehicle serviced by your GM dealer as soon as possible.

TRUNK OPEN

This message will display when the trunk is not closed completely. You should make sure that the trunk is closed completely. See *Trunk on page 2-11*.

TURN SIGNAL ON

This message will display as a reminder to turn off the turn signal if you drive your vehicle for more than about 0.75 mile (1.2 km) with a turn signal on. See *Turn Signal/Multifunction Lever on page 3-7*.

This message displays and a chime sounds only when the ignition is in RUN. The message will not disappear until the turn signal is manually turned off, or a turn is completed.

WASHER FLUID LOW ADD FLUID

This message will display when the windshield washer fluid is low. Fill the windshield washer reservoir as soon as possible. See *Engine Compartment Overview on page 5-12* for the location of the windshield washer reservoir. Also, see *Windshield Washer Fluid on page 5-39* for more information.

DIC Vehicle Customization

Your vehicle has customization capabilities that allow you to program certain features to one preferred setting. Customization features can only be programmed to one setting on the vehicle and cannot be programmed to a preferred setting for two different drivers.

All of the customization options may not be available on your vehicle. Only the options available will be displayed on your DIC.

The default settings for the customization features were set when your vehicle left the factory, but may have been changed from their default state since then.

The customization preferences are automatically recalled.

To change customization preferences, use the following procedure.

Entering the Feature Settings Menu

1. Turn the ignition on and place the vehicle in PARK (P).
2. Press the customization button to enter the feature settings menu.

If the menu is not available, FEATURE SETTINGS AVAILABLE IN PARK will display. Before entering the menu, make sure the vehicle is in PARK (P).

Feature Settings Menu Items

The following are customization features that allow you to program settings to the vehicle:

DISPLAY IN ENGLISH

This feature will only display if a language other than English has been set. This feature allows you to change the language in which the DIC messages appear to English.

Press the customization button until the PRESS ✓ TO DISPLAY IN ENGLISH screen appears on the DIC display. Press the set/reset button to display all DIC messages in English.

DISPLAY LANGUAGE

This feature allows you to select the language in which the DIC messages will appear.

Press the customization button until the DISPLAY LANGUAGE screen appears on the DIC display. Press the set/reset button to access the settings for this feature. Then press the customization button to scroll through the following choices:

ENGLISH (default): All messages will appear in English.

FRANCAIS (French): All messages will appear in French.

ESPANOL (Spanish): All messages will appear in Spanish.

NO CHANGE: No change will be made to this feature. The current setting will remain.

Select one of the available choices and press the set/reset button while it is displayed on the DIC to select it.

AUTO DOOR UNLOCK

This feature allows you to select whether or not to turn off the automatic door unlocking feature. It also allows you to select which doors and when the doors will automatically unlock. See *Programmable Automatic Door Unlock on page 2-11* for more information.

Press the customization button until AUTO DOOR UNLOCK appears on the DIC display. Press the set/reset button to access the settings for this feature. Then press the customization button to scroll through the following choices:

OFF: None of the doors will automatically unlock.

DRIVER AT KEY OUT: Only the driver's door will unlock when the key is taken out of the ignition.

DRIVER IN PARK: Only the driver's door will unlock when the vehicle is shifted into PARK (P).

ALL AT KEY OUT: All of the doors will unlock when the key is taken out of the ignition.

ALL IN PARK (default): All of the doors will unlock when the vehicle is shifted into PARK (P).

NO CHANGE: No change will be made to this feature. The current setting will remain.

Select one of the available choices and press the set/reset button while it is displayed on the DIC to select it.

REMOTE DOOR LOCK

This feature allows you to select the type of feedback you will receive when locking the vehicle with the remote keyless entry transmitter. You will not receive feedback when locking the vehicle with the remote keyless entry transmitter if any of the doors are open. See *Remote Keyless Entry System Operation on page 2-4* for more information.

Press the customization button until REMOTE DOOR LOCK appears on the DIC display. Press the set/reset button to access the settings for this feature. Then press the customization button to scroll through the following choices:

HORN & LIGHTS OFF: There will be no feedback when you press the lock button on the remote keyless entry transmitter.

LIGHTS ONLY: The exterior lamps will flash when you press the lock button on the remote keyless entry transmitter.

HORN ONLY: The horn will sound on the second press of the lock button on the remote keyless entry transmitter.

HORN & LIGHTS ON (default): The exterior lamps will flash when you press the lock button on the remote keyless entry transmitter, and the horn will sound when the lock button is pressed again within five seconds of the previous command.

NO CHANGE: No change will be made to this feature. The current setting will remain.

Select one of the available choices and press the set/reset button while it is displayed on the DIC to select it.

REMOTE DOOR UNLOCK

This feature allows you to select the type of feedback you will receive when unlocking the vehicle with the remote keyless entry transmitter. You will not receive feedback when unlocking the vehicle with the remote keyless entry transmitter if the doors are open. See *Remote Keyless Entry System Operation on page 2-4* for more information.

Press the customization button until REMOTE DOOR UNLOCK appears on the DIC display. Press the set/reset button to access the settings for this feature. Then press the customization button to scroll through the following choices:

LIGHTS OFF: The exterior lamps will not flash when you press the unlock button on the remote keyless entry transmitter.

LIGHTS ON (default): The exterior lamps will flash when you press the unlock button on the remote keyless entry transmitter.

NO CHANGE: No change will be made to this feature. The current setting will remain.

Select one of the available choices and press the set/reset button while it is displayed on the DIC to select it.

EXIT LIGHTING

If it is dark enough outside, this feature allows you to select the amount of time you want the exterior lamps to remain on. This happens after the vehicle is unlocked using the remote keyless entry transmitter or if the vehicle key is turned to OFF from RUN.

Press the customization button until EXIT LIGHTING appears on the DIC display. Press the set/reset button to access the settings for this feature. Then press the customization button to scroll through the following choices:

OFF: The exterior lamps will not turn on.

30 SECONDS (default): The exterior lamps will stay on for 30 seconds.

1 MINUTE: The exterior lamps will stay on for one minute.

2 MINUTES: The exterior lamps will stay on for two minutes.

NO CHANGE: No change will be made to this feature. The current setting will remain.

Select one of the available choices and press the set/reset button while it is displayed on the DIC to select it.

APPROACH LIGHTING

This feature allows you to select whether or not to have the exterior lights turn on briefly during low light periods after unlocking the vehicle using the remote keyless entry transmitter.

Press the customization button until APPROACH LIGHTING appears on the DIC display. Press the set/reset button to access the settings for this feature. Then press the customization button to scroll through the following choices:

OFF: The exterior lights will not turn on when you unlock the vehicle with the remote keyless entry transmitter.

ON (default): If it is dark enough outside, the exterior lights will turn on briefly when you unlock the vehicle with the remote keyless entry transmitter.

The lights will remain on for 20 seconds or until the lock button on the remote keyless entry transmitter is pressed, or the vehicle is no longer off. See *Remote Keyless Entry System Operation on page 2-4* for more information.

NO CHANGE: No change will be made to this feature. The current setting will remain.

Select one of the available choices and press the set/reset button while it is displayed on the DIC to select it.

CHIME VOLUME

This feature allows you to select the volume level of the chime.

Press the customization button until CHIME VOLUME appears on the DIC display. Press the set/reset button to access the settings for this feature. Then press the customization button to scroll through the following choices:

NORMAL (default): The chime volume will be set to a normal level.

LOUD: The chime volume will be set to a loud level.

NO CHANGE: No change will be made to this feature. The current setting will remain.

Select one of the available choices and press the set/reset button while it is displayed on the DIC to select it.

REMOTE START

If your vehicle has this feature, it allows you to turn the remote start off or on. The remote start feature allows you to start the engine from outside of the vehicle using your remote keyless entry transmitter. See “Remote Vehicle Start” under *Remote Keyless Entry System Operation on page 2-4* for more information.

Press the customization button until REMOTE START appears on the DIC display. Press the set/reset button to access the settings for this feature. Then press the customization button to scroll through the following choices:

OFF: The remote start feature will be disabled.

ON (default): The remote start feature will be enabled.

NO CHANGE: No change will be made to this feature. The current setting will remain.

Select one of the available choices and press the set/reset button while it is displayed on the DIC to select it.

FACTORY SETTINGS

This feature allows you to set all of the customization features back to their factory default settings.

Press the customization button until FACTORY SETTINGS appears on the DIC display. Press the set/reset button to access the settings for this feature. Then press the customization button to scroll through the following choices:

RESTORE ALL (default): The customization features will be set to their factory default settings.

DO NOT RESTORE: The customization features will not be set to their factory default settings.

Select one of the available choices and press the set/reset button while it is displayed on the DIC to select it.

EXIT FEATURE SETTINGS

This feature allows you to exit the FEATURE SETTINGS menu.

Press the customization button until FEATURE SETTINGS PRESS ✓ TO EXIT appears in the DIC display. Press the set/reset button to exit the menu.

If you do not exit, pressing the customization button again will return you to the beginning of the FEATURE SETTINGS menu.

Exiting the Feature Settings Menu

The feature settings menu will be exited when any of the following occurs:

- The vehicle is shifted out of PARK (P).
- The vehicle is no longer in RUN.
- The trip/fuel or vehicle information DIC buttons are pressed.
- The end of the feature settings menu is reached and exited.
- A 40 second time period has elapsed with no selection made.

Audio System(s)

Determine which radio your vehicle has and then read the pages following to familiarize yourself with its features.

Driving without distraction is a necessity for a safer driving experience. See *Defensive Driving on page 4-2*. By taking a few moments to read this manual and get familiar with your vehicle's audio system, you can use it with less effort, as well as take advantage of its features. While your vehicle is parked, set up your audio system by presetting your favorite radio stations, setting the tone, and adjusting the speakers.

Then, when driving conditions permit, you can tune to your favorite stations using the presets and steering wheel controls if the vehicle has them.

CAUTION:

This system provides you with a far greater access to audio stations and song listings. Giving extended attention to entertainment tasks while driving can cause a crash and you or others can be injured or killed. Always keep your eyes on the road and your mind on the drive — avoid engaging in extended searching while driving.

Keeping your mind on the drive is important for safe driving. For more information, see *Defensive Driving on page 4-2*.

Here are some ways in which you can help avoid distraction while driving.

While your vehicle is parked:

- Familiarize yourself with all of its controls.
- Familiarize yourself with its operation.
- Set up your audio system by presetting your favorite radio stations, setting the tone, and adjusting the speakers. Then, when driving conditions permit, you can tune to your favorite radio stations using the presets and steering wheel controls if the vehicle has them.

Notice: Before adding any sound equipment to your vehicle, such as an audio system, CD player, CB radio, mobile telephone, or two-way radio, make sure that it can be added by checking with your dealer. Also, check federal rules covering mobile radio and telephone units. If sound equipment can be added, it is very important to do it properly. Added sound equipment may interfere with the operation of your vehicle's engine, radio, or other systems, and even damage them. Your vehicle's systems may interfere with the operation of sound equipment that has been added.

Notice: The chime signals related to safety belts, parking brake, and other functions of your vehicle operate through the radio/entertainment system. If that equipment is replaced or additional equipment is added to your vehicle, the chimes may not work. Make sure that replacement or additional equipment is compatible with your vehicle before installing it. See *Accessories and Modifications on page 5-3*.

Your vehicle has a feature called Retained Accessory Power (RAP). With RAP, the audio system can be played even after the ignition is turned off. See *Retained Accessory Power (RAP) on page 2-19* for more information.

Setting the Time (Without Date Display)

If your vehicle has a base AM/FM radio with a single CD player and preset buttons numbered one through six, the radio will have a clock button for setting the time. You can set the time by following these steps:

1. Press the clock button until the hour numbers begin flashing on the display. Press the clock button a second time and the minute numbers will begin flashing on the display.

2. While either the hour or the minute numbers are flashing, rotate the tune knob clockwise or counterclockwise to increase or decrease the time. Instead of using the tune knob, you can also press the SEEK, FWD, or REV buttons to adjust the time.
3. Press the clock button again until the clock display stops flashing to set the currently displayed time; otherwise, the flashing will stop after five seconds and the current time displayed will be automatically set.

Setting the Time (With Date Display)

If your vehicle has a radio with a single CD player, the radio will have a clock button for setting the time and date. Press the clock button and the HR, MIN, MM, DD, YYYY (hour, minute, month, day, and year) will appear on the display. Press the pushbutton located under any one of the labels that you want to change. Every time the pushbutton is pressed again, the time or the date if selected, will increase by one. Another way to increase the time or date, is to press the right SEEK arrow or FWD button. To decrease, press the left SEEK arrow or REV button. You can also rotate the tune knob to adjust the selected setting.

If your vehicle has a radio with a six-disc CD player, the radio will have a MENU button instead of the clock button to set the time and date. Press the MENU button. Once the clock option is displayed, press the pushbutton located under that label. The HR, MIN, MM, DD, YYYY will appear on the display. To change the time or date, follow the instructions given earlier in this section.

To change the time default setting from 12 hour to 24 hour or to change the date default setting from month/day/year to day/month/year, press the clock button and then the pushbutton located under the forward arrow label. Once the time 12H and 24H, and the date MM/DD/YYYY (month, day, and year) and DD/MM/YYYY (day, month, and year) are displayed, press the pushbutton located under the desired option. Press the clock or MENU button again to apply the selected default, or let the screen time out.

Radio with CD (Base)

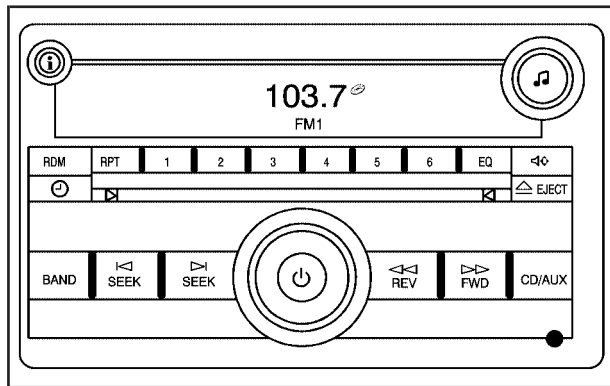

Playing the Radio

Power/Volume: Press this knob to turn the system on and off.

Turn this knob clockwise or counterclockwise to increase or decrease the volume.

The radio remembers the previous volume setting whenever the radio is turned on. You can still manually adjust the volume by using the volume knob.

Finding a Station

BAND: Press this button to switch between FM1, FM2 or AM. The display will show the selection.

Tune: Turn this knob to select radio stations.

SEEK: Press the right or left SEEK arrow to go to the next or to the previous station and stay there.

To scan stations, press and hold either SEEK arrow for a few seconds until you hear a beep. The radio will go to a station, play for a few seconds, then go on to the next station. Press either SEEK arrow again to stop scanning.

The radio will only seek and scan stations with a strong signal that are in the selected band.

Information: Press this button to switch the display between the radio station frequency and the time. While the ignition is off, press this knob to display the time.

Setting Preset Stations

Up to 18 stations (six FM1, six FM2, and six AM), can be programmed on the six numbered pushbuttons, by performing the following steps:

1. Turn the radio on.
2. Press BAND to select FM1, FM2, or AM.
3. Tune in the desired station.
4. Press and hold one of the six numbered pushbuttons for three seconds until you hear a beep. Whenever that pushbutton is pressed and released, the station that was set will return.
5. Repeat the Steps 2-4 for each pushbutton.

Setting the Tone (Bass/Treble)

BASS/TREB (Bass/Treble): To adjust the bass or treble, press the tune knob or BASS/TREBLE button until the desired tone control label appears on the display. Turn the tune knob clockwise or counterclockwise to increase or decrease the setting. You can also adjust the setting by pressing either the SEEK, FWD, or REV buttons. The display will show the current bass or treble level. If a station's frequency is weak, or if there is static, decrease the treble.

EQ (Equalization): Press this button to select preset equalization settings.

To return to the manual mode, press the EQ button until Manual appears on the display or start to manually adjust the bass or treble by pressing the tune knob.

Adjusting the Speakers (Balance/Fade)

 **BAL/FADE (Balance/Fade):** To adjust the balance or fade, press this button or the tune knob until the desired speaker control label appears on the display. Turn the tune knob clockwise or counterclockwise to adjust the setting. You can also adjust the setting by pressing either the SEEK, FWD, or REV buttons.

Radio Messages

Calibration Error: The audio system has been calibrated for your vehicle from the factory. If Calibration Error appears on the display, it means that the radio has not been configured properly for your vehicle and it must be returned to your dealer for service.

Loc: This message is displayed while the THEFTLOCK® system has locked up the radio. Take the vehicle to your dealer for service.

If any error occurs repeatedly or if an error cannot be corrected, contact your dealer.

Playing a CD (Single CD Player)

Insert a CD partway into the slot, label side up. The player will pull it in and the CD should begin playing.

If the ignition or radio is turned off with a CD in the player, it will stay in the player. When the ignition or radio is turned on, the CD will start playing where it stopped, if it was the last selected audio source.

When a CD is inserted, the CD symbol will appear on the radio display. As each new track starts to play, the track number will appear on the display.

The CD player can play the smaller 3 inch (8 cm) single CDs with an adapter ring. Full-size CDs and the smaller CDs are loaded in the same manner.

If playing a CD-R, the sound quality may be reduced due to CD-R quality, the method of recording, the quality of the music that has been recorded, and the way the CD-R has been handled. There may be an increase in skipping, difficulty in finding tracks, and/or difficulty in loading and ejecting. If these problems occur, check the bottom surface of the CD. If the surface of the CD is damaged, such as cracked, broken, or scratched, the CD will not play properly. If the surface of the CD is soiled, see *Care of Your CDs on page 3-84* for more information.

If there is no apparent damage, try a known good CD.



Notice: If you add any label to a CD, insert more than one CD into the slot at a time, or attempt to play scratched or damaged CDs, you could damage the CD player. When using the CD player, use only CDs in good condition without any label, load one CD at a time, and keep the CD player and the loading slot free of foreign materials, liquids, and debris.

Do not add any label to a CD, it could get caught in the CD player. If a CD is recorded on a personal computer and a description label is needed, try labeling the top of the recorded CD with a marking pen.

If an error appears on the display, see “CD Messages” later in this section.

 **EJECT:** Press the CD eject button to eject the CD. If the CD is not removed, after several seconds, the CD will be automatically pulled back into the player.

 **(Tune):** Turn this knob to select tracks on the CD currently playing.

 **SEEK**  : Press the left SEEK arrow to go to the start of the current track, if more than ten seconds have played. Press the right SEEK arrow to go to the next track. If either SEEK arrow is held or pressed multiple times, the player will continue moving backward or forward through the CD.

◀◀ **REV (Reverse):** Press and hold this button to reverse playback quickly within a track. You will hear sound at a reduced volume. Release this pushbutton to resume playing the track. The elapsed time of the track will appear on the display.

▶▶ **FWD (Fast Forward):** Press and hold this pushbutton to advance playback quickly within a track. You will hear sound at a reduced volume. Release this pushbutton to resume playing the track. The elapsed time of the track will appear on the display.

RDM (Random): With random, you can listen to CD tracks in random, rather than sequential order. To use random, do the following:

1. Press this button to play tracks from the CD you are listening to in random order. The random icon will appear on the display.
2. Press this button again to turn off random play. The random icon will disappear from the display.

RPT (Repeat): With repeat, one track or an entire CD can be repeated (played over and over).

To use repeat, do the following:

- To repeat the track you are listening to, press and release the RPT button. An arrow symbol will appear on the display. Press RPT again to turn off repeat play.
- To repeat the CD you are listening to, press and hold the RPT button for a few seconds. An arrow symbol will appear on the display. Press RPT again to turn off repeat play. When repeat is off, the symbol is no longer displayed.

i (Information): Press this button to switch the display between the track number, elapsed time of the track, and the time. When the ignition is off, press this button to display the time.

BAND: Press this button to listen to the radio while a CD is playing. The CD will remain safely inside the radio for future listening.

CD/AUX (CD/Auxiliary): Press this button to play a CD while listening to the radio. The CD icon and track number will appear on the display while a CD is in the player. Press this button again and the system will automatically search for an auxiliary input device such as a portable audio player.

CD Messages

CHECK DISC: If this message appears on the display and/or the CD comes out, it could be for one of the following reasons:

- It is very hot. When the temperature returns to normal, the CD should play.
- You are driving on a very rough road. When the road becomes smoother, the CD should play.
- The CD is dirty, scratched, wet, or upside down.
- The air is very humid. If so, wait about an hour and try again.
- There may have been a problem while burning the CD-R.
- The label may be caught in the CD player.

If the CD is not playing correctly, for any other reason, try a known good CD.

If any error occurs repeatedly or if an error cannot be corrected, contact your dealer. If the radio displays an error message, write it down and provide it to your dealer while reporting the problem.

Using the Auxiliary Input Jack

Your radio system has an auxiliary input jack located on the lower right side of the faceplate. You can connect an external audio device such as an iPod, MP3 player, CD changer, or cassette player, to the auxiliary input jack for use as another source for audio listening.

To use a portable audio player, connect a 3.5 mm (1/8 inch) cable to the radio's front auxiliary input jack. When a device is connected, press the radio CD/AUX button to begin playing audio from the device over the car speakers.

When a device is connected, the radio automatically begins playing audio from the device over the car speakers.

 **(Power/Volume):** Turn this knob clockwise or counterclockwise to increase or decrease the volume of the portable player. You may need to do additional volume adjustments from the portable device if the volume does not go loud or soft enough.

BAND: Press this button to listen to the radio while a portable audio device is playing. The portable audio device will continue playing, so you may want to stop it or turn it off.

CD/AUX (CD/Auxiliary): Press this button to play a CD while a portable audio device is playing. Press this button again and the system will begin playing audio from the connected portable audio player. If a portable audio player is not connected, "no input device found" will be displayed.

Radio with CD (MP3)

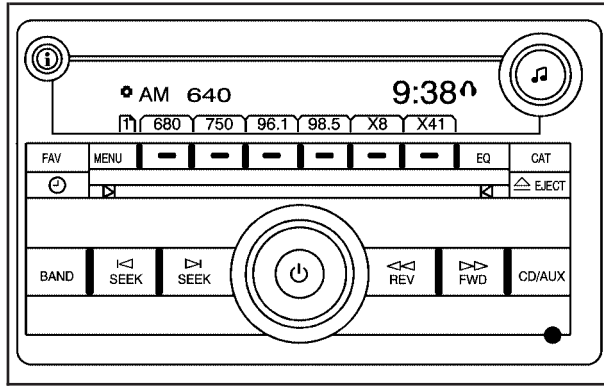

Radio with CD (MP3) shown, Radio with Six-Disc CD (MP3) similar

Radio Data System (RDS)

The audio system has a Radio Data System (RDS). The RDS feature is available for use only on FM stations that broadcast RDS information. This system relies upon receiving specific information from these stations and will only work when the information is available. While the radio is tuned to an FM-RDS station, the station name or call letters will appear on the display. In rare cases, a radio station may broadcast incorrect information that will cause the radio features to work improperly. If this happens, contact the radio station.

XM™ Satellite Radio Service

XM™ is a satellite radio service that is based in the 48 contiguous United States and in Canada (if available). XM™ offers over 100 coast-to-coast channels including music, news, sports, talk, traffic/weather, and children's programming. XM™ provides digital quality audio and text information that includes song title and artist name. A service fee is required in order to receive the XM™ service. For more information, contact XM™ at www.xmradio.com or call 1-800-852-XMXM (9696).

Playing the Radio

 **(Power/Volume):** Press this knob to turn the system on and off.

Turn this knob clockwise or counterclockwise to increase or decrease the volume.



Speed Compensated Volume (SCV): The radio has Speed Compensated Volume (SCV). When SCV is on, the radio volume automatically adjusts to compensate for road and wind noise as you speed up or slow down while driving. That way, the volume level should sound about the same as you drive. To activate SCV:

1. Set the radio volume to the desired level.
2. Press the MENU button to display the radio setup menu.
3. Press the pushbutton under the AUTO VOLUM label on the radio display.
4. Press the pushbutton under the desired Speed Compensated Volume setting (OFF, Low, Med, or High) to select the level of radio volume compensation. The display will time out after approximately 10 seconds. Each higher setting allows for more radio volume compensation at faster vehicle speeds.

Finding a Station

BAND: Press this button to switch between AM, FM, or XM™ (if equipped). The display will show the selection.

 **(Tune):** Turn this knob to select radio stations.

 **SEEK**  : Press the right or left SEEK arrow to go to the next or to the previous station and stay there.

To scan stations, press and hold either SEEK arrow for a few seconds until you hear a beep. The radio will go to a station, play for a few seconds, then go on to the next station. Press either SEEK arrow again to stop scanning.

The radio will only seek and scan stations with a strong signal that are in the selected band.

 **(Information) (XM™ Satellite Radio Service, MP3, and RDS Features):** Press the information button to display additional text information related to the current FM-RDS or XM™ station, or MP3 song. A choice of additional information such as: Channel, Song, Artist, and CAT may appear. Continue pressing the information button to highlight the desired label, or press the pushbutton positioned under any one of the labels and the information about that label will be displayed.

While information is not available, No Info will appear on the display.

Storing a Radio Station as a Favorite

Drivers are encouraged to set up their radio station favorites while the vehicle is parked. Tune to your favorite stations using the presets, favorites button, and steering wheel controls if the vehicle has this feature. See *Defensive Driving on page 4-2*.

FAV (Favorites): A maximum of 36 stations can be programmed as favorites using the six pushbuttons positioned below the radio station frequency labels and by using the radio favorites page button (FAV button). Press the FAV button to go through up to six pages of favorites, each having six favorite stations available per page. Each page of favorites can contain any combination of AM, FM, or XM™ (if equipped) stations. To store a station as a favorite, perform the following steps:

1. Tune to the desired radio station.
2. Press the FAV button to display the page where you want the station stored.
3. Press and hold one of the six pushbuttons until you hear a beep. Whenever that pushbutton is pressed and released, the station that was set will return.
4. Repeat the steps for each pushbutton radio station you want stored as a favorite.

The number of favorites pages can be setup using the MENU button. To setup the number of favorites pages, perform the following steps:

1. Press the MENU button to display the radio setup menu.
2. Press the pushbutton located below the FAV 1-6 label.
3. Select the desired number of favorites pages by pressing the pushbutton located below the displayed page numbers.
4. Press the FAV button, or let the menu time out, to return to the original main radio screen showing the radio station frequency labels and to begin the process of programming your favorites for the chosen amount of numbered pages.

Setting the Tone (Bass/Treble)

BASS/MID/TREB (Bass, Midrange, or Treble): To adjust bass, midrange, or treble, press the tune knob until the tone control labels appear on the display. Continue pressing to highlight the desired label, or press the pushbutton positioned under the desired label. Turn the tune knob clockwise or counterclockwise to adjust the highlighted setting. You can also adjust the highlighted setting by pressing either the SEEK, FWD or REV button until the desired levels are obtained. If a station's frequency is weak, or if there is static, decrease the treble.

To quickly adjust bass, midrange, or treble to the middle position, press the pushbutton positioned under the BASS, MID, or TREB label for more than two seconds. You will hear a beep and the level will be adjusted to the middle position.

To quickly adjust all tone and speaker controls to the middle position, press the tune knob for more than two seconds until you hear a beep.

EQ (Equalization): Press this button to select preset equalization settings.

To return to the manual mode, press the EQ button until Manual appears on the display or start to manually adjust the bass, midrange, or treble by pressing the tune knob.

Adjusting the Speakers (Balance/Fade)

BAL/FADE (Balance/Fade): To adjust balance or fade, press the tune knob until the speaker control labels appear on the display. Continue pressing to highlight the desired label, or press the pushbutton positioned under the desired label. Turn the tune knob clockwise or counterclockwise to adjust the highlighted setting. You can also adjust the highlighted setting by pressing either the SEEK, FWD, or REV button until the desired levels are obtained.

To quickly adjust balance or fade to the middle position, press the pushbutton positioned under the BAL or FADE label for more than two seconds. You will hear a beep and the level will be adjusted to the middle position.

To quickly adjust all speaker and tone controls to the middle position, press the tune knob for more than two seconds until you hear a beep.

Finding a Category (CAT) Station

CAT (Category): The CAT button is used to find XM™ stations while the radio is in the XM™ mode. To find XM™ channels within a desired category, perform the following:

1. Press the BAND button until the XM™ frequency is displayed. Press the CAT button to display the category labels on the radio display. Continue pressing the CAT button until the desired category name is displayed.
2. Press either of the two buttons below the desired category label to immediately tune to the first XM™ station associated with that category.
3. Rotate the tune knob, press the buttons below the right or left arrows displayed, or press the right or left SEEK buttons to go to the next or previous XM™ station within the selected category.
4. To exit the category search mode, press the FAV button or BAND button to display your favorites again.

Undesired XM™ categories can be removed through the setup menu. To remove an undesired category, perform the following:

1. Press the MENU button to display the radio setup menu.
2. Press the pushbutton located below the XM CAT label.
3. Rotate the tune knob to display the category you want removed.
4. Press the pushbutton located under the Remove label until the category name along with the word Removed appears on the display.
5. Repeat the steps to remove more categories.

Removed categories can be restored by pressing the pushbutton under the Add label when a removed category is displayed or by pressing the pushbutton under the Restore All label.

The radio will not allow you to remove or add categories while the vehicle is moving faster than 5 mph (8 kmh).

Radio Messages

Calibration Error: The audio system has been calibrated for your vehicle from the factory. If Calibration Error appears on the display, it means that the radio has not been configured properly for your vehicle and it must be returned to your dealer for service.

Locked: This message is displayed when the THEFTLOCK® system has locked up the radio. Take the vehicle to your dealer for service.

If any error occurs repeatedly or if an error cannot be corrected, contact your dealer.

XM™ Radio Messages

Radio Display Message	Condition	Action Required
XL (Explicit Language Channels)	XL on the radio display, after the channel name, indicates content with explicit language.	These channels, or any others, can be blocked at a customer's request, by calling 1-800-852-XXXM (9696).
XM Updating	Updating encryption code	The encryption code in the receiver is being updated, and no action is required. This process should take no longer than 30 seconds.
No XM Signal	Loss of signal	The system is functioning correctly, but the vehicle is in a location that is blocking the XM™ signal. When you move into an open area, the signal should return.
Loading XM	Acquiring channel audio (after four second delay)	The audio system is acquiring and processing audio and text data. No action is needed. This message should disappear shortly.
Channel Off Air	Channel not in service	This channel is not currently in service. Tune to another channel.
Channel Unavail	Channel no longer available	This previously assigned channel is no longer assigned. Tune to another station. If this station was one of the presets, choose another station for that preset button.
No Artist Info	Artist Name/Feature not available	No artist information is available at this time on this channel. The system is working properly.
No Title Info	Song/Program Title not available	No song title information is available at this time on this channel. The system is working properly.

XM™ Radio Messages (cont'd)

Radio Display Message	Condition	Action Required
No CAT Info	Category Name not available	No category information is available at this time on this channel. The system is working properly.
No Information	No Text/Informational message available	No text or informational messages are available at this time on this channel. The system is working properly.
CAT Not Found	No channel available for the chosen category	There are no channels available for the selected category. The system is working properly.
XM Theftlocked	Theftlock® active	The XM™ receiver in the vehicle may have previously been in another vehicle. For security purposes, XM™ receivers cannot be swapped between vehicles. If this message appears after having your vehicle serviced, check with your dealer.
XM Radio ID	Radio ID label (channel 0)	If tuned to channel 0, this message will alternate with the XM™ Radio eight digit radio ID label. This label is needed to activate the service.
Unknown	Radio ID not known (should only be if hardware failure)	If this message is received when tuned to channel 0, there may be a receiver fault. Consult with your dealer.
Check XM Receivr	Hardware failure	If this message does not clear within a short period of time, the receiver may have a fault. Consult with your dealer.
XM Not Available	XM™ Not Available	If this message does not clear within a short period of time, the receiver may have a fault. Consult with your dealer.

Playing a CD (Single CD Player)

Insert a CD partway into the slot, label side up. The player will pull it in and the CD should begin playing.

Playing a CD(s) (Six-Disc CD Player)

LOAD : Press this button to load CDs into the CD player. This CD player will hold up to six CDs.

To insert one CD, do the following:

1. Press and release the load button.
2. Wait for the message to insert the disc.
3. Load a CD. Insert the CD partway into the slot, label side up. The player will pull the CD in.

To insert multiple CDs, do the following:

1. Press and hold the load button for two seconds. You will hear a beep and Load All Discs will be displayed.
2. Follow the displayed instruction on when to insert the discs. The CD player takes up to six CDs.
3. Press the Load button again to cancel loading more CDs.

If the ignition or radio is turned off, with a CD in the player, it will stay in the player. When the ignition or radio is turned on, the CD will start playing where it stopped, if it was the last selected audio source.

When a CD is inserted, the CD symbol will appear on the CD. As each new track starts to play, the track number will appear on the display.

The CD player can play the smaller 3 inch (8 cm) single CDs with an adapter ring. Full-size CDs and the smaller CDs are loaded in the same manner.

If playing a CD-R, the sound quality may be reduced due to CD-R quality, the method of recording, the quality of the music that has been recorded, and the way the CD-R has been handled. There may be an increase in skipping, difficulty in finding tracks, and/or difficulty in loading and ejecting. If these problems occur, check the bottom surface of the CD. If the surface of the CD is damaged, such as cracked, broken, or scratched, the CD will not play properly. If the surface of the CD is soiled, see *Care of Your CDs on page 3-84* for more information.

If there is no apparent damage, try a known good CD.

Notice: If you add any label to a CD, insert more than one CD into the slot at a time, or attempt to play scratched or damaged CDs, you could damage the CD player. When using the CD player, use only CDs in good condition without any label, load one CD at a time, and keep the CD player and the loading slot free of foreign materials, liquids, and debris.



Do not add any label to a CD, it could get caught in the CD player. If a CD is recorded on a personal computer and a description label is needed, try labeling the top of the recorded CD with a marking pen.

If an error appears on the display, see “CD Messages” later in this section.

 **EJECT:** Press the CD eject button to eject CD(s). To eject the CD that is currently playing, press and release this button. You will hear a beep and Ejecting Disc will be displayed. Once the disc is ejected, Remove Disc will appear on display. The CD can be removed. If the CD is not removed, after several seconds, the CD will be automatically pulled back into the player and begin playing.

For the Six-Disc CD player, press and hold the eject button for two seconds to eject all discs.

 **(Tune):** Turn this knob to select tracks on the CD currently playing.

 **SEEK**  : Press the left SEEK arrow to go to the start of the current track, if more than ten seconds have played. Press the right SEEK arrow to go to the next track. If either SEEK arrow is held, or pressed multiple times, the player will continue moving backward or forward through the tracks on the CD.

 **REV (Reverse):** Press and hold this button to reverse playback quickly within a track. You will hear sound at a reduced volume. Release this pushbutton to resume playing the track. The elapsed time of the track will appear on the display.

 **FWD (Fast Forward):** Press and hold this button to advance playback quickly within a track. You will hear sound at a reduced volume. Release this button to resume playing the track. The elapsed time of the track will appear on the display.

RDM (Random): With random, you can listen to the tracks in random, rather than sequential order, on one CD or all CDs in a six-disc CD player. To use random, do one of the following:

- Press the CD/AUX button, or for a single CD player, insert a disc partway into the slot of the CD player. A RDM label will appear on display.

To play the tracks from the single CD in random order, press the pushbutton positioned under the RDM label until Random Current Disc is displayed. Press the pushbutton again to turn off random play.

- Press the CD/AUX button, or for a six-disc CD player, press and hold the LOAD button. You will hear a beep and Load All Discs will be displayed. Insert one or more discs partway into the slot of the CD player.

To play tracks from all CDs loaded in a six-disc CD player in random order, press the pushbutton positioned under the RDM label until Randomize All Discs is displayed. Press the same pushbutton again to turn off random play.

BAND: Press this button to listen to the radio while a CD is playing. The CD will remain safely inside the radio for future listening.

CD/AUX (CD/Auxiliary): Press this button to play a CD while listening to the radio. The CD icon and a message showing disc and/or track number will appear on the display when a CD is in the player. Press this button again and the system will automatically search for an auxiliary input device, such as a portable audio player. If a portable audio player is not connected, "no input device found" will be displayed.

Using an MP3/WMA CD-R or CR-W Disc

The radio will play MP3 and WMA files that were recorded on a CD-R or CD-RW disc. The files can be recorded with the following fixed bit rates: 32 kbps, 40 kbps, 56 kbps, 64 kbps, 80 kbps, 96 kbps, 112 kbps, 128 kbps, 160 kbps, 192 kbps, 224 kbps, 256 kbps, and 320 kbps or a variable bit rate. Song title, artist name, and album will be available for display by the radio when recorded using ID3 tags version 1 and 2.

Compressed Audio

The radio will also play discs that contain both uncompressed CD audio (.CDA files) and MP3/WMA files. By default the radio will read only the uncompressed audio and ignore the MP3/WMA files. Pressing the CAT button will toggle between compressed and uncompressed audio format.

MP3/WMA Format

If you burn your own MP3/WMA disc on a personal computer:

- Make sure the MP3 files are recorded on a CD-R or CD-RW disc.
- Do not mix standard audio and MP3 files on one disc.
- The CD player is able to read and play a maximum of 50 folders, 50 playlists, and 255 files.

- Create a folder structure that makes it easy to find songs while driving. Organize songs by albums using one folder for each album. Each folder or album should contain 18 songs or less.
- Avoid subfolders. The system can support up to 8 subfolders deep, however, keep the total number of folders to a minimum in order to reduce the complexity and confusion in trying to locate a particular folder during playback.
- Make sure playlists have a.m3u or.wpl extension (other file extensions may not work).
- Minimize the length of the file, folder or playlist names. Long file, folder, or playlist names, or a combination of a large number of files and folders, or playlists may cause the player to be unable to play up to the maximum number of files, folders, playlists, or sessions. If you wish to play a large number of files, folders, playlists or sessions, minimize the length of the file, folder or playlist name. Long names also take up more space on the display, potentially getting cut off.
- Finalize the audio disc before you burn it. Trying to add music to an existing disc may cause the disc not to function in the player.

You can change playlists by using the previous and next folder buttons, the tuner knob, or the seek buttons. You can also play an MP3 CD-R that was recorded using no file folders. If a CD-R contains more than the maximum of 50 folders, 50 playlists, and 255 files, the player will let you access and navigate up to the maximum, but all items over the maximum will not be accessible.

Root Directory

The root directory of the CD-R is treated as a folder. If the root directory has compressed audio files, the directory will be displayed as F1 ROOT. All files contained directly under the root directory will be accessed prior to any root directory folders. However, playlists (Px) will always be accessed before root folders or files.

Empty Directory or Folder

If a root directory or a folder exists somewhere in the file structure that contains only folders/subfolders and no compressed files directly beneath them, the player will advance to the next folder in the file structure that contains compressed audio files and the empty folder will not be displayed or numbered.

No Folder

When the CD-R contains only compressed files, the files will be located under the root folder. The next and previous folder functions will not be displayed on a CD-R that was recorded without folders or playlists. When displaying the name of the folder the radio will display ROOT.

When the CD-R contains only playlists and compressed audio files, but no folders, all files will be located under the root folder. The folder down and the folder up buttons will search playlists (Px) first and then go to the root folder. When the radio displays the name of the folder the radio will display ROOT.

Order of Play

Tracks recorded to the CD-R will be played in the following order:

- Play will begin from the first track in the first playlist and will continue sequentially through all tracks in each playlist. When the last track of the last playlist has been played, play will continue from the first track of the first playlist.
- Play will begin from the first track in the first folder and will continue sequentially through all tracks in each folder. When the last track of the last folder has been played, play will continue from the first track of the first folder.

When play enters a new folder, the display will not automatically show the new folder name unless you have chosen the folder mode as the default display. The new track name will appear on the display.

File System and Naming

The song name that will be displayed will be the song name that is contained in the ID3 tag. If the song name is not present in the ID3 tag, then the radio will display the file name without the extension (such as .mp3) as the track name.

Track names longer than 32 characters or four pages will be shortened. The display will not show parts of words on the last page of text and the extension of the filename will not be displayed.

Preprogrammed Playlists

You can access preprogrammed playlists that were created using WinAmp™, MusicMatch™, or Real Jukebox™ software, however, you will not have playlist editing capability using the radio. These playlists will be treated as special folders containing compressed audio song files.

Playing an MP3

Insert a CD-R partway into the slot (Single CD Player), or press the load button and wait for the message to insert disc (Six-Disc CD Player), label side up. The player will pull it in, and the CD-R should begin playing.

If you turn off the ignition or radio with a CD-R in the player it will stay in the player. When you turn on the ignition or radio, the CD-R will start to play where it stopped, if it was the last selected audio source.

As each new track starts to play, the track number and song title will appear on the display.

The CD player can play the smaller 3 inch (8 cm) single CD-Rs with an adapter ring. Full-size CD-Rs and the smaller CD-Rs are loaded in the same manner.

If playing a CD-R, the sound quality may be reduced due to CD-R quality, the method of recording, the quality of the music that has been recorded, and the way the CD-R has been handled. There may be an increase in skipping, difficulty in finding tracks, and/or difficulty in loading and ejecting. If these problems occur, check the bottom surface of the CD. If the surface of the CD is damaged, such as cracked, broken, or scratched, the CD will not play properly. If the surface of the CD is soiled, see *Care of Your CDs on page 3-84* for more information.

If there is no apparent damage, try a known good CD.



Notice: If you add any label to a CD, insert more than one CD into the slot at a time, or attempt to play scratched or damaged CDs, you could damage the CD player. When using the CD player, use only CDs in good condition without any label, load one CD at a time, and keep the CD player and the loading slot free of foreign materials, liquids, and debris.

Do not add any label to a CD, it could get caught in the CD player. If a CD is recorded on a personal computer and a description label is needed, try labeling the top of the recorded CD with a marking pen instead.



If an error appears on the display, see “CD Messages” later in this section.

 **EJECT:** Press the CD eject button to eject CD-R(s). To eject the CD-R that is currently playing, press and release this button. You will hear a beep and Ejecting Disc will be displayed. Once the disc is ejected, Remove Disc will appear on display. The CD-R can be removed. If the CD-R is not removed, after several seconds, the CD-R will be automatically pulled back into the player and begin playing. For the Six-Disc CD player, press and hold the eject button for two seconds to eject all discs.

 **(Tune):** Turn this knob to select MP3 files on the CD-R currently playing.

 **SEEK**  : Press the left SEEK arrow to go to the start of the current MP3 file, if more than ten seconds have played. Press the right SEEK arrow to go to the next MP3 file. If either SEEK arrow is held or pressed multiple times, the player will continue moving backward or forward through MP3 files on the CD.

 **(Previous Folder):** Press the pushbutton positioned under the Folder label to go to the first track in the previous folder.

  **(Next Folder):** Press the pushbutton positioned under the Folder label to go to the first track in the next folder.

 **REV (Reverse):** Press and hold this button to reverse playback quickly within an MP3 file. You will hear sound at a reduced volume. Release this button to resume playing the file. The elapsed time of the file will appear on the display.

 **FWD (Fast Forward):** Press and hold this button to advance playback quickly within an MP3 file. You will hear sound at a reduced volume. Release this button to resume playing the file. The elapsed time of the file will appear on the display.

RDM (Random): With random, you can listen to MP3 files on the CD-R in random, rather than sequential order, on one CD-R or all discs in a six-disc CD player. To use random, do one of the following:

1. To play MP3 files from the CD-R you are listening to in random order, press the pushbutton positioned under the RDM label until Random Current Disc is displayed. Press the same pushbutton again to turn off random play.
2. To play songs from all CDs loaded in a six-disc CD player in random order, press the pushbutton positioned under the RDM label until Randomize All Discs is displayed. Press the same pushbutton again to turn off random play.

 **(Music Navigator):** Use the music navigator feature to play MP3 files on the CD-R in order by artist or album. Press the pushbutton located below the music navigator label. The player will scan the disc to sort the files by artist and album ID3 tag information. It may take several minutes to scan the disc depending on the number of MP3 files recorded to the CD-R. The radio may begin playing while it is scanning the disc in the background. When the scan is finished, the CD-R will begin playing again.

Once the disc has been scanned, the player will default to playing MP3 files in order by artist. The current artist playing is shown on the second line of the display between the arrows. Once all songs by that artist are played, the player will move to the next artist in alphabetic order on the CD-R and begin playing MP3 files by that artist. If you want to listen to MP3 files by another artist, press the pushbutton located below either arrow button. You will go to the next or previous artist in alphabetic order. Continue pressing either button until the desired artist is displayed.

To change from playback by artist to playback by album, press the pushbutton located below the Sort By label. From the sort screen, push one of the buttons below the album button. Press the pushbutton below the back label to return to the main music navigator screen. Now the album name is displayed on the second line between the arrows and songs from the current album will begin to play. Once all songs from that album are played, the player will move to the next album in alphabetic order on the CD-R and begin playing MP3 files from that album.

To exit music navigator mode, press the pushbutton below the Back label to return to normal MP3 playback.

BAND: Press this button to listen to the radio while a CD is playing. The CD will remain safely inside the radio for future listening.

CD/AUX (CD/Auxiliary): Press this button to play a CD while listening to the radio. The CD icon and a message showing disc and/or track number will appear on the display while a CD is in the player. Press this button again and the system will automatically search for an auxiliary input device such as a portable audio player. If a portable audio player is not connected, “no input device found” will be displayed.

CD Messages

CHECK DISC: If this message appears on the display and/or the CD comes out, it could be for one of the following reasons:

- It is very hot. When the temperature returns to normal, the CD should play.
- You are driving on a very rough road. When the road becomes smoother, the CD should play.
- The CD is dirty, scratched, wet, or upside down.
- The air is very humid. If so, wait about an hour and try again.
- There may have been a problem while burning the CD.
- The label may be caught in the CD player.

If the CD is not playing correctly, for any other reason, try a known good CD.

If any error occurs repeatedly or if an error cannot be corrected, contact your dealer. If the radio displays an error message, write it down and provide it to your dealer while reporting the problem.

Using the Auxiliary Input Jack

Your radio system has an auxiliary input jack located on the lower right side of the faceplate. You can connect an external audio device such as an iPod, MP3 player, CD changer, or cassette player, to the auxiliary input jack for use as another source for audio listening.

To use a portable audio player, connect a 3.5 mm (1/8 inch) cable to the radio's front auxiliary input jack. When a device is connected, press the radio CD/AUX button to begin playing audio from the device over the car speakers.

When a device is connected, the radio automatically begins playing audio from the device over the car speakers.

 **(Power/Volume):** Turn this knob clockwise or counterclockwise to increase or decrease the volume of the portable player. You may need to do additional volume adjustments from the portable device if the volume does not go loud or soft enough.

BAND: Press this button to listen to the radio while a portable audio device is playing. The portable audio device will continue playing, so you may want to stop it or turn it off.

CD/AUX (CD/Auxiliary): Press this button to play a CD while a portable audio device is playing. Press this button again and the system will begin playing audio from the connected portable audio player. If a portable audio player is not connected, "no input device found" will be displayed.

Theft-Deterrent Feature

THEFTLOCK® is designed to discourage theft of your vehicle's radio. The feature works automatically by learning a portion of the Vehicle Identification Number (VIN). If the radio is moved to a different vehicle, it will not operate and LOCKED will appear on the display.

With THEFTLOCK® activated, the radio will not operate if stolen.

Audio Steering Wheel Controls

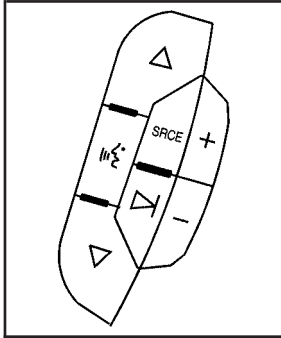

The audio steering wheel controls may be different depending on your vehicle's options. Some audio controls can be adjusted at the steering wheel. They include the following:

▽ △ **(Next/Previous):** Press the up or the down arrow to go to the next or to the previous radio station stored as a favorite.

When a CD is playing, press the up or the down arrow to go to the next or previous track.

⏏ **(Mute/Voice Recognition):** Press and release this button to silence the system. Press and release this button again, to turn the sound on.

If your vehicle has OnStar[®], press and hold this button for longer than one second to interact with the OnStar system. See the *OnStar[®] System on page 2-32* in this manual for more information.

SRCE (Source): Press this button to switch between AM, FM, XM (if equipped), CD, and AUX jack.

+ – (Volume): Press the plus or minus button to increase or to decrease the radio volume.

▷ **(Seek):** Press the seek arrow to go to the next radio station and stay there.

Radio Reception

You may experience frequency interference and static during normal radio reception if items such as cellphone chargers, vehicle convenience accessories, and external electronic devices are plugged into the accessory power outlet. If there is interference or static, unplug the item from the accessory power outlet.

AM

The range for most AM stations is greater than for FM, especially at night. The longer range can cause station frequencies to interfere with each other. For better radio reception, most AM radio stations will boost the power levels during the day, and then reduce these levels during the night. Static can also occur when things like storms and power lines interfere with radio reception. When this happens, try reducing the treble on your radio.

FM Stereo

FM stereo will give the best sound, but FM signals will reach only about 10 to 40 miles (16 to 65 km). Tall buildings or hills can interfere with FM signals, causing the sound to fade in and out.

XM™ Satellite Radio Service

XM™ Satellite Radio Service gives digital radio reception from coast-to-coast in the 48 contiguous United States, and in Canada (if available). Just as with FM, tall buildings or hills can interfere with satellite radio signals, causing the sound to fade in and out. In addition, traveling or standing under heavy foliage, bridges, garages, or tunnels may cause loss of the XM™ signal for a period of time. The radio may display NO SIGNAL to indicate interference.

Care of Your CDs

Handle CDs carefully. Store them in their original cases or other protective cases and away from direct sunlight and dust. The CD player scans the bottom surface of the disc. If the surface of a CD is damaged, such as cracked, broken, or scratched, the CD will not play properly or not at all. If the surface of a CD is soiled, take a soft, lint free cloth or dampen a clean, soft cloth in a mild, neutral detergent solution mixed with water, and clean it. Make sure the wiping process starts from the center to the edge.

Do not touch the bottom side of a CD while handling it; this could damage the surface. Pick up CDs by grasping the outer edges or the edge of the hole and the outer edge.

Care of the CD Player

The use of CD lens cleaners for CD players is not advised, due to the risk of contaminating the internal lens of the CD optics with lubricants.

Backglass Antenna

The AM-FM antenna is integrated with the rear window defogger, located in the rear window. Make sure that the inside surface of the rear window is not scratched and that the lines on the glass are not damaged. If the inside surface is damaged, it could interfere with radio reception. Also, for proper radio reception, the antenna connector at the top-center of the rear window needs to be properly attached to the post on the glass.

Notice: Do not apply aftermarket glass tinting with metallic film. The metallic film in some tinting materials will interfere with or distort the incoming radio reception. Any damage caused to your backglass antenna due to metallic tinting materials will not be covered by your warranty.

Notice: Using a razor blade or sharp object to clear the inside rear window may damage the rear window antenna and/or the rear window defogger. Repairs would not be covered by your warranty. Do not clear the inside rear window with sharp objects.

Because this antenna is built into your rear window, there is a reduced risk of damage caused by car washes and vandals.

If static is heard on the radio, when the rear window defogger is turned on, it could mean that a defogger grid line has been damaged. If this is true, the grid line must be repaired.

If you choose to add a cellular telephone to your vehicle, and the antenna needs to be attached to the glass, make sure that you do not damage the grid lines for the AM-FM antenna. There is enough space between the lines to attach a cellular telephone antenna without interfering with radio reception.

XM™ Satellite Radio Antenna System

The XM™ Satellite Radio antenna is located on the roof of your vehicle. Keep this antenna clear of snow and ice build up for clear radio reception.

If your vehicle has a sunroof, the performance of the XM™ system may be affected if the sunroof is open.

Loading items onto the roof of your vehicle can interfere with the performance of the XM™ system. Make sure the XM™ Satellite Radio antenna is not obstructed.



NOTES



Section 4 Driving Your Vehicle

Your Driving, the Road, and Your Vehicle	4-2	Freeway Driving	4-20
Defensive Driving	4-2	Before Leaving on a Long Trip	4-21
Drunken Driving	4-3	Highway Hypnosis	4-22
Control of a Vehicle	4-5	Hill and Mountain Roads	4-22
Braking	4-6	Winter Driving	4-24
Anti-Lock Brake System (ABS)	4-7	If Your Vehicle is Stuck in Sand, Mud, Ice or Snow	4-28
Braking in Emergencies	4-8	Rocking Your Vehicle to Get It Out	4-29
Traction Control System (TCS)	4-9	Loading Your Vehicle	4-29
Steering	4-10	Towing	4-34
Off-Road Recovery	4-13	Towing Your Vehicle	4-34
Passing	4-13	Recreational Vehicle Towing	4-34
Loss of Control	4-14	Towing a Trailer	4-36
Driving at Night	4-16		
Driving in Rain and on Wet Roads	4-17		
City Driving	4-19		

Your Driving, the Road, and Your Vehicle

Defensive Driving

The best advice anyone can give about driving is: Drive defensively.

Please start with a very important safety device in your vehicle: Buckle up. See *Safety Belts: They Are for Everyone* on page 1-12.

CAUTION:

Defensive driving really means “Be ready for anything.” On city streets, rural roads, or expressways, it means “Always expect the unexpected.” Assume that pedestrians or other drivers are going to be careless and make mistakes. Anticipate what they might do and be ready. Rear-end collisions are about the most preventable of accidents. Yet they are common. Allow enough following distance. Defensive driving requires that a driver concentrate on the driving task. Anything that distracts from the driving task makes proper defensive driving more difficult and can even cause a collision, with resulting injury. Ask a passenger to help do these things, or pull off the road in a safe place to do them. These simple defensive driving techniques could save your life.

Drunken Driving

Death and injury associated with drinking and driving is a national tragedy. It is the number one contributor to the highway death toll, claiming thousands of victims every year.

Alcohol affects four things that anyone needs to drive a vehicle:

- Judgment
- Muscular Coordination
- Vision
- Attentiveness

Police records show that almost half of all motor vehicle-related deaths involve alcohol. In most cases, these deaths are the result of someone who was drinking and driving. In recent years, more than 16,000 annual motor vehicle-related deaths have been associated with the use of alcohol, with more than 300,000 people injured.

Many adults — by some estimates, nearly half the adult population — choose never to drink alcohol, so they never drive after drinking. For persons under 21, it is against the law in every U.S. state to drink alcohol. There are good medical, psychological, and developmental reasons for these laws.

The obvious way to eliminate the leading highway safety problem is for people never to drink alcohol and then drive. But what if people do? How much is “too much” if someone plans to drive? It is a lot less than many might think. Although it depends on each person and situation, here is some general information on the problem.

The Blood Alcohol Concentration (BAC) of someone who is drinking depends upon four things:

- The amount of alcohol consumed
- The drinker’s body weight
- The amount of food that is consumed before and during drinking
- The length of time it has taken the drinker to consume the alcohol

According to the American Medical Association, a 180 lb (82 kg) person who drinks three 12 ounce (355 ml) bottles of beer in an hour will end up with a BAC of about 0.06 percent. The person would reach the same BAC by drinking three 4 ounce (120 ml) glasses of wine or three mixed drinks if each had 1-1/2 ounces (45 ml) of liquors like whiskey, gin, or vodka.

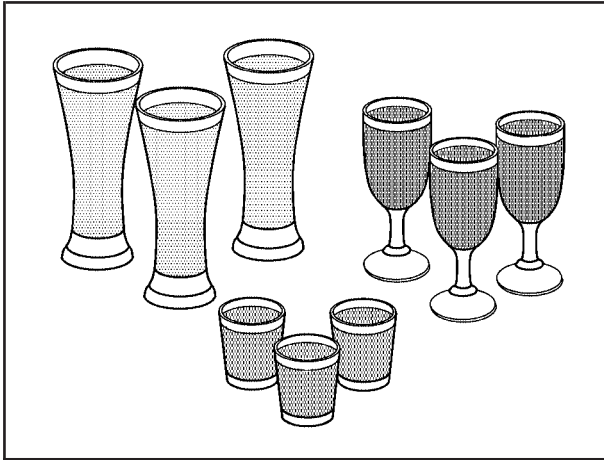

It is the amount of alcohol that counts. For example, if the same person drank three double martinis (3 ounces or 90 ml of liquor each) within an hour, the person's BAC would be close to 0.12 percent.

A person who consumes food just before or during drinking will have a somewhat lower BAC level.

There is a gender difference, too. Women generally have a lower relative percentage of body water than men. Since alcohol is carried in body water, this means that a woman generally will reach a higher BAC level than a man of her same body weight will when each has the same number of drinks.

The law in most U.S. states, and throughout Canada, sets the legal limit at 0.08 percent. In some other countries, the limit is even lower. For example, it is 0.05 percent in both France and Germany. The BAC limit for all commercial drivers in the United States is 0.04 percent.

The BAC will be over 0.10 percent after three to six drinks (in one hour). Of course, as we have seen, it depends on how much alcohol is in the drinks, and how quickly the person drinks them.

But the ability to drive is affected well below a BAC of 0.10 percent. Research shows that the driving skills of many people are impaired at a BAC approaching 0.05 percent, and that the effects are worse at night. All drivers are impaired at BAC levels above 0.05 percent. Statistics show that the chance of being in a collision increases sharply for drivers who have a BAC of 0.05 percent or above. A driver with a BAC level of 0.06 percent has doubled his or her chance of having a collision. At a BAC level of 0.10 percent, the chance of this driver having a collision is 12 times greater; at a level of 0.15 percent, the chance is 25 times greater!

The body takes about an hour to rid itself of the alcohol in one drink. No amount of coffee or number of cold showers will speed that up. “I will be careful” is not the right answer. What if there is an emergency, a need to take sudden action, as when a child darts into the street? A person with even a moderate BAC might not be able to react quickly enough to avoid the collision.

There is something else about drinking and driving that many people do not know. Medical research shows that alcohol in a person’s system can make crash injuries worse, especially injuries to the brain, spinal cord, or heart. This means that when anyone who has been drinking — driver or passenger — is in a crash, that person’s chance of being killed or permanently disabled is higher than if the person had not been drinking.

CAUTION:

Drinking and then driving is very dangerous. Your reflexes, perceptions, attentiveness, and judgment can be affected by even a small amount of alcohol. You can have a serious — or even fatal — collision if you drive after drinking. Please do not drink and drive or ride with a driver who has been drinking. Ride home in a cab; or if you are with a group, designate a driver who will not drink.

Control of a Vehicle

You have three systems that make your vehicle go where you want it to go. They are the brakes, the steering, and the accelerator. All three systems have to do their work at the places where the tires meet the road.

Sometimes, as when you are driving on snow or ice, it is easy to ask more of those control systems than the tires and road can provide. That means you can lose control of your vehicle. See *Traction Control System (TCS)* on page 4-9.

Adding non-GM accessories can affect your vehicle’s performance. See *Accessories and Modifications* on page 5-3.

Braking

See *Brake System Warning Light on page 3-31*.

Braking action involves perception time and reaction time.

First, you have to decide to push on the brake pedal. That is perception time. Then you have to bring up your foot and do it. That is reaction time.

Average reaction time is about three-fourths of a second. But that is only an average. It might be less with one driver and as long as two or three seconds or more with another. Age, physical condition, alertness, coordination, and eyesight all play a part. So do alcohol, drugs, and frustration. But even in three-fourths of a second, a vehicle moving at 60 mph (100 km/h) travels 66 feet (20 m). That could be a lot of distance in an emergency, so keeping enough space between your vehicle and others is important.

And, of course, actual stopping distances vary greatly with the surface of the road, whether it is pavement or gravel; the condition of the road, whether it is wet, dry, or icy; tire tread; the condition of your brakes; the weight of the vehicle; and the amount of brake force applied.

Avoid needless heavy braking. Some people drive in spurts — heavy acceleration followed by heavy braking — rather than keeping pace with traffic. This is a mistake. Your brakes may not have time to cool between hard stops. Your brakes will wear out much faster if you do a lot of heavy braking. If you keep pace with the traffic and allow realistic following distances, you will eliminate a lot of unnecessary braking. That means better braking and longer brake life.

If your engine ever stops while you are driving, brake normally but do not pump your brakes. If you do, the pedal may get harder to push down. If your engine stops, you will still have some power brake assist. But you will use it when you brake. Once the power assist is used up, it may take longer to stop and the brake pedal will be harder to push.

Adding non-GM accessories can affect your vehicle's performance. See *Accessories and Modifications on page 5-3*.

Anti-Lock Brake System (ABS)

Your vehicle may have the Anti-Lock Brake System (ABS), an advanced electronic braking system that will help prevent a braking skid.

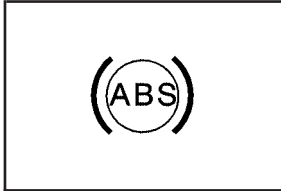

If your vehicle has ABS, this warning light on the instrument panel cluster will come on briefly when you start your vehicle.

When you start your engine, or when you begin to drive away, ABS will check itself. You may hear a momentary motor or clicking noise while this test is going on, and you may even notice that your brake pedal moves or pulses a little. This is normal.

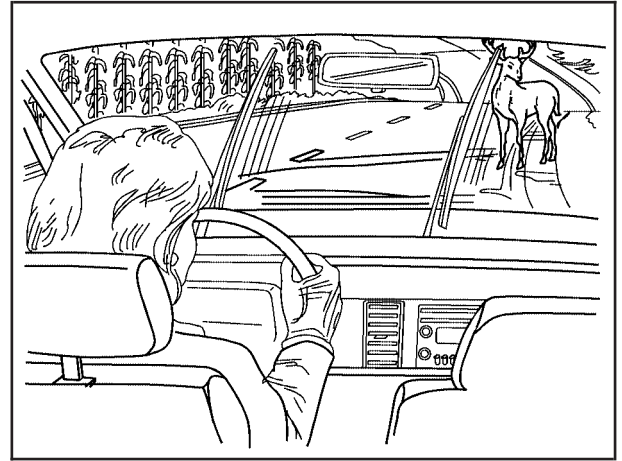

Let us say the road is wet and you are driving safely. Suddenly, an animal jumps out in front of you. You slam on the brakes and continue braking. Here is what happens with ABS:

A computer senses that wheels are slowing down. If one of the wheels is about to stop rolling, the computer will separately work the brakes at each front wheel and at both rear wheels.

ABS can change the brake pressure faster than any driver could. The computer is programmed to make the most of available tire and road conditions. This can help you steer around the obstacle while braking hard.

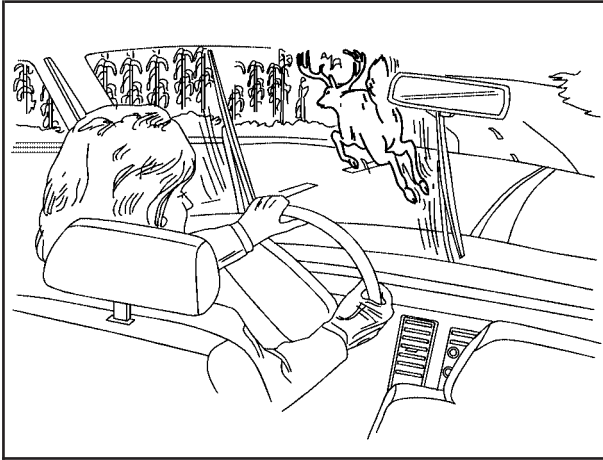

As you brake, your computer keeps receiving updates on wheel speed and controls braking pressure accordingly.

Remember: ABS does not change the time you need to get your foot up to the brake pedal or always decrease stopping distance. If you get too close to the vehicle in front of you, you will not have time to apply your brakes if that vehicle suddenly slows or stops. Always leave enough room up ahead to stop, even though you have ABS.

Using ABS

Do not pump the brakes. Just hold the brake pedal down firmly and let anti-lock work for you. You may feel a slight brake pedal pulsation or notice some noise, but this is normal.

Braking in Emergencies

At some time, nearly every driver gets into a situation that requires hard braking.

If you have ABS, you can steer and brake at the same time. However, if you do not have ABS, your first reaction — to hit the brake pedal hard and hold it down — may be the wrong thing to do. Your wheels can stop rolling. Once they do, the vehicle cannot respond to your steering. Momentum will carry it in whatever direction it was headed when the wheels stopped rolling. That could be off the road, into the very thing you were trying to avoid, or into traffic.

If you do not have ABS, use a “squeeze” braking technique. This will give you maximum braking while maintaining steering control. You can do this by pushing on the brake pedal with steadily increasing pressure.

In an emergency, you will probably want to squeeze the brakes hard without locking the wheels. If you hear or feel the wheels sliding, ease off the brake pedal. This will help you retain steering control. If you do have ABS, it is different. See *Anti-Lock Brake System (ABS)* on page 4-7.

In many emergencies, steering can help you more than even the very best braking.

Traction Control System (TCS)

Your vehicle is equipped with a Traction Control System that limits wheel spin. This is especially useful in slippery road conditions. The system operates only if it senses that one or both of the front wheels are spinning or beginning to lose traction. When this happens, the system reduces engine power and may also upshift the transaxle and apply the front brakes to limit wheel spin.



This light will flash when your Traction Control System is limiting wheel spin. See *Traction Control System (TCS) Warning Light* on page 3-32.

You may feel or hear the system working, but this is normal.

If your vehicle is in cruise control when the traction control system begins to limit wheel spin, the cruise control will automatically disengage. When road conditions allow you to safely use it again, you may re-engage the cruise control. See *Cruise Control Light* on page 3-38.

The Traction Control System operates in all transaxle shift lever positions. But the system can upshift the transaxle only as high as the shift lever position you've chosen, so you should use the lower gears only when necessary. See *Automatic Transaxle Operation* on page 2-22.

The SERVICE TRACTION CONTROL message will appear in the Driver Information (DIC) to let you know if there is a problem with the system.

See *DIC Warnings and Messages* on page 3-46. When this message appears, the system will not limit wheel spin. Adjust your driving accordingly.

To limit wheel spin, especially in slippery road conditions, you should always leave the Traction Control System on. But you can turn the system off if you ever need to.

You should turn the system off if your vehicle ever gets stuck in sand, mud or snow and rocking the vehicle is required. See *If Your Vehicle is Stuck in Sand, Mud, Ice or Snow* on page 4-28.

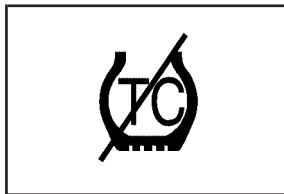

To turn the system off or on, press the traction control button located near the exterior lamp control.

When you turn the system off, a chime will sound and a TRACTION CONTROL OFF message will appear in the DIC. If the Traction Control System is limiting wheel spin when you press the button to turn the system off, the traction control system warning light will come on and the system will turn off right away.

You can turn the system back on at any time by pressing the button again. The Traction Control System warning light should go off.

Adding non-GM accessories can affect your vehicle's performance. See *Accessories and Modifications* on page 5-3 for more information.

Steering

Power Steering

If you lose power steering assist because the engine stops or the system is not functioning, you can steer but it will take much more effort.

Steering Tips

It is important to take curves at a reasonable speed.

A lot of the “driver lost control” accidents mentioned on the news happen on curves.

Here is why:

Experienced driver or beginner, each of us is subject to the same laws of physics when driving on curves. The traction of the tires against the road surface makes it possible for the vehicle to change its path when you turn the front wheels. If there is no traction, inertia will keep the vehicle going in the same direction. If you have ever tried to steer a vehicle on wet ice, you will understand this.

The traction you can get in a curve depends on the condition of your tires and the road surface, the angle at which the curve is banked, and your speed. While you are in a curve, speed is the one factor you can control.

Suppose you are steering through a sharp curve. Then you suddenly apply the brakes. Both control systems — steering and braking — have to do their work where the tires meet the road. Unless you have four-wheel anti-lock brakes, adding the hard braking can demand too much of those places. You can lose control.

The same thing can happen if you are steering through a sharp curve and you suddenly accelerate. Those two control systems — steering and acceleration — can overwhelm those places where the tires meet the road and make you lose control.

What should you do if this ever happens? Ease up on the brake or accelerator pedal, steer the vehicle the way you want it to go, and slow down.

Speed limit signs near curves warn that you should adjust your speed. Of course, the posted speeds are based on good weather and road conditions. Under less favorable conditions you will want to go slower.

If you need to reduce your speed as you approach a curve, do it before you enter the curve, while your front wheels are straight ahead.

Try to adjust your speed so you can “drive” through the curve. Maintain a reasonable, steady speed. Wait to accelerate until you are out of the curve, and then accelerate gently into the straightaway.

Adding non-GM accessories can affect your vehicle’s performance. See *Accessories and Modifications on page 5-3*.

Steering in Emergencies

There are times when steering can be more effective than braking. For example, you come over a hill and find a truck stopped in your lane, or a car suddenly pulls out from nowhere, or a child darts out from between parked cars and stops right in front of you. You can avoid these problems by braking — if you can stop in time. But sometimes you cannot; there is not room. That is the time for evasive action — steering around the problem.

Your vehicle can perform very well in emergencies like these. First apply your brakes — but, unless you have anti-lock brakes, not enough to lock your wheels.

See *Braking on page 4-6*. It is better to remove as much speed as you can from a possible collision. Then steer around the problem, to the left or right depending on the space available.

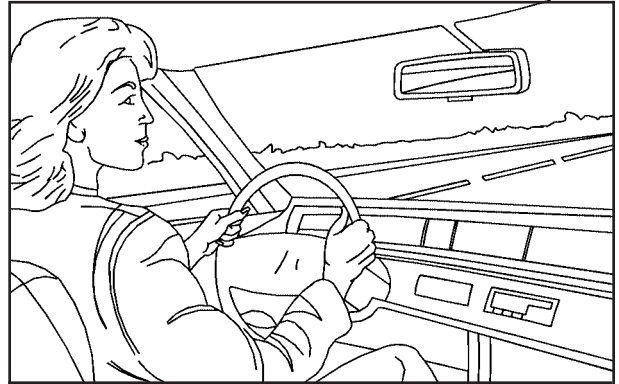

An emergency like this requires close attention and a quick decision. If you are holding the steering wheel at the recommended 9 and 3 o'clock positions, you can turn it a full 180 degrees very quickly without removing either hand. But you have to act fast, steer quickly, and just as quickly straighten the wheel once you have avoided the object.

The fact that such emergency situations are always possible is a good reason to practice defensive driving at all times and wear safety belts properly.

Off-Road Recovery

You may find that your right wheels have dropped off the edge of a road onto the shoulder while you are driving.

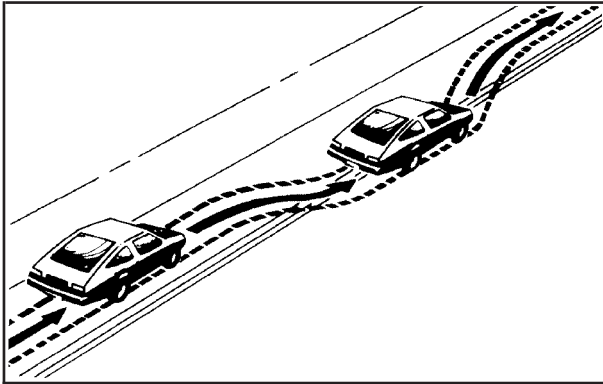

If the level of the shoulder is only slightly below the pavement, recovery should be fairly easy. Ease off the accelerator and then, if there is nothing in the way, steer so that your vehicle straddles the edge of the pavement. You can turn the steering wheel up to one-quarter turn until the right front tire contacts the pavement edge. Then turn your steering wheel to go straight down the roadway.

Passing

The driver of a vehicle about to pass another on a two-lane highway waits for just the right moment, accelerates, moves around the vehicle ahead, then goes back into the right lane again. A simple maneuver?

Not necessarily! Passing another vehicle on a two-lane highway is a potentially dangerous move, since the passing vehicle occupies the same lane as oncoming traffic for several seconds. A miscalculation, an error in judgment, or a brief surrender to frustration or anger can suddenly put the passing driver face to face with the worst of all traffic accidents — the head-on collision.

So here are some tips for passing:

- Drive ahead. Look down the road, to the sides and to crossroads for situations that might affect your passing patterns. If you have any doubt whatsoever about making a successful pass, wait for a better time.
- Watch for traffic signs, pavement markings and lines. If you can see a sign up ahead that might indicate a turn or an intersection, delay your pass. A broken center line usually indicates it is all right to pass, providing the road ahead is clear. Never cross a solid line on your side of the lane or a double solid line, even if the road seems empty of approaching traffic.

- Do not get too close to the vehicle you want to pass while you are awaiting an opportunity. For one thing, following too closely reduces your area of vision, especially if you are following a larger vehicle. Also, you will not have adequate space if the vehicle ahead suddenly slows or stops. Keep back a reasonable distance.
- When it looks like a chance to pass is coming up, start to accelerate but stay in the right lane and do not get too close. Time your move so you will be increasing speed as the time comes to move into the other lane. If the way is clear to pass, you will have a running start that more than makes up for the distance you would lose by dropping back. And if something happens to cause you to cancel your pass, you need only slow down and drop back again and wait for another opportunity.
- If other vehicles are lined up to pass a slow vehicle, wait your turn. But take care that someone is not trying to pass you as you pull out to pass the slow vehicle. Remember to glance over your shoulder and check the blind spot.
- Check your mirrors, glance over your shoulder, and start your left lane change signal before moving out of the right lane to pass. When you are far enough ahead of the passed vehicle to see its front in your inside mirror, activate your right lane change signal and move back into the right lane.

Remember that your passenger side outside mirror is convex. The vehicle you just passed may seem to be farther away from you than it really is.

- Try not to pass more than one vehicle at a time on two-lane roads. Reconsider before passing the next vehicle.
- Do not overtake a slowly moving vehicle too rapidly. Even though the brake lamps are not flashing, it may be slowing down or starting to turn.
- If you are being passed, make it easy for the following driver to get ahead of you. Perhaps you can ease a little to the right.

Loss of Control

Let us review what driving experts say about what happens when the three control systems — brakes, steering, and acceleration — do not have enough friction where the tires meet the road to do what the driver has asked.

In any emergency, do not give up. Keep trying to steer and constantly seek an escape route or area of less danger.

Skidding

In a skid, a driver can lose control of the vehicle. Defensive drivers avoid most skids by taking reasonable care suited to existing conditions, and by not overdriving those conditions. But skids are always possible.

The three types of skids correspond to your vehicle's three control systems. In the braking skid, your wheels are not rolling. In the steering or cornering skid, too much speed or steering in a curve causes tires to slip and lose cornering force. And in the acceleration skid, too much throttle causes the driving wheels to spin.

A cornering skid and an acceleration skid are best handled by easing your foot off the accelerator pedal.

If your vehicle starts to slide, ease your foot off the accelerator pedal and quickly steer the way you want the vehicle to go. If you start steering quickly enough, your vehicle may straighten out. Always be ready for a second skid if it occurs.

Of course, traction is reduced when water, snow, ice, gravel, or other material is on the road. For safety, you will want to slow down and adjust your driving to these conditions. It is important to slow down on slippery surfaces because stopping distance will be longer and vehicle control more limited.

While driving on a surface with reduced traction, try your best to avoid sudden steering, acceleration, or braking, including engine braking by shifting to a lower gear. Any sudden changes could cause the tires to slide. You may not realize the surface is slippery until your vehicle is skidding. Learn to recognize warning clues — such as enough water, ice, or packed snow on the road to make a mirrored surface — and slow down when you have any doubt.

If you have the Anti-Lock Brake System (ABS), remember: It helps avoid only the braking skid. If you do not have ABS, then in a braking skid, where the wheels are no longer rolling, release enough pressure on the brakes to get the wheels rolling again. This restores steering control. Push the brake pedal down steadily when you have to stop suddenly. As long as the wheels are rolling, you will have steering control.

Driving at Night

Night driving is more dangerous than day driving. One reason is that some drivers are likely to be impaired — by alcohol or drugs, with night vision problems, or by fatigue.

Here are some tips on night driving.

- Drive defensively.
- Do not drink and drive.
- Adjust the inside rearview mirror to reduce the glare from headlamps behind you.
- Since you cannot see as well, you may need to slow down and keep more space between you and other vehicles.
- Slow down, especially on higher speed roads. Your vehicle's headlamps can light up only so much road ahead.
- In remote areas, watch for animals.
- If you are tired, pull off the road in a safe place and rest.

No one can see as well at night as in the daytime. But as we get older these differences increase. A 50-year-old driver may require at least twice as much light to see the same thing at night as a 20-year-old.

What you do in the daytime can also affect your night vision. For example, if you spend the day in bright sunshine you are wise to wear sunglasses. Your eyes will have less trouble adjusting to night. But if you are driving, do not wear sunglasses at night. They may cut down on glare from headlamps, but they also make a lot of things invisible.

You can be temporarily blinded by approaching headlamps. It can take a second or two, or even several seconds, for your eyes to re-adjust to the dark. When you are faced with severe glare, as from a driver who does not lower the high beams, or a vehicle with misaimed headlamps, slow down a little. Avoid staring directly into the approaching headlamps.

Keep the windshield and all the glass on your vehicle clean — inside and out. Glare at night is made much worse by dirt on the glass. Even the inside of the glass can build up a film caused by dust. Dirty glass makes lights dazzle and flash more than clean glass would, making the pupils of your eyes contract repeatedly.

Remember that the headlamps light up far less of a roadway when you are in a turn or curve. Keep your eyes moving; that way, it is easier to pick out dimly lighted objects. Just as the headlamps should be checked regularly for proper aim, so should your eyes be examined regularly. Some drivers suffer from night blindness — the inability to see in dim light — and are not even aware of it.

Driving in Rain and on Wet Roads

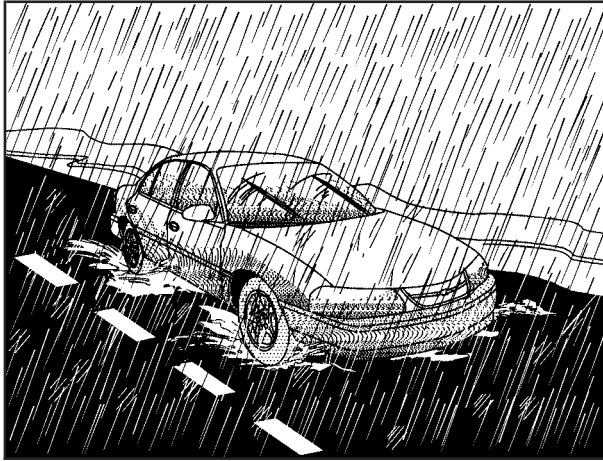

Rain and wet roads can mean driving trouble. On a wet road, you cannot stop, accelerate, or turn as well because your tire-to-road traction is not as good as on dry roads. And, if your tires do not have much tread left, you will get even less traction. It is always wise to go slower and be cautious if rain starts to fall while you are driving. The surface may get wet suddenly when your reflexes are tuned for driving on dry pavement.

The heavier the rain, the harder it is to see. Even if your windshield wiper blades are in good shape, a heavy rain can make it harder to see road signs and traffic signals, pavement markings, the edge of the road, and even people walking.

It is wise to keep your windshield wiping equipment in good shape and keep your windshield washer fluid reservoir filled with washer fluid. Replace your windshield wiper inserts when they show signs of streaking or missing areas on the windshield, or when strips of rubber start to separate from the inserts.

CAUTION:

Wet brakes can cause accidents. They will not work as well in a quick stop and may cause pulling to one side. You could lose control of the vehicle.

After driving through a large puddle of water or a car wash, apply your brake pedal lightly until your brakes work normally.

Driving too fast through large water puddles or even going through some car washes can cause problems, too. The water may affect your brakes. Try to avoid puddles. But if you cannot, try to slow down before you hit them.

Hydroplaning

Hydroplaning is dangerous. So much water can build up under your tires that they can actually ride on the water. This can happen if the road is wet enough and you are going fast enough. When your vehicle is hydroplaning, it has little or no contact with the road.

Hydroplaning does not happen often. But it can if your tires do not have much tread or if the pressure in one or more is low. It can happen if a lot of water is standing on the road. If you can see reflections from trees, telephone poles, or other vehicles, and raindrops dimple the water's surface, there could be hydroplaning.

Hydroplaning usually happens at higher speeds. There just is not a hard and fast rule about hydroplaning. The best advice is to slow down when it is raining.

Driving Through Deep Standing Water

Notice: If you drive too quickly through deep puddles or standing water, water can come in through your engine's air intake and badly damage your engine. Never drive through water that is slightly lower than the underbody of your vehicle. If you cannot avoid deep puddles or standing water, drive through them very slowly.

Driving Through Flowing Water

CAUTION:

Flowing or rushing water creates strong forces. If you try to drive through flowing water, as you might at a low water crossing, your vehicle can be carried away. As little as six inches of flowing water can carry away a smaller vehicle. If this happens, you and other vehicle occupants could drown. Do not ignore police warning signs, and otherwise be very cautious about trying to drive through flowing water.

Some Other Rainy Weather Tips

- Besides slowing down, allow some extra following distance. And be especially careful when you pass another vehicle. Allow yourself more clear room ahead, and be prepared to have your view restricted by road spray.
- Have good tires with proper tread depth. See *Tires on page 5-54*.

City Driving

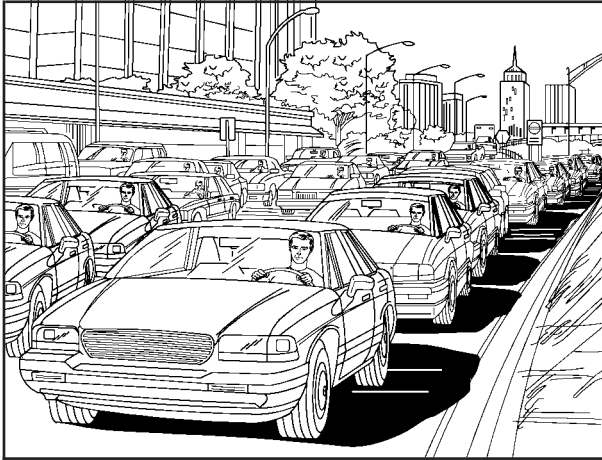

One of the biggest problems with city streets is the amount of traffic on them. You will want to watch out for what the other drivers are doing and pay attention to traffic signals.

Here are ways to increase your safety in city driving:

- Know the best way to get to where you are going. Get a city map and plan your trip into an unknown part of the city just as you would for a cross-country trip.
- Try to use the freeways that rim and crisscross most large cities. You will save time and energy. See *Freeway Driving on page 4-20*.
- Treat a green light as a warning signal. A traffic light is there because the corner is busy enough to need it. When a light turns green, and just before you start to move, check both ways for vehicles that have not cleared the intersection or may be running the red light.

Freeway Driving



Mile for mile, freeways — also called thruways, parkways, expressways, turnpikes, or superhighways — are the safest of all roads. But they have their own special rules.

The most important advice on freeway driving is: Keep up with traffic and keep to the right. Drive at the same speed most of the other drivers are driving. Too-fast or too-slow driving breaks a smooth traffic flow. Treat the left lane on a freeway as a passing lane.

At the entrance, there is usually a ramp that leads to the freeway. If you have a clear view of the freeway as you drive along the entrance ramp, you should begin to check traffic. Try to determine where you expect to blend with the flow. Try to merge into the gap at close to the prevailing speed. Switch on your turn signal, check your mirrors, and glance over your shoulder as often as necessary. Try to blend smoothly with the traffic flow.

Once you are on the freeway, adjust your speed to the posted limit or to the prevailing rate if it is slower. Stay in the right lane unless you want to pass.

Before changing lanes, check your mirrors. Then use your turn signal.

Just before you leave the lane, glance quickly over your shoulder to make sure there is not another vehicle in your blind spot.

Once you are moving on the freeway, make certain you allow a reasonable following distance.

Expect to move slightly slower at night.

When you want to leave the freeway, move to the proper lane well in advance. If you miss your exit, do not, under any circumstances, stop and back up. Drive on to the next exit.

The exit ramp can be curved, sometimes quite sharply. The exit speed is usually posted. Reduce your speed according to your speedometer, not to your sense of motion. After driving for any distance at higher speeds, you may tend to think you are going slower than you actually are.

Before Leaving on a Long Trip

Make sure you are ready. Try to be well rested. If you must start when you are not fresh — such as after a day's work — do not plan to make too many miles that first part of the journey. Wear comfortable clothing and shoes you can easily drive in.

Is your vehicle ready for a long trip? If you keep it serviced and maintained, it is ready to go. If it needs service, have it done before starting out. Of course, you will find experienced and able service experts in GM dealerships all across North America. They will be ready and willing to help if you need it.

Here are some things you can check before a trip:

- *Windshield Washer Fluid:* Is the reservoir full? Are all windows clean inside and outside?
- *Wiper Blades:* Are they in good shape?
- *Fuel, Engine Oil, Other Fluids:* Have you checked all levels?
- *Lamps:* Are they all working? Are the lenses clean?
- *Tires:* They are vitally important to a safe, trouble-free trip. Is the tread good enough for long-distance driving? Are the tires all inflated to the recommended pressure?
- *Weather Forecasts:* What is the weather outlook along your route? Should you delay your trip a short time to avoid a major storm system?
- *Maps:* Do you have up-to-date maps?

Highway Hypnosis

Is there actually such a condition as highway hypnosis? Or is it just plain falling asleep at the wheel? Call it highway hypnosis, lack of awareness, or whatever.

There is something about an easy stretch of road with the same scenery, along with the hum of the tires on the road, the drone of the engine, and the rush of the wind against the vehicle that can make you sleepy. Do not let it happen to you! If it does, your vehicle can leave the road in less than a second, and you could crash and be injured.

What can you do about highway hypnosis? First, be aware that it can happen.

Then here are some tips:

- Make sure your vehicle is well ventilated, with a comfortably cool interior.
- Keep your eyes moving. Scan the road ahead and to the sides. Check your rearview mirrors and your instruments frequently.
- If you get sleepy, pull off the road into a rest, service, or parking area and take a nap, get some exercise, or both. For safety, treat drowsiness on the highway as an emergency.

Hill and Mountain Roads



Driving on steep hills or mountains is different from driving in flat or rolling terrain.

If you drive regularly in steep country, or if you are planning to visit there, here are some tips that can make your trips safer and more enjoyable.

- Keep your vehicle in good shape. Check all fluid levels and also the brakes, tires, cooling system, and transaxle. These parts can work hard on mountain roads.

 **CAUTION:**

If you do not shift down, your brakes could get so hot that they would not work well. You would then have poor braking or even none going down a hill. You could crash. Shift down to let your engine assist your brakes on a steep downhill slope.

 **CAUTION:**

Coasting downhill in NEUTRAL (N) or with the ignition off is dangerous. Your brakes will have to do all the work of slowing down. They could get so hot that they would not work well. You would then have poor braking or even none going down a hill. You could crash. Always have your engine running and your vehicle in gear when you go downhill.

- Know how to go down hills. The most important thing to know is this: let your engine do some of the slowing down. Shift to a lower gear when you go down a steep or long hill.
- Know how to go uphill. You may want to shift down to a lower gear. The lower gears help cool your engine and transaxle, and you can climb the hill better.
- Stay in your own lane when driving on two-lane roads in hills or mountains. Do not swing wide or cut across the center of the road. Drive at speeds that let you stay in your own lane.
- As you go over the top of a hill, be alert. There could be something in your lane, like a stalled car or an accident.
- You may see highway signs on mountains that warn of special problems. Examples are long grades, passing or no-passing zones, a falling rocks area, or winding roads. Be alert to these and take appropriate action.

Winter Driving



Here are some tips for winter driving:

- Have your vehicle in good shape for winter.
- You may want to put winter emergency supplies in your trunk.

Also see *Tires* on page 5-54.



Include an ice scraper, a small brush or broom, a supply of windshield washer fluid, a rag, some winter outer clothing, a small shovel, a flashlight, a red cloth, and a couple of reflective warning triangles. And, if you will be driving under severe conditions, include a small bag of sand, a piece of old carpet, or a couple of burlap bags to help provide traction. Be sure you properly secure these items in your vehicle.

Driving on Snow or Ice

Most of the time, those places where the tires meet the road probably have good traction.

However, if there is snow or ice between the tires and the road, you can have a very slippery situation. You will have a lot less traction, or grip, and will need to be very careful.



What is the worst time for this? Wet ice. Very cold snow or ice can be slick and hard to drive on. But wet ice can be even more trouble because it may offer the least traction of all. You can get wet ice when it is about freezing, 32°F (0°C), and freezing rain begins to fall. Try to avoid driving on wet ice until salt and sand crews can get there.

Whatever the condition — smooth ice, packed, blowing, or loose snow — drive with caution.

Traction control improves your ability to accelerate when driving on a slippery road. Even though your vehicle has the Traction Control System (TCS), you will want to slow down and adjust your driving to the road conditions. Under certain conditions, you may want to turn the traction control system off, such as when driving through deep snow and loose gravel, to help maintain vehicle motion at lower speeds. See *Traction Control System (TCS)* on page 4-9.

Unless you have the Anti-Lock Brake System (ABS), you will want to brake very gently, too. If you do have ABS, see *Anti-Lock Brake System (ABS)* on page 4-7. ABS improves your vehicle's stability when you make a hard stop on a slippery road. Whether you have ABS or not, you will want to begin stopping sooner than you would on dry pavement. Without ABS, if you feel your vehicle begin to slide, let up on the brakes a little. Push the brake pedal down steadily to get the most traction you can.

Remember, unless you have ABS, if you brake so hard that your wheels stop rolling, you will just slide. Brake so your wheels always keep rolling and you can still steer.

- Whatever your braking system, allow greater following distance on any slippery road.
- Watch for slippery spots. The road might be fine until you hit a spot that is covered with ice. On an otherwise clear road, ice patches may appear in shaded areas where the sun cannot reach, such as around clumps of trees, behind buildings, or under bridges. Sometimes the surface of a curve or an overpass may remain icy when the surrounding roads are clear. If you see a patch of ice ahead of you, brake before you are on it. Try not to brake while you are actually on the ice, and avoid sudden steering maneuvers.

If You Are Caught in a Blizzard

If you are stopped by heavy snow, you could be in a serious situation. You should probably stay with your vehicle unless you know for sure that you are near help and you can hike through the snow. Here are some things to do to summon help and keep yourself and your passengers safe:

- Turn on your hazard flashers.
- Tie a red cloth to your vehicle to alert police that you have been stopped by the snow.
- Put on extra clothing or wrap a blanket around you. If you do not have blankets or extra clothing, make body insulators from newspapers, burlap bags, rags, floor mats — anything you can wrap around yourself or tuck under your clothing to keep warm.

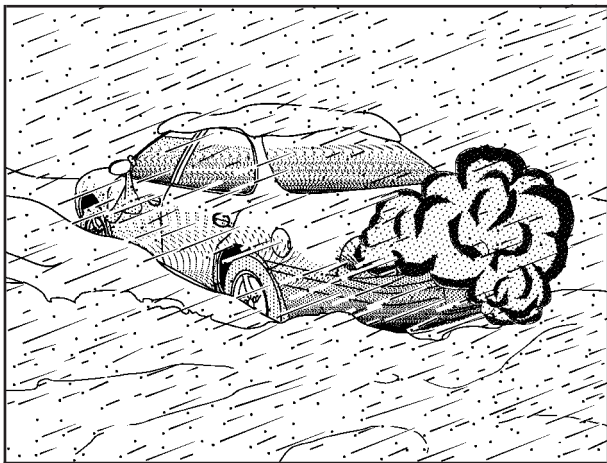

You can run the engine to keep warm, but be careful.

⚠ CAUTION:

Snow can trap exhaust gases under your vehicle. This can cause deadly CO (carbon monoxide) gas to get inside. CO could overcome you and kill you. You cannot see it or smell it, so you might not know it is in your vehicle. Clear away snow from around the base of your vehicle, especially any that is blocking your exhaust pipe. And check around again from time to time to be sure snow does not collect there.

Open a window just a little on the side of the vehicle that is away from the wind. This will help keep CO out.

Run your engine only as long as you must. This saves fuel. When you run the engine, make it go a little faster than just idle. That is, push the accelerator slightly. This uses less fuel for the heat that you get and it keeps the battery charged. You will need a well-charged battery to restart the vehicle, and possibly for signaling later on with your headlamps. Let the heater run for a while.

Then, shut the engine off and close the window almost all the way to preserve the heat. Start the engine again and repeat this only when you feel really uncomfortable from the cold. But do it as little as possible. Preserve the fuel as long as you can. To help keep warm, you can get out of the vehicle and do some fairly vigorous exercises every half hour or so until help comes.

If Your Vehicle is Stuck in Sand, Mud, Ice or Snow

In order to free your vehicle when it is stuck, you will need to spin the wheels, but you do not want to spin your wheels too fast. The method known as rocking can help you get out when you are stuck, but you must use caution.

CAUTION:

If you let your tires spin at high speed, they can explode, and you or others could be injured. And, the transaxle or other parts of the vehicle can overheat. That could cause an engine compartment fire or other damage. When you are stuck, spin the wheels as little as possible. Do not spin the wheels above 35 mph (55 km/h) as shown on the speedometer.

***Notice:* Spinning your wheels can destroy parts of your vehicle as well as the tires. If you spin the wheels too fast while shifting your transaxle back and forth, you can destroy your transaxle. See *Rocking Your Vehicle to Get It Out* on page 4-29.**

For information about using tire chains on your vehicle, see *Tire Chains* on page 5-73.

Rocking Your Vehicle to Get It Out

First, turn your steering wheel left and right. That will clear the area around your front wheels. If your vehicle has traction control, you should turn your traction control system off. See *Traction Control System (TCS)* on page 4-9. Then shift back and forth between REVERSE (R) and a forward gear, spinning the wheels as little as possible. Release the accelerator pedal while you shift, and press lightly on the accelerator pedal when the transaxle is in gear. By slowly spinning your wheels in the forward and reverse directions, you will cause a rocking motion that may free your vehicle. If that does not get you out after a few tries, you may need to be towed out. If you do need to be towed out, see *Towing Your Vehicle* on page 4-34.

Loading Your Vehicle

It is very important to know how much weight your vehicle can carry. Two labels on your vehicle show how much weight it may properly carry, the Tire and Loading Information label and the Vehicle Certification label.

CAUTION:

Do not load your vehicle any heavier than the Gross Vehicle Weight Rating (GVWR), or either the maximum front or rear Gross Axle Weight Rating (GAWR). If you do, parts on your vehicle can break, and it can change the way your vehicle handles. These could cause you to lose control and crash. Also, overloading can shorten the life of your vehicle.

Tire and Loading Information Label

The diagram shows a rectangular label with a tire icon on the left. Callout A points to the tire icon. Callout B points to the title 'TIRE AND LOADING INFORMATION'. Callout C points to the 'ORIGINAL SIZE' column in the table. Callout D points to the 'COLD TIRE PRESSURE' column in the table.

TIRE AND LOADING INFORMATION			
SEATING CAPACITY	TOTAL	FRONT	REAR
The combined weight of occupants and cargo should never exceed XXX kg or XXX lbs.			
TIRE	ORIGINAL SIZE	COLD TIRE PRESSURE	SEE OWNER'S MANUAL FOR ADDITIONAL INFORMATION
FRONT			
REAR			
SPARE			

Label Example

A vehicle specific Tire and Loading Information label is attached to the vehicle's center pillar (B-pillar). With the driver's door open, you will find the label attached below the door lock post (striker). The tire and loading information label lists the number of occupant seating positions (A), and the maximum vehicle capacity weight (B) in kilograms and pounds.

The Tire and Loading Information label also lists the tire size of the original equipment tires (C) and the recommended cold tire inflation pressures (D). For more information on tires and inflation, see *Tires on page 5-54* and *Inflation - Tire Pressure on page 5-60*.

There is also important loading information on the Certification label. It tells you the Gross Vehicle Weight Rating (GVWR) and the Gross Axle Weight Rating (GAWR) for the front and rear axle, see "Certification Label" later in this section.

Steps for Determining Correct Load Limit

1. Locate the statement "The combined weight of occupants and cargo should never exceed XXX kg or XXX lbs" on your vehicle's placard.
2. Determine the combined weight of the driver and passengers that will be riding in your vehicle.
3. Subtract the combined weight of the driver and passengers from XXX kg or XXX lbs.
4. The resulting figure equals the available amount of cargo and luggage load capacity. For example, if the "XXX" amount equals 1400 lbs and there will be five 150 lb passengers in your vehicle, the amount of available cargo and luggage load capacity is 650 lbs (1400 – 750 (5 x 150) = 650 lbs).

5. Determine the combined weight of luggage and cargo being loaded on the vehicle. That weight may not safely exceed the available cargo and luggage load capacity calculated in Step 4.
6. If your vehicle will be towing a trailer, the load from your trailer will be transferred to your vehicle. Consult this manual to determine how this reduces the available cargo and luggage load capacity for your vehicle.

If your vehicle can tow a trailer, see *Towing a Trailer on page 4-36* for important information on towing a trailer, towing safety rules, and trailering tips.

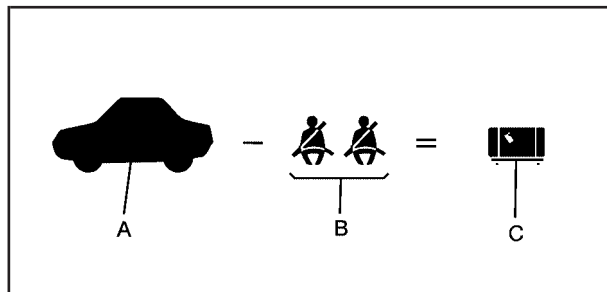

Example 1

Item	Description	Total
A	Maximum Vehicle Capacity Weight for Example 1 =	1,000 lbs (453 kg)
B	Subtract Occupant Weight 150 lbs (68 kg) × 2 =	300 lbs (136 kg)
C	Available Occupant and Cargo Weight =	700 lbs (317 kg)

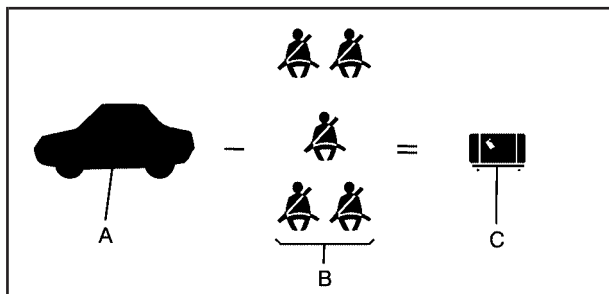

Example 2

Item	Description	Total
A	Maximum Vehicle Capacity Weight for Example 2 =	1,000 lbs (453 kg)
B	Subtract Occupant Weight 150 lbs (68 kg) × 5 =	750 lbs (340 kg)
C	Available Cargo Weight =	250 lbs (113 kg)

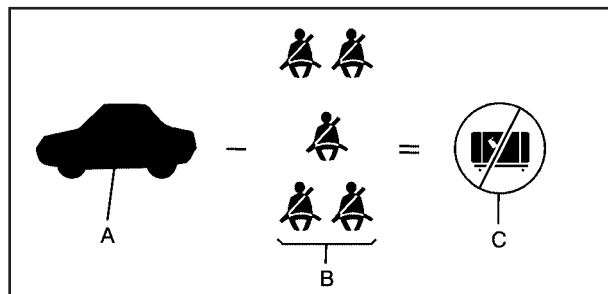

Example 3

Item	Description	Total
A	Maximum Vehicle Capacity Weight for Example 3 =	1,000 lbs (453 kg)
B	Subtract Occupant Weight 200 lbs (91 kg) × 5 =	1,000 lbs (453 kg)
C	Available Cargo Weight =	0 lbs (0 kg)

Refer to your vehicle's tire and loading information label for specific information about your vehicle's maximum vehicle capacity weight and seating positions. The combined weight of the driver, passengers, and cargo should never exceed your vehicle's maximum vehicle capacity weight.

Certification Label

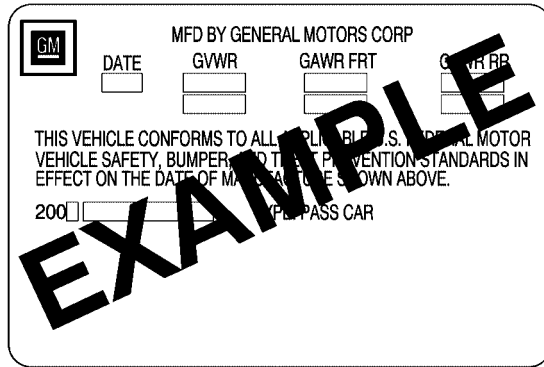

The image shows a GM Certification Label with a large diagonal watermark that reads "EXAMPLE". The label includes the GM logo, the text "MFD BY GENERAL MOTORS CORP", and a table with four columns: "DATE", "GVWR", "GAWR FRT", and "GAWR RR". Each column has a corresponding empty box for data entry. Below the table, there is a paragraph of text: "THIS VEHICLE CONFORMS TO ALL APPLICABLE U.S. FEDERAL MOTOR VEHICLE SAFETY, BUMPER, AND TRAFFIC PREVENTION STANDARDS IN EFFECT ON THE DATE OF MANUFACTURE SHOWN ABOVE." At the bottom, there is a line with "200" followed by a box and the text "TYPE PASS CAR".

A vehicle specific Certification label is found on the rear edge of the driver's door.

The label shows the gross weight capacity of your vehicle, called the Gross Vehicle Weight Rating (GVWR). The GVWR includes the weight of the vehicle, all occupants, fuel, and cargo.

Never exceed the GVWR for your vehicle or the Gross Axle Weight Rating (GAWR) for either the front or rear axle.

If the vehicle is going to carry a heavy load, spread it out. Do not carry more than 167 lbs (76 kg) in the trunk.

CAUTION:

Do not load your vehicle any heavier than the Gross Vehicle Weight Rating (GVWR), or either the maximum front or rear Gross Axle Weight Rating (GAWR). If you do, parts on your vehicle can break, and it can change the way your vehicle handles. These could cause you to lose control and crash. Also, overloading can shorten the life of your vehicle.

Notice: Overloading your vehicle may cause damage. Repairs would not be covered by your warranty. Do not overload your vehicle.

If things like suitcases, tools, packages, or anything else are put inside the vehicle, they will go as fast as the vehicle goes. If you have to stop or turn quickly, or if there is a crash, they will keep going.

CAUTION:

Things you put inside your vehicle can strike and injure people in a sudden stop or turn, or in a crash.

- **Put things in the trunk of your vehicle. In a trunk, put them as far forward as you can. Try to spread the weight evenly.**
- **Never stack heavier things, like suitcases, inside the vehicle so that some of them are above the tops of the seats.**
- **Do not leave an unsecured child restraint in your vehicle.**
- **When you carry something inside the vehicle, secure it whenever you can.**
- **Do not leave a seat folded down unless you need to.**

Towing

Towing Your Vehicle

Consult your dealer or a professional towing service if you need to have your disabled vehicle towed. See *Roadside Assistance Program on page 7-5*.

If you want to tow your vehicle behind another vehicle for recreational purposes (such as behind a motorhome), see “Recreational Vehicle Towing” following.

Recreational Vehicle Towing

Recreational vehicle towing means towing your vehicle behind another vehicle — such as behind a motorhome. The two most common types of recreational vehicle towing are known as “dinghy towing” (towing your vehicle with all four wheels on the ground) and “dolly towing” (towing your vehicle with two wheels on the ground and two wheels up on a device known as a “dolly”).

With the proper preparation and equipment, many vehicles can be towed in these ways. See “Dinghy Towing” and “Dolly Towing,” following.

Here are some important things to consider before you do recreational vehicle towing:

- What's the towing capacity of the towing vehicle? Be sure you read the tow vehicle manufacturer's recommendations.
- How far will you tow? Some vehicles have restrictions on how far and how long they can tow.
- Do you have the proper towing equipment? See your dealer or trailering professional for additional advice and equipment recommendations.
- Is your vehicle ready to be towed? Just as you would prepare your vehicle for a long trip, you'll want to make sure your vehicle is prepared to be towed. See *Before Leaving on a Long Trip on page 4-21*.

Dinghy Towing

Notice: If you tow your vehicle with all four wheels on the ground, the drivetrain components could be damaged. The repairs would not be covered by your warranty. Do not tow your vehicle with all four wheels on the ground.

Your vehicle was not designed to be towed with all four wheels on the ground. If your vehicle must be towed, you should use a dolly. See "Dolly Towing" following for more information.

Dolly Towing

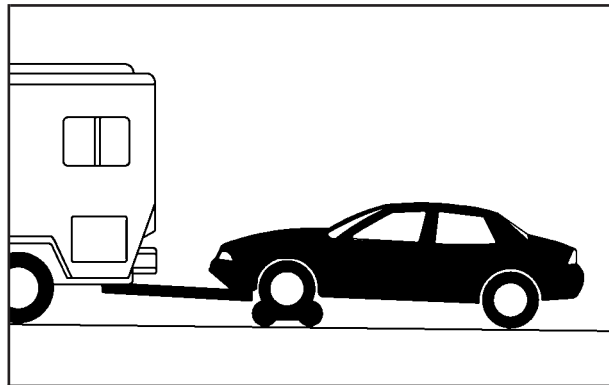

Your vehicle can be towed using a dolly. To tow your vehicle using a dolly, follow these steps:

1. Put the front wheels on the dolly.
2. Put the vehicle in PARK (P).
3. Set the parking brake and then remove the key.
4. Clamp the steering wheel in a straight-ahead position.
5. Release the parking brake.

Towing a Trailer

CAUTION:

If you do not use the correct equipment and drive properly, you can lose control when you pull a trailer. For example, if the trailer is too heavy, the brakes may not work well — or even at all. You and your passengers could be seriously injured. You may also damage your vehicle; the resulting repairs would not be covered by your warranty. Pull a trailer only if you have followed all the steps in this section. Ask your dealer for advice and information about towing a trailer with your vehicle.

To identify the trailering capacity of your vehicle, you should read the information in “Weight of the Trailer” that appears later in this section. Trailering is different than just driving your vehicle by itself. Trailering means changes in handling, durability and fuel economy. Successful, safe trailering takes correct equipment, and it has to be used properly.

That’s the reason for this part. In it are many time-tested, important trailering tips and safety rules. Many of these are important for your safety and that of your passengers. So please read this section carefully before you pull a trailer.

Load-pulling components such as the engine, transaxle, wheel assemblies and tires are forced to work harder against the drag of the added weight. The engine is required to operate at relatively higher speeds and under greater loads, generating extra heat. What’s more, the trailer adds considerably to wind resistance, increasing the pulling requirements.

If You Do Decide To Pull A Trailer

If you do, here are some important points:

- There are many different laws, including speed limit restrictions, having to do with trailering. Make sure your rig will be legal, not only where you live but also where you'll be driving. A good source for this information can be state or provincial police.
- Consider using a sway control. You can ask a hitch dealer about sway controls.
- Don't tow a trailer at all during the first 1,000 miles (1 600 km) your new vehicle is driven. Your engine, axle or other parts could be damaged.
- Then, during the first 500 miles (800 km) that you tow a trailer, don't drive over 50 mph (80 km/h) and don't make starts at full throttle. This helps your engine and other parts of your vehicle wear in at the heavier loads.
- Obey speed limit restrictions when towing a trailer. Don't drive faster than the maximum posted speed for trailers, or no more than 55 mph (90 km/h), to save wear on your vehicle's parts.

Three important considerations have to do with weight:

- the weight of the trailer,
- the weight of the trailer tongue
- and the total weight on your vehicle's tires.

Weight of the Trailer

How heavy can a trailer safely be?

It should never weigh more than 1,000 lbs (454 kg). But even that can be too heavy.

It depends on how you plan to use your rig. For example, speed, altitude, road grades, outside temperature and how much your vehicle is used to pull a trailer are all important. It can also depend on any special equipment that you have on your vehicle, and the amount of tongue weight the vehicle can carry. See "Weight of the Trailer Tongue" later in this section for more information.

Maximum trailer weight is calculated assuming only the driver is in the tow vehicle and it has all the required trailering equipment. The weight of additional optional equipment, passengers and cargo in the tow vehicle must be subtracted from the maximum trailer weight.

You can ask your dealer for our trailering information or advice, or you can write us at:

Chevrolet Customer Assistance Center
P.O. Box 33170
Detroit, MI 48232-5170

In Canada, write to:

General Motors of Canada Limited
Customer Communication Centre, 163-005
1908 Colonel Sam Drive
Oshawa, Ontario L1H 8P7

Weight of the Trailer Tongue

The tongue load (A) of any trailer is an important weight to measure because it affects the total or gross weight of your vehicle. The Gross Vehicle Weight (GVW) includes the curb weight of the vehicle, any cargo you may carry in it, and the people who will be riding in the vehicle. And if you tow a trailer, you must add the tongue load to the GVW because your vehicle will be carrying that weight, too. See *Loading Your Vehicle on page 4-29* for more information about your vehicle's maximum load capacity.

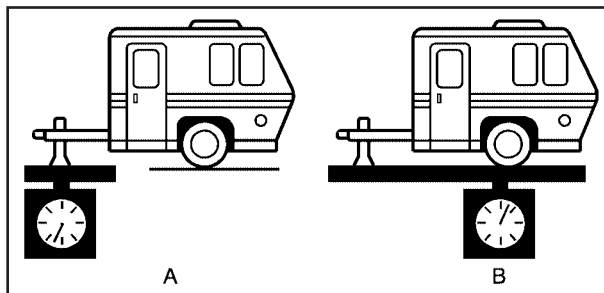

If you're using a weigh-carrying hitch or a weight-distributing hitch, the trailer tongue (A) should weigh 10 to 15 percent of the total loaded trailer weight (B).

After you've loaded your trailer, weigh the trailer and then the tongue, separately, to see if the weights are proper. If they aren't, you may be able to get them right simply by moving some items around in the trailer.

Total Weight on Your Vehicle's Tires

Be sure your vehicle's tires are inflated to the upper limit for cold tires. You'll find these numbers on the Tire-Loading Information label, See *Loading Your Vehicle* on page 4-29. Then be sure you don't go over the GVW limit for your vehicle, including the weight of the trailer tongue.

Hitches

It's important to have the correct hitch equipment. Crosswinds, large trucks going by and rough roads are a few reasons why you'll need the right hitch. Here are some rules to follow:

- The rear bumper on your vehicle is not intended for hitches. Do not attach rental hitches or other bumper-type hitches to it. Use only a frame-mounted hitch that does not attach to the bumper.
- Will you have to make any holes in the body of your vehicle when you install a trailer hitch? If you do, then be sure to seal the holes later when you remove the hitch. If you don't seal them, deadly carbon monoxide (CO) from your exhaust can get into your vehicle. See *Engine Exhaust* on page 2-28. Dirt and water can, too.

Safety Chains

You should always attach chains between your vehicle and your trailer. Cross the safety chains under the tongue of the trailer so that the tongue will not drop to the road if it becomes separated from the hitch. Instructions about safety chains may be provided by the hitch manufacturer or by the trailer manufacturer. Follow the manufacturer's recommendation for attaching safety chains and do not attach them to the bumper. Always leave just enough slack so you can turn with your rig. And, never allow safety chains to drag on the ground.

Trailer Brakes

Does your trailer have its own brakes? Be sure to read and follow the instructions for the trailer brakes so you'll be able to install, adjust and maintain them properly.

Your vehicle has anti-lock brakes. Do not try to tap into your vehicle's brake system. If you do, both brake systems won't work well, or at all.

Driving with a Trailer

Towing a trailer requires a certain amount of experience. Before setting out for the open road, you'll want to get to know your rig. Acquaint yourself with the feel of handling and braking with the added weight of the trailer. And always keep in mind that the vehicle you are driving is now a good deal longer and not nearly as responsive as your vehicle is by itself.

Before you start, check the trailer hitch and platform (and attachments), safety chains, electrical connector, lamps, tires and mirror adjustment. If the trailer has electric brakes, start your vehicle and trailer moving and then apply the trailer brake controller by hand to be sure the brakes are working. This lets you check your electrical connection at the same time.

During your trip, check occasionally to be sure that the load is secure, and that the lamps and any trailer brakes are still working.

Following Distance

Stay at least twice as far behind the vehicle ahead as you would when driving your vehicle without a trailer. This can help you avoid situations that require heavy braking and sudden turns.

Passing

You'll need more passing distance up ahead when you're towing a trailer. And, because you're a good deal longer, you'll need to go much farther beyond the passed vehicle before you can return to your lane.

Backing Up

Hold the bottom of the steering wheel with one hand. Then, to move the trailer to the left, just move that hand to the left. To move the trailer to the right, move your hand to the right. Always back up slowly and, if possible, have someone guide you.

Making Turns

Notice: Making very sharp turns while trailering could cause the trailer to come in contact with the vehicle. Your vehicle could be damaged. Avoid making very sharp turns while trailering.

When you're turning with a trailer, make wider turns than normal. Do this so your trailer won't strike soft shoulders, curbs, road signs, trees or other objects. Avoid jerky or sudden maneuvers. Signal well in advance.

Turn Signals When Towing a Trailer

When you tow a trailer, your vehicle may need additional wiring. Check with your dealer. The arrows on your instrument panel will flash whenever you signal a turn or lane change. Properly hooked up, the trailer lamps will also flash, telling other drivers you're about to turn, change lanes or stop.

When towing a trailer, the arrows on your instrument panel will flash for turns even if the bulbs on the trailer are burned out. Thus, you may think drivers behind you are seeing your signal when they are not. It's important to check occasionally to be sure the trailer bulbs are still working.

Driving On Grades

Reduce speed and shift to a lower gear *before* you start down a long or steep downgrade. If you don't shift down, you might have to use your brakes so much that they would get hot and no longer work well.

On a long uphill grade, shift down and reduce your speed to around 45 mph (70 km/h) to reduce the possibility of engine and transaxle overheating.

If you have overdrive, you may want to drive in THIRD (3), instead of AUTOMATIC OVERDRIVE (D).

Parking on Hills

CAUTION:

You really should not park your vehicle, with a trailer attached, on a hill. If something goes wrong, your rig could start to move. People can be injured, and both your vehicle and the trailer can be damaged.

But if you ever have to park your rig on a hill, here's how to do it:

1. Apply your regular brakes, but don't shift into PARK (P) yet.
2. Have someone place chocks under the trailer wheels.
3. When the wheel chocks are in place, release the regular brakes until the chocks absorb the load.
4. Reapply the regular brakes. Then apply your parking brake, and then shift to PARK (P).
5. Release the regular brakes.

When You Are Ready to Leave After Parking on a Hill

1. Apply your regular brakes and hold the pedal down while you:
 - start your engine,
 - shift into a gear, and
 - release the parking brake.
2. Let up on the brake pedal.
3. Drive slowly until the trailer is clear of the chocks.
4. Stop and have someone pick up and store the chocks.

Maintenance When Trailer Towing

Your vehicle will need service more often when you're pulling a trailer. See the Maintenance Schedule for more on this. Things that are especially important in trailer operation are automatic transaxle fluid (don't overfill), engine oil, drive belts, cooling system and brake system. Each of these is covered in this manual, and the Index will help you find them quickly. If you're trailering, it's a good idea to review this information before you start your trip.

Check periodically to see that all hitch nuts and bolts are tight.

Engine Cooling When Trailer Towing

Your cooling system may temporarily overheat during severe operating conditions. See *Engine Overheating on page 5-29*.

Section 5 Service and Appearance Care

Service	5-3	Cooling System	5-31
Accessories and Modifications	5-3	Power Steering Fluid	5-38
California Proposition 65 Warning	5-3	Windshield Washer Fluid	5-39
Doing Your Own Service Work	5-4	Brakes	5-40
Adding Equipment to the Outside of Your Vehicle	5-4	Battery	5-42
Jump Starting	5-43	Headlamp Aiming	5-47
Fuel	5-4	Bulb Replacement	5-47
Gasoline Octane	5-5	Halogen Bulbs	5-47
Gasoline Specifications	5-5	Headlamps, Front Turn Signal, Sidemarkers, and Parking Lamps	5-48
California Fuel	5-5	Taillamps, Stoplamps and Back-up Lamps	5-50
Additives	5-6	Back-Up Lamps	5-51
Fuel E85 (85% Ethanol)	5-6	Replacement Bulbs	5-51
Fuels in Foreign Countries	5-7	Windshield Wiper Blade Replacement	5-52
Filling the Tank	5-8	Tires	5-54
Filling a Portable Fuel Container	5-10	Tire Sidewall Labeling	5-55
Checking Things Under the Hood	5-10	Tire Terminology and Definitions	5-57
Hood Release	5-11	Inflation - Tire Pressure	5-60
Engine Compartment Overview	5-12	Tire Pressure Monitor System	5-62
Engine Oil	5-17	Tire Inspection and Rotation	5-66
Engine Oil Life System	5-20	When It Is Time for New Tires	5-67
Engine Air Cleaner/Filter	5-22	Buying New Tires	5-68
Automatic Transaxle Fluid	5-23	Different Size Tires and Wheels	5-69
Engine Coolant	5-26	Uniform Tire Quality Grading	5-70
Pressure Cap	5-28	Wheel Alignment and Tire Balance	5-71
Engine Overheating	5-29		
Overheated Engine Protection Operating Mode	5-31		

Section 5 Service and Appearance Care

Wheel Replacement	5-71	Aluminum Wheels	5-90
Tire Chains	5-73	Tires	5-91
If a Tire Goes Flat	5-74	Sheet Metal Damage	5-91
Changing a Flat Tire	5-74	Finish Damage	5-91
Removing the Spare Tire and Tools	5-76	Underbody Maintenance	5-91
Removing the Flat Tire and Installing the Spare Tire	5-77	Chemical Paint Spotting	5-92
Storing a Flat or Spare Tire and Tools	5-83	Vehicle Care/Appearance Materials	5-92
Compact Spare Tire	5-85	Vehicle Identification	5-93
Appearance Care	5-85	Vehicle Identification Number (VIN)	5-93
Cleaning the Inside of Your Vehicle	5-85	Service Parts Identification Label	5-93
Fabric/Carpet	5-87	Electrical System	5-94
Leather	5-87	Add-On Electrical Equipment	5-94
Instrument Panel, Vinyl, and Other Plastic Surfaces	5-88	Headlamp Wiring	5-94
Care of Safety Belts	5-88	Windshield Wiper Fuses	5-94
Weatherstrips	5-88	Power Windows and Other Power Options	5-94
Washing Your Vehicle	5-89	Fuses and Circuit Breakers	5-95
Cleaning Exterior Lamps/Lenses	5-89	Instrument Panel Fuse Block	5-95
Finish Care	5-89	Underhood Fuse Block	5-97
Windshield and Wiper Blades	5-90	Capacities and Specifications	5-100

Service

Your dealer knows your vehicle best and wants you to be happy with it. We hope you will go to your dealer for all your service needs. You will get genuine GM parts and GM-trained and supported service people.

We hope you will want to keep your GM vehicle all GM. Genuine GM parts have one of these marks:

ACDelco

GM Parts

**GM
Goodwrench**

GM Accessories

Accessories and Modifications

When you add non-GM accessories to your vehicle they can affect your vehicle's performance and safety, including such things as, braking, stability, ride and handling, emissions systems, aerodynamics, durability, and electronic systems like antilock brakes, traction control and stability control. Some of these accessories may even cause malfunction or damage not covered by warranty.

GM Accessories are designed to complement and function with other systems on your vehicle. Your GM dealer can accessorize your vehicle using genuine GM Accessories. When you go to your GM dealer and ask for GM Accessories, you will know that GM-trained and supported service technicians will perform the work using genuine GM Accessories.

California Proposition 65 Warning

Most motor vehicles, including this one, contain and/or emit chemicals known to the State of California to cause cancer and birth defects or other reproductive harm. Engine exhaust, many parts and systems (including some inside the vehicle), many fluids, and some component wear by-products contain and/or emit these chemicals.

Doing Your Own Service Work

CAUTION:

You can be injured and your vehicle could be damaged if you try to do service work on a vehicle without knowing enough about it.

- **Be sure you have sufficient knowledge, experience, the proper replacement parts, and tools before you attempt any vehicle maintenance task.**
- **Be sure to use the proper nuts, bolts, and other fasteners. English and metric fasteners can be easily confused. If you use the wrong fasteners, parts can later break or fall off. You could be hurt.**

If you want to do some of your own service work, you will want to use the proper service manual. It tells you much more about how to service your vehicle than this manual can. To order the proper service manual, see *Service Publications Ordering Information on page 7-15*.

Your vehicle has an airbag system. Before attempting to do your own service work, see *Servicing Your Airbag-Equipped Vehicle on page 1-65*.

You should keep a record with all parts receipts and list the mileage and the date of any service work you perform. See *Maintenance Record on page 6-14*.

Adding Equipment to the Outside of Your Vehicle

Things you might add to the outside of your vehicle can affect the airflow around it. This may cause wind noise and affect windshield washer performance. Check with your dealer before adding equipment to the outside of your vehicle.

Fuel

The 8th digit of your vehicle identification number (VIN) shows the code letter or number that identifies your engine. You will find the VIN at the top left of the instrument panel. See *Vehicle Identification Number (VIN) on page 5-93*.

If your vehicle has the 3.5L V6 engine (VIN Code K only), you may use either regular unleaded gasoline or ethanol fuel containing up to 85% ethanol (E85); also see *Fuel E85 (85% Ethanol) on page 5-6*. In all other engines, use only regular unleaded gasoline.

Gasoline Octane

If your vehicle has a V6 engine, use regular unleaded gasoline with a posted octane rating of 87 or higher. If the octane rating is less than 87, you may notice an audible knocking noise when you drive, commonly referred to as spark knock. If this occurs, use a gasoline rated at 87 octane or higher as soon as possible. If you are using gasoline rated at 87 octane or higher and you hear heavy knocking, your engine needs service.

If your vehicle has the 5.3L V8 engine (VIN Code C), use premium unleaded gasoline with a posted octane rating of 91 or higher. You may also use regular unleaded gasoline rated at 87 octane or higher, but your vehicle's acceleration may be slightly reduced, and you may notice a slight audible knocking noise, commonly referred to as spark knock. If the octane is less than 87, you may notice a heavy knocking noise when you drive. If this occurs, use a gasoline rated at 87 octane or higher as soon as possible. Otherwise, you might damage your engine. If you are using gasoline rated at 87 octane or higher and you hear heavy knocking, your engine needs service.

Gasoline Specifications

At a minimum, gasoline should meet ASTM specification D 4814 in the United States or CAN/CGSB-3.5 in Canada. Some gasolines may contain an octane-enhancing additive called methylcyclopentadienyl manganese tricarbonyl (MMT). General Motors recommends against the use of gasolines containing MMT. See *Additives on page 5-6* for additional information.

California Fuel

If your vehicle is certified to meet California Emissions Standards, it is designed to operate on fuels that meet California specifications. See the underhood emission control label. If this fuel is not available in states adopting California emissions standards, your vehicle will operate satisfactorily on fuels meeting federal specifications, but emission control system performance may be affected. The malfunction indicator lamp may turn on and your vehicle may fail a smog-check test. See *Malfunction Indicator Lamp on page 3-34*. If this occurs, return to your authorized GM dealer for diagnosis. If it is determined that the condition is caused by the type of fuel used, repairs may not be covered by your warranty.

Additives

To provide cleaner air, all gasolines in the United States are now required to contain additives that will help prevent engine and fuel system deposits from forming, allowing your emission control system to work properly. In most cases, you should not have to add anything to your fuel. However, some gasolines contain only the minimum amount of additive required to meet U.S. Environmental Protection Agency regulations. To help keep fuel injectors and intake valves clean, or if your vehicle experiences problems due to dirty injectors or valves, look for gasoline that is advertised as TOP TIER Detergent Gasoline. Also, your GM dealer has additives that will help correct and prevent most deposit-related problems.

Gasolines containing oxygenates, such as ethers and ethanol, and reformulated gasolines may be available in your area. General Motors recommends that you use these gasolines if they comply with the specifications described earlier. However, E85 (85% ethanol) and other fuels containing more than 10% ethanol must not be used in vehicles that were not designed for those fuels.

Notice: Your vehicle was not designed for fuel that contains methanol. Do not use fuel containing methanol. It can corrode metal parts in your fuel system and also damage the plastic and rubber parts. That damage would not be covered under your warranty.

Some gasolines that are not reformulated for low emissions may contain an octane-enhancing additive called methylcyclopentadienyl manganese tricarbonyl (MMT); ask the attendant where you buy gasoline whether the fuel contains MMT. General Motors recommends against the use of such gasolines. Fuels containing MMT can reduce the life of spark plugs and the performance of the emission control system may be affected. The malfunction indicator lamp may turn on. If this occurs, return to your authorized GM dealer for service.

Fuel E85 (85% Ethanol)

The 8th digit of your vehicle identification number (VIN) shows the code letter or number that identifies your engine. You will find the VIN at the top left of the instrument panel. See *Vehicle Identification Number (VIN) on page 5-93*.

If your vehicle has the 3.5L V6 engine (VIN Code K only), you may use either regular unleaded gasoline or ethanol fuel containing up to 85% ethanol (E85); also see *Fuel on page 5-4*. In all other engines, including the 3.5L V6 (VIN Code N), use only regular unleaded gasoline.

Only vehicles that have the 3.5L V6 engine (VIN Code K) may use 85% ethanol fuel (E85). General Motors encourages the use of E85 in vehicles that are designed to use it. The ethanol in E85 is a “renewable” fuel, meaning it is made from renewable sources such as corn and other crops.

Many service stations will not have an 85% ethanol fuel (E85) pump available. The U. S. Department of Energy has an alternative fuels website (<http://www.eere.energy.gov/afdc/infrastructure/locator.html>) that can help you find E85 fuel. Those stations that do have E85 should have a label indicating ethanol content. Do not use the fuel if the ethanol content is *greater* than 85%.

At a minimum, E85 should meet ASTM Specification D 5798.

To ensure quick starts in the wintertime, the E85 fuel must be formulated properly for your climate according to ASTM specification D 5798. If you have trouble starting on E85, it may be because your E85 fuel is not properly formulated for your climate. If this happens, switching to gasoline or adding gasoline to your fuel tank may improve starting. Your vehicle is designed to accommodate a mixture of gasoline and E85 fuel. For good starting and heater efficiency below 32°F (0°C), the fuel mix in the fuel tank should contain no more than 70% ethanol.

E85 has less energy per gallon than gasoline, so you will need to refill your fuel tank more often when using E85 than when you are using gasoline. Regular unleaded gasoline is recommended when pulling a trailer. For payload capacity with ethanol fuel, see *Loading Your Vehicle on page 4-29*.

Notice: Some additives are not compatible with E85 fuel and may harm your fuel system. Damage caused by additives would not be covered by your new vehicle warranty. Do not use additives with E85 fuel.

Notice: Your vehicle was not designed for fuel that contains methanol. Do not use fuel containing methanol. It can corrode metal parts in your fuel system and also damage the plastic and rubber parts. That damage would not be covered under your warranty.

Fuels in Foreign Countries

If you plan on driving in another country outside the United States or Canada, the proper fuel may be hard to find. Never use leaded gasoline or any other fuel not recommended in the previous text on fuel. Costly repairs caused by use of improper fuel would not be covered by your warranty.

To check the fuel availability, ask an auto club, or contact a major oil company that does business in the country where you will be driving.

Filling the Tank

CAUTION:

Fuel vapor burns violently and a fuel fire can cause bad injuries. To help avoid injuries to you and others, read and follow all the instructions on the pump island. Turn off your engine when you are refueling. Do not smoke if you are near fuel or refueling your vehicle. Keep sparks, flames, and smoking materials away from fuel. Do not leave the fuel pump unattended when refueling your vehicle — this is against the law in some places. Keep children away from the fuel pump; never let children pump fuel.

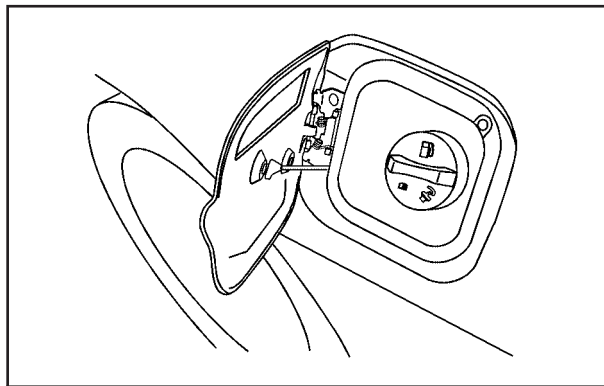

The tethered fuel cap is located behind a hinged fuel door on the driver's side of the vehicle.

To remove the fuel cap, turn it slowly counterclockwise. The fuel cap has a spring in it; if the cap is released too soon, it will spring back to the right.

While refueling, hang the tethered fuel cap on the hook on the inside of the fuel door.

 **CAUTION:**

If you spill fuel and then something ignites it, you could be badly burned. Fuel can spray out on you if you open the fuel cap too quickly. This spray can happen if your tank is nearly full, and is more likely in hot weather. Open the fuel cap slowly and wait for any hiss noise to stop. Then unscrew the cap all the way.

Be careful not to spill fuel. Do not top off or overfill the tank and wait a few seconds after you have finished pumping before removing the nozzle. Clean fuel from painted surfaces as soon as possible. See *Washing Your Vehicle* on page 5-89.

When replacing the fuel cap, turn it clockwise until it clicks. Make sure the cap is fully installed. The diagnostic system can determine if the fuel cap has been left off or improperly installed. This would allow fuel to evaporate into the atmosphere. See *Malfunction Indicator Lamp* on page 3-34.

The TIGHTEN GAS CAP message will be displayed on the Driver Information Center (DIC) if the fuel cap is not properly installed. See *DIC Warnings and Messages* on page 3-46 for more information.

 **CAUTION:**

If a fire starts while you are refueling, do not remove the nozzle. Shut off the flow of fuel by shutting off the pump or by notifying the station attendant. Leave the area immediately.

Notice: If you need a new fuel cap, be sure to get the right type. Your dealer can get one for you. If you get the wrong type, it may not fit properly. This may cause your malfunction indicator lamp to light and may damage your fuel tank and emissions system. See *Malfunction Indicator Lamp* on page 3-34.

Filling a Portable Fuel Container

CAUTION:

Never fill a portable fuel container while it is in your vehicle. Static electricity discharge from the container can ignite the gasoline vapor. You can be badly burned and your vehicle damaged if this occurs. To help avoid injury to you and others:

- Dispense gasoline only into approved containers.
- Do not fill a container while it is inside a vehicle, in a vehicle's trunk, pickup bed, or on any surface other than the ground.
- Bring the fill nozzle in contact with the inside of the fill opening before operating the nozzle. Contact should be maintained until the filling is complete.
- Do not smoke while pumping gasoline.

Checking Things Under the Hood

CAUTION:

An electric fan under the hood can start up and injure you even when the engine is not running. Keep hands, clothing and tools away from any underhood electric fan.

CAUTION:

Things that burn can get on hot engine parts and start a fire. These include liquids like fuel, oil, coolant, brake fluid, windshield washer and other fluids, and plastic or rubber. You or others could be burned. Be careful not to drop or spill things that will burn onto a hot engine.

Hood Release

To open the hood, do the following:

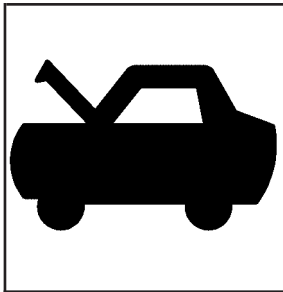

1. Pull the interior hood release handle with this symbol on it. It is located to the left of the parking brake pedal.

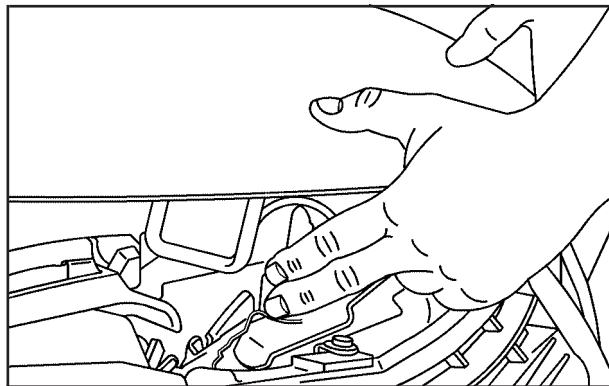

2. Then go to the front of the vehicle and release the secondary hood latch, located near the center of the hood front, by pushing the latch to the right.
3. Lift the hood.

Before closing the hood, be sure all the filler caps are on properly. Then pull the hood down and close it firmly.

Engine Compartment Overview

When you open the hood on the 3.5L V6 engine, here is what you will see:

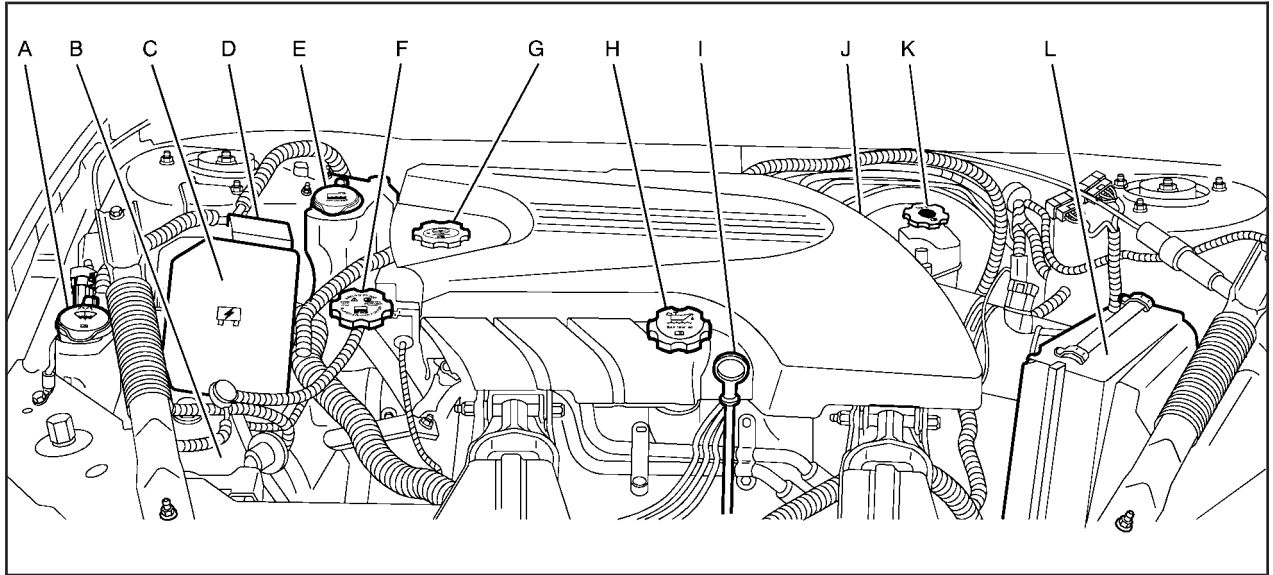

- A. Windshield Washer Fluid Reservoir. See “Adding Washer Fluid” under *Windshield Washer Fluid* on page 5-39.
- B. Battery. See *Battery* on page 5-42.
- C. Underhood Fuse Block. See *Underhood Fuse Block* on page 5-97.
- D. Remote Positive (+) Terminal. See *Jump Starting* on page 5-43.
- E. Coolant Recovery Tank. See “Checking Coolant” under *Cooling System* on page 5-31.
- F. Pressure Cap. See *Pressure Cap* on page 5-28.
- G. Power Steering Fluid Cap. See *Power Steering Fluid* on page 5-38.
- H. Engine Oil Fill Cap. See “When to Add Engine Oil” under *Engine Oil* on page 5-17.
- I. Engine Oil Dipstick. See “Checking Engine Oil” under *Engine Oil* on page 5-17.
- J. Automatic Transaxle Fluid Dipstick (Out of View). See “Checking the Fluid Level” under *Automatic Transaxle Fluid* on page 5-23.
- K. Brake Master Cylinder Reservoir. See “Brake Fluid” under *Brakes* on page 5-40.
- L. Engine Air Cleaner/Filter. See *Engine Air Cleaner/Filter* on page 5-22.

When you open the hood on the 3.9L V6 engine, here is what you will see:

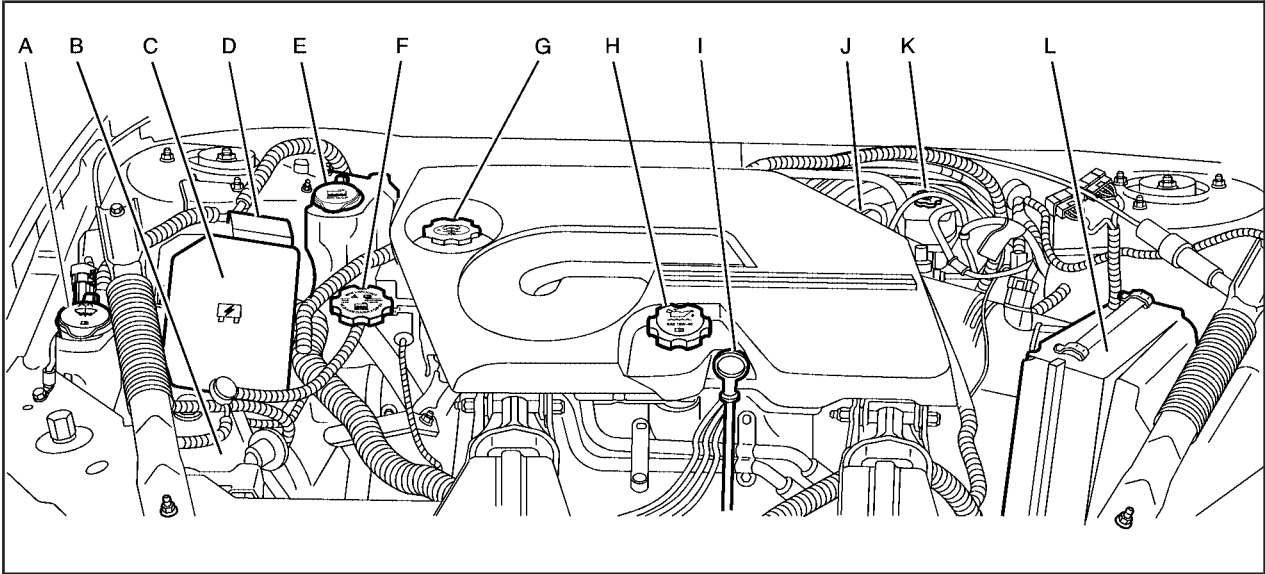

- A. Windshield Washer Fluid Reservoir. See “Adding Washer Fluid” under *Windshield Washer Fluid* on page 5-39.
- B. Battery. See *Battery* on page 5-42.
- C. Underhood Fuse Block. See *Underhood Fuse Block* on page 5-97.
- D. Remote Positive (+) Terminal. See *Jump Starting* on page 5-43.
- E. Coolant Recovery Tank. See “Checking Coolant” under *Cooling System* on page 5-31.
- F. Pressure Cap. See *Pressure Cap* on page 5-28.
- G. Power Steering Fluid Cap. See *Power Steering Fluid* on page 5-38.
- H. Engine Oil Fill Cap. See “When to Add Engine Oil” under *Engine Oil* on page 5-17.
- I. Engine Oil Dipstick. See “Checking Engine Oil” under *Engine Oil* on page 5-17.
- J. Automatic Transaxle Fluid Dipstick (Out of View). See “Checking the Fluid Level” under *Automatic Transaxle Fluid* on page 5-23.
- K. Brake Master Cylinder Reservoir. See “Brake Fluid” under *Brakes* on page 5-40.
- L. Engine Air Cleaner/Filter. See *Engine Air Cleaner/Filter* on page 5-22.

When you open the hood on the 5.3L V8 engine, here is what you will see:

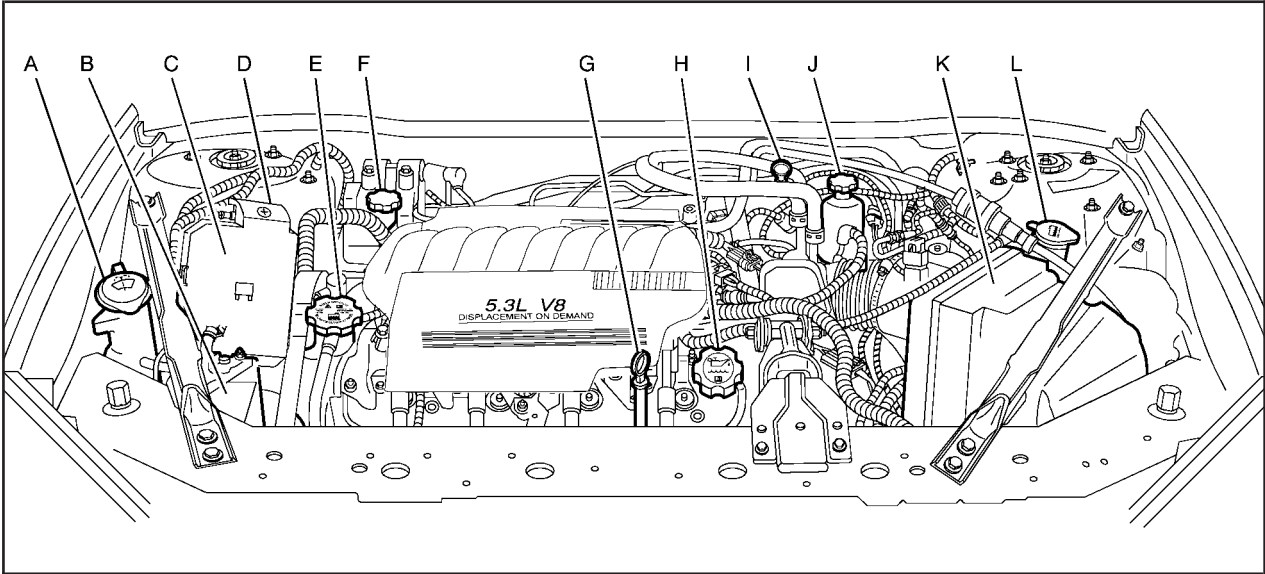

- A. Windshield Washer Fluid Reservoir. See “Adding Washer Fluid” under *Windshield Washer Fluid* on page 5-39.
- B. Battery. See *Battery* on page 5-42.
- C. Underhood Fuse Block. See *Underhood Fuse Block* on page 5-97.
- D. Remote Positive (+) Terminal. See *Jump Starting* on page 5-43.
- E. Pressure Cap. See *Pressure Cap* on page 5-28.
- F. Power Steering Fluid Reservoir. See *Power Steering Fluid* on page 5-38.
- G. Engine Oil Dipstick. See “Checking Engine Oil” under *Engine Oil* on page 5-17.
- H. Engine Oil Fill Cap. See “When to Add Engine Oil” under *Engine Oil* on page 5-17.
 - I. Automatic Transaxle Fluid Dipstick. See “Checking the Fluid Level” under *Automatic Transaxle Fluid* on page 5-23.
- J. Brake Master Cylinder Reservoir. See “Brake Fluid” under *Brakes* on page 5-40.
- K. Engine Air Cleaner/Filter. See *Engine Air Cleaner/Filter* on page 5-22.
- L. Coolant Recovery Tank. See “Checking Coolant” under *Cooling System* on page 5-31.

Engine Oil

Checking Engine Oil

It is a good idea to check your engine oil every time you get fuel. In order to get an accurate reading, the oil must be warm and the vehicle must be on level ground.

The engine oil dipstick handle is a yellow loop. See *Engine Compartment Overview* on page 5-12 for the location of the engine oil dipstick.

1. Turn off the engine and give the oil several minutes to drain back into the oil pan. If you do not do this, the oil dipstick might not show the actual level.
2. Pull out the dipstick and clean it with a paper towel or cloth, then push it back in all the way. Remove it again, keeping the tip down, and check the level.

When to Add Engine Oil

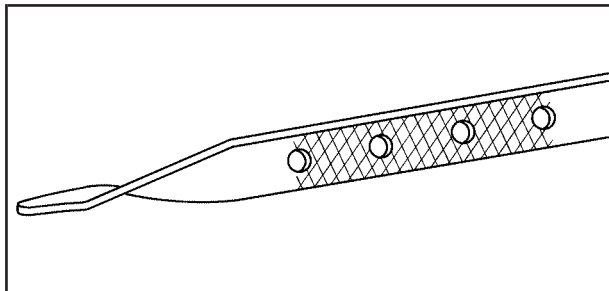

V6 Engine

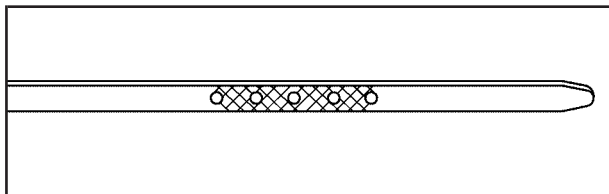

V8 Engine

If the oil is below the cross-hatched area at the tip of the dipstick, you will need to add at least one quart/liter of oil. But you must use the right kind. This section explains what kind of oil to use. For engine oil crankcase capacity, see *Capacities and Specifications* on page 5-100.

Notice: Do not add too much oil. If the engine has so much oil that the oil level gets above the cross-hatched area that shows the proper operating range, the engine could be damaged.

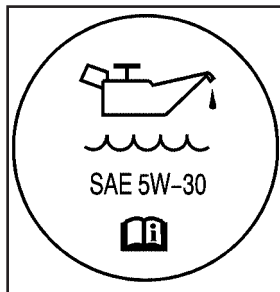

See *Engine Compartment Overview* on page 5-12 for the location of the engine oil fill cap.

Be sure to add enough oil to put the level somewhere in the proper operating range in the cross-hatched area. Push the dipstick all the way back in when you are through.

What Kind of Engine Oil to Use

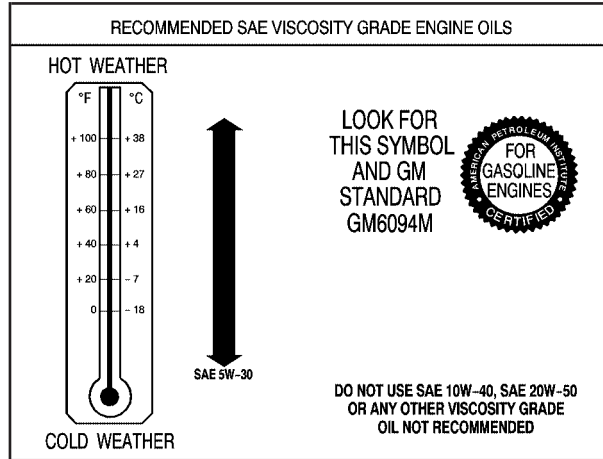

Look for two things:

- GM6094M
Your vehicle's engine requires oil meeting GM Standard GM6094M. You should look for and use only an oil that meets GM Standard GM6094M.
- SAE 5W-30
As shown in the viscosity chart, SAE 5W-30 is best for your vehicle.

These numbers on an oil container show its viscosity, or thickness. Do not use other viscosity oils such as SAE 20W-50.

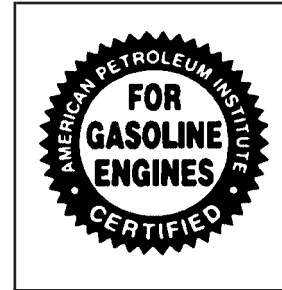

Oils meeting these requirements should also have the starburst symbol on the container. This symbol indicates that the oil has been certified by the American Petroleum Institute (API).

You should look for this information on the oil container, and use *only* those oils that are identified as meeting GM Standard GM6094M and have the starburst symbol on the front of the oil container.

Notice: Use only engine oil identified as meeting GM Standard GM6094M and showing the American Petroleum Institute Certified For Gasoline Engines starburst symbol. Failure to use the recommended oil can result in engine damage not covered by your warranty.

GM Goodwrench[®] oil meets all the requirements for your vehicle.

If you are in an area of extreme cold, where the temperature falls below -20°F (-29°C), it is recommended that you use either an SAE 5W-30 synthetic oil or an SAE 0W-30 oil. Both will provide easier cold starting and better protection for your engine at extremely low temperatures.

Engine Oil Additives

Do not add anything to your oil. The recommended oils with the starburst symbol that meet GM Standard GM6094M are all you will need for good performance and engine protection.

Engine Oil Life System

When to Change Engine Oil

Your vehicle has a computer system that lets you know when to change the engine oil and filter. This is based on engine revolutions and engine temperature, and not on mileage. Based on driving conditions, the mileage at which an oil change will be indicated can vary considerably. For the oil life system to work properly, you must reset the system every time the oil is changed.

When the system has calculated that oil life has been diminished, it will indicate that an oil change is necessary. A CHANGE ENGINE OIL SOON message in the Driver Information Center (DIC) will come on. See *DIC Warnings and Messages on page 3-46*. Change your oil as soon as possible within the next 600 miles (1 000 km). It is possible that, if you are driving under the best conditions, the oil life system may not indicate that an oil change is necessary for over a year. However, your engine oil and filter must be changed at least once a year and at this time the system must be reset. Your dealer has GM-trained service people who will perform this work using genuine GM parts and reset the system. It is also important to check your oil regularly and keep it at the proper level.

If the system is ever reset accidentally, you must change your oil at 3,000 miles (5 000 km) since your last oil change. Remember to reset the oil life system whenever the oil is changed.

How to Reset the Engine Oil Life System

The Engine Oil Life System calculates when to change your engine oil and filter based on vehicle use. Anytime your oil is changed, reset the system so it can calculate when the next oil change is required. If a situation occurs where you change your oil prior to a CHANGE ENGINE OIL SOON message being turned on, reset the system.

After changing the engine oil, the system must be reset. To reset the CHANGE ENGINE OIL SOON message, do the following procedures:

1. Turn the ignition to RUN, with the engine off.
2. Fully press and release the accelerator pedal slowly three times within five seconds. If the CHANGE ENGINE OIL SOON message flashes, the system is reset. However, if it stays on, it did not reset. Repeat the procedure.
3. Turn the key to OFF.

If the CHANGE ENGINE OIL SOON message comes back on when you start your vehicle, the engine oil life system has not reset. Repeat the procedure.

What to Do with Used Oil

Used engine oil contains certain elements that may be unhealthy for your skin and could even cause cancer. Do not let used oil stay on your skin for very long. Clean your skin and nails with soap and water, or a good hand cleaner. Wash or properly dispose of clothing or rags containing used engine oil. See the manufacturer's warnings about the use and disposal of oil products.

Used oil can be a threat to the environment. If you change your own oil, be sure to drain all the oil from the filter before disposal. Never dispose of oil by putting it in the trash, pouring it on the ground, into sewers, or into streams or bodies of water. Instead, recycle it by taking it to a place that collects used oil. If you have a problem properly disposing of your used oil, ask your dealer, a service station, or a local recycling center for help.

Engine Air Cleaner/Filter

The engine air cleaner/filter is located in the engine compartment on the driver's side of the vehicle. See *Engine Compartment Overview on page 5-12* for more information on location.

When to Inspect the Engine Air Cleaner/Filter

Inspect the air cleaner/filter at the Maintenance II intervals and replace it at the first oil change after each 50,000 mile (83 000 km) interval. See *Scheduled Maintenance on page 6-4* for more information. If you are driving in dusty/dirty conditions, inspect the filter at each engine oil change.

How to Inspect the Engine Air Cleaner/Filter

To inspect the air cleaner/filter, remove the filter from the vehicle and lightly shake the filter to release loose dust and dirt. If the filter remains caked with dirt, a new filter is required.

To inspect or replace the engine air cleaner/filter do the following:

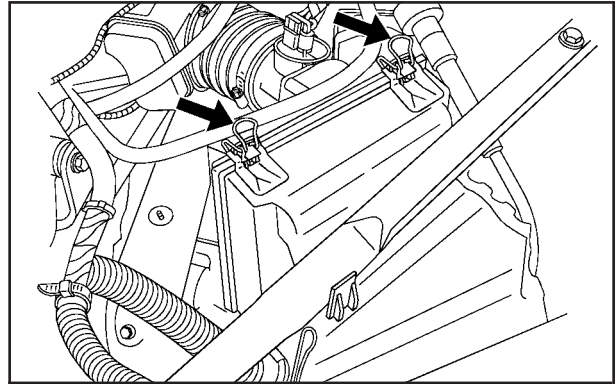

1. Lift the filter cover tabs on top of the engine air cleaner/filter housing.
2. Push the filter cover housing toward the engine.
3. Pull out the filter.
4. Inspect or replace the engine air cleaner/filter.
5. To reinstall the cover, position the tabs through the hinges on the housing.
6. Push the cover tabs on top of the housing to lock the cover in place.

 **CAUTION:**

Operating the engine with the air cleaner/filter off can cause you or others to be burned. The air cleaner not only cleans the air; it helps to stop flames if the engine backfires. If it is not there and the engine backfires, you could be burned. Do not drive with it off, and be careful working on the engine with the air cleaner/filter off.

Notice: If the air cleaner/filter is off, a backfire can cause a damaging engine fire. And, dirt can easily get into your engine, which will damage it. Always have the air cleaner/filter in place when you are driving.

Automatic Transaxle Fluid

When to Check and Change Automatic Transaxle Fluid

A good time to check your automatic transaxle fluid level is when the engine oil is changed.

Change the fluid and filter at the intervals listed in *Additional Required Services* on page 6-6, and be sure to use the transaxle fluid listed in *Recommended Fluids and Lubricants* on page 6-12.

How to Check Automatic Transaxle Fluid

Because this operation can be a little difficult, you may choose to have this done at the dealership service department.

If you do it yourself, be sure to follow all the instructions here, or you could get a false reading on the dipstick.

Notice: Too much or too little fluid can damage the transaxle. Too much can mean that some of the fluid could come out and fall on hot engine or exhaust system parts, starting a fire. Too little fluid could cause the transaxle to overheat. Be sure to get an accurate reading if you check the transaxle fluid.

Wait at least 30 minutes before checking the transaxle fluid level if you have been driving:

- When outside temperatures are above 90°F (32°C).
- At high speed for quite a while.
- In heavy traffic — especially in hot weather.
- While pulling a trailer.

To get the right reading, the fluid should be at normal operating temperature, which is 180°F to 200°F (82°C to 93°C).

Get the vehicle warmed up by driving about 15 miles (24 km) when outside temperatures are above 50°F (10°C). If it is colder than 50°F (10°C), you may have to drive longer.

Checking the Fluid Level

Prepare your vehicle as follows:

1. Park your vehicle on a level place. Keep the engine running.
2. With the parking brake applied, place the shift lever in PARK (P).

3. With your foot on the brake pedal, move the shift lever through each gear range, pausing for about three seconds in each range. Then, position the shift lever in PARK (P).
4. Let the engine run at idle for three to five minutes.

Then, without shutting off the engine, follow these steps:

1. Pull out the dipstick and wipe it with a clean rag or paper towel.

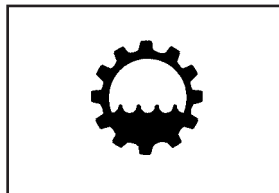

The transaxle fluid dipstick handle is the black loop with this symbol on it. It is located near the rear of the engine compartment.

See *Engine Compartment Overview* on page 5-12 for more information on location.

2. Push it back in all the way, wait three seconds and then pull it back out again.

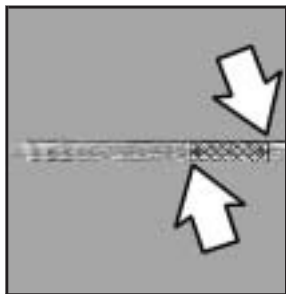

V6 Engines

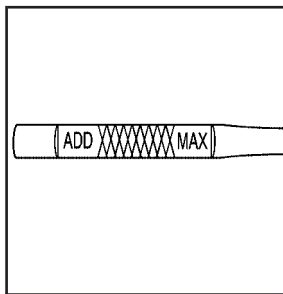

5.3L V8 Engine

3. Check both sides of the dipstick, and read the lower level. The fluid level must be in the cross-hatched area.
4. If the fluid level is in the acceptable range, push the dipstick back in all the way.

How to Add Fluid

Refer to the Maintenance Schedule to determine what kind of transaxle fluid to use. See *Recommended Fluids and Lubricants on page 6-12*.

If the fluid level is low, add only enough of the proper fluid to bring the level into the cross-hatched area on the dipstick.

1. Pull out the dipstick.
2. Using a long-neck funnel, add enough fluid at the dipstick hole to bring it to the proper level.
It does not take much fluid, generally less than one pint (0.5 L). Do not overfill.

Notice: Use of the incorrect automatic transaxle fluid may damage your vehicle, and the damages may not be covered by your warranty. Always use the automatic transaxle fluid listed in *Recommended Fluids and Lubricants on page 6-12*.

3. After adding fluid, recheck the fluid level as described under "How to Check Automatic Transaxle Fluid," earlier in this section.
4. When the correct fluid level is obtained, push the dipstick back in all the way.

Engine Coolant

The cooling system in your vehicle is filled with DEX-COOL[®] engine coolant. This coolant is designed to remain in your vehicle for five years or 150,000 miles (240 000 km), whichever occurs first, if you add only DEX-COOL[®] extended life coolant.

The following explains your cooling system and how to add coolant when it is low. If you have a problem with engine overheating or if you need to add coolant to the radiator, see *Engine Overheating on page 5-29*.

A 50/50 mixture of clean, drinkable water and DEX-COOL[®] coolant will:

- Give freezing protection down to -34°F (-37°C).
- Give boiling protection up to 265°F (129°C).
- Protect against rust and corrosion.
- Help keep the proper engine temperature.
- Let the warning lights and gages work as they should.

Notice: Using coolant other than DEX-COOL[®] may cause premature engine, heater core, or radiator corrosion. In addition, the engine coolant may require changing sooner, at the first maintenance service after each 30,000 miles (50 000 km) or 24 months, whichever occurs first. Any repairs would not be covered by your warranty. Always use DEX-COOL[®] (silicate-free) coolant in your vehicle.

What to Use

Use a mixture of one-half clean, drinkable water and one-half DEX-COOL[®] coolant which will not damage aluminum parts. If you use this coolant mixture, you do not need to add anything else.

CAUTION:

Adding only plain water to your cooling system can be dangerous. Plain water, or some other liquid such as alcohol, can boil before the proper coolant mixture will. Your vehicle's coolant warning system is set for the proper coolant mixture. With plain water or the wrong mixture, your engine could get too hot but you would not get the overheat warning. Your engine could catch fire and you or others could be burned. Use a 50/50 mixture of clean, drinkable water and DEX-COOL® coolant.

Notice: If you use an improper coolant mixture, your engine could overheat and be badly damaged. The repair cost would not be covered by your warranty. Too much water in the mixture can freeze and crack the engine, radiator, heater core and other parts.

If coolant needs to be added more than four times a year, have your dealer check the cooling system.

Notice: If you use extra inhibitors and/or additives in your vehicle's cooling system, you could damage your vehicle. Use only the proper mixture of the engine coolant listed in this manual for the cooling system. See *Recommended Fluids and Lubricants on page 6-12* for more information.

Checking Coolant

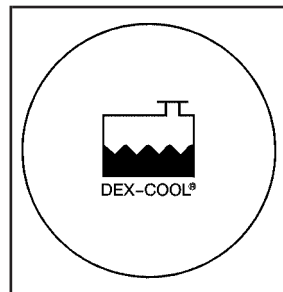

The coolant recovery tank cap has this symbol on it.

See *Engine Compartment Overview on page 5-12* for more information on the location of the coolant recovery tank.

The vehicle must be on a level surface when checking the coolant level.

When the engine is cold, the coolant level should be at the cold fill line or a little higher. The cold fill line is marked with the same symbol as the coolant recovery tank cap.

Adding Coolant

If more coolant is needed, add the proper DEX-COOL® coolant mixture at the coolant recovery tank, but be careful not to spill it.

If the coolant recovery tank is completely empty, add coolant to the radiator. See *Engine Overheating on page 5-29*.

CAUTION:

Turning the radiator pressure cap when the engine and radiator are hot can allow steam and scalding liquids to blow out and burn you badly. With the coolant recovery tank, you will almost never have to add coolant at the radiator. Never turn the radiator pressure cap — even a little — when the engine and radiator are hot.

CAUTION:

You can be burned if you spill coolant on hot engine parts. Coolant contains ethylene glycol, and it will burn if the engine parts are hot enough. Do not spill coolant on a hot engine.

Occasionally check the coolant level in the radiator. For information on how to add coolant to the radiator, see *Cooling System on page 5-31*.

Pressure Cap

Notice: If the pressure cap is not tightly installed, coolant loss and possible engine damage may occur. Be sure the cap is properly and tightly secured.

See *Engine Compartment Overview on page 5-12* for more information on location.

Engine Overheating

There is a coolant temperature gage and a warning light on the instrument panel that indicate an overheated engine condition. See *Engine Coolant Temperature Gage on page 3-33* and *Engine Coolant Temperature Warning Light on page 3-33*.

In addition, you will find an ENGINE OVERHEATED IDLE ENGINE and an ENGINE OVERHEATED STOP ENGINE message displayed on the vehicle's Driver Information Center (DIC). See *DIC Warnings and Messages on page 3-46* for more information.

If Steam Is Coming From Your Engine

CAUTION:

Steam from an overheated engine can burn you badly, even if you just open the hood. Stay away from the engine if you see or hear steam coming from it. Just turn it off and get everyone away from the vehicle until it cools down. Wait until there is no sign of steam or coolant before you open the hood.

CAUTION: (Continued)

CAUTION: (Continued)

If you keep driving when your engine is overheated, the liquids in it can catch fire. You or others could be badly burned. Stop your engine if it overheats, and get out of the vehicle until the engine is cool.

See *Overheated Engine Protection Operating Mode on page 5-31* for information on driving to a safe place in an emergency.

Notice: If your engine catches fire because you keep driving with no coolant, your vehicle can be badly damaged. The costly repairs would not be covered by your warranty. See *Overheated Engine Protection Operating Mode on page 5-31* for information on driving to a safe place in an emergency.

If No Steam Is Coming From Your Engine

An overheat warning can indicate a serious problem.

If you get an engine overheat warning but see or hear no steam, the problem may not be too serious. Sometimes the engine can get a little too hot when you:

- Climb a long hill on a hot day.
- Stop after high-speed driving.
- Idle for long periods in traffic.
- Tow a trailer.

If an overheat warning occurs without any sign of steam, try this for a minute or so:

1. In heavy traffic, let the engine idle in NEUTRAL (N) while stopped. If it is safe to do so, pull off the road, shift to PARK (P) or NEUTRAL (N) and let the engine idle.
2. Set the heater at the highest setting and the fan at the highest speed and open the windows as necessary.

If the overheat warning no longer exists, the vehicle can be driven. Just to be safe, drive slower for about 10 minutes. If the warning does not come back on, the vehicle can be driven normally.

If the warning continues, and you have not stopped, pull over, stop, and park the vehicle right away.

If there is still no sign of steam, idle the engine for three minutes while parked. If the warning is still there, turn off the engine and get everyone out of the vehicle until it cools down. Also, see “Overheated Engine Protection Operating Mode” later in this section.

You may decide not to lift the hood but to get service help right away.

Overheated Engine Protection Operating Mode

This emergency operating mode allows your vehicle to be driven to a safe place in an emergency situation. If an overheated engine condition exists, an overheat protection mode which alternates firing groups of cylinders helps prevent engine damage. In this mode, you will notice a significant loss in power and engine performance. The coolant temperature gage will indicate an overheat condition exists. Driving extended miles (km) and/or towing a trailer in the overheat protection mode should be avoided.

Notice: After driving in the overheated engine protection operating mode, to avoid engine damage, allow the engine to cool before attempting any repair. The engine oil will be severely degraded. Repair the cause of coolant loss, change the oil and reset the oil life system. See *Engine Oil* on page 5-17.

Cooling System

When you decide it is safe to lift the hood, here is what you will see:

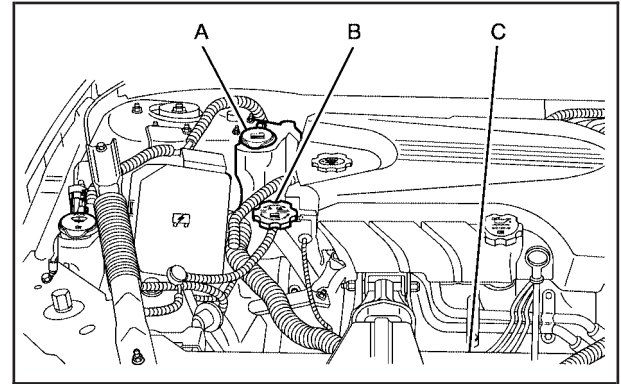

3.5L V6 Engine shown, 3.9L V6 Engine similar

- A. Coolant Recovery Tank
- B. Pressure Cap
- C. Electric Engine Cooling Fans

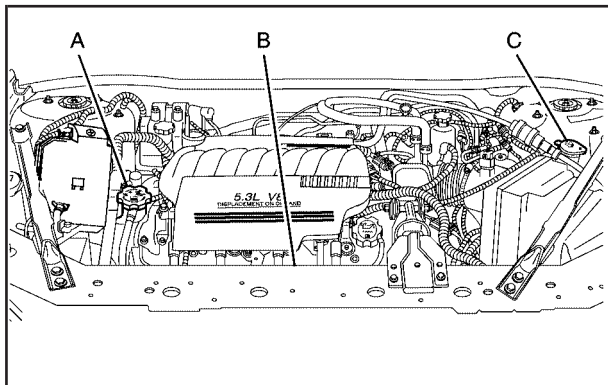

5.3L V8 Engine

- A. Pressure Cap
- B. Electric Engine Cooling Fans
- C. Coolant Recovery Tank

CAUTION:

An electric engine cooling fan under the hood can start up even when the engine is not running and can injure you. Keep hands, clothing and tools away from any underhood electric fan.

If the coolant inside the coolant recovery tank is boiling, do not do anything else until it cools down. The vehicle should be parked on a level surface.

If your vehicle has one of the V6 engines, the coolant recovery tank is located in the rear of the engine compartment on the passenger's side of the vehicle. If your vehicle has the 5.3L V8 engine, the coolant recovery tank is located in the rear of the engine compartment on the driver's side of the vehicle. See *Engine Compartment Overview* on page 5-12.

When the engine is cold, the coolant level should be at or above the cold fill line on the coolant recovery tank. To check the coolant level, look for the cold fill line on the side of the coolant recovery tank that faces the engine. If the level is not correct, there may be a leak at the pressure cap or in the radiator hoses, heater hoses, radiator, water pump, or somewhere else in the cooling system.

 **CAUTION:**

Heater and radiator hoses, and other engine parts, can be very hot. Do not touch them. If you do, you can be burned.

Do not run the engine if there is a leak. If you run the engine, it could lose all coolant. That could cause an engine fire, and you could be burned. Get any leak fixed before you drive the vehicle.

If there seems to be no leak, with the engine on, check to see if the electric engine cooling fans are running. If the engine is overheating, the fans should be running. If the fans are not running, your vehicle needs service.

Notice: Engine damage from running your engine without coolant is not covered by your warranty. See *Overheated Engine Protection Operating Mode on page 5-31* for information on driving to a safe place in an emergency.

Notice: Using coolant other than DEX-COOL® may cause premature engine, heater core or radiator corrosion. In addition, the engine coolant may require changing sooner, at 30,000 miles (50 000 km) or 24 months, whichever occurs first. Any repairs would not be covered by your warranty. Always use DEX-COOL® (silicate-free) coolant in your vehicle.

How to Add Coolant to the Coolant Recovery Tank

CAUTION:

Adding only plain water to your cooling system can be dangerous. Plain water, or some other liquid such as alcohol, can boil before the proper coolant mixture will. Your vehicle's coolant warning system is set for the proper coolant mixture. With plain water or the wrong mixture, your engine could get too hot but you would not get the overheat warning. Your engine could catch fire and you or others could be burned. Use a 50/50 mixture of clean, drinkable water and DEX-COOL[®] coolant.

If you have not found a problem yet, but the coolant level is not at the cold fill line, add a 50/50 mixture of clean, drinkable water and DEX-COOL[®] engine coolant at the coolant recovery tank. See *Engine Coolant* on page 5-26 for more information.

Notice: In cold weather, water can freeze and crack the engine, radiator, heater core and other parts. Use the recommended coolant and the proper coolant mixture.

CAUTION:

You can be burned if you spill coolant on hot engine parts. Coolant contains ethylene glycol and it will burn if the engine parts are hot enough. Do not spill coolant on a hot engine.

When the coolant level in the coolant recovery tank is at the cold fill line, start the vehicle.

If the overheat warning continues, there is one more thing you can try. You can add the proper coolant mixture directly to the radiator, but be sure the system is cool before you do it.

CAUTION:

Steam and scalding liquids from a hot cooling system can blow out and burn you badly. They are under pressure, and if you turn the radiator pressure cap — even a little — they can come out at high speed. Never turn the cap when the cooling system, including the radiator pressure cap, is hot. Wait for the cooling system and radiator pressure cap to cool if you ever have to turn the pressure cap.

How to Add Coolant to the Cooling System (V6 Engines)

Notice: Your engine has a specific radiator fill procedure. Failure to follow this procedure could cause your engine to overheat and be severely damaged.

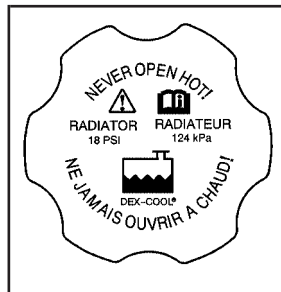

If you hear a hiss, wait for that to stop. A hiss means there is still some pressure left.

2. Then keep turning the pressure cap and remove it.

CAUTION:

You can be burned if you spill coolant on hot engine parts. Coolant contains ethylene glycol and it will burn if the engine parts are hot enough. Do not spill coolant on a hot engine.

3. Fill the radiator with the proper DEX-COOL[®] coolant mixture, up to the base of the filler neck. See *Engine Coolant* on page 5-26 for more information about the proper coolant mixture.

4. Rinse or wipe any spilled coolant from the engine and the compartment.

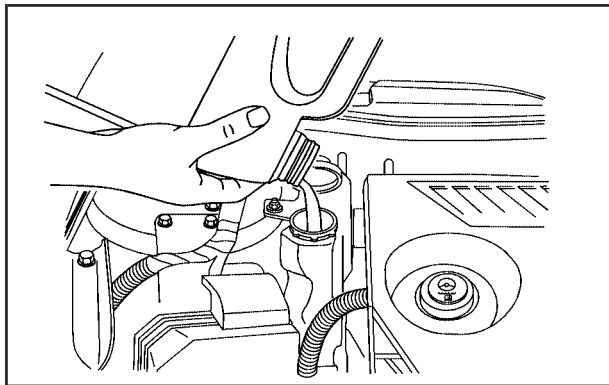

3.9L V6 Engine shown, 3.5L V6 Engine similar

5. Then fill the coolant recovery tank to the cold fill line.
6. Put the cap back on the coolant recovery tank, but leave the pressure cap off.

7. Start the engine and let it run until you can feel the upper radiator hose getting hot. Watch out for the engine cooling fans.
8. By this time, the coolant level inside the radiator filler neck may be lower. If the level is lower, add more of the proper DEX-COOL[®] coolant mixture through the filler neck until the level reaches the base of the filler neck.
9. Then replace the pressure cap. At any time during this procedure if coolant begins to flow out of the filler neck, reinstall the pressure cap. Be sure the cap is hand-tight and fully seated.
10. Check the coolant in the recovery tank. The level in the coolant recovery tank should be at the cold fill line when the engine is cold.

How to Add Coolant to the Cooling System (5.3L V8 Engine)

Notice: Your engine has a specific cooling system drain and fill procedure. Failure to follow this procedure could cause your engine to overheat and be severely damaged. If your engine's cooling system needs to be drained and re-filled, please see your dealer.

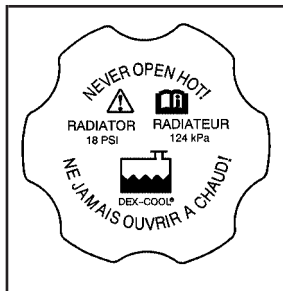

- If you hear a hiss, wait for that to stop. A hiss means that there is still some pressure left.
2. Then keep turning the pressure cap and remove it.

1. You can remove the pressure cap when the cooling system, including the pressure cap and upper radiator hose is no longer hot. Turn the pressure cap slowly counterclockwise.

CAUTION:

You can be burned if you spill coolant on hot engine parts. Coolant contains ethylene glycol and it will burn if the engine parts are hot enough. Do not spill coolant on a hot engine.

3. Fill the cooling system with the proper DEX-COOL® coolant mixture, up to the base of the filler neck. See *Engine Coolant* on page 5-26 for more information about the proper coolant mixture.
4. Rinse or wipe any spilled coolant from the engine and the compartment.
5. Then fill the coolant recovery tank to the cold fill line.
6. Install the coolant recovery tank cap and the pressure cap.
7. If the coolant in the recovery tank is constantly low, you should have a dealership service department inspect the vehicle for leaks.

Power Steering Fluid

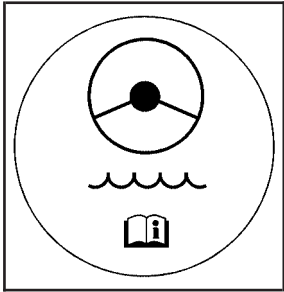

The power steering fluid reservoir is located toward the rear of the engine compartment on the passenger's side of the vehicle. See *Engine Compartment Overview* on page 5-12 for reservoir location.

When to Check Power Steering Fluid

It is not necessary to regularly check power steering fluid unless you suspect there is a leak in the system or you hear an unusual noise. A fluid loss in this system could indicate a problem. Have the system inspected and repaired.

How to Check Power Steering Fluid

To check the power steering fluid, do the following:

1. Turn the key off and let the engine compartment cool down.
2. Wipe the cap and the top of the reservoir clean.
3. Unscrew the cap and wipe the dipstick with a clean rag.
4. Replace the cap and completely tighten it.
5. Remove the cap again and look at the fluid level on the dipstick.

The fluid level should be somewhere within the cross-hatched area on the dipstick. If the fluid is at the ADD mark, you should add fluid.

What to Use

To determine what kind of fluid to use, see *Recommended Fluids and Lubricants* on page 6-12. Always use the proper fluid. Failure to use the proper fluid can cause leaks and damage hoses and seals.

Windshield Washer Fluid

What to Use

When you need windshield washer fluid, be sure to read the manufacturer's instructions before use. If you will be operating your vehicle in an area where the temperature may fall below freezing, use a fluid that has sufficient protection against freezing.

Adding Washer Fluid

A WASHER FLUID LOW ADD FLUID message will be displayed on the Driver Information Center (DIC) when you need to add windshield washer fluid to your vehicle. See *DIC Warnings and Messages on page 3-46* for more information.

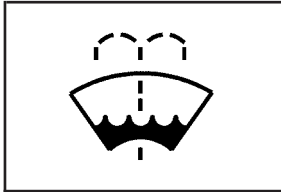

Open the cap with the washer symbol on it. Add washer fluid until the tank is full. See *Engine Compartment Overview on page 5-12* for more information on location.

Notice:

- **When using concentrated washer fluid, follow the manufacturer's instructions for adding water.**
- **Do not mix water with ready-to-use washer fluid. Water can cause the solution to freeze and damage your washer fluid tank and other parts of the washer system. Also, water does not clean as well as washer fluid.**
- **Fill your washer fluid tank only three-quarters full when it is very cold. This allows for expansion if freezing occurs, which could damage the tank if it is completely full.**
- **Do not use engine coolant (antifreeze) in your windshield washer. It can damage your washer system and paint.**

Brakes

Brake Fluid

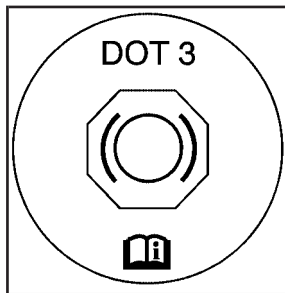

Your brake master cylinder reservoir is filled with DOT-3 brake fluid. See *Engine Compartment Overview* on page 5-12 for the location of the reservoir.

There are only two reasons why the brake fluid level in the reservoir might go down. The first is that the brake fluid goes down to an acceptable level during normal brake lining wear. When new linings are put in, the fluid level goes back up. The other reason is that fluid is leaking out of the brake system. If it is, you should have your brake system fixed, since a leak means that sooner or later your brakes will not work well, or will not work at all.

So, it is not a good idea to top off your brake fluid. Adding brake fluid will not correct a leak. If you add fluid when your linings are worn, then you will have too much fluid when you get new brake linings. You should add or remove brake fluid, as necessary, only when work is done on the brake hydraulic system.

CAUTION:

If you have too much brake fluid, it can spill on the engine. The fluid will burn if the engine is hot enough. You or others could be burned, and your vehicle could be damaged. Add brake fluid only when work is done on the brake hydraulic system.

When your brake fluid falls to a low level, your brake warning light will come on. See *Brake System Warning Light* on page 3-31.

What to Add

When you do need brake fluid, use only DOT-3 brake fluid. Use new brake fluid from a sealed container only. See *Recommended Fluids and Lubricants* on page 6-12.

Always clean the brake fluid reservoir cap and the area around the cap before removing it. This will help keep dirt from entering the reservoir.

 **CAUTION:**

With the wrong kind of fluid in your brake system, your brakes may not work well, or they may not even work at all. This could cause a crash. Always use the proper brake fluid.

Notice:

- **Using the wrong fluid can badly damage brake system parts. For example, just a few drops of mineral-based oil, such as engine oil, in your brake system can damage brake system parts so badly that they will have to be replaced. Do not let someone put in the wrong kind of fluid.**
- **If you spill brake fluid on your vehicle's painted surfaces, the paint finish can be damaged. Be careful not to spill brake fluid on your vehicle. If you do, wash it off immediately. See *Washing Your Vehicle* on page 5-89.**

Brake Wear

Your vehicle has four-wheel disc brakes.

Disc brake pads have built-in wear indicators that make a high-pitched warning sound when the brake pads are worn and new pads are needed. The sound may come and go or be heard all the time your vehicle is moving, except when you are pushing on the brake pedal firmly.

 **CAUTION:**

The brake wear warning sound means that soon your brakes will not work well. That could lead to an accident. When you hear the brake wear warning sound, have your vehicle serviced.

Notice: Continuing to drive with worn-out brake pads could result in costly brake repair.

Some driving conditions or climates may cause a brake squeal when the brakes are first applied or lightly applied. This does not mean something is wrong with your brakes.

Properly torqued wheel nuts are necessary to help prevent brake pulsation. When tires are rotated, inspect brake pads for wear and evenly tighten wheel nuts in the proper sequence to GM torque specifications.

Brake linings should always be replaced as complete axle sets.

Brake Pedal Travel

See your dealer if the brake pedal does not return to normal height, or if there is a rapid increase in pedal travel. This could be a sign of brake trouble.

Brake Adjustment

Every time you apply the brakes, with or without the vehicle moving, your brakes adjust for wear.

Replacing Brake System Parts

The braking system on a vehicle is complex. Its many parts have to be of top quality and work well together if the vehicle is to have really good braking. Your vehicle was designed and tested with top-quality GM brake parts. When you replace parts of your braking system — for example, when your brake linings wear down and you need new ones put in — be sure you get new approved GM replacement parts. If you do not, your brakes may no longer work properly.

For example, if someone puts in brake linings that are wrong for your vehicle, the balance between your front and rear brakes can change — for the worse. The braking performance you have come to expect can change in many other ways if someone puts in the wrong replacement brake parts.

Battery

Your vehicle has a maintenance free battery. When it is time for a new battery, get one that has the replacement number shown on the original battery's label. We recommend an ACDelco® replacement battery. See *Engine Compartment Overview on page 5-12* for battery location.

Warning: Battery posts, terminals, and related accessories contain lead and lead compounds, chemicals known to the State of California to cause cancer and reproductive harm. Wash hands after handling.

Vehicle Storage

If you are not going to drive your vehicle for 25 days or more, remove the black, negative (-) cable from the battery. This will help keep your battery from running down.

CAUTION:

Batteries have acid that can burn you and gas that can explode. You can be badly hurt if you are not careful. See *Jump Starting* on page 5-43 for tips on working around a battery without getting hurt.

Jump Starting

If your vehicle's battery has run down, you may want to use another vehicle and some jumper cables to start your vehicle. Be sure to use the following steps to do it safely.

CAUTION:

Batteries can hurt you. They can be dangerous because:

- They contain acid that can burn you.
- They contain gas that can explode or ignite.
- They contain enough electricity to burn you.

If you do not follow these steps exactly, some or all of these things can hurt you.

Notice: Ignoring these steps could result in costly damage to your vehicle that would not be covered by your warranty.

Trying to start your vehicle by pushing or pulling it will not work, and it could damage your vehicle.

1. Check the other vehicle. It must have a 12-volt battery with a negative ground system.

Notice: If the other vehicle's system is not a 12-volt system with a negative ground, both vehicles can be damaged. Only use vehicles with 12-volt systems with negative grounds to jump start your vehicle.

2. Get the vehicles close enough so the jumper cables can reach, but be sure the vehicles are not touching each other. If they are, it could cause a ground connection you do not want. You would not be able to start your vehicle, and the bad grounding could damage the electrical systems.

To avoid the possibility of the vehicles rolling, set the parking brake firmly on both vehicles involved in the jump start procedure. Put an automatic transaxle in PARK (P) or a manual transaxle in NEUTRAL before setting the parking brake.

Notice: If you leave your radio or other accessories on during the jump starting procedure, they could be damaged. The repairs would not be covered by your warranty. Always turn off your radio and other accessories when jump starting your vehicle.

3. Turn off the ignition on both vehicles. Unplug unnecessary accessories plugged into the cigarette lighter or the accessory power outlets. Turn off the radio and all lamps that are not needed. This will avoid sparks and help save both batteries. And it could save the radio!
4. Open the hoods and locate the batteries. Find the positive (+) and negative (-) terminal locations on each vehicle.

You will not need to access your battery for jump starting. Your vehicle has a remote positive (+) jump starting terminal for that purpose.

The remote positive (+) terminal is located in the engine compartment on the passenger's side of the vehicle, on the underhood fuse block. See *Engine Compartment Overview* on page 5-12 for more information on location.

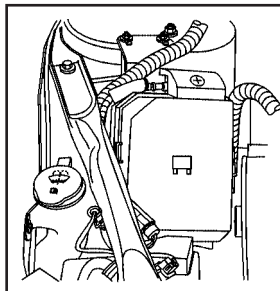

To uncover the remote positive (+) terminal, remove the fuse block cover. You should always use the remote positive (+) terminal instead of the positive (+) terminal on the battery.

⚠ CAUTION:

An electric fan can start up even when the engine is not running and can injure you. Keep hands, clothing and tools away from any underhood electric fan.

 **CAUTION:**

Using a match near a battery can cause battery gas to explode. People have been hurt doing this, and some have been blinded. Use a flashlight if you need more light.

Be sure the battery has enough water. You do not need to add water to the battery installed in your new vehicle. But if a battery has filler caps, be sure the right amount of fluid is there. If it is low, add water to take care of that first. If you do not, explosive gas could be present.

Battery fluid contains acid that can burn you. Do not get it on you. If you accidentally get it in your eyes or on your skin, flush the place with water and get medical help immediately.

 **CAUTION:**

Fans or other moving engine parts can injure you badly. Keep your hands away from moving parts once the engine is running.

5. Check that the jumper cables do not have loose or missing insulation. If they do, you could get a shock. The vehicles could be damaged too.
Before you connect the cables, here are some basic things you should know. Positive (+) will go to positive (+) or to a remote positive (+) terminal if the vehicle has one. Negative (-) will go to a heavy, unpainted metal engine part or to a remote negative (-) terminal if the vehicle has one.
Do not connect positive (+) to negative (-), or you will get a short that would damage the battery and maybe other parts too. And do not connect the negative (-) cable to the negative (-) terminal on the dead battery because this can cause sparks.
6. Connect the red positive (+) cable to the positive (+) terminal location of the vehicle with the dead battery. Use a remote positive (+) terminal if the vehicle has one.

7. Do not let the other end touch metal. Connect it to the positive (+) terminal location of the vehicle with the good battery. Use a remote positive (+) terminal if the vehicle has one.
8. Now connect the black negative (-) cable to the negative (-) terminal location of the vehicle with the good battery. Use a remote negative (-) terminal if the vehicle has one.

Do not let the other end touch anything until the next step. The other end of the negative (-) cable does not go to the dead battery. It goes to a heavy, unpainted metal engine part or to a remote negative (-) terminal on the vehicle with the dead battery.

9. Connect the other end of the negative (-) cable at least 18 inches (45 cm) away from the dead battery, but not near engine parts that move. The electrical connection is just as good there, and the chance of sparks getting back to the battery is much less.
10. Now start the vehicle with the good battery and run the engine for a while.
11. Try to start the vehicle that had the dead battery. If it will not start after a few tries, it probably needs service.

Notice: If the jumper cables are connected or removed in the wrong order, electrical shorting may occur and damage the vehicle. The repairs would not be covered by your warranty. Always connect and remove the jumper cables in the correct order, making sure that the cables do not touch each other or other metal.

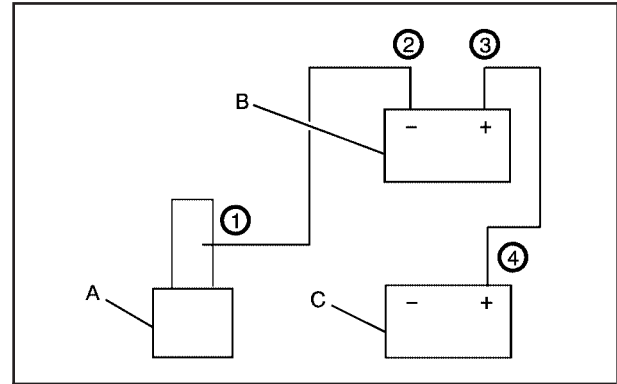

Jumper Cable Removal

- A. Heavy, Unpainted Metal Engine Part or Remote Negative (-) Terminal
- B. Good Battery or Remote Positive (+) Terminal and Remote Negative (-) Terminals
- C. Dead Battery or Remote Positive (+) Terminal

To disconnect the jumper cables from both vehicles, do the following:

1. Disconnect the black negative (-) cable from the vehicle that had the dead battery.
2. Disconnect the black negative (-) cable from the vehicle with the good battery.
3. Disconnect the red positive (+) cable from the vehicle with the good battery.
4. Disconnect the red positive (+) cable from the other vehicle.
5. Return the fuse block cover to its original position.

Headlamp Aiming

Headlamp aim has been preset at the factory and should need no further adjustment.

However, if your vehicle is damaged in an accident, the headlamp aim may be affected. Aim adjustment to the low-beam headlamps may be necessary if it is difficult to see the lane markers (for horizontal aim), or if oncoming drivers flash their high-beam headlamps at you (for vertical aim).

If you believe your headlamps need to be re-aimed, it is recommend that you take the vehicle to your dealer for service.

Bulb Replacement

For the proper type of replacement bulbs, see *Replacement Bulbs on page 5-51*.

For any bulb changing procedure not listed in this section, contact your dealer.

Halogen Bulbs

CAUTION:

Halogen bulbs have pressurized gas inside and can burst if you drop or scratch the bulb. You or others could be injured. Be sure to read and follow the instructions on the bulb package.

Headlamps, Front Turn Signal, Sidemarker, and Parking Lamps

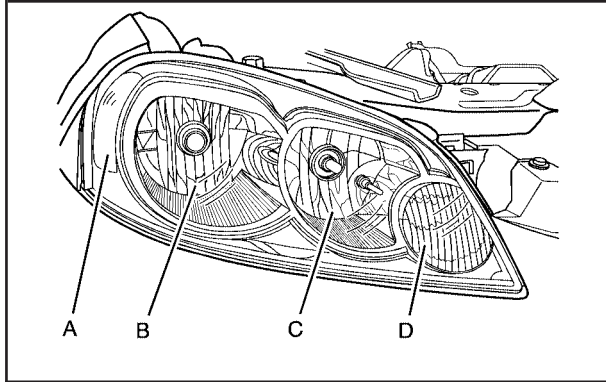

- A. Sidemarker
- B. Low-Beam Headlamp
- C. High-Beam Headlamp
- D. Parking/Turn Signal Lamp

To replace one of these bulbs, do the following:

1. Open the hood. See *Hood Release* on page 5-11 for more information.

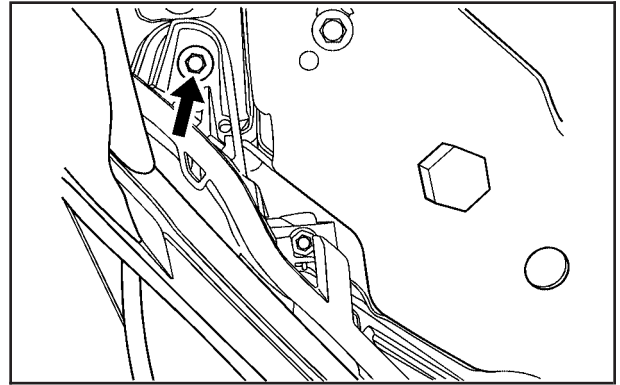

2. Remove the screw from the headlamp assembly.

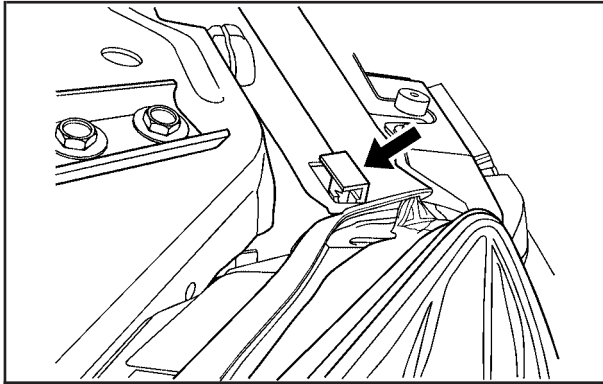

3. Remove the headlamp plastic retainer by pulling it up.
4. Pull the headlamp assembly away from the vehicle and remove the electrical connector.
5. Remove the round dust caps to gain access to the bulbs.
6. Turn the old bulb counterclockwise and remove it from the retaining ring by pulling it away from the headlamp.
7. Remove the electrical connector from the bulb by raising the lock tab and pulling the connector away from the bulb's base.

8. Install the electrical connector to the bulb.
9. Install the new bulb by inserting the smallest tab on the bulb base into the matching notch in the retaining ring. Turn the bulb a quarter-turn clockwise until it stops.
10. Reverse Steps 1 through 5 to reinstall the headlamp assembly.

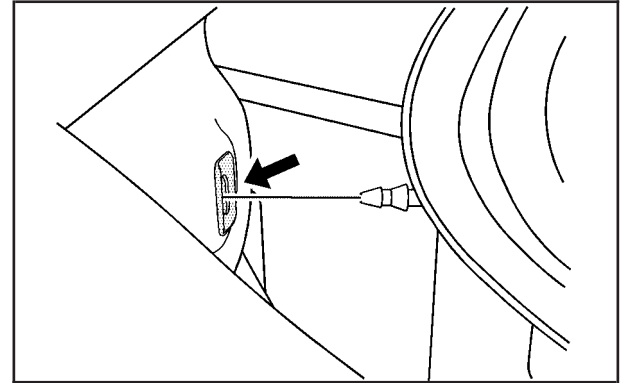

When you reinstall the headlamp assembly, make sure to line up the pin in the headlamp assembly with the slot in the vehicle.

Taillamps, Stoplamps and Back-up Lamps

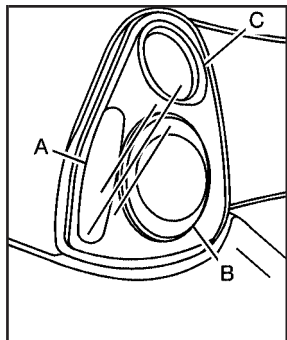

- A. Rear Sidemarket Lamp
- B. Taillamp/Turn Signal and Stoplamp
- C. Taillamp

3. Pull the carpet away from the rear of the vehicle.
4. Remove the two hex nuts.
5. Pull the assembly from the vehicle.
6. Remove the bulb socket. To do so, press the tab, turn it counterclockwise and pull it out.
7. Pull the old bulb out. Do not twist it.
8. Push the new bulb into the bulb socket.
9. Reverse Steps 1 through 5 to reinstall the taillamp assembly.

To replace one of these bulbs, do the following:

1. Open the trunk. See *Trunk* on page 2-11 for more information.
2. Remove the convenience net, if your vehicle has one, and then remove it by unhooking the upper wing nut.

Back-Up Lamps

The back-up lamps are located in the rear bumper.

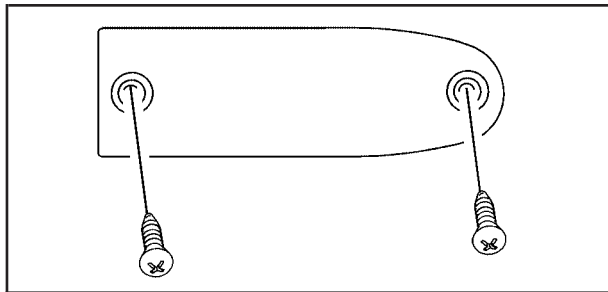

1. Remove the two screws from the back-up lamp assembly.
2. Pull the assembly from the rear bumper.
3. Remove the socket by turning it counterclockwise and pull it out.
4. Pull the old bulb straight out. Do not twist it.
5. Push the new bulb into the socket.
6. Push the socket back into the assembly. Tighten the socket by turning it clockwise.
7. Reinstall the assembly with the two screws.

Replacement Bulbs

Exterior Lamp	Bulb Number
Back-Up Lamp	921
Front Parking/Turn Signal Lamp	3157
Headlamps	
High-Beam	H9
Low-Beam	H11
Sidemarkers Lamp	194
Stoptlamps, Taillamps, and Turn Signal Lamp	3067

For replacement bulbs not listed here, contact your dealer.

Windshield Wiper Blade Replacement

Windshield wiper blades should be inspected for wear or cracking. See *Scheduled Maintenance on page 6-4* for more information on wiper blade inspection.

Replacement blades come in different types and are removed in different ways. Here's how to remove the wiper blade:

1. Pull the windshield wiper arm connector away from the windshield.

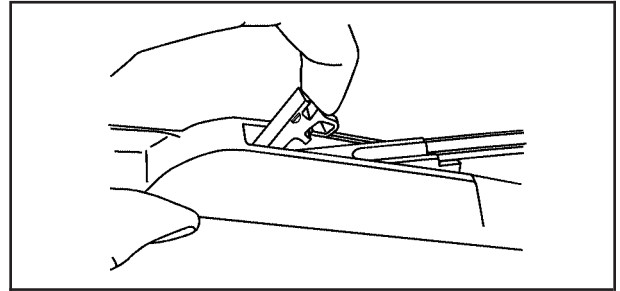

2. While holding the wiper arm, pull the clip up from the blade connecting point, and pull the blade assembly down toward the windshield to remove it from the wiper arm.
3. Install the new wiper blade onto the wiper arm and snap the clip down into place.

To remove and replace the wiper blade element do the following:

1. The wiper blade element has two notches at one end which are engaged by the bottom claw set of the wiper blade. At the notched end of the wiper blade, pull the wiper blade element from the wiper blade assembly.
2. To replace the element, start at the heel end of the wiper blade, which is the end nearest to the base of the wiper arm, and slide the wiper blade element, notched end last, into the wiper blade claw sets.
3. To engage the last claw into the notched end of the wiper blade element, squeeze the wiper blade element at the notched area, and push the wiper blade element so the claw fits into the notch.
4. Be sure the two wiper blade element notches are engaged by the last claw set, and that all the other claws are properly engaged in the slots of the wiper blade element on both sides.

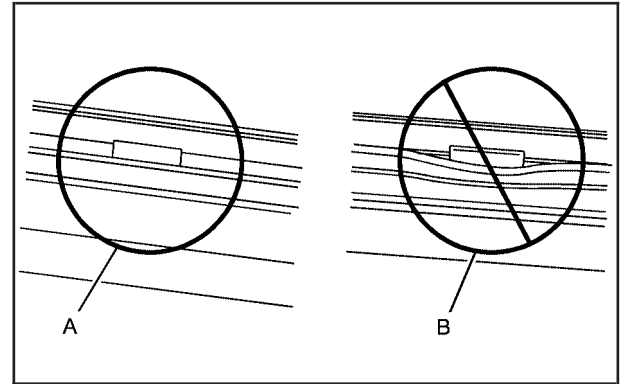

A. Correct Installation

B. Incorrect Installation

For the proper type and size windshield wiper blades, see *Normal Maintenance Replacement Parts* on page 6-13.

Tires

Your new vehicle comes with high-quality tires made by a leading tire manufacturer. If you ever have questions about your tire warranty and where to obtain service, see your GM Warranty booklet for details. For additional information refer to the tire manufacturer's booklet included with your vehicle's Owner Manual.

CAUTION:

Poorly maintained and improperly used tires are dangerous.

- Overloading your tires can cause overheating as a result of too much friction. You could have an air-out and a serious accident. See *Loading Your Vehicle on page 4-29*.

CAUTION: (Continued)

CAUTION: (Continued)

- Underinflated tires pose the same danger as overloaded tires. The resulting accident could cause serious injury. Check all tires frequently to maintain the recommended pressure. Tire pressure should be checked when your tires are cold. See *Inflation - Tire Pressure on page 5-60*.
- Overinflated tires are more likely to be cut, punctured, or broken by a sudden impact — such as when you hit a pothole. Keep tires at the recommended pressure.
- Worn, old tires can cause accidents. If your tread is badly worn, or if your tires have been damaged, replace them.

Tire Sidewall Labeling

Useful information about a tire is molded into its sidewall. The examples below show a typical passenger vehicle tire and a compact spare tire sidewall.

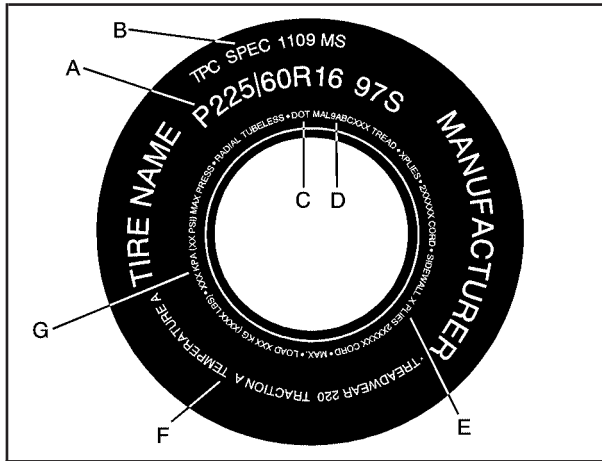

Passenger (P-Metric) Tire Example

(A) Tire Size: The tire size is a combination of letters and numbers used to define a particular tire's width, height, aspect ratio, construction type, and service description. See the "Tire Size" illustration later in this section for more detail.

(B) TPC Spec (Tire Performance Criteria Specification): Original equipment tires designed to GM's specific tire performance criteria have a TPC specification code molded onto the sidewall. GM's TPC specifications meet or exceed all federal safety guidelines.

(C) DOT (Department of Transportation): The Department of Transportation (DOT) code indicates that the tire is in compliance with the U.S. Department of Transportation Motor Vehicle Safety Standards.

(D) Tire Identification Number (TIN): The letters and numbers following DOT (Department of Transportation) code is the Tire Identification Number (TIN). The TIN shows the manufacturer and plant code, tire size, and date the tire was manufactured. The TIN is molded onto both sides of the tire, although only one side may have the date of manufacture.

(E) Tire Ply Material: The type of cord and number of plies in the sidewall and under the tread.

(F) Uniform Tire Quality Grading (UTQG): Tire manufacturers are required to grade tires based on three performance factors: treadwear, traction, and temperature resistance. For more information see *Uniform Tire Quality Grading on page 5-70*.

(G) Maximum Cold Inflation Load Limit: Maximum load that can be carried and the maximum pressure needed to support that load.

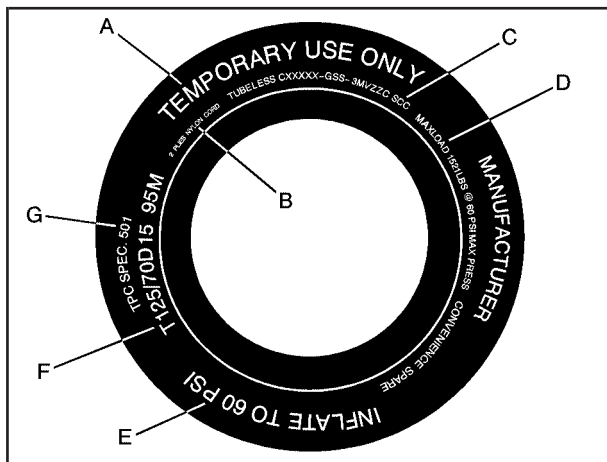

Compact Spare Tire Example

(A) Temporary Use Only: The compact spare tire or temporary use tire has a tread life of approximately 3,000 miles (5 000 km) and should not be driven at speeds over 65 mph (105 km/h). The compact spare tire is for emergency use when a regular road tire has lost air and gone flat. If your vehicle has a compact spare tire, see *Compact Spare Tire on page 5-85* and *If a Tire Goes Flat on page 5-74*.

(B) Tire Ply Material: The type of cord and number of plies in the sidewall and under the tread.

(C) Tire Identification Number (TIN): The letters and numbers following the DOT (Department of Transportation) code is the Tire Identification Number (TIN). The TIN shows the manufacturer and plant code, tire size, and date the tire was manufactured. The TIN is molded onto both sides of the tire, although only one side may have the date of manufacture.

(D) Maximum Cold Inflation Load Limit: Maximum load that can be carried and the maximum pressure needed to support that load.

(E) Tire Inflation: The temporary use tire or compact spare tire should be inflated to 60 psi (420 kPa). For more information on tire pressure and inflation see *Inflation - Tire Pressure on page 5-60*.

(F) Tire Size: A combination of letters and numbers define a tire's width, height, aspect ratio, construction type and service description. The letter T as the first character in the tire size means the tire is for temporary use only.

(G) TPC Spec (Tire Performance Criteria Specification): Original equipment tires designed to GM's specific tire performance criteria have a TPC specification code molded onto the sidewall. GM's TPC specifications meet or exceed all federal safety guidelines.

Tire Size

The following illustration shows an example of a typical passenger vehicle tire size.

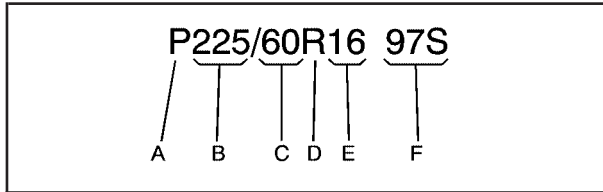

(A) Passenger (P-Metric) Tire: The United States version of a metric tire sizing system. The letter P as the first character in the tire size means a passenger vehicle tire engineered to standards set by the U.S. Tire and Rim Association.

(B) Tire Width: The three-digit number indicates the tire section width in millimeters from sidewall to sidewall.

(C) Aspect Ratio: A two-digit number that indicates the tire height-to-width measurements. For example, if the tire size aspect ratio is 60, as shown in item C of the illustration, it would mean that the tire's sidewall is 60 percent as high as it is wide.

(D) Construction Code: A letter code is used to indicate the type of ply construction in the tire. The letter R means radial ply construction; the letter D means diagonal or bias ply construction; and the letter B means belted-bias ply construction.

(E) Rim Diameter: Diameter of the wheel in inches.

(F) Service Description: These characters represent the load range and speed rating of the tire. The load index represents the load carry capacity a tire is certified to carry. The load index can range from 1 to 279. The speed rating is the maximum speed a tire is certified to carry a load. Speed ratings range from A to Z.

Tire Terminology and Definitions

Air Pressure: The amount of air inside the tire pressing outward on each square inch of the tire. Air pressure is expressed in pounds per square inch (psi) or kilopascal (kPa).

Accessory Weight: This means the combined weight of optional accessories. Some examples of optional accessories are, automatic transmission, power steering, power brakes, power windows, power seats, and air conditioning.

Aspect Ratio: The relationship of a tire's height to its width.

Belt: A rubber coated layer of cords that is located between the plies and the tread. Cords may be made from steel or other reinforcing materials.

Bead: The tire bead contains steel wires wrapped by steel cords that hold the tire onto the rim.

Bias Ply Tire: A pneumatic tire in which the plies are laid at alternate angles less than 90 degrees to the centerline of the tread.

Cold Inflation Pressure: The amount of air pressure in a tire, measured in pounds per square inch (psi) or kilopascals (kPa) before a tire has built up heat from driving. See *Inflation - Tire Pressure on page 5-60*.

Curb Weight: This means the weight of a motor vehicle with standard and optional equipment including the maximum capacity of fuel, oil and coolant, but without passengers and cargo.

DOT Markings: A code molded into the sidewall of a tire signifying that the tire is in compliance with the U.S. Department of Transportation (DOT) motor vehicle safety standards. The DOT code includes the Tire Identification Number (TIN), an alphanumeric designator which can also identify the tire manufacturer, production plant, brand and date of production.

GVWR: Gross Vehicle Weight Rating, see *Loading Your Vehicle on page 4-29*.

GAWR FRT: Gross Axle Weight Rating for the front axle, see *Loading Your Vehicle on page 4-29*.

GAWR RR: Gross Axle Weight Rating for the rear axle, see *Loading Your Vehicle on page 4-29*.

Intended Outboard Sidewall: The side of an asymmetrical tire, that must always face outward when mounted on a vehicle.

Kilopascal (kPa): The metric unit for air pressure.

Light Truck (LT-Metric) Tire: A tire used on light duty trucks and some multipurpose passenger vehicles.

Load Index: An assigned number ranging from 1 to 279 that corresponds to the load carrying capacity of a tire.

Maximum Inflation Pressure: The maximum air pressure to which a cold tire may be inflated. The maximum air pressure is molded onto the sidewall.

Maximum Load Rating: The load rating for a tire at the maximum permissible inflation pressure for that tire.

Maximum Loaded Vehicle Weight: The sum of curb weight; accessory weight; vehicle capacity weight; and production options weight.

Normal Occupant Weight: The number of occupants a vehicle is designed to seat multiplied by 150 lbs (68 kg). See *Loading Your Vehicle on page 4-29*.

Occupant Distribution: Designated seating positions.

Outward Facing Sidewall: The side of an asymmetrical tire that has a particular side that faces outward when mounted on a vehicle. The side of the tire that contains a whitewall, bears white lettering, or bears manufacturer, brand, and/or model name molding that is higher or deeper than the same moldings on the other sidewall of the tire.

Passenger (P-Metric) Tire: A tire used on passenger cars and some light duty trucks and multipurpose vehicles.

Recommended Inflation Pressure: Vehicle manufacturer's recommended tire inflation pressure and shown on the tire placard. See *Inflation - Tire Pressure on page 5-60* and *Loading Your Vehicle on page 4-29*.

Radial Ply Tire: A pneumatic tire in which the ply cords that extend to the beads are laid at 90 degrees to the centerline of the tread.

Rim: A metal support for a tire and upon which the tire beads are seated.

Sidewall: The portion of a tire between the tread and the bead.

Speed Rating: An alphanumeric code assigned to a tire indicating the maximum speed at which a tire can operate.

Traction: The friction between the tire and the road surface. The amount of grip provided.

Tread: The portion of a tire that comes into contact with the road.

Treadwear Indicators: Narrow bands, sometimes called wear bars, that show across the tread of a tire when only 1/16 inch (1.6 mm) of tread remains. See *When It Is Time for New Tires on page 5-67*.

UTQGS (Uniform Tire Quality Grading Standards):

A tire information system that provides consumers with ratings for a tire's traction, temperature, and treadwear. Ratings are determined by tire manufacturers using government testing procedures. The ratings are molded into the sidewall of the tire. See *Uniform Tire Quality Grading on page 5-70*.

Vehicle Capacity Weight: The number of designated seating positions multiplied by 150 lbs (68 kg) plus the rated cargo load. See *Loading Your Vehicle on page 4-29*.

Vehicle Maximum Load on the Tire: Load on an individual tire due to curb weight, accessory weight, occupant weight, and cargo weight.

Vehicle Placard: A label permanently attached to a vehicle showing the vehicle's capacity weight and the original equipment tire size and recommended inflation pressure. See "Tire and Loading Information Label" under *Loading Your Vehicle on page 4-29*.

Inflation - Tire Pressure

Tires need the correct amount of air pressure to operate effectively.

Notice: Do not let anyone tell you that under-inflation or over-inflation is all right. It is not. If your tires do not have enough air (under-inflation), you can get the following:

- Too much flexing
- Too much heat
- Tire overloading
- Premature or irregular wear
- Poor handling
- Reduced fuel economy

If your tires have too much air (over-inflation), you can get the following:

- Unusual wear
- Poor handling
- Rough ride
- Needless damage from road hazards

A Tire and Loading Information label is attached to the vehicle's center pillar (B-pillar), below the driver's door latch. This label shows your vehicle's original equipment tires and the correct inflation pressures for your tires when they are cold. The recommended cold tire inflation pressure, shown on the label, is the minimum amount of air pressure needed to support your vehicle's maximum load carrying capacity.

For additional information regarding how much weight your vehicle can carry, and an example of the tire and loading information label, see *Loading Your Vehicle on page 4-29*. How you load your vehicle affects vehicle handling and ride comfort, never load your vehicle with more weight than it was designed to carry.

When to Check

Check your tires once a month or more. Do not forget to check the compact spare tire, it should be at 60 psi (420 kPa). For additional information regarding the compact spare tire, see *Compact Spare Tire on page 5-85*.

How to Check

Use a good quality pocket-type gage to check tire pressure. You cannot tell if your tires are properly inflated simply by looking at them. Radial tires may look properly inflated even when they are under-inflated. Check the tire's inflation pressure when the tires are cold. Cold means your vehicle has been sitting for at least three hours or driven no more than 1 mile (1.6 km).

Remove the valve cap from the tire valve stem. Press the tire gage firmly onto the valve to get a pressure measurement. If the cold tire inflation pressure matches the recommended pressure on the Tire and Loading Information label, no further adjustment is necessary. If the inflation pressure is low, add air until you reach the recommended amount.

If you overfill the tire, release air by pushing on the metal stem in the center of the tire valve. Re-check the tire pressure with the tire gage.

Be sure to put the valve caps back on the valve stems. They help prevent leaks by keeping out dirt and moisture.

Tire Pressure Monitor System

Your vehicle may have a Tire Pressure Monitor System (TPMS). This system uses radio and sensor technology to check tire pressure levels. If your vehicle has this feature, sensors are mounted onto each tire and wheel assembly, except for the spare tire. The TPMS sensors monitor the air pressure in your vehicle's tires and transmit tire pressure readings to a receiver located in the vehicle.

Each tire, including the spare (if provided), should be checked monthly when cold and inflated to the inflation pressure recommended by the vehicle manufacturer on the vehicle placard or tire inflation pressure label. (If your vehicle has tires of a different size than the size indicated on the vehicle placard or tire inflation pressure label, you should determine the proper inflation pressure for those tires.)

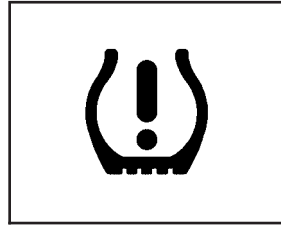

As an added safety feature, your vehicle has been equipped with a tire pressure monitoring system (TPMS) that illuminates a low tire pressure telltale when one or more of your tires is significantly under-inflated.

Accordingly, when the low tire pressure telltale illuminates, you should stop and check your tires as soon as possible, and inflate them to the proper pressure. Driving on a significantly under-inflated tire causes the tire to overheat and can lead to tire failure. Under-inflation also reduces fuel efficiency and tire tread life, and may affect the vehicle's handling and stopping ability.

Please note that the TPMS is not a substitute for proper tire maintenance, and it is the driver's responsibility to maintain correct tire pressure, even if under-inflation has not reached the level to trigger illumination of the TPMS low tire pressure telltale.

When a low tire pressure condition is detected, the TPMS will illuminate the low tire pressure warning symbol on the instrument panel cluster, and at the same time a message to check the pressure in a specific tire will appear on the Driver Information Center (DIC) display. The low tire pressure warning symbol on the instrument panel cluster and the check tire pressure message will appear at each ignition cycle until the tires are inflated to the correct inflation pressure. Using the DIC, tire pressure levels can be viewed by the driver. For additional information and details about the DIC operation and displays see *DIC Operation and Displays on page 3-40* and *DIC Warnings and Messages on page 3-46*.

The tire pressure warning light may come on in cool weather when the vehicle is first started, and then turn off as you start to drive. This may be an early indicator that the air pressure in the tire(s) are getting low and need to be inflated to the proper pressure.

A tire and Loading Information label, attached to your vehicle, shows the size of your vehicle's original equipment tires and the correct inflation pressure for your vehicle's tires when they are cold. See *Loading Your Vehicle on page 4-29*, for an example of the tire information label and its location on your vehicle. Also see *Inflation - Tire Pressure on page 5-60*.

Your vehicle's TPMS system can warn you about a low tire pressure condition but it does not replace normal tire maintenance. See *Tire Inspection and Rotation on page 5-66* and *Tires on page 5-54*.

Notice: Do not use a tire sealant if your vehicle has Tire Pressure Monitors. The liquid sealant can damage the tire pressure monitor sensors.

The TPMS will not function properly if one or more of the TPMS sensors are missing or inoperable. If the system detects a missing or inoperable sensor, an error message SERVICE TIRE MONITOR SYSTEM will be shown on the DIC display. If you have replaced a tire/wheel assembly without transferring the TPMS sensors, the error message will be displayed. Once you re-install the TPMS sensors, the error message should go off. See your GM dealer for service if all TPMS sensors are installed and the error message comes on and stays on.

TPMS Sensor Identification Codes

Each TPMS sensor has a unique identification code. Any time you replace one or more of the TPMS sensors or rotate the vehicle's tires, the identification codes will need to be matched to the new tire/wheel position. The sensors are matched, to the tire/wheel positions, in the following order: driver's side front tire, passenger's side front tire, passenger's side rear tire, and driver's side rear tire using a TPMS diagnostic tool. See your GM dealer for service.

The TPMS sensors may also be matched to each tire/wheel position by increasing or decreasing the tire's air pressure. When increasing the tire's pressure, do not exceed the maximum inflation pressure indicated on the tire's sidewall.

You will have two minutes to match each tire and wheel position. If it takes longer than two minutes to match any tire and wheel position, the matching process stops and you will need to start over.

The TPMS matching process is outlined below:

1. Set the parking brake.
2. Turn the ignition switch to RUN with the engine off.
3. Using the DIC, press the vehicle information button until the LEARN TIRE POSITIONS message displays.
4. Press the set/reset button to allow the system to learn the tire positions. The horn will sound twice to indicate the receiver is ready, and the TIRE LEARNING ACTIVE message will display. The TPMS system is ready for the sensor matching process to begin.
5. Start with the driver's side front tire.
6. Remove the valve cap from the tire's valve stem. Activate the TPMS sensor by increasing or decreasing the tire's air pressure for five seconds, or until a horn chirp sounds. The horn chirp, which may take up to 30 seconds to sound, confirms that the sensor identification code has been matched to the tire/wheel position. To decrease the tire's air-pressure use the pointed end of the valve cap, a pencil-style air pressure gage, or a key.

7. Proceed to the passenger's side front tire, and repeat the procedure in Step 6.
8. Proceed to the passenger's side rear tire, and repeat the procedure in Step 6.
9. Proceed to the driver's side rear tire, and repeat the procedure in Step 6.
10. After hearing the confirming horn chirp for the driver's side rear tire, the tire learning process ends. Turn the ignition switch to OFF.
11. Set all four tires to the recommended air pressure level as indicated on the tire and loading information label.
12. Put the valve caps back on the valve stems.

Federal Communications Commission (FCC) and Industry and Science Canada

The Tire Pressure Monitor System (TPMS) operates on a radio frequency and complies with Part 15 of the FCC Rules and with RSS-210 of Industry and Science Canada. Operation is subject to the following two conditions:

1. This device may not cause harmful interference.
2. This device must accept any interference received, including interference that may cause undesired operation.

Changes or modifications to this system by other than an authorized service facility could void authorization to use this equipment.

Tire Inspection and Rotation

Tires should be rotated every 5,000 to 8,000 miles (8 000 to 13 000 km).

Any time you notice unusual wear, rotate your tires as soon as possible and check wheel alignment. Also check for damaged tires or wheels. See *When It Is Time for New Tires* on page 5-67 and *Wheel Replacement* on page 5-71 for more information.

The purpose of regular rotation is to achieve more uniform wear for all tires on the vehicle. The first rotation is the most important. See *Scheduled Maintenance* on page 6-4 for scheduled rotation intervals.

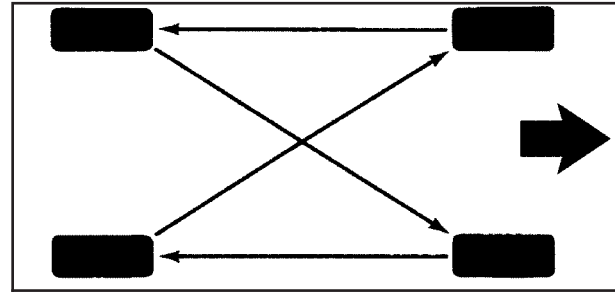

When rotating your tires, always use the correct rotation pattern shown here.

Do not include the compact spare tire in your tire rotation.

After the tires have been rotated, adjust the front and rear inflation pressures as shown on the Tire and Loading Information label. See *Inflation - Tire Pressure* on page 5-60 and *Loading Your Vehicle* on page 4-29.

Reset the Tire Pressure Monitor System. See “TPMS Sensor Identification Codes” under *Tire Pressure Monitor System* on page 5-62.

Make certain that all wheel nuts are properly tightened. See “Wheel Nut Torque” under *Capacities and Specifications* on page 5-100.

CAUTION:

Rust or dirt on a wheel, or on the parts to which it is fastened, can make wheel nuts become loose after a time. The wheel could come off and cause an accident. When you change a wheel, remove any rust or dirt from places where the wheel attaches to the vehicle. In an emergency, you can use a cloth or a paper towel to do this; but be sure to use a scraper or wire brush later, if needed, to get all the rust or dirt off. See *Changing a Flat Tire on page 5-74*.

When It Is Time for New Tires

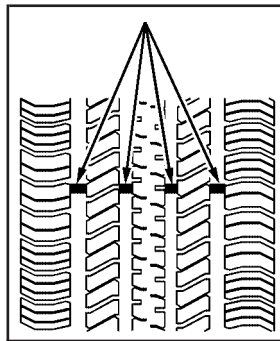

One way to tell when it is time for new tires is to check the treadwear indicators, which will appear when your tires have only 1/16 inch (1.6 mm) or less of tread remaining.

You need a new tire if any of the following statements are true:

- You can see the indicators at three or more places around the tire.
- You can see cord or fabric showing through the tire's rubber.
- The tread or sidewall is cracked, cut, or snagged deep enough to show cord or fabric.
- The tire has a bump, bulge, or split.
- The tire has a puncture, cut or other damage that cannot be repaired well because of the size or location of the damage.

Buying New Tires

GM has developed and matched specific tires for your vehicle. The original equipment tires installed on your vehicle, when it was new, were designed to meet General Motors Tire Performance Criteria Specification (TPC Spec) system rating. If you need replacement tires, GM strongly recommends that you get tires with the same TPC Spec rating. This way, your vehicle will continue to have tires that are designed to give the same performance and vehicle safety, during normal use, as the original tires.

GM's exclusive TPC Spec system considers over a dozen critical specifications that impact the overall performance of your vehicle, including brake system performance, ride and handling, traction control, and tire pressure monitoring performance. GM's TPC Spec number is molded onto the tire's sidewall by the tire manufacturer. If the tires have an all-season tread design, the TPC Spec number will be followed by an MS for mud and snow. See *Tire Sidewall Labeling on page 5-55* for additional information.

CAUTION:

Mixing tires could cause you to lose control while driving. If you mix tires of different sizes, brands, or types (radial and bias-belted tires), the vehicle may not handle properly, and you could have a crash. Using tires of different sizes, brands, or types may also cause damage to your vehicle. Be sure to use the correct size, brand, and type of tires on all wheels. It is all right to drive with your compact spare temporarily, as it was developed for use on your vehicle. See *Compact Spare Tire on page 5-85*.

CAUTION:

If you use bias-ply tires on your vehicle, the wheel rim flanges could develop cracks after many miles of driving. A tire and/or wheel could fail suddenly, causing a crash. Use only radial-ply tires with the wheels on your vehicle.

If you must replace your vehicle's tires with those that do not have a TPC Spec number, make sure they are the same size, load range, speed rating, and construction type (radial and bias-belted tires) as your vehicle's original tires.

Vehicles that have a tire pressure monitoring system may give an inaccurate low-pressure warning if non-TPC Spec rated tires are installed on your vehicle. Non-TPC Spec rated tires may give a low-pressure warning that is higher or lower than the proper warning level you would get with TPC Spec rated tires. See *Tire Pressure Monitor System* on page 5-62.

Your vehicle's original equipment tires are listed on the Tire and Loading Information Label. This label is attached to the vehicle's center pillar (B-pillar). See *Loading Your Vehicle* on page 4-29, for more information about the Tire and Loading Information Label and its location on your vehicle.

Different Size Tires and Wheels

If you add wheels or tires that are a different size than your original equipment wheels and tires, this may affect the way your vehicle performs, including its braking, ride and handling characteristics, stability and resistance to rollover. Additionally, if your vehicle has electronic systems such as, anti-lock brakes, traction control, and electronic stability control, the performance of these systems can be affected.

CAUTION:

If you add different sized wheels, your vehicle may not provide an acceptable level of performance and safety if tires not recommended for those wheels are selected. You may increase the chance that you will crash and suffer serious injury. Only use GM specific wheel and tire systems developed for your vehicle, and have them properly installed by a GM certified technician.

See *Buying New Tires* on page 5-68 and *Accessories and Modifications* on page 5-3 for additional information.

Uniform Tire Quality Grading

Quality grades can be found where applicable on the tire sidewall between tread shoulder and maximum section width. For example:

Treadwear 200 Traction AA Temperature A

The following information relates to the system developed by the United States National Highway Traffic Safety Administration, which grades tires by treadwear, traction and temperature performance. (This applies only to vehicles sold in the United States.)

The grades are molded on the sidewalls of most passenger car tires. The Uniform Tire Quality Grading system does not apply to deep tread, winter-type snow tires, space-saver or temporary use spare tires, tires with nominal rim diameters of 10 to 12 inches (25 to 30 cm), or to some limited-production tires.

While the tires available on General Motors passenger cars and light trucks may vary with respect to these grades, they must also conform to federal safety requirements and additional General Motors Tire Performance Criteria (TPC) standards.

Treadwear

The treadwear grade is a comparative rating based on the wear rate of the tire when tested under controlled conditions on a specified government test course. For example, a tire graded 150 would wear one and a half (1.5) times as well on the government course as a tire graded 100. The relative performance of tires depends upon the actual conditions of their use, however, and may depart significantly from the norm due to variations in driving habits, service practices and differences in road characteristics and climate.

Traction – AA, A, B, C

The traction grades, from highest to lowest, are AA, A, B, and C. Those grades represent the tire's ability to stop on wet pavement as measured under controlled conditions on specified government test surfaces of asphalt and concrete. A tire marked C may have poor traction performance. Warning: The traction grade assigned to this tire is based on straight-ahead braking traction tests, and does not include acceleration, cornering, hydroplaning, or peak traction characteristics.

Temperature – A, B, C

The temperature grades are A (the highest), B, and C, representing the tire's resistance to the generation of heat and its ability to dissipate heat when tested under controlled conditions on a specified indoor laboratory test wheel. Sustained high temperature can cause the material of the tire to degenerate and reduce tire life, and excessive temperature can lead to sudden tire failure. The grade C corresponds to a level of performance which all passenger car tires must meet under the Federal Motor Vehicle Safety Standard No. 109. Grades B and A represent higher levels of performance on the laboratory test wheel than the minimum required by law.

Warning: The temperature grade for this tire is established for a tire that is properly inflated and not overloaded. Excessive speed, underinflation, or excessive loading, either separately or in combination, can cause heat buildup and possible tire failure.

Wheel Alignment and Tire Balance

The wheels on your vehicle were aligned and balanced carefully at the factory to give you the longest tire life and best overall performance.

If you notice unusual tire wear or your vehicle pulling one way or the other, the alignment may need to be reset. If you notice your vehicle vibrating when driving on a smooth road, your wheels may need to be rebalanced.

Wheel Replacement

Replace any wheel that is bent, cracked or badly rusted or corroded. If wheel nuts keep coming loose, the wheel, wheel bolts and wheel nuts should be replaced. If the wheel leaks air, replace it (except some aluminum wheels, which can sometimes be repaired). See your dealer if any of these conditions exist.

Your dealer will know the kind of wheel you need.

Each new wheel should have the same load-carrying capacity, diameter, width, offset and be mounted the same way as the one it replaces.

If you need to replace any of your wheels, wheel bolts or wheel nuts, replace them only with new GM original equipment parts. This way, you will be sure to have the right wheel, wheel bolts and wheel nuts for your vehicle.

 **CAUTION:**

Using the wrong replacement wheels, wheel bolts, or wheel nuts on your vehicle can be dangerous. It could affect the braking and handling of your vehicle, make your tires lose air and make you lose control. You could have a collision in which you or others could be injured. Always use the correct wheel, wheel bolts and wheel nuts for replacement.

Notice: The wrong wheel can also cause problems with bearing life, brake cooling, speedometer or odometer calibration, headlamp aim, bumper height, vehicle ground clearance, and tire or tire chain clearance to the body and chassis.

See *Changing a Flat Tire* on page 5-74 for more information.

Used Replacement Wheels

 **CAUTION:**

Putting a used wheel on your vehicle is dangerous. You cannot know how it has been used or how far it has been driven. It could fail suddenly and cause a crash. If you have to replace a wheel, use a new GM original equipment wheel.

Tire Chains

CAUTION:

If your vehicle has P225/55R17 or P235/50R18 size tires, do not use tire chains, there is not enough clearance.

Tire chains used on a vehicle without the proper amount of clearance can cause damage to the brakes, suspension, or other vehicle parts. The area damaged by the tire chains could cause you to lose control of your vehicle and you or others may be injured in a crash.

Use another type of traction device only if its manufacturer recommends it for use on your vehicle and tire size combination and road conditions. Follow that manufacturer's instructions. To help avoid damage to your vehicle, drive slowly, readjust, or remove the device if it is contacting your vehicle, and do not spin your wheels.

If you do find traction devices that will fit, install them on the front tires.

Notice: If your vehicle has a tire size other than P225/55R17 or P235/50R18 size tires, use tire chains only where legal and only when you must. Use only SAE Class S-type chains that are the proper size for your tires. Install them on the front tires and tighten them as tightly as possible with the ends securely fastened. Drive slowly and follow the chain manufacturer's instructions. If you can hear the chains contacting your vehicle, stop and retighten them. If the contact continues, slow down until it stops. Driving too fast or spinning the wheels with chains on will damage your vehicle.

If a Tire Goes Flat

It is unusual for a tire to blowout while you are driving, especially if you maintain your vehicle's tires properly. If air goes out of a tire, it is much more likely to leak out slowly. But if you should ever have a blowout, here are a few tips about what to expect and what to do:

If a front tire fails, the flat tire will create a drag that pulls the vehicle toward that side. Take your foot off the accelerator pedal and grip the steering wheel firmly. Steer to maintain lane position, and then gently brake to a stop well out of the traffic lane.

A rear blowout, particularly on a curve, acts much like a skid and may require the same correction you would use in a skid. In any rear blowout remove your foot from the accelerator pedal. Get the vehicle under control by steering the way you want the vehicle to go. It may be very bumpy and noisy, but you can still steer. Gently brake to a stop, well off the road if possible.

CAUTION:

Lifting a vehicle and getting under it to do maintenance or repairs is dangerous without the appropriate safety equipment and training. The jack provided with your vehicle is designed only for changing a flat tire. If it is used for anything else, you or others could be badly injured or killed if the vehicle slips off the jack. Use the jack provided with your vehicle only for changing a flat tire.

If a tire goes flat, the next part shows how to use the jacking equipment to change a flat tire safely.

Changing a Flat Tire

If a tire goes flat, avoid further tire and wheel damage by driving slowly to a level place. Turn on your vehicle's hazard warning flashers. See *Hazard Warning Flashers* on page 3-6 for more information.

CAUTION:

Changing a tire can be dangerous. The vehicle can slip off the jack and roll over or fall on you or other people. You and they could be badly injured or even killed. Find a level place to change your tire. To help prevent the vehicle from moving:

1. Set the parking brake firmly.
2. Put the shift lever in PARK (P).
3. Turn off the engine and do not restart while the vehicle is raised.
4. Do not allow passengers to remain in the vehicle.

To be even more certain the vehicle will not move, you should put blocks at the front and rear of the tire farthest away from the one being changed. That would be the tire, on the other side, at the opposite end of the vehicle.

When your vehicle has a flat tire, use the following example as a guide to assist you in the placement of wheel blocks.

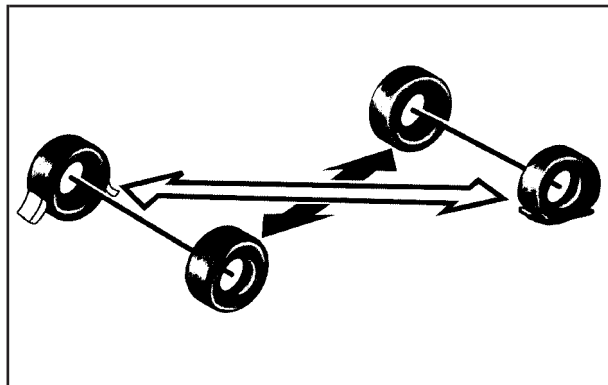

The following information will tell you next how to use the jack and change a tire.

Removing the Spare Tire and Tools

The equipment you will need is located in the trunk.

1. Open the trunk. See *Trunk* on page 2-11 for more information.

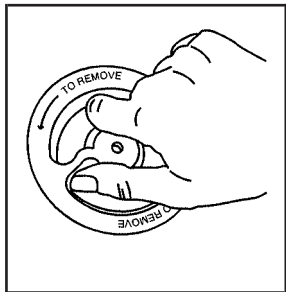

2. Turn the center nut on the compact spare tire cover counterclockwise to remove it. Then remove the cover.

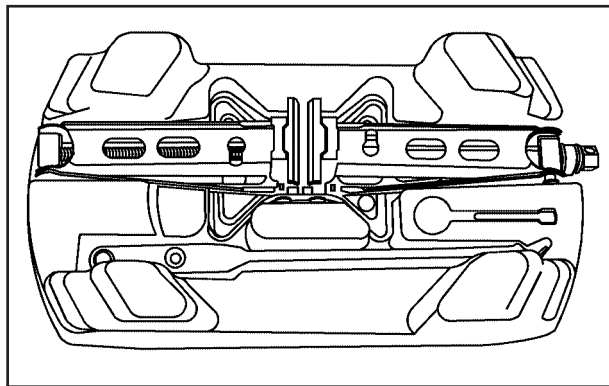

4. Turn the nut holding the jack counterclockwise and remove it. Then remove the jack and wrench.

3. Remove the compact spare tire. See *Compact Spare Tire* on page 5-85 for more information.

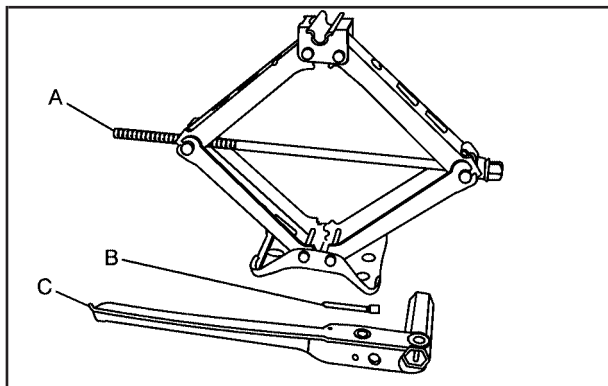

The tools you will need to change a tire include the jack (A), extension and protection guide (B), and wheel wrench (C).

Removing the Flat Tire and Installing the Spare Tire

Your vehicle may have aluminum wheels. If so, you will see exposed stainless steel wheel nuts. Use the wheel wrench to loosen all the wheel nuts. Do not remove them yet.

Or, your vehicle may have steel wheel covers.

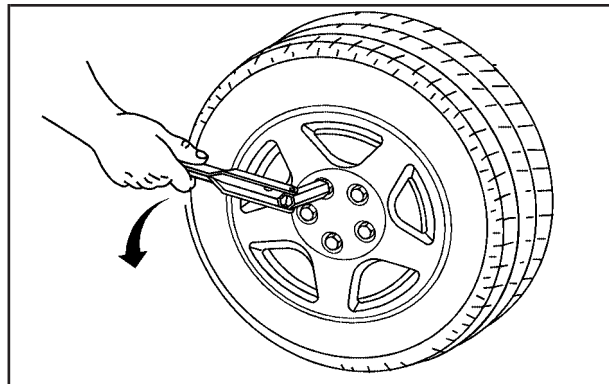

To remove the steel wheel covers and wheel nut caps, loosen the plastic nut caps with the wheel wrench in a counterclockwise direction. If needed, you can finish loosening them with your fingers. The plastic nut caps will not come off.

Use the flat end of the wheel wrench and pry along the edge of the cover until it comes off. The edge of the wheel cover could be sharp, so do not try to remove it with your bare hands. Do not drop the cover or lay it face down, as it could become scratched or damaged.

Once you have removed the wheel cover, use the following procedure to remove the flat tire and install the spare tire.

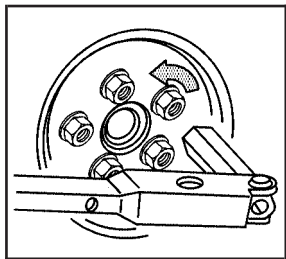

1. Turn the wheel wrench once on each wheel nut to loosen them. Do not remove them yet.

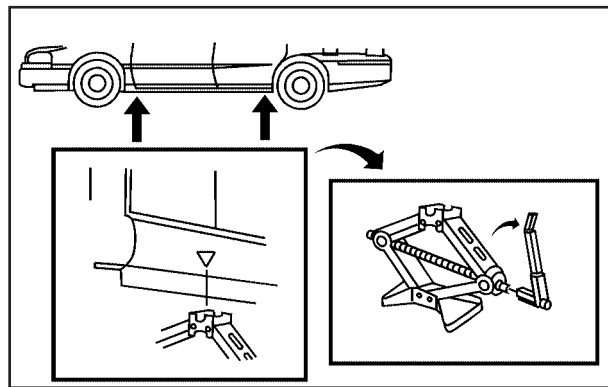

2. For all wheel types, find the jacking location using the diagram above and the corresponding hoisting notches located in the plastic molding. The notches in the plastic molding are marked with a triangle shape to help you find them.

The front location is about 7 inches (17.7 cm) from the rear edge of the front wheel well. The rear location is about 8.5 inches (21.6 cm) from the rear edge of the wheel well.

3. Put the compact spare tire near you.

 **CAUTION:**

Getting under a vehicle when it is jacked up is dangerous. If the vehicle slips off the jack you could be badly injured or killed. Never get under a vehicle when it is supported only by a jack.

 **CAUTION:**

Raising your vehicle with the jack improperly positioned can damage the vehicle and even make the vehicle fall. To help avoid personal injury and vehicle damage, be sure to fit the jack lift head into the proper location before raising the vehicle.

⚠ CAUTION:

Lifting a vehicle and getting under it to do maintenance or repairs is dangerous without the appropriate safety equipment and training. The jack provided with your vehicle is designed only for changing a flat tire. If it is used for anything else, you or others could be badly injured or killed if the vehicle slips off the jack. Use the jack provided with your vehicle only for changing a flat tire.

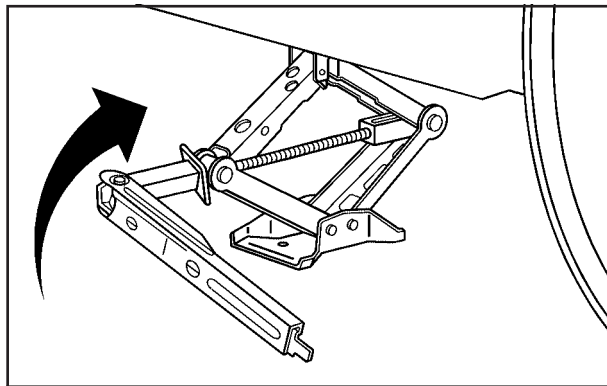

4. Raise the vehicle by turning the jack handle clockwise. Raise the vehicle far enough off the ground for the compact spare tire to fit underneath the wheel well of the vehicle.
5. Remove all wheel nuts and take off the flat tire.

⚠ CAUTION:

Rust or dirt on the wheel, or on the parts to which it is fastened, can make the wheel nuts become loose after a time. The wheel could come off and cause an accident. When you change a wheel, remove any rust or dirt from the places where the wheel attaches to the vehicle. In an emergency, you can use a cloth or a paper towel to do this; but be sure to use a scraper or wire brush later, if needed, to get all the rust or dirt off.

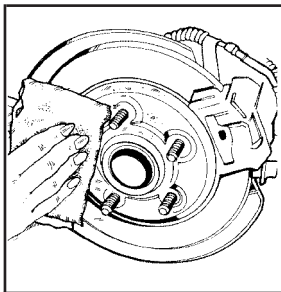

6. Remove any rust or dirt from the wheel bolts, mounting surfaces and spare wheel.

7. Install the compact spare tire.

⚠ CAUTION:

Never use oil or grease on studs or nuts. If you do, the nuts might come loose. Your wheel could fall off, causing a serious accident.

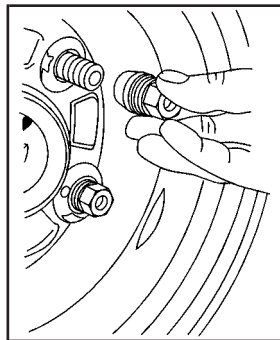

8. Reinstall the wheel nuts with the rounded end of the nuts toward the wheel. Tighten each nut by hand until the wheel is held against the hub.

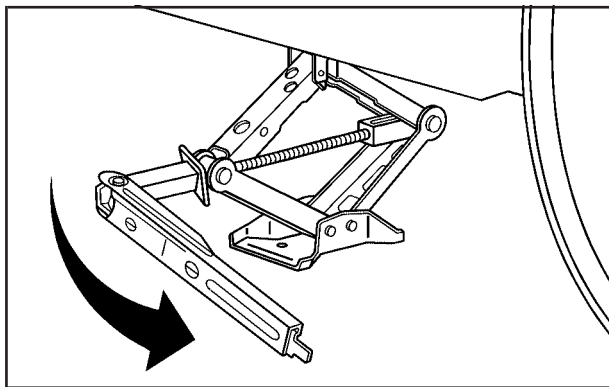

9. Lower the vehicle by turning the jack handle counterclockwise. Lower the jack completely.

⚠ CAUTION:

Incorrect wheel nuts or improperly tightened wheel nuts can cause the wheel to come loose and even come off. This could lead to an accident. Be sure to use the correct wheel nuts. If you have to replace them, be sure to get new GM original equipment wheel nuts. Stop somewhere as soon as you can and have the nuts tightened with a torque wrench to the proper torque specification. See *Capacities and Specifications on page 5-100* for wheel nut torque specification.

Notice: Improperly tightened wheel nuts can lead to brake pulsation and rotor damage. To avoid expensive brake repairs, evenly tighten the wheel nuts in the proper sequence and to the proper torque specification. See *Capacities and Specifications on page 5-100* for the wheel nut torque specification.

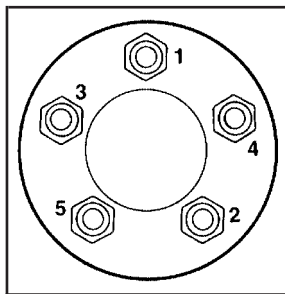

10. Tighten the wheel nuts firmly in a crisscross sequence as shown.

Notice: Wheel covers will not fit on your compact spare. If you try to put a wheel cover on the compact spare, you could damage the cover or the spare.

Do not try to put the wheel cover on your compact spare tire. It will not fit. Store the wheel cover in the trunk until you have the flat tire repaired or replaced.

Storing a Flat or Spare Tire and Tools

CAUTION:

Storing a jack, a tire, or other equipment in the passenger compartment of the vehicle could cause injury. In a sudden stop or collision, loose equipment could strike someone. Store all these in the proper place.

After the compact spare tire has been installed on the vehicle, store the flat tire in the trunk.

When storing a full-size tire, use the extension with the protector, located in the foam holder, to help avoid wheel surface damage.

To store a full-size tire, do the following:

1. Install the tools in their original location in the trunk area and secure.
2. Place the tire valve stem facing down and the protector/guide placed through a wheel bolt hole.
3. Remove the protector and attach the retainer securely.
4. Store the cover as far forward as possible.

When storing a compact spare tire in the trunk, put the protector back in the foam holder.

The compact spare is for temporary use only. Replace the compact spare tire with a full-size tire as soon as you can. See *Compact Spare Tire* on page 5-85. Use the following as a guide for storing the compact spare tire and tools.

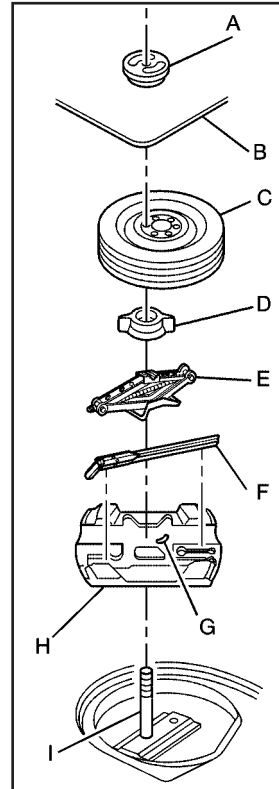

- A. Retainer
- B. Cover
- C. Compact Spare Tire
- D. Wing Nut
- E. Jack
- F. Wheel Wrench
- G. Extension and Protective Guide
- H. Foam Holder
- I. Bolt Screw

Compact Spare Tire

Although the compact spare tire was fully inflated when your vehicle was new, it can lose air after a time. Check the inflation pressure regularly. It should be 60 psi (420 kPa).

After installing the compact spare on your vehicle, you should stop as soon as possible and make sure your spare tire is correctly inflated. The compact spare is made to perform well at speeds up to 65 mph (105 km/h) for distances up to 3,000 miles (5 000 km), so you can finish your trip and have your full-size tire repaired or replaced where you want. You must calibrate the tire inflation monitor system after installing or removing the compact spare. See *Tire Pressure Monitor System on page 5-62* for more information. The system may not work correctly when the compact spare is installed on the vehicle. Of course, it is best to replace your spare with a full-size tire as soon as you can. Your spare will last longer and be in good shape in case you need it again.

Notice: When the compact spare is installed, do not take your vehicle through an automatic car wash with guide rails. The compact spare can get caught on the rails. That can damage the tire and wheel, and maybe other parts of your vehicle.

Do not use your compact spare on other vehicles.

And do not mix your compact spare tire or wheel with other wheels or tires. They will not fit. Keep your spare tire and its wheel together.

Notice: Tire chains will not fit your compact spare. Using them can damage your vehicle and can damage the chains too. Do not use tire chains on your compact spare.

Appearance Care

Cleaning the Inside of Your Vehicle

Your vehicle's interior will continue to look its best if it is cleaned often. Although not always visible, dust and dirt can accumulate on your upholstery. Dirt can damage carpet, fabric, leather, and plastic surfaces. Regular vacuuming is recommended to remove particles from your upholstery. It is important to keep your upholstery from becoming and remaining heavily soiled. Soils should be removed as quickly as possible. Your vehicle's interior may experience extremes of heat that could cause stains to set rapidly.

Lighter colored interiors may require more frequent cleaning. Use care because newspapers and garments that transfer color to your home furnishings may also transfer color to your vehicle's interior.

When cleaning your vehicle's interior, only use cleaners specifically designed for the surfaces being cleaned. Permanent damage may result from using cleaners on surfaces for which they were not intended. Use glass cleaner only on glass. Remove any accidental over-spray from other surfaces immediately. To prevent over-spray, apply cleaner directly to the cleaning cloth.

Notice: If you use abrasive cleaners when cleaning glass surfaces on your vehicle, you could scratch the glass and/or cause damage to the integrated radio antenna and the rear window defogger. When cleaning the glass on your vehicle, use only a soft cloth and glass cleaner.

Many cleaners contain solvents that may become concentrated in your vehicle's breathing space. Before using cleaners, read and adhere to all safety instructions on the label. While cleaning your vehicle's interior, maintain adequate ventilation by opening your vehicle's doors and windows.

Dust may be removed from small buttons and knobs using a small brush with soft bristles.

Your GM dealer has a product for cleaning your vehicle's glass. Should it become necessary, you can also obtain a product from your GM dealer to remove odors from your vehicle's upholstery.

Do not clean your vehicle using the following cleaners or techniques:

- Never use a knife or any other sharp object to remove a soil from any interior surface.
- Never use a stiff brush. It can cause damage to your vehicle's interior surfaces.
- Never apply heavy pressure or rub aggressively with a cleaning cloth. Use of heavy pressure can damage your interior and does not improve the effectiveness of soil removal.
- Use only mild, neutral-pH soaps. Avoid laundry detergents or dishwashing soaps with degreasers. Using too much soap will leave a residue that leaves streaks and attracts dirt. For liquid cleaners, about 20 drops per gallon (3.78 L) of water is a good guide.
- Do not heavily saturate your upholstery while cleaning.
- Damage to your vehicle's interior may result from the use of many organic solvents such as naphtha, alcohol, etc.

Fabric/Carpet

Use a vacuum cleaner with a soft brush attachment frequently to remove dust and loose dirt. A canister vacuum with a beater bar in the nozzle may only be used on floor carpet and carpeted floor mats. For soils, always try to remove them first with plain water or club soda. Before cleaning, gently remove as much of the soil as possible using one of the following techniques:

- For liquids: gently blot the remaining soil with a paper towel. Allow the soil to absorb into the paper towel until no more can be removed.
- For solid dry soils: remove as much as possible and then vacuum.

To clean, use the following instructions:

1. Saturate a lint-free, clean white cloth with water or club soda.
2. Wring the cloth to remove excess moisture.
3. Start on the outside edge of the soil and gently rub toward the center. Continue cleaning, using a clean area of the cloth each time it becomes soiled.
4. Continue to gently rub the soiled area until the cleaning cloth remains clean.
5. If the soil is not completely removed, use a mild soap solution and repeat the cleaning process that was used with plain water.

If any of the soil remains, a commercial fabric cleaner or spot lifter may be necessary. When a commercial upholstery cleaner or spot lifter is to be used, test a small hidden area for colorfastness first. If the locally cleaned area gives any impression that a ring formation may result, clean the entire surface.

After the cleaning process has been completed, a paper towel can be used to blot excess moisture from the fabric or carpet.

Leather

A soft cloth dampened with water may be used to remove dust. If a more thorough cleaning is necessary, a soft cloth dampened with a mild soap solution can be used. Allow the leather to dry naturally. Do not use heat to dry. Never use steam to clean leather. Never use spot lifters or spot removers on leather. Many commercial leather cleaners and coatings that are sold to preserve and protect leather may permanently change the appearance and feel of your leather and are not recommended. Do not use silicone or wax-based products, or those containing organic solvents to clean your vehicle's interior because they can alter the appearance by increasing the gloss in a non-uniform manner. Never use shoe polish on your leather.

Instrument Panel, Vinyl, and Other Plastic Surfaces

A soft cloth dampened with water may be used to remove dust. If a more thorough cleaning is necessary, a clean soft cloth dampened with a mild soap solution can be used to gently remove dust and dirt. Never use spot lifters or removers on plastic surfaces. Many commercial cleaners and coatings that are sold to preserve and protect soft plastic surfaces may permanently change the appearance and feel of your interior and are not recommended. Do not use silicone or wax-based products, or those containing organic solvents to clean your vehicle's interior because they can alter the appearance by increasing the gloss in a non-uniform manner.

Some commercial products may increase gloss on your instrument panel. The increase in gloss may cause annoying reflections in the windshield and even make it difficult to see through the windshield under certain conditions.

Care of Safety Belts

Keep belts clean and dry.

CAUTION:

Do not bleach or dye safety belts. If you do, it may severely weaken them. In a crash, they might not be able to provide adequate protection. Clean safety belts only with mild soap and lukewarm water.

Weatherstrips

Silicone grease on weatherstrips will make them last longer, seal better, and not stick or squeak. Apply silicone grease with a clean cloth. During very cold, damp weather frequent application may be required. See *Recommended Fluids and Lubricants* on page 6-12.

Washing Your Vehicle

The paint finish on the vehicle provides beauty, depth of color, gloss retention, and durability.

The best way to preserve the vehicle's finish is to keep it clean by washing it often with lukewarm or cold water.

Do not wash the vehicle in the direct rays of the sun. Use a car washing soap. Do not use strong soaps or chemical detergents. Be sure to rinse the vehicle well, removing all soap residue completely. GM-approved cleaning products can be obtained from your dealer. See *Vehicle Care/Appearance Materials on page 5-92*. Do not use cleaning agents that are petroleum based, or that contain acid or abrasives. All cleaning agents should be flushed promptly and not allowed to dry on the surface, or they could stain. Dry the finish with a soft, clean chamois or an all-cotton towel to avoid surface scratches and water spotting.

High pressure car washes may cause water to enter the vehicle.

Cleaning Exterior Lamps/Lenses

Use only lukewarm or cold water, a soft cloth and a car washing soap to clean exterior lamps and lenses. Follow instructions under *Washing Your Vehicle on page 5-89*.

Finish Care

Occasional waxing or mild polishing of the vehicle by hand may be necessary to remove residue from the paint finish. GM-approved cleaning products can be obtained from your dealer. See *Vehicle Care/Appearance Materials on page 5-92*.

Notice: Machine compounding or aggressive polishing on a basecoat/clearcoat paint finish may damage it. Use only non-abrasive waxes and polishes that are made for a basecoat/clearcoat paint finish on your vehicle.

The vehicle has a “basecoat/clearcoat” paint finish. The clearcoat gives more depth and gloss to the colored basecoat. Always use waxes and polishes that are non-abrasive and made for a basecoat/clearcoat paint finish.

Foreign materials such as calcium chloride and other salts, ice melting agents, road oil and tar, tree sap, bird droppings, chemicals from industrial chimneys, etc., can damage the vehicle's finish if they remain on painted surfaces. Wash the vehicle as soon as possible. If necessary, use non-abrasive cleaners that are marked safe for painted surfaces to remove foreign matter.

Exterior painted surfaces are subject to aging, weather, and chemical fallout that can take their toll over a period of years. To help keep the paint finish looking new, keep the vehicle in a garage or covered whenever possible.

Windshield and Wiper Blades

If the windshield is not clear after using the windshield washer, or if the wiper blade chatters when running, wax, sap, or other material may be on the blade or windshield.

Clean the outside of the windshield with a glass cleaning liquid or powder and water solution. The windshield is clean if beads do not form when it is rinsed with water.

Grime from the windshield will stick to the wiper blades and affect their performance. Clean the blade by wiping vigorously with a cloth soaked in full-strength windshield washer solvent. Then rinse the blade with water.

Check the wiper blades and clean them as necessary; replace blades that look worn.

Aluminum Wheels

Notice: If you use strong soaps, chemicals, abrasive polishes, cleaners, brushes, or cleaners that contain acid on aluminum or chrome-plated wheels, you could damage the surface of the wheel(s). The repairs would not be covered by your warranty. Use only GM-approved cleaners on aluminum or chrome-plated wheels.

Keep the wheels clean using a soft clean cloth with mild soap and water. Rinse with clean water. After rinsing thoroughly, dry with a soft clean towel. A wax may then be applied.

Notice: Using chrome polish on aluminum wheels could damage the wheels. The repairs would not be covered by your warranty. Use chrome polish on chrome wheels only.

The surface of these wheels is similar to the painted surface of the vehicle. Do not use strong soaps, chemicals, abrasive polishes, abrasive cleaners, cleaners with acid, or abrasive cleaning brushes on them because the surface could be damaged. Do not use chrome polish on aluminum wheels.

Notice: If you drive your vehicle through an automatic car wash that has silicone carbide tire cleaning brushes, you could damage the aluminum or chrome-plated wheels. The repairs would not be covered by your warranty. Never drive a vehicle equipped with aluminum or chrome-plated wheels through an automatic car wash that uses silicone carbide tire cleaning brushes.

Do not take the vehicle through an automatic car wash that has silicone carbide tire cleaning brushes. These brushes can also damage the surface of these wheels.

Tires

To clean the tires, use a stiff brush with tire cleaner.

Notice: Using petroleum-based tire dressing products on your vehicle may damage the paint finish and/or tires. When applying a tire dressing, always wipe off any overspray from all painted surfaces on your vehicle.

Sheet Metal Damage

If the vehicle is damaged and requires sheet metal repair or replacement, make sure the body repair shop applies anti-corrosion material to parts repaired or replaced to restore corrosion protection.

Original manufacturer replacement parts will provide the corrosion protection while maintaining the warranty.

Finish Damage

Any stone chips, fractures or deep scratches in the finish should be repaired right away. Bare metal will corrode quickly and may develop into major repair expense.

Minor chips and scratches can be repaired with touch-up materials available from your GM dealer. Larger areas of finish damage can be corrected in your GM dealer's body and paint shop.

Underbody Maintenance

Chemicals used for ice and snow removal and dust control can collect on the underbody. If these are not removed, corrosion and rust can develop on the underbody parts such as fuel lines, frame, floor pan, and exhaust system even though they have corrosion protection.

At least every spring, flush these materials from the underbody with plain water. Clean any areas where mud and debris can collect. Dirt packed in close areas of the frame should be loosened before being flushed. Your dealer or an underbody car washing system can do this for you.

Chemical Paint Spotting

Some weather and atmospheric conditions can create a chemical fallout. Airborne pollutants can fall upon and attack painted surfaces on the vehicle. This damage can take two forms: blotchy, ring-shaped discolorations, and small, irregular dark spots etched into the paint surface.

Although no defect in the paint job causes this, GM will repair, at no charge to the owner, the surfaces of new vehicles damaged by this fallout condition within 12 months or 12,000 miles (20 000 km) of purchase, whichever occurs first.

Vehicle Care/Appearance Materials

Description	Usage
Polishing Cloth Wax-Treated	Interior and exterior polishing cloth.
Tar and Road Oil Remover	Removes tar, road oil, and asphalt.
Chrome Cleaner and Polish	Use on chrome or stainless steel.
White Sidewall Tire Cleaner	Removes soil and black marks from whitewalls.
Vinyl Cleaner	Cleans vinyl.
Glass Cleaner	Removes dirt, grime, smoke and fingerprints.

Description	Usage
Chrome and Wire Wheel Cleaner	Removes dirt and grime from chrome wheels and wire wheel covers.
Finish Enhancer	Removes dust, fingerprints, and surface contaminants. Spray on and wipe off.
Swirl Remover Polish	Removes swirl marks, fine scratches, and other light surface contamination.
Cleaner Wax	Removes light scratches and protects finish.
Foaming Tire Shine Low Gloss	Cleans, shines, and protects in one step. No wiping necessary.
Wash Wax Concentrate	Medium foaming shampoo. Cleans and lightly waxes. Biodegradable and phosphate free.
Spot Lifter	Quickly removes spots and stains from carpets, vinyl, and cloth upholstery.
Odor Eliminator	Odorless spray odor eliminator used on fabrics, vinyl, leather and carpet.

Vehicle Identification

Vehicle Identification Number (VIN)



This is the legal identifier for your vehicle. It appears on a plate in the front corner of the instrument panel, on the driver's side. You can see it if you look through the windshield from outside your vehicle. The VIN also appears on the Vehicle Certification and Service Parts labels and the certificates of title and registration.

Engine Identification

The eighth character in the VIN is the engine code. This code will help you identify your vehicle's engine, specifications, and replacement parts.

Service Parts Identification Label

You will find this label in the trunk. It is very helpful if you ever need to order parts. On this label, you will find the following:

- VIN
- Model designation
- Paint information
- Production options and special equipment

Be sure that this label is not removed from the vehicle.

Electrical System

Add-On Electrical Equipment

Notice: Don't add anything electrical to your vehicle unless you check with your dealer first. Some electrical equipment can damage your vehicle and the damage wouldn't be covered by your warranty. Some add-on electrical equipment can keep other components from working as they should.

Your vehicle has an airbag system. Before attempting to add anything electrical to your vehicle, see *Servicing Your Airbag-Equipped Vehicle* on page 1-65.

Headlamp Wiring

The headlamp circuit is protected by individual fuses in the underhood fuse block. An electrical overload will cause the fuse to blow. If this happens, have your headlamp system checked right away.

Windshield Wiper Fuses

The windshield wiper motor is protected by a fuse. If the motor overheats due to heavy snow, etc., the wiper will stop until the motor cools. If the overload is caused by some electrical problem, have it fixed.

Power Windows and Other Power Options

A circuit breaker in the instrument panel fuse block protects the power windows and other power accessories. When the current load is too heavy, the circuit breaker opens and closes, protecting the circuit until the problem is fixed.

Fuses and Circuit Breakers

The wiring circuits in your vehicle are protected from short circuits by a combination of fuses and circuit breakers. This greatly reduces the chance of fires caused by electrical problems.

Look at the silver-colored band inside the fuse. If the band is broken or melted, replace the fuse. Be sure you replace a bad fuse with a new one of the identical size and rating.

Instrument Panel Fuse Block

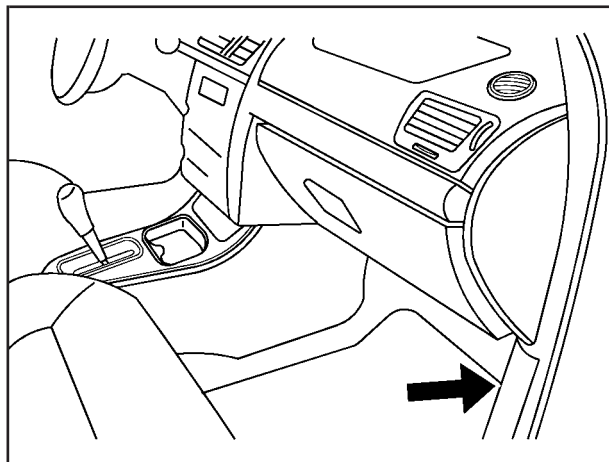

The fuse block is located on the passenger side of the vehicle in the carpet molding. Remove the fuse block door to access the fuses.

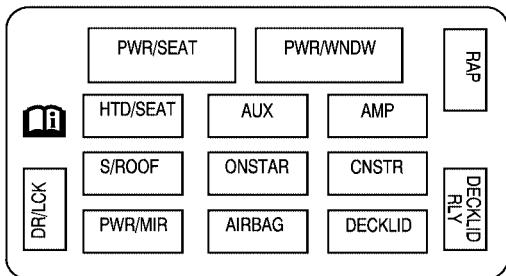

Fuses	Usage
CNSTR	Canister
DR/LCK	Door Locks
PWR/MIR	Power Mirrors
AIRBAG	Airbags
DECKLID	Trunk

Fuses	Usage
DECKLID RLY	Trunk Relay

Fuses	Usage
PWR/SEAT	Power Seats
PWR/WNDW	Power Window
RAP	Retained Accessory Power
HTD/SEAT	Heated Seats
AUX	Auxiliary Outlets
AMP	Amplifier
S/ROOF	Sunroof
ONSTAR	OnStar®

Underhood Fuse Block

The underhood fuse block is located in the engine compartment. See *Engine Compartment Overview* on page 5-12 for more information on location.

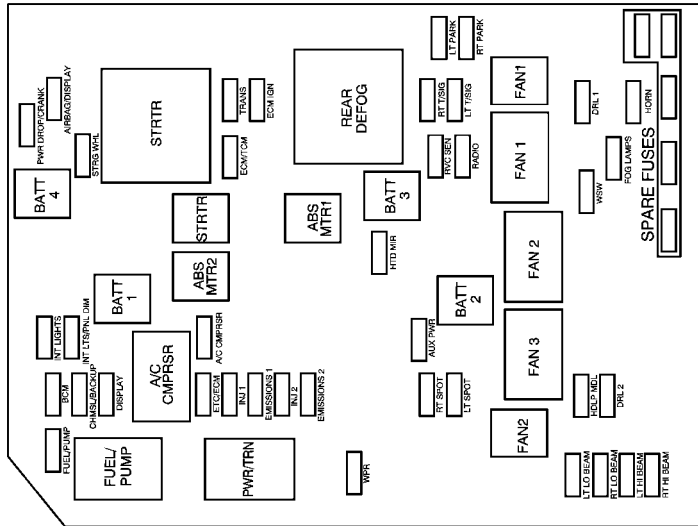

Fuses	Usage
LT PARK	Driver's Side Parking Lamp
RT PARK	Passenger's Side Parking Lamp

Fuses	Usage
FAN 1	Cooling Fan 1
SPARE	Spare

Fuses	Usage
SPARE	Spare
AIRBAG/ DISPLAY	Airbag, Display
TRANS	Transaxle
ECM IGN	Engine Control Module, Ignition
RT T/SIG	Passenger's Side Turn Signal
LT T/SIG	Driver's Side Turn Signal
DRL 1	Daytime Running Lamps 1
HORN	Horn
SPARE	Spare
PWR DROP/ RANK	Power Drop, Crank
STRG WHL	Steering Wheel
ECM/TCM	Engine Control Module, Transmission Control Module
RVC SEN	Regulated Voltage Control Sensor
RADIO	Audio System
FOG LAMPS	Fog Lamps

Fuses	Usage
SPARE	Spare
BATT 4	Battery 4
STRTR	Starter
ABS MTR1	Anti-lock Brake System Motor 1
BATT 3	Battery 3
WSW	Windshield Wiper
HTD MIR	Heated Mirror
SPARE	Spare
BATT 1	Battery 1
ABS MTR2	Anti-lock Brake System Motor 2
BATT 2	Battery 2
INT LIGHTS	Interior Lamps
INT LTS/ NL DIM	Interior Lamps, Instrument Panel Dimmer
A/C CMPRSR	Air Conditioning Compressor
AUX PWR	Auxiliary Power

Fuses	Usage
BCM	Body Control Module
CHMSL/ BACKUP	Center High-Mounted Stoplamp, Back-up Lamps
DISPLAY	Display
ETC/ECM	Electronic Throttle Control, Engine Control Module
INJ 1	Injector 1
EMISSIONS 1	Emissions 1
INJ 2	Injector 2
EMISSIONS 2	Emissions 2
RT SPOT	Right Spot
LT SPOT	Left Spot
HDLP MDL	Headlamp Module
DRL 2	Daytime Running Lamps 2
FAN 2	Cooling Fan 2
FUEL/PUMP	Fuel Pump
WPR	Wiper

Fuses	Usage
LT LO BEAM	Driver's Side Low Beam
RT LO BEAM	Passenger's Side Low Beam
LT HI BEAM	Driver's Side High Beam
RT HI BEAM	Passenger's Side High Beam

Relay	Usage
STRTR	Starter
REAR DEFOG	Rear Defogger
FAN 1	Cooling Fan 1
FAN 2	Cooling Fan 2
A/C CMPRSR	Air Conditioning Compressor
FAN 3	Cooling Fan 3
FUEL/PUMP	Fuel Pump
PWR/TRN	Powertrain

Capacities and Specifications

The following approximate capacities are given in English and metric conversions. See *Recommended Fluids and Lubricants* on page 6-12 for more information.

Application	Capacities	
	English	Metric
Air Conditioning Refrigerant R134a		
3.5L V6 Engine, 3.5L V6 Flexible Fuel and 3.9L V6 Engine	1.35 lb	.61 kg
5.3L V8 Engine	1.21 lb	.55 kg
Automatic Transaxle		
Pan Removal and Replacement	7.6 qt	7.2 L
Cooling System		
3.5L V6, 3.5L V6 Flex Fuel and 3.9L V6 Engines	12.2 qt	11.6 L
5.3L V8 Engine	12.8 qt	12.1 L
Engine Oil with Filter		
3.5L V6, 3.5L V6 Flex Fuel and 3.9L Engines	4.0 qt	3.8 L
5.3L V8 Engine	6.0 qt	5.7 L
Fuel Tank	17.5 gal	66.2 L
Wheel Nut Torque	100 lb-ft	140 Nm
All capacities are approximate. When adding, be sure to fill to the approximate level, as recommended in this manual. Recheck fluid level after filling.		

Engine Specifications

Engine	VIN Code	Transaxle	Spark Plug Gap
3.5L V6	N	Automatic	.040 in (1.01 mm)
3.5L V6 Flex Fuel	K	Automatic	.040 in (1.01 mm)
3.9L V6	1	Automatic	.040 in (1.01 mm)
5.3 L V8	C	Automatic	.040 in (1.01 mm)

NOTES

Section 6 Maintenance Schedule

Maintenance Schedule	6-2	Owner Checks and Services	6-8
Introduction	6-2	At Each Fuel Fill	6-8
Maintenance Requirements	6-2	At Least Once a Month	6-9
Your Vehicle and the Environment	6-2	At Least Once a Year	6-9
Using the Maintenance Schedule	6-3	Recommended Fluids and Lubricants	6-12
Scheduled Maintenance	6-4	Normal Maintenance Replacement Parts	6-13
Additional Required Services	6-6	Maintenance Record	6-14
Maintenance Footnotes	6-7		

Maintenance Schedule

Introduction

Important: Keep engine oil at the proper level and change as recommended.



Have you purchased the GM Protection Plan? The Plan supplements your new vehicle warranties. See your Warranty and Owner Assistance booklet or your dealer for details.

Maintenance Requirements

Notice: Maintenance intervals, checks, inspections, replacement parts, and recommended fluids and lubricants as prescribed in this manual are necessary to keep your vehicle in good working condition. Any damage caused by failure to follow scheduled maintenance may not be covered by warranty.

Your Vehicle and the Environment

Proper vehicle maintenance not only helps to keep your vehicle in good working condition, but also helps the environment. All recommended maintenance is important. Improper vehicle maintenance can even affect the quality of the air we breathe. Improper fluid levels or the wrong tire inflation can increase the level of emissions from your vehicle. To help protect our environment, and to keep your vehicle in good condition, be sure to maintain your vehicle properly.

Using the Maintenance Schedule

We at General Motors want to help you keep your vehicle in good working condition. But we do not know exactly how you will drive it. You may drive very short distances only a few times a week. Or you may drive long distances all the time in very hot, dusty weather. You may use your vehicle in making deliveries. Or you may drive it to work, to do errands, or in many other ways.

Because of all the different ways people use their vehicles, maintenance needs vary. You may need more frequent checks and replacements. So please read the following and note how you drive. If you have any questions on how to keep your vehicle in good condition, see your GM Goodwrench[®] dealer.

This schedule is for vehicles that:

- carry passengers and cargo within recommended limits. You will find these limits on the tire and loading information label. See *Loading Your Vehicle* on page 4-29.
- are driven on reasonable road surfaces within legal driving limits.
- use the recommended fuel. See *Gasoline Octane* on page 5-5.

The services in *Scheduled Maintenance* on page 6-4 should be performed when indicated. See *Additional Required Services* on page 6-6 and *Maintenance Footnotes* on page 6-7 for further information.

CAUTION:

Performing maintenance work on a vehicle can be dangerous. In trying to do some jobs, you can be seriously injured. Do your own maintenance work only if you have the required know-how and the proper tools and equipment for the job. If you have any doubt, see your GM Goodwrench[®] dealer to have a qualified technician do the work.

Some maintenance services can be complex. So, unless you are technically qualified and have the necessary equipment, you should have your GM Goodwrench[®] dealer do these jobs.

When you go to your GM Goodwrench[®] dealer for your service needs, you will know that GM-trained and supported service technicians will perform the work using genuine GM parts.

If you want to purchase service information, see *Service Publications Ordering Information* on page 7-15.

Owner Checks and Services on page 6-8 tells you what should be checked, when to check it, and what you can easily do to help keep your vehicle in good condition.

The proper replacement parts, fluids, and lubricants to use are listed in *Recommended Fluids and Lubricants on page 6-12* and *Normal Maintenance Replacement Parts on page 6-13*. When your vehicle is serviced, make sure these are used. All parts should be replaced and all necessary repairs done before you or anyone else drives the vehicle. We recommend the use of genuine GM parts.

Scheduled Maintenance

When the CHANGE ENGINE OIL SOON message comes on, it means that service is required for your vehicle. Have your vehicle serviced as soon as possible within the next 600 miles (1 000 km). It is possible that, if you are driving under the best conditions, the engine oil life system may not indicate that vehicle service is necessary for over a year. However, your engine oil and filter must be changed at least once a year and at this time the system must be reset. Your GM Goodwrench® dealer has GM-trained service technicians who will perform this work using genuine GM parts and reset the system.

If the engine oil life system is ever reset accidentally, you must service your vehicle within 3,000 miles (5 000 km) since your last service. Remember to reset the oil life system whenever the oil is changed. See *Engine Oil Life System on page 5-20* for information on the Engine Oil Life System and resetting the system.

When the CHANGE ENGINE OIL SOON message appears, certain services, checks, and inspections are required. Required services are described in the following for “Maintenance I” and “Maintenance II.” Generally, it is recommended that your first service be Maintenance I, your second service be Maintenance II, and that you alternate Maintenance I and Maintenance II thereafter. However, in some cases, Maintenance II may be required more often.

Maintenance I — Use Maintenance I if the CHANGE ENGINE OIL SOON message comes on within 10 months since the vehicle was purchased or Maintenance II was performed.

Maintenance II — Use Maintenance II if the previous service performed was Maintenance I. Always use Maintenance II whenever the CHANGE ENGINE OIL SOON message comes on 10 months or more since the last service or if the message has not come on at all for one year.

Scheduled Maintenance

Service	Maintenance I	Maintenance II
Change engine oil and filter. See <i>Engine Oil</i> on page 5-17. Reset oil life system. See <i>Engine Oil Life System</i> on page 5-20. An <i>Emission Control Service</i> .	•	•
Visually check for any leaks or damage. See <i>footnote (k)</i> .	•	•
Inspect engine air cleaner filter. If necessary, replace filter. See <i>Engine Air Cleaner/Filter</i> on page 5-22. See <i>footnote (m)</i> .		•
Rotate tires and check inflation pressures and wear. See <i>Tire Inspection and Rotation</i> on page 5-66 and “Tire Wear Inspection” in <i>At Least Once a Month</i> on page 6-9.	•	•
Inspect brake system. See <i>footnote (a)</i> .	•	•
Check engine coolant and windshield washer fluid levels and add fluid as needed.	•	•
Perform any needed additional services. See “Additional Required Services” in this section.	•	•
Inspect suspension and steering components. See <i>footnote (b)</i> .		•
Inspect engine cooling system. See <i>footnote (c)</i> .		•
Inspect wiper blades. See <i>footnote (d)</i> .		•
Inspect restraint system components. See <i>footnote (e)</i> .		•
Lubricate body components. See <i>footnote (f)</i> .		•
Check transaxle fluid level and add fluid as needed.		•
Replace passenger compartment air filter, if equipped. See <i>footnote (g)</i> .		•
Inspect throttle system. See <i>footnote (j)</i> .		•

Additional Required Services

The following services should be performed at the first maintenance service (I or II) after the indicated miles (kilometers) shown for each item.

Additional Required Services

Service and Miles (Kilometers)	25,000 (40 000)	50,000 (80 000)	75,000 (120 000)	100,000 (160 000)	125,000 (200 000)	150,000 (240 000)
Inspect fuel system for damage or leaks.	•	•	•	•	•	•
Inspect exhaust system for loose or damaged components.	•	•	•	•	•	•
Replace engine air cleaner filter. See <i>Engine Air Cleaner/Filter on page 5-22.</i>		•		•		•
Change automatic transaxle fluid and filter (severe service). See <i>footnote (h).</i>		•		•		•
Change automatic transaxle fluid and filter (normal service).				•		
Replace spark plugs and inspect spark plug wires. <i>An Emission Control Service.</i>				•		
Engine cooling system service (or every five years, whichever occurs first). <i>An Emission Control Service. See footnote (i).</i>						•
Inspect engine accessory drive belt. <i>An Emission Control Service. See footnote (n).</i>						•

Maintenance Footnotes

† *The U.S. Environmental Protection Agency or the California Air Resources Board has determined that the failure to perform this maintenance item will not nullify the emission warranty or limit recall liability prior to the completion of the vehicle's useful life. We, however, urge that all recommended maintenance services be performed at the indicated intervals and the maintenance be recorded.*

(a) *Visually inspect brake lines and hoses for proper hook-up, binding, leaks, cracks, chafing, etc. Inspect disc brake pads for wear and rotors for surface condition. Inspect other brake parts, including calipers, parking brake, etc.*

(b) *Visually inspect front and rear suspension and steering system for damaged, loose, or missing parts or signs of wear. Inspect power steering lines and hoses for proper hook-up, binding, leaks, cracks, chafing, etc.*

(c) *Visually inspect hoses and have them replaced if they are cracked, swollen, or deteriorated. Inspect all pipes, fittings, and clamps; replace with genuine GM parts as needed. To help ensure proper operation, a pressure test of the cooling system and pressure cap and cleaning the outside of the radiator and air conditioning condenser is recommended at least once a year.*

(d) *Visually inspect wiper blades for wear or cracking. Replace wiper blades that appear worn or damaged or that streak or miss areas of the windshield.*

(e) *Make sure the safety belt reminder light and all belts, buckles, latch plates, retractors, and anchorages are working properly. Look for any other loose or damaged safety belt system parts. If you see anything that might keep a safety belt system from doing its job, have it repaired. Have any torn or frayed safety belts replaced. Also look for any opened or broken airbag coverings, and have them repaired or replaced. The airbag system does not need regular maintenance.*

(f) *Lubricate all key lock cylinders. Lubricate all hinges and latches, including those for the body doors, hood, secondary latch, pivots, spring anchor, release pawl, rear compartment, glove box door, console door, and any folding seat hardware. More frequent lubrication may be required when exposed to a corrosive environment. Applying silicone grease on weatherstrips with a clean cloth will make them last longer, seal better, and not stick or squeak.*

(g) *If you drive regularly under dusty conditions, the filter may require replacement more often.*

(h) *Change automatic transaxle fluid and filter if the vehicle is mainly driven under one or more of these conditions:*

- *In heavy city traffic where the outside temperature regularly reaches 90°F (32°C) or higher.*
- *In hilly or mountainous terrain.*
- *When doing frequent trailer towing.*
- *Uses such as found in taxi, police, or delivery service.*

(i) *Drain, flush, and refill cooling system. This service can be complex; you should have your dealer perform this service. See Engine Coolant on page 5-26 for what to use. Inspect hoses. Clean radiator, condenser, pressure cap, and filler neck. Pressure test the cooling system and pressure cap.*

(j) *Check throttle system for interference or binding and for damaged or missing parts. Replace parts as needed. Replace any components that have high effort or excessive wear. Do not lubricate accelerator or cruise control cables.*

(k) *A fluid loss in any vehicle system could indicate a problem. Have the system inspected and repaired and the fluid level checked. Add fluid if needed.*

(m) *If you drive regularly under dusty conditions, inspect the filter at each engine oil change.*

(n) *Visually inspect belt for fraying, excessive cracks, or obvious damage. Replace belt if necessary.*

Owner Checks and Services

These owner checks and services should be performed at the intervals specified to help ensure the safety, dependability, and emission control performance of your vehicle. Your GM Goodwrench® dealer can assist you with these checks and services.

Be sure any necessary repairs are completed at once. Whenever any fluids or lubricants are added to your vehicle, make sure they are the proper ones, as shown in *Recommended Fluids and Lubricants on page 6-12*.

At Each Fuel Fill

It is important to perform these underhood checks at each fuel fill.

Engine Oil Level Check

Check the engine oil level and add the proper oil if necessary. See *Engine Oil on page 5-17* for further details.

Notice: **It is important to check your oil regularly and keep it at the proper level. Failure to keep your engine oil at the proper level can cause damage to your engine not covered by your warranty.**

Engine Coolant Level Check

Check the engine coolant level and add DEX-COOL[®] coolant mixture if necessary. See *Engine Coolant* on page 5-26 for further details.

Windshield Washer Fluid Level Check

Check the windshield washer fluid level in the windshield washer fluid reservoir and add the proper fluid if necessary.

At Least Once a Month

Tire Inflation Check

Visually inspect your vehicle's tires and make sure they are inflated to the correct pressures. Do not forget to check the spare tire. See *Tires* on page 5-54 for further details. Check to make sure the spare tire is stored securely. See *Changing a Flat Tire* on page 5-74.

Tire Wear Inspection

Tire rotation may be required for high mileage highway drivers prior to the Engine Oil Life System service notification. Check the tires for wear and, if necessary, rotate the tires. See *Tire Inspection and Rotation* on page 5-66.

At Least Once a Year

Starter Switch Check

CAUTION:

When you are doing this inspection, the vehicle could move suddenly. If the vehicle moves, you or others could be injured.

1. Before you start, be sure you have enough room around the vehicle.
2. Firmly apply both the parking brake and the regular brake. See *Parking Brake* on page 2-25.
Do not use the accelerator pedal, and be ready to turn off the engine immediately if it starts.
3. Try to start the engine in each gear. The vehicle should start only in PARK (P) or NEUTRAL (N). If the vehicle starts in any other position, contact your GM Goodwrench[®] dealer for service.

Automatic Transaxle Shift Lock Control System Check

CAUTION:

When you are doing this inspection, the vehicle could move suddenly. If the vehicle moves, you or others could be injured.

1. Before you start, be sure you have enough room around the vehicle. It should be parked on a level surface.
2. Firmly apply the parking brake. See *Parking Brake* on page 2-25.

Be ready to apply the regular brake immediately if the vehicle begins to move.

3. With the engine off, turn the ignition to RUN, but do not start the engine. Without applying the regular brake, try to move the shift lever out of PARK (P) with normal effort. If the shift lever moves out of PARK (P), contact your GM Goodwrench® dealer for service.

Ignition Transaxle Lock Check

While parked, and with the parking brake set, try to turn the ignition to OFF in each shift lever position.

- The ignition should turn to OFF only when the shift lever is in PARK (P).
- The key should come out only in OFF.

Contact your GM Goodwrench® dealer if service is required.

Parking Brake and Automatic Transaxle Park (P) Mechanism Check

CAUTION:

When you are doing this check, your vehicle could begin to move. You or others could be injured and property could be damaged. Make sure there is room in front of your vehicle in case it begins to roll. Be ready to apply the regular brake at once should the vehicle begin to move.

Park on a fairly steep hill, with the vehicle facing downhill. Keeping your foot on the regular brake, set the parking brake.

- To check the parking brake's holding ability: With the engine running and transaxle in NEUTRAL (N), slowly remove foot pressure from the regular brake pedal. Do this until the vehicle is held by the parking brake only.
- To check the PARK (P) mechanism's holding ability: With the engine running, shift to PARK (P). Then release the parking brake followed by the regular brake.

Contact your GM Goodwrench® dealer if service is required.

Underbody Flushing Service

At least every spring, use plain water to flush any corrosive materials from the underbody. Take care to clean thoroughly any areas where mud and other debris can collect.

Recommended Fluids and Lubricants

Fluids and lubricants identified below by name, part number, or specification may be obtained from your dealer.

Usage	Fluid/Lubricant
Engine Oil	Engine oil which meets GM Standard GM6094M and displays the American Petroleum Institute Certified for Gasoline Engines starburst symbol. GM Goodwrench [®] oil meets all the requirements for your vehicle. To determine the proper viscosity for your vehicle's engine, see <i>Engine Oil on page 5-17</i> .
Engine Coolant	50/50 mixture of clean, drinkable water and use only DEX-COOL [®] Coolant. See <i>Engine Coolant on page 5-26</i> .
Hydraulic Brake System	Delco [®] Supreme 11 Brake Fluid or equivalent DOT-3 brake fluid.

Usage	Fluid/Lubricant
Windshield Washer	GM Optikleen [®] Washer Solvent.
Power Steering System	GM Power Steering Fluid (GM Part No. U.S. 89021184, in Canada 89021186).
Automatic Transaxle	DEXRON [®] -VI Automatic Transmission Fluid.
Key Lock Cylinders	Multi-Purpose Lubricant, Superlube (GM Part No. U.S. 12346241, in Canada 10953474).
Hood Latch Assembly, Secondary Latch, Pivots, Spring Anchor, and Release Pawl	Lubriplate Lubricant Aerosol (GM Part No. U.S. 12346293, in Canada 992723) or lubricant meeting requirements of NLGI #2, Category LB or GC-LB.
Hood and Door Hinges	Multi-Purpose Lubricant, Superlube (GM Part No. U.S. 12346241, in Canada 10953474).
Weatherstrip Conditioning	Dielectric Silicone Grease (GM Part No. U.S. 12345579, in Canada 992887).

Normal Maintenance Replacement Parts

Replacement parts identified below by name, part number, or specification can be obtained from your GM dealer.

Normal Maintenance Replacement Parts

Part	GM Part Number	AC Delco Part Number
Automatic Transaxle Filter	24224522	—
Engine Air Cleaner/Filter	10350737	—
Engine Oil Filter		
3.5L V6, 3.9L V6 and 3.5L Flexible Fuel V6 Engines	89017342	PF61
5.3L V8 Engine	88984215	PF46
Passenger Compartment Air Filter	15284938	CF132
Spark Plugs		
3.5L V6, 3.5L Flexible Fuel and 3.9L V6 Engine	12591131	41-100
5.3L V8 Engine	12571164	41-985
Windshield Wiper Blades 21.6 inches (55.0 cm)		
Driver's Side	19120353	—
Passenger's Side	19120354	—

Maintenance Record

After the scheduled services are performed, record the date, odometer reading, who performed the service, and the type of services performed in the boxes provided. See *Maintenance Requirements on page 6-2*. Any additional information from *Owner Checks and Services on page 6-8* can be added on the following record pages. You should retain all maintenance receipts.

Maintenance Record

Date	Odometer Reading	Serviced By	Maintenance I or Maintenance II	Services Performed

Maintenance Record (cont'd)

Date	Odometer Reading	Serviced By	Maintenance I or Maintenance II	Services Performed

Maintenance Record (cont'd)

Date	Odometer Reading	Serviced By	Maintenance I or Maintenance II	Services Performed

Section 7 Customer Assistance and Information

Customer Assistance and Information	7-2	Reporting Safety Defects	7-14
Customer Satisfaction Procedure	7-2	Reporting Safety Defects to the United States Government	7-14
Online Owner Center	7-3	Reporting Safety Defects to the Canadian Government	7-14
Customer Assistance for Text Telephone (TTY) Users	7-4	Reporting Safety Defects to General Motors	7-14
Customer Assistance Offices	7-4	Service Publications Ordering Information	7-15
GM Mobility Reimbursement Program	7-5		
Roadside Assistance Program	7-5		
Courtesy Transportation	7-7		
Vehicle Data Collection and Event Data Recorders	7-9		
Collision Damage Repair	7-10		

Customer Assistance and Information

Customer Satisfaction Procedure

Your satisfaction and goodwill are important to your dealer and to Chevrolet. Normally, any concerns with the sales transaction or the operation of your vehicle will be resolved by your dealer's sales or service departments. Sometimes, however, despite the best intentions of all concerned, misunderstandings can occur. If your concern has not been resolved to your satisfaction, the following steps should be taken:

STEP ONE: Discuss your concern with a member of dealership management. Normally, concerns can be quickly resolved at that level. If the matter has already been reviewed with the sales, service or parts manager, contact the owner of the dealership or the general manager.

STEP TWO: If after contacting a member of dealership management, it appears your concern cannot be resolved by the dealership without further help, contact the Chevrolet Customer Assistance Center by calling 1-800-222-1020. In Canada, contact GM of Canada Customer Communication Centre by calling 1-800-263-3777 (English) or 1-800-263-7854 (French).

We encourage you to call the toll-free number in order to give your inquiry prompt attention. Please have the following information available to give the Customer Assistance Representative:

- Vehicle Identification Number (VIN). This is available from the vehicle registration or title, or the plate at the top left of the instrument panel and visible through the windshield.
- Dealership name and location.
- Vehicle delivery date and present mileage (kilometers).

When contacting Chevrolet, please remember that your concern will likely be resolved at a dealer's facility. That is why we suggest you follow Step One first if you have a concern.

STEP THREE: Both General Motors and your dealer are committed to making sure you are completely satisfied with your new vehicle. However, if you continue to remain unsatisfied after following the procedure outlined in Steps One and Two, you should file with the BBB Auto Line Program to enforce any additional rights you may have. Canadian owners refer to your Warranty and Owner Assistance Information booklet for information on the Canadian Motor Vehicle Arbitration Plan (CAMVAP).

The BBB Auto Line Program is an out of court program administered by the Council of Better Business Bureaus to settle automotive disputes regarding vehicle repairs or the interpretation of the New Vehicle Limited Warranty. Although you may be required to resort to this informal dispute resolution program prior to filing a court action, use of the program is free of charge and your case will generally be heard within 40 days. If you do not agree with the decision given in your case, you may reject it and proceed with any other venue for relief available to you.

You may contact the BBB Auto Line Program using the toll-free telephone number or write them at the following address:

BBB Auto Line Program
Council of Better Business Bureaus, Inc.
4200 Wilson Boulevard
Suite 800
Arlington, VA 22203-1838
Telephone: 1-800-955-5100

This program is available in all 50 states and the District of Columbia. Eligibility is limited by vehicle age, mileage, and other factors. General Motors reserves the right to change eligibility limitations and/or discontinue its participation in this program.

Online Owner Center

The Owner Center is a resource for your GM ownership needs. Specific vehicle information can be found in one place.

The Online Owner Center allows you to:

- Get e-mail service reminders.
- Access information about your specific vehicle, including tips and videos and an electronic version of this owner's manual (United States only).
- Keep track of your vehicle's service history and maintenance schedule.
- Find GM dealers for service nationwide.
- Receive special promotions and privileges only available to members (United States only).

Refer to the web for updated information.

To register your vehicle, visit www.MyGMLink.com (United States) or My GM Canada within www.gmcanada.com (Canada).

Customer Assistance for Text Telephone (TTY) Users

To assist customers who are deaf, hard of hearing, or speech-impaired and who use Text Telephones (TTYs), Chevrolet has TTY equipment available at its Customer Assistance Center. Any TTY user can communicate with Chevrolet by dialing: 1-800-833-CHEV (2438). (TTY users in Canada can dial 1-800-263-3830.)

Customer Assistance Offices

Chevrolet encourages customers to call the toll-free number for assistance. However, if a customer wishes to write or e-mail Chevrolet, refer to the addresses below.

United States — Customer Assistance

Chevrolet Motor Division
Chevrolet Customer Assistance Center
P.O. Box 33170
Detroit, MI 48232-5170

www.Chevrolet.com
1-800-222-1020
1-800-833-2438 (For Text Telephone devices (TTYs))
Roadside Assistance: 1-800-CHEV-USA (243-8872)
Fax Number: 313-381-0022

From Puerto Rico:
1-800-496-9992 (English)
1-800-496-9993 (Spanish)
Fax Number: 313-381-0022

From U.S. Virgin Islands:
1-800-496-9994
Fax Number: 313-381-0022

Canada — Customer Assistance

General Motors of Canada Limited
Customer Communication Centre, 163-005
1908 Colonel Sam Drive
Oshawa, Ontario L1H 8P7

1-800-263-3777 (English)
1-800-263-7854 (French)
1-800-263-3830 (For Text Telephone devices (TTYs))
Roadside Assistance: 1-800-268-6800

Overseas — Customer Assistance

Please contact the local General Motors Business Unit.

Mexico, Central America and Caribbean Islands/Countries (Except Puerto Rico and U.S. Virgin Islands) — Customer Assistance

General Motors de Mexico, S. de R.L. de C.V.
Customer Assistance Center
Paseo de la Reforma # 2740
Col. Lomas de Bezares
C.P. 11910, Mexico, D.F.
01-800-508-0000
Long Distance: 011-52-53 29 0 800

GM Mobility Reimbursement Program



This program, available to qualified applicants, can reimburse you up to \$1,000 of the cost of eligible aftermarket adaptive equipment required for your vehicle, such as hand controls or a wheelchair/scooter lift.

The offer is available for a very limited period of time from the date of vehicle purchase/lease. For more details, or to determine your vehicle's eligibility, visit gmmobility.com or call the GM Mobility Assistance Center at 1-800-323-9935. Text telephone (TTY) users, call 1-800-833-9935.

GM of Canada also has a Mobility Program. Call 1-800-GM-DRIVE (463-7483) for details. TTY users call 1-800-263-3830.

Roadside Assistance Program

As the owner of a new Chevrolet vehicle, you are automatically enrolled in the Chevrolet Roadside Assistance program. This value-added service is intended to provide you with peace of mind as you drive in the city or travel the open road. Call Chevrolet's Roadside Assistance at **1-800-CHEV-USA, (1-800-243-8872)** 24 hours a day, 365 days a year to speak with a Chevrolet Roadside Assistance representative.

We will provide the following services during the Bumper-to-Bumper warranty period, at no expense to you:

- **Fuel Delivery:** Delivery of enough fuel (\$5 maximum) for the customer to get to the nearest service station.
- **Lock-out Service (identification required):** Replacement keys or locksmith service will be covered at no charge if you are unable to gain entry into your vehicle. Delivery of the replacement key will be covered within 10 miles (16 km).
- **Emergency Tow:** Tow to the nearest dealership for warranty service or in the event of a vehicle-disabling accident. Assistance provided when the vehicle is mired in sand, mud, or snow.
- **Flat Tire Change:** Installation of a spare tire will be covered at no charge. The customer is responsible for the repair or replacement of the tire if not covered by a warrantable failure.
- **Jump Start:** No-start occurrences which require a battery jump start will be covered at no charge.
- **Dealer Locator Service**

In many instances, mechanical failures are covered under Chevrolet's Bumper-to-Bumper warranty. However, when other services are utilized, our Roadside Assistance Representatives will explain any payment obligations you might incur.

For prompt and efficient assistance when calling, please provide the following to the Roadside Assistance Representative:

- Your name, home address, and home telephone number.
- Telephone number of your location.
- Location of the vehicle.
- Model, year, color, and license plate number.
- Mileage, Vehicle Identification Number (VIN), and delivery date of the vehicle.
- Description of the problem.

While we hope you never have the occasion to use our service, it is added security while traveling for you and your family. Remember, we are only a phone call away. Chevrolet Roadside Assistance:

1-800-CHEV-USA (1-800-243-8872), text telephone (TTY) users, call **1-888-889-2438**.

Chevrolet reserves the right to limit services or reimbursement to an owner or driver when, in Chevrolet's judgement, the claims become excessive in frequency or type of occurrence.

Roadside Assistance is not part of or included in the coverage provided by the New Vehicle Limited Warranty. Chevrolet reserves the right to make any changes or discontinue the Roadside Assistance program at any time without notification.

Canadian Roadside Assistance

Vehicles purchased in Canada have an extensive roadside assistance program accessible from anywhere in Canada or the United States. Please refer to the Warranty and Owner Assistance Information book.

Courtesy Transportation

To enhance your ownership experience, we and our participating dealers are proud to offer Courtesy Transportation, a customer support program for new vehicles.

The Courtesy Transportation program is offered to customers in conjunction with the Bumper-to-Bumper coverage provided by the New Vehicle Limited Warranty. Several transportation options are available when warranty repairs are required. This will reduce your inconvenience during warranty repairs.

Scheduling Service Appointments

When your vehicle requires warranty service, you should contact your dealer and request an appointment. By scheduling a service appointment and advising your service consultant of your transportation needs, your dealer can help minimize your inconvenience.

If your vehicle cannot be scheduled into the service department immediately, keep driving it until it can be scheduled for service, unless, of course, the problem is safety-related. If it is, please call your dealership, let them know this, and ask for instructions.

If the dealer requests that you simply drop the vehicle off for service, you are urged to do so as early in the work day as possible to allow for the same day repair.

Transportation Options

Warranty service can generally be completed while you wait. However, if you are unable to wait, GM helps to minimize your inconvenience by providing several transportation options. Depending on the circumstances, your dealer can offer you one of the following:

Shuttle Service

Participating dealers can provide you with shuttle service to get you to your destination with minimal interruption of your daily schedule. This includes one-way or round trip shuttle service to a destination up to 10 miles (16 km) from the dealership.

Public Transportation or Fuel Reimbursement

If your vehicle requires overnight warranty repairs, reimbursement of public transportation expenses may be available, for up to a maximum of five days. In addition, should you arrange transportation through a friend or relative, reimbursement for reasonable fuel expenses may be available, up to a five-day maximum. Claim amounts should reflect actual costs and be supported by original receipts.

Courtesy Rental Vehicle

Your dealer may arrange to provide you with a courtesy rental vehicle or reimburse you for a rental vehicle that you obtain if your vehicle is kept for a warranty repair. Reimbursement will be limited to a maximum amount per day and must be supported by receipts. This requires that you sign and complete a rental agreement and meet state, local and rental vehicle provider requirements. Requirements vary and may include minimum age requirements, insurance coverage, credit card, etc. You are responsible for fuel usage charges and may also be responsible for taxes, levies, usage fees, excessive mileage or rental usage beyond the completion of the repair.

Generally it is not possible to provide a like-vehicle as a courtesy rental.

Additional Program Information

Courtesy Transportation is available during the Bumper-to-Bumper warranty coverage period, but it is not part of the New Vehicle Limited Warranty. A separate booklet entitled *Warranty and Owner Assistance Information* furnished with each new vehicle provides detailed warranty coverage information.

Courtesy Transportation is available only at participating dealers and all program options, such as shuttle service, may not be available at every dealer. Please contact your dealer for specific information about availability. All Courtesy Transportation arrangements will be administered by appropriate dealer personnel.

Canadian Vehicles: For warranty repairs during the Complete Vehicle Coverage period of the General Motors of Canada New Vehicle Limited Warranty, alternative transportation may be available under the Courtesy Transportation Program. Please consult your dealer for details.

General Motors reserves the right to unilaterally modify, change or discontinue Courtesy Transportation at any time and to resolve all questions of claim eligibility pursuant to the terms and conditions described herein at its sole discretion.

Vehicle Data Collection and Event Data Recorders

Your vehicle, like other modern motor vehicles, has a number of sophisticated computer systems that monitor and control several aspects of the vehicle's performance. Your vehicle uses on-board vehicle computers to monitor emission control components to optimize fuel economy, to monitor conditions for airbag deployment and, if so equipped, to provide anti-lock braking and to help the driver control the vehicle in difficult driving situations. Some information may be stored during regular operations to facilitate repair of detected malfunctions; other information is stored only in a crash event by computer systems, such as those commonly called event data recorders (EDR).

In a crash event, computer systems, such as the Airbag Sensing and Diagnostic Module (SDM) in your vehicle may record information about the condition of the vehicle and how it was operated, such as data related to engine speed, brake application, throttle position, vehicle speed, safety belt usage, airbag readiness, airbag performance, and the severity of a collision. This information has been used to improve vehicle crash performance and may be used to improve crash performance of future vehicles and driving safety. Unlike the data recorders on many airplanes, these on-board systems do not record sounds, such as conversation of vehicle occupants.

To read this information, special equipment is needed and access to the vehicle or the device that stores the data is required. GM will not access information about a crash event or share it with others other than:

- with the consent of the vehicle owner or, if the vehicle is leased, with the consent of the lessee,
- in response to an official request of police or similar government office,
- as part of GM's defense of litigation through the discovery process, or
- as required by law.

In addition, once GM collects or receives data, GM may:

- use the data for GM research needs,
- make it available for research where appropriate confidentiality is to be maintained and need is shown, or
- share summary data which is not tied to a specific vehicle with non-GM organizations for research purposes.

Others, such as law enforcement, may have access to the special equipment that can read the information if they have access to the vehicle or the device that stores the data.

If your vehicle is equipped with OnStar[®], please check the OnStar[®] subscription service agreement or manual for information on its operations and data collection.

Collision Damage Repair

If your vehicle is involved in a collision and it is damaged, have the damage repaired by a qualified technician using the proper equipment and quality replacement parts. Poorly performed collision repairs will diminish your vehicle's resale value, and safety performance can be compromised in subsequent collisions.

Collision Parts

Genuine GM Collision parts are new parts made with the same materials and construction methods as the parts with which your vehicle was originally built. Genuine GM Collision parts are your best choice to assure that your vehicle's designed appearance, durability and safety are preserved. The use of Genuine GM parts can help maintain your GM New Vehicle Warranty.

Recycled original equipment parts may also be used for repair. These parts are typically removed from vehicles that were total losses in prior accidents. In most cases, the parts being recycled are from undamaged sections of the vehicle. A recycled original equipment GM part, may be an acceptable choice to maintain your vehicle's originally designed appearance and safety performance, however, the history of these parts is not known. Such parts are not covered by your GM New Vehicle Limited Warranty, and any related failures are not covered by that warranty.

Aftermarket collision parts are also available. These are made by companies other than GM and may not have been tested for your vehicle. As a result, these parts may fit poorly, exhibit premature durability/corrosion problems, and may not perform properly in subsequent collisions. Aftermarket parts are not covered by your GM New Vehicle Limited Warranty, and any vehicle failure related to such parts are not covered by that warranty.

Repair Facility

GM also recommends that you choose a collision repair facility that meets your needs before you ever need collision repairs. Your GM dealer may have a collision repair center with GM-trained technicians and state of the art equipment, or be able to recommend a collision repair center that has GM-trained technicians and comparable equipment.

Insuring Your Vehicle

Protect your investment in your GM vehicle with comprehensive and collision insurance coverage. There are significant differences in the quality of coverage afforded by various insurance policy terms. Many insurance policies provide reduced protection to your GM vehicle by limiting compensation for damage repairs by using aftermarket collision parts. Some insurance companies will not specify aftermarket collision parts. When purchasing insurance, we recommend that you assure your vehicle will be repaired with GM original equipment collision parts. If such insurance coverage is not available from your current insurance carrier, consider switching to another insurance carrier.

If your vehicle is leased, the leasing company may require you to have insurance that assures repairs with Genuine GM Original Equipment Manufacturer (OEM) parts or Genuine Manufacturer replacement parts. Read your lease carefully, as you may be charged at the end of your lease for poor quality repairs.

If an Accident Occurs

Here is what to do if you are involved in an accident.

- Try to relax and then check to make sure you are all right. If you are uninjured, make sure that no one else in your vehicle, or the other vehicle, is injured.
- If there has been an injury, call 911 for help. Do not leave the scene of an accident until all matters have been taken care of. Move your vehicle only if its position puts you in danger or you are instructed to move it by a police officer.
- Give only the necessary and requested information to police and other parties involved in the accident. Do not discuss your personal condition, mental frame of mind, or anything unrelated to the accident. This will help guard against post-accident legal action.
- If you need roadside assistance, call GM Roadside Assistance. See *Roadside Assistance Program on page 7-5* for more information.
- If your vehicle cannot be driven, know where the towing service will be taking it. Get a card from the tow truck operator or write down the driver's name, the service's name, and the phone number.
- Remove any valuables from your vehicle before it is towed away. Make sure this includes your insurance information and registration if you keep these items in your vehicle.
- Gather the important information you will need from the other driver. Things like name, address, phone number, driver's license number, vehicle license plate, vehicle make, model and model year, Vehicle Identification Number (VIN), insurance company and policy number, and a general description of the damage to the other vehicle.
- If possible, call your insurance company from the scene of the accident. They will walk you through the information they will need. If they ask for a police report, phone or go to the police department headquarters the next day and you can get a copy of the report for a nominal fee. In some states with "no fault" insurance laws, a report may not be necessary. This is especially true if there are no injuries and both vehicles are driveable.

- Choose a reputable collision repair facility for your vehicle. Whether you select a GM dealer or a private collision repair facility to fix the damage, make sure you are comfortable with them. Remember, you will have to feel comfortable with their work for a long time.
- Once you have an estimate, read it carefully and make sure you understand what work will be performed on your vehicle. If you have a question, ask for an explanation. Reputable shops welcome this opportunity.

Managing the Vehicle Damage Repair Process

In the event that your vehicle requires damage repairs, GM recommends that you take an active role in its repair. If you have a pre-determined repair facility of choice, take your vehicle there, or have it towed there. Specify to the facility that any required replacement collision parts be original equipment parts, either new Genuine GM parts or recycled original GM parts. Remember, recycled parts will not be covered by your GM vehicle warranty.

Insurance pays the bill for the repair, but you must live with the repair. Depending on your policy limits, your insurance company may initially value the repair using aftermarket parts. Discuss this with your repair professional, and insist on Genuine GM parts. Remember if your vehicle is leased you may be obligated to have the vehicle repaired with Genuine GM parts, even if your insurance coverage does not pay the full cost.

If another party's insurance company is paying for the repairs, you are not obligated to accept a repair valuation based on that insurance company's collision policy repair limits, as you have no contractual limits with that company. In such cases, you can have control of the repair and parts choices as long as cost stays within reasonable limits.

Reporting Safety Defects

Reporting Safety Defects to the United States Government

If you believe that your vehicle has a defect which could cause a crash or could cause injury or death, you should immediately inform the National Highway Traffic Safety Administration (NHTSA), in addition to notifying General Motors.

If NHTSA receives similar complaints, it may open an investigation, and if it finds that a safety defect exists in a group of vehicles, it may order a recall and remedy campaign. However, NHTSA cannot become involved in individual problems between you, your dealer, or General Motors.

To contact NHTSA, you may call the Vehicle Safety Hotline toll-free at 1-888-327-4236 (TTY: 1-800-424-9153); go to <http://www.safercar.gov>; or write to:

Administrator, NHTSA
400 Seventh Street, SW.
Washington, D.C. 20590

You can also obtain other information about motor vehicle safety from <http://www.safercar.gov>.

Reporting Safety Defects to the Canadian Government

If you live in Canada, and you believe that your vehicle has a safety defect, you should immediately notify Transport Canada, in addition to notifying General Motors of Canada Limited. You may call them at 1-800-333-0510 or write to:

Transport Canada
Place de Ville Tower C
330 Sparks Street
Ottawa, Ontario K1A 0N5

Reporting Safety Defects to General Motors

In addition to notifying NHTSA (or Transport Canada) in a situation like this, we certainly hope you will notify General Motors. Please call the Chevrolet Customer Assistance Center at 1-800-222-1020, or write:

Chevrolet Motor Division
Chevrolet Customer Assistance Center
P.O. Box 33170
Detroit, MI 48232-5170

In Canada, please call us at 1-800-263-3777 (English) or 1-800-263-7854 (French). Or, write:

General Motors of Canada Limited
Customer Communication Centre, 163-005
1908 Colonel Sam Drive
Oshawa, Ontario L1H 8P7

Service Publications Ordering Information

Service Manuals

Service Manuals have the diagnosis and repair information on engines, transmission, axle suspension, brakes, electrical, steering, body, etc.

Transmission, Transaxle, Transfer Case Unit Repair Manual

This manual provides information on unit repair service procedures, adjustments, and specifications for GM transmissions, transaxles, and transfer cases.

Service Bulletins

Service Bulletins give technical service information needed to knowledgeably service General Motors cars and trucks. Each bulletin contains instructions to assist in the diagnosis and service of your vehicle.

In Canada, information pertaining to Product Service Bulletins can be obtained by contacting your General Motors dealer or by calling 1-800-GM-DRIVE (1-800-463-7483).

Owner's Information

Owner publications are written specifically for owners and intended to provide basic operational information about the vehicle. The owner's manual will include the Maintenance Schedule for all models.

In-Portfolio: Includes a Portfolio, Owner's Manual, and Warranty Booklet.

RETAIL SELL PRICE: \$35.00

Without Portfolio: Owner's Manual only.

RETAIL SELL PRICE: \$25.00

Current and Past Model Order Forms

Service Publications are available for current and past model GM vehicles. To request an order form, please specify year and model name of the vehicle.

ORDER TOLL FREE: 1-800-551-4123 Monday-Friday 8:00 AM - 6:00 PM Eastern Time

For Credit Card Orders Only
(VISA-MasterCard-Discover), visit Helm, Inc. on the
World Wide Web at: www.helminc.com

Or you can write to:

Helm, Incorporated
P.O. Box 07130
Detroit, MI 48207

Prices are subject to change without notice and without incurring obligation. Allow ample time for delivery.

Note to Canadian Customers: All listed prices are quoted in U.S. funds. Canadian residents are to make checks payable in U.S. funds.

A

Accessories and Modifications	5-3	Anti-Lock Brake System (ABS)	4-7
Accessory Power Outlet(s)	3-17	Anti-Lock Brake, System Warning Light	3-32
Adding Equipment to Your Airbag-Equipped Vehicle	1-66	Appearance Care	
Additives, Fuel	5-6	Aluminum Wheels	5-90
Add-On Electrical Equipment	5-94	Care of Safety Belts	5-88
Air Cleaner/Filter, Engine	5-22	Chemical Paint Spotting	5-92
Air Conditioning	3-19	Cleaning Exterior Lamps/Lenses	5-89
Airbag		Cleaning the Inside of Your Vehicle	5-85
Passenger Status Indicator	3-28	Fabric/Carpet	5-87
Readiness Light	3-27	Finish Care	5-89
Airbag Sensing and Diagnostic Module (SDM)	7-9	Finish Damage	5-91
Airbag System	1-52	Instrument Panel, Vinyl, and Other Plastic Surfaces	5-88
Adding Equipment to Your Airbag-Equipped Vehicle	1-66	Leather	5-87
How Does an Airbag Restrain?	1-58	Sheet Metal Damage	5-91
Passenger Sensing System	1-60	Tires	5-91
Servicing Your Airbag-Equipped Vehicle	1-65	Underbody Maintenance	5-91
What Makes an Airbag Inflate?	1-58	Vehicle Care/Appearance Materials	5-92
What Will You See After an Airbag Inflates?	1-59	Washing Your Vehicle	5-89
When Should an Airbag Inflate?	1-57	Weatherstrips	5-88
Where Are the Airbags?	1-55	Windshield and Wiper Blades	5-90
Antenna, Backglass	3-85	Ashtray(s)	3-18
Antenna, XM™ Satellite Radio Antenna System	3-85	Audio System(s)	3-59
		Audio Steering Wheel Controls	3-83
		Backglass Antenna	3-85
		Care of Your CD Player	3-84

Audio System(s) (cont.)	
Care of Your CDs	3-84
Radio with CD	3-62, 3-67
Setting the Time	3-60, 3-61
Theft-Deterrent Feature	3-82
Understanding Radio Reception	3-83
XM™ Satellite Radio Antenna System	3-85
Automatic Door Lock	2-10
Automatic Transaxle	
Fluid	5-23
Operation	2-22

B

Backglass Antenna	3-85
Battery	5-42
Run-Down Protection	3-17
Before Leaving on a Long Trip	4-21
Brake	
Anti-Lock Brake System (ABS)	4-7
Emergencies	4-8
Parking	2-25
System Warning Light	3-31
Brakes	5-40
Braking	4-6

Braking in Emergencies	4-8
Break-In, New Vehicle	2-18
Bulb Replacement	5-47
Back-Up Lamps	5-51
Halogen Bulbs	5-47
Headlamp Aiming	5-47
Headlamps, Front Turn Signal, Sidemarker, and Parking Lamps	5-48
Replacement Bulbs	5-51
Taillamps, Stoplamps and Back-Up Lamps	5-50
Buying New Tires	5-68

C

California Fuel	5-5
California Proposition 65 Warning	5-3
Canadian Owners	ii
Capacities and Specifications	5-100
Carbon Monoxide	2-11, 2-28, 4-24, 4-36
Care of	
Safety Belts	5-88
Your CD Player	3-84
Your CDs	3-84
Center Console Storage Area	2-39
Chains, Tire	5-73

Charging System Light	3-30	Cleaning (cont.)	
Check		Underbody Maintenance	5-91
Engine Light	3-34	Washing Your Vehicle	5-89
Checking Things Under the Hood	5-10	Weatherstrips	5-88
Chemical Paint Spotting	5-92	Windshield and Wiper Blades	5-90
Child Restraints		Climate Control System	3-19
Child Restraint Systems	1-36	Air Filter, Passenger Compartment	3-23
Infants and Young Children	1-32	Outlet Adjustment	3-22
Lower Anchors and Tethers for Children	1-41	Collision Damage Repair	7-10
Older Children	1-30	Comfort Guides, Rear Safety Belt	1-27
Securing a Child Restraint in a Rear Seat		Compact Spare Tire	5-85
Position	1-46	Content Theft-Deterrent	2-15
Securing a Child Restraint in the Right		Control of a Vehicle	4-5
Front Seat Position	1-48	Convenience Net	2-39
Where to Put the Restraint	1-39	Coolant	
Cigarette Lighter	3-18	Engine Temperature Gage	3-33
Cleaning		Engine Temperature Warning Light	3-33
Aluminum Wheels	5-90	Heater, Engine	2-20
Exterior Lamps/Lenses	5-89	Cooling System	5-31
Fabric/Carpet	5-87	Courtesy Lamps	3-15
Finish Care	5-89	Cruise Control	3-10
Inside of Your Vehicle	5-85	Cruise Control Light	3-38
Instrument Panel, Vinyl, and Other Plastic		Cupholder(s)	2-39
Surfaces	5-88	Customer Assistance Information	
Leather	5-87	Courtesy Transportation	7-7
Tires	5-91	Customer Assistance for Text Telephone (TTY)	
		Users	7-4

Customer Assistance Information (cont.)	
Customer Assistance Offices	7-4
Customer Satisfaction Procedure	7-2
GM Mobility Reimbursement Program	7-5
Reporting Safety Defects to General Motors	7-14
Reporting Safety Defects to the Canadian Government	7-14
Reporting Safety Defects to the United States Government	7-14
Roadside Assistance Program	7-5
Service Publications Ordering Information	7-15

D

Daytime Running Lamps/Automatic Headlamp System	3-14
Defensive Driving	4-2
Delayed Entry Lighting	3-16
Delayed Exit Lighting	3-16
Delayed Headlamps	3-14
Displacement on Demand™ (DoD™)	2-21
Doing Your Own Service Work	5-4
Dome Lamp	3-15
Door	
Automatic Door Lock	2-10
Locks	2-9

Door (cont.)	
Power Door Locks	2-10
Programmable Automatic Door Unlock	2-11
Driver	
Position, Safety Belt	1-18
Driver Information Center (DIC)	3-39
DIC Operation and Displays	3-40
DIC Vehicle Customization	3-53
DIC Warnings and Messages	3-46
Driving	
At Night	4-16
City	4-19
Defensive	4-2
Drunken	4-3
Freeway	4-20
Hill and Mountain Roads	4-22
In Rain and on Wet Roads	4-17
Rocking Your Vehicle to Get it Out	4-29
Winter	4-24

E

Easy Entry Seat	1-9
Electrical System	
Add-On Equipment	5-94
Fuses and Circuit Breakers	5-95

Electrical System (cont.)	
Headlamp Wiring	5-94
Instrument Panel Fuse Block	5-95
Power Windows and Other Power Options	5-94
Underhood Fuse Block	5-97
Windshield Wiper Fuses	5-94
Engine	
Air Cleaner/Filter	5-22
Battery	5-42
Check and Service Engine Soon Light	3-34
Coolant	5-26
Coolant Heater	2-20
Coolant Temperature Gage	3-33
Coolant Temperature Warning Light	3-33
Engine Compartment Overview	5-12
Exhaust	2-28
Oil	5-17
Oil Life System	5-20
Overheated Protection Operating Mode	5-31
Overheating	5-29
Starting	2-19
Entry Lighting	3-16
Event Data Recorders (EDR)	7-9
Extender, Safety Belt	1-30
Exterior Lamps	3-13

F

Filter	
Engine Air Cleaner	5-22
Finish Damage	5-91
Flash-to-Pass	3-8
Flat Tire	5-74
Flat Tire, Changing	5-74
Flat Tire, Storing	5-83
Fluid	
Automatic Transaxle	5-23
Power Steering	5-38
Windshield Washer	5-39
Fog Lamp Light	3-38
Fog Lamps	3-15
Folding Rear Seat	1-10
Fuel	
Additives	5-6
California Fuel	5-5
E85 (85% Ethanol)	5-6
Filling a Portable Fuel Container	5-10
Filling Your Tank	5-8
Fuels in Foreign Countries	5-7
Gage	3-38
Gasoline Octane	5-5
Gasoline Specifications	5-5

Fuses	
Fuses and Circuit Breakers	5-95
Instrument Panel Fuse Block	5-95
Underhood Fuse Block	5-97
Windshield Wiper	5-94

G

Gage	
Engine Coolant Temperature	3-33
Fuel	3-38
Speedometer	3-26
Tachometer	3-26
Garage Door Opener	2-34
Gasoline	
Octane	5-5
Specifications	5-5
Glove Box	2-39
GM Mobility Reimbursement Program	7-5

H

Hazard Warning Flashers	3-6
Head Restraints	1-7
Headlamp	
Aiming	5-47
Headlamp Wiring	5-94

Headlamps	
Bulb Replacement	5-47
Daytime Running Lamps/Automatic Headlamp System	3-14
Delayed	3-14
Flash-to-Pass	3-8
Halogen Bulbs	5-47
Headlamps, Front Turn Signal, Sidemarker, and Parking Lamps	5-48
High/Low Beam Changer	3-8
Heated Seats	1-4
Heater	3-19
Highbeam On Light	3-38
Highway Hypnosis	4-22
Hill and Mountain Roads	4-22
Hood	
Checking Things Under	5-10
Release	5-11
Horn	3-6
How to Use This Manual	ii
How to Wear Safety Belts Properly	1-17

I

Ignition Positions	2-18
Infants and Young Children, Restraints	1-32
Inflation - Tire Pressure	5-60

Instrument Panel	
Overview	3-4
Instrument Panel (I/P)	
Brightness	3-15
Cluster	3-25

J

Jump Starting	5-43
---------------------	------

K

Keyless Entry System	2-3
Keys	2-2

L

Labeling, Tire Sidewall	5-55
Lamps	
Battery Run-Down Protection	3-17
Courtesy	3-15
Dome	3-15
Exterior	3-13

Lamps (cont.)	
Fog	3-15
Reading	3-17
LATCH System	
Child Restraints	1-41
Latches, Seatback	1-8
Light	
Airbag Readiness	3-27
Anti-Lock Brake System Warning	3-32
Brake System Warning	3-31
Charging System	3-30
Cruise Control	3-38
Engine Coolant Temperature Warning	3-33
Fog Lamp	3-38
Highbeam On	3-38
Malfunction Indicator	3-34
Oil Pressure	3-37
Passenger Airbag Status Indicator	3-28
Passenger Safety Belt Reminder	3-27
Safety Belt Reminder	3-26
Security	3-37
TCS Warning Light	3-32
Tire Pressure	3-34
Traction Control System (TCS) Warning	3-32

Lighting	
Delayed Entry	3-16
Delayed Exit	3-16
Entry	3-16
Parade Dimming	3-17
Loading Your Vehicle	4-29
Lockout Protection	2-11
Locks	
Automatic Door Lock	2-10
Door	2-9
Lockout Protection	2-11
Power Door	2-10
Programmable Automatic Door Unlock	2-11
Loss of Control	4-14
Lumbar	
Manual Controls	1-3

M

Maintenance Schedule	
Additional Required Services	6-6
At Each Fuel Fill	6-8
At Least Once a Month	6-9
At Least Once a Year	6-9
Introduction	6-2

Maintenance Schedule (cont.)	
Maintenance Footnotes	6-7
Maintenance Record	6-14
Maintenance Requirements	6-2
Normal Maintenance Replacement Parts	6-13
Owner Checks and Services	6-8
Recommended Fluids and Lubricants	6-12
Scheduled Maintenance	6-4
Using	6-3
Your Vehicle and the Environment	6-2
Malfunction Indicator Light	3-34
Manual Lumbar Controls	1-3
Manual Passenger Seat	1-2
Message	
DIC Warnings and Messages	3-46
Mirrors	
Automatic Dimming Rearview	2-30
Automatic Dimming Rearview with OnStar®	2-31
Manual Rearview Mirror	2-30
Manual Rearview Mirror with OnStar®	2-30
Outside Convex Mirror	2-32
Outside Heated Mirrors	2-32
Outside Power Mirrors	2-31
MyGMLink.com	7-3

N

New Vehicle Break-In	2-18
Normal Maintenance Replacement Parts	6-13

O

Odometer	3-26
Off-Road Recovery	4-13
Oil	
Engine	5-17
Pressure Light	3-37
Oil, Engine Oil Life System	5-20
Older Children, Restraints	1-30
Online Owner Center	7-3
OnStar® System, see OnStar® Manual	2-32
Other Warning Devices	3-6
Outlet Adjustment	3-22
Outside	
Convex Mirror	2-32
Heated Mirrors	2-32
Power Mirrors	2-31
Overheated Engine Protection Operating Mode	5-31
Owner Checks and Services	6-8
Owners, Canadian	ii

P

Parade Dimming	3-17
Park (P)	
Shifting Into	2-26
Shifting Out of	2-27
Parking	
Brake	2-25
Over Things That Burn	2-28
Passenger Airbag Status Indicator	3-28
Passenger Compartment Air Filter	3-23
Passenger Sensing System	1-60
Passing	4-13
PASS-Key® III+	2-16
PASS-Key® III+ Operation	2-16
Power	
Accessory Outlet(s)	3-17
Door Locks	2-10
Electrical System	5-94
Retained Accessory (RAP)	2-19
Seat	1-2
Steering Fluid	5-38
Windows	2-14
Pressure Cap	5-28
Pretensioners, Safety Belt	1-29
Programmable Automatic Door Unlock	2-11

Q

Questions and Answers About Safety Belts	1-16
--	------

R

Radios	3-59
Care of Your CD Player	3-84
Care of Your CDs	3-84
Radio with CD	3-62, 3-67
Setting the Time	3-60, 3-61
Theft-Deterrent	3-82
Understanding Reception	3-83
Reading Lamps	3-17
Rear Safety Belt Comfort Guides	1-27
Rear Seat Armrest	2-39
Rear Seat Passengers, Safety Belts	1-25
Rearview Mirror, Automatic Dimming	2-30
Rearview Mirror, Automatic Dimming with OnStar®	2-31
Rearview Mirror with OnStar®	2-30
Rearview Mirrors	2-30
Reclining Seatbacks	1-4

Recommended Fluids and Lubricants	6-12
Recreational Vehicle Towing	4-34
Remote Keyless Entry System	2-3
Remote Keyless Entry System, Operation	2-4
Removing the Flat Tire and Installing the Spare Tire	5-77
Removing the Spare Tire and Tools	5-76
Replacement Bulbs	5-51
Reporting Safety Defects	
Canadian Government	7-14
General Motors	7-14
United States Government	7-14
Restraint System Check	
Checking the Restraint Systems	1-67
Replacing Restraint System Parts After a Crash	1-68
Retained Accessory Power (RAP)	2-19
Right Front Passenger Position, Safety Belts	1-25
Roadside	
Assistance Program	7-5
Rocking Your Vehicle to Get it Out	4-29
Running the Engine While Parked	2-29

S

Safety Belt		
Passenger Reminder Light	3-27	
Pretensioners	1-29	
Reminder Light	3-26	
Safety Belts		
Care of	5-88	
Driver Position	1-18	
How to Wear Safety Belts Properly	1-17	
Questions and Answers About Safety Belts	1-16	
Rear Safety Belt Comfort Guides	1-27	
Rear Seat Passengers	1-25	
Right Front Passenger Position	1-25	
Safety Belt Extender	1-30	
Safety Belt Use During Pregnancy	1-24	
Safety Belts Are for Everyone	1-12	
Safety Warnings and Symbols	iii	
Scheduled Maintenance	6-4	
Seatback Latches	1-8	
Seats		
Easy Entry Seat	1-9	
Head Restraints	1-7	
Heated Seats	1-4	
Manual Lumbar	1-3	
Seats (cont.)		
Manual Passenger	1-2	
Power Seat	1-2	
Reclining Seatbacks	1-4	
Seatback Latches	1-8	
Split Folding Rear Seat	1-10	
Securing a Child Restraint		
Rear Seat Position	1-46	
Right Front Seat Position	1-48	
Security Light	3-37	
Service	5-3	
Accessories and Modifications	5-3	
Adding Equipment to the Outside of Your Vehicle	5-4	
California Proposition 65 Warning	5-3	
Doing Your Own Work	5-4	
Engine Soon Light	3-34	
Publications Ordering Information	7-15	
Servicing Your Airbag-Equipped Vehicle	1-65	
Setting the Time	3-60, 3-61	
Sheet Metal Damage	5-91	
Shifting Into Park (P)	2-26	
Shifting Out of Park (P)	2-27	
Signals, Turn and Lane-Change	3-7	

Spare Tire	
Compact	5-85
Installing	5-77
Removing	5-76
Storing	5-83
Specifications, Capacities	5-100
Speedometer	3-26
Split Folding Rear Seat	1-10
Starting Your Engine	2-19
Steering	4-10
Steering Wheel Controls, Audio	3-83
Steering Wheel, Tilt Wheel	3-6
Storage Areas	
Center Console Storage Area	2-39
Convenience Net	2-39
Cupholder(s)	2-39
Glove Box	2-39
Rear Seat Armrest	2-39
Stuck in Sand, Mud, Ice or Snow	4-28
Sun Visors	2-14
Sunroof	2-40

T

Tachometer	3-26
Taillamps	
Stoplamps, and Back-Up Lamps	5-50
TCS Warning Light	3-32
Theft-Deterrent, Radio	3-82
Theft-Deterrent Systems	2-15
Content Theft-Deterrent	2-15
PASS-Key [®] III+	2-16
PASS-Key [®] III+ Operation	2-16
Tilt Wheel	3-6
Tire	
Pressure Light	3-34
Tires	5-54
Aluminum Wheels, Cleaning	5-90
Buying New Tires	5-68
Chains	5-73
Changing a Flat Tire	5-74
Cleaning	5-91
Compact Spare Tire	5-85

Tires (cont.)		
Different Size	5-69	
If a Tire Goes Flat	5-74	
Inflation - Tire Pressure	5-60	
Inspection and Rotation	5-66	
Installing the Spare Tire	5-77	
Pressure Monitor System	5-62	
Removing the Flat Tire	5-77	
Removing the Spare Tire and Tools	5-76	
Storing a Flat or Spare Tire and Tools	5-83	
Tire Sidewall Labeling	5-55	
Tire Terminology and Definitions	5-57	
Uniform Tire Quality Grading	5-70	
Wheel Alignment and Tire Balance	5-71	
Wheel Replacement	5-71	
When It Is Time for New Tires	5-67	
Towing		
Recreational Vehicle	4-34	
Towing a Trailer	4-36	
Your Vehicle	4-34	
Traction		
Control System (TCS)	4-9	
Control System Warning Light	3-32	
Transaxle		
Fluid, Automatic	5-23	
Transaxle Operation, Automatic	2-22	
Trunk	2-11	
Turn and Lane-Change Signals	3-7	
Turn Signal/Multifunction Lever	3-7	
U		
Understanding Radio Reception	3-83	
Uniform Tire Quality Grading	5-70	
Universal Home Remote System	2-34	
Operation	2-35	
V		
Vehicle		
Control	4-5	
Damage Warnings	iv	
Loading	4-29	
Symbols	iv	
Vehicle Customization, DIC	3-53	

Vehicle Data Collection and Event Data	
Recorders	7-9
Vehicle Identification	
Number (VIN)	5-93
Service Parts Identification Label	5-93
Ventilation Adjustment	3-22
Visors	2-14

W

Warning Lights, Gages and Indicators	3-24
Warnings	
DIC Warnings and Messages	3-46
Hazard Warning Flashers	3-6
Other Warning Devices	3-6
Safety and Symbols	iii
Vehicle Damage	iv
Wheels	
Alignment and Tire Balance	5-71
Different Size	5-69
Replacement	5-71

Where to Put the Restraint	1-39
Windows	2-13
Power	2-14
Windshield	
Washer	3-9
Washer Fluid	5-39
Wiper Blade Replacement	5-52
Wiper Blades, Cleaning	5-90
Wiper Fuses	5-94
Wipers	3-8
Winter Driving	4-24

X

XM™ Satellite Radio Antenna System	3-85
--	------

Y

Your Vehicle and the Environment	6-2
--	-----