

TECHNICAL MANUAL
OPERATOR, ORGANIZATIONAL, DIRECT
SUPPORT AND GENERAL SUPPORT
MAINTENANCE MANUAL

APPENDIX A

REFERENCES

B

MAINTENANCE
ALLOCATION CHART

C COMPONENTS OF END
ITEMS AND
BASIC ISSUE ITEMS

D

ADDITIONAL
AUTHORIZATION LIST

E

EXPENDABLE
SUPPLIES AND MATERIALS LIST

F

MANUFACTURED
TOOLS

INDEX

LANDING CRAFT UTILITY
LCU 1667-1670
NSN 1905-00-168-5764

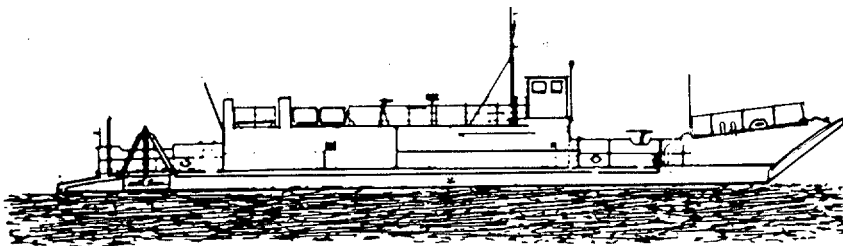

CHANGE

NO. 6

HEADQUARTERS
DEPARTMENT OF THE ARMY
WASHINGTON, D.C., 10 October 1996

Operator, Organizational, Direct
Support and General Support
Maintenance Manual

LANDING CRAFT UTILITY
LCU 1667 - 1670
NSN 1905-00-168-5764

DISTRIBUTION STATEMENT A: Approved for public release; distribution is unlimited.

TM 55-1905-219-14-12, 8 April 1985, is changed as follows:

1. Remove and insert pages as indicated below. New or changed text material is indicated by a vertical bar in the margin. An illustration change is indicated by a miniature pointing hand.

Remove pages	Insert pages
i/(ii blank)	i/(ii blank)
A-1/(A-2 blank)	A-1 and A-2
C-7 and C-8	C-7 and C-8
-----	C-8.1/(C-8.2 blank)
-----	C-123/(C-124 blank)

2. Retain this sheet in front of manual for reference purposes.

By Order of the Secretary of the Army:

Official:

JOEL B. HUDSON
*Administrative Assistant to the
Secretary of the Army*
02792

DENNIS J. REIMER
*General, United States Army
Chief of Staff*

DISTRIBUTION:

To be distributed in accordance with DA Form 12-25-E, block no. 1057, requirements for TM 55-1905-219-14-12.

CHANGE
NO. 5

HEADQUARTERS
DEPARTMENT OF THE ARMY
WASHINGTON, D.C., 30 JUNE 1994

Operator, Organizational, Direct Support and General Support
Maintenance Manual

LANDING CRAFT UTILITY
LCU 1667-1670
NSN 1905-00-168-5764

DISTRIBUTION STATEMENT A: Approved for public release; distribution is unlimited.

TM 55-1905-219-14-12, 8 April 1985, is changed as follows:

1. Remove and insert pages as indicated below. New or changed text material is indicated by a vertical bar in the margin. An illustration change is indicated by a miniature pointing hand.

Remove pages

i/(ii blank)
B-1 through B-44
C-119/(C-120 blank)
D-7/(D-8 blank)

Insert pages

i/(ii blank)
B-1 through B-44
C-119 through C-122
D-7/(D-8 blank)

2. Retain this sheet in front of manual for reference purposes.

By Order of the Secretary of the Army:

Official:

MILTON H. HAMILTON
*Administrative Assistant to the
Secretary of the Army*
07110

GORDON R. SULLIVAN
*General, United States Army
Chief of Staff*

DISTRIBUTION:

To be distributed in accordance with DA Form 12-25-E, block no. 1057, requirements for TM 55-1905-219-14-12.

CHANGE

NO. 4

HEADQUARTERS
DEPARTMENT OF THE ARMY
WASHINGTON, D.C., 31 March 1993

OPERATOR, ORGANIZATIONAL, DIRECT SUPPORT
AND GENERAL SUPPORT MAINTENANCE MANUAL

LANDING CRAFT UTILITY

LCU

NSN

1667-1670

1905-00-168-5764

DISTRIBUTION STATEMENT A: Approved for public release; distribution is unlimited.

TM 55-1905-219-14-12, 8 April 1985, is changed as follows:

1. Remove and insert pages as indicated below. New or changed text material is indicated by a vertical bar in the margin. An illustration change is indicated by a miniature pointing hand.

Remove pages

Insert pages

i/(ii blank)

i/(ii blank)

D-7/(D-8 blank)

D-7/(D-8 blank)

2. Retain this sheet in front of manual for reference purposes.

By Order of the Secretary of the Army:

Official:

MILTON H. HAMILTON
Administrative Assistant to the
Secretary of the Army
03961

GORDON R. SULLIVAN
General, United States Army
Chief of Staff

DISTRIBUTION:

To be distributed in accordance with DA Form 12-25-E, block no. 1057, requirements for TM 55-1905-219-14-12.

CHANGE

NO. 3

Operator's, Organizational, Direct Support
and General Support Maintenance Manual

LANDING CRAFT UTILITY
LCU 1667-1670
NSN 1905-00-168-5764

Approved for public release; distribution is unlimited

TM 55-1905-219-14-12, 8 April 1985, is changed as follows:

1. Remove and insert pages as indicated below. New or changed text material is indicated by a vertical bar in the margin. An illustration change is indicated by a miniature pointing hand.
2. Appendix B, Maintenance Allocation Chart has been changed in its entirety therefore no change bars are shown.

Remove pages

B-1 through B-36
 C-19 through C-22
 Index-1 through Index-4
 Index-11 through Index-14
 Index-19 through Index-22
 Index-25 through Index-28
 Index-53 and Index-54
 Index-57 and Index-58
 Index-59/Index-60

Insert pages

B-1 through B-44
 C-19 through C-22
 Index-1 through Index-4
 Index-11 through Index-14
 Index-19 through Index-22
 Index-25 through Index-28
 Index-53 and Index-54
 Index-57 and Index-58
 Index-59/Index-60

3. Retain this sheet in front of manual for reference purposes.

By Order of the Secretary of the Army:

GORDON R. SULLIVAN
General, United States Army
Chief of Staff

Official:

MILTON H. HAMILTON
Administrative Assistant to the
Secretary of the Army
 01014

DISTRIBUTION:

To be distributed in accordance with DA Form 12-25E, (qty rqr block no. 1057)

CHANGE }
NO. 2 }

HEADQUARTERS
DEPARTMENT OF THE ARMY
WASHINGTON, D.C., 30 August 1989

Operator's, Organizational, Direct Support
and General Support Maintenance Manual

LANDING CRAFT UTILITY
LCU 1667-1670
NSN 1905-00-168-5764

Approved for public release; distribution is unlimited

TM 55-1905-219-14-12, 8 April 1985, is changed as follows:

1. Remove and insert pages as indicated below. New or changed text material is indicated by a vertical bar in the margin. An illustration change is indicated by a miniature pointing hand.

Remove pages	Insert pages
D-7/D-8	D-7/D-8

2. Retain this sheet in front of manual for reference purposes.

By Order of the Secretary of the Army:

CARL E. VUONO
General, United States Army
Chief of Staff

Official:

WILLIAM J. MEEHAN, II
Brigadier General, United States Army
The Adjutant General

DISTRIBUTION:

To be distributed in accordance with DA Form 12-25A, Operator, Unit, Direct Support and General Support Maintenance requirements for Landing Craft, Utility, LUC-1667-1670.

CHANGE }
No. 1 }

HEADQUARTERS
DEPARTMENT OF THE ARMY
WASHINGTON, D.C., 11 April 1988

Operator, Organizational, Direct Support
and General Support Maintenance Manual

LANDING CRAFT UTILITY
LCU 1667-1670
NSN 1905-00-168-5764

TM 55-1905-219-14-12, 8 April 1985, is changed as follows:

1. Remove and insert pages as indicated below. New or changed text material is indicated by a vertical bar in the margin. An illustration change is indicated by a miniature pointing hand.

Remove pages

Insert pages

B-17 and B-18
B-35 and B-36

B-17 and B-18
B-35 and B-36

2. Retain this sheet in front of manual for reference purposes.

By Order of the Secretary of the Army:

CARL E. VUONO
General, United States Army
Chief of Staff

Official:

R. L. DILWORTH
Brigadier General, United States Army
The Adjutant General

DISTRIBUTION:

To be distributed in accordance with DA Form 12-25A, Operator, Unit, Direct Support and General Support Maintenance requirements for Landing Craft, Utility, LUC-1667-1670.

CHANGE

NO. 55-1905-219-14-12

HEADQUARTERS
DEPARTMENT OF THE ARMY
WASHINGTON, D.C., 8 April 1985

Operator, Organizational, Direct
Support and General Support
Maintenance Manual

LANDING CRAFT UTILITY
LCU 1667 - 1670
NSN 1905-00-168-5764

REPORTING ERRORS AND RECOMMENDING IMPROVEMENTS

You can help improve this manual. If you find any mistakes, or if you know of a way to improve these procedures, please let us know. Mail your letter or DA Form 2028 (Recommended Changes to Publications and Blank Forms), or DA Form 2028-2 located in the back of this manual directly to: Commander, US Army Aviation and Troop Command, ATTN: AMSAT-I-MP, 4300 Goodfellow Blvd., St. Louis, MO 63120-1798. You may also submit your recommended changes by E-mail directly to <mpmt%avma28@st-louis-emh7.army.mil>. A reply will be furnished directly to you. Instructions for sending an electronic 2028 may be found at the back of this manual immediately preceding the hard copy 2028.

DISTRIBUTION STATEMENT A: Approved for public release; distribution is unlimited.

TABLE OF CONTENTS

	PAGE
APPENDIX A	REFERENCES..... A-1
APPENDIX B	MAINTENANCE ALLOCATION CHART B-1
APPENDIX C	COMPONENTS OF END ITEM AND BASIC ISSUE ITEMS LISTS..... C-1
APPENDIX D	ADDITIONAL AUTHORIZATION LIST..... D-1
APPENDIX E	EXPENDABLE SUPPLIES AND MATERIALS LIST..... E-1
APPENDIX F	MANUFACTURED TOOLS F-1
INDEX	INDEX-1

APPENDIX A
REFERENCES

- | | | |
|----|---|---|
| 1. | Fire Protection
TB 5-4200-200-10 | Hand Portable Fire Extinguishers for
Army Users |
| 2. | Lubrication

C91001L |

Fuels, Lubricants, Oil, and Waxes |
| 3. | Painting

TM 9-213 |

Painting Instructions for Field Use |
| 4. | Cleaning

C680011 |

Cleaning and Chemical Products |
| 5. | Maintenance

TM 55-1905-219-20P

TM 55-1905-219-34P

DA Pam 738-750 | Unit Maintenance Repair Parts and
Special Tools List

Direct Support, and General Support
Maintenance Repair Parts and
Special Tools List

The Army Maintenance Management System
(TAMMS) |
| 6. | Shipment and Storage

TB 740-244-3

TB 740-93-2 |

Preservation and Packing of Military Equipment

Preservation of Mechanical Equipment for
Shipment and Storage |
| 7. | Demolition

TM 750-244-3 |

Destruction of Material to Prevent Enemy Use |

APPENDIX A

REFERENCES - CONTINUED

8. Communications, Electronics, Navigation (CEN) Equipment Commercial Manuals
- Alden Electronics SATFIND-406 M3 EPIRB
Owner's Manual
- Alden TR-IV Marinefax Technical Manual and
Operator's Manual
- Instruction Book No.
71261 Rev. C and
Instruction Book
Cat. No. 120 and 122
No. 509754
- Belfort Instrument Company Aerovane Indicator
Model 135
- Bendix/King EPH/EPI Series Portable Radio
Owner's Manual
- Bendix/King EPH Series Portable Radio Service
Manual
- Bendix/King LAA Series Battery Chargers
Service Manual
- Dymek DA1 OOD All Wave Receiving Antenna
Owner Information Manual
- Mackay Communications 403A Emergency
Lifeboat Transceiver Instruction Manual
- Naval Electronics Inc. MK22CA/Pba 2205
System Installation and Service Manual
- Newmar Heavy Duty DC-DC Converters
Operation and Installation Instructions
- RMC Document Number
G261404 Rev A
- Raytheon Marine Company Radar Set Model
R40X/R41X AN/SPS-69 Description, Operation
and Maintenance Technical Manual
- Ross Engineering DSC 500 Digital Selective Call
Marine VHF Transceiver Operating Manual
- TM-8080000701
- Sunair Electronics, Inc. Digital Automatic
Antenna Coupler DCU-100 Operation and
Maintenance Manual

Appendix B. MAINTENANCE ALLOCATION CHART (MAC)

Section I. INTRODUCTION

B-1 THE ARMY MAINTENANCE SYSTEM MAC.

a This introduction (Section I) provides a general explanation of all maintenance and repair functions authorized at various maintenance levels under the standard Army Maintenance System concept.

b The Maintenance Allocation Chart (MAC) in Section II designates overall authority and responsibility for the performance of maintenance functions on the identified end item or component. The application of the maintenance functions to the end item or component will be consistent with the capacities and capabilities of the designated maintenance levels, which are shown in the MAC in column (4) as:

Unit - includes two subcolumns: C (operator/crew) and O (unit) maintenance.

Direct Support - includes an F subcolumn.

General Support - includes an H subcolumn.

Depot - includes a D subcolumn.

c Section III lists the tools and test equipment (both special tools and common tools sets) required for each maintenance function as referenced from Section II.

d Section IV contains supplemental instructions and explanatory notes for a particular maintenance function as referenced from Section II.

B-2 MAINTENANCE FUNCTIONS. Maintenance functions will be limited to and defined as follows:

a Inspect. To determine the serviceability of an item by comparing its physical, mechanical, and/or electrical characteristics with established standards through examination (i.e., by sight, sound, or feel).

b Test. To verify serviceability by measuring the mechanical, pneumatic, hydraulic, or electrical characteristics of an item and comparing those characteristics with prescribed standards.

c Service. Operations required periodically to keep an item in proper operating condition, i.e., to clean (includes decontamination, when required), to replace filters, to preserve, to drain, to paint, or to replenish fuel, lubricants, chemical fluids, or gases.

d Adjust. To maintain or regulate, within prescribed limits, by bringing into proper or exact position, or by setting the operating characteristics to specified parameters.

e Align. To adjust specified variable elements of an item to bring about optimum or desired performance.

f Calibrate. To determine and cause corrections to be made or to be adjusted on instruments or test, measuring, and diagnostic equipment used in precision measurement. Consists of comparisons of two instruments, one of which is a certified standard of known accuracy, to detect and adjust any discrepancy in the accuracy of the instrument being compared.

g Remove/Install. To remove and install the same item when required to perform service or other maintenance functions. Install may be the act of emplacing, seating, or fixing into position a spare, repair part, or module (component or assembly) in a manner to allow the proper functioning of an equipment or system.

H Replace. To remove an unserviceable item and install a serviceable counterpart in its place. Replace is authorized by the MAC and is shown as the 3rd position code of the SMR code.

i Repair. The application of maintenance services¹ including fault location/troubleshooting², removal/installation, and disassembly/assembly³ procedures, and maintenance actions⁴ to identify troubles and restore serviceability to an item by correcting specific damage, fault, malfunction, or failure in a part, subassembly, module (component or assembly), and item, or system.

j Overhaul. That maintenance effort (service/action) prescribed to restore an item to a completely serviceable/operational condition as required by maintenance standards in appropriate technical publications (i.e., DMWR). Overhaul is normally the highest degree of maintenance performed by the Army. Overhaul does not normally return an item to like new condition.

k Rebuild. Consists of those service/actions necessary for the restoration of unserviceable equipment to a like new condition in accordance with original manufacturing standards. Rebuild is the highest degree of material maintenance applied to Army equipment. The rebuild operation includes the act of returning to zero those age measurements (hours, miles, etc.) considered in classifying Army equipment and components.

B-3 EXPLANATION OF COLUMNS IN THE MAC, SECTION II

a Column 1 - Group Number. Column 1 lists functional group code numbers, the purpose of which is to identify maintenance significant components, assemblies, subassemblies, and modules with the next higher assembly.

b Column 2 - Component/Assembly. Column 2 contains the names of components, assemblies, subassemblies, and modules for which maintenance is authorized.

c Column 3 - Maintenance Function. Column 3 lists the functions to be performed on the item listed in column 2. (For detailed explanation of these functions, see paragraph A-2.)

d Column 4 - Maintenance Category. Column 4 specifies, by the listing of a work time figure in the appropriate subcolumn(s), the category of maintenance authorized to perform the function listed in Column 3. This figure represents the active time required to perform that maintenance function at the indicated category of maintenance. If the number or complexity of the tasks within the listed maintenance function varies at different maintenance categories, appropriate work time figures will be shown for each category. The work time figure represents the average time required to restore an item (assembly, subassembly, component, module, end item, or system) to a serviceable condition under typical field operating conditions. This time includes preparation time (including any necessary disassembly/assembly time), troubleshooting/fault location time, and quality assurance/quality control time in addition to the time required to perform the specific tasks identified for the maintenance functions authorized in the maintenance allocation chart. The symbol designations for the various maintenance categories are as follows:

- C Operator or Crew
- O Unit Maintenance
- F Direct Support Maintenance (DS)
- H General Support Maintenance (GS)
- D Depot Maintenance

¹Service - Inspect, test, service, adjust, align, calibrate, and/or replace.

²Fault location/troubleshooting - The process of investigating and detecting the cause of equipment malfunctioning; the act of isolating a fault within a system or unit under test (UUT).

³Disassembly/assembly - The step-by-step breakdown (taking apart) of a spare/functional group coded item to the level of its least component, that is assigned an SMR code for the level of maintenance under consideration (i.e., identification as maintenance significant).

⁴Actions - Welding, grinding, riveting, straightening, facing, machining, and/or resurfacing.

e Column 5 - Tools and Equipment. Column 5 specifies, by number code, those common tool sets (not individual tools); special tools; Test, Measurement, and Diagnostic Equipment (TMDE); and support equipment required to perform the designated function, which shall be keyed to the tools listed in Section III.

f Column 6 - Remarks. This column shall, when applicable, contain a letter code, in alphabetic order, which shall be keyed to the remarks contained in Section IV.

B-4 EXPLANATION OF COLUMNS IN TOOL AND TEST EQUIPMENT REQUIREMENTS, SECTION III.

a Column 1 - Reference Code. The tool and test equipment reference code correlates with a number code used in the MAC, Section II, Column 5.

b Column 2 - Maintenance Category. The lowest category of maintenance authorized to use the tool or test equipment.

c Column 3 - Nomenclature. Name or identification of the tool or test equipment.

d Column 4 - National Stock Number. The National stock number (NSN) of the tool or test equipment.

e Column 5 - Tool Number. The manufacturer's part number.

B-5 EXPLANATION OF COLUMNS IN REMARKS, SECTION IV.

a Column 1 - Reference Code. The letter code recorded in Column 6, Section II.

b Column 2 - Remarks. This column lists information pertinent to the maintenance function being performed as indicated in the MAC, Section II.

Section II. MAINTENANCE ALLOCATION CHART (Cont.)

(1) GROUP NUMBER	(2) COMPONENT/ ASSEMBLY	(3) MAINTENANCE FUNCTION	(4) MAINTENANCE LEVEL					(5) TOOLS AND EQUIPMENT	(6) REMARKS
			UNIT		DS	GS	DEPOT		
			C	O	F	H	D		
0104	Air Intake	Inspect	0.2						
		Service	0.2						
		Replace	3.5						
		Repair	1.5						
0105	Blower	Inspect	0.2						
		Service	0.2				8,9		
		Replace	1.5				7		
		Repair	1.0						
0106	Fuel Pump	Inspect	0.2						
		Replace	1.0				10,11		
		Repair	1.5						
0107	Fuel Filter, Strainer and Fuel Lines	Inspect	0.1						
		Service	0.5						
		Replace	2.0						
		Repair	1.5						
0108	Fuel Injector	Inspect	0.1						
		Test	0.3		0.5				
		Service	0.2						
		Replace	1.5				14		
		Repair	1.5				12,13,15		
0109	Lube Oil Filters and Housing	Inspect	0.2						
		Service	0.4						
		Replace	1.5						
		Repair	1.4		1.5 (weld)				
0110	Oil Cooler	Inspect	0.1						
		Replace	1.2						
		Repair	1.5		2.5				
0111	Fresh Water Pump	Inspect	0.2						
		Replace	1.2				11,16,17,18, 19,21,52		
		Repair	2.5		3.0			D	

Section II. MAINTENANCE ALLOCATION CHART (Cont.)

(1) GROUP NUMBER	(2) COMPONENT/ ASSEMBLY	(3) MAINTENANCE FUNCTION	(4) MAINTENANCE LEVEL					(5) TOOLS AND EQUIPMENT	(6) REMARKS
			UNIT		DS	GS	DEPOT		
			C	O	F	H	D		
0112	Expansion Tank	Inspect	0.1						
		Service	0.2						
		Test	0.5						
		Replace	2.5						
		Repair	1.7	2.5					
0113	Water Con- nections	Inspect	0.2						
		Replace	2.0						
0114	Water Manifold	Inspect	0.2						
		Replace	1.5						
		Repair			3.0	(weld)			
0116	Thermostat and Housing	Inspect	0.2						
		Test	0.5						
		Replace	0.4						
		Repair	1.3		2.0	(weld)			
0118	Tachometer Drive	Inspect	0.1						
		Replace	1.6						
		Repair	2.0						
0119	Instrument Panel	Inspect	0.1						
		Replace	1.5						
		Repair	2.0						
0120	Crankshaft Pul- ley and Vibration Dampener	Inspect	0.2						
		Replace	3.0				21,40		
		Repair			2.5				
0121	Balance Weight Cover and Accessory Drive	Inspect	0.2					40	
		Replace			2.5				
		Repair			3.5				
0122	Engine Supports , Lift Brackets and Crankshaft Front Cover	Inspect	0.1						
		Replace	0.5			1.5			
0123	Exhaust Mani- fold and Fittings	Inspect	0.2					40	
		Replace	3.0						
		Repair	3.0		3.0				

Section II. MAINTENANCE ALLOCATION CHART (Cont.)

(1) GROUP NUMBER	(2) COMPONENT/ ASSEMBLY	(3) MAINTENANCE FUNCTION	(4) MAINTENANCE LEVEL					(5) TOOLS AND EQUIPMENT	(6) REMARKS
			UNIT		DS	GS	DEPOT		
			C	O	F	H	D		
0123A	Muffler	Inspect	1.0						
		Service	2.0						
		Replace			50.0				
		Repair			18.0				
0124	Rocker Arm Cover	Inspect	0.1						
		Replace	0.2						
0125	Injector Controls	Inspect	0.1						
		Adjust	2.3						
		Replace	2.0						
		Repair	2.7						
0126	Flywheel and Housing	Inspect	0.2						
		Replace			4.0			22	
		Repair	2.0		2.0				
0127	Camshaft and Gear Train	Inspect			0.9				
		Replace			4.5			23,24, 25	
		Repair			4.0				
0128	Valve Operating Mechanism (per cylinder)	Inspect	0.2					26	
		Adjust	0.8						
		Replace	2.5						
		Repair	3.2						
0129	Cylinder Head	Inspect	0.2						
		Test			0.5				
		Replace	1.5					27, 28,29,30, 31,32,33,34	
		Repair	1.5		4.5	(weld)			
0130	Oil Pan and Dipstick	Inspect	0.2					28	
		Replace	2.5						
		Repair			2.5	(weld)			
0131	Lube Oil Relief Valve	Inspect	0.1						
		Replace	1.0						
		Repair			1.5				
0131A	Lube Oil Regulator	Inspect	0.1						
	Replace		1.0						
		Repair			1.5				

Section II. MAINTENANCE ALLOCATION CHART (Cont.)

(1) GROUP NUMBER	(2) COMPONENT/ ASSEMBLY	(3) MAINTENANCE FUNCTION	(4) MAINTENANCE LEVEL					(5) TOOLS AND EQUIPMENT	(6) REMARKS
			UNIT		DS	GS	DEPOT		
			C	O	F	H	D		
0132	Lube Oil Pump	Inspect Replace Repair	0.2 1.0		2.0			35, 36, 53	
0133	Lube Oil Distribution System	Inspect Replace	0.1 2.0						
0134	Pistons, Con- necting Rods and Lliners	Inspect Replace Repair	1.0 4.5		5.5			33, 34, 37, 38, 39, 41,42, 43, 44,45, 46, 47	
0135	Crankshaft Bearing	Inspect Replace	1.0 6.5						
0135A	Crankshaft	Inspect Replace	0.1		2.0				
0135B	Crankshaft Seals	Inspect Replace	0.1		1.0				
0136	Cylinder Block	Inspect Replace Repair	0.3 1.0		12.0 8.5				
0137	Starting Aid	Inspect Service Replace Repair	0.1 0.2 1.5 2.0						
0138	Hydrostarter (Hydrotor)	Inspect Test Replace Repair	0.2 1.2 1.2		1.5			48	B, C
0139	Accumulator	Inspect Service Replace Repair	0.1 1.4		1.0 3.5			49	
0140	Hydrostarter Pump (Engine Driven)	Inspect Replace Repair	0.1 0.4		1.8				

Section II. MAINTENANCE ALLOCATION CHART (Cont.)

(1) GROUP NUMBER	(2) COMPONENT/ ASSEMBLY	(3) MAINTENANCE FUNCTION	(4) MAINTENANCE LEVEL					(5) TOOLS AND EQUIPMENT	(6) REMARKS
			UNIT		DS	GS	DEPOT		
			C	O	F	H	D		
0123A	Muffler	Inspect	1.0						
		Service	2.0						
		Replace			50.0				
		Repair			18.0				
0124	Rocker Arm Cover	Inspect	0.1						
		Replace	0.2						
0125	Injector Controls	Inspect	0.1						
		Adjust	2.3						
		Replace	2.0						
		Repair	2.7						
0126	Flywheel and Housing	Inspect	0.2					22	
		Replace			4.0				
		Repair	2.0		2.0				
0127	Camshaft and Gear Train	Inspect			0.9			23, 24, 25	
		Replace			4.5				
		Repair			4.0				
0128	Valve Operating Mechanism (per cylinder)	Inspect	0.2					26	
		Adjust	0.8						
		Replace	2.5						
		Repair	3.2						
0129	Cylinder Head	Inspect	0.2					27, 28, 29, 30, 31,32, 33, 34	
		Test			0.5				
		Replace	1.5						
0130	Oil Pan and Dipstick	Repair	1.5		4.5	(weld)		28	
		Inspect	0.2						
		Replace	2.5		2.5	(weld)			
0131	Lube Oil Relief Valve	Inspect	0.1						
		Replace	1.0						
		Repair			1.5				
0131A	Lube Oil Regulator	Inspect	0.1						
		Replace	1.0						
		Repair			1.5				

Section II. MAINTENANCE ALLOCATION CHART (Cont.)

(1) GROUP NUMBER	(2) COMPONENT/ ASSEMBLY	(3) MAINTENANCE FUNCTION	(4) MAINTENANCE LEVEL					(5) TOOLS AND EQUIPMENT	(6) REMARKS
			UNIT		DS	GS	DEPOT		
			C	O	F	H	D		
0132	Lube Oil Pump	Inspect	0.2					35, 36, 53	
		Replace	1.0						
		Repair			2.0				
0133	Lube Oil Distribution System	Inspect	0.1						
		Replace	2.0						
0134	Pistons, Connecting Rods and Liners	Inspect	1.0					33, 34, 37, 38, 39, 41, 42, 43, 44, 45, 46, 47	
		Replace Repair	4.5		5.5				
0135	Crankshaft Bearing	Inspect	1.0						
		Replace	6.5						
0135A	Crankshaft	Inspect	0.1						
0135B	Crankshaft Seals	Inspect	0.1						
		Replace			1.0				
0136	Cylinder Block	Inspect	0.3						
		Replace			12.0				
		Repair	1.0		8.5				
0137	Starting Aid	Inspect	0.1						
		Service	0.2						
		Replace	1.5						
		Repair	2.0						
0138	Hydrostarter (Hydrotor)	Inspect	0.2					48	B, C
		Test	1.5						
		Replace	1.2						
		Repair	1.2						
0139	Accumulator	Inspect	0.1					49	
		Service			1.0				
		Replace Repair	1.4		3.5				
0140	Hydrostarter Pump (Engine Driven)	Inspect	0.1						
		Replace	0.4						
		Repair			1.8				

Section II. MAINTENANCE ALLOCATION CHART (Cont.)

(1) GROUP NUMBER	(2) COMPONENT/ ASSEMBLY	(3) MAINTENANCE FUNCTION	(4) MAINTENANCE LEVEL					(5) TOOLS AND EQUIPMENT	(6) REMARKS
			UNIT		DS	GS	DEPOT		
			C	O	F	H	D		
0141	Hydrostarter Pump (Hand)	Inspect Replace Repair	0.1 1.2 2.5						
0142	Hydrostarter Piping (Forward Engine Room)	Inspect Replace Repair	0.2		2.7 1.5				
0143	Hydrostarter Piping (Aft Engine Room)	Inspect Replace Repair	0.2		2.7 1.5				
0144	Reservoirs, Filters and Solenoids	Inspect Replace Repair	0.2 1.0		1.0				
0150	Propeller Shaft and Bearings	Inspect Adjust Replace Repair Overhaul	0.5 0.4 12.0		100.0 6.5	5.5		49	E, F L
0150A	Port Line Shaft	Inspect Adjust Repair	0.5 1.0 3.0						
0150B	Shaft Inflatable Seals	Inspect Service Replace Repair	0.1 4.0 2.0			15.0		49	
0150C	Shaft Seal, Preformed	Inspect Service Replace	0.1 15.0		2.0				
0151	Shaft Lock	Inspect Replace	0.3 4.5		4.0				
0200	Electric Power Genera- tion and Distribution	Overhaul							L

Section II. MAINTENANCE ALLOCATION CHART (Cont.)

(1) GROUP NUMBER	(2) COMPONENT/ ASSEMBLY	(3) MAINTENANCE FUNCTION	(4) MAINTENANCE LEVEL					(5) TOOLS AND EQUIPMENT	(6) REMARKS
			UNIT		DS	GS	DEPOT		
			C	O	F	H	D		
0205	Switchboard (main)	Inspect	0.4						
		Replace			24.0				
		Repair	0.5		25.5				
0208	Transformers	Inspect	0.5		0.5				
		Service	1.0		5.5				
		Replace			6.6				
		Repair			3.5				
0210	Power Distribu- tion Panel Boards	Inspect	0.7						
		Replace			4.0				
		Repair	2.5		5.5				
0213	Fuse Panel P-024	Inspect	0.2						
		Replace			4.0				
		Repair	2.5						J
0214	Alarm Distribu- tion Panel	Inspect	0.2						
		Replace			4.0				
		Repair	2.5						
0215	Generator, 12V	Inspect	0.3						
		Service	1.0						
		Test	1.0		2.0				
		Replace	1.0						
		Repair	5.0					*	L
		Overhaul							
0218	Generator (40KW)	Inspect	0.2						
		Service	2.0						
		Replace	16.0						
		Overhaul						*	L
0220	Engine Assy	Inspect	0.3						
		Service	1.5						
		Test			8.0				
		Replace			40.0				
		Repair	8.5						
		Overhaul						*	L

Change 5

B-10

Section II. MAINTENANCE ALLOCATION CHART (Cont.)

(1) GROUP NUMBER	(2) COMPONENT/ ASSEMBLY	(3) MAINTENANCE FUNCTION	(4) MAINTENANCE LEVEL					(5) TOOLS AND EQUIPMENT	(6) REMARKS
			UNIT		DS	GS	DEPOT		
			C	O	F	H	D		
0221	Engine Controls	Inspect Adjust Replace Repair	0.5 2.0 8.0 2.0						
0221A	Emergency Stop Solenoid	Inspect Adjust Replace Repair	0.5 0.5 1.0 1.0						
0221B	Alarm Switches	Inspect Adjust Replace Repair	0.3 0.2 0.5 0.5						
0221C	Emergency Shut-Off	Inspect Adjust Replace Repair	0.5 0.2 2.0 1.0						
0222	Governor (Hydraulic) and Oil Filters	Inspect Service Test Adjust Replace Repair	0.2 0.2 0.2 1.0 1.0		0.4 1.0 4.5			3, 4, 5, 6	
0223	Air Intake	Inspect Service Replace Repair	0.2 0.4 1.5 3.0						
0224	Blower	Inspect Service Replace Repair	0.2 0.4 1.5 1.0					7,8,9, 48	
0225	Fuel Pump and Drain Lines	Inspect Replace Repair	0.2 1.0 2.0					10,11	

Section II. MAINTENANCE ALLOCATION CHART (Cont.)

(1) GROUP NUMBER	(2) COMPONENT/ ASSEMBLY	(3) MAINTENANCE FUNCTION	(4) MAINTENANCE LEVEL					(5) TOOLS AND EQUIPMENT	(6) REMARKS
			UNIT		DS	GS	DEPOT		
			C	O	F	H	D		
0226	Fuel Filter and Strainer	Inspect	0.2						
		Service	0.5						
		Replace	1.5						
		Repair	1.5						
0227	Fuel Injector	Inspect	0.1						
		Test	0.3		0.5			12,13,14,15, 50	
		Replace	1.5					12,13,14,15, 50	
		Repair	1.5					12,13,14,15, 50	
0228	Fuel Lines and Manifold Connections	Inspect	0.2						
		Replace	1.5						
0229	Lube Oil Filter and Housing	Inspect	0.2						
		Service	0.4						
		Replace	1.5						
0230	Lube Oil Cooler	Repair	1.4		1.5				
		Inspect	0.2						
		Replace	1.2						
0231	Fresh Water Pump	Repair	1.5		2.5				
		Inspect	0.2					11	
		Replace	1.2					11,16,17,18, 19	
0232	Heat Expansion Tank and Water Connections	Repair			2.5			11,16,17,18, 19,21,52	
		Inspect	0.2						
		Replace	1.2						
0233	Water Manifold	Inspect	0.2						
		Replace	1.2						
		Repair			3.0 (weld)				
0234	Thermostat and Housing	Inspect	0.2						
		Replace	0.4						
		Repair	1.3		2.0 (weld)				

Section II. MAINTENANCE ALLOCATION CHART (Cont.)

(1) GROUP NUMBER	(2) COMPONENT/ ASSEMBLY	(3) MAINTENANCE FUNCTION	(4) MAINTENANCE LEVEL					(5) TOOLS AND EQUIPMENT	(6) REMARKS
			UNIT		DS	GS	DEPOT		
			C	O	F	H	D		
0235	Overspeed Governor	Inspect	0.2						
		Test			1.0				
		Service	1.0						
		Adjust	0.5						
		Replace	1.0						
		Repair	1.0						
0236	Tachometer Drive	Inspect	0.2						
		Replace	1.6						
		Repair	1.5						
0237	Air Cleaner	Inspect	0.1						
		Service	0.3						
		Replace	1.0						
		Repair	1.0						
0238	Crankshaft Pulley	Inspect	0.2				21		
		Replace	2.5						
		Repair			1.7				
0239	Balance Weight Cover	Inspect	0.2				50		
		Replace	1.5						
0240	Lift Brackets and Supports	Inspect	0.2						
		Replace	1.6						
		Repair	1.0		2.5				
0241	Exhaust Manifold	Inspect	0.2						
		Replace	2.0						
		Repair	2.5		2.5				
0242	Rocker Arm Cover	Inspect	0.1						
		Replace	1.0						
0243	Injector Controls	Inspect	0.2						
		Adjust	0.3						
		Replace	1.5						
		Repair	2.0						
0244	Oil Pan, Dipstick, Oil Filter	Inspect	0.2					28	
		Replace	1.5						
		Repair	1.5						

Section II. MAINTENANCE ALLOCATION CHART (Cont.)

(1) GROUP NUMBER	(2) COMPONENT/ ASSEMBLY	(3) MAINTENANCE FUNCTION	(4) MAINTENANCE LEVEL					(5) TOOLS AND EQUIPMENT	(6) REMARKS
			UNIT		DS	GS	DEPOT		
			C	O	F	H	D		
0245	Cylinder Head	Inspect	0.2					27, 28,29,30, 31,32,33,34	
		Replace	1.5						
		Repair	1.5		4.5				
0246	Valve Operating Mechanism	Inspect	0.2					26	
		Adjust	0.8						
		Replace	1.5						
		Repair	2.5						
0247	Camshaft and Gear Train	Inspect	0.4					23, 24,25	
		Replace	6.0						
		Repair			3.5				
0248	Flywheel and Housing	Inspect	0.2					22	
		Replace	3.5						
		Repair	2.0		2.0 (weld)				
0249	Lube Oil Pressure Regulator	Inspect	0.1'						
		Adjust	0.4						
		Replace	1.0						
		Repair	1.5						
0250	Lube Oil Pump	Inspect	0.2					35, 36, 53	
		Replace	1.0						
		Repair			2.0				
0251	Lube Oil Distribution System	Inspect	0.2						
		Replace	1.2						
0252	Pistons, Con- necting Rods and Cylinder Liners	Inspect	1.0					33,34,37,38, 39, 41,42, 43, 44,45,46,47 21	
		Replace	4.5						
		Repair	5.5						
0253	Crankshaft	Inspect	0.5						
	Bearings	Inspect	0.4						
	Front Cover and Oil Seal	Inspect	0.2						
		Replace	1.0						

Section II. MAINTENANCE ALLOCATION CHART (Cont.)

(1) GROUP NUMBER	(2) COMPONENT/ ASSEMBLY	(3) MAINTENANCE FUNCTION	(4) MAINTENANCE LEVEL					(5) TOOLS AND EQUIPMENT	(6) REMARKS
			UNIT		DS	GS	DEPOT		
			C	O	F	H	D		
0254	Cylinder Block	Inspect	0.5						
		Replace			10.5				
		Repair	1.0		4.5				
0255	Instrument Panel	Inspect	0.2						
		Replace	1.5						
		Repair	2.0						
0256	Starting Aid	Inspect	0.1						
		Service	0.2						
		Replace	0.5						
		Repair	1.2						
0260	Hydrostarter (Hydrotor)	Inspect	0.2				48		
		Test			1.5				
		Replace Repair	1.2 1.2						
0262	Accumulator	Inspect	0.1						
		Service			1.0				
		Replace Repair	1.4 3.5				49		
0264	Hydrostarter Pump (Engine Driven)	Inspect	0.1						
		Replace	0.4						
		Repair	1.8						
0266	Hydrostarter Pump (Hand)	Inspect	0.1						
		Replace	1.2						
		Repair	2.5						
0267	Hydrostarter Piping (Forward Engine Room)	Inspect	0.2						
		Replace			2.7				
		Repair			1.5				
0268	Hydrostarter Piping (Aft Engine Room)	Inspect	0.2						
		Replace			2.7				
		Repair			1.5				

Section II. MAINTENANCE ALLOCATION CHART (Cont.)

(1) GROUP NUMBER	(2) COMPONENT/ ASSEMBLY	(3) MAINTENANCE FUNCTION	(4) MAINTENANCE LEVEL					(5) TOOLS AND EQUIPMENT	(6) REMARKS
			UNIT		DS	GS	DEPOT		
			C	O	F	H	D		
0269	Reservoirs	Inspect Replace Repair	0.2 1.0		1.0				
0270	Rectifier, 24 VDC	Inspect Replace Repair	0.5 2.0 2.0						
0272	Distribution Panels Lighting	Inspect Replace Repair	0.1 1.0		2.5				
0274	Switches	Inspect Replace	0.2 1.5						
0274A	Safety Switch, Air Compressor	Inspect Replace	0.1 1.0						
0281	Lights	Inspect Replace	0.2 1.5						
0282	Emergency Lighting	Inspect Replace Repair	0.2 1.5 1.0						
0282A	Rotary Light, Red, Fire Warning	Replace Repair	0.5 1.0						
0282B	Rotary Light, Amber, General Alarm	Replace Repair	0.5 1.0						
0282C	Lamp, Fluorescent, Red and White	Replace Repair	0.5 1.0						
0284	Running, Signal, and Anchor Lights	Inspect Replace Repair	0.2 1.5 1.0						
0285	Navigational Light Control Panel	Inspect Replace Repair	0.2 0.4		10.0				
0300	Bow Ramp and Winch	Overhaul					*	L	

Section II. MAINTENANCE ALLOCATION CHART (Cont.)

(1) GROUP NUMBER	(2) COMPONENT/ ASSEMBLY	(3) MAINTENANCE FUNCTION	(4) MAINTENANCE LEVEL					(5) TOOLS AND EQUIPMENT	(6) REMARKS
			UNIT		DS	GS	DEPOT		
			C	O	F	H	D		
0310	Bow Ramp, Sheaves, and Fairlead	Inspect	0.7						
		Replace			12.0				
		Repair	3.0						
0320	Winch Assembly	Inspect	0.3						
		Replace			80.0				
		Repair	20.0						
0322	Torque Coupling	Inspect	0.3						
		Replace	2.5						
		Repair	2.5						
0323	Speed Reducer	Inspect	0.3						
		Replace			25.0				
		Repair	1.0						
0324	Winch Brake and Motor	Inspect	0.4						
		Test	1.0						
		Replace			4.5				
		Repair	2.0						
0325	Controller	Inspect	0.2						
		Replace	3.5						
		Repair			2.0				
0326	Master Switch	Inspect	0.3						
		Replace			2.0				
		Repair	2.5						
0327	Limit Switches	Inspect	0.3						
		Replace	1.5						
		Repair	2.0						
0400	Stern Gate	Inspect	0.6						
		Service	1.0						
		Replace			7.0				
		Repair			15.0				
		Overhaul					*	L	

Section II. MAINTENANCE ALLOCATION CHART (Cont.)

(1) GROUP NUMBER	(2) COMPONENT/ ASSEMBLY	(3) MAINTENANCE FUNCTION	(4) MAINTENANCE LEVEL					(5) TOOLS AND EQUIPMENT	(6) REMARKS
			UNIT		DS	GS	DEPOT		
			C	O	F	H	D		
0410	Gate, Hinges, and Springs	Inspect Replace Repair	0.6		7.0 15.0				
0420	Portable Davit	Inspect Replace Repair	0.3 1.5		3.5				
0500	Anchor Handling System	Overhaul					*	L	
0510	Winch	Inspect Service Replace Repair	0.3 0.4 2.0		100.0 29.0				
0511	Drive Brake	Inspect Service Adjust Replace Repair	0.3 0.5 1.0 3.0 5.5		1.0 7.5				
0512	Drive Gear	Inspect Replace Repair	0.5 2.5		2.5 9.0				
0513	Level Wind	Inspect Service Replace Repair	0.3 0.2 1.5		15.0 5.5				
0514	Drum Assembly	Inspect Service Replace Repair	0.2 0.3 2.5	4.5	80.0				
0515	Slack Puller	Inspect Service Replace Repair	0.2 0.2 5.0		20.0 15.0				

Section II. MAINTENANCE ALLOCATION CHART (Cont.)

(1) GROUP NUMBER	(2) COMPONENT/ ASSEMBLY	(3) MAINTENANCE FUNCTION	(4) MAINTENANCE LEVEL					(5) TOOLS AND EQUIPMENT	(6) REMARKS
			UNIT		DS	GS	DEPOT		
			C	O	F	H	D		
0516	Disconnect Clutch	Inspect	0.3						
		Service	0.2						
		Replace			4.5				
		Repair			3.5				
0517	Torque Converter	Inspect	0.3						
		Service	0.6						
		Replace			26.0				
		Repair	5.5						
0518	Hydraulic Tank Assembly	Inspect	0.2						
		Service	0.6						
		Replace	3.5						
		Repair	20.0		2.0 (weld)				
0519	Winch Control	Inspect	0.2						
		Service	0.3						
		Replace	2.0						
		Repair	2.5						
0519A	Hoses, Lines, and Fittings	Inspect	0.5						
		Replace	2.5						
		Repair	2.5						
0520	Engine	Inspect	0.3						
		Service	1.0						
		Test			8.0				
		Replace			80.0				
		Repair	8.5						
		Overhaul					*		
0521	Diesel Throttle Controls	Inspect	0.2						
		Service	0.3						
		Replace			2.5 (weld)				
		Repair	2.5						

Section II. MAINTENANCE ALLOCATION CHART (Cont.)

(1) GROUP NUMBER	(2) COMPONENT/ ASSEMBLY	(3) MAINTENANCE FUNCTION	(4) MAINTENANCE LEVEL					(5) TOOLS AND EQUIPMENT	(6) REMARKS
			UNIT		DS	GS	DEPOT		
			C	O	F	H	D		
0522	Governor	Inspect	0.2					3, 4, 5, 6	
		Test			1.0				
		Replace	1.0						
0523	Air Intake	Repair	1.0					7, 8, 9	
		Inspect	0.2						
		Service	0.4						
0524	Blower	Replace	1.5					10,11	
		Repair	3.0						
		Inspect	0.3						
0525	Fuel Pump	Service	0.4					12,13,14	
		Replace	2.0						
		Repair	1.0						
0526	Fuel Filter and Strainer	Inspect	0.2					12,13,14,15, 50	
		Service	0.5						
		Replace	1.5						
0527	Fuel Injector	Repair	1.5					12,13,14,15, 50	
		Inspect	0.1						
		Test	0.3		0.5				
0528	Lube Oil Filter, Hoses and Housing	Replace	1.5					12,13,14,15, 50	
		Repair	1.4						
		Service	0.4						
0529	Lube Oil Cooler	Inspect	0.2					12,13,14,15, 50	
		Replace	1.2						
		Repair	1.5						

Section II. MAINTENANCE ALLOCATION CHART (Cont.)

(1) GROUP NUMBER	(2) COMPONENT/ ASSEMBLY	(3) MAINTENANCE FUNCTION	(4) MAINTENANCE LEVEL					(5) DEPOT EQUIPMENT	(6) TOOLS AND REMARKS
			UNIT		F	DS	GS		
			C	O		H	D		
0530	Fresh Water Pump	Inspect	0.2					11, 16, 17 18, 19, 52	
		Replace	1.2						
		Repair			2.5				
0531	Water Connections	Inspect	0.2						
		Repair	1.5						
0532	Water Manifold	Inspect	0.2						
		Replace	1.2						
		Repair	1.0		3.0 (weld)				
0533	Thermostat and Housing	Inspect	0.2						
		Replace	1.4						
		Repair	1.3		2.0 (weld)				
0534	Overspeed Governor	Inspect	0.2						
		Test	1.0						
		Adjust	0.5						
		Replace	1.0						
		Repair	1.0						
0535	Tachometer Drive	Inspect	0.2						
		Replace	1.6						
		Repair	1.5						
0535A	Air Cleaner	Inspect	0.1						
		Service	0.3						
		Replace	1.0						
		Repair	1.0						
0536	Crankshaft Pulley and Vibration Dampener	Inspect	0.2					21, 51	
		Replace	2.5						
		Repair	1.7						
0537	Balance Weight and Cover	Inspect	0.3					51	
		Replace	1.5						
0538	Engine Supports and Lifting Brackets	Inspect	0.4						
		Replace	2.5						
		Repair	1.0						

Section II. MAINTENANCE ALLOCATION CHART (Cont.)

(1) GROUP NUMBER	(2) COMPONENT/ ASSEMBLY	(3) MAINTENANCE FUNCTION	(4) MAINTENANCE LEVEL					(5) DEPOT EQUIPMENT	(6) TOOLS AND REMARKS
			UNIT		F	DS	GS		
			C	O		H	D		
0539	Exhaust Manifold	Inspect	0.2						
		Replace	2.5						
		Repair	2.5		2.5 (weld)				
0540	Rocker Arm Cover	Inspect	0.1						
		Replace	1.0						
0541	Injector Controls	Inspect	0.2						
		Adjust	0.3						
		Replace	1.5						
		Repair	2.0						
0542	Oil Pan and Dipstick	Inspect	0.2						
		Replace	1.5						
		Repair	1.5						
0543	Cylinder Head	Inspect	0.2					27, 28, 29, 30,31,32, 33, 34	
		Replace	1.5						
		Repair	1.5						
0544	Valve Operating Mechanism	Inspect	0.2						
		Adjust	0.8						
		Replace	1.5					26	
		Repair	2.5						
0545	Camshaft and Gear Train	Inspect	0.4					23, 24, 25	
		Replace	6.0						
		Repair	3.5						
0546	Flywheel and Housing	Inspect	0.2						
		Replace	3.5					22	
		Repair	2.0	2.0	2.0				
0547	Lube Oil Pressure Regulator Valve	Inspect	0.1						
		Adjust	0.4						
		Replace	1.0						
		Repair	1.5						
0548	Lube Oil Pump	Inspect	0.2						
		Replace	1.0					35, 36, 53	
		Repair	2.0						

Section II. MAINTENANCE ALLOCATION CHART (Cont.)

(1) GROUP NUMBER	(2) COMPONENT/ ASSEMBLY	(3) MAINTENANCE FUNCTION	(4) MAINTENANCE LEVEL					(5) DEPOT EQUIPMENT	(6) TOOLS AND REMARKS
			UNIT		F	DS H	GS D		
			C	O					
0549	Lube Oil Distribution System	Inspect	0.2						
		Replace	1.5						
0550	Pistons, Connecting Rods and Liners	Inspect	1.0					33, 34, 37, 38, 39, 41, 42, 43, 44, 45, 46, 47	
		Replace	4.5						
		Repair	5.5						
0551	Crankshaft	Inspect	0.5						
		Replace	6.5					21	
0551A	Bearings, Mains	Inspect	0.5						
		Replace	6.5					21, 51	
0552	Cylinder Block	Inspect	0.5						
		Replace	10.5						
		Repair	1.0	4.5					
0553	Instrument Panel	Inspect	0.1						
		Replace	1.5						
		Repair	2.0						
0554	Starting Aid	Inspect	0.1						
		Service	0.2						
		Replace	1.5						
		Repair	2.0						
0560	Hydrostarter (Hydrotor)	Inspect	0.2						
		Test			1.5			48	
		Replace	1.5						
0561	Accumulator	Repair	1.2						
		Inspect	0.1					49	
		Service	1.0						
0562	Hydrostarter Pump (Engine Driven)	Replace	1.4						
		Repair	3.5						
		Inspect	0.2						
0562	Hydrostarter Pump (Engine Driven)	Replace	1.2						
		Repair	2.5						

Section II. MAINTENANCE ALLOCATION CHART (Cont.)

(1) GROUP NUMBER	(2) COMPONENT/ ASSEMBLY	(3) MAINTENANCE FUNCTION	(4) MAINTENANCE LEVEL					(5) DEPOT EQUIPMENT	(6) TOOLS AND REMARKS
			UNIT		F	DS H	GS D		
			C	O					
0563	Hydraulic Pump (Hand)	Inspect	0.2						
		Replace	1.0						
		Repair	3.5						
0564	Reservoir	Inspect	0.2						
		Replace	1.9						
		Repair			1.0				
0565	Hydraulic Filter and Hoses	Inspect	0.2						
		Replace	2.0						
		Repair	1.0		2.0				
0570	"A" Frame, Wire Rope and Anchor	Inspect	0.5						
		Service	1.0						
		Replace			2.0				
		Repair			1.0				
0571	Fairlead	Inspect	0.2						
		Service	0.3						
		Replace			6.0				
0572	Wire Rope Cutter	Inspect	0.5						
		Repair	4.0						
0600	Mast	Inspect	0.5						
		Service	0.5						
		Replace			12.0				
		Repair	5.5		29.0				
0700	Ship's Hydraulic System	Service Overhaul	0.2				*	L	
0710	Hydraulic Power Unit								
0711	Electric Motor	Inspect	0.2		1.0				
		Replace	1.5						
		Repair			7.5				
0712	Hydraulic Pump	Inspect	0.3						
		Replace	3.5						
		Repair			5.5				

Section II. MAINTENANCE ALLOCATION CHART (Cont.)

(1) GROUP NUMBER	(2) COMPONENT/ ASSEMBLY	(3) MAINTENANCE FUNCTION	(4) MAINTENANCE LEVEL					(5) DEPOT EQUIPMENT	(6) TOOLS AND REMARKS
			UNIT		F	DS H	GS D		
			C	O					
0713	Relief Valve	Inspect	0.3						
		Adjust	0.5						
		Replace	1.0						
0714	Hydraulic Reservoir	Inspect	0.3						
		Replace	2.5						
		Repair	1.0		2.0				
0715	Controller	Inspect	0.3						
		Replace	2.5						
		Repair			4.5				
0716	Gages	Inspect	0.5						
		Replace	1.3						
0717	Push Button Switch	Inspect	0.2						
		Replace	1.7						
		Repair	1.0						
0720	Stem Gate Hydraulic System								
0721	Hydraulic Control	Inspect	0.4						
		Replace	3.0						
		Repair			10.5				
0723	Hoses, Fittings and Pipings	Inspect	0.5						
		Replace	4.2						
0724	Hydraulic Ram	Inspect	0.5						
		Replace	3.5						
		Repair			10.5				
0730	Mast Hydraulic System								
0731	Hydraulic Ram	Inspect	0.5						
		Replace	3.5						
		Repair			10.5				
0732	Hydraulic Control	Inspect	0.4						
		Replace	3.0						
		Repair			10.5				

Section II. MAINTENANCE ALLOCATION CHART (Cont.)

(1) GROUP NUMBER	(2) COMPONENT/ ASSEMBLY	(3) MAINTENANCE FUNCTION	(4) MAINTENANCE LEVEL					(5) DEPOT EQUIPMENT	(6) TOOLS AND REMARKS
			UNIT		F	DS H	GS D		
			C	O					
0734	Hoses and Fittings	Inspect Replace	0.5 4.7		11.0				
0740	Stern Anchor Hydraulic System								
0741	Hydraulic Winch	Inspect Replace Repair	0.5 3.0 2.0		10.5				
0742	Hydraulic Control	Inspect Replace Repair	0.4 3.0		10.5				
0743	Hoses and Fittings	Inspect Replace	0.5 4.2						
0800	Steering Systems	Overhaul					*	L	
0810	Motor	Inspect Replace Repair	0.3 2.0 2.0		7.0				
0811	Motor Controller	Inspect Replace Repair	0.5 2.5		4.5				
0812	Hydraulic Pump	Inspect Replace Repair	0.3 2.0 2.0		7.0				
0813	Brake Valve	Inspect Replace Repair	0.3 2.5		4.5				
0814	Directional Control Valve	Inspect Replace Repair	0.3 2.5 4.5						
0815	Hydraulic Cylinder and Linkage	Inspect Adjust Replace Repair	1.0 1.0 1.8		15.0 13.0				

Section II. MAINTENANCE ALLOCATION CHART (Cont.)

(1) GROUP NUMBER	(2) COMPONENT/ ASSEMBLY	(3) MAINTENANCE FUNCTION	(4) MAINTENANCE LEVEL					(5) DEPOT EQUIPMENT	(6) TOOLS AND REMARKS
			UNIT		F	DS H	GS D		
			C	O					
0816	Hydraulic Hoses, Piping and Valves	Inspect	1.0						
		Replace			15.0				
		Repair	2.0		12.0				
0817	Main and Flanking Rudders	Inspect			4.0				
		Replace			20.0				
		Repair			10.0				
0820	Rudder Angle Indicator	Inspect	0.5						
		Replace			4.0				
		Repair	1.5						
0821	Rudder Angle Transmitter	Inspect	0.5						
		Replace	4.0						
		Repair	1.0						
0830	Flanking Rudder Limit Switch	Inspect	0.2						
		Replace	1.0						
		Repair	0.2						
0840	Steering Control Panel and Gyro Computer	Inspect	0.5						
		Replace	2.5					G	
		Repair	2.0						
0850	Heading Selector	Inspect	0.5						
		Replace	0.5						
		Repair	1.5						
0860	Remote Magnetic Heading Compass	Inspect	0.5						
		Adjust			2.5				
		Replace			7.0				
		Calibrate			3.5			H	
0870	Emergency Steering System	Inspect	1.0						
		Replace	2.0						
		Repair	2.5						

Section II. MAINTENANCE ALLOCATION CHART (Cont.)

(1) GROUP NUMBER	(2) COMPONENT/ ASSEMBLY	(3) MAINTENANCE FUNCTION	(4) MAINTENANCE LEVEL					(5) DEPOT EQUIPMENT	(6) TOOLS AND REMARKS
			UNIT		F	DS H	GS D		
			C	O					
0880	Ship's Course Indicator	Inspect Replace Repair	0.7 5.0 12.5		40.0				
0900	Pump Sets	Overhaul					*	L	
0910	Portable Fire Pump Set	Inspect Service Test Adjust Replace Repair	0.6 1.2 1.5 1.5 5.0 3.5						
0911	Fire Pump	Inspect Service Replace Repair	0.2 0.4 2.5 2.0		3.5				
0912	Motor	Inspect Service Replace Repair	0.2 0.4 5.0 2.5		4.5				
0913	Controller (Starter)	Inspect Replace Repair	0.2 2.0		3.5 4.0				
0920	Bilge Pump Set								
0921	Pump	Inspect Service Replace Repair	0.4 0.5 4.5 2.5		5.0				
0922	Foundation and Drive	Inspect Replace Repair	0.2 3.0 3.0		3.5 1.5				

Section II. MAINTENANCE ALLOCATION CHART (Cont.)

(1) GROUP NUMBER	(2) COMPONENT/ ASSEMBLY	(3) MAINTENANCE FUNCTION	(4) MAINTENANCE LEVEL					(5) DEPOT EQUIPMENT	(6) TOOLS AND REMARKS
			UNIT		F	DS			
			C	O		H	D		
0930	Lube Oil Pump Set	Inspect	0.4						
		Service	0.5						
		Replace	5.0						
		Repair	8.5						
0931	Pump	Inspect	0.2						
		Replace	4.0						
		Repair	2.5		4.5				
0932	Motor	Inspect	0.2						
		Replace	1.5						
		Repair	2.5		4.5				
0933	Controller (Starter)	Inspect	0.2						
		Replace			3.5				
		Repair	2.0		6.0				
0940	Fresh Water Pump Set	Inspect	0.4						
		Replace	5.0						
		Repair	2.5						
0941	Pump	Inspect	0.2						
		Replace	2.5						
		Repair	7.5						
0942	Motor	Inspect	0.2						
		Replace	2.5						
		Repair	2.5		4.5				
0943	Controller (Starter)	Inspect	0.2						
		Replace	3.5						
		Repair	2.0		6.0				
0950	Air Conditioning Water Circulating Pump Set	Inspect	0.4						
		Replace	5.5						
		Repair	8.0						
0951	Pump	Inspect	0.2						
		Replace	3.5						
		Repair	2.0		6.5				

Section II. MAINTENANCE ALLOCATION CHART (Cont.)

(1) GROUP NUMBER	(2) COMPONENT/ ASSEMBLY	(3) MAINTENANCE FUNCTION	(4) MAINTENANCE LEVEL					(5) DEPOT EQUIPMENT	(6) TOOLS AND REMARKS
			UNIT		F	DS H	GS D		
			C	O					
0952	Motor	Inspect	0.2						
		Replace	1.5						
		Repair	2.5		4.5				
0953	Controller (Starter)	Inspect	0.2						
		Replace	3.5						
		Repair	2.0		4.0				
0960	Diesel Oil Cooling Pump Set	Inspect	0.4						
		Replace	5.5						
		Repair	5.0						
0961	Pump	Inspect	0.2						
		Replace	3.5						
		Repair	4.5						
0962	Motor	Inspect	0.2						
		Replace	3.5						
		Repair	2.5		4.5				
0963	Controller (Starter)	Inspect	0.2						
		Replace	3.5						
		Repair	4.0						
0970	Lube Oil Transfer Pump (Hand)	Inspect	0.2						
		Service	0.2						
		Replace	2.0						
		Repair	2.0						
1000	Sewage System	Overhaul					*	L	
1010	Sewage System Discharge Pump	Inspect	0.4						
		Service	0.5						
		Replace	6.0						
		Repair	5.5		3.5				
1011	Pump	Inspect	0.2						
		Service	0.3						
		Replace	3.5						
		Repair	4.5						

Section II. MAINTENANCE ALLOCATION CHART (Cont.)

(1) GROUP NUMBER	(2) COMPONENT/ ASSEMBLY	(3) MAINTENANCE FUNCTION	(4) MAINTENANCE LEVEL					(5) DEPOT EQUIPMENT	(6) TOOLS AND REMARKS
			UNIT		F	DS	GS		
			C	O		H	D		
1012	Motor	Inspect	0.2						
		Service	0.2						
		Replace	3.8						
		Repair	5.0						
1020	Sewage System Macerator/Transfer Pump	Inspect	0.4						
		Service	2.0						
		Replace	3.0						
		Repair	2.0						
1021	Motor	Inspect	0.2						
		Replace	3.5						
		Repair	2.0		4.5				
1030	Sewage System Air Pump	Inspect	0.3						
		Service	0.2						
		Replace	3.0						
		Repair	2.0						
1031	Motor	Inspect	0.2						
		Replace	3.5						
		Repair	2.0		4.5				
1040	Toilet	Inspect	0.2						
		Service	0.7						
		Replace	3.8						
		Repair	5.0						
1050	Urinal	Inspect	0.2						
		Replace	2.0						
		Repair	2.0						
1060	Controller (Starter)	Inspect	0.2						
		Replace	3.5						
		Repair	2.0		4.0				
1070	Sewage System Piping	Inspect	1.0						
		Replace			20.0				
		Repair	2.0		18.0				

Section II. MAINTENANCE ALLOCATION CHART (Cont.)

(1) GROUP NUMBER	(2) COMPONENT/ ASSEMBLY	(3) MAINTENANCE FUNCTION	(4) MAINTENANCE LEVEL					(5) DEPOT EQUIPMENT	(6) TOOLS AND REMARKS
			UNIT		F	DS	GS		
			C	O		H	D		
1080	Sewage Holding Tank	Inspect	0.5						
		Service	2.5						
		Replace			90.0				
		Repair	2.5						
1100	Heating, Ventilation and Air Conditioning System (HVAC)	Overhaul					*	L	
1111	HVAC Supply, Fan and Motor Sets	Inspect	0.5						
		Service	1.0						
		Replace	5.0						
		Repair	2.5		5.0				
1112	HVAC Ducting	Inspect	0.7						
		Service	1.2						
		Replace			13.5				
		Repair			7.5				
1121	HVAC Exhaust System Fan and Motor Sets	Inspect	0.5						
		Service	1.0						
		Replace	5.0						
		Repair	2.5		5.0				
1131	HVAC Heating System Heaters	Inspect	0.5						
		Service	1.0						
		Replace	3.0						
		Repair	2.5						
1140	HVAC Air Conditioning System								
1141	Compressor	Inspect	0.3						
		Service	1.0		6.0				
		Replace			2.5				
		Repair	2.0		6.5				
1142	Condenser	Inspect	3.0						
		Service	1.0						
		Replace	3.5						
		Repair	4.5						

Section II. MAINTENANCE ALLOCATION CHART (Cont.)

(1) GROUP NUMBER	(2) COMPONENT/ ASSEMBLY	(3) MAINTENANCE FUNCTION	(4) MAINTENANCE LEVEL					(5) DEPOT EQUIPMENT	(6) TOOLS AND REMARKS
			UNIT		F	DS	GS		
			C	O		H	D		
1143	Strainer	Inspect	0.3						
		Service	0.6						
		Replace	1.2						
1144	Drier	Inspect	0.2						
		Service	0.5						
		Replace	1.0						
1145	Gage Board	Inspect	0.3						
		Adjust	0.5						
		Replace	3.0						
		Repair	2.5						
1146	Thermal Expansion Valve	Inspect	0.2						
		Adjust	0.6						
		Replace	1.5						
		Repair	1.0						
1150	Miscellaneous Valves and Headers								
1151	Liquid Solenoid Valve	Inspect	0.5						
		Replace	1.0						
		Repair	2.0						
1152	Receiver	Inspect	0.5						
		Replace	1.0						
		Repair	1.0						
1153	Heat Interchanger	Inspect	0.5						
		Replace	3.0						
1154	Water Regulating Valve	Inspect	0.5						
		Service	0.5						
		Adjust	0.5						
		Replace	2.0						
1154A	Thermostat	Inspect	0.5						
		Replace	1.0						
1155	Thermometer	Inspect	0.5						
		Replace	0.5						

Section II. MAINTENANCE ALLOCATION CHART (Cont.)

(1) GROUP NUMBER	(2) COMPONENT/ ASSEMBLY	(3) MAINTENANCE FUNCTION	(4) MAINTENANCE LEVEL					(5) DEPOT EQUIPMENT	(6) TOOLS AND REMARKS
			UNIT		F	DS	GS		
			C	O		H	D		
1156	Controller	Inspect Replace Repair	0.5 2.0 1.5						
1200	Commissary Space Equipment								
1210	Refrigerator/Freezer	Inspect Service Replace Repair	0.4 1.0 3.0		6.0 30.0 10.0				
1220	Toaster	Inspect Replace Repair	0.1 0.5 1.5						
1230	Drinking Fountain	Inspect Service Replace Repair	0.3 1.0 3.5 2.8						
1240	Milk Dispenser	Inspect Service Replace Repair	0.3 0.6 2.0 1.5		4.0 3.0				
1250	Coffee Maker	Inspect Replace Repair	0.1 0.5 1.5						
1260	Washer/Dryer	Inspect Service Replace Repair	2.0 0.3 12.0 2.5		10.0				
126001	Washer/Dryer Exterior	Inspect Repair	0.3 3.0						
126002	Washer/Dryer Drum Heater	Inspect Repair	0.5 3.0						
126003	Washer/Dryer Blower	Inspect Repair	0.4 1.5						

Section II. MAINTENANCE ALLOCATION CHART (Cont.)

(1) GROUP NUMBER	(2) COMPONENT/ ASSEMBLY	(3) MAINTENANCE FUNCTION	(4) MAINTENANCE LEVEL					(5) DEPOT EQUIPMENT	(6) TOOLS AND REMARKS
			UNIT		F	DS			
			C	O		H	D		
126004	Washer/Dryer Tubs	Inspect	1.0					K	
		Water Valve and Lid Switch Repair	4.0						
126005	Washer/Dryer Drive Pump System	Inspect	0.5						
		Adjust	0.5						
		Repair	2.5						
126006	Washer/Dryer Transmission, Water Seal and Lower Bearing	Inspect	0.5						
		Replace	2.0						
		Repair	5.0						
1270	Sanitizing Sink Heater	Inspect	0.2						
		Replace	3.0						
		Repair	2.0						
1280	Galley Range	Inspect	0.2						
		Replace	30.0						
		Repair	5.0						
1300	Washroom Fixtures	Inspect	0.2						
		Replace	1.5						
		Repair	1.0						
1400	Fire Fighting System	Overhaul					*		L
1410	Fire Fighting Components	Inspect	0.2						
		Test	0.5						
		Replace	2.5						
1420	Halon Control Panel	Inspect	0.3						
		Test	0.6						
		Replace	2.0						
		Repair	2.0						
1430	Pneumatic Heat Detector	Test	0.5						
		Replace	1.0						
1440	Cylinder Assembly, 1301,40 Pound	Inspect	0.3						
		Test	1.0						
		Service	1.0						
		Replace	4.0						

Section II. MAINTENANCE ALLOCATION CHART (Cont.)

(1) GROUP NUMBER	(2) COMPONENT/ ASSEMBLY	(3) MAINTENANCE FUNCTION	(4) MAINTENANCE LEVEL					(5) DEPOT EQUIPMENT	(6) TOOLS AND REMARKS
			UNIT		F	DS H	GS D		
			C	O					
1450	Cylinder Assembly, 1301, 60 Pound	Inspect	0.3						
		Test	1.0						
		Service	1.0						
		Replace	4.0						
1460	Halon System Piping and Wiring	Inspect	1.0						
		Test	2.0						
		Repair	6.0						
1500	Interior s Communication System	Inspect	1.0						
		Service	2.0						
		Test	1.0						
		Replace			15.0				
		Repair Overhaul	5.0		20.0		*	L	
1510	Alarm Pane	Inspect	0.5						
		Test	1.0						
		Replace			30.0				
		Repair	5.0		20.0				
1600	Electronic/Navigation Systems	Inspect	1.0						
		Test	1.5						
		Replace			25.0				
		Repair	2.0		12.0				
		Overhaul					*	L	
1610	VHF Antenna	Inspect	1.0						
		Replace			10.0				
		Repair			13.5				
1700	Oil/Water Separation System	Inspect	0.5						
		Service	1.5						
		Replace	20.0						
		Repair	2.0		13.5				
		Overhaul					*	L	
1800	Piping Systems	Overhaul					*	L	

Section II. MAINTENANCE ALLOCATION CHART (Cont.)

(1) GROUP NUMBER	(2) COMPONENT/ ASSEMBLY	(3) MAINTENANCE FUNCTION	(4) MAINTENANCE LEVEL					(5) DEPOT EQUIPMENT	(6) TOOLS AND REMARKS
			UNIT		F	DS H	GS D		
			C	O					
1801	Pipe Hangers	Inspect Replace	1.0		5.0				
1810	Fire, Bilge and Ballast Piping System	Inspect Replace Repair	1.5 3.0		30.0 22.0				
1822	Machinery Cooling Keel Coolers	Inspect Replace Repair	1.0 2.0		25.0 18.0				
1830	Lube Oil Piping System	Inspect Replace Repair	1.0 2.0		20.0 18.0				
1832	Diesel Oil Storage Tank Piping System	Inspect Replace Repair	1.0 2.0		20.0 18.0				
1840	Diesel Oil Piping	Inspect Replace Repair	1.0 2.0		20.0 18.0				
1845	Diesel Oil Coolers	Inspect Replace Repair	1.0 1.5 1.5		10.0				
1846	Duplex Strainer	Inspect Service Replace Repair	0.5 0.5 2.0 2.0						
1847	Fuel Filters and Water Separator	Inspect Service Replace Repair	0.5 0.5 1.5 2.0						
1850	Washdown Countermeasure Piping System	Inspect Replace Repair	1.0 20.0 2.0						

Section II. MAINTENANCE ALLOCATION CHART (Cont.)

(1) GROUP NUMBER	(2) COMPONENT/ ASSEMBLY	(3) MAINTENANCE FUNCTION	(4) MAINTENANCE LEVEL					(5) DEPOT EQUIPMENT	(6) TOOLS AND REMARKS
			UNIT		F	DS H	GS D		
			C	O					
1870	Engine Exhaust Piping System	Inspect	1.0						
		Replace			20.0				
		Repair	2.0		18.0				
1890	Oil/Water Separator Piping	Inspect	1.0						
		Replace	1.0		20.0				
		Repair	2.0		18.0				
1895	Deck Fittings	Inspect	1.8						
		Replace			5.0				
		Repair	1.8		10.5				
1900	Tanks and Voids	Inspect	1.0						
		Replace			20.0				
		Repair	2.0		18.0				
		Overhaul					*	L	
1905	Receiver	Inspect	0.5						
		Test	0.5						
		Adjust	1.5						
		Replace			6.0				
		Repair	5.5		5.5				
1911	Transmitter	Inspect	0.5						
		Test	0.5						
		Replace	6.0						
1912	Cables	Inspect	1.0						
		Replace	4.5						
1913	Brackets	Inspect	1.0						
		Replace	4.5						
1914	Tank Penetrations	Inspect	0.5						
		Repair	4.5						
1915	Hot Water Heater	Inspect	0.5						
		Replace			20.0				
		Repair	5.0						

Section II. MAINTENANCE ALLOCATION CHART (Cont.)

(1) GROUP NUMBER	(2) COMPONENT/ ASSEMBLY	(3) MAINTENANCE FUNCTION	(4) MAINTENANCE LEVEL					(5) DEPOT EQUIPMENT	(6) TOOLS AND REMARKS
			UNIT		F	DS H	GS D		
			C	O					
2000	Plumbing and Deck Drains	Inspect Replace Repair Overhaul	1.0		8.0				L
2100	Vents and Sounding Tubes	Inspect Replace Repair Overhaul	1.2		10.5				L
2200	Hull and Outfit	Overhaul							L
2210	Stanchions and Railings	Inspect Replace	1.2 22.0						
2213	Furniture and Misc. Furnishings	Inspect Replace	1.8 2.5		7.5				
2214	Portable Air Compressor	Inspect Replace Repair	0.5 1.0 2.5						
2215	Doors, Hatches, Scuttles and Manholes	Inspect Replace Repair	2.0 8.0 4.0		15.0 15.0				
2216	Windows and Airports	Inspect Replace Repair	1.5 10.0 3.0						
2217	Mooring and Towing Fittings	Inspect Replace	1.0 12.0						
2218	High Intensity Lights	Inspect Test Replace Repair	1.0 0.5 2.0 3.5						

Section II. MAINTENANCE ALLOCATION CHART (Cont.)

(1) GROUP NUMBER	(2) COMPONENT/ ASSEMBLY	(3) MAINTENANCE FUNCTION	(4) MAINTENANCE LEVEL					(5) DEPOT EQUIPMENT	(6) TOOLS AND REMARKS
			UNIT		F	DS	GS		
			C	O		H	D		
2219	Windshield Wipers	Inspect	0.8						
		Test	0.8						
		Replace	5.0						
		Repair	3.0						
2220	Searchlight	Inspect	0.2						
		Service	0.7						
		Repair	2.5						
		Replace	1.5						
2221	Vehicle Lashing Gear	Inspect	1.0						
		Replace	4.5						
		Repair	6.5						
2222	Air Horn System	Inspect	0.5						
		Test	0.2						
		Replace	3.0						
		Repair	4.0						
222201	Air Horn Piping	Inspect	1.0						
		Test	1.0						
		Repair	4.0						
222202	Air Horn	Inspect	0.2						
		Test	0.2						
		Replace	1.0						
		Repair	1.5						
222203	Whistle Valve	Test	0.2						
		Replace	1.5						
		Repair	1.0						
222204	Air Strainer Assembly	Service	0.3						
		Replace	1.0						
222205	Air Compressor Unit	Inspect	0.3						
		Replace	4.0						
		Repair	8.0						
22220501	Air Compressor	Replace	2.0						
		Repair	8.0						

SECTION III. TOOL AND TEST EQUIPMENT REQUIRED (Cont.)

TOOL OR TEST EQUIPMENT REF CODE	MAINTENANCE CATEGORY	NOMENCLATURE	NATIONAL/NATO STOCK NUMBER	TOOL NUMBER
1	C, H	Gage, Compression	6220-01-065-3441	J4897-5 (33287)
2	C, H	Adapter, Compression Gage	5210-00-999-8777	J7915-02(33287)
3	C, H	Gage, Governor Gap (.200)	5210-01-048-7085	J23478 (33287)
4	C, H	Gage, Governor Gap (.0015)	5210-01-048-6532	J23185 (33287)
5	C, H	Gage, Governor Linkage	5210-00-125-4415	J21304(33287)
6	C, H	Wrench, Governor High Speed	5120-00-627-9311	J1652-01(33287)
7	C, H	Clamp Set, Alignment		J21834-01(33287)
8	C, H	Cam Installer, Blower Drive	5120-00-219-8405	J1471 (33287)
9	C, H	Tool Set, Blower Service	4940-00-611-7945	J6270-04(33287)
10	C, H	Tool Set, Fuel Pump		J1508-02 (33287)
11	C, H	Wrench, Fuel & Water Pump	5120-00-591-2685	J4242(33287)
12	H	Reamer, Injector Body	5110-00-937-7628	J21089(33287)
13	H	Service Set, Injector	5220-00-483-1375	J23435(33287)
14	C, H	Timing Gage, Injector 1.484	5210-00-474-6400	J1242(33287)
15	H	Lapping Block Set, Injector	3460-00-937-5521	J22090 (33287)
16	C, H	Installer, Water Pump Oil Seal	5120-01-012-9151	J22150(33287)
17	C, H	Installer, Water Pump Seal	5120-00-937-7267	J8501 (33287)
18	C, H	Remover, Water Pump Coupling and Oil Seal	5120-00-363-7572	J1930(33287)
19	C, H	Remover, Water Pump Impeller	2040-01-057-6267	J22143(33287)
20	C, H	Installer, Flywheel Housing Oil Seal	5120-00-999-8619	J9727(33287)

SECTION III. TOOL AND TEST EQUIPMENT REQUIRED (Cont.)

TOOL OR TEST EQUIPMENT REF CODE	MAINTENANCE CATEGORY	NOMENCLATURE	NATIONAL/NATO STOCK NUMBER	TOOL NUMBER
21	C, H	Puller, Crankshaft Pulley	5120-00-671-4494	J4558-01(33287)
22	C, H	Lifter, Flywheel	4910-00-722-3877	J6361-01(33287)
23	C, H	Puller, Camshaft Gear	5120-00-219-8397	J1902-01(33287)
24	C, H	Installer, Camshaft Gear	5120-00-473-7456	J1903 (33287)
25	C, H	Service Fixture, Camfollower	2815-00-705-9278	J5840-01(33287)
26	C, H	Remover Set, Push Rod	5120-00-494-1843	J3092-01(33287)
27	C, H	Wrench, Cylinder Head	5120-01-013-1677	J1928-01(33287)
28	C, H	Wrench, Torque, 1/2" Drive, 0-300 Ft. Lbs.	5120-00-247-2536	GGG-W-00686 (81348)
29	H	Reconditioning Kit, Injector Tube	2910-00-146-9619	J22525(33287)
30	C, H	Remover, Valve Seat Insert	5120-00-999-8613	J6567-02(33287)
31	C, H	Installer, Valve Seat Insert	5120-00-733-8876	K6568 (33287)
32	C, H	Compressor, Valve Spring	5210-00-733-8888	J7455(33287)
33	C, H	Lifting Fixture, Cylinder Head	4910-00-432-7620	J22062-01(33287)
34	C, H	Stud Set, Guide	4910-00-591-6634	J9665(33287)
35	C, H	Installer, Oil Pump Drive Gear		J22285 (33287)
36	C, H	Installer, Oil Pump Gear	5120-00-937-7268	J8509 (33287)
37	C, H	Reamer Set, Connecting Rod Bushing	4910-00-733-8896	J1686-03(33287)
38	C, H	Remover, Connecting Rod Nozzle	5120-00-937-7632	J8995(33287)
39	C, H	Hold-down Clamp, Cylinder Liner	5120-00-219-8394	J21793-01(33287)

SECTION III. TOOL AND TEST EQUIPMENT REQUIRED (Cont.)

TOOL OR TEST EQUIPMENT REF CODE	MAINTENANCE CATEGORY	NOMENCLATURE	NATIONAL/NATO STOCK NUMBER	TOOL NUMBER
40	C, H	Wrench, Torque, 3/4" Drive	5120-00-221-7983	
41	C, H	Remover, Cylinder Liner	5120-00-387-9615	J1918-02(33287)
42	C, H	Gage, Cylinder Diameter Checking	5210-01-070-4543	J5347-01(33287)
43	C, H	Installer and Remover Set, Piston and Connecting Rod Bushing	5180-00-776-7240	J1513-02(33287)
44	C, H	Reaming Fixture, Piston Bushing	4910-00-779-6163	J5273 (33287)
45	C, H	Assembly Tool, Piston Ring	5120-00-494-1846	J8128 (33287)
46	C, H	Compressor, Piston Ring	5120-00-859-6259	J3272-03(33287)
47	C, H	Gage, Master Ring	5120-00-937-7631	J8386-01(33287)
48	C, H	Remover and Installer Set, Blower Rotor Shaft	5120-00-113-1004	J4254(33287)
49	C, H	Tool, Shaft Seal Aligning		52407 (58849)
50	C, H	Gage, Injector Timing (1.460)	5220-00-387-9851	J1853 (33287)
51	C, H	Installer, Crankshaft Oil Seal, Front	5120-00-936-4377	J9783 (33287)
52	C, H	Installer, Water pump Seal	2815-00-018-2631	J21971 (33287)
53	C, H	Reconditioning Set, Lube Oil	5180-00-113-3168	J2624 (33287)

SECTION IV. REMARKS

REFERENCE CODE	REMARKS
A	All tools required for repair/overhaul of Twin Disc marine gear to be made locally in accordance with instructions contained in technical manual for MG514 Marine Gear DM-133.
B	Used only on Detroit Diesel Hydraulic Starting System.
C	Used only on American Bosch Hydraulic Starting System.
D	Use Compound (P/N 5198653) (72582) when reassembling fresh water pump.
E	Adhere to drawing 203-4661553 when disassembling propeller shafts.
F	Propellers and propeller shaft will be carried on board even though the maintenance level is not crew/operator, to give the craft the "Get home " capability.
G	General Support units will not attempt in-depth repair of Gyro Compasses. Report them to the National Maintenance Point (NMP).
H	No Field repair is authorized on the Remote Magnetic Heading System (RMHS). Report them to the National Maintenance Point (NMP).
I	Refer to TM 5-2815-251-14, Detroit Diesel Engines, V-71, Section 1.4.
J	Replacement of Fuse Cartridge.
K	Drive Belt Adjustment.
L	Depot Level Repair/Maintenance will be performed on a case by case basis, subject to approval and funding by the National Maintenance Point (NMP).

APPENDIX C
COMPONENTS OF END ITEMS AND
BASIC ISSUE ITEMS LIST.

SECTION I. INTRODUCTION.

C-1. SCOPE

This appendix lists components of end item and basic issue items for the Landing Craft to help you inventory items required for safe and efficient operation.

C-2. GENERAL

The Components of End Item and Basic Issue Items Lists are divided into the following sections:

a. Section II. Components of End Item. This listing is for informational purposes only, and is not authority to requisition replacements. These items are part of the end item, but are removed and separately packaged for transportation or shipment. As part of the end item, these items must be with the end item whenever it is issued or transferred between property accounts. Illustrations are furnished to assist you in identifying the items.

b. Section III. Basic Issue Items. These are the minimum essential items required to place the Landing Craft in operation, to operate it, and to perform emergency repairs. Although shipped separately packaged BII must be with the Landing Craft during operation and whenever it is transferred between property accounts. The illustrations will assist you with hard-to-identify items. This manual is your authority to request/requisition replacement BII, based on TOE/MTOE authorization of the end item.

C-3. EXPLANATION OF COLUMNS

The following provides an explanation of columns found in the tabular listings:

a. Column (1) - Illustration Number (Illus Number). This column indicates the number of the illustration in which the item is shown.

b. Column (2) - National Stock Number. Indicates the National stock number assigned to the item and will be used for requisitioning purposes.

c. Column (3) - Description. Indicates the National item name and, if required, a minimum description to identify and locate the item. The last line for each item indicates the FSCM (in parentheses) followed by the part number.

SECTION I. INTRODUCTION (CONTINUED).

d. Column (4) - Unit of Measure (U/M). Indicates the measure used in performing the actual operational/maintenance function. This measure is expressed by a two-character alphabetical abbreviation (e.g., ea, in, pr).

e. Column (5) - Quantity required (Qty rqr). Indicates the quantity of the item authorized to be used with/on the equipment.

SECTION II. COMPONENTS OF END ITEMS LIST.

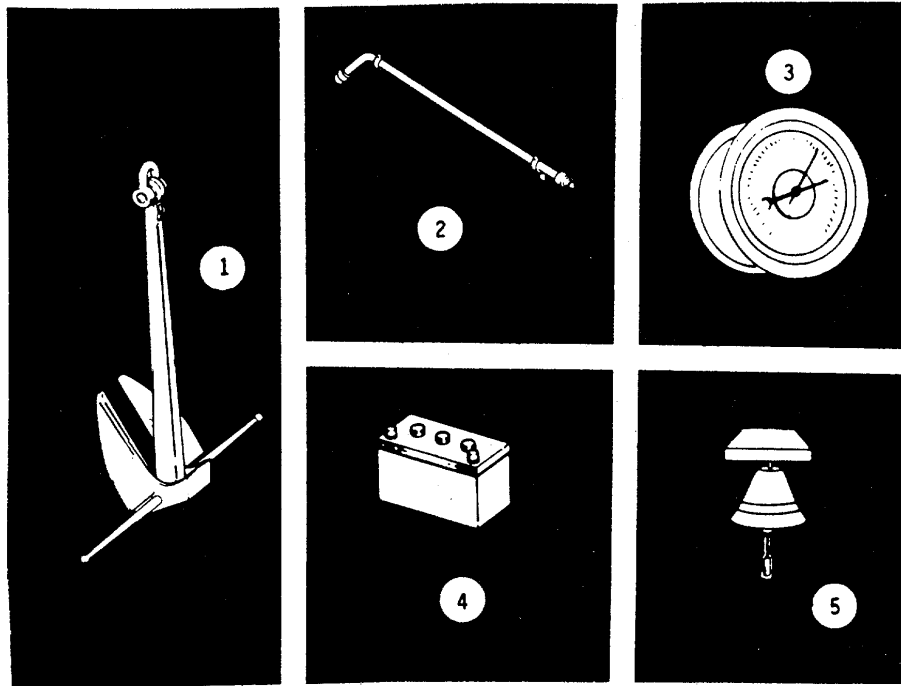

(1) ILLUS NO.	(2) NATIONAL STOCK NUMBER	(3) DESCRIPTION FSCM AND PART NUMBER	(4) USABLE ON CODE U/M	(5) QTY RQR
1	2040-00-377-8607	Anchor, Marine, Fluked, 15500 lb (81349) MIL-A- 15707	EA	2
2	4210-00-372-0864	Applicator, Nozzle, Fog, 4 (81348) MIL-S-1070	EA	3
3	6660-00-075-6666	Barometer, Aneroid (81349) MIL-B-17896B	EA	1
4	6140-00-105-5341	Battery, Storage, 6V 100AH (81348) W-B-131	EA	4
5	6350-00-256-9062	Bell, Ships 30 lb. "A" flat (81349) MIL-B-674	EA	1

SECTION II. COMPONENTS OF END ITEMS LIST (CONTINUED).

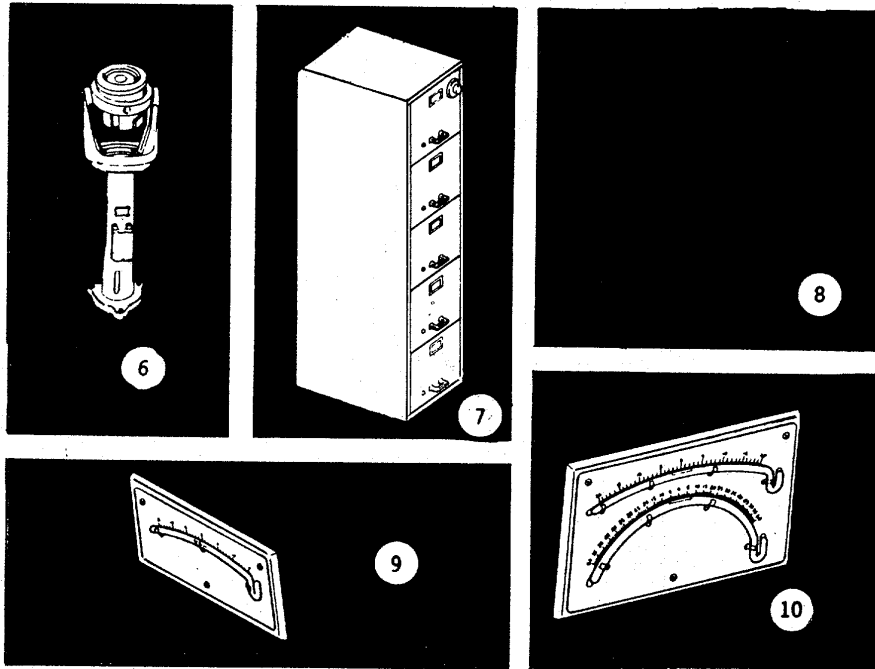

(1) ILLUS NO.	(2) NATIONAL STOCK NUMBER	(3) DESCRIPTION FSCM AND PART NUMBER USABLE ON CODE	(4) U/M	(5) QTY RQR
6	6605-00-530-0459	Binnacle Assembly (03956) 1887627	EA	1
7		Cabinet, Filing 4 Drawer W/Combination Lock (80064) 805-163842	EA	1
8		Cable, Shore Power, W/Lugs, THOF-15 (81349) MIL-C-915	FT	75
9	6605-00-618-3887	Clinometer, Ship's Keel (81349) MIL-C-200061, Type II	EA	1
10		Clinometer, Ship, Trim (81349) MIL-C-200061, Type 1	EA	1

SECTION II. COMPONENTS OF END ITEMS LIST (CONTINUED).

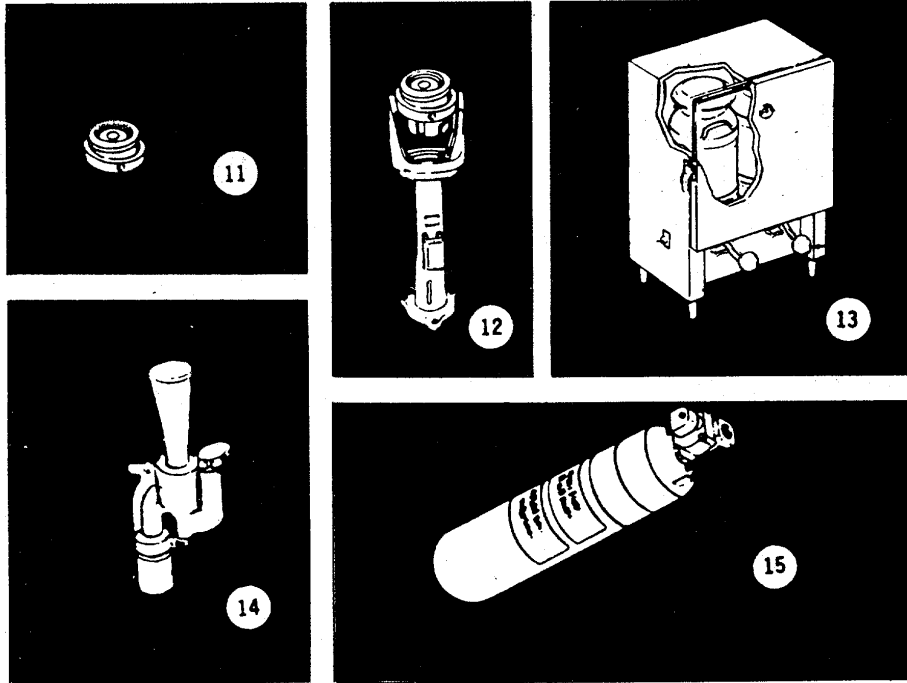

(1) ILLUS NO.	(2) NATIONAL STOCK NUMBER	(3) DESCRIPTION FSCM AND PART NUMBER USABLE ON CODE	(4) U/M	(5) QTY RQR
11	6605-00-248-0595	Compass Magnetic (80064) Navy No. 3 S2407A533821	EA	1
12	6605-00-019-0481	Compass, Gyro, MK27, MOD 1, W/70VDC Step by Step, 1X & 36X 400HZ Transmission	EA	1
13	7310-00-345-9903	Dispenser, Milk, Refrigerated 10 gal (21880) NIOM	EA	1
14	4320-00-256-8206	Eductor 4 inch (71905) 485011	EA	1
15	4210-00-203-0341	Extinguisher, Fire, Fixed 50 lb (33333) NO REF	EA	1

SECTION II. COMPONENTS OF END ITEMS LIST (CONTINUED).

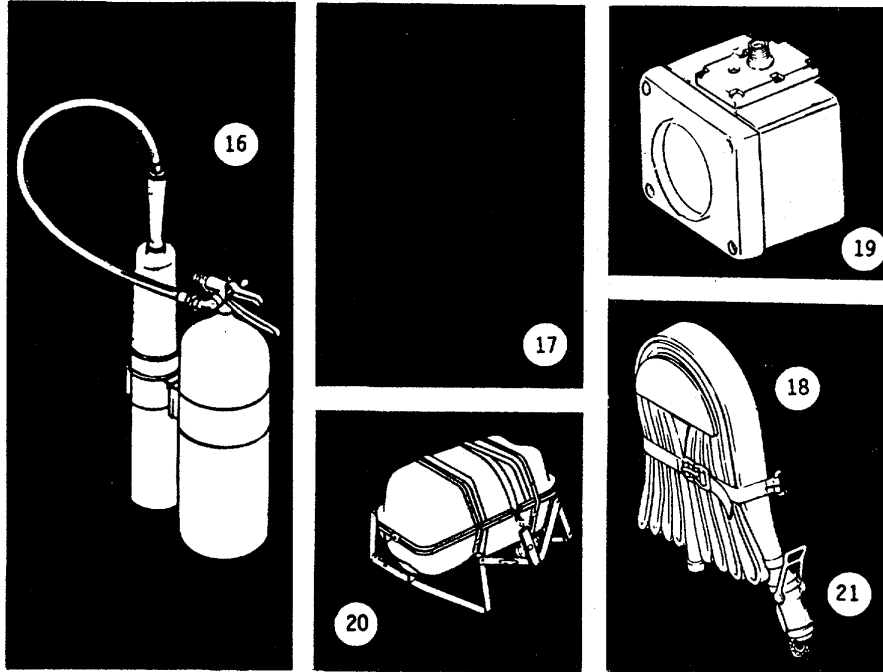

(1) ILLUS NO.	(2) NATIONAL STOCK NUMBER	(3) DESCRIPTION FSCM AND PART NUMBER	(4) USABLE ON CODE U/M	(5) QTY RQR
16	4210-00-558-8837	Extinguisher, Fire, Portable 20 lb (81349) MIL-E-24091	EA	12
17	2040-00-565-9124	Fender, Marine (81349) MIL-F-58065	EA	14
18	4210-00-078-9170	Hose, Fire, 1 1/2 inch NH x 50 feet long (33333) NO REF	EA	6
19	6230-00-828-6398	Lantern, Elcd, 6V. w/Relay Lantern Elcd. 6V (33333) NO REF	EA	1
20	1940-00-204-3894	Life Raft, Inflatable (81349) MIL 19496	EA	2
21	4210-00-288-6857	Nozzle, Fire, 3 position 1 1/2 inch Type 1 Class C (81349) MIL-N-12276	EA	5

SECTION II. COMPONENTS OF END ITEM LIST (CONTINUED)

(1) Illus Number	(2) National Stock Number	(3) Description CAGEC and Part Number	(4) Usable On Code	(5) Qty rqr
The following listed items comprise the installed communication/electronic equipment.				
22	5895-00-879-0211	IFF, RT-859/APC 72	EA	1
23	5840-01-017-2798	Radar Set, AN/SPS-69, Model R41 X 7H422	EA	1
24	5840-01-017-3024	Radar Antenna, AS-3146/SPS-59(V)	EA	1
25	5840-01-017-2684	Radar Display Unit, IP-1258/SPS-59(V)	EA	1
26	5810-00-110-8617	Transceiver, RT-1061/URC-80(V)	EA	1
27	5820-00-164-2146	Control, Receiver Trans, C-8981/URC-80(V)	EA	1
28	5820-01-057-6447	Radio Set, AN/URC 92	EA	1
29	5820-00-223-7433	Radio Set, AN/URC 46	EA	1
30	5820-00-906-1115	Antenna, MX-6707 VRC	EA	1
31		Antenna, 6035-0000 SSB 92	EA	1
32	5820-00-538-7555	Receiver, R390-URR	EA	1
33		Amplifier, AM6747 GR	EA	1
		Omni - Directional Antenna System, MK22CA/Pba 2205 (OGMC3)	EA	1
		Marinefax, TR-IV, Model 9414 (04855)	EA	1
		Antenna, Receiving, DA100D (32172)	EA	1
		Aerovane Wind Indicator/Transmitter, Model 120 (Trans), Model 135 (Ind) (82205)	EA	1
		Emergency Lifeboat Transceiver, 403A (OTFK2)	EA	1
		EPIRB, SATFIND-406, M3 (04855)	EA	1
		CONVERTER, DC-DC, Heavy Duty, Model 32-12-10, 420-0327-0 (62028)	EA	1

SECTION II. COMPONENTS OF END ITEM LIST (CONTINUED)

(1) Illus Number	(2) National Stock Number	(3) Description CAGEC and Part Number	(4) Usable On Code	(5) Qty rqr
		Antenna Coupler, Digital Automatic, DCU-100 (12338)	EA	1
		Transceiver, Marine, VHF, DSC 500 (OWF67)	EA	1
		Radio, Portable, EPH/EPI (22373)	EA	4
		Charger, Battery, LAA0300 Series (22373)	EA	1
		Television, Color	EA	1
		Recorder, Video Cassette, VHS	EA	1

SECTION III. BASIC ISSUE ITEMS LIST.

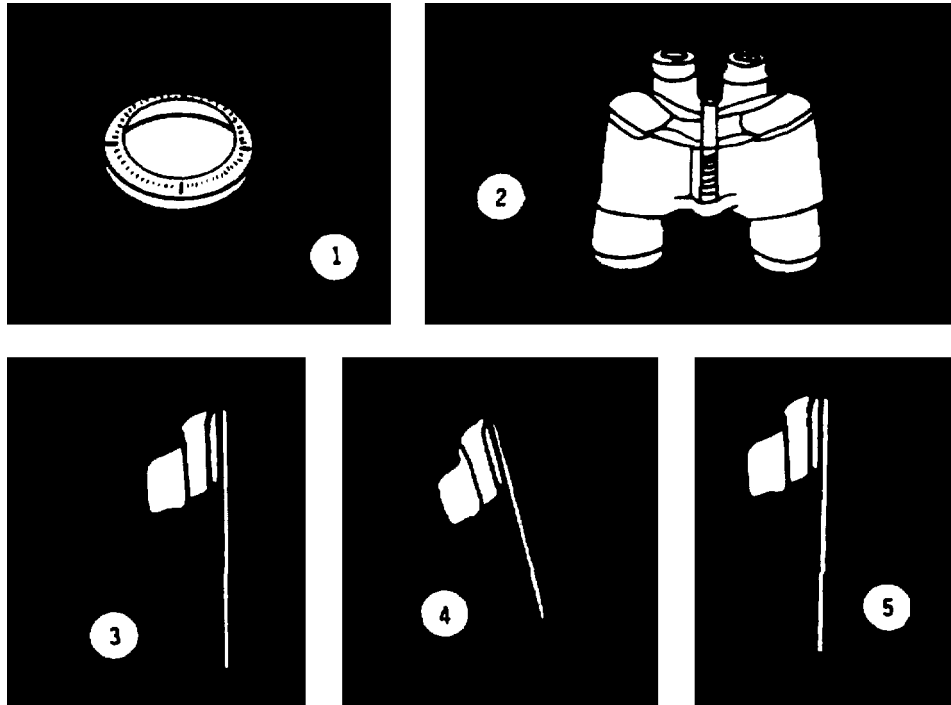

(1) Illus Number	(2) National Stock Number	(3) Description CAGEC and Part Number	Usable On Code	(4) U/I	(5) Qty rqr
1	6605-00-9194743	Azimuth Circle, 6 inches MK4, MOD 1 (80064) 00-533-991		EA	1
2	6605-00-530-0974	Binocular, 7 X 50, M17A1 (81349) MIL-B-76566		EA	3
3	8345-00-656-1446	Flag, National, Union Jack, 1 foot 10 inches X 2 feet 8 inches (81348) DDD-F-416		EA	2
4	8345-00-245-2040	Flag, National, U. S., 1 foot 6 inches X 2 feet 2 inches (81348) DDD-F-416		EA	2
5	8345-00-935-3120	Flag, Organizational, Transportation Corps (81348) DDD-F-416		EA	2

SECTION III. BASIC ISSUE ITEMS LIST (CONTINUED).

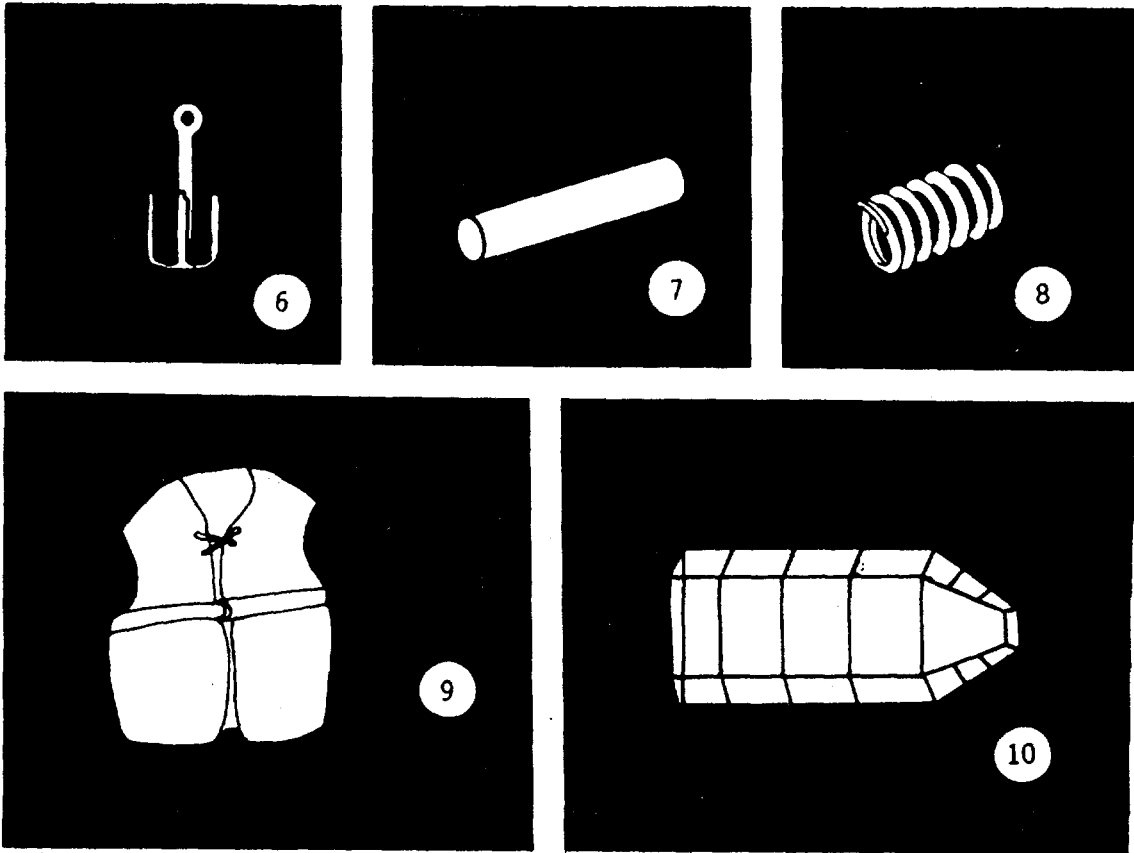

(1) ILLUS NO.	(2) NATIONAL STOCK NUMBER	(3) DESCRIPTION FSCM AND PART NUMBER	USABLE ON CODE	(4) U/M	(5) QTY RQR
6	2040-00-238-9060	Grapnel, Marine, 5 Prong		EA	1
7	4720-00-288-8532	Hose Assy, 1 ½ inches X 50 inches (F.W.F.11)		EA	2
8	4720-00-202-6482	Hose Assy, Rubber Wrapped, Water ¾ inch		EA	2
9	4220-00-200-0538	Life Preserver, Vest (81349) MIL-L-18045		EA	16
10	6530-00-785-7810	Litter, Rigid, Stokes		EA	1

SECTION III. BASIC ISSUE ITEMS LIST (CONTINUED).

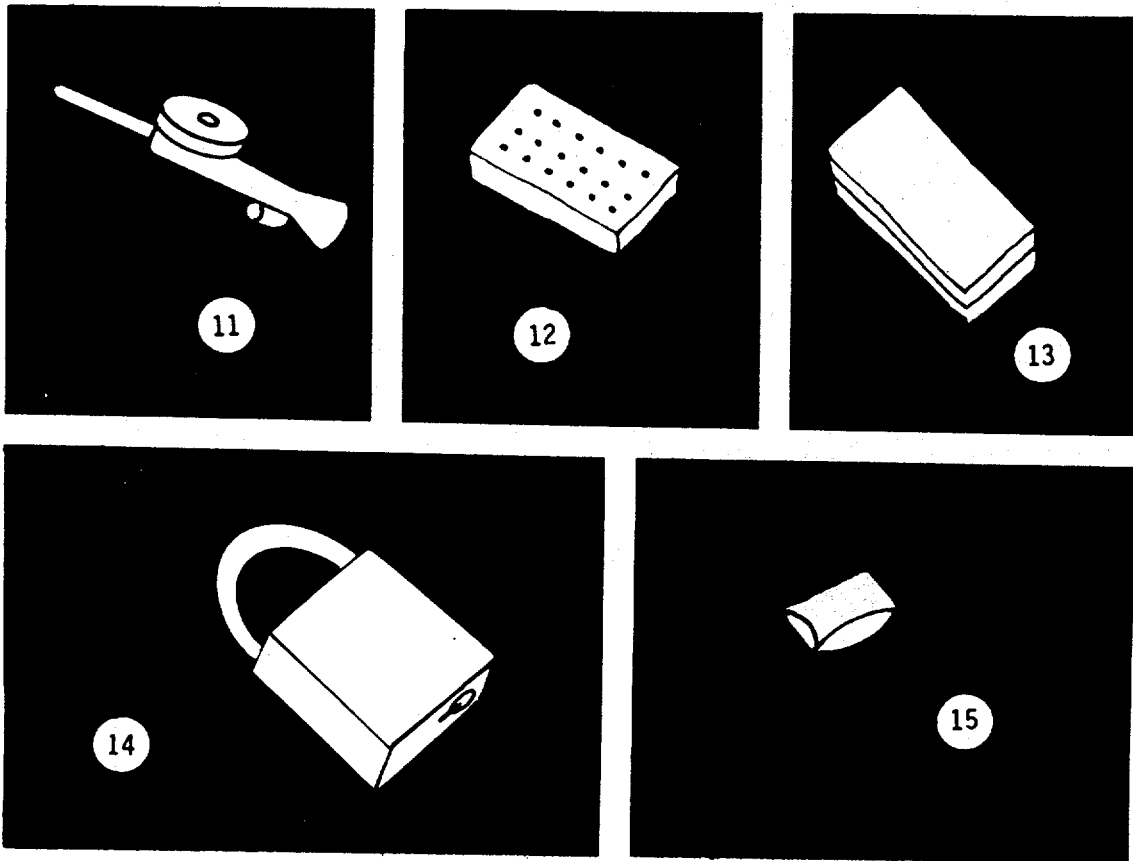

(1) ILLUS NO.	(2) NATIONAL STOCK NUMBER	(3) DESCRIPTION FSCM AND PART NUMBER	(4) USABLE ON CODE U/M	(5) QTY RQR
11		Line Throwing Device (75324) GR-52-A2	EA	1
12	7210-00-935-6619	Mattress, Bed	EA	12
13	7210-00-205-3585	Mattress, Bed Box/Spring Combination	EA	2
14	5340-00-582-2742	Padlock, Keyed (96906) MS35647-1	EA	48
15	7210-00-292-2326	Pillow, Bed (81348) V-P-356	EA	14

SECTION III. BASIC ISSUE ITEMS LIST (CONTINUED).

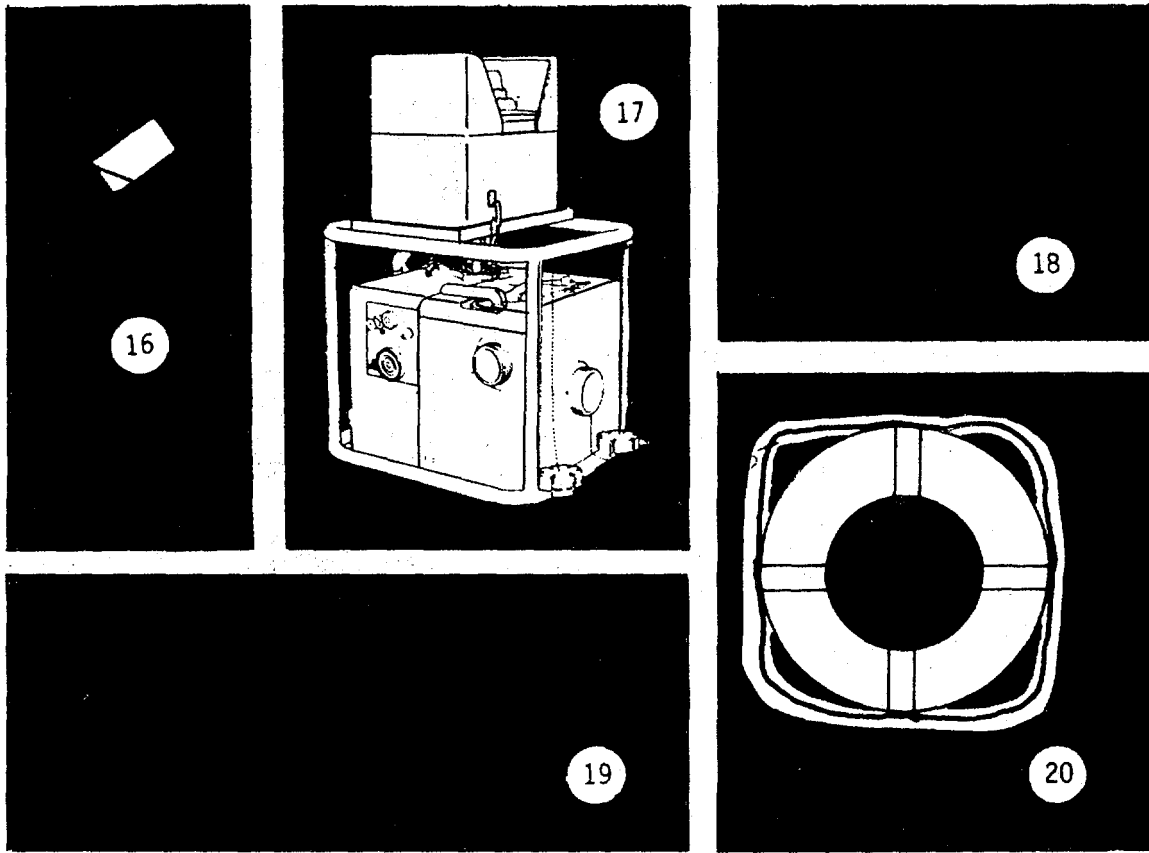

(1) ILLUS NO.	(2) NATIONAL STOCK NUMBER	(3) DESCRIPTION FSCM AND PART NUMBER	USABLE ON CODE	(4) U/M	(5) QTY RQR
16	7210-00-292-2326	Pillowcase, Bed (81348) DDD-P-381		EA	28
17	4320-00-368-4419	Pump, Centrifugal, Portable (Fire & Salvage) (80256) 553144		EA	1
18	4930-00-263-9886	Pump, Dispensing, Hand Rotary (81349) MIL-D-40078, Type 1, Class 1		EA	2
19		Pump, Submersible, E1c1 (39428) 4327K2		EA	1
20	4220-00-275-3157	Ring, Buoy, Floating, 30 inches (81349) MIL-R-116847		EA	6

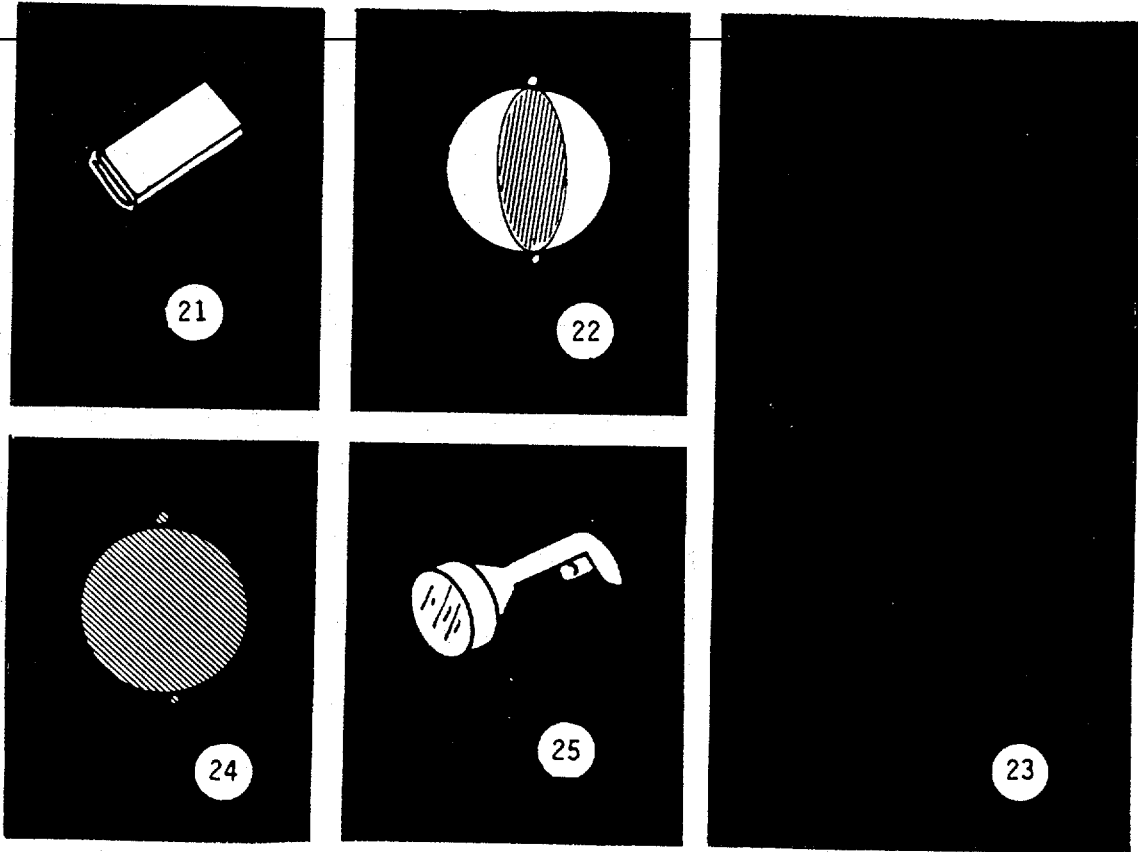

SECTION III. BASIC ISSUE ITEMS LIST (CONTINUED).

(1) ILLUS NO.	(2) NATIONAL STOCK NUMBER	(3) DESCRIPTION FSCM AND PART NUMBER	USABLE ON CODE	(4) U/M	(5) QTY RQR
21	7217-00-171-1099	Sheet, Bed DDD-S-281		EA	56
22	8345-00-264-6081	Signal, Day, Maritime, Ball, Black & White (81349) MIL-S-29108		EA	1
23	4327-01-029-9675	Pump , Centrifugal, Portable (PE250)0 (52845) When uneconomical to repair - requisition.			
24	8345-00-276-9576	Signal, Day, Maritime, Ball, Red (81349)) MIL-S-29108		EA	1
25	5850-00-407-6771	Signal, Lamp , Aldis (80063) SE11		EA	1

SECTION III. BASIC ISSUE ITEMS LIST (CONTINUED).

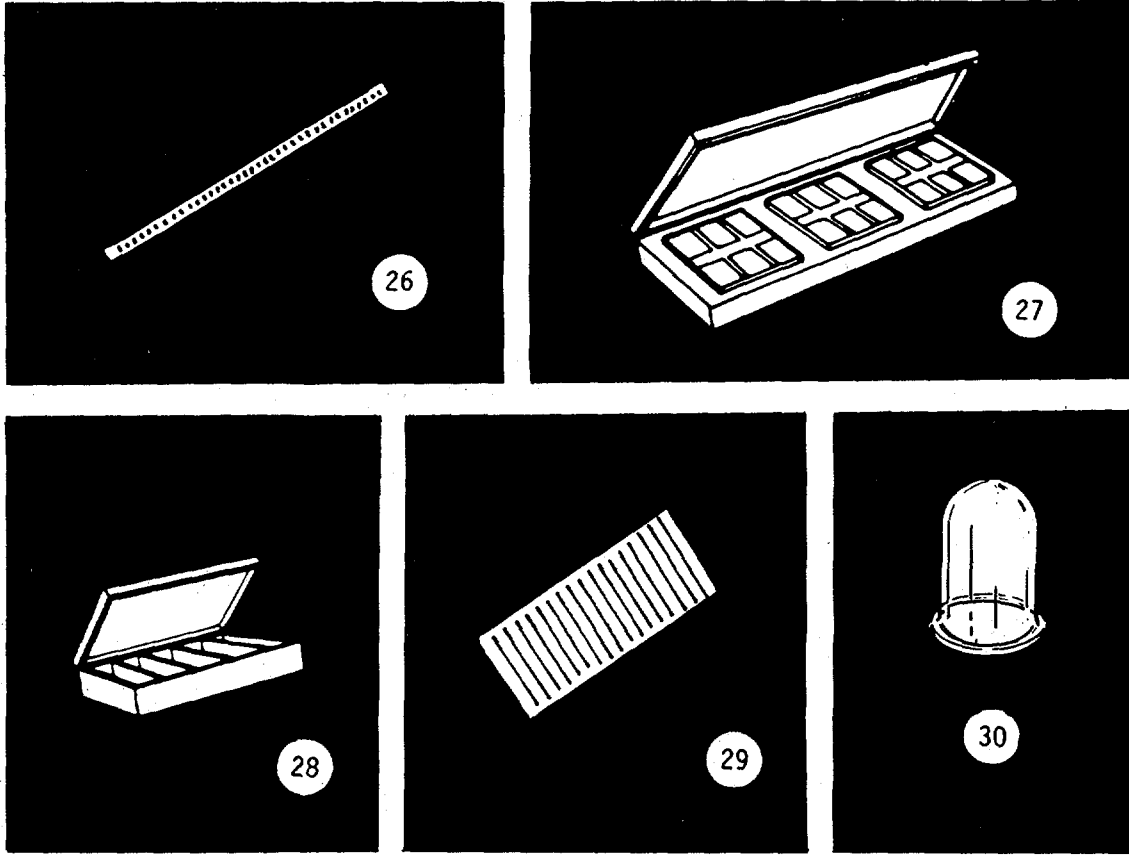

(1) ILLUS NO.	(2) NATIONAL STOCK NUMBER	(3) DESCRIPTION FSCM AND PART NUMBER	USABLE ON CODE	(4) U/M	(5) QTY RQR
26	5210-00-526-0752	Tape, Tank Measuring, 50 feet (37163) 14075		EA	1
27	6630-00-316-5831	Test Kit, Chromate (71821) 121358		EA	1
28	6630-00-531-1931	Test Kit, 0.1 Condition (81349 MIL-T-19467		EA	1
29	7220-01-024-9041	Mat, Floor, Synthetic (81349) MIL-M-15562 Type		EA	10
30	6220-00-2909-7146	Lens, Marine, Green Navigational (46576) 259-1-G		EA	1

SECTION III. BASIC ISSUE I TEMS LIST (CONTINUED).

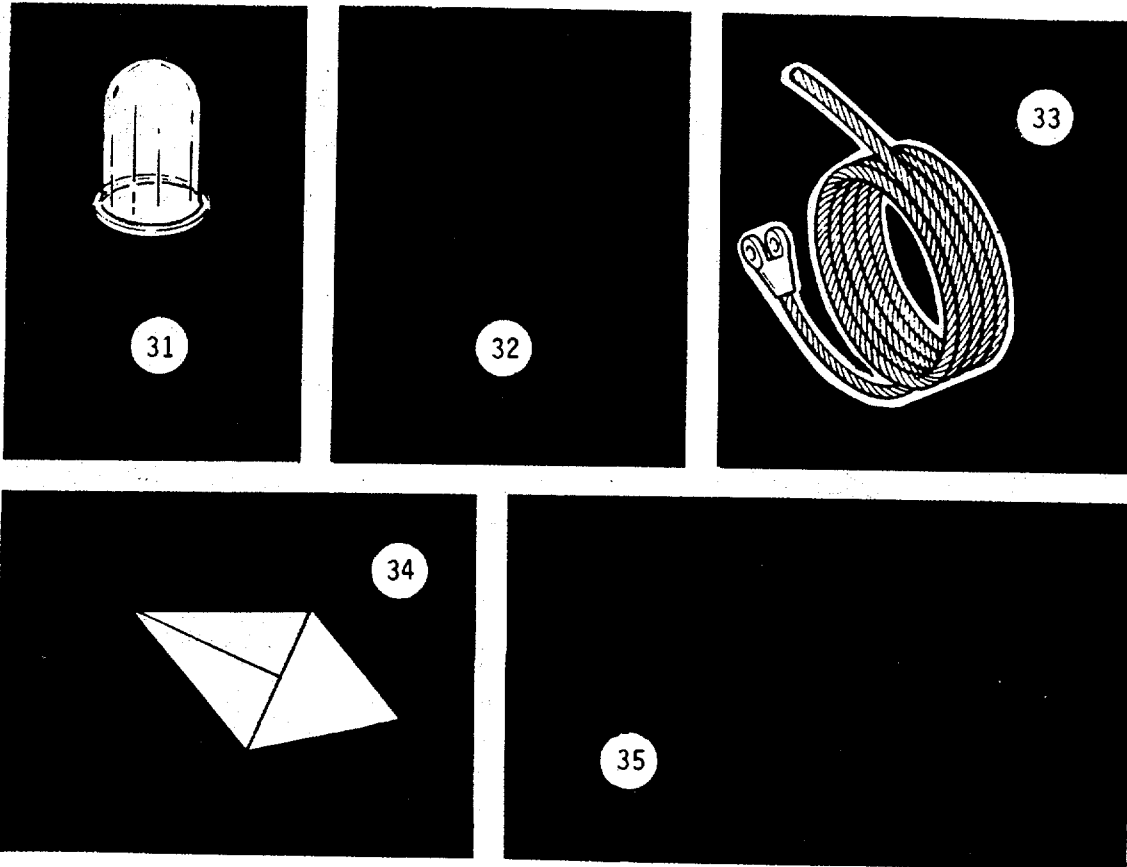

(1) ILLUS NO.	(2) NATIONAL STOCK NUMBER	(3) DESCRIPTION FSCM AND PART NUMBER	(4) USABLE ON CODE U/M	(5) QTY RQR
31	6220-00-299-7151	Lens, Marine, Red, Navigational (46576)	EA	1
32	4310-00-289-5967	Pump, Vacuum (to pull vacuum on Air Conditioning and Refrigeration Systems)	EA	1
33	4010-00-436-4276	Wire, Rope, Steel, Zinc Coated Breaking Strength 132,000 Lbs. 900 feet Required RR-W-06410, Type 1, Class 3, Construction 4	FT	900
34	2040-00-222-3729	Anchor, Sea, 36 x 70 (81348) MM-1-562	EA	1
35	4210-00-372-0864	Applicator, Nozzle, Fog 4 feet	EA	4

SECTION III. BASIC ISSUE ITEMS LIST (CONTINUED).

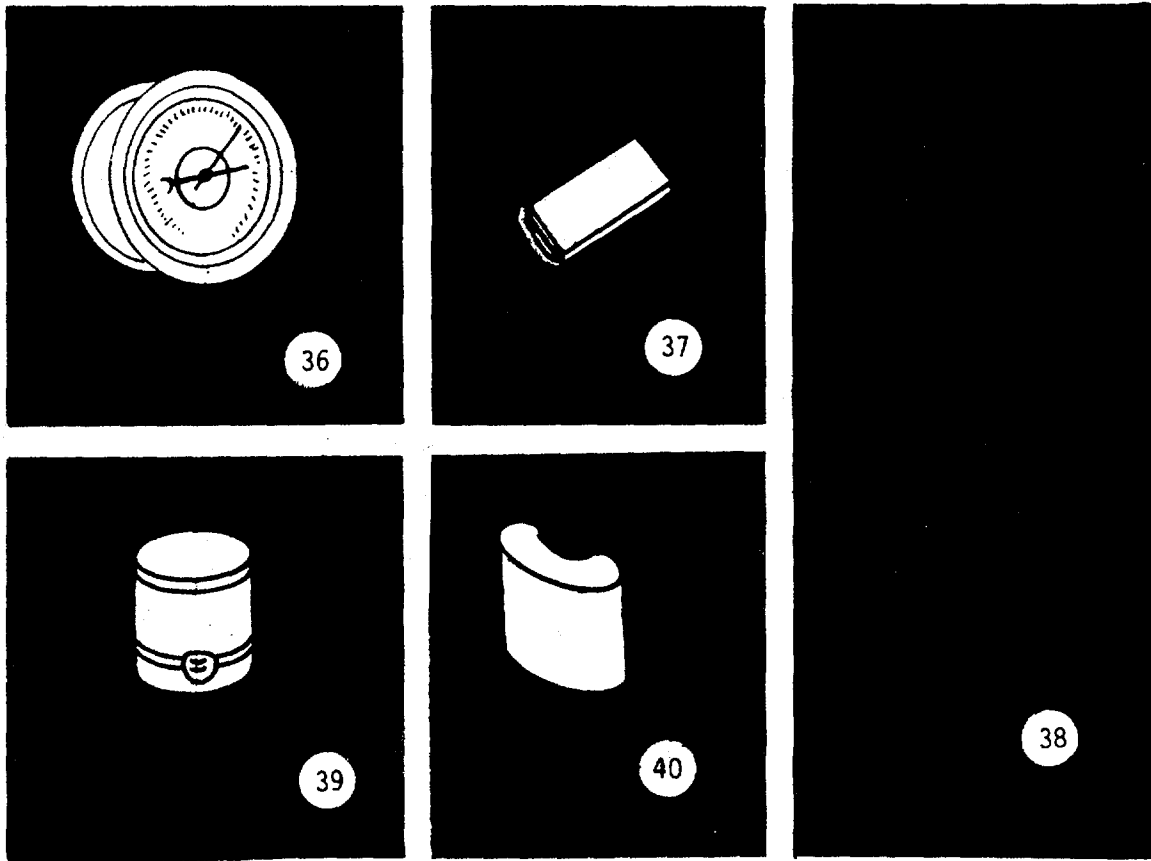

(1) ILLUS NO.	(2) NATIONAL STOCK NUMBER	(3) DESCRIPTION FSCM AND PART NUMBER	USABLE ON CODE	(4) U/M	(5) QTY RQR
36	6685-00-537-9173	Barometer, Aneroid (80063) P/N 3257A		EA	1
37	6545-00-911-1300	Blanket Set, Medical		EA	1
38	4240-00-678-5263	Breathing Apparatus, Oxygen (81349) B-51254		EA	4
39	7240-00-256-7700	Can, Flammable Waste, 5 Gallon (81349) RR-C-114		EA	2
40	4240-00-174-1365	Canister, OBA (81349) C-17671		EA	4

SECTION III. BASIC ISSUE ITEMS LIST (CONTINUED).

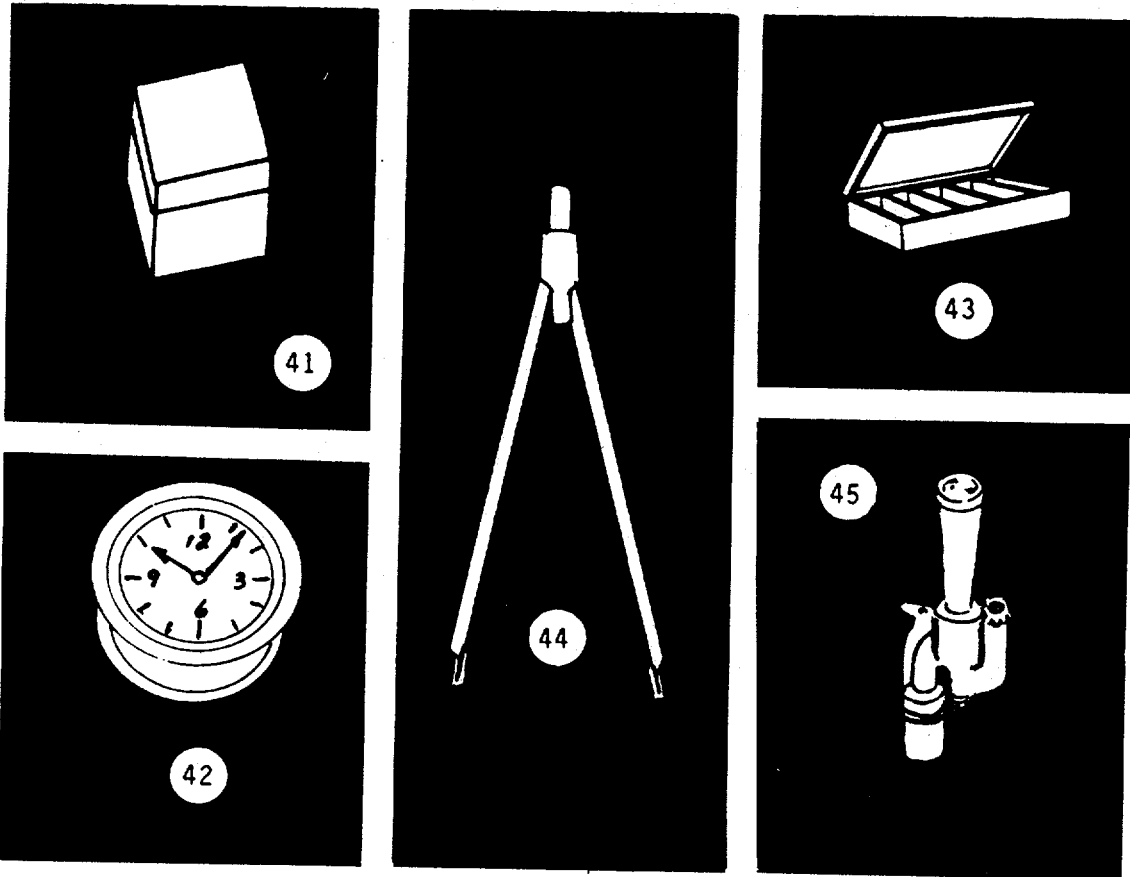

(1) ILLUS NO.	(2) NATIONAL STOCK NUMBER	(3) DESCRIPTION FSCM AND PART NUMBER	USABLE ON CODE	(4) U/M	(5) QTY RQR
41	6645-00-290-2233	Case, Chronometer, u/w Size 35		EA	1
42	6645-00-238-9054	Chronometer, Size 35 (81348) -2536		EA	1
43	66650-00-903-476	Detector Kit, Chemical Agent		EA	1
44	6605-0-0257-7005	Divider Set, Navigation (80064) S2407H533623		EA	1
45		Eductor, Bilge, 2 x 3 (71905) 358		EA	1

SECTION III. BASIC ISSUE ITEMS LIST (CONTINUED).

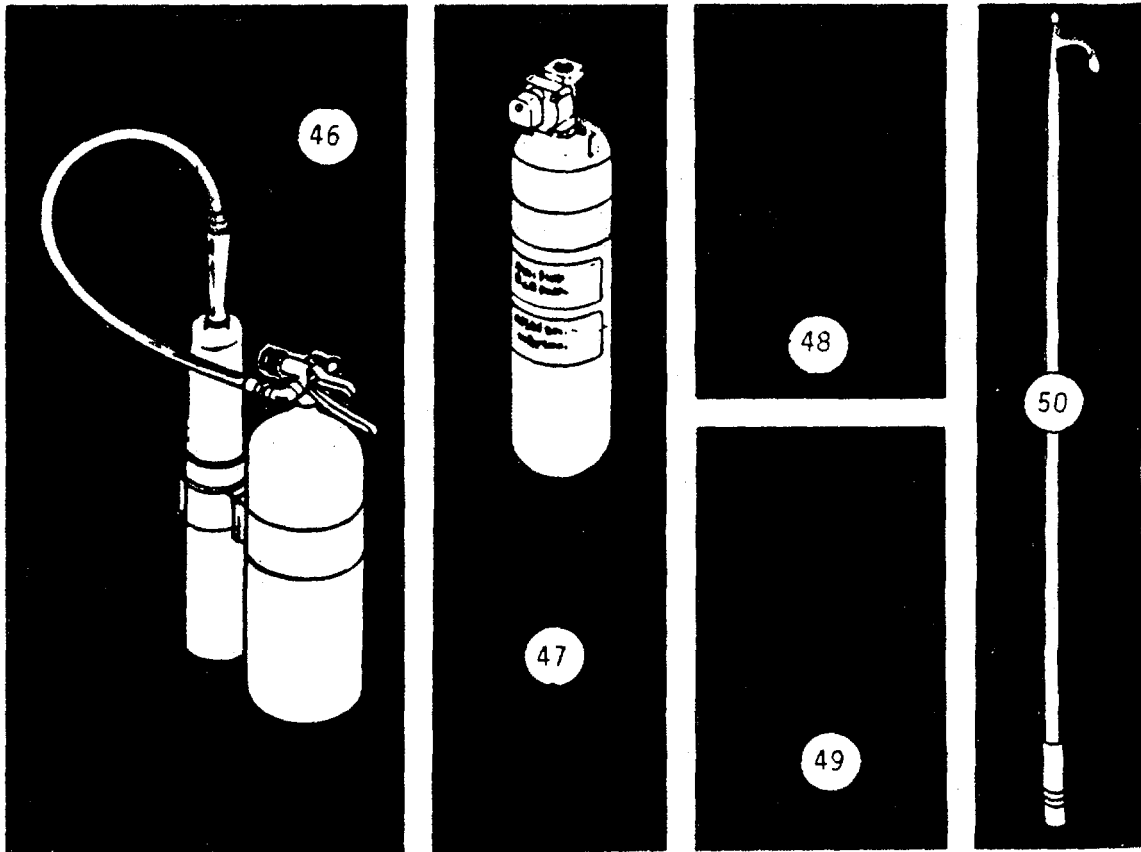

(1) ILLUS NO.	(2) NATIONAL STOCK NUMBER	(3) DESCRIPTION FSCM AND PART NUMBER	USABLE ON CODE	(4) U/M	(5) QTY RQR
46	4210-00-555-8837	Extinguisher, Fire, Halon, 15 lb, Portable (81348) E810, Type 1, Size 15		EA	12
47		Extinguisher, Fire, 35 lb, Halon, Fixed (11941) 11-1019		EA	1
48	4210-00-223-9877	Foam, Liquid, Fire Extinguishing (81348) 0-F-55		EA	12
49	4240-00-052-3776	Goggles, Plastic, Safety (81348) G-G-531		EA	4
50	2040-00-268-9250	Hook, Boat, 10 feet		EA	2

SECTION III. BASIC ISSUE ITEMS LIST (CONTINUED).

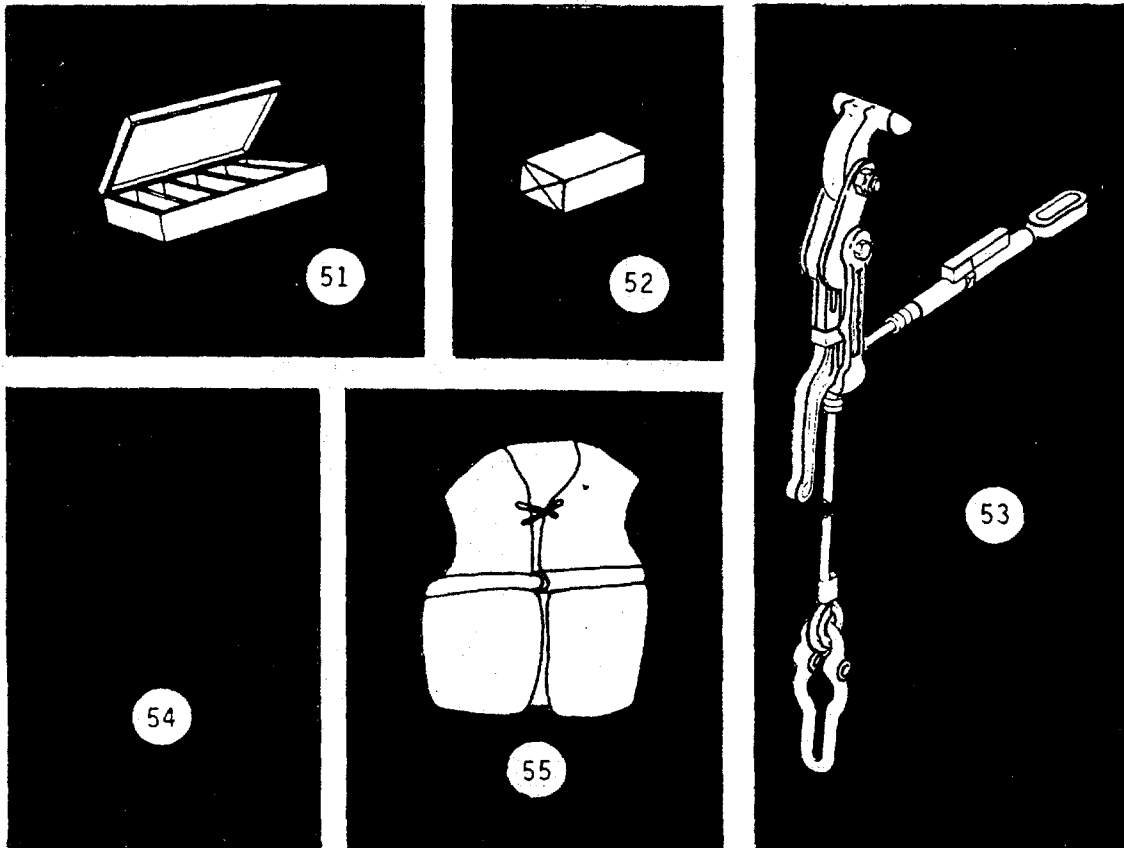

(1) ILLUS NO.	(2) NATIONAL STOCK NUMBER	(3) DESCRIPTION FSCM AND PART NUMBER	USABLE ON CODE	(4) U/M	(5) QTY RQR
51	6545-00-922-1200	Kit, First Aid, 12 unit		EA	1
52	6545-00-168-6893	Kit, First Aid, Life Raft		EA	2
53	2020-00-789-1065	Lashing Gear, Vehicle 3500 lb breaking strength (80064) 80513113819		EA	50
54	4940-00-384-0466	Leak Detector, Halide Refrigerant Gas (36346) Prestolite 18 R17		EA	1
55	4220-00-200-0538	Life Preserver, Vest, Adult MIL-L-18045		EA	15

SECTION III. BASIC ISSUE ITEMS LIST (CONTINUED).

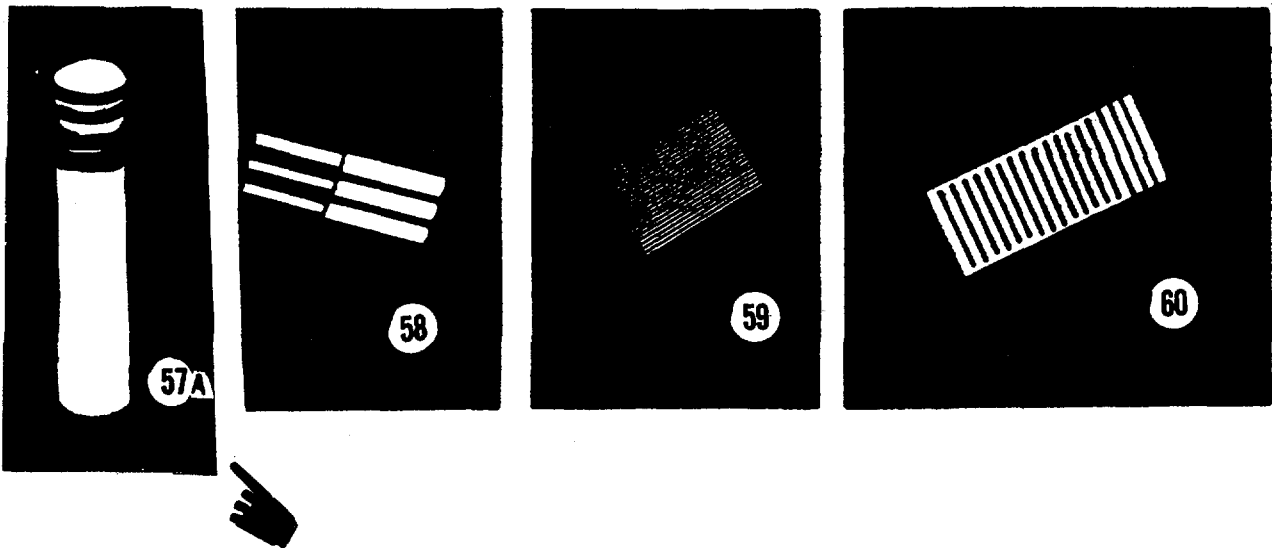
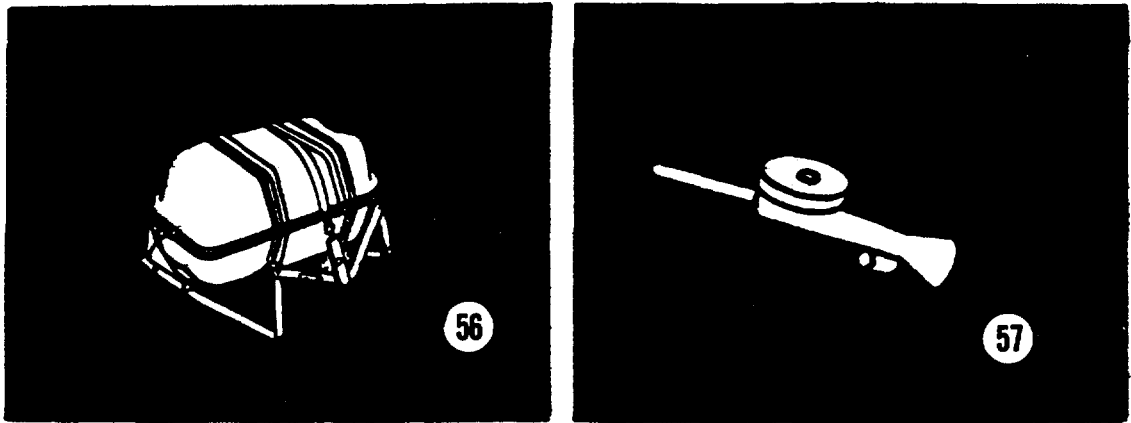

(1) ILLUS NO.	(2) NATIONAL STOCK NUMBER	(3) DESCRIPTION FSCM AND PART NUMBER	(4) USABLE ON CODE U/M	(5) QTY RQR
56		Life Raft, Inflatable, 15 man (98604) MMMK3	EA	2
57	1095-00-270-6019	Line Throwing Device (75324) P/N	EA	1
57A	1370-01-074-0591	Marker, Location, Marine, MK58, MOD1, (10001)	EA	4
58	6850-00-270-9986	Marker, Sea, Fluorescent	EA	4
59	7220-00-634-1601	Mat, Floor, 20 inches x 20 inches (81349)	EA	2
60	7220-00-292-2096	Mat, Floor, Black, Rubber or Plastic 36 inches x 30 inches x ¼ inch	EA	4

SECTION III. BASIC ISSUE ITEMS LIST (CONTINUED).

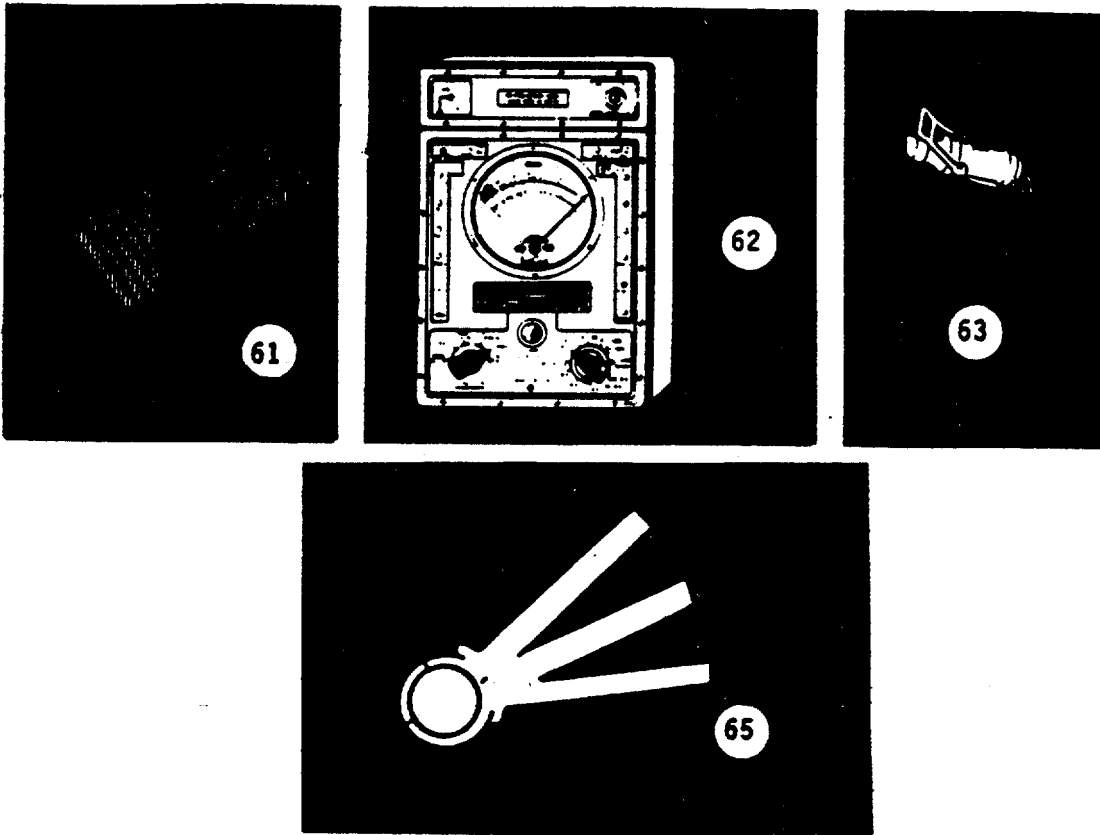

(1) ILLUS NO.	(2) NATIONAL STOCK NUMBER	(3) DESCRIPTION FSCM AND PART NUMBER	USABLE ON CODE	(4) U/M	(5) QTY RQR
61	7220-255-0765	Mat Floor, Safety, Rubber 24 inches x 22 feet x 3/16 inch		EA	1
62	6625-00-553-0142	Multimeter (77221) P/N T-S 352 B/U U/P \$100I		EA	1
63	4210-00-225-6225	Nozzle, Fire, Foam, NPU 1/2 inches, Type 1, Class C (81349) N-122796		EA	5
64	DELETED				
65	6675-00-191-1514	Protractor, Plastic, 3 Arm (81349) P-288 Type II		EA	1

SECTION III. BASIC ISSUE ITEMS LIST (CONTINUED).

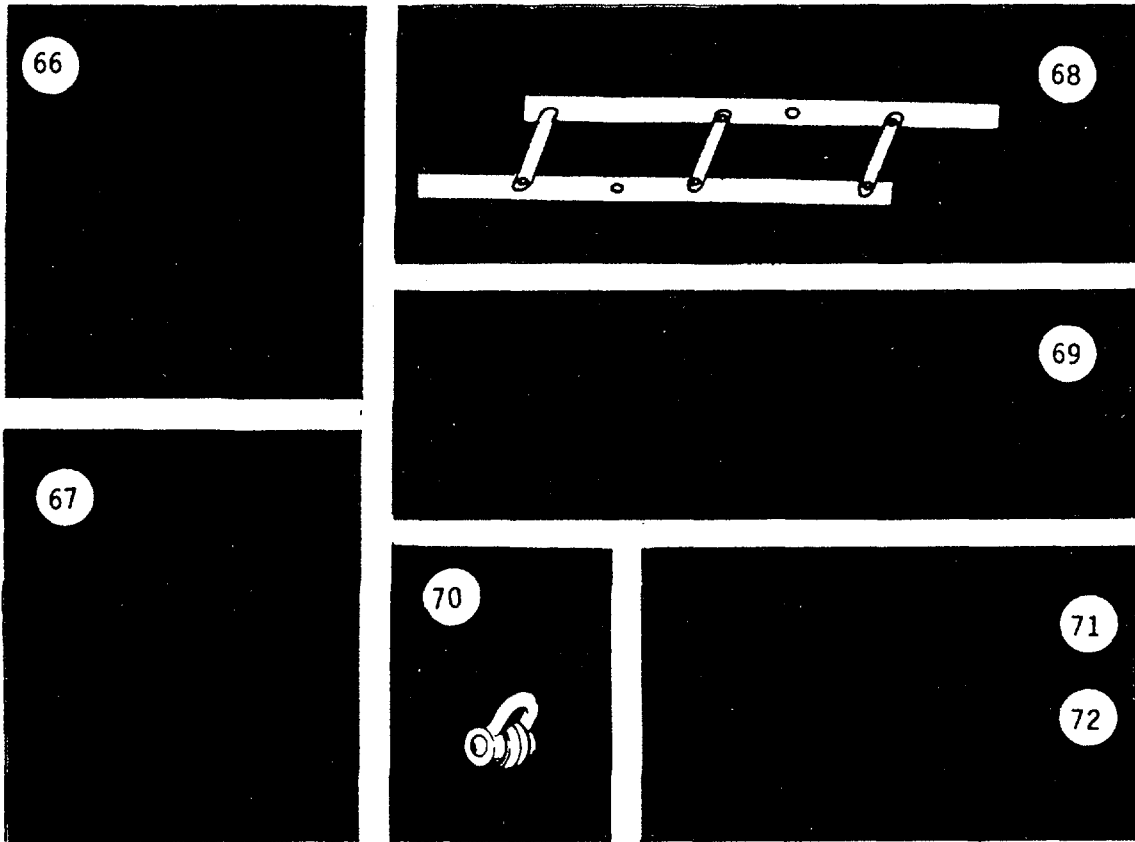

(1) ILLUS NO.	(2) NATIONAL STOCK NUMBER	(3) DESCRIPTION FSCM AND PART NUMBER	USABLE ON CODE	(4) U/M	(5) QTY RQR
66	4240-00-691-5617	Protector, Aural (71483) 117		EA	6
67	4240-00-368-6149	Respirator, Air Filter (81349) R-3308		EA	4
68	6675-00-191-1509	Ruler, Parallel, 18 inches Navigators (81348) GG-P-KK8		EA	1
69	6605-00-391-1110	Rule, Slide, Nautical		EA	1
70	4030-00-834-1232	Shackle, Anchor, 1 1/2-1/4 between eyes, 130,000 lb breaking strength		EA	2
71	4240-00-240-5141	Shield, Face, Industrial Clear		EA	2
72	4240-00-240-5140	Shield, Face, Industrial Amber		EA	2

SECTION III. BASIC ISSUE ITEMS LIST (CONTINUED).

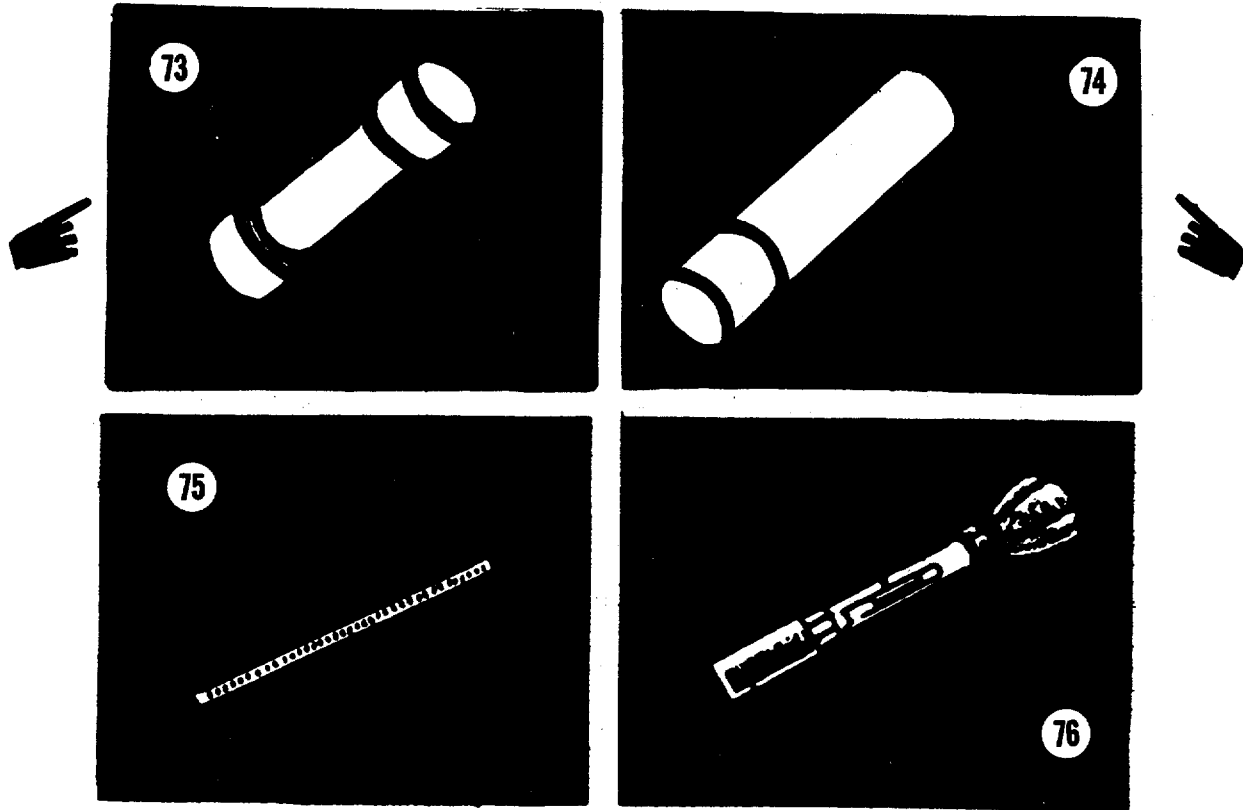

(1) ILLUS NO.	(2) NATIONAL STOCK NUMBER	(3) DESCRIPTION FSCM AND PART NUMBER	USABLE ON CODE	(4) U/M	(5) QTY RQR
73	1370-01-030-8330	Signal, Smoke & Illumination, (10001) DL3139734 Marine, MK124, MOD0		EA	12
74	1370-00-629-2336	Signal, Distress, Illumination, Ground, Red Star, Parachute, M126A1 (19203) 8797968		EA	4
75	5210-00-526-0752	Tape, Tank Measuring, 50 feet (37163) 14075		EA	1
76	6630-00-171-5126	Tester, Battery, Electrolyte Solution (81348) GG-T-258		EA	1

SECTION III. BASIC ISSUE ITEMS LIST (CONTINUED).

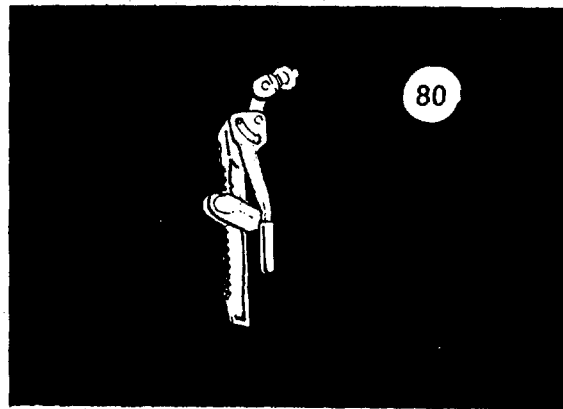
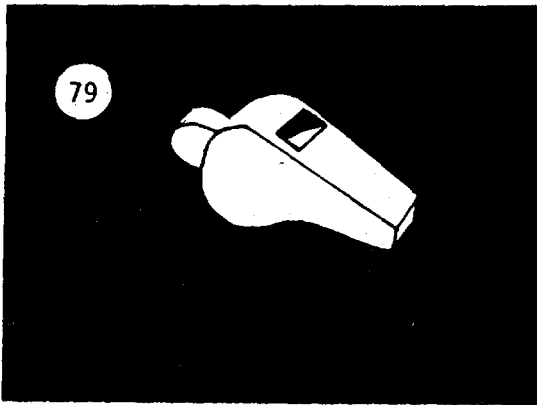
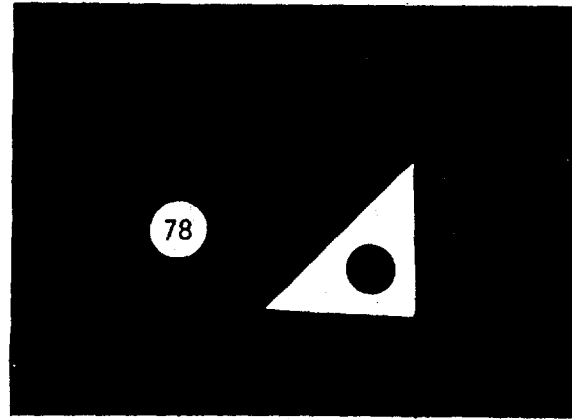
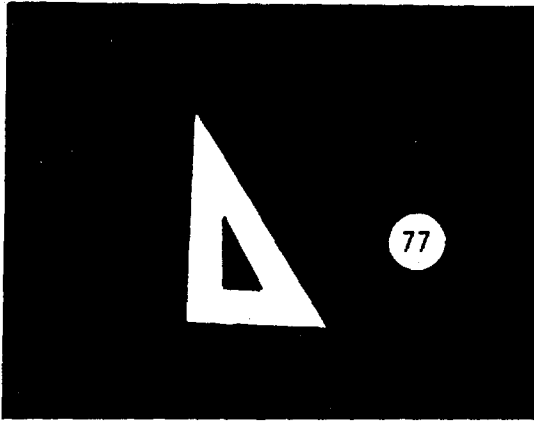

(1) ILLUS NO.	(2) NATIONAL STOCK NUMBER	(3) DESCRIPTION FSCM AND PART NUMBER	(4) USABLE ON CODE U/M	(5) QTY RQR
77	6675-00-190-5867	Triangle, Drafting, Plastic 30 to 60 (81348) GG-T-671	EA	1
		Requires Special Handling & Storage. Will not be issued as part of Boat Set. Will be requisitioned/furnished by user.		
78	6675-00-190-5862	Triangle, Drafting, Plastic, 45	EA	1
79	8465-00-254-8803	Whistle, Ball w/Lanyard (81349) W-1053	EA	20
80	2020-00-789-1088	Lashing Gear, Vehicle 9,800 lb Breaking Strength (80064) 805-13131520	FT	50

SECTION III. BASIC ISSUE ITEMS LIST (CONTINUED).

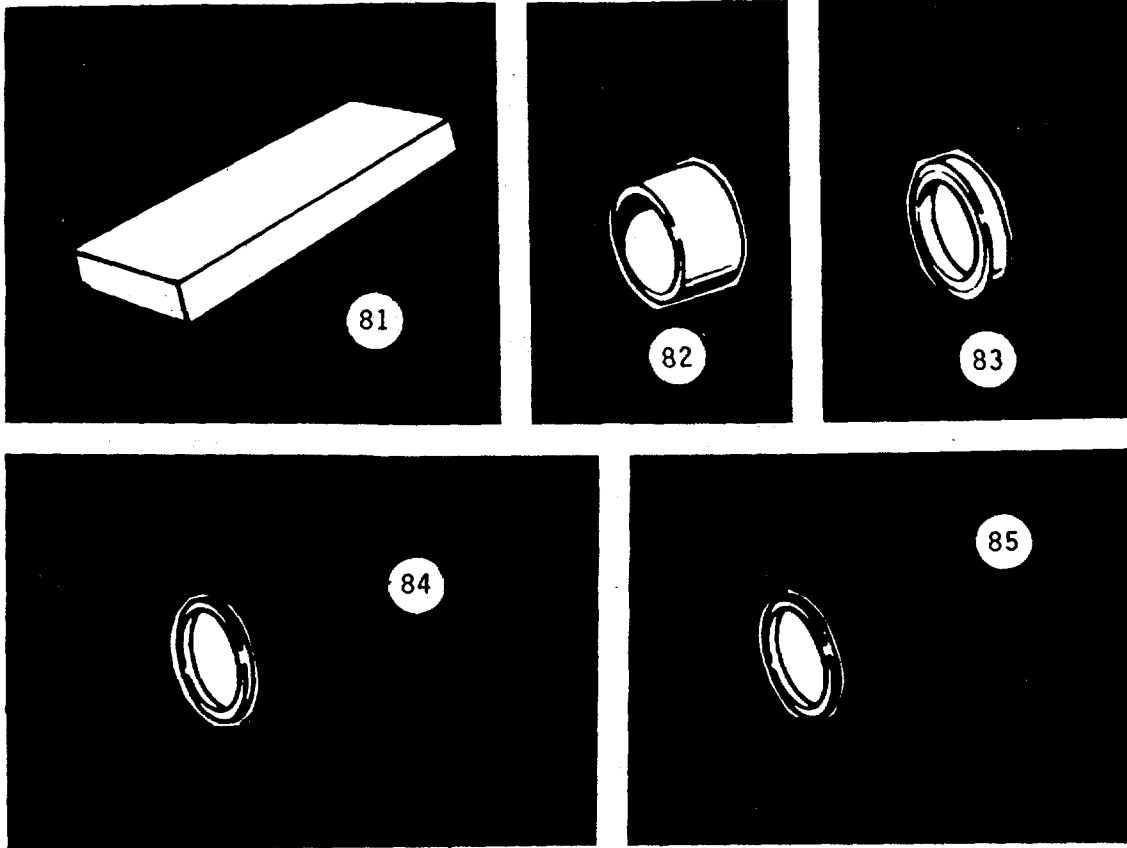

(1) ILLUS NO.	(2) NATIONAL STOCK NUMBER	(3) DESCRIPTION FSCM AND PART NUMBER	(4) USABLE ON CODE U/M	(5) QTY RQR
		The following items are u/o Ship's Service Generator, Engine Detroit Diesel, Allison Division (DDAD) Model 1033-7005-1. Some parts are also u/o: Main Propulsion Engines, DDAD Mdl 7122-7000 and Anchor Winch Engine DDAD Model 1043-7000.		
81	5330-00-375-2948	Kit, Engine Gasket (72582) 5193113	EA	1
82	5365-00-299-0623	Spacer, Crankshaft Seal, Front (72582) 5151475	EA	1
83	5330-00-154-8358	Seal, Crankshaft Front (72582) 5115454	EA	4
84	5330-00-282-5906	Seal, Crankshaft, Rear (72582) 5114335	EA	4
85	5365-00-597-4351	Spacer, Crankshaft Seal Rear (72582) 5192496	EA	1

SECTION III. BASIC ISSUE ITEMS LIST (CONTINUED).

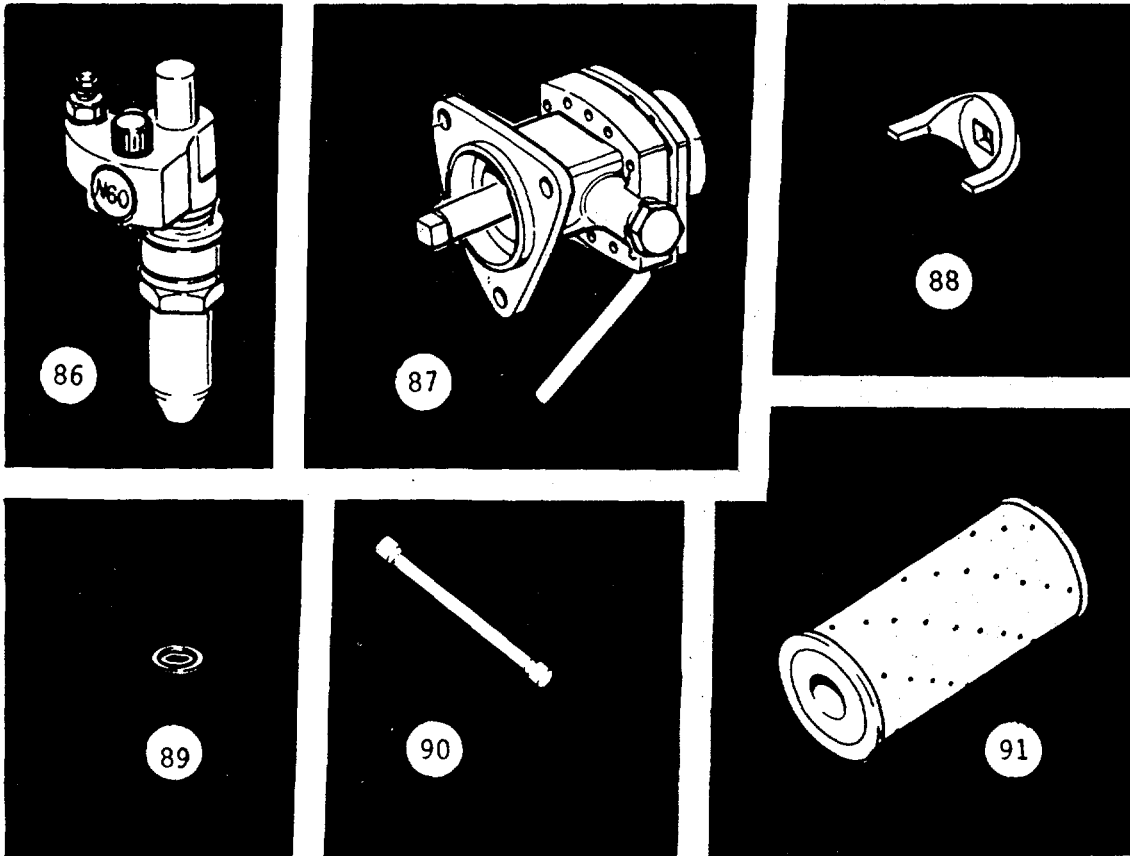

(1) ILLUS NO.	(2) NATIONAL STOCK NUMBER	(3) DESCRIPTION FSCM AND PART NUMBER	(4) USABLE ON CODE U/M	(5) QTY RQR
86	2910-00-075-7474	Injector, Fuel (N60) (72582) 5228760	EA	3
87	2910-00-808-2655	Pump, Fuel (72582) 5199561	EA	2
88	2910-00-524-7862	Fork, Fuel Pump Drive (72582) 5102257	EA	4
89	5310-00-785-3961	Washer, Fuel Connector (72582) 5125108	EA	6
90	2815-00-623-1467	Shaft, Drive, Blower (72582) 5154638	EA	1
91	2940-00-589-6283	Element, Filter, L.O. (72582) 5573014	EA	48

SECTION III. BASIC ISSUE ITEMS LIST (CONTINUED).

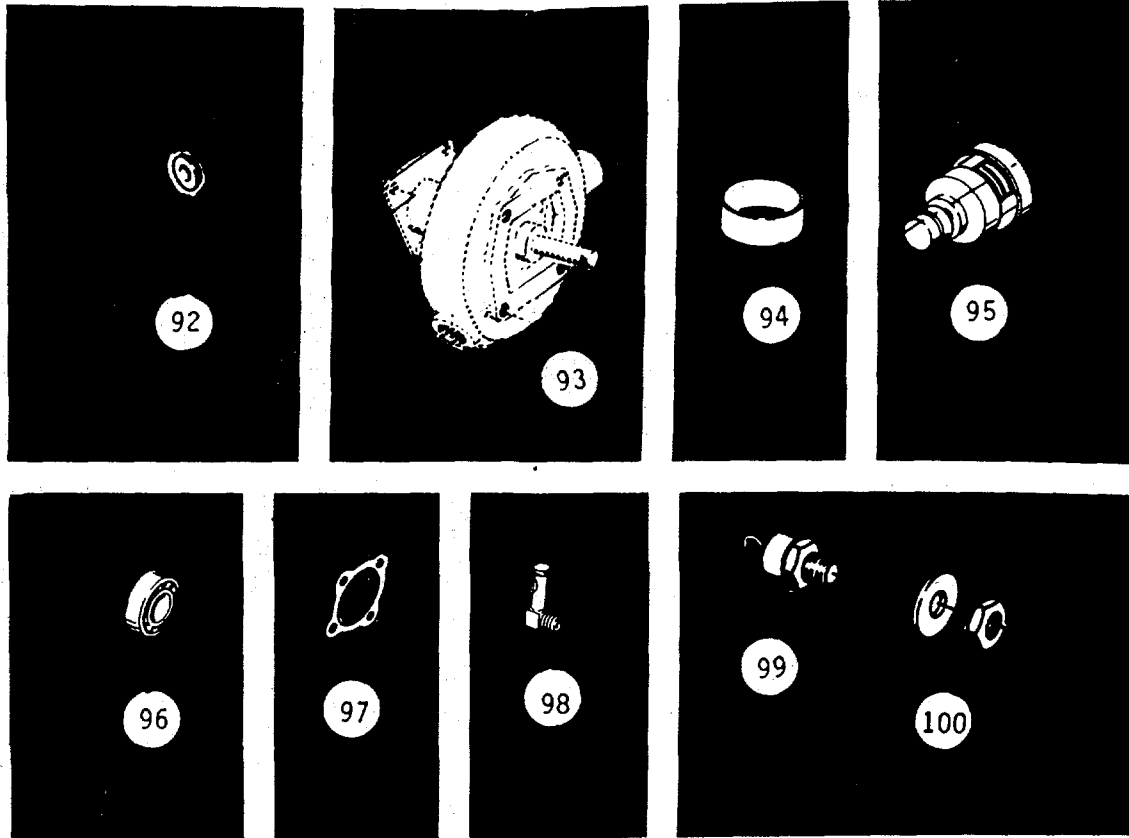

(1) ILLUS NO.	(2) NATIONAL STOCK NUMBER	(3) DESCRIPTION FSCM AND PART NUMBER	(4) USABLE ON CODE U/M	(5) QTY RQR
92	5330-00-604-8094	Seal, Element, L.O. (72582) 5187310	EA	12
93	2930-00-027-2479	Pump, Fresh Water (72582) 5149374	EA	2
94	5330-00-354-1235	Seal, Water	EA	1
95	6620-00-377-3497	Thermostat (72582) 5172141	EA	2
96	3110-00-554-3248	Bearing (72582) 5333914	EA	1
97	5330-00-329-4039	Gasket (72582) 5334586	EA	1
98	6680-00-526-8366	Gauge (72582) 5330431	EA	1
99	5961-00-024-0752	Rectifier (72582) 3179357	EA	6
100	5310-01-040-5346	Nut (72582) 3195233	EA	6

SECTION III. BASIC ISSUE ITEMS LIST (CONTINUED).

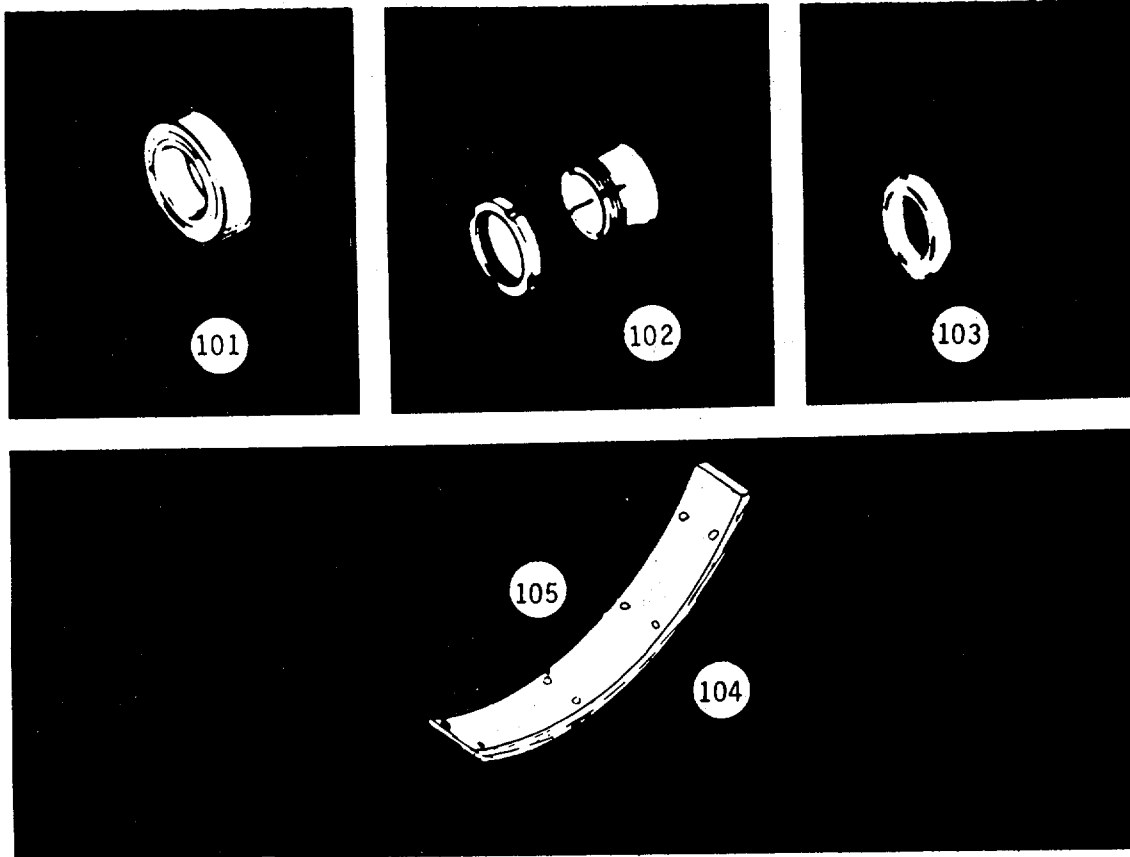

(1) ILLUS NO.	(2) NATIONAL STOCK NUMBER	(3) DESCRIPTION FSCM AND PART NUMBER	(4) USABLE ON CODE U/M	(5) QTY RQR
		The following 21 items are u/o Bow Ramp Winch (New England Trawler Mdl X-1454):		
		<u>WINCH</u>		
101	3110-00-105-2632	Bearing (52676) 22218CK	EA	1
102	3110-00-191-0481	Adapter, Bearing (52676) SNW18	EA	1
103	5330-01-040-3837	Seal, Oil (76727) R-11290-15	EA	1
104	2030-01-068-5324	Lining, Brake (76727) B-11292-1	EA	1
105	5320-01-069-2663	Rivets, Brake Band (76727) B11292-4	EA	22

SECTION III. BASIC ISSUE ITEMS LIST (CONTINUED).

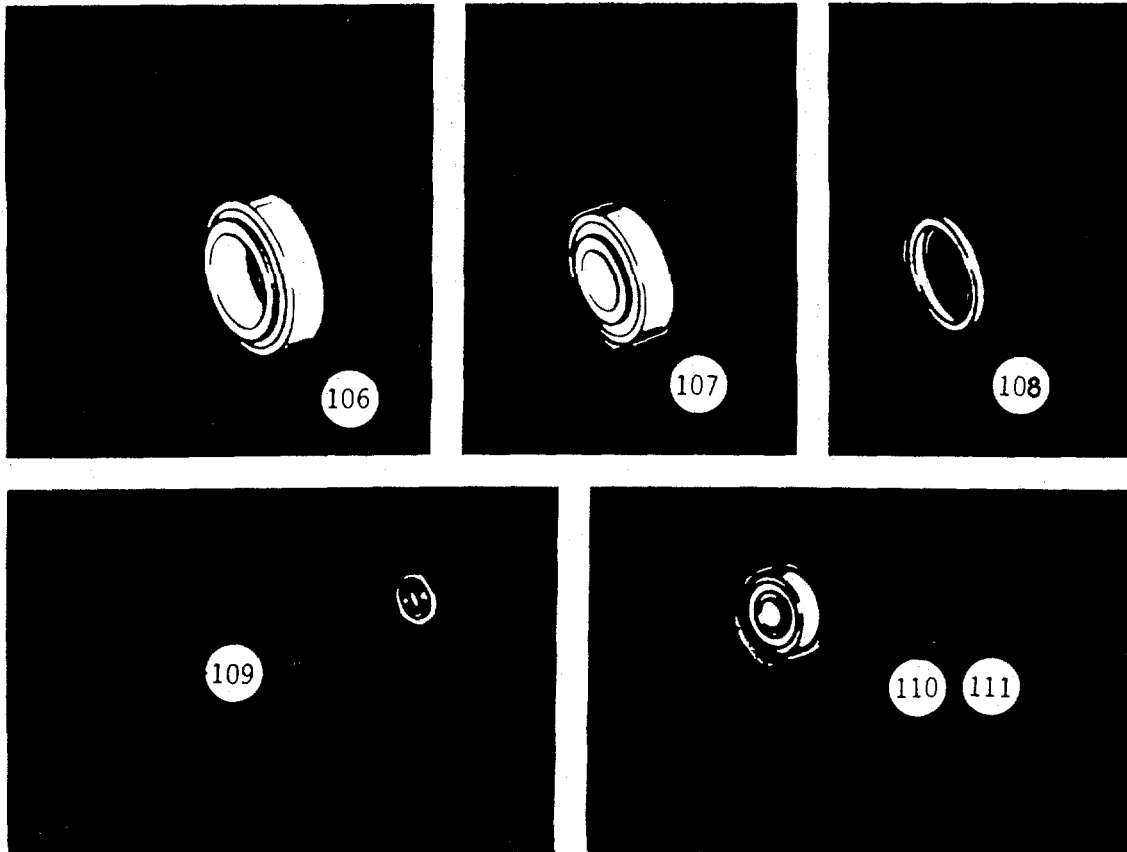

(1) ILLUS NO.	(2) NATIONAL STOCK NUMBER	(3) DESCRIPTION FSCM AND PART NUMBER	(4) USABLE ON CODE U/M	(5) QTY RQR
<u>HORSBURG - SCOTT 90T SPEED REDUCER</u>				
106	3110-00-001-4769	Bearing, Slow Speed (60038) JM718149/JM718110	EA	2
107	3110-00-115-6105	Bearing, Slow Speed (60038) H414249/H414210	EA	2
108	5330-00-477-0225	Seal, Slow Speed (29386) 34861	EA	1
109	5330-00-888-6345	Seal, High Speed (29386) CR11124	EA	1
<u>STERLING POWER 15 HP MOTOR</u>				
110	3110-00-158-8161	Bearing, F. E. (52676) 6308-ZZ	EA	1
111	3110-00-155-6190	Bearing, B. E. (52676) 6309-ZZ	EA	1

SECTION III. BASIC ISSUE ITEMS LIST (CONTINUED).

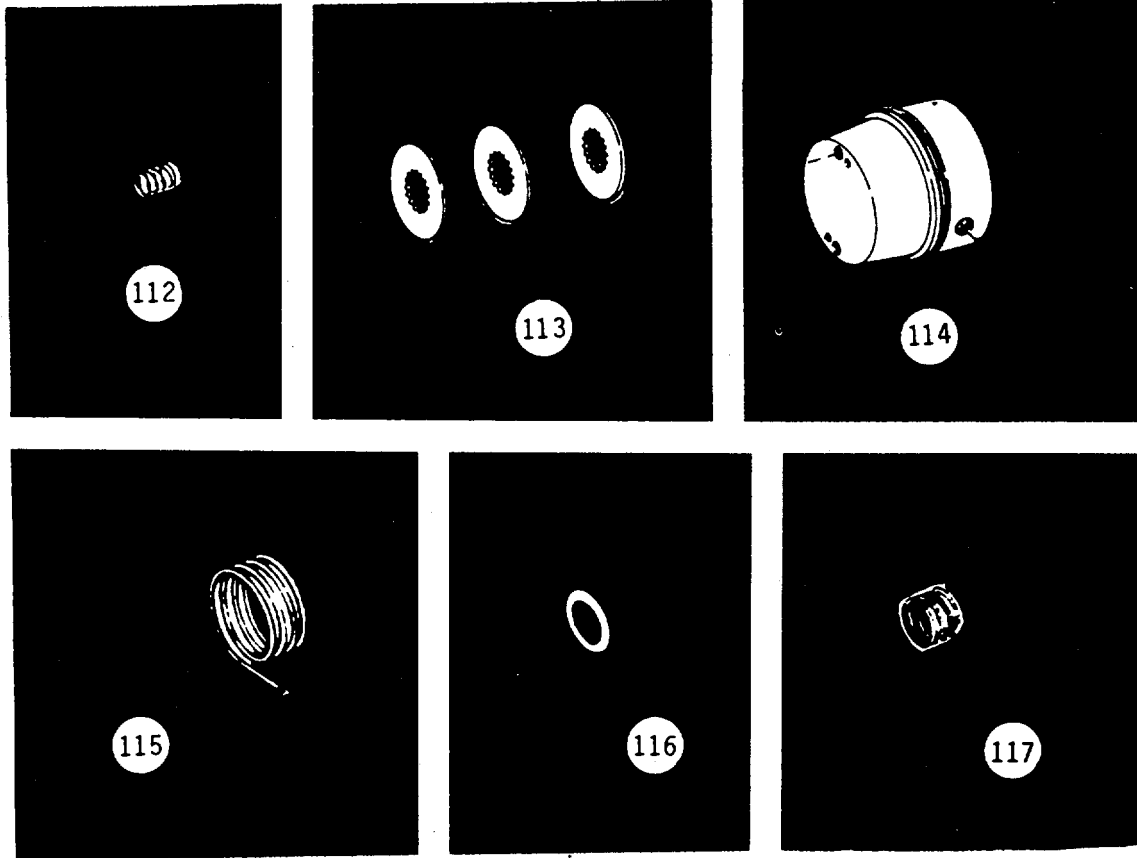

(1) ILLUS NO.	(2) NATIONAL STOCK NUMBER	(3) DESCRIPTION FSCM AND PART NUMBER	(4) USABLE ON CODE U/M	(5) QTY RQR
		<u>DINGS MDL 5-73050-4 50 LB BRAKE</u>		
112	5360-00-021-1547	Spring, Pressure (17904) G700-12	EA	1
113	3010-00-718-4525	Disc, Friction (17904) H70103	EA	2
114	5950-01-039-7161	Magnet, Brake (17904) R73050-4	EA	1
		<u>NAMCO SNAP-LOCK LIMIT SWITCH/MARINE SWITCH</u>		
115	5360-01-017-2522	Spring, Torsion (42337) EH160-03892	EA	2
116	5330-01-042-2328	"O" Ring (51238) EHO80-00063	EA	2
117	5360-01-017-2493	Spring, Cam (51238) EH160-03898	EA	2

SECTION III. BASIC ISSUE ITEMS LIST (CONTINUED).

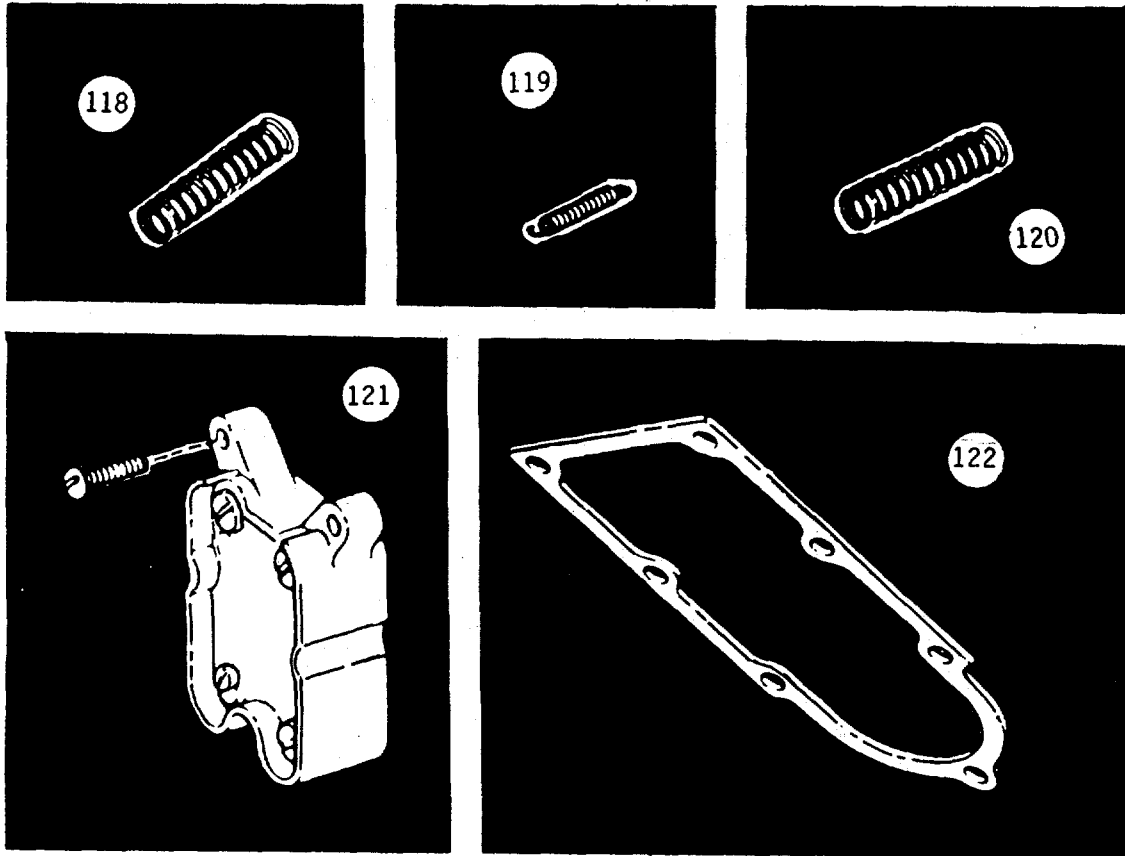

(1) ILLUS NO.	(2) NATIONAL STOCK NUMBER	(3) DESCRIPTION FSCM AND PART NUMBER	(4) USABLE ON CODE U/M	(5) QTY RQR
118	5360-01-017-2523	Spring, Slide (51238) EH160-03899	EA	1
119	5360-01-017-2494	Spring, Latch (51238) EH160-03897	EA	1
120	5360-01-017-2524	Spring, Slide Return (51238) EH160-03704	EA	1
121	5930-01-024-0877	Block, Assy, Contact (51238) EA711-11601	EA	1
122	5330-01-041-0699	Gasket, Bottom Cover EA780-10100-91	EA	1

SECTION III. BASIC ISSUE ITEMS LIST (CONTINUED).

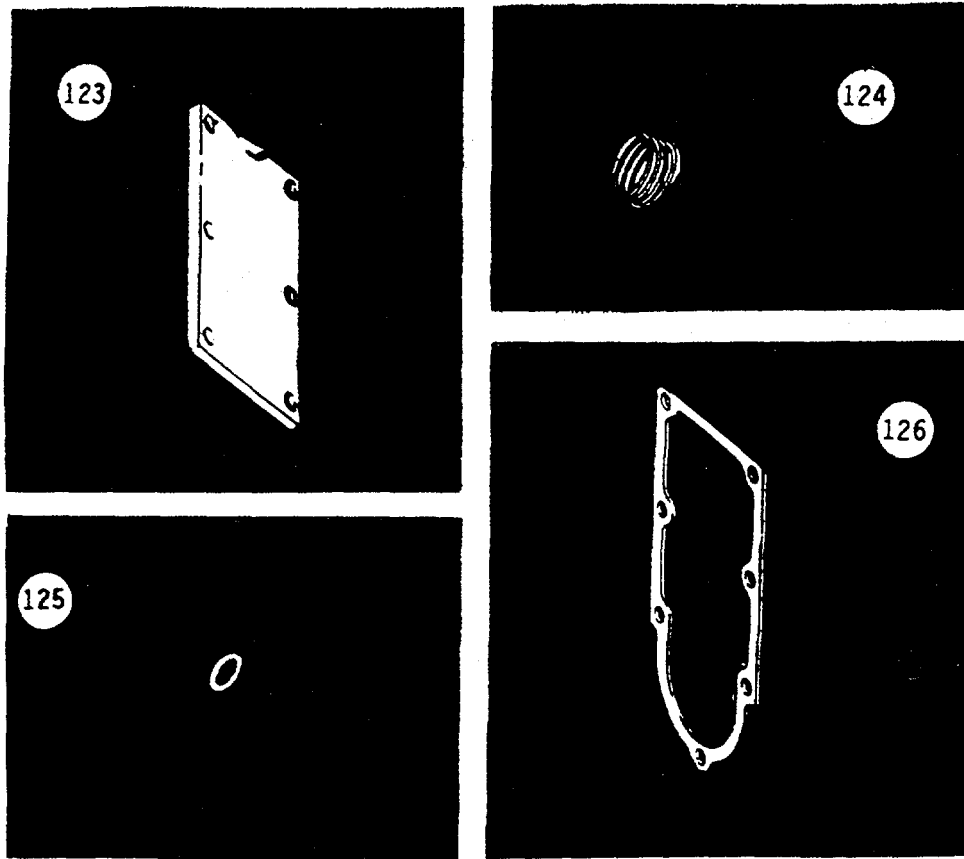

(1) ILLUS NO.	(2) NATIONAL STOCK NUMBER	(3) DESCRIPTION FSCM AND PART NUMBER	(4) USABLE ON CODE U/M	(5) QTY RQR
123	5330-01-041-6157	Gasket, Top Cover (51238) EA705-13101	EA	1
124		Spring, Torsion (51238) EA 160-03864	EA	1
125		"O" Ring, (51238) EA 080-00063	EA	1
126	5330-01-040-7853	Gasket, Bottom Cover (51238) EA 705-13107	EA	1

SECTION III. BASIC ISSUE ITEMS LIST (CONTINUED).

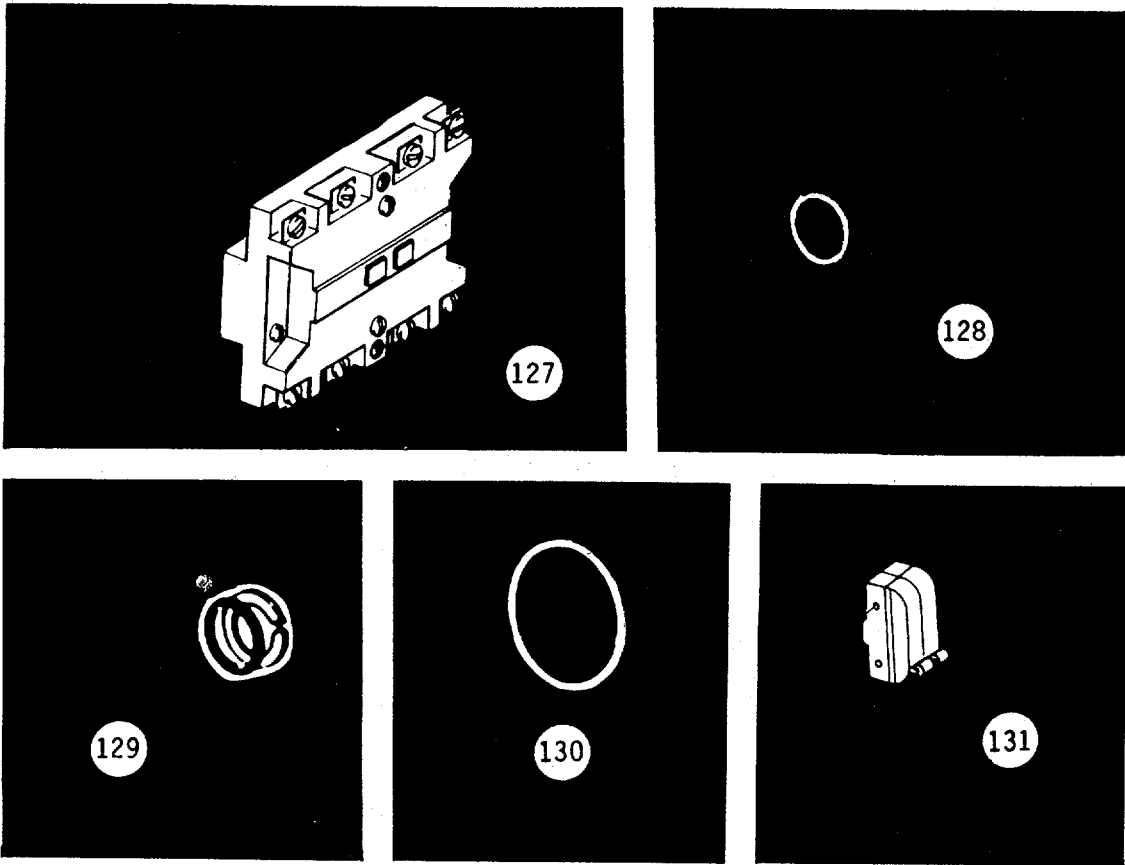

(1) ILLUS NO.	(2) NATIONAL STOCK NUMBER	(3) DESCRIPTION FSCM AND PART NUMBER	USABLE ON CODE	(4) U/M	(5) QTY RQR
		The following 21 items are u/o Sperry Steering System:			
127	5950-00-018-9265	Coil, Starter (01411) 505C806G1		EA	1
128	5330-00-434-1487	"O" Ring, 3/4 x 1 (30780) ARP 568-210		EA	2
129	5330-00-835-3007	"O" Ring & Back-up, 1 1/4 x 2 1/2 (30780) ARP 568-218		EA	2
130	5330-00-984-3762	"O" Ring, 2 1/4 x 2 1/2 (30780) ARP-568-228		EA	2
131	5930-01-063-2958	Switch, Micro (56232) 771614		EA	2

SECTION III. BASIC ISSUE ITEMS LIST (CONTINUED).

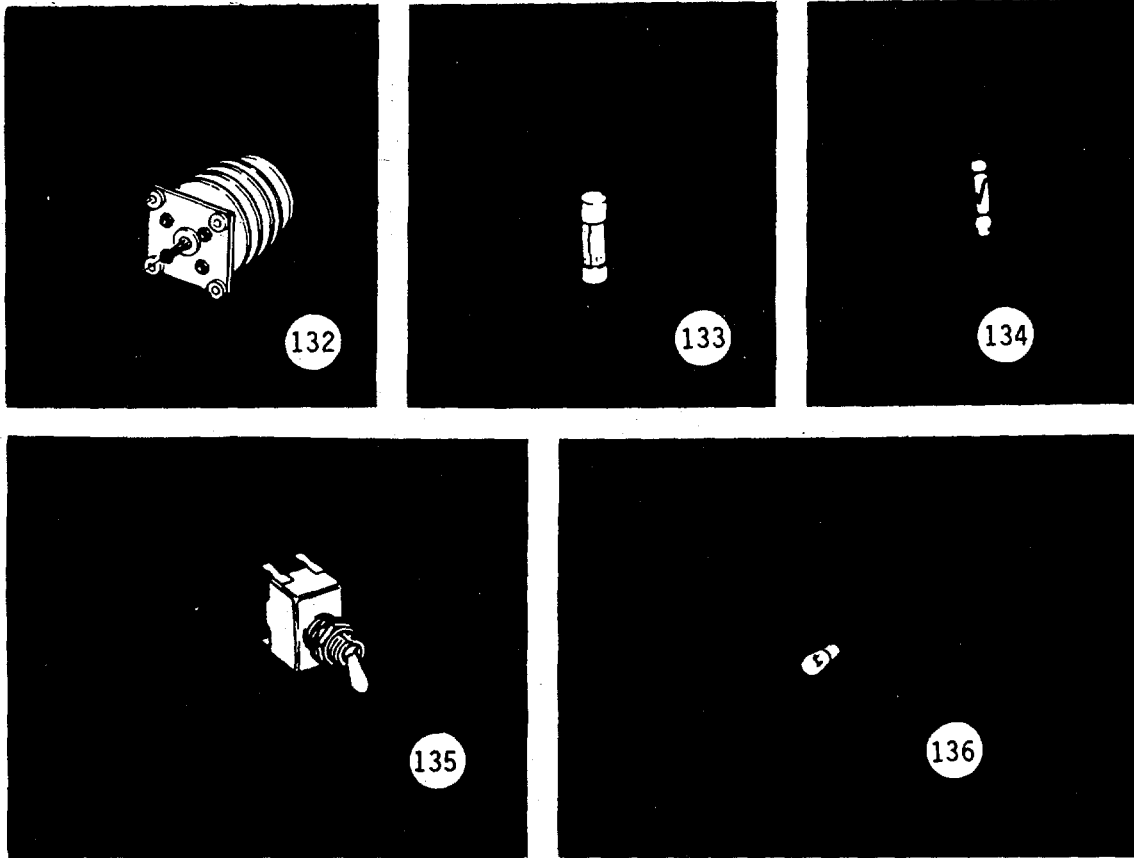

(1) ILLUS NO.	(2) NATIONAL STOCK NUMBER	(3) DESCRIPTION FSCM AND PART NUMBER	(4) USABLE ON CODE U/M	(5) QTY RQR
132	5930-01-017-0342	Switch, Operator (27191) E30AD	EA	1
133	5920-00-280-4960	Fuse (81349) F02A250V 2A	EA	5
134	5920-00-284-6787	Fuse (81349) R02A250V 5A	EA	10
135	5930-00-683-1628	Switch, Toggle (96906) MS24523-22	EA	1
136	6240-00-939-7859	Lamp (71744) 120MB	EA	10

SECTION III. BASIC ISSUE ITEMS LIST (CONTINUED).

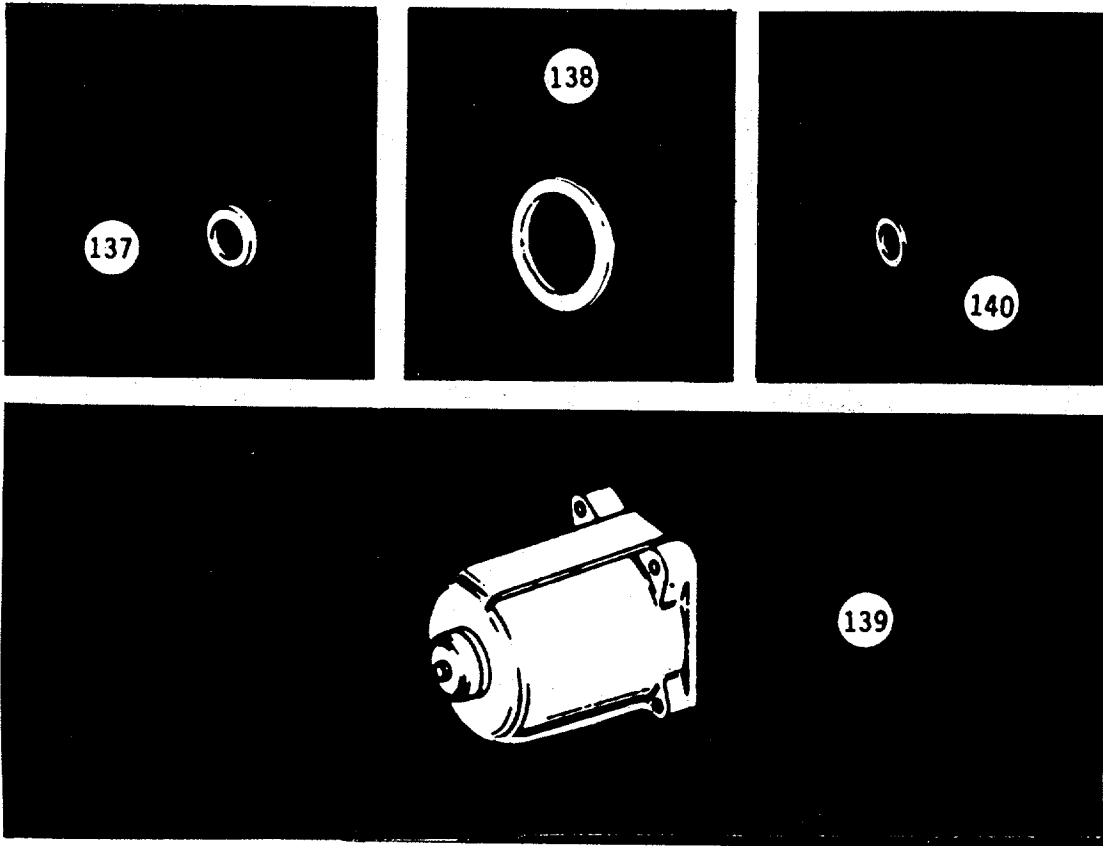

(1) ILLUS NO.	(2) NATIONAL STOCK NUMBER	(3) DESCRIPTION FSCM AND PART NUMBER	(4) USABLE ON CODE U/M	(5) QTY RQR
137	5330-01-021-3786	Cup, Seal, Rod, 1 x 1 3/8 (02697) 18701000	EA	2
138	5330-01-021-3787	Cup, Seal, 2 1/8 x 2 1/2 (83259) 18702125	EA	4
139	5945-00-967-4798	Solenoid (62983) 195053	EA	1
140	5845-00-999-2985	Ring, Retaining (62983) 236797	EA	1

SECTION III. BASIC ISSUE ITEMS LIST (CONTINUED)

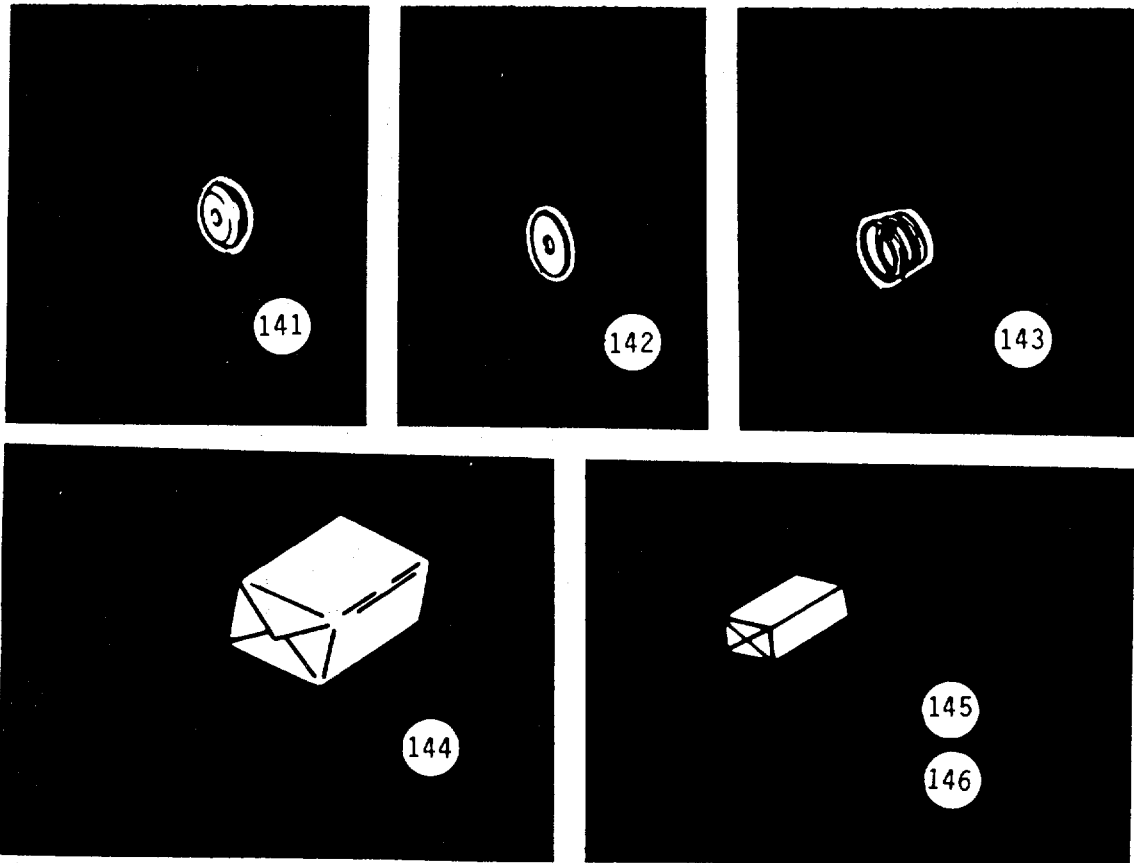

(1) ILLUS NO.	(2) NATIONAL STOCK NUMBER	(3) DESCRIPTION FSCM AND PART NUMBER	(4) USABLE ON CODE U/M	(5) QTY RQR
141	5315-00-159-2781	Guide, Spring (62983) 281422	EA	3
142	4810-00-059-6729	Washer (62983) 281423	EA	2
143	5360-00-059-6725	Spring (62983) 290072	EA	1
144	5330-01-073-0865	Gasket Kit (62983) 919190	EA	1
145	5330-01-040-7788	Gasket Kit (62983) 919428	EA	1
146	3930-00-587-7019	Pump Seal Kit (62983) 922733	EA	1

SECTION III. BASIC ISSUE ITEMS LIST (CONTINUED).

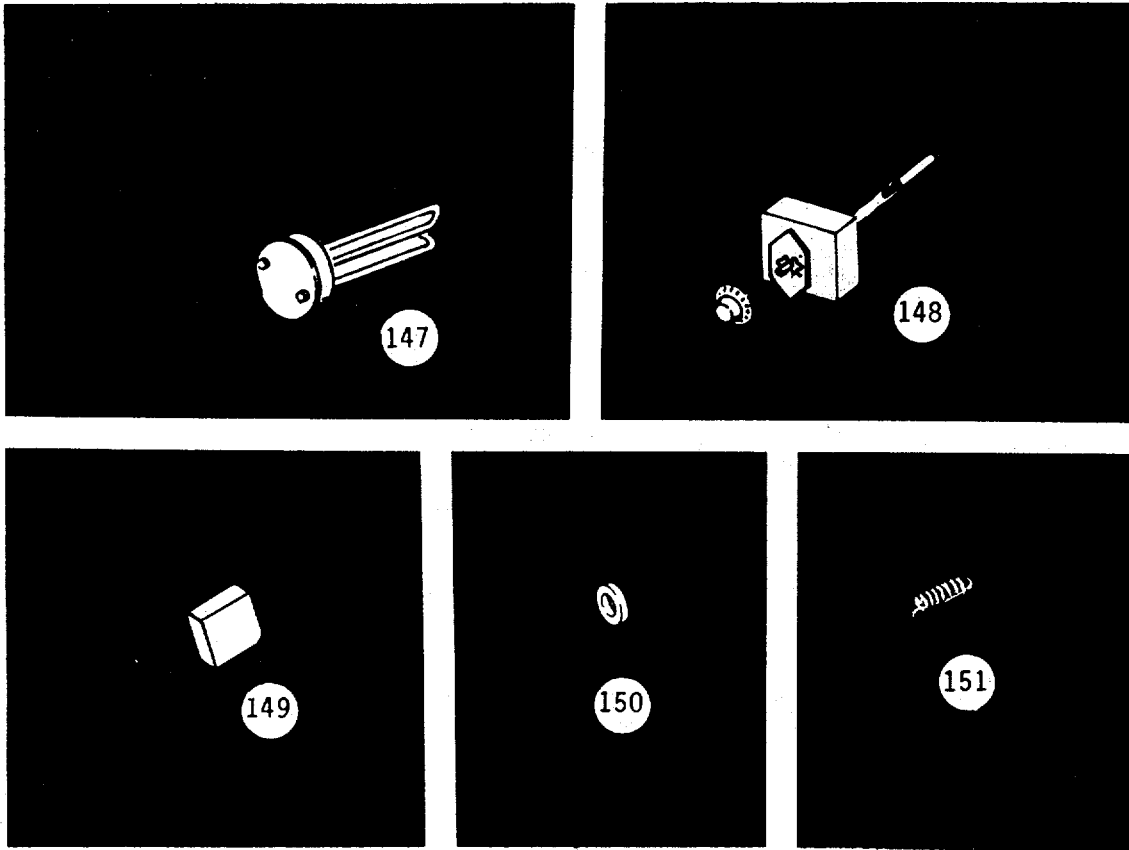

(1) ILLUS NO.	(2) NATIONAL STOCK NUMBER	(3) DESCRIPTION FSCM AND PART NUMBER	(4) USABLE ON CODE U/M	(5) QTY RQR
147	4540-00-938-2907	The following 2 items are u/o Electric Heater Company Hot Water Heater:		
148		Element, Heater (19857) 3-38682	EA	1
		Switch, Thermostatic (19857) DIA-Z-52162-006	EA	1
		The following 3 items are u/o Blackmer Pump Co. Lube Oil Transfer Pump:		
149	4320-00-712-1452	Vane (07524) 090405	EA	3
150	5330-00-054-4946	Packing (07524) 300105	EA	1
151	5360-00-776-7201	Spring (07524) 110401	EA	3

SECTION III. BASIC ISSUE ITEMS LIST (CONTINUED).

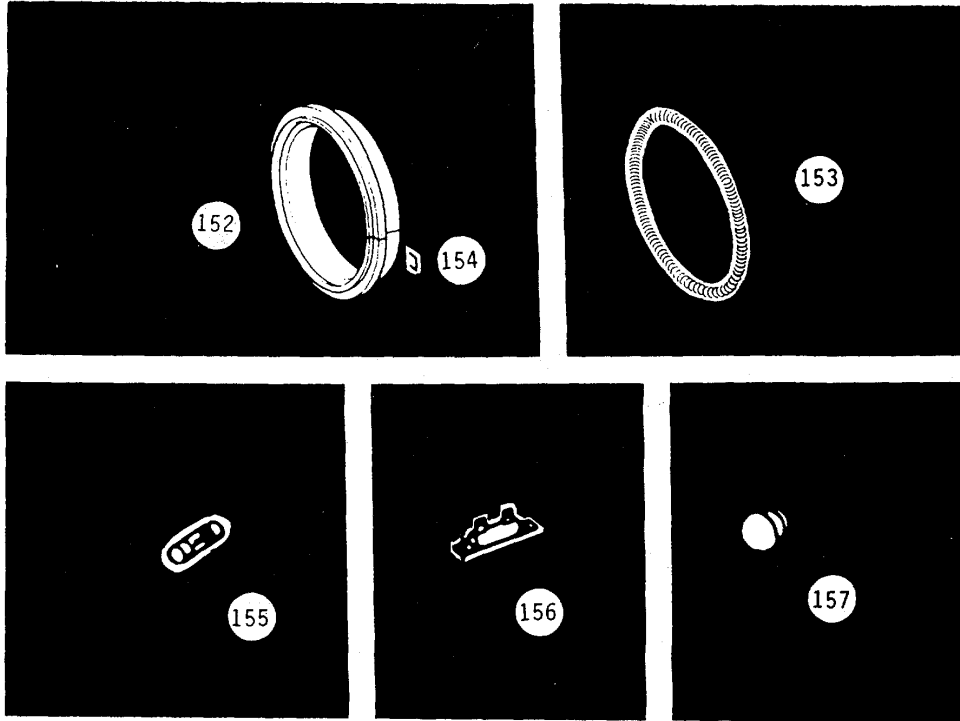

(1) ILLUS NO.	(2) NATIONAL STOCK NUMBER	(3) DESCRIPTION FSCM AND PART NUMBER	USABLE ON CODE	(4) U/M	(5) QTY RQR
		The following 3 items are u/o The Propeller Shaft Syntron Seal by RMC Corp:			
152	5330-00-650-2587	Element, Sealing (58849) 52384		EA	4
153	5360-00-619-0773	Spring, Garter (58849) 52385		EA	4
154	5315-00-664-0696	Staple, Barbed (58849) 44244			
		The following 3 items are u/o Electrol Specialties Ship's Service Switchboard:			
155	5920-00-050-4970	Fuse (71400) ABC-30		EA	5
156	5905-00-892-0337	Resistor, (44655) 0214		EA	1
157	6240-00-143-7432	Lamp, Indicator (96906) MS15579-6		EA	5

SECTION III. BASIC ISSUE ITEMS LIST (CONTINUED).

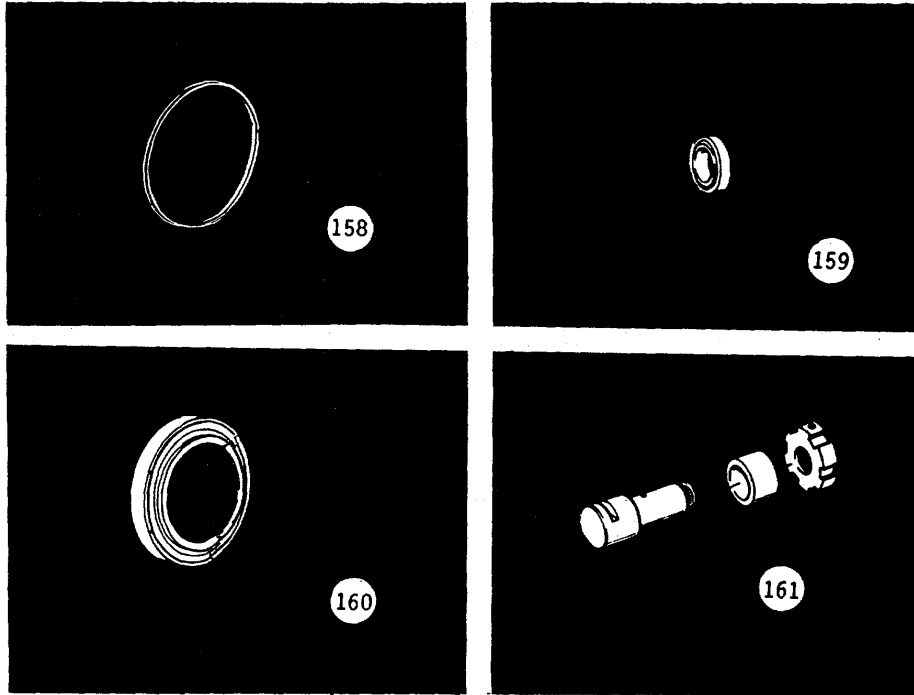

(1) ILLUS NO.	(2) NATIONAL STOCK NUMBER	(3) DESCRIPTION FSCM AND PART NUMBER USABLE ON CODE	(4) U/M	(5) QTY RQR
The following 4 items are u/o Anchor Cable Swivel Fairleader by Smith-Berger Corp:				
158	5330-01-073-0905	Seal, Shank (Felt) (15950) MK-2	EA	1
159	3110-00-100-0317	Bearing, Sheave (15950) (60038) 472	EA	2
160	3110-01-101-0797	Bearing, Sheave (15950) M241543-M241510	EA	2
161	5315-01-040-6554	Pin, Sheave w/Nut (15950) 31838	EA	2

SECTION III. BASIC ISSUE ITEMS LIST (CONTINUED).

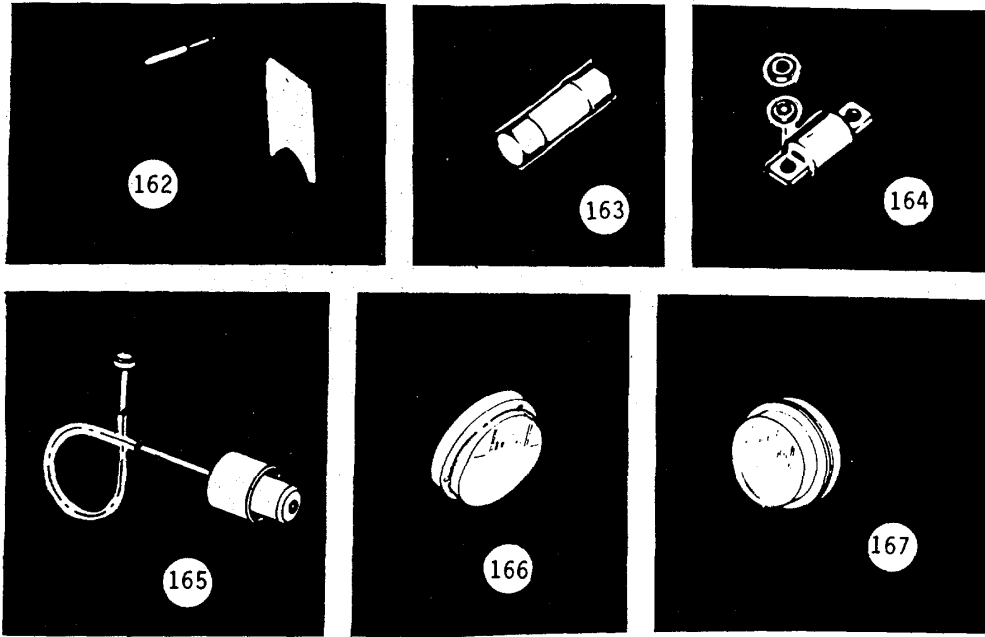

(1) ILLUS NO.	(2) NATIONAL STOCK NUMBER	(3) DESCRIPTION FSCM AND PART NUMBER	USABLE ON CODE	(4) U/M	(5) QTY RQR
162	5110-01-038-5815	The following item is u/o Northern Hardware's Wire Rope Cutter: Blade (85767) 135		EA	3
163	5920-00-829-3806	The following 2 items are u/o Lamarche Mfg. Co's - Rectifier: Fuse, Input (45A250V) AC (92731) P-8-45		EA	2
164	5920-00-828-0148	Fuse, Output (80A130V) AC (83698) A13X-80		EA	2
165	5895-01-037-0553	The following 3 items are u/o Hose-McCann Sound Powered Telephone Headset: Cable (73274) 70214-890		EA	1
166	5865-01-039-9061	Unit, Earphone (14100) 702003-277		EA	2
167	5965-01-040-4304	Unit, Transmitter (14100) 702003-278		EA	1

SECTION III. BASIC ISSUE ITEMS LIST (CONTINUED).

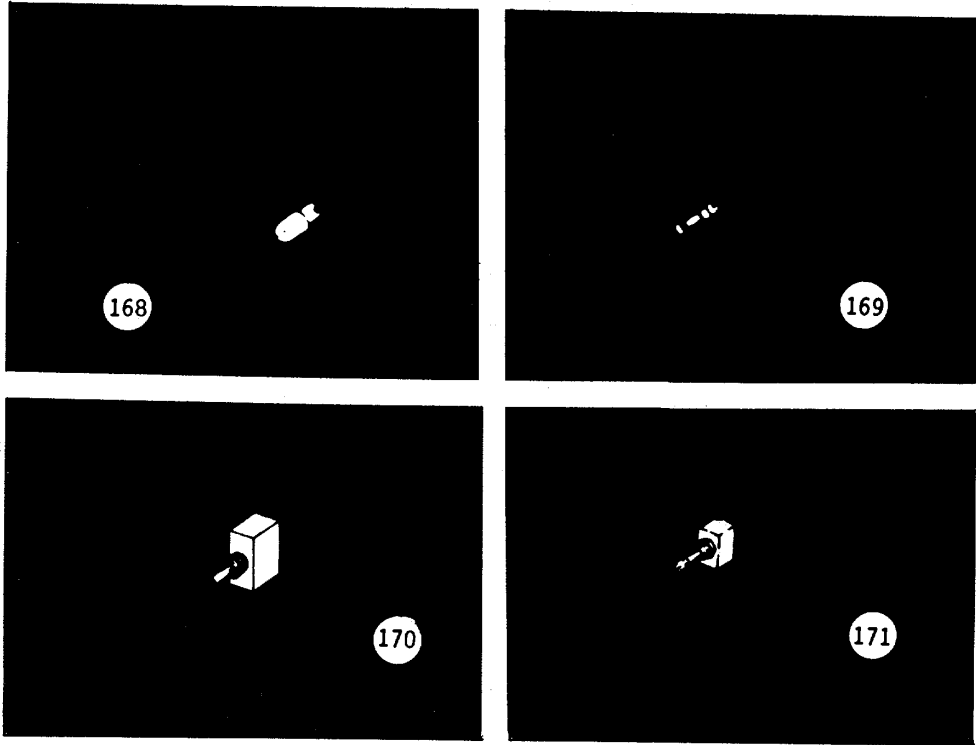

(1) ILLUS NO.	(2) NATIONAL STOCK NUMBER	(3) DESCRIPTION FSCM AND PART NUMBER	(4) USABLE ON CODE U/M	(5) QTY RQR
		The following 4 items are u/o Delaval Gens. Sensors Modular Receiver:		
168	6210-00-475-9532	Lamp (96906) 3278237	EA	1
169	5920-00-252-2019	Fuse, Lamp (96906) MS 10088-3	EA	1
170	5930-00-878-6734	Switch, Toggle (96906) MS 24659-22D	EA	1
171	5930-00-810-5410	Switch, Toggle (04034) MS 24659-26F	EA	1

SECTION III. BASIC ISSUE ITEMS LIST (CONTINUED).

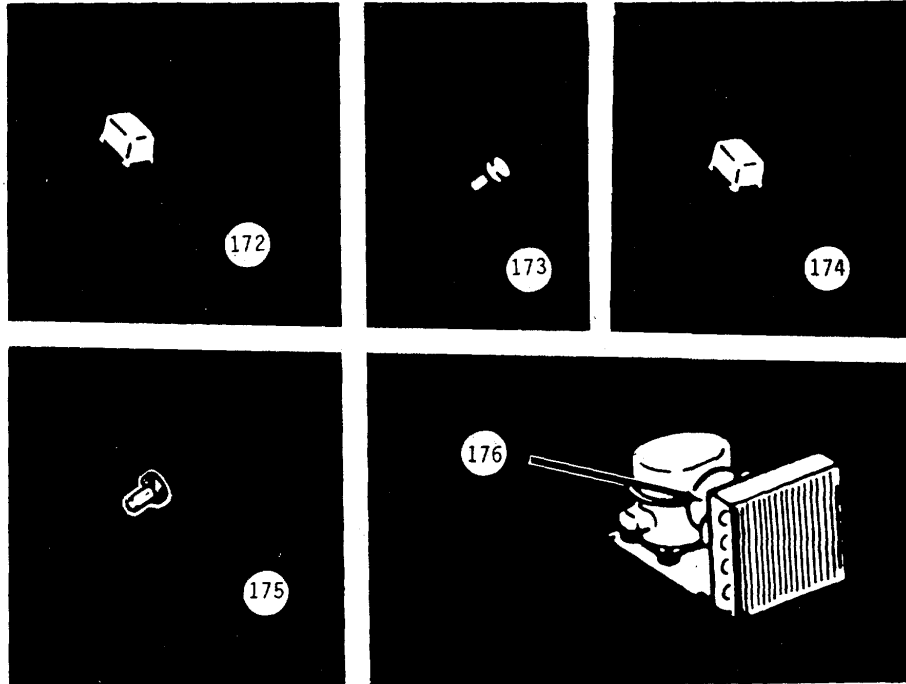

(1) ILLUS NO.	(2) NATIONAL STOCK NUMBER	(3) DESCRIPTION FSCM AND PART NUMBER	(4) USABLE ON CODE U/M	(5) QTY RQR
172		The following 7 items are u/o Foster Refrigeration Co's. Refrig/Freezer: Relay, Refrigerator (59431) 82636	EA	1
173	5945-00-013-9566	Relay, Freezer (59431) 82468	EA	1
174	6105-00-844-3972	Overload, Refrigerator (59431) 83601	EA	1
175	6105-00-937-5785	Overload, Freezer (59431) 83426	EA	1
176	6105-01-137-6075	Motor, Condensor Fan (Refrigerator) (59431) 81085A	EA	1

SECTION III. BASIC ISSUE ITEMS LIST (CONTINUED).

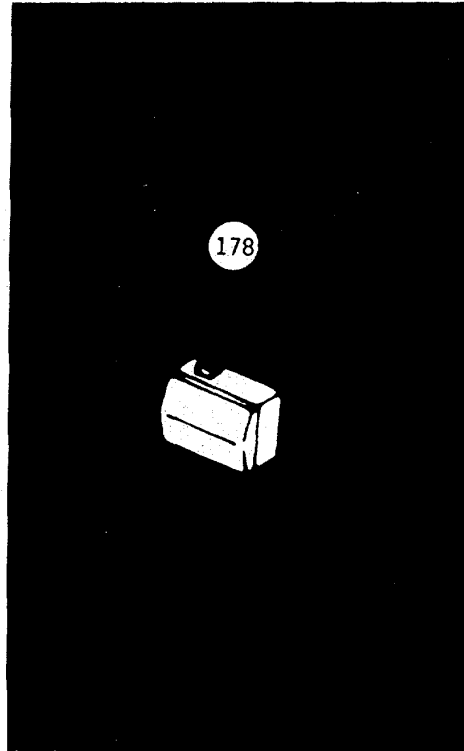
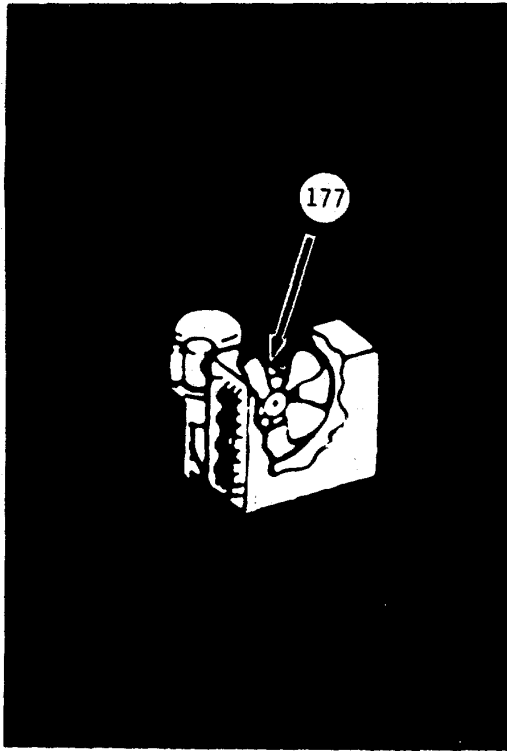

(1) ILLUS NO.	(2) NATIONAL STOCK NUMBER	(3) DESCRIPTION FSCM AND PART NUMBER	(4) USABLE ON CODE U/M	(5) QTY RQR
177	6105-01-085-5096	Motor, Condensor Fan (Freezer) (25795) 810G006A12	EA	1
178		Timer, Defrost (45605) 31050	EA	1

SECTION III. BASIC ISSUE ITEMS LIST (CONTINUED).

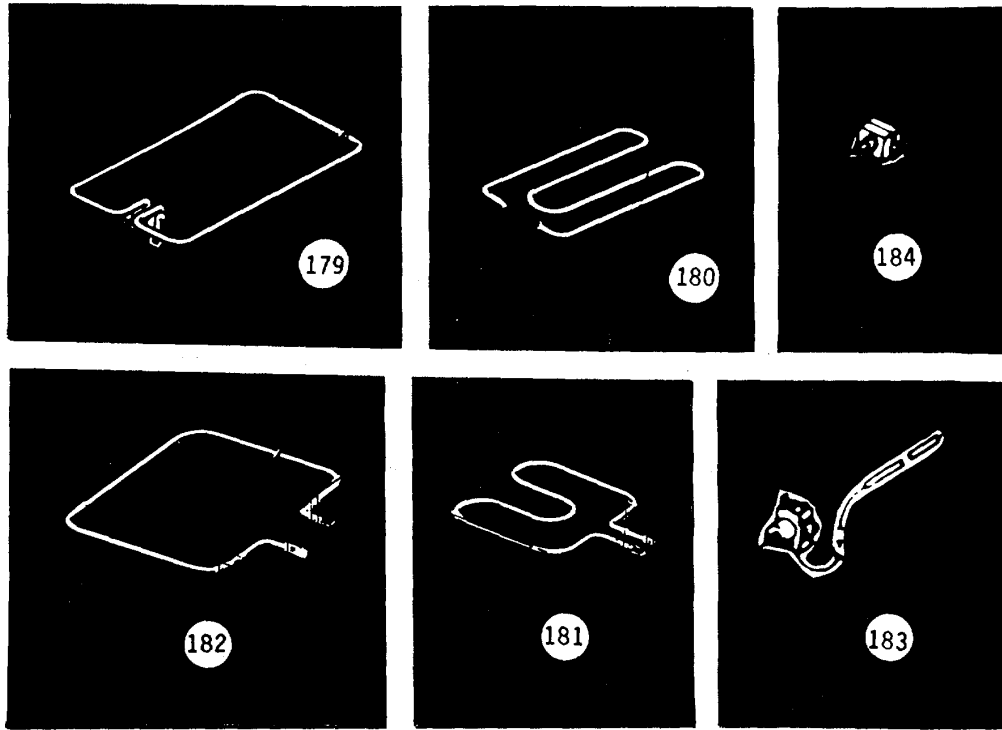

(1) ILLUS NO.	(2) NATIONAL STOCK NUMBER	(3) DESCRIPTION FSCM AND PART NUMBER USABLE ON CODE	(4) U/M	(5) QTY RQR
		The following 6 items are u/o McGraw-Edison's 440V Electric Range:		
179	7310-01-093-3457	Element, Surface, Outer, 2750W, 460V (78770) 20MIE-30	EA	1
180	7310-01-093-3458	Element, Surface Inner, 2750W, 460V (78770) 20MIE-31	EA	1
181	7310-01-093-3459	Element, Oven, Inner, 900W, 460V (78770) PA-169-13	EA	1
182		Element, Oven Outer 900W, 460V (78770) PA-169-13	EA	1
183	5930-00-828-0004	Thermostat, Oven (78770) 18A18-74	EA	1
184	5930-00-784-8989	Switch, 3-Heat (78770) 4111A8733	EA	1

SECTION III. BASIC ISSUE ITEMS LIST (CONTINUED).

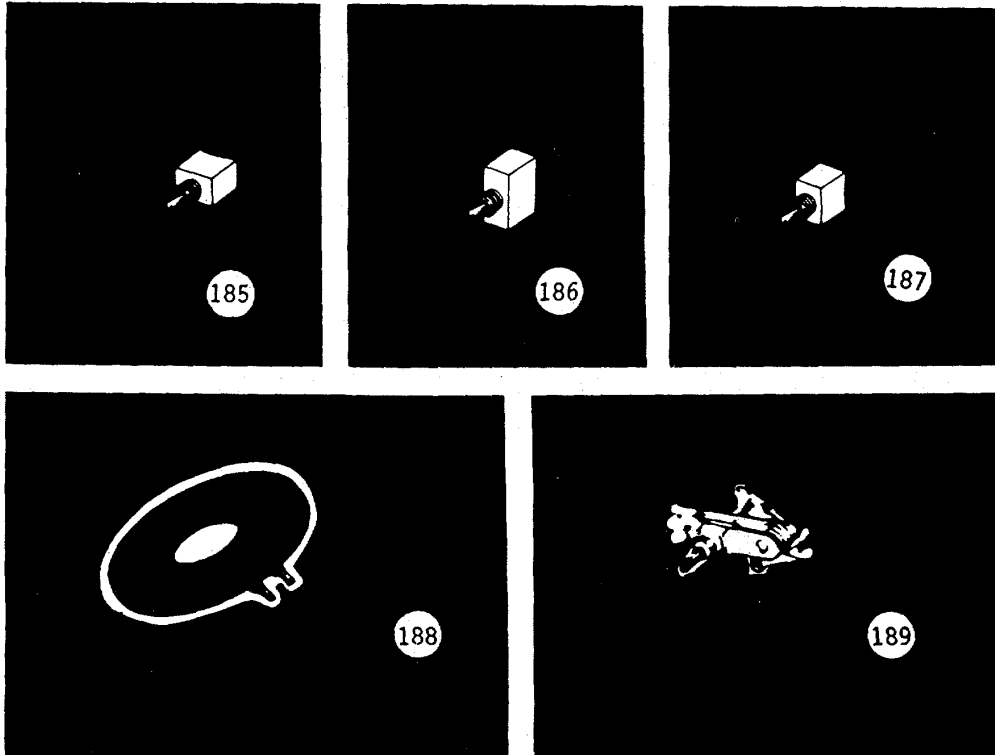

(1) ILLUS NO.	(2) NATIONAL STOCK NUMBER	(3) DESCRIPTION FSCM AND PART NUMBER	(4) USABLE ON CODE U/M	(5) QTY RQR
185	5930-00-615-9376	The following 3 items are u/o Electrol Specialties Navigational Light Panel: Switch, Toggle (96906) MS35059-21	EA	1
186	5930-00-615-7883	Switch, Toggle (96906) MS25068-21	EA	1
187	5930-00-655-1575	Switch, Toggle (96906) MS35059-22	EA	1
188	7310-00-998-2811	The following 5 items are u/o Cory Corp's. Coffee Maker & 2 Burner Range: Element (14718) 134829	EA	1
189	5930-00-018-9276	Switch (14718) 185200	EA	2

SECTION III. BASIC ISSUE ITEMS LIST (CONTINUED).

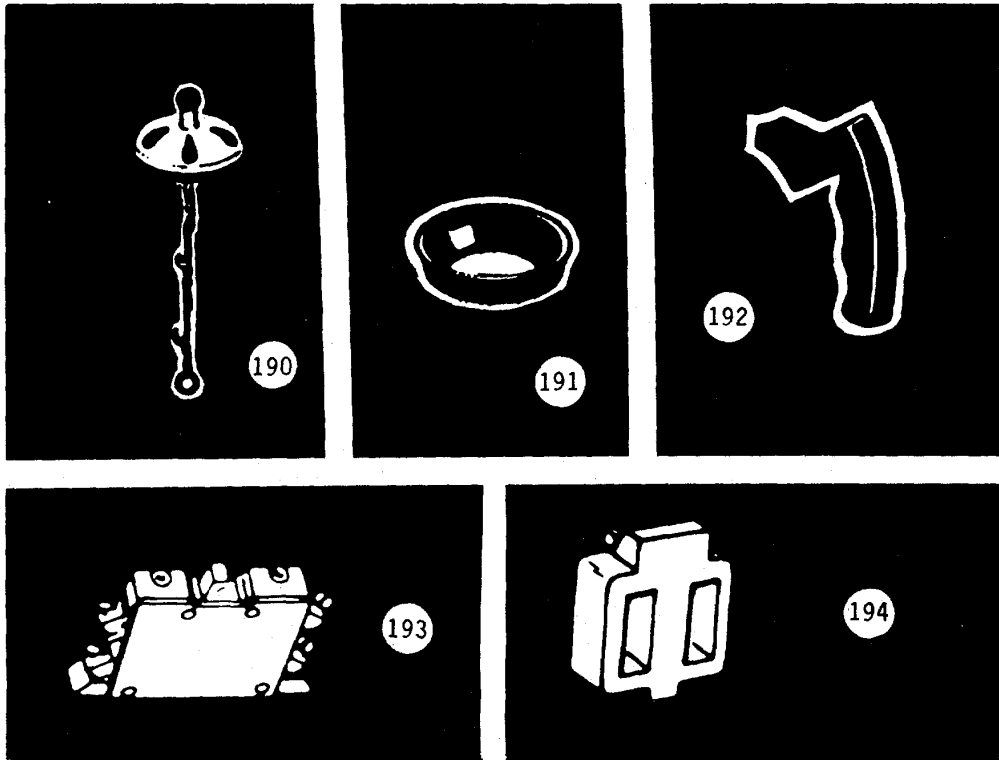

(1) ILLUS NO.	(2) NATIONAL STOCK NUMBER	(3) DESCRIPTION FSCM AND PART NUMBER USABLE ON CODE	(4) U/M	(5) QTY RQR
190	7310-01-041-1216	Filter, CRES (14718) 205301	EA	1
191	5325-01-041-9578	Bushing, Rubber (14718) 204000	EA	1
192	7310-01-044-5385	Handle (14718) 201000	EA	1
		The following 17 items are u/o various Cutler-Hammer Magnetic Controllers:		
193	5945-00-138-5220	Interlock (27191) C320KB2	EA	2
194	5950-00-401-6781	Coil, Shunt (110V) (27191) 9-1887-19	EA	1

SECTION III. BASIC ISSUE ITEMS LIST (CONTINUED).

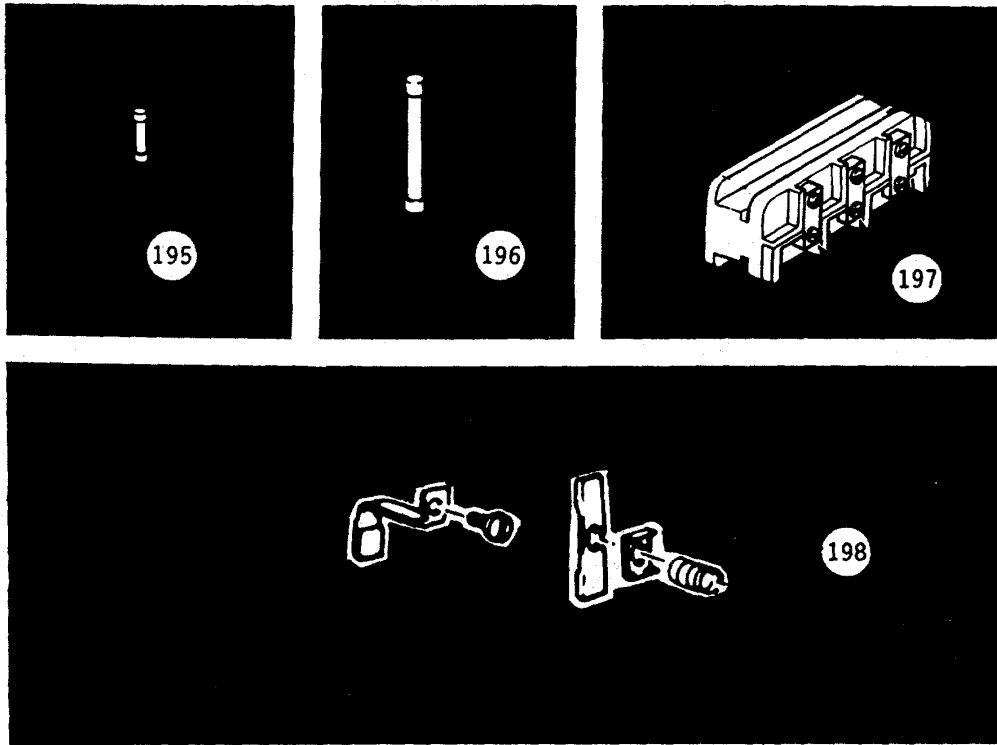

(1) ILLUS NO.	(2) NATIONAL STOCK NUMBER	(3) DESCRIPTION FSCM AND PART NUMBER USABLE ON CODE	(4) U/M	(5) QTY RQR
195	5920-00-646-4630	Fuse 10A 500V (27191) F61C500V10A	EA	2
196	5920-00-515-3208	Fuse 30A 250V (27191) F15B250V30A	EA	2
197	5999-00-518-3060	Heater, Overload (21810) 5490F4-0	EA	3
198	5945-00-165-0369	Renewal Set, Contact (217192) 6-23-2	EA	1

SECTION III. BASIC ISSUE ITEMS LIST (CONTINUED).

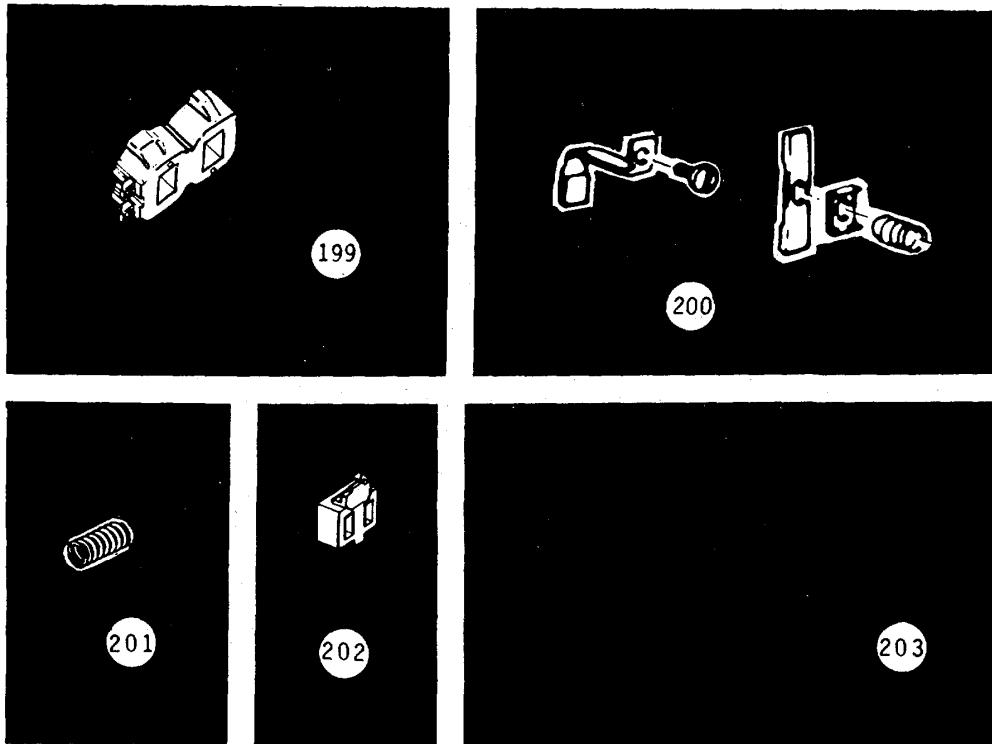

(1) ILLUS NO.	(2) NATIONAL STOCK NUMBER	(3) DESCRIPTION FSCM AND PART NUMBER USABLE ON CODE	(4) U/M	(5) QTY RQR
199	5950-01-031-3205	Coil, Shunt (440V) (27191) 9-1889-20	EA	2
200	5999-00-318-2670	Renewal Set (27191) 6-22-2	EA	4
201	5360-00-760-7331	Spring, Arm, Frame (27191) 69-2507	EA	6
202	5950-00-121-2796	Coil, Shunt (110V) (27191) 9-1887-17	EA	1
203	5920-01-017-0342	Switch, Operator (27193) E30AD	EA	2

SECTION III. BASIC ISSUE ITEMS LIST (CONTINUED).

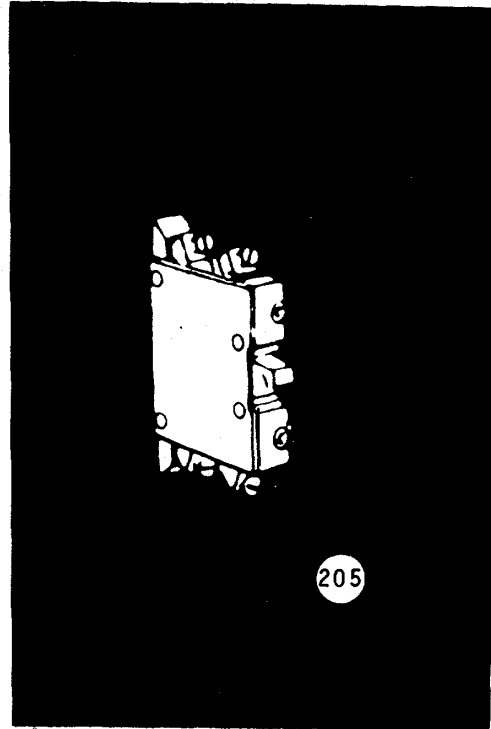
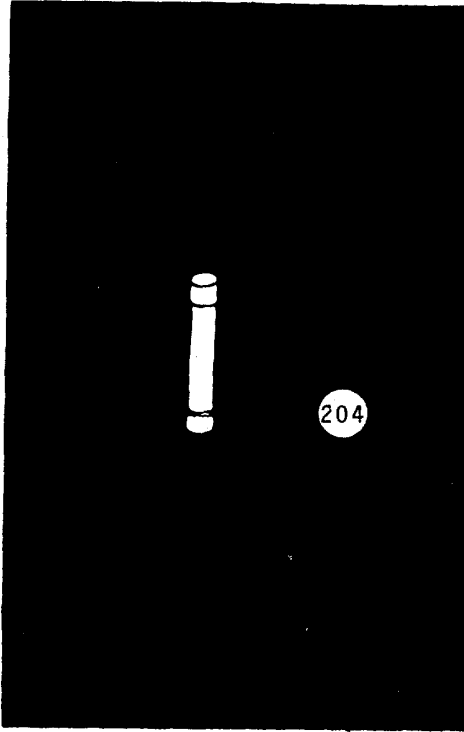

(1) ILLUS NO.	(2) NATIONAL STOCK NUMBER	(3) DESCRIPTION FSCM AND PART NUMBER	(4) USABLE ON CODE U/M	(5) QTY RQR
204	5920-01-050-0544	Fuse (27191) 611-562 F15A250V3A	EA	2
205	5945-00-138-5220	Interlock (27191) C320KB2	EA	4

SECTION III. BASIC ISSUE ITEMS LIST (CONTINUED).

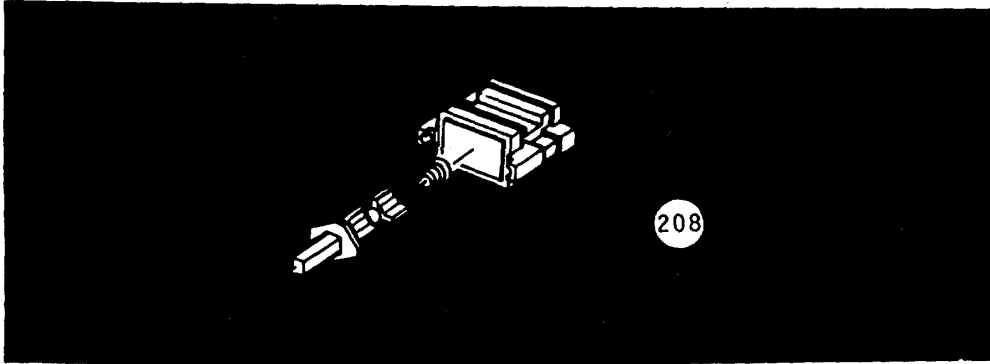
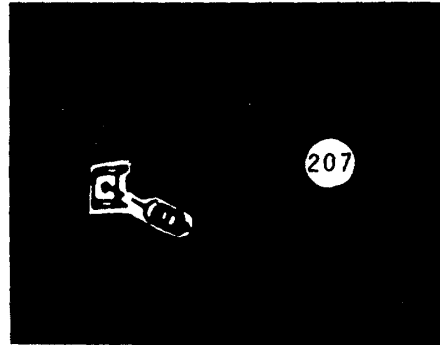
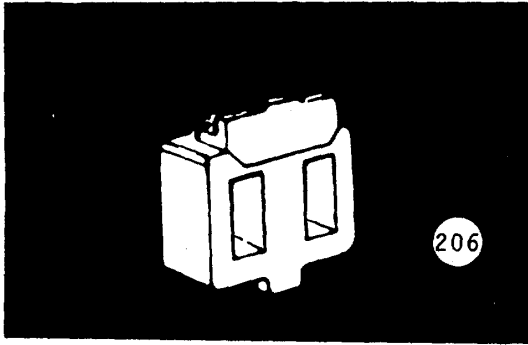

(1) ILLUS NO.	(2) NATIONAL STOCK NUMBER	(3) DESCRIPTION FSCM AND PART NUMBER USABLE ON CODE	(4) U/M	(5) QTY RQR
206	5950-00-131-1589	Coil, Shunt (440V) (27191) 9-1891-3	EA	2
207	5999-00-487-7697	Renewal Set (27191) 6-25-2 The following 1 item is u/o various Cutler-Hammer Pushbutton Stations:	EA	2
208	5930-00-296-6431	Element (Pushbutton) (15605) 86-346-3	EA	1

SECTION III. BASIC ISSUE ITEMS LIST (CONTINUED).

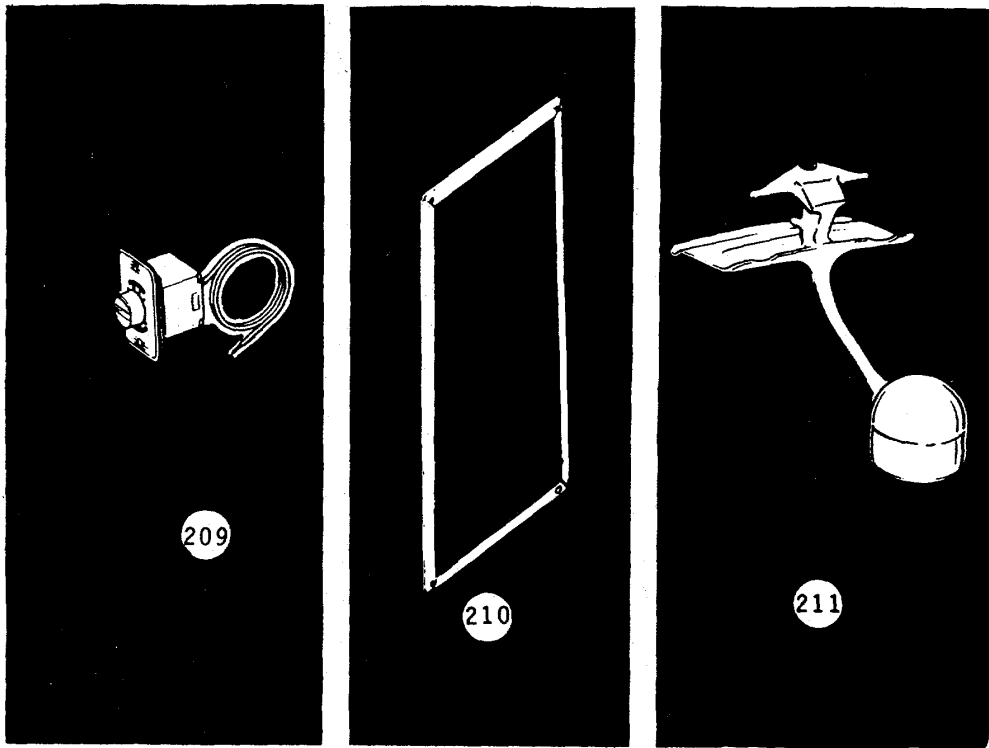

(1) ILLUS NO.	(2) NATIONAL STOCK NUMBER	(3) DESCRIPTION FSCM AND PART NUMBER	(4) USABLE ON CODE U/M	(5) QTY RQR
209	5930-00-929-2647	Control, Temperature (21880) 106784	EA	1
210	5330-00-880-8293	Gasket, Door (21880) 100841	EA	1
211	7310-00-214-8780	Valve Assembly (21880) 108133	EA	1

SECTION III. BASIC ISSUE ITEMS LIST (CONTINUED).

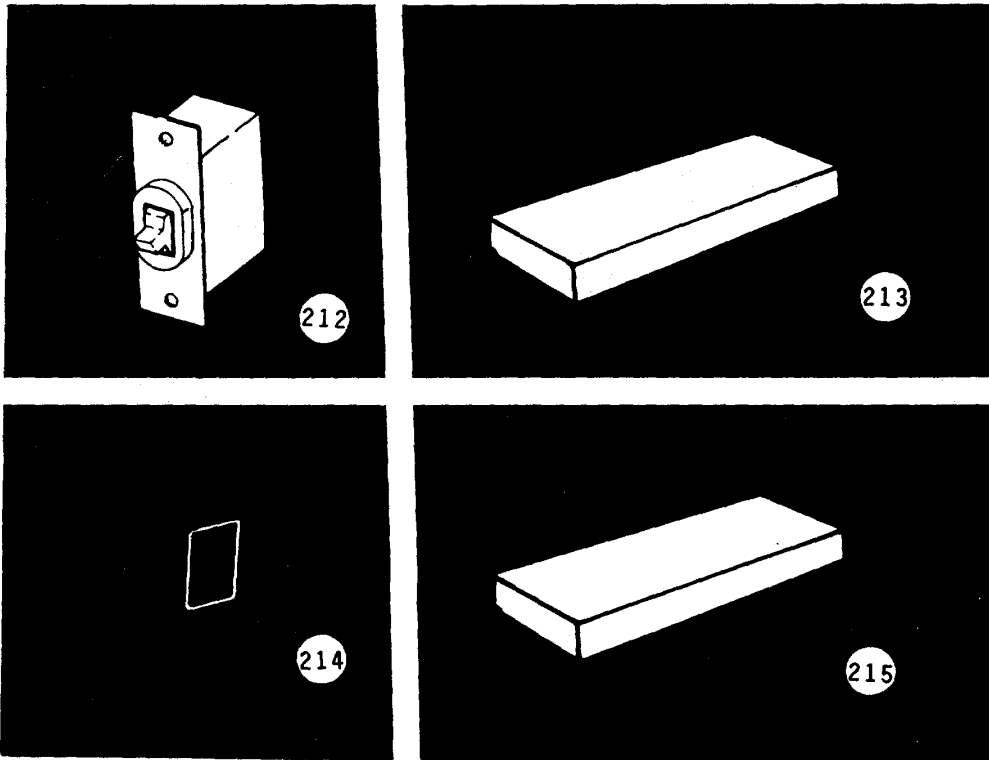

(1) ILLUS NO.	(2) NATIONAL STOCK NUMBER	(3) DESCRIPTION FSCM AND PART NUMBER USABLE ON CODE	(4) U/M	(5) QTY RQR
212	5930-01-258-0777	The following 1 item is u/o Light Fixtures: Switch, Toggle DPST (04009) T1312	EA	6
213	5330-00-379-4327	The following 31 items are u/o Detroit Diesel Model 1043-7000 (Prime mover for Anchor Winch): Gasket Kit, Engine Overhaul (72582) 5193114	EA	1
214	5330-00-425-5142	Gasket, Hand Hole Cover (72592) 5150020	EA	4
215	5330-00-166-8622	Gasket Kit, Cylinder Head Overhaul (72582) 5198676	EA	1

SECTION III. BASIC ISSUE ITEMS LIST (CONTINUED).

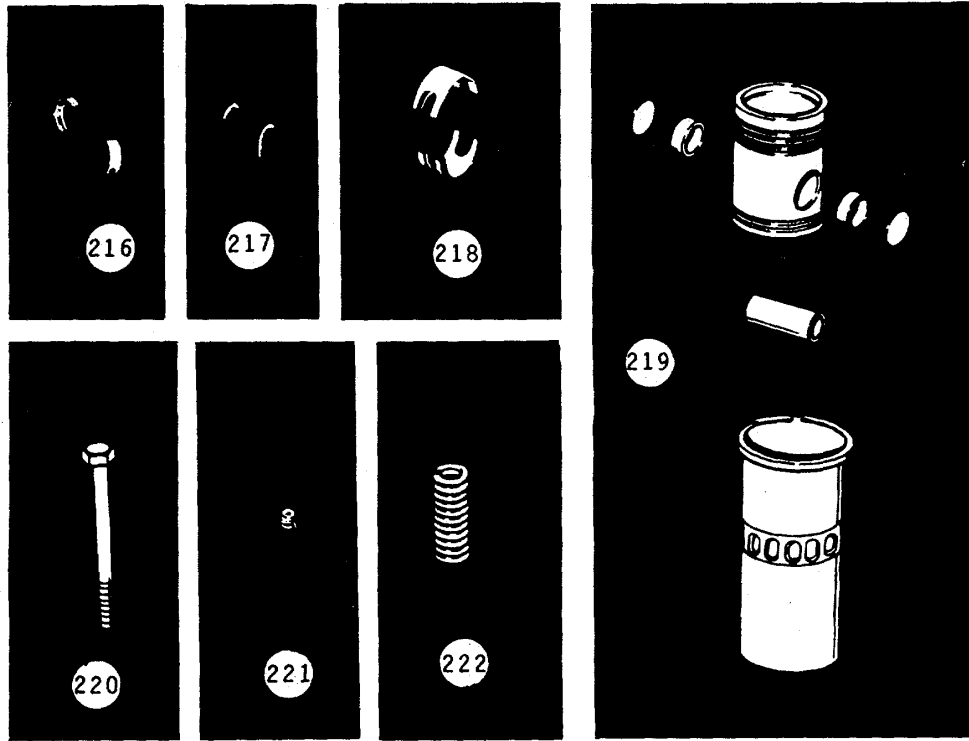

(1) ILLUS NO.	(2) NATIONAL STOCK NUMBER	(3) DESCRIPTION FSCM AND PART NUMBER USABLE ON CODE	(4) U/M	(5) QTY RQR
216	3120-00-662-8992	Shell Set, Main Bearing (72582) 5192874	EA	9
217	2815-00-511-2336	Washer, Thrust Main Bearing (72582) 5159353	EA	2
218	3120-00-662-8425	Shell Set, Con Rod (STD) (72582) 5192895	EA	4
219	2815-00-937-6571	Cylinder Kit "N" Non-Auto (72582) 5149265	EA	8
220	4730-00-212-6331	Bolt, Rocker Shaft Bracket (72582) 5150325	EA	8
221	5310-00-270-7111	Nut, Lock, Push Rod (72582) 5151601	EA	8
222	5360-00-252-8444	Spring, Push Rod (72582) 5186858	EA	8

SECTION III. BASIC ISSUE ITEMS LIST (CONTINUED).

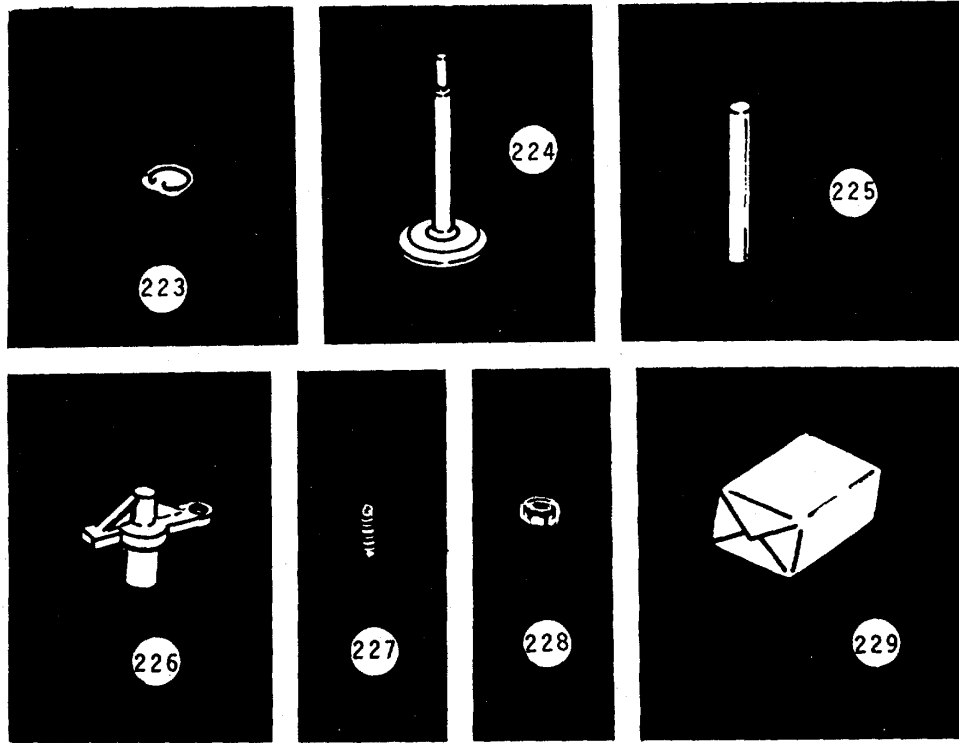

(1) ILLUS NO.	(2) NATIONAL STOCK NUMBER	(3) DESCRIPTION FSCM AND PART NUMBER	USABLE ON CODE	(4) U/M	(5) QTY RQR
223	5365-00-282-5031	Retainer, Push Rod (72582) 5150303		EA	8
224	2815-00-842-0859	Valve, Exhaust (72582) 5195167		EA	16
225	5360-01-893-3295	Spring, Exhaust Valve (72582) 5147347		EA	16
226	2815-00-731-4335	Bridge, Exhaust Valve (72582) 5117565		EA	2
227	2815-00-884-4803	Screw, Exhaust Valve Bridge Adjusting (72582) 5129101		EA	4
228	5310-00-270-7111	Nut, Exhaust Valve Bridge Screw Lock (72582) 5151601		EA	4
229	2910-00-808-2655	Overhaul Kit, Fuel Pump (72582) 5199561		EA	2

SECTION III. BASIC ISSUE ITEMS LIST (CONTINUED).

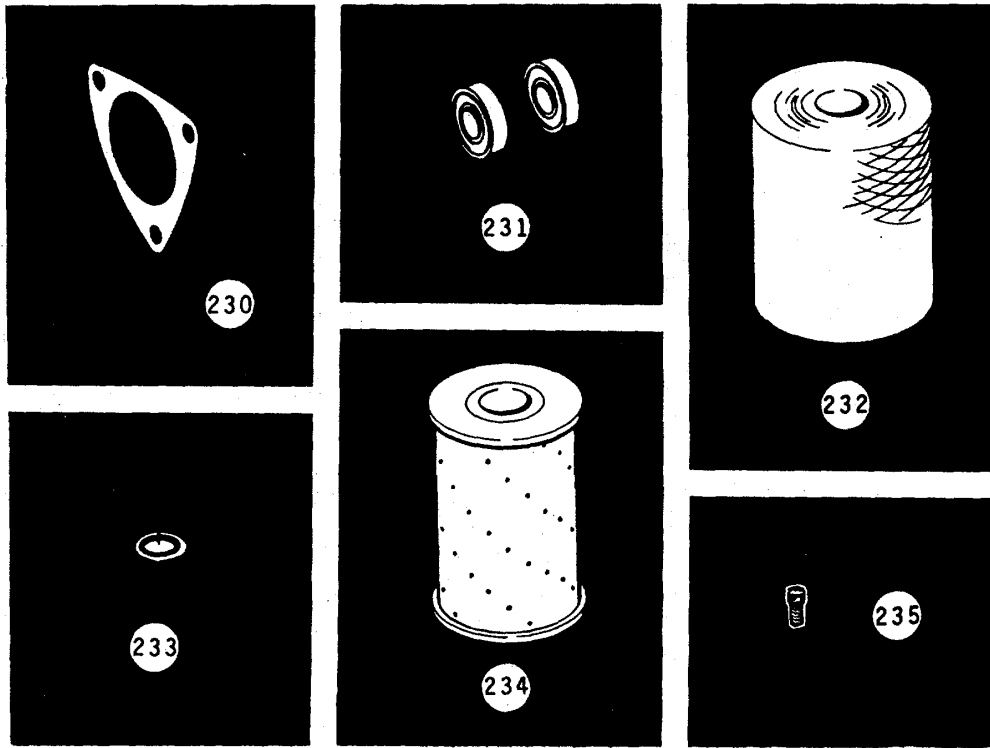

(1) ILLUS NO.	(2) NATIONAL STOCK NUMBER	(3) DESCRIPTION FSCM AND PART NUMBER	(4) USABLE ON CODE U/M	(5) QTY RQR
231	5330-00-178-3773	Seal, Oil, Fuel Pump (72582) 5230007	EA	2
232	2910-00-792-8985	Element, Fuel Strainer (72582) 5574961	EA	2
233	5330-00-930-3244	Gasket, Fuel Strainer Cover Screws (72582) 6435794	EA	6
234	2910-00-890-2436	Element, Fuel Filter (72582) 5573261	EA	2
235	5305-00-272-2080	Screw, Injector Control Tube Rack Lever (72582) 5176228	EA	10

SECTION III. BASIC ISSUE ITEMS LIST (CONTINUED).

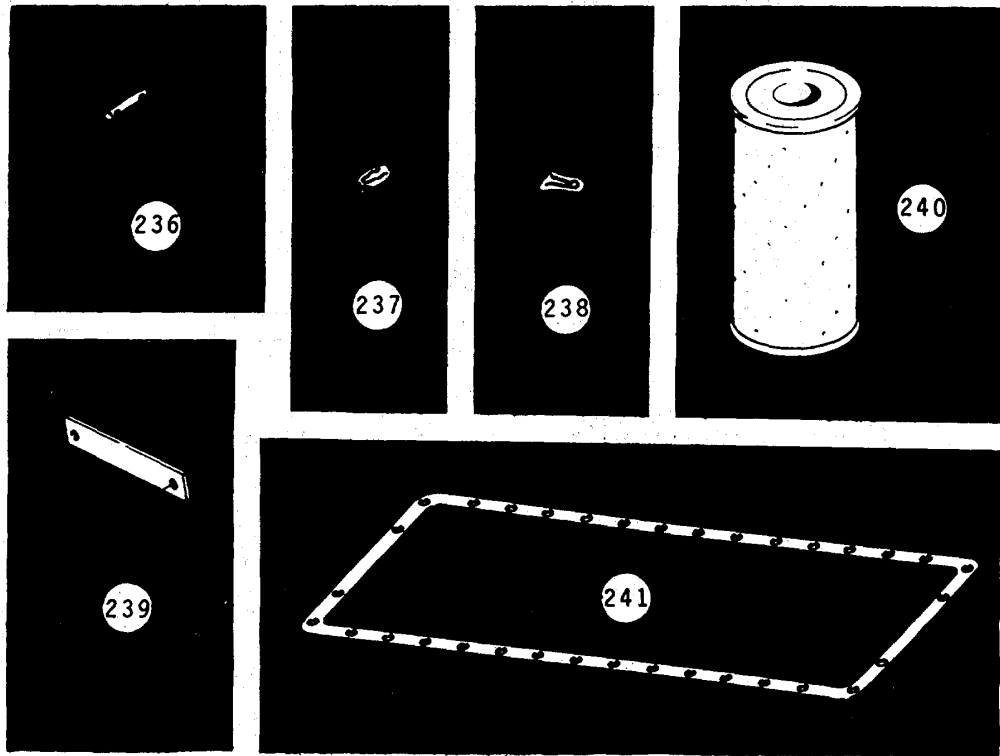

(1) ILLUS NO.	(2) NATIONAL STOCK NUMBER	(3) DESCRIPTION FSCM AND PART NUMBER USABLE ON CODE	(4) U/M	(5) QTY RQR
236	5315-01-027-4955	Pin, Injector Control Tube to Gov Link (72582) 5147345	EA	4
237	5340-00-814-2583	Retainer, Injector Control Tube to Gov. link (72582) 142583	EA	4
238	5315-00-839-2325	Pin, Cotter (72582) 103361	EA	4
239	5365-00-597-7348	Shim, Oil, Pump, .003 (72582) 5176119	EA	4
240	2940-00-141-9026	Element, Lube Oil Filter By-Pass (72582) 5572425	EA	20
241	5330-00-383-8661	Gasket, Oil Pan (4 cyl) (72582) 5150116	EA	2

SECTION III. BASIC ISSUE ITEMS LIST (CONTINUED).

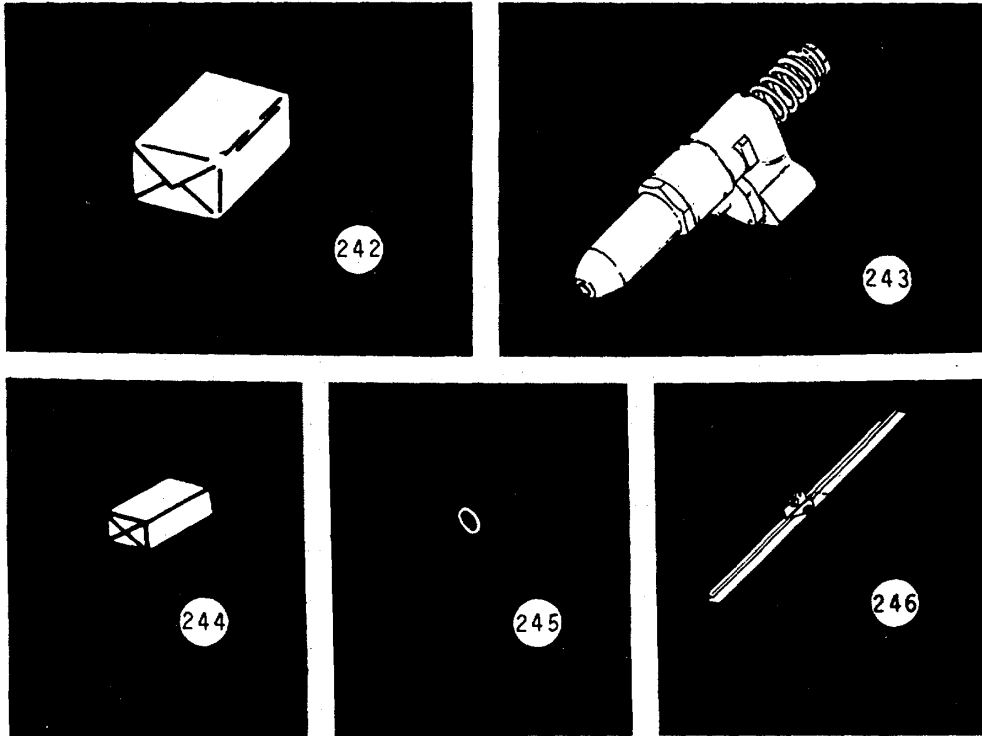

(1) ILLUS NO.	(2) NATIONAL STOCK NUMBER	(3) DESCRIPTION FSCM AND PART NUMBER	(4) USABLE ON CODE U/M	(5) QTY RQR
242	2930-00-986-4068	Reconditioning Kit, (FW) Pump (Std with Carbon Seal) (72582) 5198307 The following one item is u/o Singer-Kearfott Windshield Wiper:	EA	2
243	2910-00-039-2370	Injector, Fuel (72582) 5228900	EA	4
244	2930-00-025-6743	Replacement Kit (T2582) 5193605 FW Pump:	EA	2
245	5330-00-599-2027	Packing, FW Pump Outlet (72582) 5150191	EA	2
246	2090-00-708-2022	Blade, Wiper (81100) N56-14	EA	2

SECTION III. BASIC ISSUE ITEMS LIST (CONTINUED).

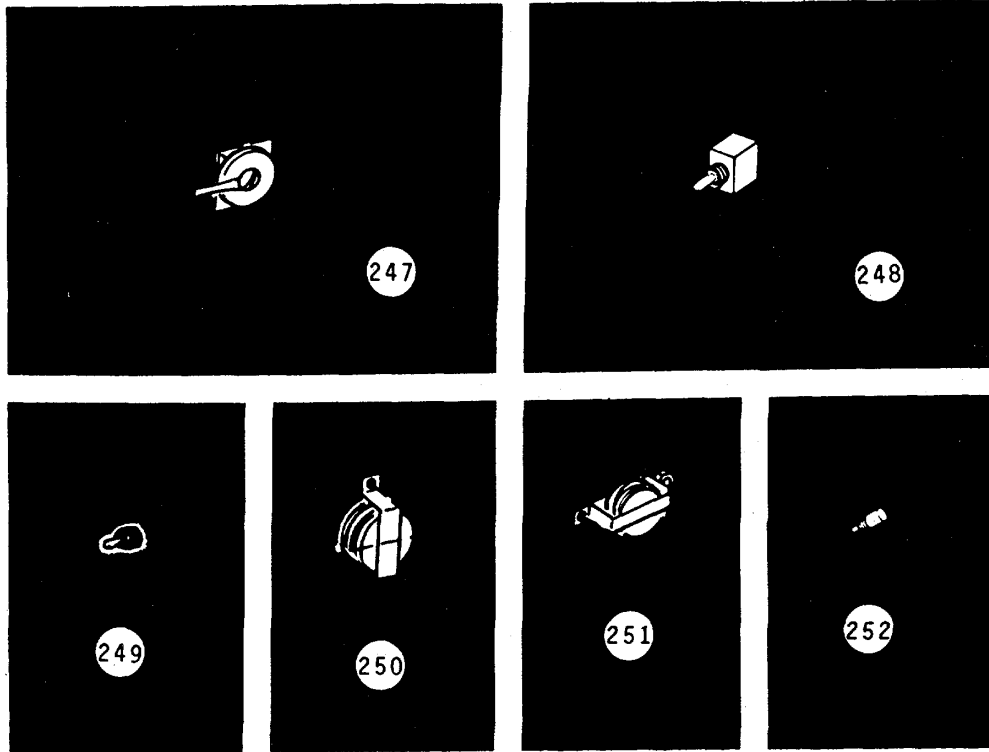

(1) ILLUS NO.	(2) NATIONAL STOCK NUMBER	(3) DESCRIPTION FSCM AND PART NUMBER USABLE ON CODE	(4) U/M	(5) QTY RQR
		The following 10 items are u/o Audio Equipped Tabet Mfr Co. Portable Electric Megaphones:		
247	5905-00-294-9097	Thermistor Assy (83186) A-815	EA	1
248	5930-00-552-9877	Switch, SPDT (40931) V3-32	EA	1
249	5930-00-556-9217	Switch (91929) 6AT-1	EA	1
250	5950-01-039-7146	Transformer, Input (89829) 1T-1079	EA	1
251	5950-00-733-2823	Transformer, Driver (88829) DT 1080	EA	1
252	5830-01-039-7259	Control, Volume (88829) VR-5	EA	1

SECTION III. BASIC ISSUE ITEMS LIST (CONTINUED).

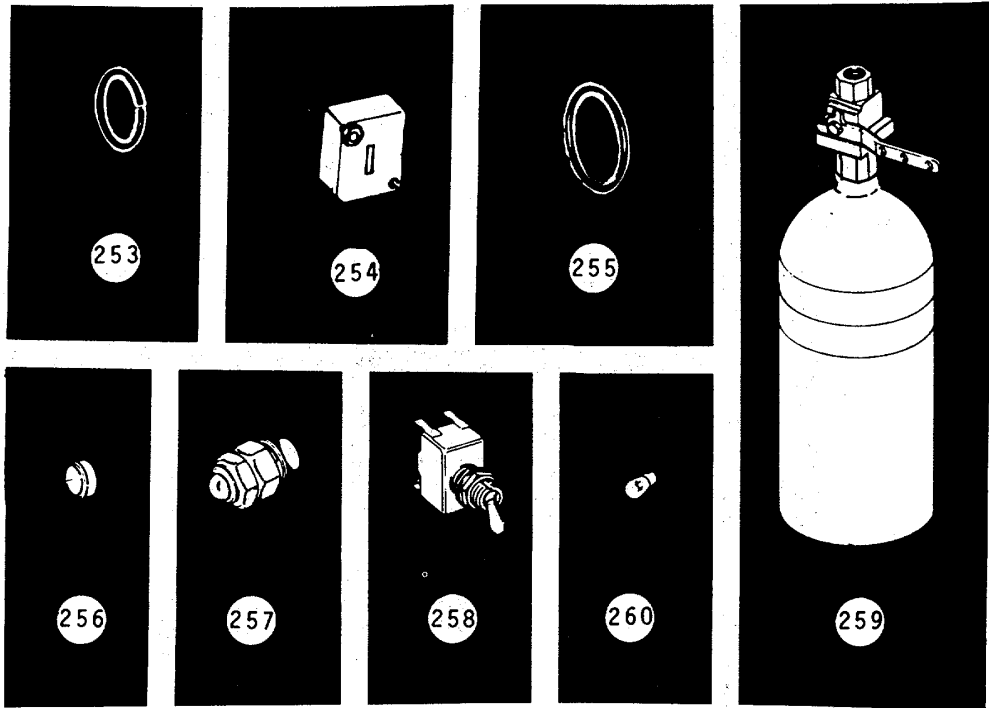

(1) ILLUS NO.	(2) NATIONAL STOCK NUMBER	(3) DESCRIPTION FSCM AND PART NUMBER	(4) U/M	(5) QTY RQR
253	5330-00-194-3733	"0" Ring, Drive Unit (88044) AN-6230-18	EA	1
254	5935-00-885-8598	Socket, Transistor (71785) 14T24324	EA	1
255	5330-00-993-3792	"0" Ring, Cover (88044) AN-6230-15	EA	1
256	5965-01-039-9060	Element, Microphone (88829) T8	EA	1
		The following 6 items are u/o Protector Inc. Fire Detection and Extinguishing System:		
257	6350-00-263-0588	Detector, Flame (11941) 30-2013-5	EA	2
258	5950-00-655-1575	Switch, Toggle (96906) MS35059-22	EA	1
259	4210-01-040-7619	Cylinder and Valve Assembly	EA	2
260	6240-00-491-0530	Lamp, Incandescent (71744) 376-AS15	EA	10

SECTION III. BASIC ISSUE ITEMS LIST (CONTINUED).

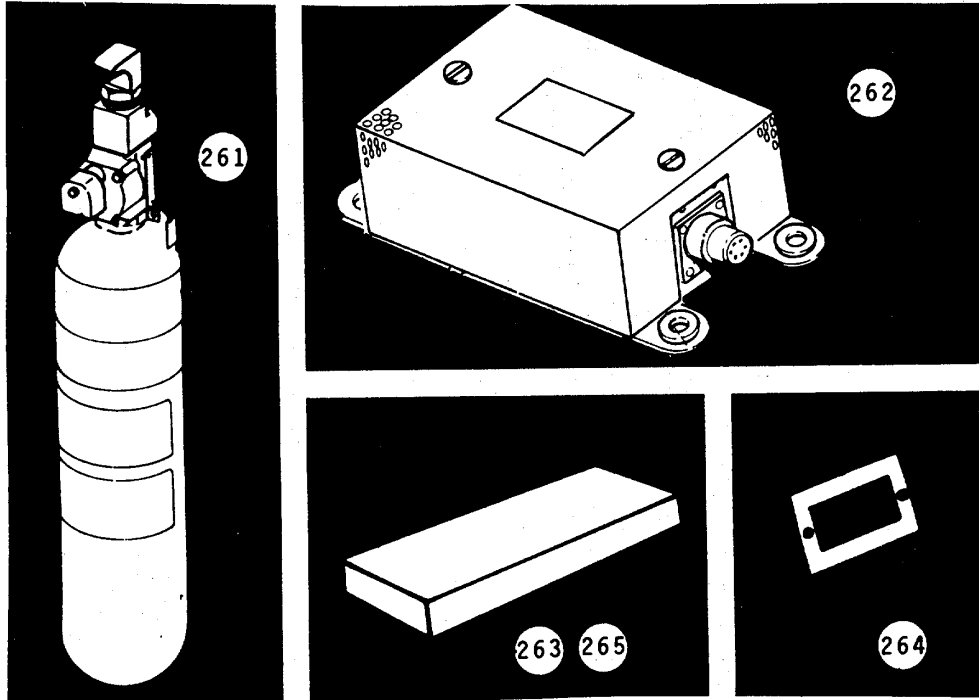

(1) ILLUS NO.	(2) NATIONAL STOCK NUMBER	(3) DESCRIPTION FSCM AND PART NUMBER	USABLE ON CODE	(4) U/M	(5) QTY RQR
261	4210-01-042-0268	Cylinder and Valve/Nozzle (11941) 30-295-87		EA	1
262	4210-01-040-5556	Detector, Smoke (11941) 30-231-11		EA	2
		The following 6 items are u/o Detroit Diesel Main Propulsion Engines (DDAD Model 7122-7000). Some of these parts may also be u/o the Anchor Winch Engine and Generator Engines (DDAD Models 1043-7000 and 1033-7005:			
263	5330-00-837-8327	Gasket Kit, Engine Overhaul (72582)		EA	1
264	5330-00-866-9401	Gasket, Hand Hole Cover Small (WBP) 72582 5132924		EA	12
265	2815-00-839-6203	Gasket Kit, Cylinder Head Overhaul (72582) 5196382		EA	1

SECTION III. BASIC ISSUE ITEMS LIST (CONTINUED).

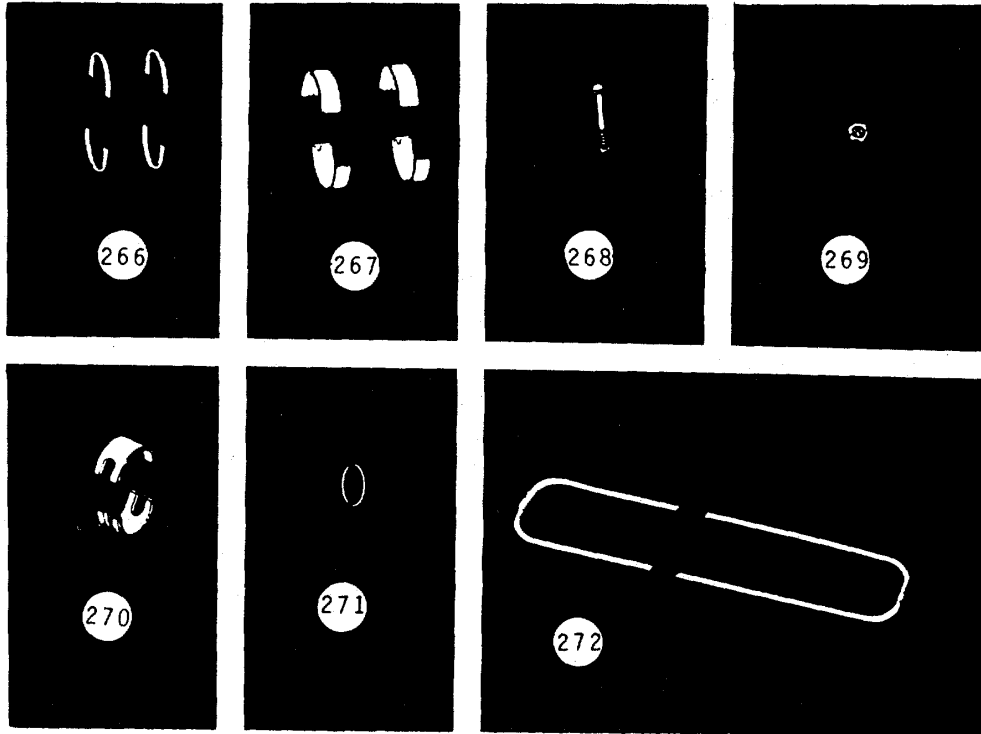

(1) ILLUS NO.	(2) NATIONAL STOCK NUMBER	(3) DESCRIPTION FSCM AND PART NUMBER USABLE ON CODE	(4) U/M	(5) QTY RQR
266	2815-00-735-4202	Washer, Thrust, Main Bearing (72582) 5196319	EA	1
267	3120-00-903-0786	Shell Set, Main Bearing (STD) (72582) 5196319	EA	7
268	5360-00-136-9989	Bolt, Con Rod (72582) 5132383	EA	4
269	5310-00-841-5700	Nut, Con Rod Bolt (72582) 5117629	EA	6
270	3120-01-084-5357	Shell Set, Con Rod Bearing (STD) (72582) 5199946	EA	12
271	5330-00-792-9849	Seal, Oil, Camshaft (72582) 5116476	EA	2
272	5330-00-471-5618	Gasket, Rocker Cover (72582) 5143407	EA	2

SECTION III. BASIC ISSUE ITEMS LIST (CONTINUED).

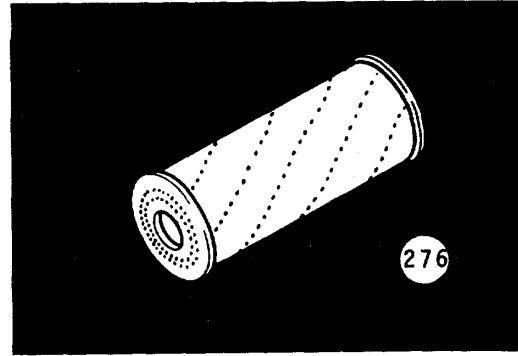
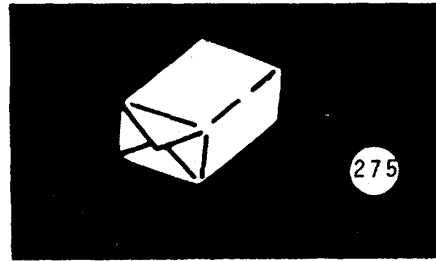
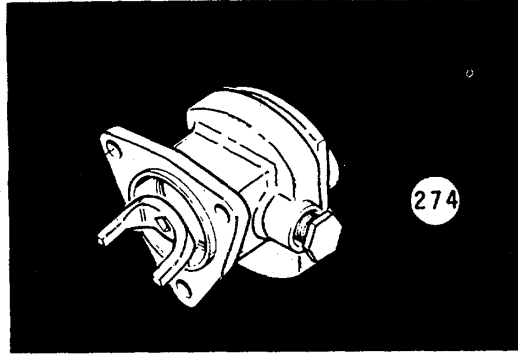
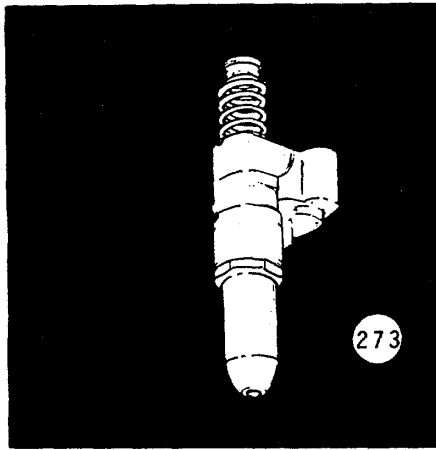

(1) ILLUS NO.	(2) NATIONAL STOCK NUMBER	(3) DESCRIPTION FSCM AND PART NUMBER	(4) USABLE ON CODE U/M	(5) QTY RQR
273	2910-00-911-0139	Injector, Fuel (72582) 5228770	EA	24
274	2910-01-024-9238	Pump, Fuel (72582) 5199735	EA	2
275	2910-00-880-0054	Overhead Kit, Fuel Pump (72582) 5196938	EA	2
276	2910-00-089-6012	Element, Fuel Filter (72582) 6436719	EA	12

SECTION III. BASIC ISSUE ITEMS LIST (CONTINUED).

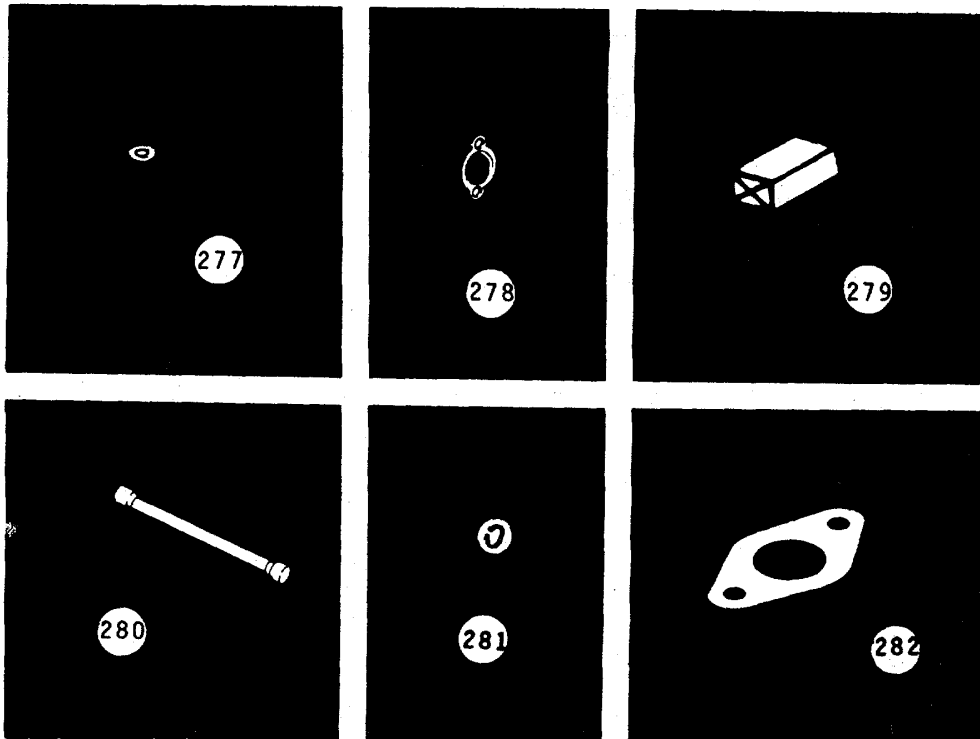

(1) ILLUS NO.	(2) NATIONAL STOCK NUMBER	(3) DESCRIPTION FSCM AND PART NUMBER	(4) USABLE ON CODE U/M	(5) QTY RQR
277	5330-00-930-3244	Gasket, Fuel Filter Cover Screw (72582) 6435794	EA	4
278	5330-00-250-5817	Gasket, Governor High Speed Spring Cover (72582) 5152944	EA	2
279	2815-00-837-8371	Installation Kit, Blower (72582) 5196386	EA	1
280	2990-01-009-8178	Shaft, Blower Drive (72582) 5148253	EA	1
281	5365-00-266-1963	Ring, Snap, Blower Drive Shaft (Ind) (72582) 5154637	EA	1
282	5330-00-735-4291	Gasket, Pressure Regulator (72582) 5117269	EA	1

SECTION III. BASIC ISSUE ITEMS LIST (CONTINUED).

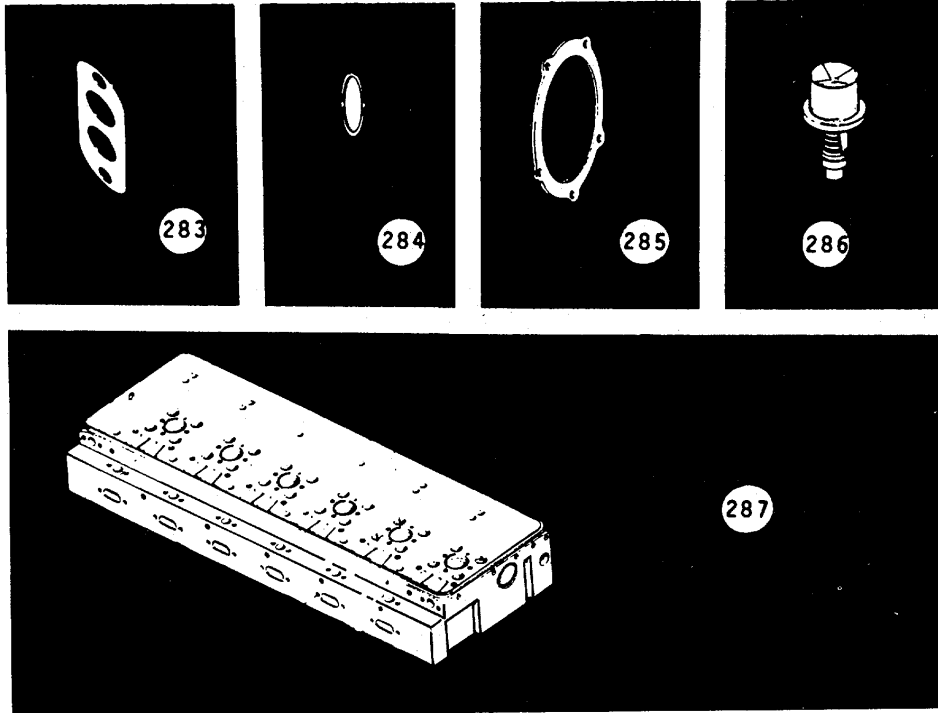

(1) ILLUS NO.	(2) NATIONAL STOCK NUMBER	(3) DESCRIPTION FSCM AND PART NUMBER	USABLE ON CODE	(4) U/M	(5) QTY RQR
283	5330-00-835-6131	Gasket, (FF) Filter Cover Screw (72582) 5117575		EA	4
284	5330-00-736-3508	Gasket, (FF) Filter By-Pass Valve (72582) 5575086		EA	1
285	5330-00-758-2868	Gasket, (FW) Pump Cover (72582) 5117976		EA	1
286	6620-00-846-9848	Thermostat Assembly (72582) 5119826		EA	2
287	2815-01-012-5834	Head, Cylinder Complete (72582) 5199717		EA	2

SECTION III. BASIC ISSUE ITEMS LIST (CONTINUED).

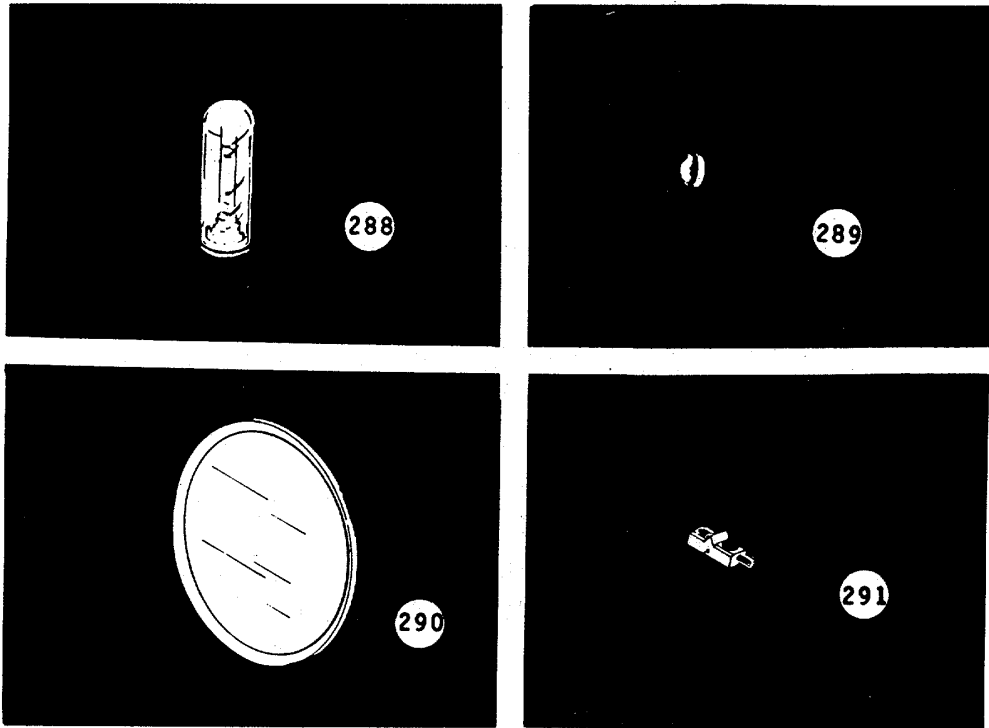

(1) ILLUS NO.	(2) NATIONAL STOCK NUMBER	(3) DESCRIPTION FSCM AND PART NUMBER	(4) USABLE ON CODE U/M	(5) QTY RQR
		The following 4 items are u/o Carlisle & Finch 12 in. Signaling Searchlight:		
288	6240-00-143-3142	Lamp, 1000W (96906) MS25015	EA	2
289	5360-00-619-3418	Spring, Shutter (10741) SP16-1	EA	1
290	6230-00-299-5902	Glass, Cover (10741) FE15F	EA	1
291	6250-00-785-6482	Lampholder (10741) FE 132X	EA	1

SECTION III. BASIC ISSUE ITEMS LIST (CONTINUED).

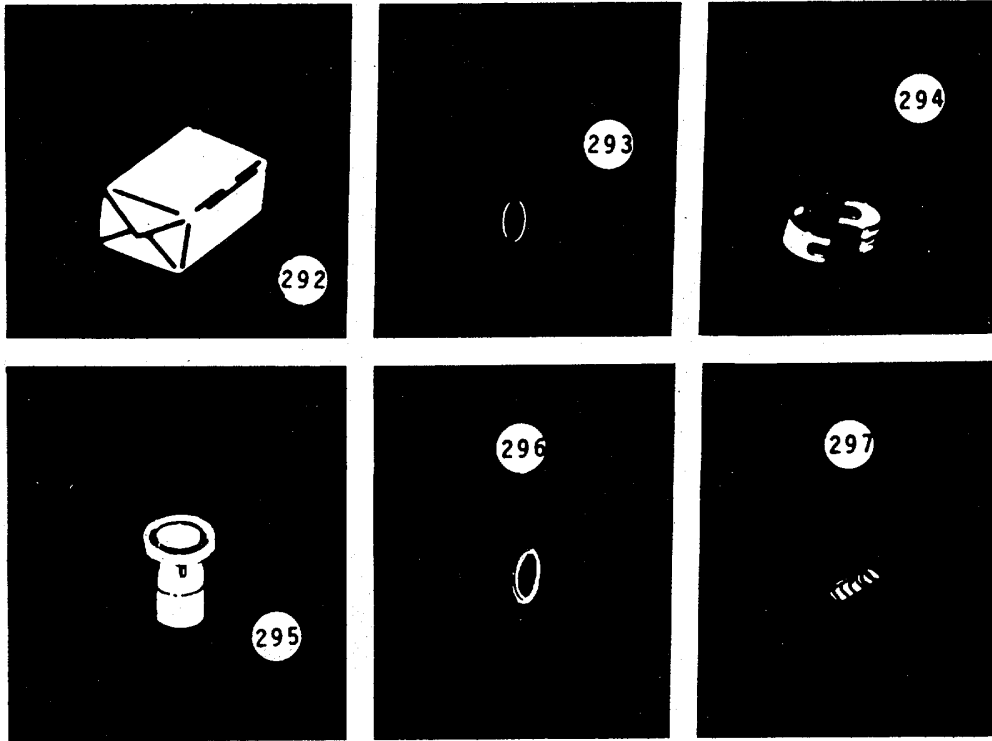

(1) ILLUS NO.	(2) NATIONAL STOCK NUMBER	(3) DESCRIPTION FSCM AND PART NUMBER USABLE ON CODE	(4) U/M	(5) QTY RQR
		The following 23 items are u/o Carrier-Transicold Air Conditioning Plant:		
292	5330-01-040-7867	Gasket Set (10855) 5F20660001	EA	1
293	4130-00-625-4955	Seal, Shaft (10855) 5F20-676	EA	1
294	3120-00-796-2600	Bearing Pkg, Con Rod (10855) 5F20-451	EA	3
295	4130-00-895-1693	Spring Discharge Valve.(10855) 6G45-1151	EA	12
296	4130-00-393-4901	Disc, Suction Valve (10855) SF20-1142	EA	3
297	5360-00-200-4445	Spring Suction (10855) 5F20-1791	EA	18

SECTION III. BASIC ISSUE ITEMS LIST (CONTINUED).

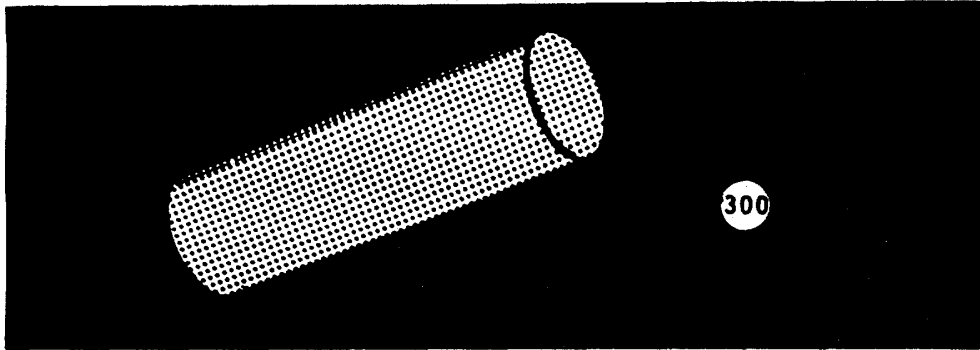
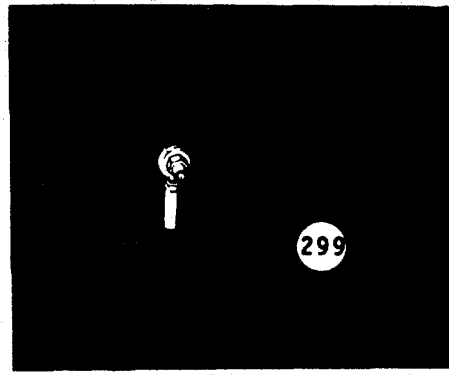
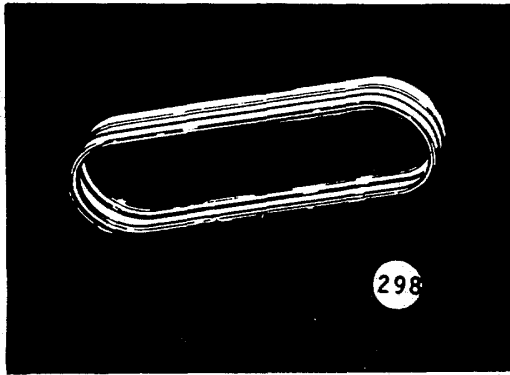

(1) ILLUS NO.	(2) NATIONAL STOCK NUMBER	(3) DESCRIPTION FSCM AND PART NUMBER USABLE ON CODE	(4) U/M	(5) QTY RQR
298	3030-01-040-8904	"V" Belt Pkg (10855) 5F20-A201	EA	1
299	4820-00-287-4045	Valve, Relief (28193) 5422	EA	2
300	4440-00-494-9427	Cartridge, Drier (28193) 73-C-AA	EA	1

SECTION III. BASIC ISSUE ITEMS LIST (CONTINUED).

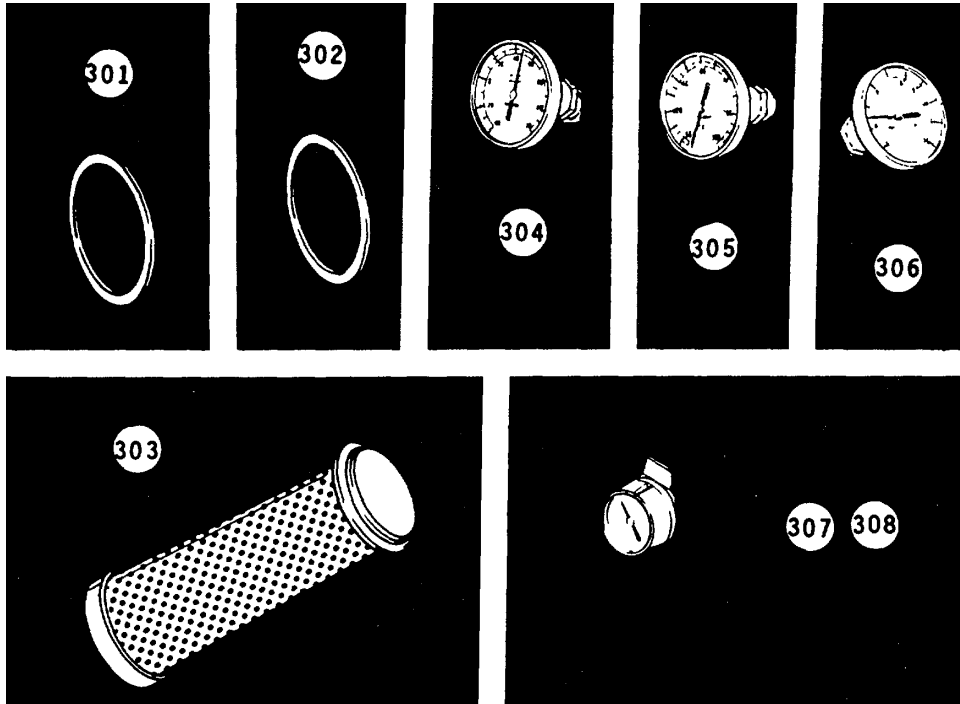

(1) ILLUS NO.	(2) NATIONAL STOCK NUMBER	(3) DESCRIPTION FSCM AND PART NUMBER	(4) U/M	(5) QTY RQR
301	5330-00-297-7369	Gasket, Flange, Drier (28193) U-203-4	EA	1
302	5330-00-297-6119	Gasket, Strainer (28193) U-201-4	EA	1
303	4730-00-202-8880	Cartridge, Strainer (10855) U-201-5A	EA	1
304	6685-01-044-0244	Thermometer, 3 inches 40°F 12°F (64467) 3A04	EA	2
305	6685-01-044-0245	Thermometer, 3 inches 50°F 300°F (64467) 3A04	EA	1
306		Thermometer, 3 inches 25°F to 125°F (64467) 3A04	EA	2
307	6685-01-044-0236	Gauge, Pressure (64467) BQ13-PFNS-RWXX	EA	1
308	6685-01-044-0237	Gauge, Pressure (64467) BQ13-POOS-RWXX	EA	1

SECTION III. BASIC ISSUE ITEMS LIST (CONTINUED).

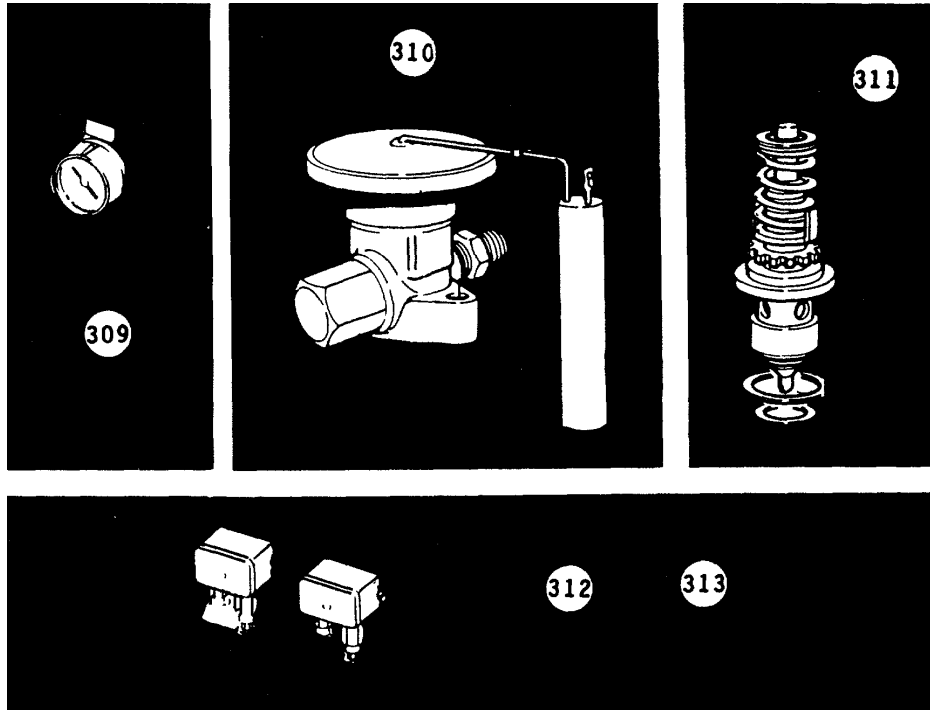

(1) ILLUS NO.	(2) NATIONAL STOCK NUMBER	(3) DESCRIPTION FSCM AND PART NUMBER	(4) USABLE ON CODE U/M	(5) QTY RQR
309	6685-01-044-0238	Gauge, Pressure (64467) BA13-PPFS-RWXX	EA	1
310	4820-01-041-9947	Power Assy, Thermal Expansion Valve (19278) XB1019FW552B	EA	1
311	4820-00-036-3755	Cage Assy, Thermal Expansion Valve (20418) XC724-B4B	EA	1
312		Switch, High Pressure (19278) 223876CB7	EA	1
313	5930-01-050-0535	Switch, Low Pressure (19278) 223875CB3	EA	2

SECTION III. BASIC ISSUE ITEMS LIST (CONTINUED).

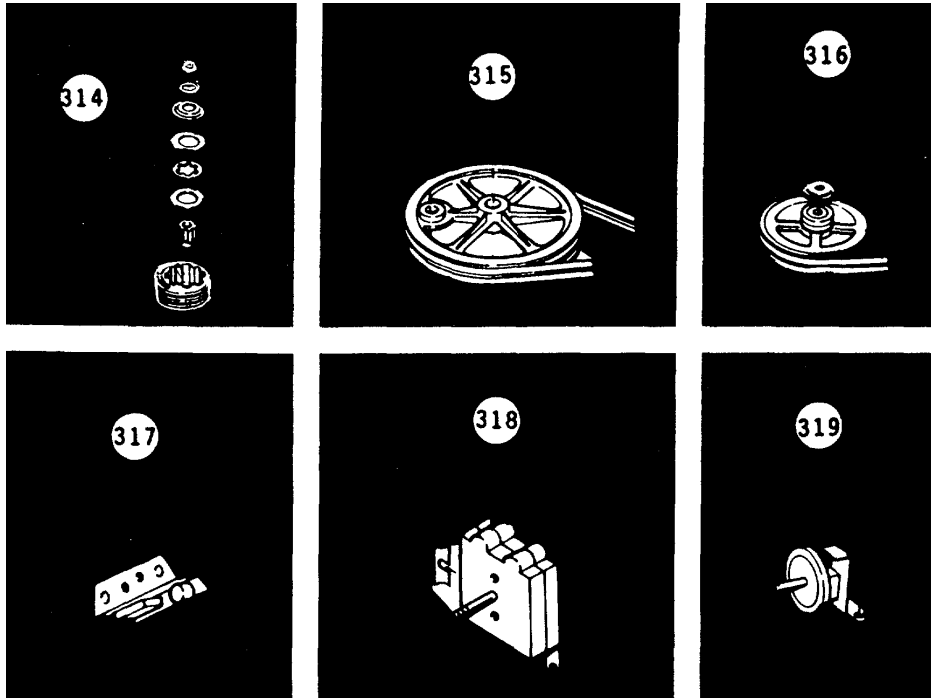

(1) ILLUS NO.	(2) NATIONAL STOCK NUMBER	(3) DESCRIPTION FSCM AND PART NUMBER	(4) USABLE ON CODE U/M	(5) QTY RQR
		The following 14 items are u/o Frigidaire Washer/Dryer:		
314	3510-01-043-8550	Clutch (23671) 635147	EA	1
315	3030-01-042-0255	Belt Set (23671) 634913	EA	4
316	3030-01-037-4934	Belt Set (23671) 634914	EA	4
317	6645-01-068-3042	Timer, Washer (23671) 636442	EA	1
318	5930-01-043-4390	Switch, Water Temp (23671) 633640	EA	1
319	3510-01-019-0591	Water Level (23671) 634964	EA	1

SECTION III. BASIC ISSUE ITEMS LIST (CONTINUED).

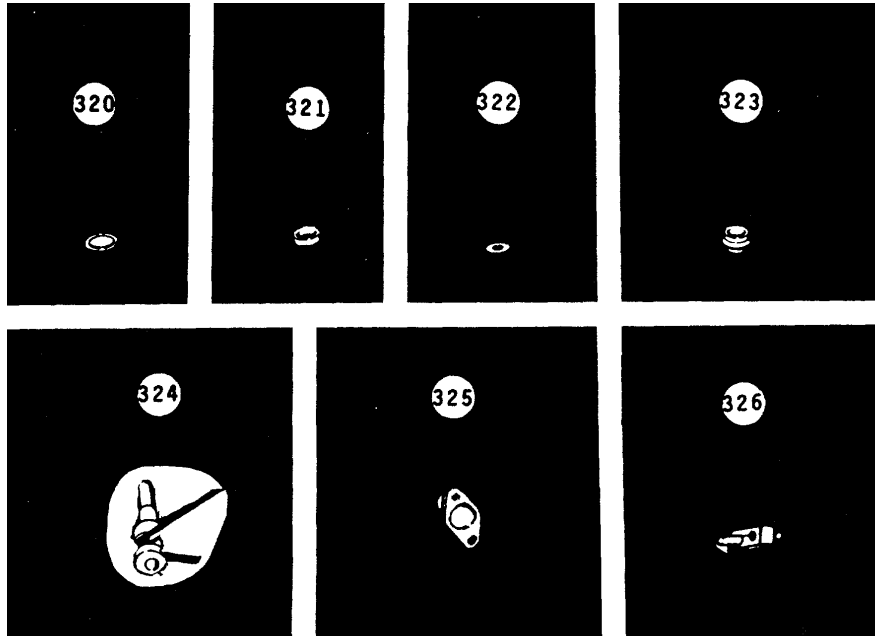

(1) ILLUS NO.	(2) NATIONAL STOCK NUMBER	(3) DESCRIPTION FSCM AND PART NUMBER	(4) USABLE ON CODE U/M	(5) QTY RQR
320	5330-01-040-3919	Gasket (23671) 1126048	EA	1
321	5330-01-020-5716	Gasket (23671) 6598955	EA	1
322	5330-01-020-5717	Seal (23671) 1126013	EA	1
323	5330-01-020-5715	Seal (23671) 6599277	EA	1
324	3030-01-037-4934	Belt (23671) 639357	EA	1
325	5920-01-037-5869	Thermostat (23671) 633927	EA	4
326	5930-01-043-5894	Selector, Dryer (23671) 633962	EA	1

SECTION III. BASIC ISSUE ITEMS LIST (CONTINUED).

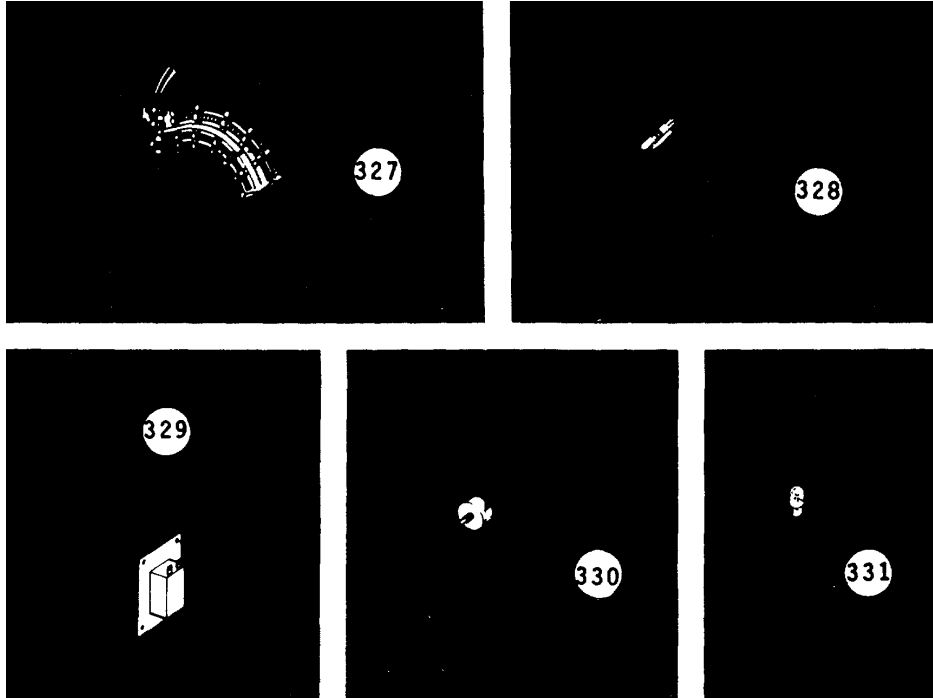

(1) ILLUS NO.	(2) NATIONAL STOCK NUMBER	(3) DESCRIPTION FSCM AND PART NUMBER USABLE ON CODE	(4) U/M	(5) QTY RQR
327	3510-01-019-0592	Element, 3000W, 240V (23671) 633897 The following 4 items are u/o Wing Corp's Alarm Switchboard:	EA	1
328	5905-00-454-2818	Resistor, Fixed 0.75 Megohms, 2W RCR 32GTE4JS	EA	1
329	5945-00-925-4360	Relay (77342) SP11A120V	EA	1
330	5930-00-222-5984	Switch, Rotary (71590) PA600-397	EA	1
331	6240-00-179-1814	Lamp, Neon (96906) MS15098-5-002	EA	2

SECTION III. BASIC ISSUE ITEMS LIST (CONTINUED).

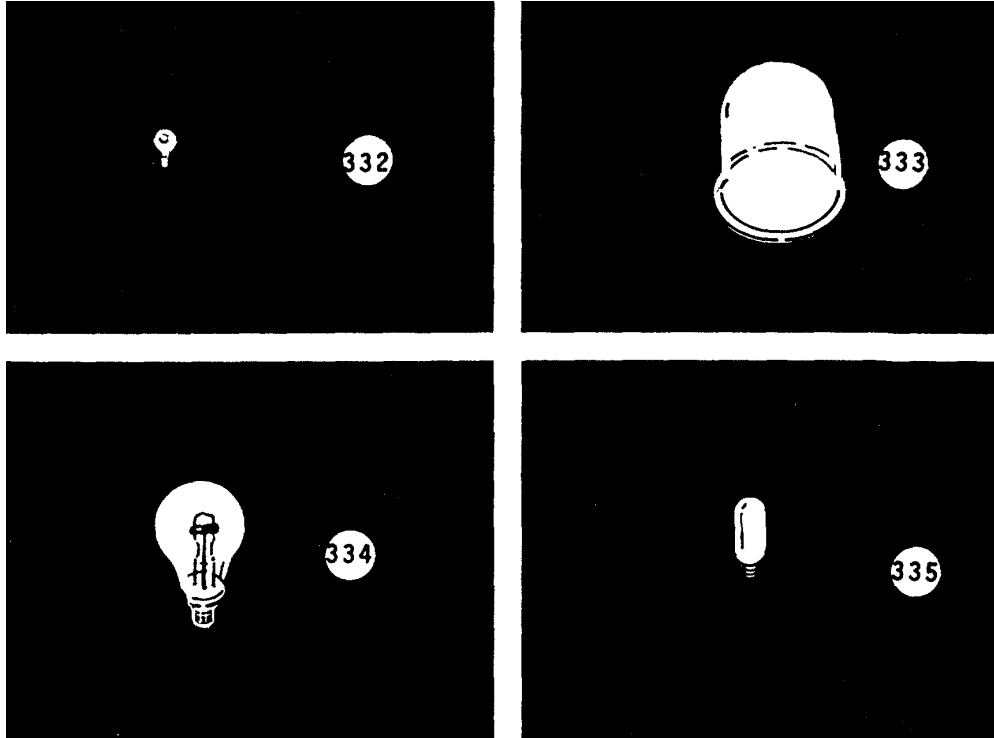

(1) ILLUS NO.	(2) NATIONAL STOCK NUMBER	(3) DESCRIPTION FSCM AND PART NUMBER USABLE ON CODE	(4) U/M	(5) QTY RQR
332	6240-00-939-7859	The following 1 item is u/o Sperry Marine Systems Ship's Course Indicator: Lamp, Incandescent (58854) 120MB	EA	2
333	6220-00-722-4496	The following 2 items are u/o Anchor Light, Symbol 161.3: Globe (96906) MS16867-1	EA	2
334	6240-00-155-8634	Lamp (96906) MS15586-1	EA	1
335	6240-00-617-1717	The following 1 item is u/o Task Light, Symbol 192.1: Lamp (96906) MS15574-1	EA	2

SECTION III. BASIC ISSUE ITEMS LIST (CONTINUED).

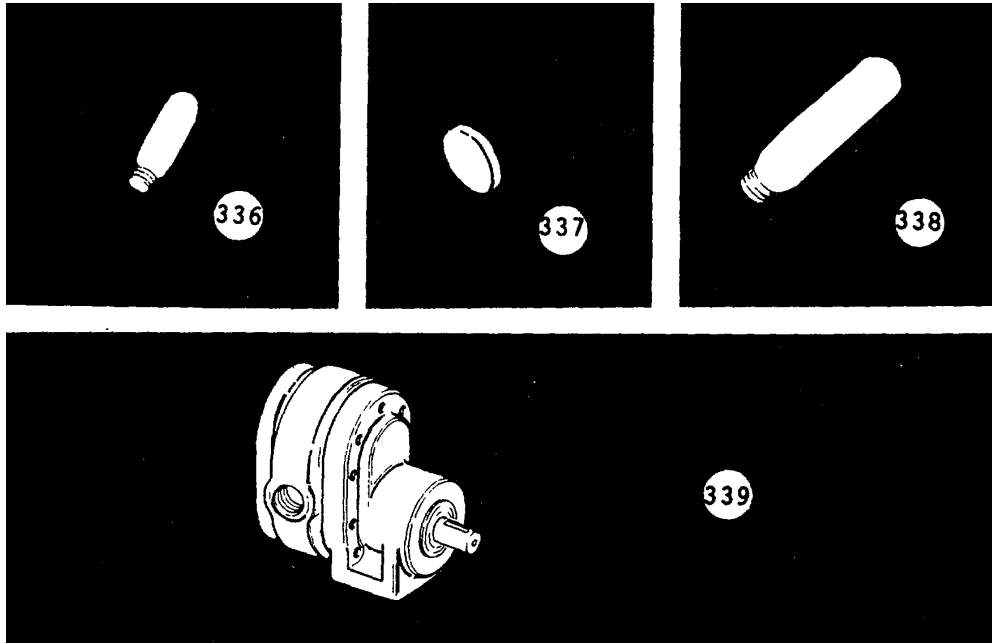

(1) ILLUS NO.	(2) NATIONAL STOCK NUMBER	(3) DESCRIPTION FSCM AND PART NUMBER	USABLE ON CODE	(4) U/M	(5) QTY RQR
336	6240-00-243-8331	Lamp (24446) 15T7C120 MOD		EA	2
337 EA	6120-00-869-9042 1	Lens (96906) MS17780-6			
338 EA	6240-00-577-8455 2	Lamp (50/50T-12) (96906) MS15545-2			
339	4320-01-040-4624	Pump (13829) PD 311 BAEQ 20-4		EA	1

SECTION III. BASIC ISSUE ITEMS LIST (CONTINUED).

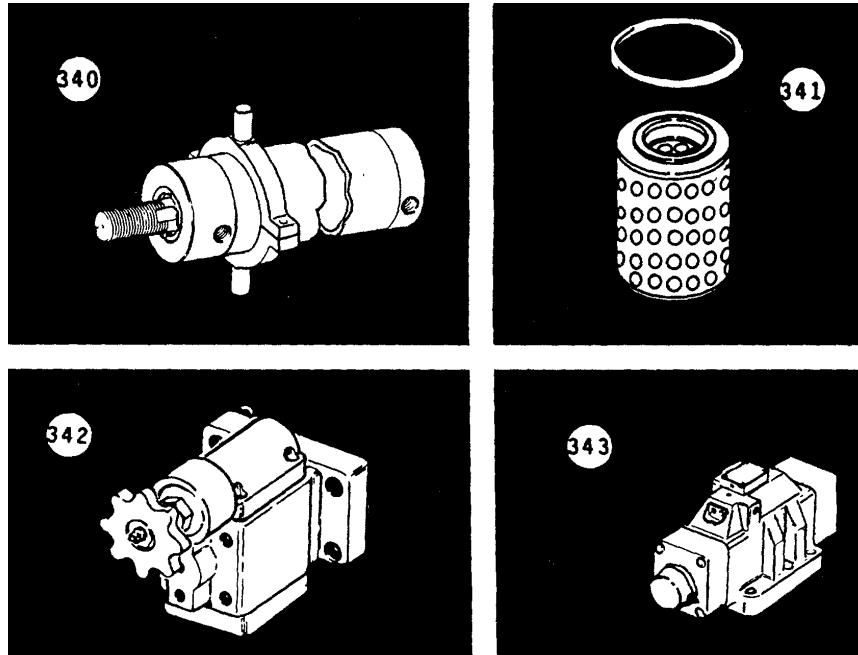

(1) ILLUS NO.	(2) NATIONAL STOCK NUMBER	(3) DESCRIPTION FSCM AND PART NUMBER	(4) USABLE ON CODE	(5) QTY RQR
340	4320-01-049-6450	Cylinder (60285) LSM-5-2	EA	1
341	4330-00-689-3307	Filter, Element (62983) 923117	EA	2
342	4820-00-533-0868	Valve, Pressure Reducing (62983) XGL-03-B-10	EA	1
343		Valve, 4-way (62983) DG3S-4-100A-50	EA	1

SECTION III. BASIC ISSUE ITEMS LIST (CONTINUED).

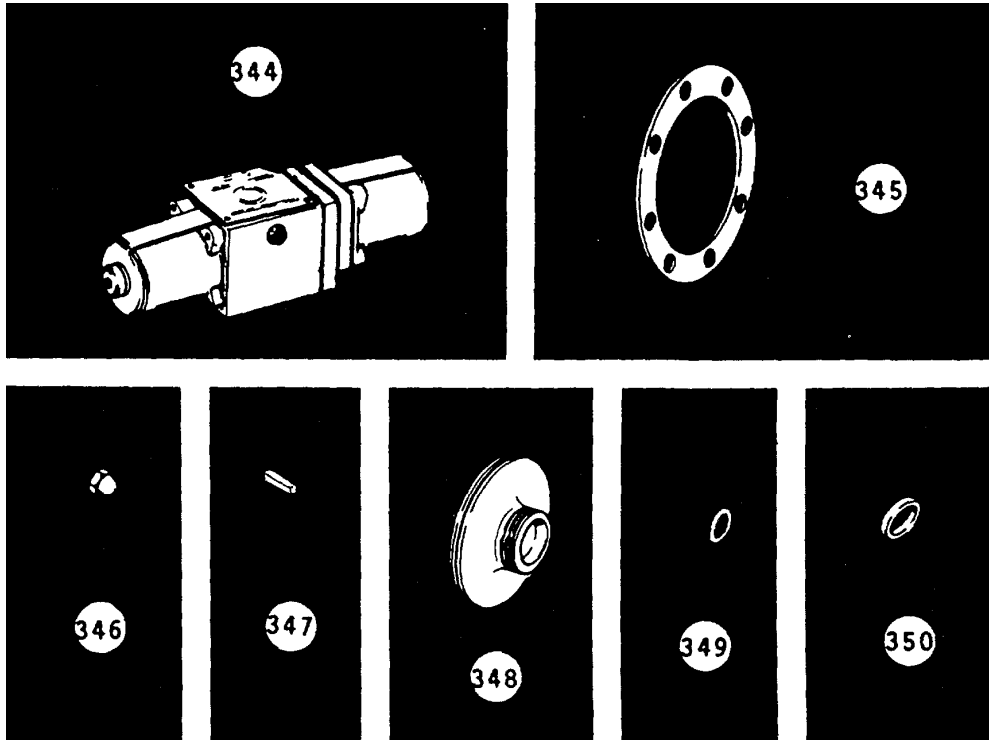

(1) ILLUS NO.	(2) NATIONAL STOCK NUMBER	(3) DESCRIPTION FSCM AND PART NUMBER USABLE ON CODE	(4) U/M	(5) QTY RQR
344 EA	4810-01-070-6823 1	Valve, 4-way (62983) DG454-016C-50 The following items are u/o the Air Conditioning Water Circulation Pump:		
345	5330-00-585-1587	Gasket, Suction Head 22098 (93232)	EA	1
346	4320-00-967-4748	Nut, Impellor 53618 (10131)	EA	1
347		Key, Impellor DN36 (10131)	EA	1
348		Impellor 22444RB (10131)	EA	1
349	5330-00-826-8959	Seal 22082 (93232)	EA	1
350	4320-00-646-7457	Rings, Packing 22094 (93232)	EA	5

SECTION III. BASIC ISSUE ITEMS LIST (CONTINUED).

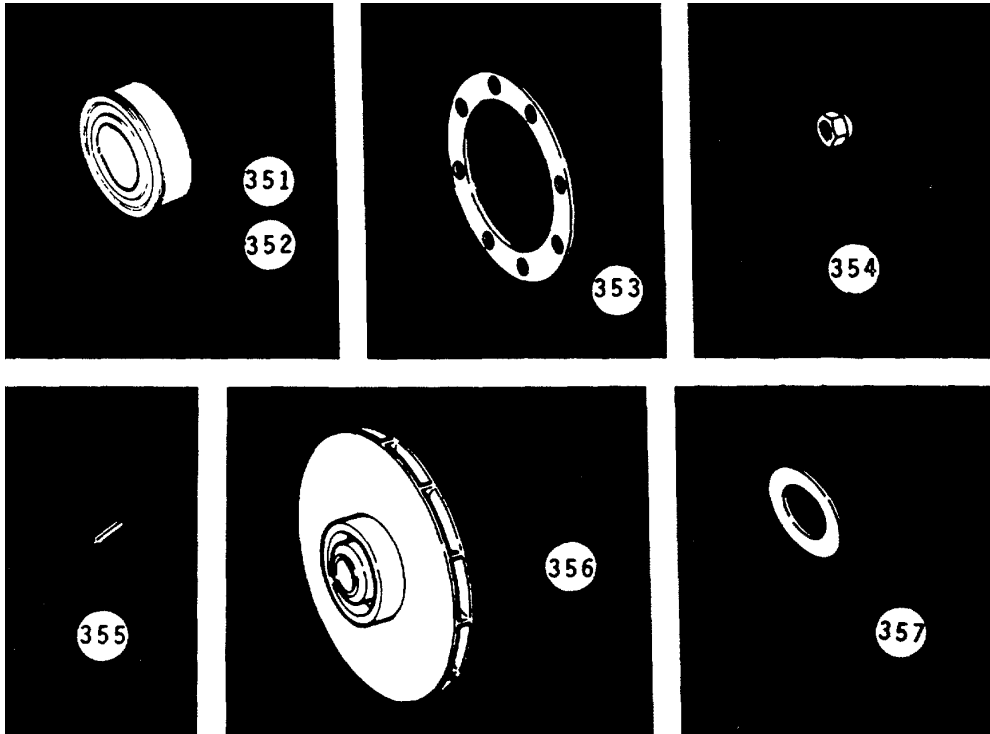

(1) ILLUS NO.	(2) NATIONAL STOCK NUMBER	(3) DESCRIPTION FSCM AND PART NUMBER	(4) USABLE ON CODE U/M	(5) QTY RQR
		The following items are u/o on the Air Conditioning Pump Motor:		
351	3110-00-972-0314	Bearing, Ball 405850-44-C (50380)	EA	1
352	3110-00-235-0521	Bearing, Ball 405850-90-E (50380)	EA	1
		The following items are u/o the Diesel Oil Cooling Pump:		
353	5330-00-239-4237	Gasket, Suction DNH-91 (93232)	EA	1
354		Nut, Impellor DNH-16 (10131)	EA	1
355		Key, Impellor DNH-36 (10131)	EA	1
356		Impellor DNH-4 (10131)	EA	1
357	5330-00-731-2848	Ring, Seal DNH-27 (93232)	EA	1

SECTION III. BASIC ISSUE ITEMS LIST (CONTINUED).

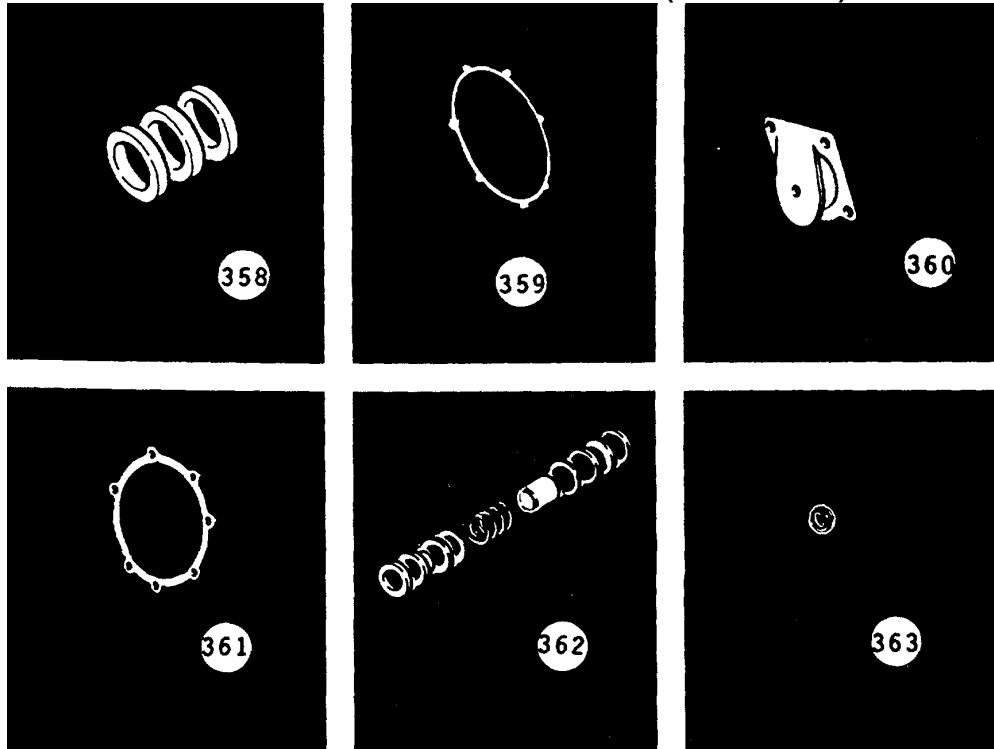

(1) ILLUS NO.	(2) NATIONAL STOCK NUMBER	(3) DESCRIPTION FSCM AND PART NUMBER	USABLE ON CODE	(4) U/M	(5) QTY RQR
358	5330-00-641-1639	Packing DNH-9 (93232) The following items are u/o the Sewage Pump:		EA	4
359	5330-00-232-8707	Gasket 12369-G (25567)		EA	1
360	4320-00-403-4725	Valve 1352-G (25567)		EA	1
361		Gasket 504G (25567)		EA	1
362	5330-00-353-5163	Seal Assembly GS-625 (25567)		EA	1
363	5365-00-361-7355	Shim 513-A (25567)		EA	1

SECTION III. BASIC ISSUE ITEMS LIST (CONTINUED).

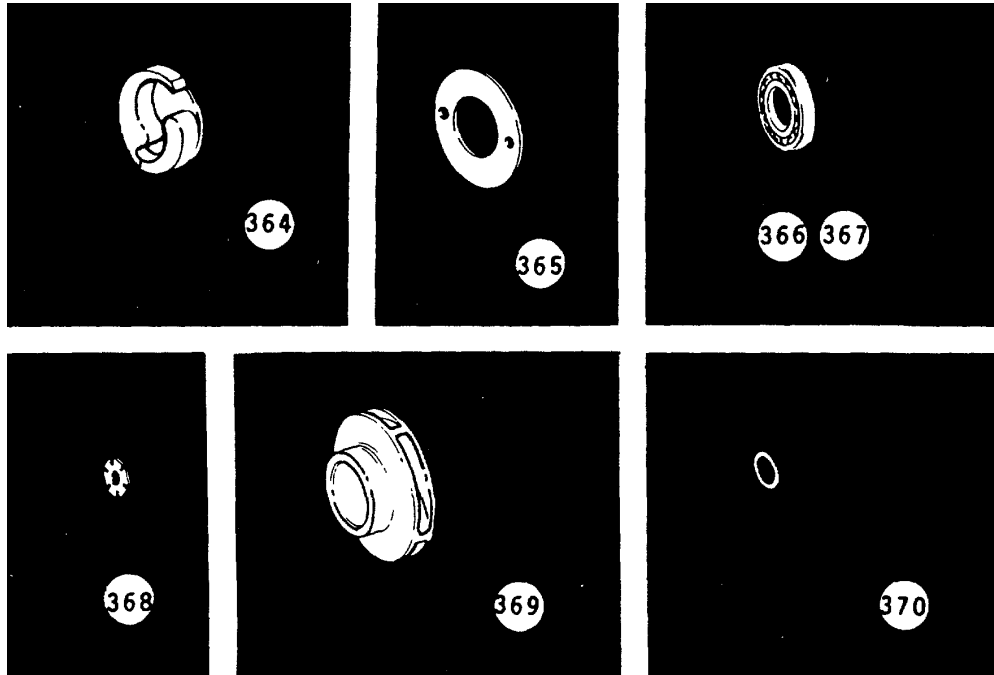

(1) ILLUS NO.	(2) NATIONAL STOCK NUMBER	(3) DESCRIPTION FSCM AND PART NUMBER	(4) USABLE ON CODE U/M	(5) QTY RQR
364		Impellor 12368-A (25567)	EA	1
365	4320-00-361-7347	Plate, Wear 2643 (25567)	EA	1
		The following items are u/o the Sewage Pump Motor:		
366	3110-00-145-2249	Bearing A7848817 (38151)	EA	1
367		Bearing A7848820 (38151)	EA	1
		The following items are u/o the Fire Pump:		
368		Washer 390035 (10131)	EA	1
369		Impellor 959379RB (10131)	EA	1
370		Gasket 389033 (10131)	EA	1

SECTION III. BASIC ISSUE ITEMS LIST (CONTINUED).

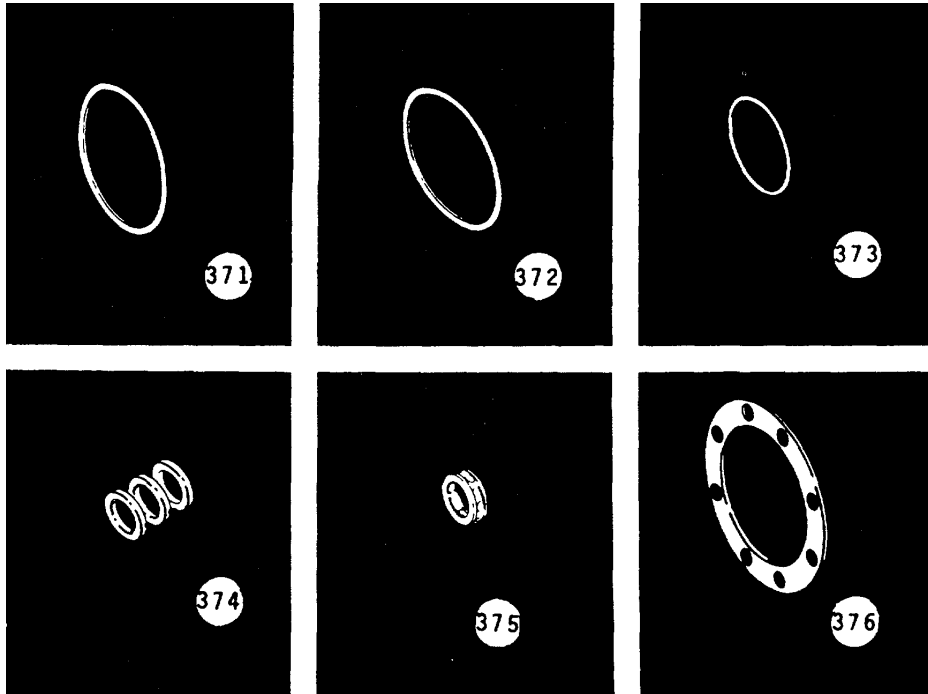

(1) ILLUS NO.	(2) NATIONAL STOCK NUMBER	(3) DESCRIPTION FSCM AND PART NUMBER	(4) USABLE ON CODE U/M	(5) QTY RQR
371		Gasket 390008-01 (10131)	EA	1
372		Gasket D1021-73A (10131)	EA	1
373		"O" Ring D1021-73B (10131)	EA	1
374		Packing P02066 (10131)	EA	1
375	4320-00-400-6731	Ring, Lantern 23617 (93232)	EA	1
376	5330-00-955-6656	The following items are u/o the Bilge Pump: Gasket 23613 (10131)	EA	2

SECTION III. BASIC ISSUE ITEMS LIST (CONTINUED).

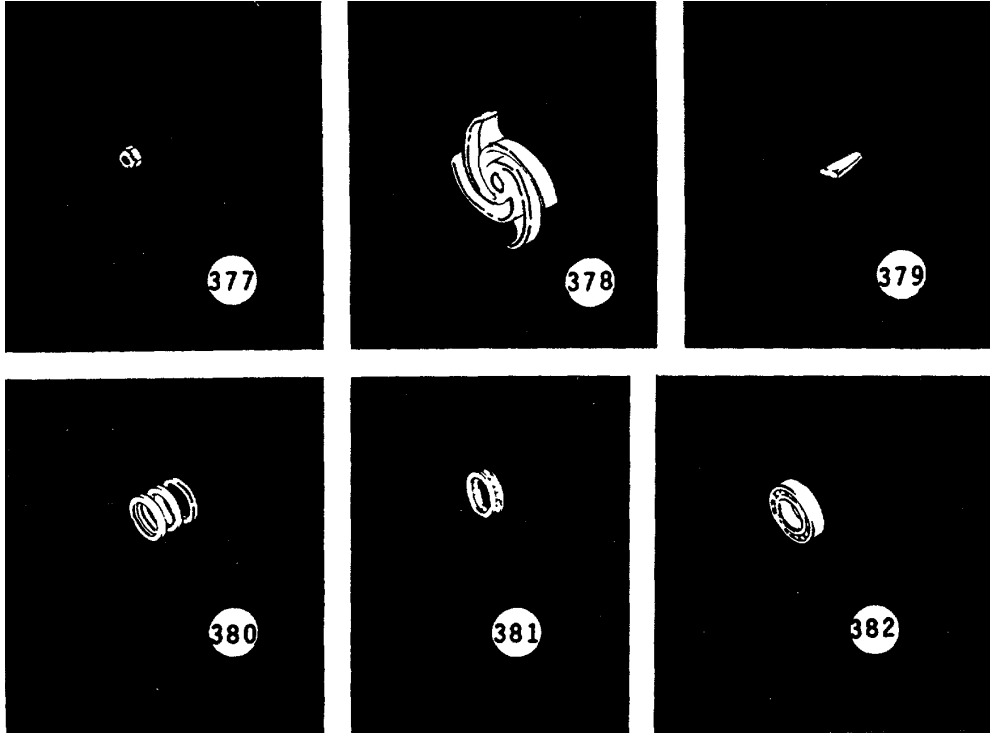

(1) ILLUS NO.	(2) NATIONAL STOCK NUMBER	(3) DESCRIPTION FSCM AND PART NUMBER	(4) USABLE ON CODE U/M	(5) QTY RQR
377	4320-00-913-1288	Nut 53618 (10131)	EA	1
378		Impellor 23147RA (10131)	EA	1
379	5315-00-257-6497	Key 51766 (93232)	EA	1
380		Ring 22094 (10131)	EA	5
381	5330-00-221-4607	Gauge, Seal 23616 (10131)	EA	1
382		Bearing 3207 (43334)	EA	1

SECTION III. BASIC ISSUE ITEMS LIST (CONTINUED).

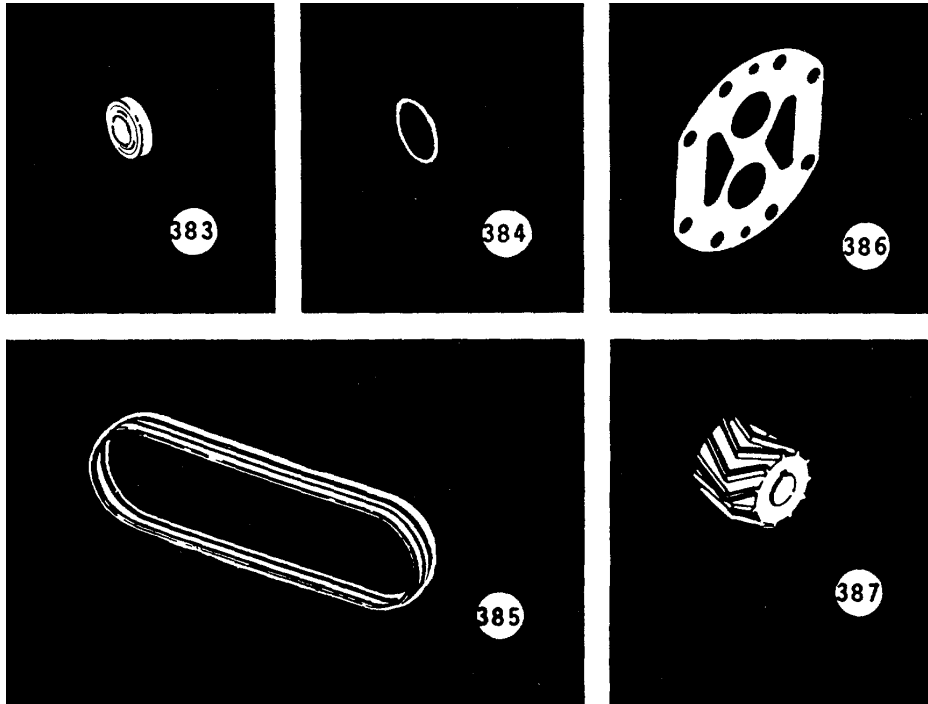

(1) ILLUS NO.	(2) NATIONAL STOCK NUMBER	(3) DESCRIPTION FSCM AND PART NUMBER	(4) USABLE ON CODE U/M	(5) QTY RQR
383	3110-00-554-3910	Bearing SKF6306NR (52676)	EA	1
384		Ring, Seal 23001 (10131)	EA	1
385	3030-00-529-0491	V-Belt Set A90 (73842)	EA	1
		The following items are u/o the Lube Oil Pump:		
386		Gasket 24258 (10131)	EA	2
387	4320-00-893-5301	Gear, Driven 24139 (93232)	EA	1

SECTION III. BASIC ISSUE ITEMS LIST (CONTINUED).

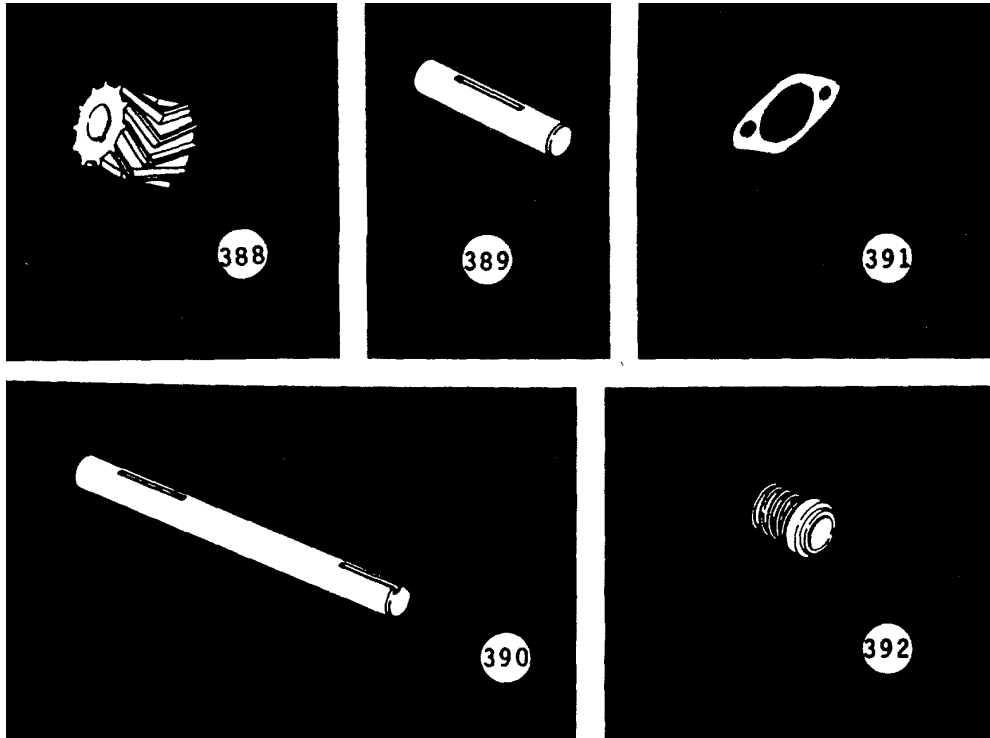

(1) ILLUS NO.	(2) NATIONAL STOCK NUMBER	(3) DESCRIPTION FSCM AND PART NUMBER	(4) USABLE ON CODE U/M	(5) QTY RQR
388	3020-00-893-5267	Gear, Driving 13534 (93232)	EA	1
389	4320-00-893-5308	Shaft, Driven 24231 (93232)	EA	1
390	4320-00-893-5305	Shaft, Driving 24209 (93232)	EA	1
391	5330-00-455-0311	Gasket 24262 (10131)	EA	1
392	4320-00-012-2479	Seal 24438 (93232)	EA	1

SECTION III. BASIC ISSUE ITEMS LIST (CONTINUED).

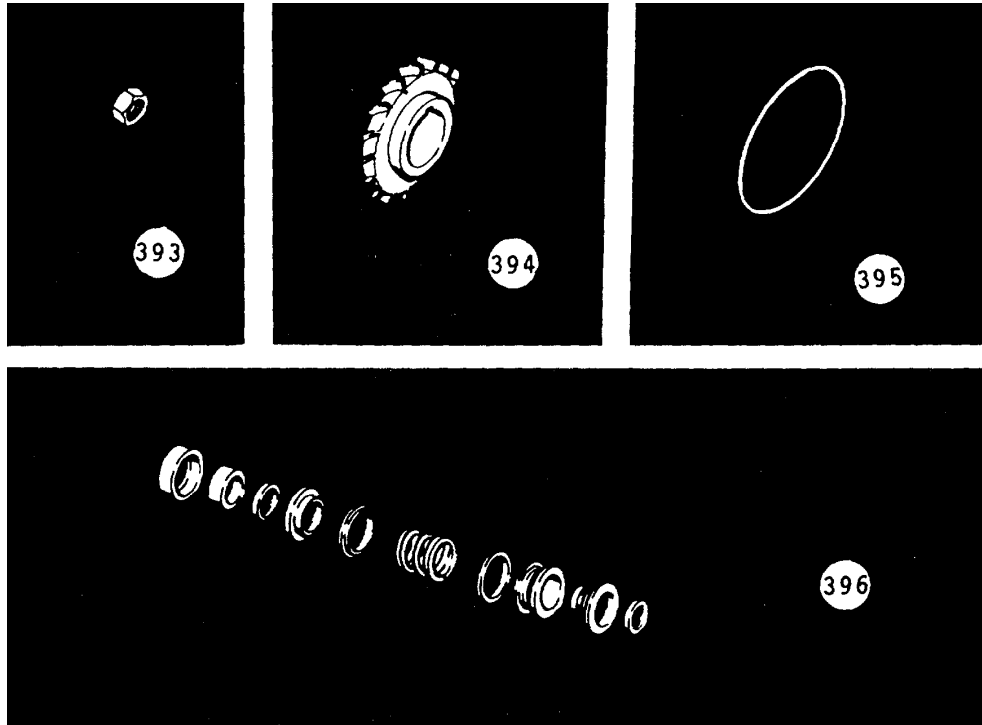

(1) ILLUS NO.	(2) NATIONAL STOCK NUMBER	(3) DESCRIPTION FSCM AND PART NUMBER	(4) USABLE ON CODE U/M	(5) QTY RQR
393		The following items are u/o the Fresh Water Pump: Nut, Impellor 50530 (10131)	EA	1
394		Impellor 51050 (10131)	EA	1
395	5330-00-067-3286	Packing 50718 (93232)	EA	2
396		Seal Assembly 43008 (10131)	EA	1

SECTION III. BASIC ISSUE ITEMS LIST (CONTINUED).

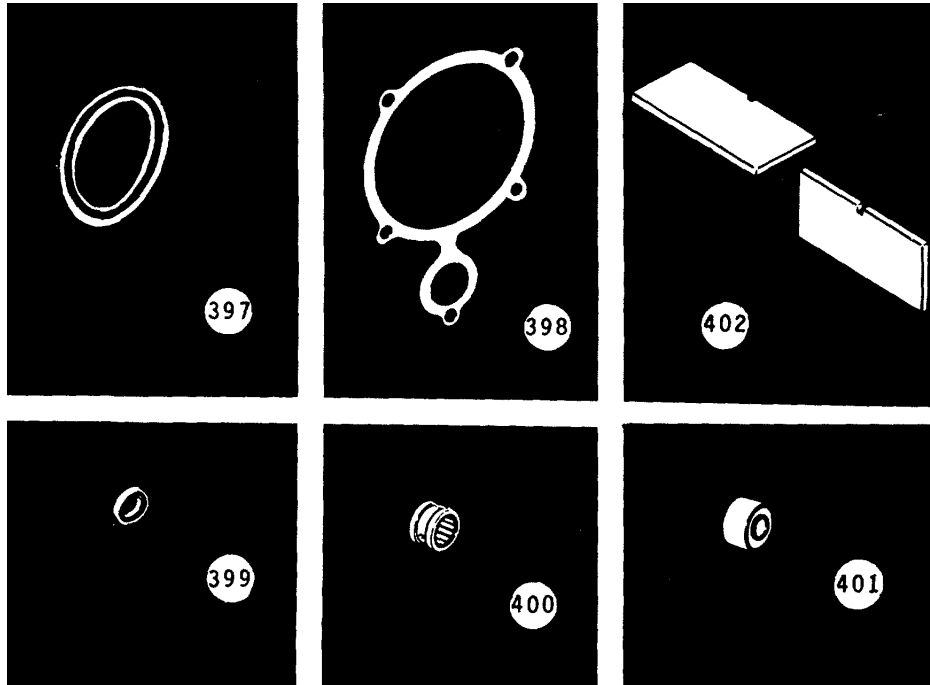

(1) ILLUS NO.	(2) NATIONAL STOCK NUMBER	(3) DESCRIPTION FSCM AND PART NUMBER	(4) USABLE ON CODE U/M	(5) QTY RQR
		The following items are u/o the GATX Sewage System:		
397		"O" Ring 1-31-11422 (19190)	EA	1
398		Gasket 1-31-11426 (19190)	EA	1
399	5330-00-641-2165	Seal L22005 (51034)	EA	1
400	3110-01-027-8813	Bearing L21001 (51034)	EA	1
401	3110-01-027-8815	Bearing L21006 (51034)	EA	1
402	4320-01-004-0759	Vane L06118 (51034)	EA	4

SECTION III. BASIC ISSUE ITEMS LIST (CONTINUED).

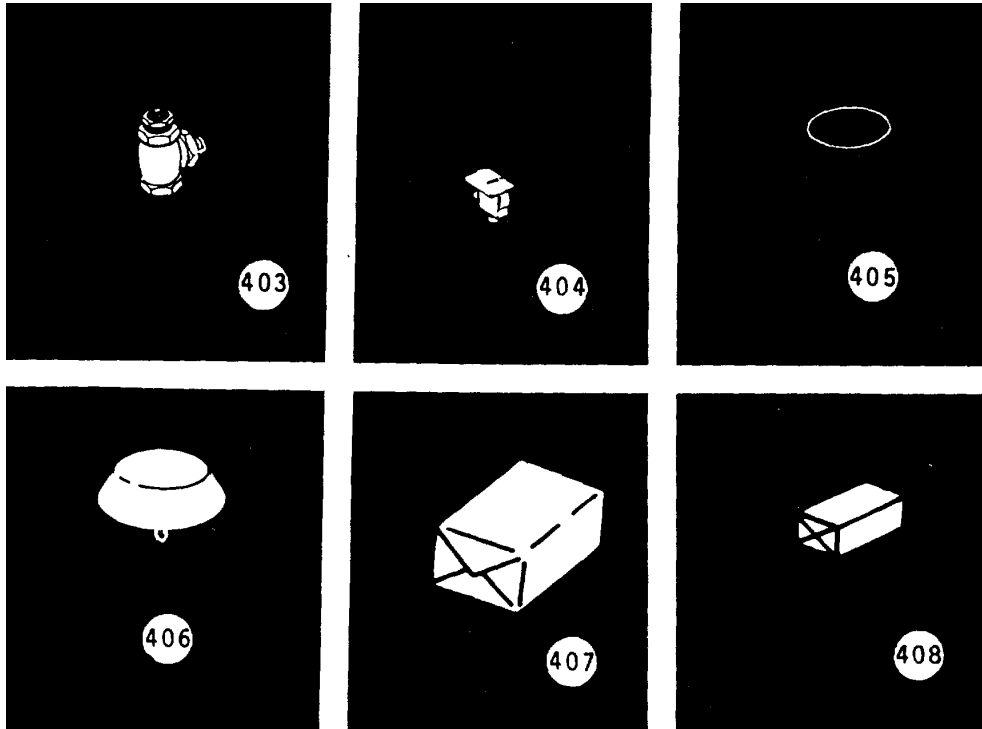

(1) ILLUS NO.	(2) NATIONAL STOCK NUMBER	(3) DESCRIPTION FSCM AND PART NUMBER	(4) USABLE ON CODE U/M	(5) QTY RQR
403		Switch, Flow 1-13-15229 (19190)	EA	1
404		Switch, Foot 1-13-13525 (19190)	EA	1
405		Gasket 1-13-10733 (19190)	EA	1
406		Stopper 2-33-10648 (19190)	EA	1
407		Kit, Vacuum 2-28-14938-16 (12201)	EA	1
408		Kit, Piston 2-28-14942-6 (12201)	EA	1

SECTION III. BASIC ISSUE ITEMS LIST (CONTINUED).

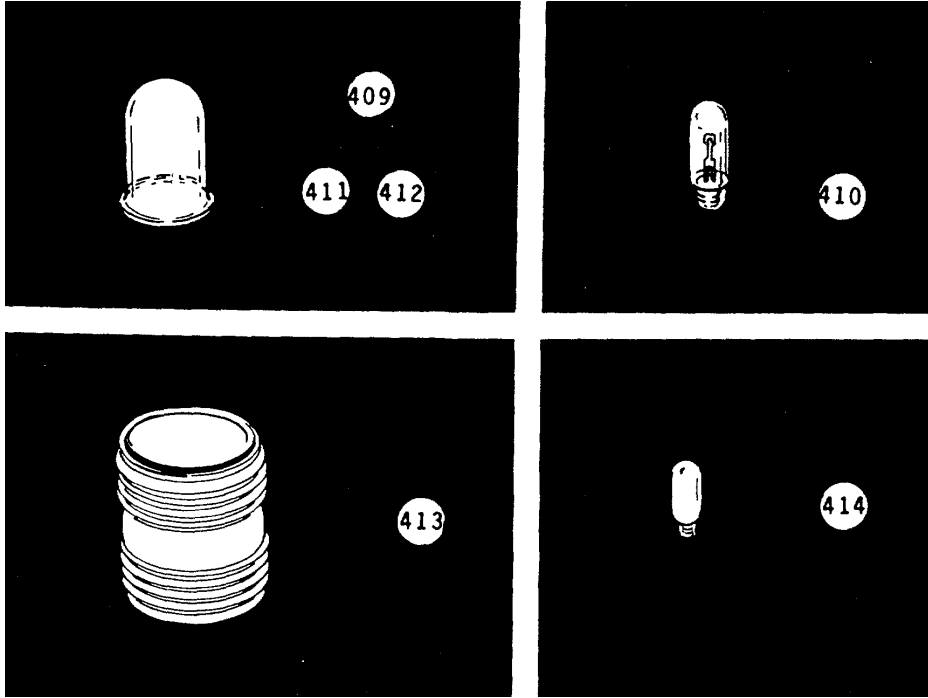

(1) ILLUS NO.	(2) NATIONAL STOCK NUMBER	(3) DESCRIPTION FSCM AND PART NUMBER	(4) USABLE ON CODE U/M	(5) QTY RQR
		The following items are u/o the Navigation Lights:		
409	6220-00-722-2013	Globe, Red MS16867-2 (96906)	EA	1
410	6240-00-577-8455	Lamp MS15545-2 (96906)	EA	5
411	6220-00-715-2029	Globe, Green MS16867-3 (96906)	EA	1
412	6220-00-722-4496	Globe, Clear MS16867-1 (96906)	EA	3
413	6240-00-617-1719	Lamp MS15574-1 (96906)	EA	1
414	6220-00-399-6196	Lens MS17998-7 (96906)	EA	1

SECTION III. BASIC ISSUE ITEMS LIST (CONTINUED).

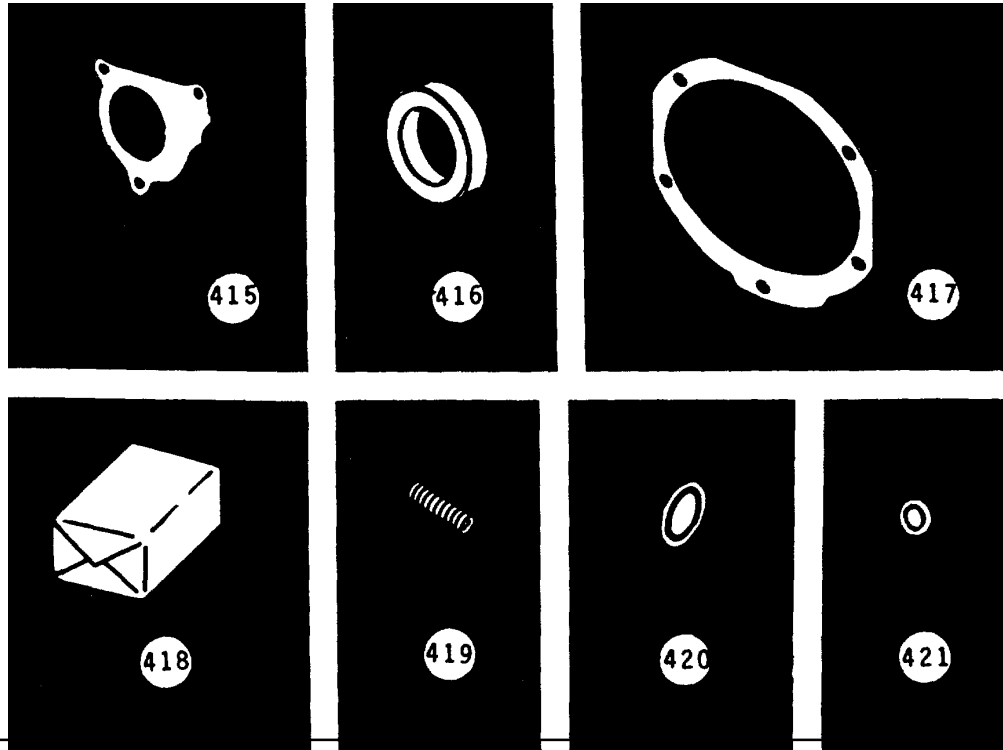

(1) ILLUS NO.	(2) NATIONAL STOCK NUMBER	(3) DESCRIPTION		(4)	(5) QTY
		FSCM AND PART NUMBER	USABLE ON CODE	U/M	RQR
		The following items are u/o the Ship's Hydrostarters:			
415	5330-00-980-1546	Gasket 5130995 (72582)		EA	3
416	5330-00-250-5705	Seal SE1047 (01843)		EA	1
417	5330-00-401-0864	Gasket GA202082 (01843)		EA	1
418	2990-00-899-4813	Kit, Repair KT202788 (01843)		EA	1
419	5360-00-650-7232	Spring 6525042 (72582)		EA	3
420	5330-00-650-7228	Seal 6525111 (72582)		EA	3
421	5330-00-672-6770	Seal 6524104 (72582)		EA	1

SECTION III. BASIC ISSUE ITEMS LIST (CONTINUED).

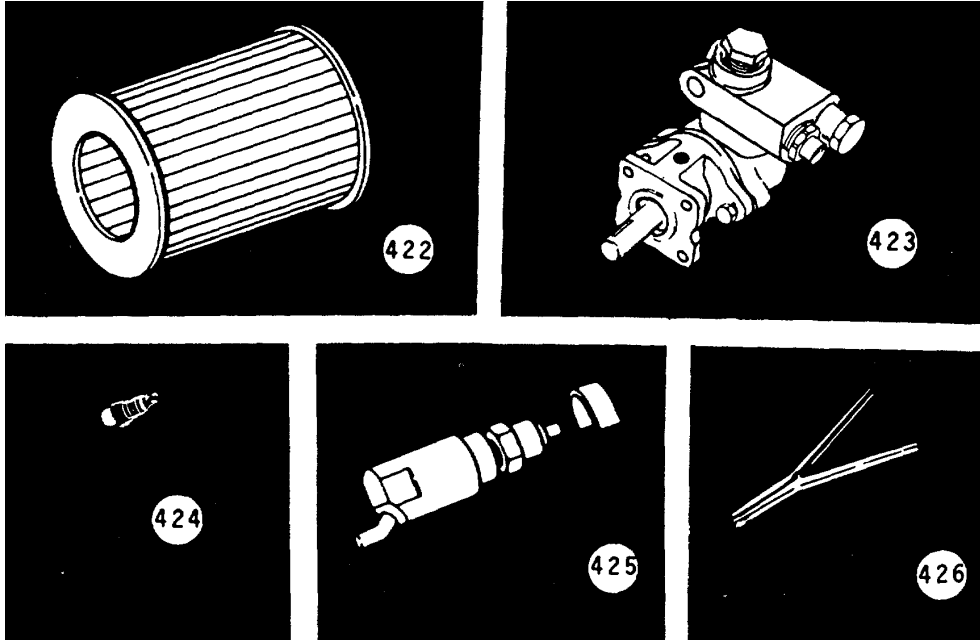

(1) ILLUS NO.	(2) NATIONAL STOCK NUMBER	(3) DESCRIPTION FSCM AND PART NUMBER	USABLE ON CODE	(4) U/M	(5) QTY RQR
422	2910-00-823-5580	Element 854454 (72582) The following item is u/o the Engine Hydrostarter System:		EA	1
423	4320-00-350-8725	Pump, Engine Charging (Hyd) (01843) RPA308090B The following item is u/o the Sanitizing Sink Heater by Marionette Marine:		EA	1
424	6240-00-155-7878	Lamp, 6W, 120V (65083) 6S6		EA	3
<u>SPECIAL TOOLS</u>					
425	5210-00-999-8777	Adapter Compression Gauge (33287) J7915-02		EA	1
426	5120-00-494-1846	Assembly Tool, Piston Ring (33287) J8128		EA	1

SECTION III. BASIC ISSUE ITEMS LIST (CONTINUED).

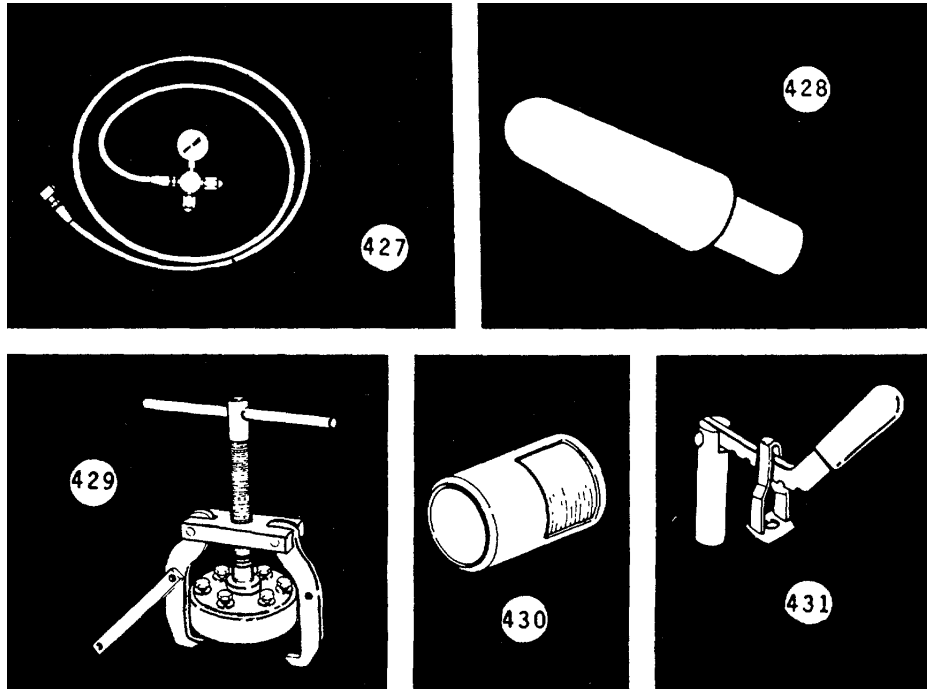

(1) ILLUS NO.	(2) NATIONAL STOCK NUMBER	(3) DESCRIPTION FSCM AND PART NUMBER	(4) USABLE ON CODE	(5) QTY RQR
427	4940-00-657-7605	Assembly, G6714-02 (33287)	EA	1
428	5120-00-219-8405	Cam Installer, Blower Drive (33287) J1471	EA	1
429	5180-00-136-6120	Clamp Set, Alignment Blower (33287) J23184-01	EA	1
430	5120-00-859-6259	Compressor, Piston Ring (33287) J3272-03	EA	1
431	5120-00-733-8888	Compressor, Valve Spring J7455 (33287)	EA	1

SECTION III. BASIC ISSUE ITEMS LIST (CONTINUED).

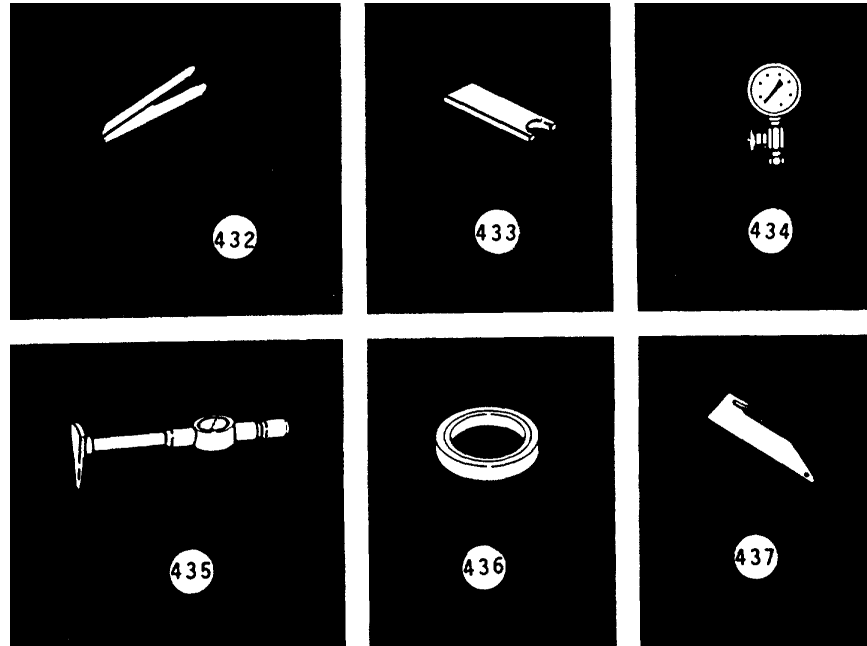

(1) ILLUS NO.	(2) NATIONAL STOCK NUMBER	(3) DESCRIPTION FSCM AND PART NUMBER USABLE ON CODE	(4) U/M	(5) QTY RQR
432	5210-01-048-7085	Gauge, Governor Gap (.0015) (33287) J23185	EA	1
433	5210-01-048-6532	Gauge, Governor Gap (.200) (33287) J23478	EA	1
434	6620-01-065-3441	Gauge, Compression (33287) J4897-5	EA	1
435	5210-01-070-4543	Gauge, Cylinder Diameter Checking (33287) J5347-01	EA	1
436	5120-00-937-7631	Gauge, Master Ring (33287) J8386-01	EA	1
437	5210-00-125-4415	Gauge, Governor Linkage (33287) J21304	EA	1

SECTION III. BASIC ISSUE ITEMS LIST (CONTINUED).

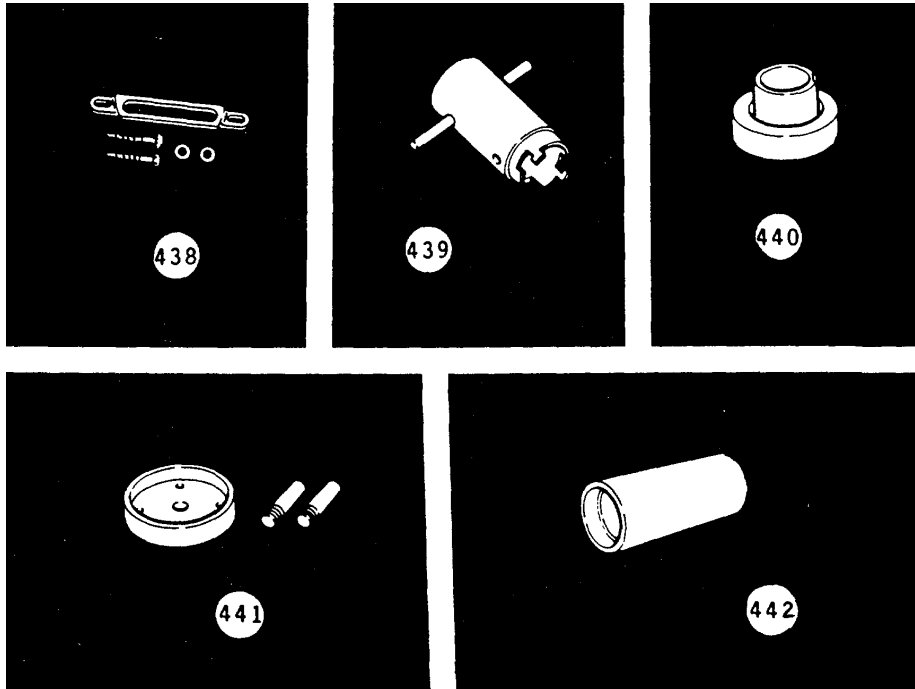

(1) ILLUS NO.	(2) NATIONAL STOCK NUMBER	(3) DESCRIPTION FSCM AND PART NUMBER USABLE ON CODE	(4) U/M	(5) QTY RQR
438	5120-00-999-8618	Hold-down Clamp, Cylinder Liner (33287) J21973-01	EA	1
439	5120-01-012-9151	Installer, Water Pump Oil Seal (33287) J22150	EA	1
440	5120-00-937-7267	Installer, Water Pump Seal (33287) J8501	EA	1
441	5120-00-999-8619	Installer, Flywheel Housing Oil Seal (33287) J9727	EA	1
442		Installer, Oil Pump Drive Gear (33287) J22825	EA	1

SECTION III. BASIC ISSUE ITEMS LIST (CONTINUED).

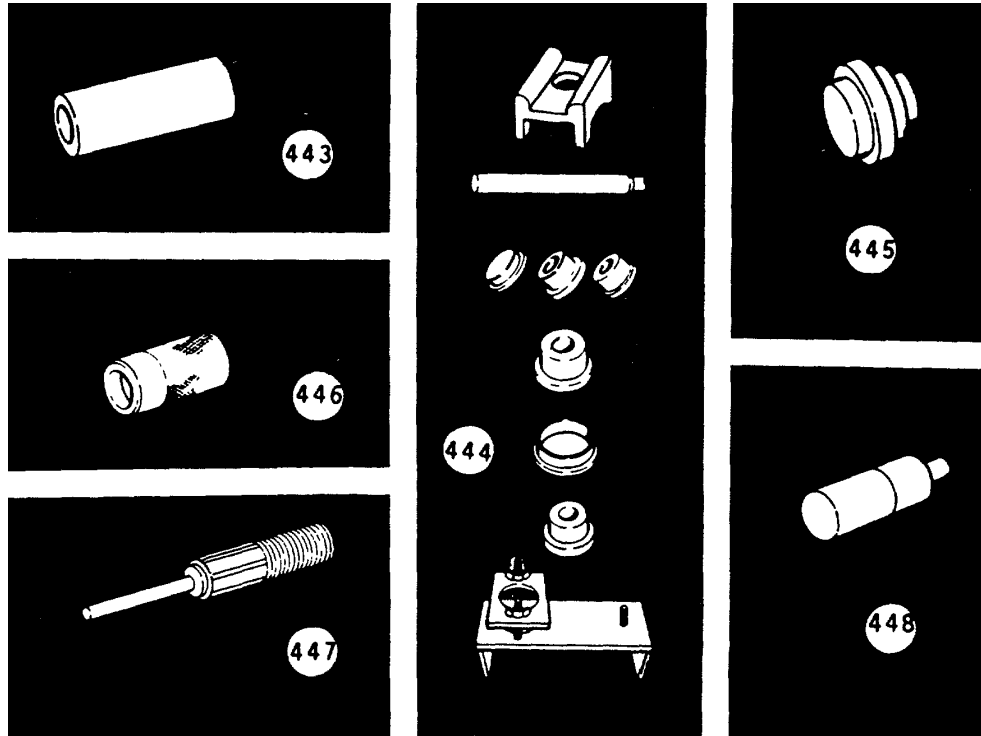

(1) ILLUS NO.	(2) NATIONAL STOCK NUMBER	(3) DESCRIPTION FSCM AND PART NUMBER USABLE ON CODE	(4) U/M	(5) QTY RQR
443	5120-00-937-7268	Installer, Oil Pump Gear (33287) J8509	EA	1
444	5180-00-776-7240	Installer & Piston Remover Set & Connecting Rod Bushing (33287) J1513-01	EA	1
445	5120-00-936-4377	Installer, Crankshaft Oil Seal (33287) J9783	EA	1
446	2815-00-018-2631	Installer, Water Pump Seal (33287) J21971	EA	1
447	5120-00-733-8876	Installer, Valve Seat Insert (33287) J6568	EA	1
448	5120-00-473-7456	Installer, Camshaft Gear (33287) J1903	EA	1

SECTION III. BASIC ISSUE ITEMS LIST (CONTINUED).

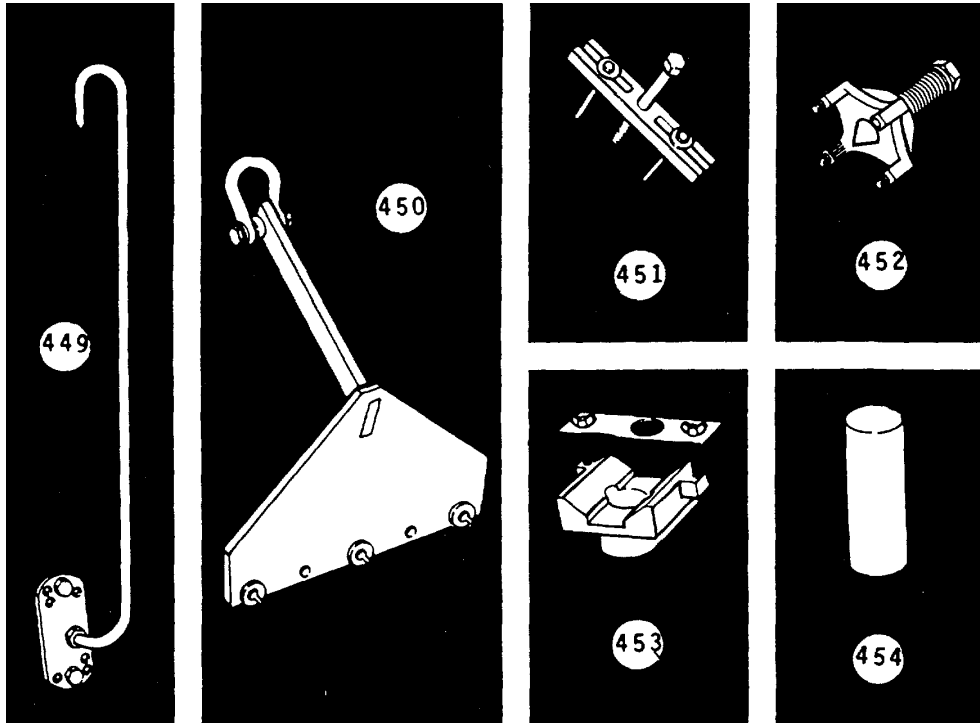

(1) ILLUS NO.	(2) NATIONAL STOCK NUMBER	(3) DESCRIPTION FSCM AND PART NUMBER USABLE ON CODE	(4) U/M	(5) QTY RQR
449	4910-00-722-3877	Lifter, Flywheel (33287) J6361-01	EA	1
450	4910-00-456-7620	Lifting Fixture, Cylinder Head (33287) J22062-01	EA	1
451	5120-00-471-4494	Puller, Crankshaft Pulley (33287) J45558-01	EA	1
452	5120-00-219-8397	Puller, Camshaft Gear (33287) J1902-01	EA	1
453	4910-00-779-6163	Reaming Fixture, Piston Bushing (33287) J5273	EA	1
454	5120-00-363-7572	Remover, Water Pump Coupling & Oil Seal (33287) J1930	EA	1

SECTION III. BASIC ISSUE ITEMS LIST (CONTINUED).

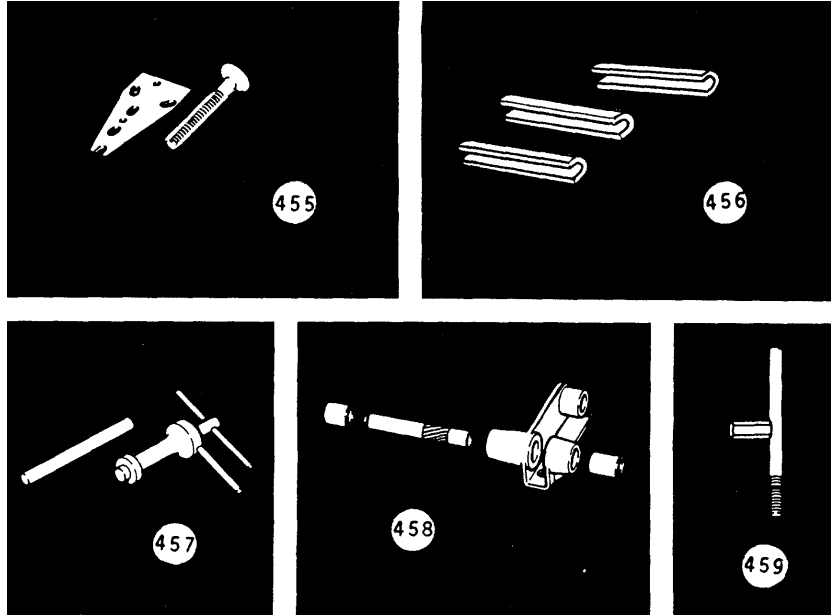

(1) ILLUS NO.	(2) NATIONAL STOCK NUMBER	(3) DESCRIPTION FSCM AND PART NUMBER USABLE ON CODE	(4) U/M	(5) QTY RQR
455	2040-01-057-6267	Remover, Water Pump Impeller (33287) J22143	EA	1
456	5120-00-494-1843	Remover Set, Push Rod (33287) J3092-01	EA	1
457	5120-00-999-8613	Remover, Valve Seat Insert (33287) J6567-02	EA	1
458	4910-00-219-8392	Reamer Set, Connecting Rod Rushing (33287) J1686-03	EA	1
459	5120-00-937-7632	Remover, Connecting Rod Nozzle (33287) J8995	EA	1

SECTION III. BASIC ISSUE ITEMS LIST (CONTINUED).

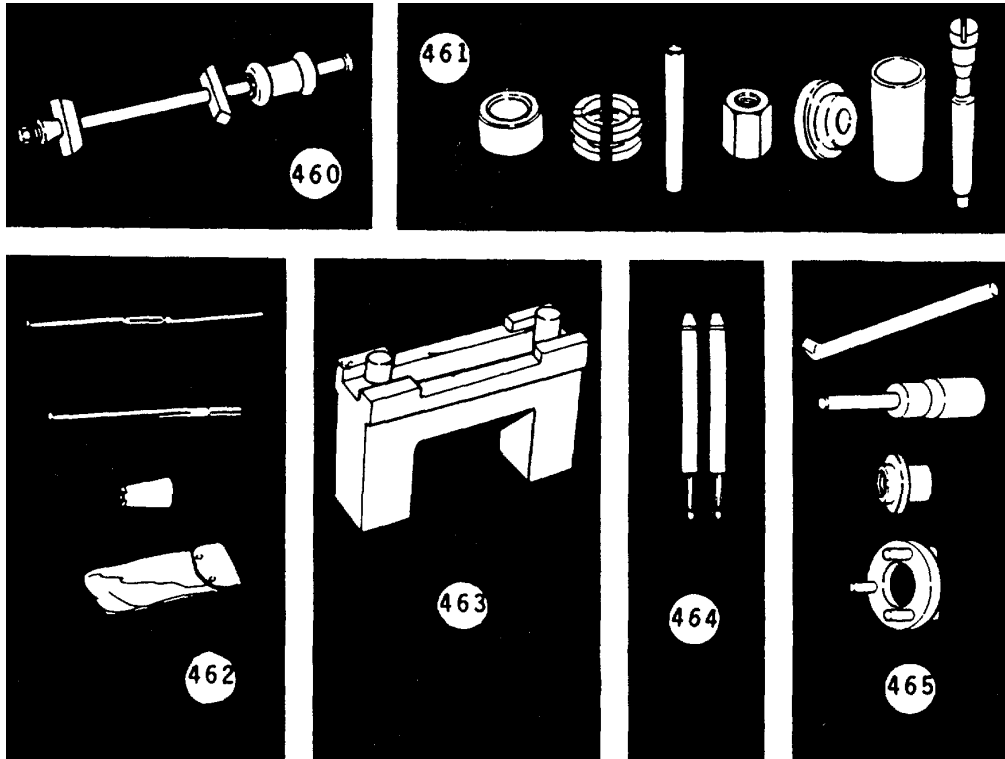

(1) ILLUS NO.	(2) NATIONAL STOCK NUMBER	(3) DESCRIPTION FSCM AND PART NUMBER USABLE ON CODE	(4) U/M	(5) QTY RQR
460	5120-00-387-9615	Remover, Cylinder Liner (33287) J1918-02	EA	1
461	5120-00-113-1004	Remover & Installer Set Blower Rotor Shaft (33287) J4254	EA	1
462	5180-00-113-3168	Reconditioning Kit, Lube Oil Pump (33287) J2624	EA	1
463	2815-00-705-9278	Service Fixture, Cam Follower (33287) J5840-01	EA	1
464	4910-00-591-6634	Stud Set, Guide (33287) J9665	EA	1
465	5180-OQ-219-8407	Tool Set, Fuel Pump (33287) J1508-02	EA	1

SECTION III. BASIC ISSUE ITEMS LIST (CONTINUED).

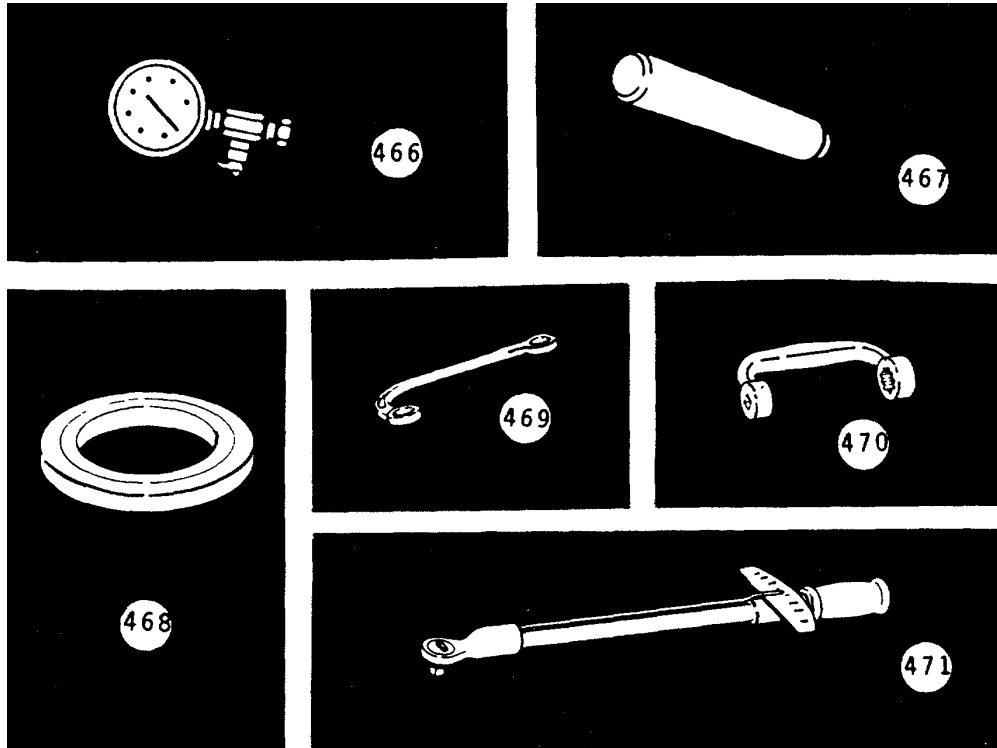

(1) ILLUS NO.	(2) NATIONAL STOCK NUMBER	(3) DESCRIPTION FSCM AND PART NUMBER	USABLE ON CODE	(4) U/M	(5) QTY RQR
466	6620-01-065-3441	Gauge, Compression (33287) J4897-528-01		EA	1
467	5120-00-711-6305	Installing Tool, Hydrostarter Relief Valve (33287) J7192		EA	1
468		Tool, Shaft Seal Aligning (58849) 52407		EA	1
469	5120-00-591-2685	Wrench, Fuel & Water Pump (33287) J4242		EA	1
470	5120-01-013-1677	Wrench, Cylinder head (33287) J1928-01		EA	1
471	5120-00-247-2540	Wrench, Torque, 1/2" Drive 0-300 ft.lbs. (81348) GGG-W-00686		EA	1

SECTION III. BASIC ISSUE ITEMS LIST (CONTINUED)

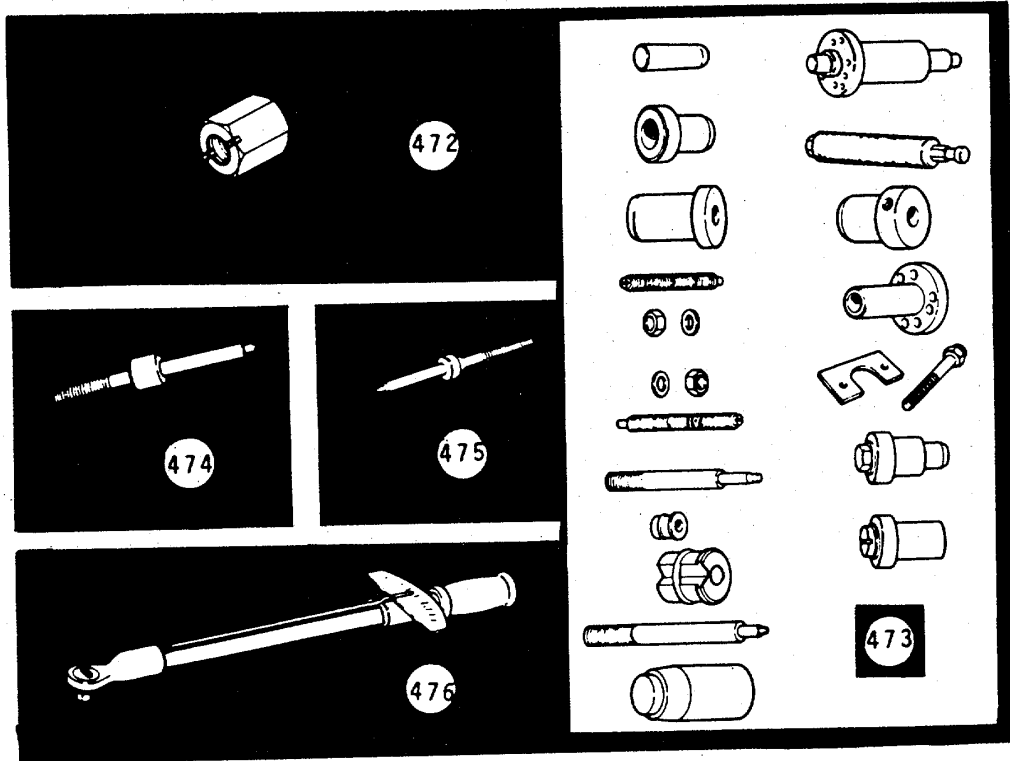

(1) ILLUS NO.	(2) NATIONAL STOCK NUMBER	(3) DESCRIPTION FSCM AND PART NUMBER	(4) USABLE ON CODE U/M	(5) QTY RQR
472	5120-00-627-9311	Wrench, Gov Retainer Nut (33287) J1652-01	EA	1
473	4940-00-611-7945	Tool Set, Blower Service (33287) J6270-04	EA	1
474	5210-00-474-6400	Timing Gage, INJ 1.484 (33287) J1242	EA	1
475	5220-00-387-9581	Timing Gage, INJ 1.460 (33287) J1853	EA	1
476	5120-00-221-7983	Wrench, Torque 3/4 inch Drive 0-600 ft.lbs.	EA	1

SECTION III. BASIC ISSUE ITEMS LIST (CONTINUED)

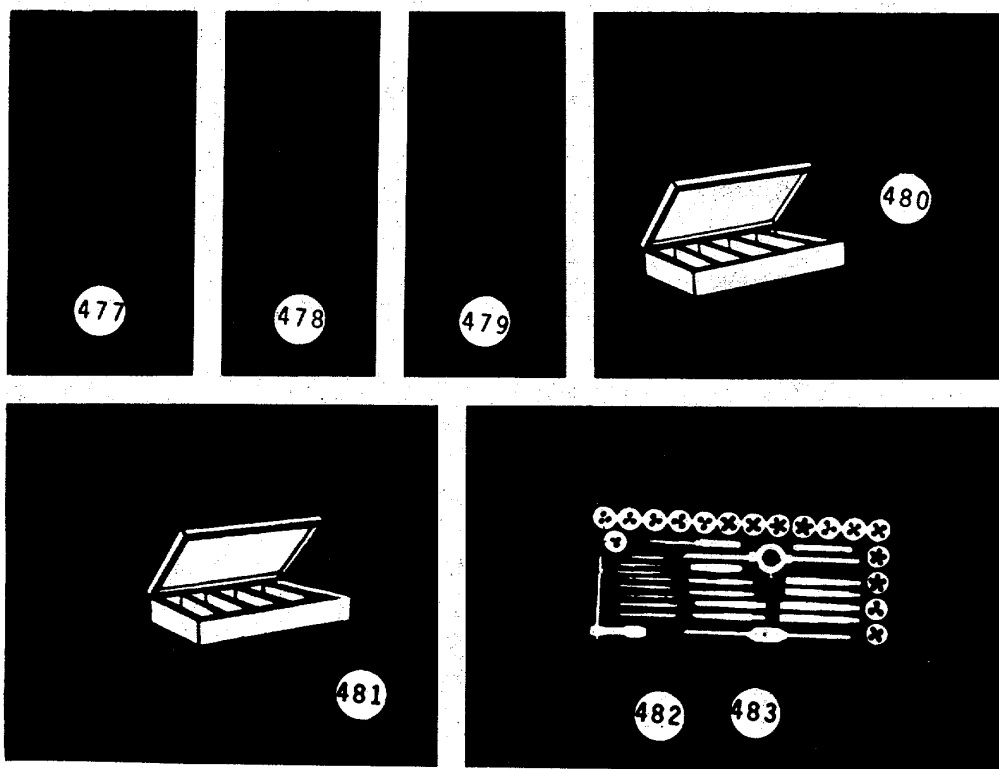

(1) ILLUS NO.	(2) NATIONAL STOCK NUMBER	(3) DESCRIPTION FSCM AND PART NUMBER	(4) USABLE ON CODE U/M	(5) QTY RQR
477	5850-00-407-6671	Signal Lamp. Aldis, SE 11 (80063)	EA	1
478		Sprayer, Insecticide, Hand, 2 gallon		
479	5680-00-351-9702	Tachometer, Mechanical 1412 (57737)	EA	1
480	6630-00-074-0394	Test Kit, Chromate 12100 (71881)	EA	2
481	6630-00-531-1968	Test Kit, Oil Conditioning (531 Components) T-19467 (81349)	EA	2
482	5180-00-357-7514	Threading Set, Pipe, 1/8 inch to 1 inch GGG-T-581 (81348)	EA	1
483	5180-00-387-9631	Threading Set, Pipe, 1-1/4-11-1/2 NPT	EA	1

SECTION III. BASIC ISSUE ITEMS LIST (CONTINUED)

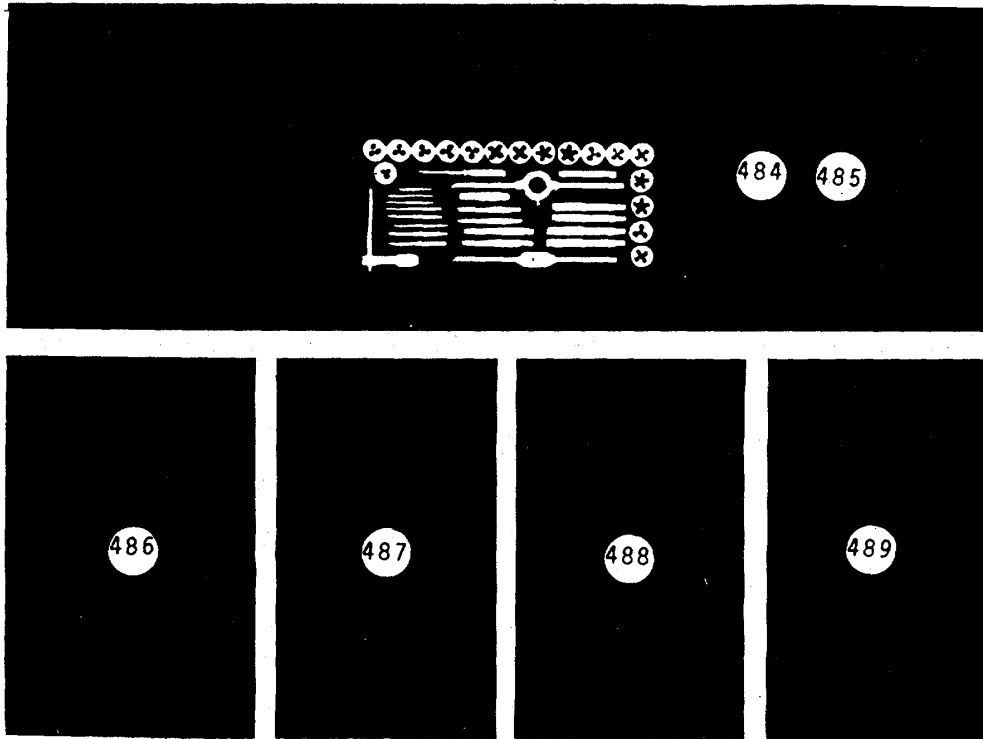

(1) ILLUS NO.	(2) NATIONAL STOCK NUMBER	(3) DESCRIPTION FSCM AND PART NUMBER USABLE ON CODE	(4) U/M	(5) QTY RQR
484	5180-00-448-2362	Threading Set, Screw 1/4-20 to 1-8 NC	EA	1
485	5180-00-422-4975	Threading Set, Screw, 1/4-28 to 1-12 NF & 1-14 NS	EA	1
486	5180-00-356-4614	Tool Kit, TK-61/SR	EA	1
487	5180-00-293-2875	Tool Kit, Carpenters	EA	1
488	5180-00-629-9783	Tool Kit, General Mechanics, Marine SC5180-97-CL-E28	EA	2
489	5180-00-511-1950	Tool Kit, Machinist	EA	1

SECTION III. BASIC ISSUE ITEMS LIST (CONTINUED)

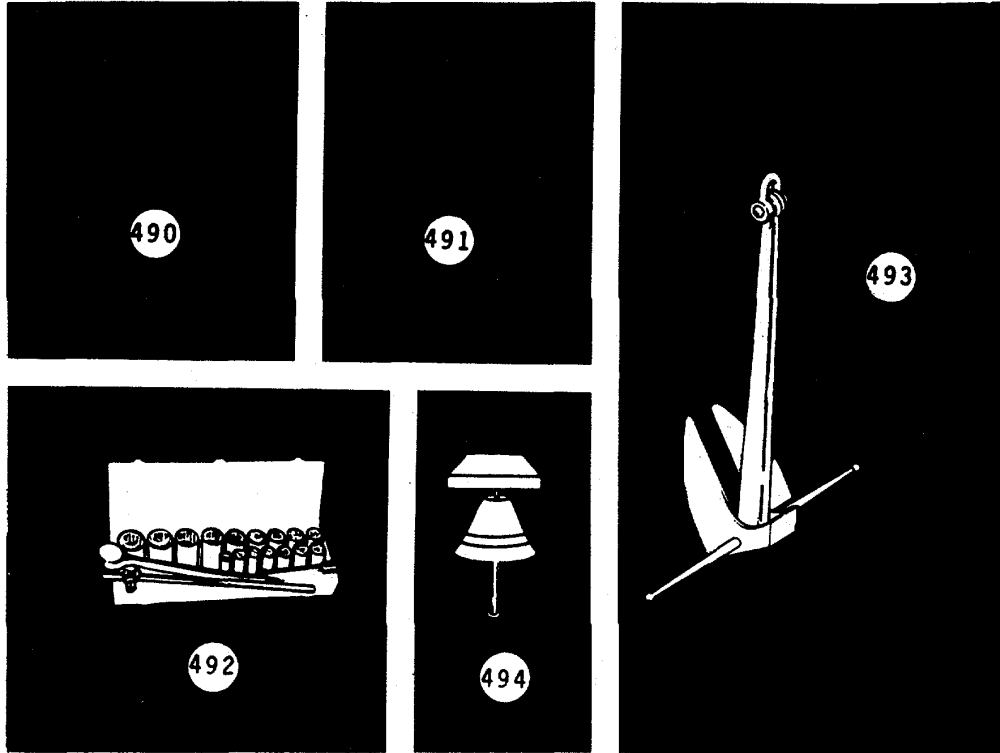

(1) ILLUS NO.	(2) NATIONAL STOCK NUMBER	(3) DESCRIPTION FSCM AND PART NUMBER	(4) USABLE ON CODE U/M	(5) QTY RQR
490	3433-00-357-8116	Torch Outfit, Cutting and Welding, Medium Duty, Oxy-Acetylene	EA	1
491	6645-00-250-4680	Watch, Stop, 60 Second Dial GG-S-764 (81348)	EA	1
492	5120-00-204-1999	Wrench Set, Socket, 3/4 inch, Square Drive 12 PT 7/8 to 2 inches	EA	1
493	2040-00-377-8607	Anchor, Removable Stock, LWT A15707 (81349)	EA	1
494	6350-00-256-9062	Bell, Ships, 30 lb. "A" Flat MIL-B-674 (81349)	EA	1

SECTION III. BASIC ISSUE ITEMS LIST (CONTINUED)

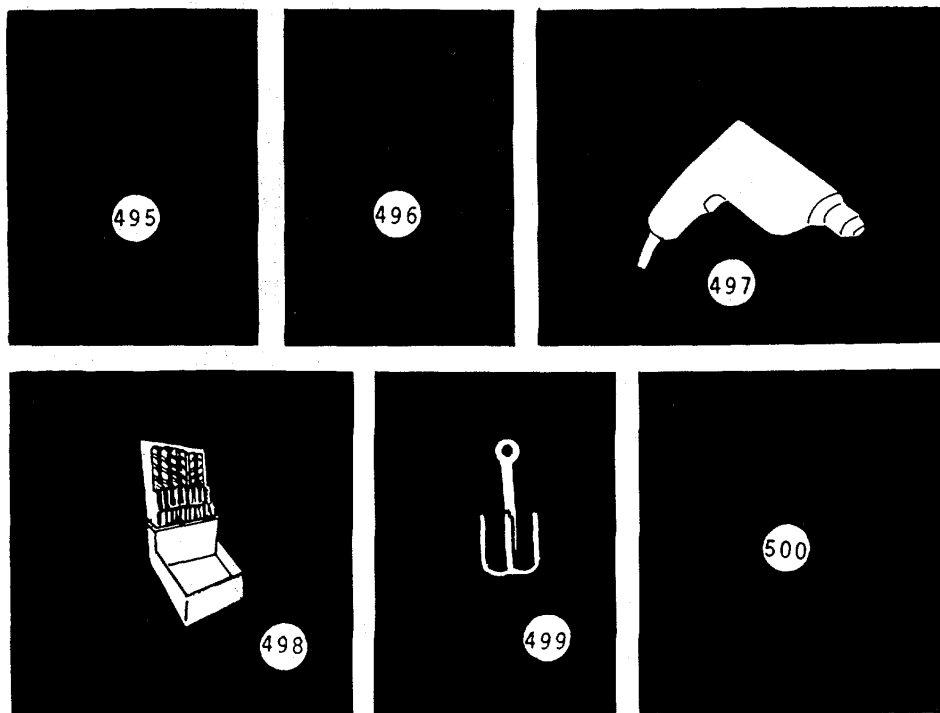

(1) ILLUS NO.	(2) NATIONAL STOCK NUMBER	(3) DESCRIPTION FSCM AND PART NUMBER	(4) USABLE ON CODE U/M	(5) QTY RQR
495	7210-00-282-7950	Blanket, Wool, OD, B-844 (81349)	EA	28
496	6665-00-618-1482	Detector Kit, Carbon Monoxide, Colometric	EA	1
497	5130-00-853-4480	Drill, Electric 1/2 inch AC/DC WD-661 (81348)	EA	1
498	5133-00-293-0983	Drill Set, Twist, HSS, ST, Rd Shank, Rn Cut, W/Case	EA	1
499	2040-00-238-9060	Grapnel, Marine, Iron or Steel, Galv, Prong 15 lb.	EA	1
500	3940-00-150-7108	Hoist, Chain, Hand, 3/4 Ton, 10 Feet, Load Chain, Lever, and Ratchet	EA	2

SECTION III. BASIC ISSUE ITEMS LIST (CONTINUED)

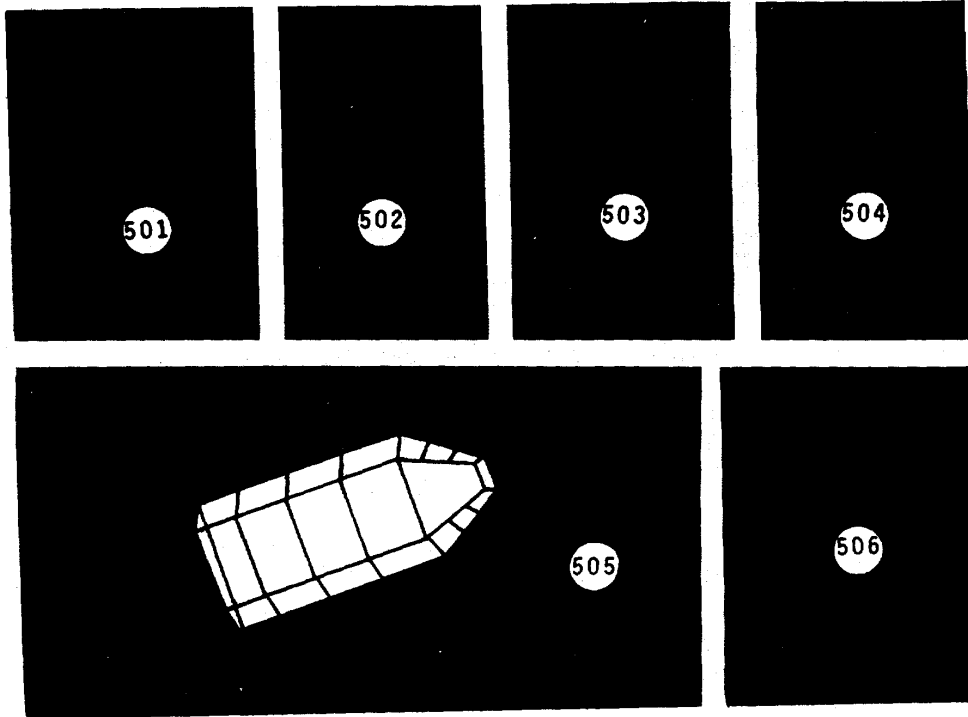

(1) ILLUS NO.	(2) NATIONAL STOCK NUMBER	(3) DESCRIPTION FSCM AND PART NUMBER USABLE ON CODE	(4) U/M	(5) QTY RQR
501	3950-00-235-4236	Hoist, Chain, Hand 1-1/2 Ton, 10 Feet, 1 Load Chain, Lever, and Ratchet	EA	1
502	3950-00-965-0096	Hoist, Chain, Hand, 2 Ton 12 Feet, 1 Load Chain, Spur Gear	EA	1
503	4720-00-202-6482	Hose Assy, Rubber, Wrap, Water, 3/4 inch Female Hose Fitting, 14 NPSH, 50 ft. Long	EA	2
504	4210-00-078-9170	Hose, Fire, 1-1/2 in. NH, 1-1/2 in. ID, 50'	EA	4
505	6530-00-783-7810	Litter, Rigid, Stokes	EA	1
506	7210-00-292-2326	Pillowcase, Bed DDD-P-351 (81348)	EA	28

SECTION III. BASIC ISSUE ITEMS LIST (CONTINUED)

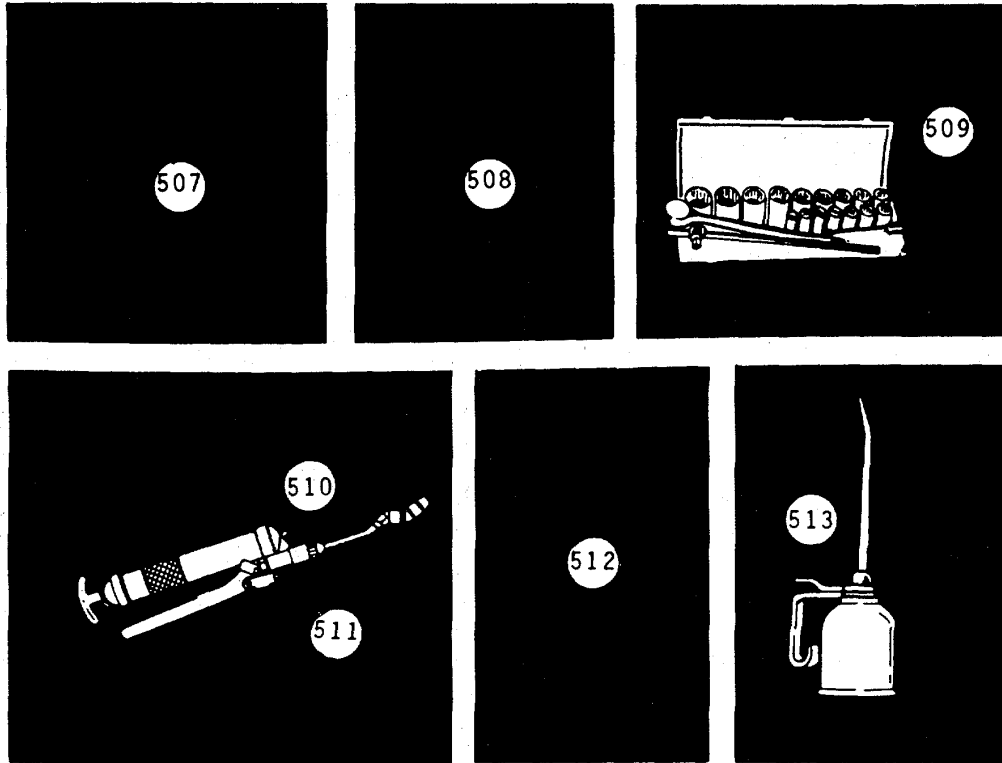

(1) ILLUS NO.	(2) NATIONAL STOCK NUMBER	(3) DESCRIPTION FSCM AND PART NUMBER USABLE ON CODE	(4) U/M	(5) QTY RQR
507	4220-00-285-3157	Ring, Buoy, Floating, 30 inch OD w/Line R-116847 (81349)	EA	10
508	6605-00-001-4322	Sextant, Marine, MK3, MOD1 9240-001 (12004)	EA	1
509	5120-00-357-5135	Wrench Set, Socket, Sq Drive, 3/4 inch Across Flats, Hex Type Sockets	EA	1
510	4930-00-253-2478	Grease Gun, Hand, 16 oz cap	EA	1
511	4930-00-287-5419	Gun, Fluid (Grease), Dir. Del. 30 oz Cap.	EA	1
512	6230-00-828-6398	Lantern, elcl, 6V, w/Relay	EA	5
513	4930-00-262-8868	Oiler, Hand, Flex Spout 1 pt GGG-0-591 (81348)	EA	2

SECTION III. BASIC ISSUE ITEMS LIST (CONTINUED)

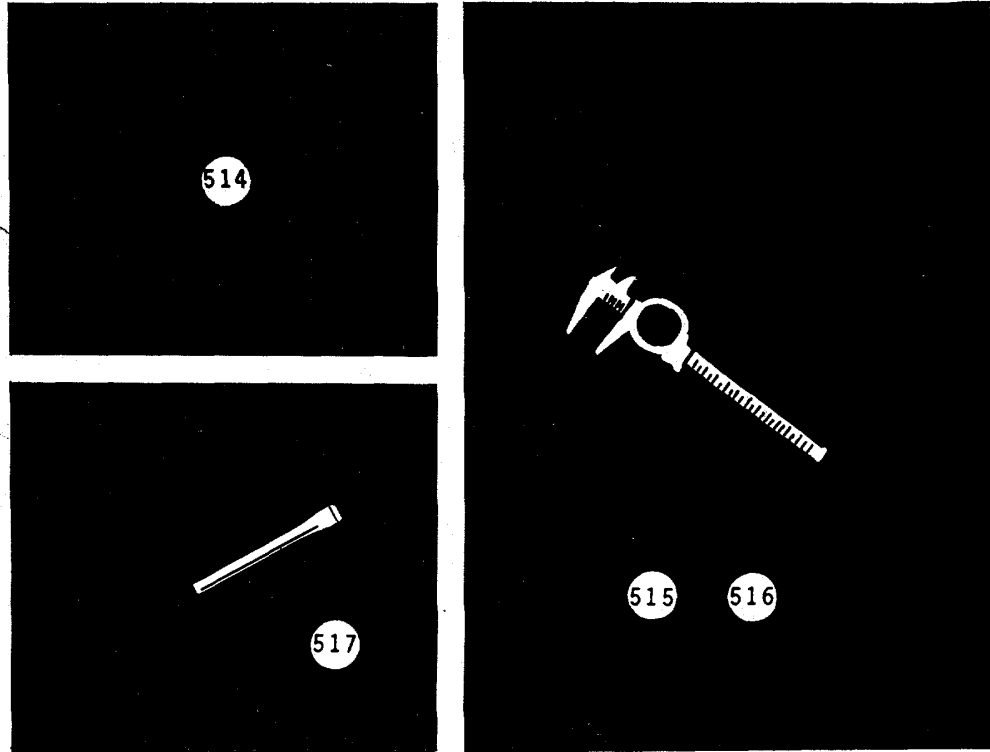

(1) ILLUS NO.	(2) NATIONAL STOCK NUMBER	(3) DESCRIPTION FSCM AND PART NUMBER	USABLE ON CODE	(4) U/M	(5) QTY RQR
514	5120-00-293-0762	GGG-B-101, Type V, Class 1, Style B (81348)	Bar, Wrecking, 36 inches	EA	1
515	5210-00-554-7134	GGG-C-105, Type 1, Class 1, Style A, (81348)	Caliper Set, Micrometer	EA	1
516	5210-00-221-1921	GGG-C-105, Type 1, Class 2 (81348)	Caliper Set Micrometer Inside 2 to 12 in.	EA	1
517	5110-00-554-7345	GGG-C-313 Type 1 Style B (81348)	Chisel, Cape, 1/2 x 6 3/4 in.	EA	1

SECTION III. BASIC ISSUE ITEMS LIST (CONTINUED)

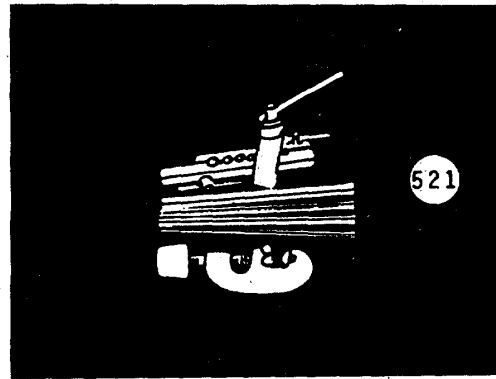
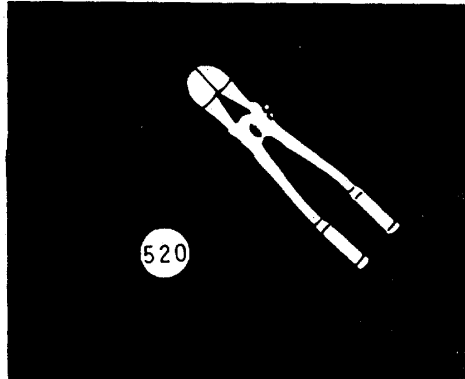
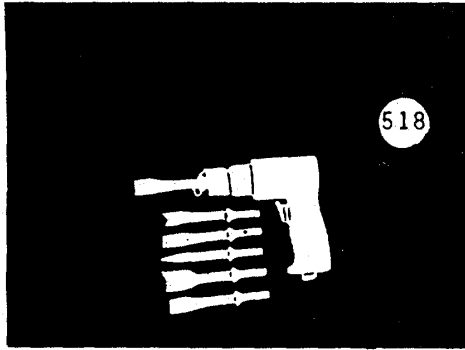

(1) ILLUS NO.	(2) NATIONAL STOCK NUMBER	(3) DESCRIPTION FSCM AND PART NUMBER	USABLE ON CODE	(4) U/M	(5) QTY RQR
518	5110-00-203-6424	GGG-C-330 Type XV, Class A (81348)	Chisel, Power Hammer	EA	2
519	5120-00-529-3744	GGG-C-406 Type 1 Style I Class D (81348)	Clamp "C" heavy 9 ER 1165	EA	2
520	5110-00-188-2524	GGG-C-740 Class 4 (81348)	Cutter, Bolt 36 inch	EA	1
521	5180-00-596-1035	GGG-C-771, Type 2, Class I (81348)	Cutting & Flaring Tool Kit	EA	1

SECTION III. BASIC ISSUE ITEMS LIST (CONTINUED)

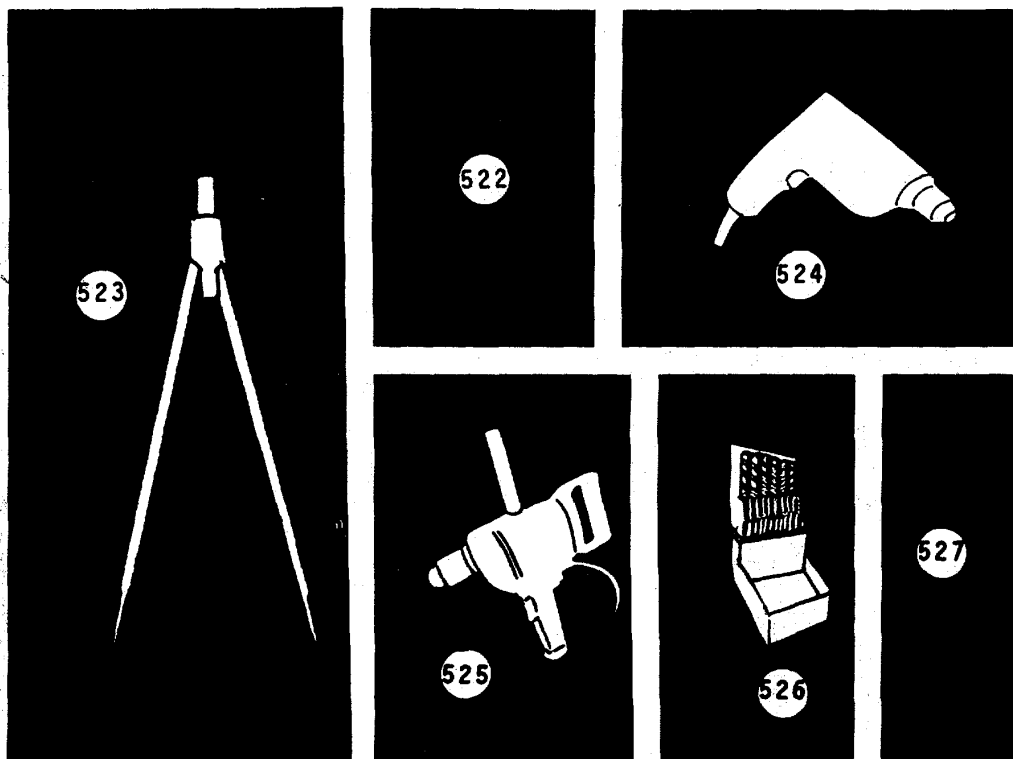

(1) ILLUS NO.	(2) NATIONAL STOCK NUMBER	(3) DESCRIPTION FSCM AND PART NUMBER	USABLE ON CODE	(4) U/M	(5) QTY RQR
522	5110-00-293-0460	GGG-C-771, Type 1, Class I Style B (81348)	Cutter Pipe 1/8 in.- 2 in.	EA	1
523	5210-00-266-7038	GGG-D-351, Type A, Class 2 (81348)	Dividers, Mech Ring-Type	EA	1
524	5130-00-473-6224	W-D-661, Class C - Style I (81348)	Drill Elcl Prbl 3/8 inch cap	EA	1
525	5130-00-226-5386	W-D-1114, Style 4 (81348)	Drill Elcl, Prbl 1/2 in.cap	EA	1
526	5136-00-293-0983	GGG-D-751 (81348)	Drill Set, Twist Set # 2	EA	2
527	6230-00-268-9246	XP162 (83303)	Droplight, Explosion-Proof	EA	1

SECTION III. BASIC ISSUE ITEMS LIST (CONTINUED).

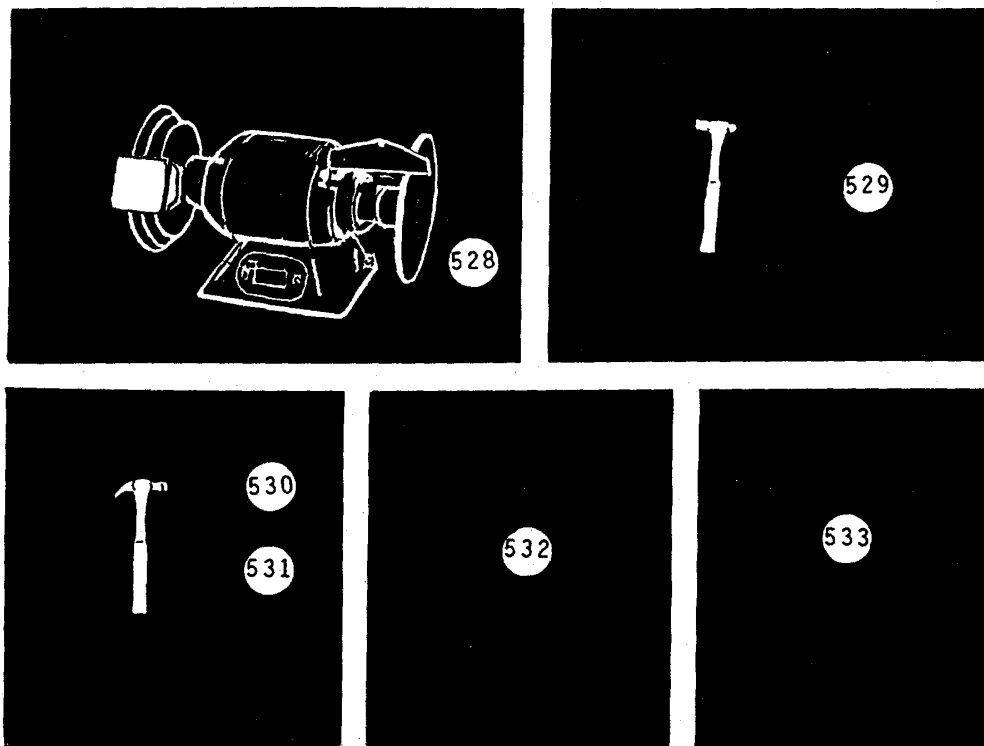

(1) ILLUS NO.	(2) NATIONAL STOCK NUMBER	(3) DESCRIPTION FSCM AND PART NUMBER	USABLE ON CODE	(4) U/M	(5) QTY RQR
528	3415-00-243-1456	NO REF (33333)	Grinding Machine Bench Mtd 115 VAC	EA	1
529	5120-00-224-4111	GGG-H-886 (81348)	Hammer, Hand, Sealing	EA	4
530	5120-00-243-2957	GGG-H-86 (81348)	Hammer, Hand 10 lb	EA	1
531	5120-00-061-8546	GGG-H-86 (81348)	Hammer, Hand 24 oz	EA	2
532	5130-00-190-6442	CO-H-116 Type 1, Style A (81348)	Hammer, Pneu- matic Ptbl.	EA	2
533	3950-00-235-4235	NO REF (33333)	Hoist, Chain, Lever & Ratchet	EA	2

SECTION III. BASIC ISSUE ITEMS LIST (CONTINUED)

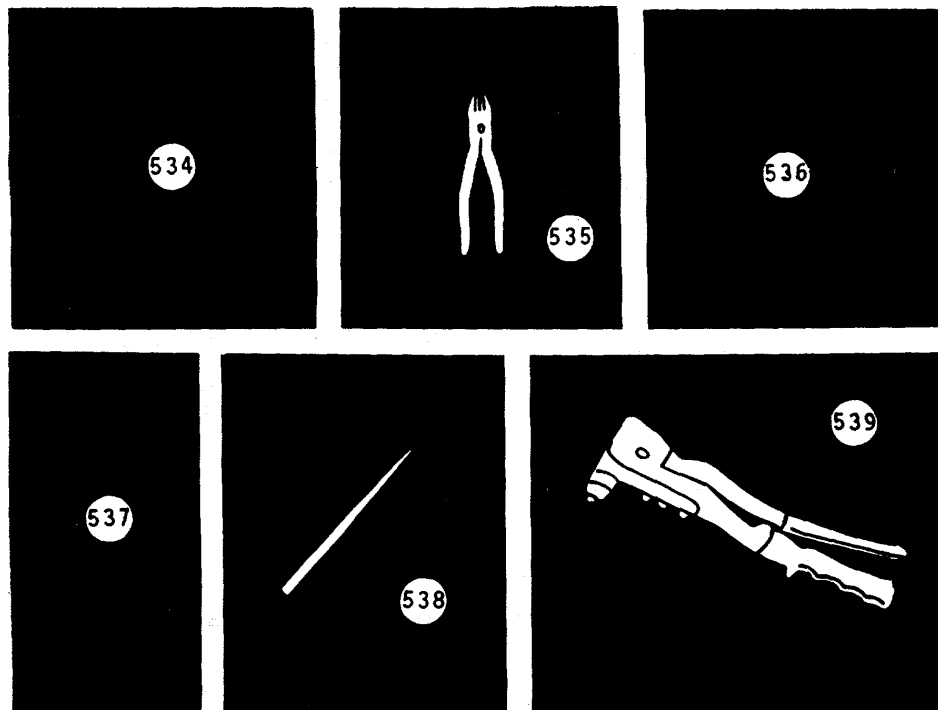

(1) ILLUS NO.	(2) NATIONAL STOCK NUMBER	(3) DESCRIPTION FSCM AND PART NUMBER	USABLE ON CODE	(4) U/M	(5) QTY RQR
534	3950-00-235-4236	NO REF (33333)	Hoist, Chain, Lever & Ratchet	EA	2
535	5120-00-248-9420	GGG-P-471, Type IX Class 2 (81348)	Pliers, Lineman 8 inches	EA	1
536	5120-00-224-9456	W-P-796 Type 1 (81348)	Puller, Fuse, No 2	EA	2
537	5120-00-288-7710	GGG-P-781 Type 1, Class 1	Puller, Mechan- ical 0-7 in.	EA	2
538	5110-00-449-7313	HP7 (45225)	Punch Set, Hand	EA	1
539	5120-00-017-2849	GGG-R-00395 (81348)	Riveter, Blind Hand	EA	1

SECTION III. BASIC ISSUE ITEMS LIST (CONTINUED)

(1) ILLUS NO.	(2) NATIONAL STOCK NUMBER	(3) DESCRIPTION FSCM AND PART NUMBER	(4) USABLE ON CODE U/M	(5) QTY RQR
540	5130-00-226-5387	00-S-116, Type II, Style I (81348)	EA	2
541	5120-00-278-1280	GGG-S-121, Type 1, Design Flat Tip, 8 in.	EA	2
542	5120-00-293-3309	GGG-S-121, Type 1, Design A (81348)	EA	2
543	5120-00-542-3438	GGG-S-121, Type VI, Class 6 (81348)	EA	2

SECTION III. BASIC ISSUE ITEMS LIST (CONTINUED)

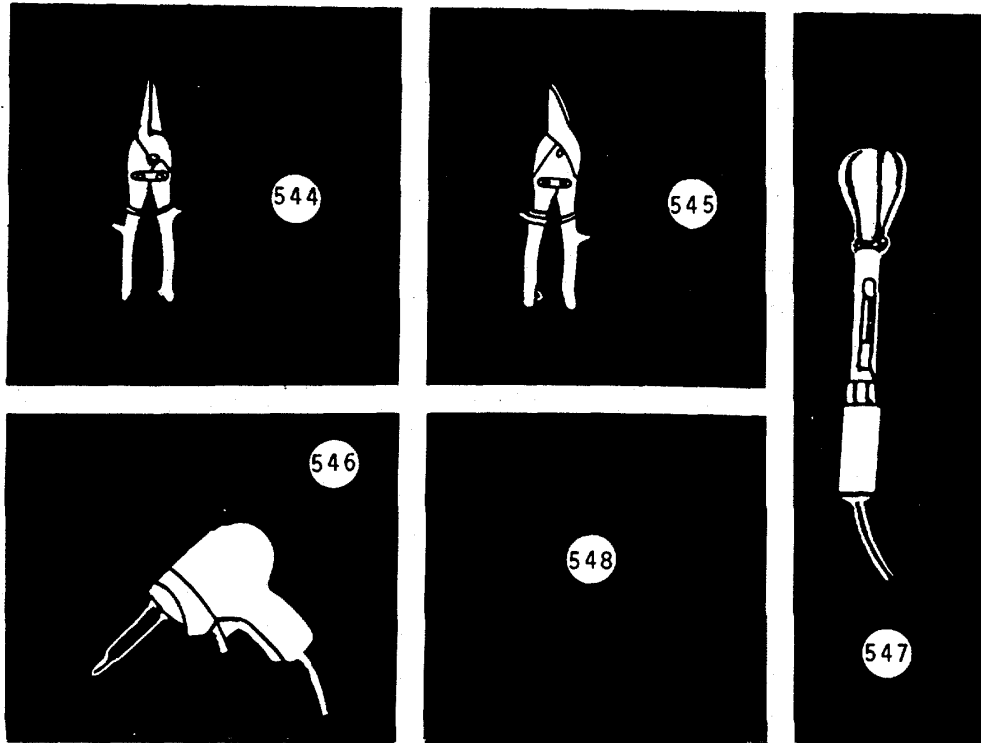

(1) ILLUS NO.	(2) NATIONAL STOCK NUMBER	(3) DESCRIPTION FSCM AND PART NUMBER	USABLE ON CODE	(4) U/M	(5) QTY RQR
544	5110-00-221-1087	GGG-S-291, Class 3 (81348)	Shears, Metal Cutting Straight Cut	EA	1
545	5110-00-223-5370	GGG-S-278 Type 1, Class 4 (81348)	Shears, Tailors	EA	1
546	3439-00-542-0531	450K4 (11103)	Soldering Gun Kit, Elcl	EA	1
547	6630-00-171-5126	GGG-T-258 Class 1 Style B (81348)	Tester, Batt. Electrolite Solution	EA	1
548	5130-00-857-8522	600-S-90 (81348) AC/DC	Sander, Disc Elcl Portable	EA	1

SECTION III. BASIC ISSUE ITEMS LIST (CONTINUED)

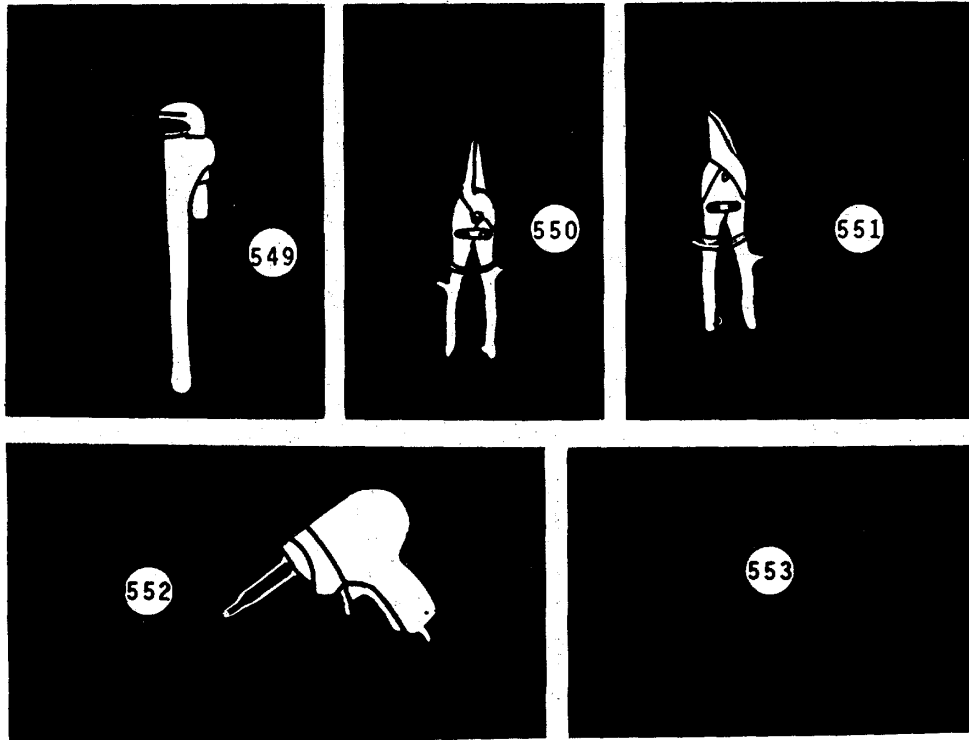

(1) ILLUS NO.	(2) NATIONAL STOCK NUMBER	(3) DESCRIPTION FSCM AND PART NUMBER	USABLE ON CODE	(4) U/M	(5) QTY RQR
549	5120-00-277-1462	GGG-W-651 Type 2 Class A	Wrench Pipe 24 inches	EA	2
550	5110-00-221-1087	GGG-S -291, Class 3 (81348)	Shears, Metal Cutting Straight Cut	EA	1
551	5110-00-223-5370	GGG-S-278 Type 1, Class 4 (81348)	Shears, Tailors	EA	1
552	3439-00-542-0531	450K4 (11103)	Soldering Gun Kit, Elcl	EA	1
553	6630-00-171-5126	GGG-T-258 Class 1 Style B (81348)	Tester, Batt. Electrolite Solution	EA	1

SECTION III. BASIC ISSUE ITEMS LIST (CONTINUED)

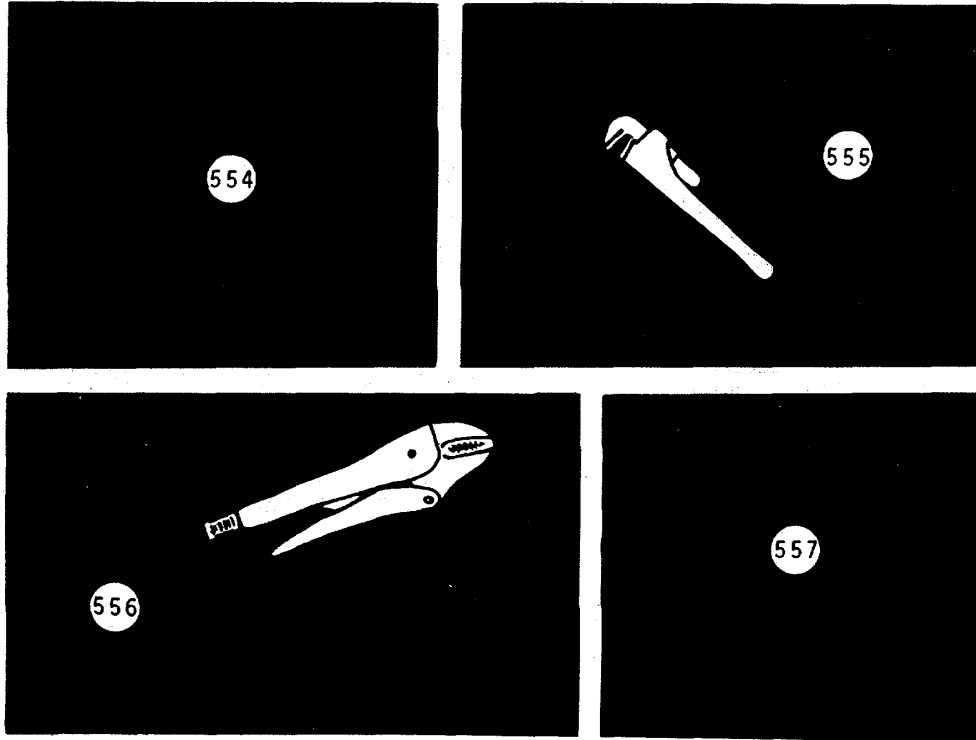

(1) ILLUS NO.	(2) NATIONAL STOCK NUMBER	(3) DESCRIPTION FSCM AND PART NUMBER	USABLE ON CODE	(4) U/M	(5) QTY RQR
554	5130-00-857-8522	600-S-90 (81348) AC/DC	Sander, Disc Elcl Portable	EA	1
555	5120-00-277-1462	GGG-W-651 Type 2 Class A	Wrench Pipe 24 inches	EA	2
556	5120-00-277-4244	GGG-W-649 Type 1 Class 1 Style A (81348)	Wrench Plier, 8 1/2 inches	EA	2
557	5120-00-288-6488	GGG-W-665 Type 1 Class 1 (81348)	Wrench, Spanner fixed pivot point adjustable hook 3/4-2 in.	EA	6

SECTION III. BASIC ISSUE ITEMS LIST (CONTINUED)

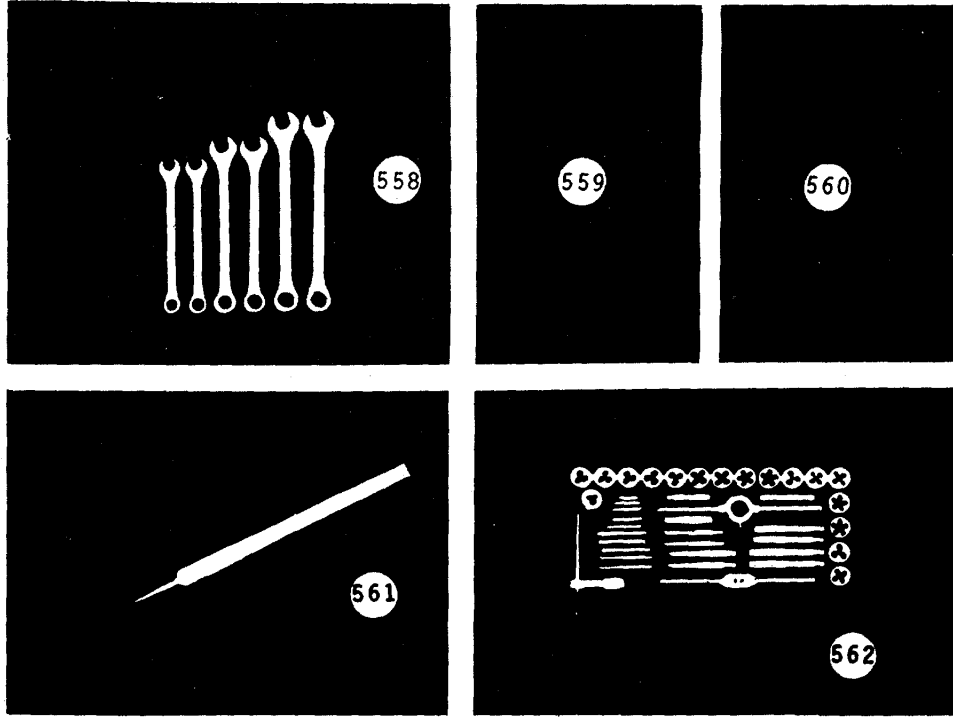

(1) ILLUS NO.	(2) NATIONAL STOCK NUMBER	(3) DESCRIPTION FSCM AND PART NUMBER	USABLE ON CODE	(4) U/M	(5) QTY RQR
558	5120-00-935-7333	OEXM709 (55719)	Wrench Set, Comb. Box & Open-end Metric	EA	1
559	5120-00-224-9453	W-P-796, Type 1	Puller, Fuse #1	EA	2
560	5130-00-288-6577	MIL-STD-1337	Scaling and Chipping Tool	EA	2
561	5120-00-223-8860	MIL-F-3113	File 18 inch	EA	1
562	5180-00-448-2362	GGG-T-300 Type 1 (81348)	Threading Set, Screw 1/2-20 Tol 8 NC	EA	1

SECTION III. BASIC ISSUE ITEMS LIST (CONTINUED)

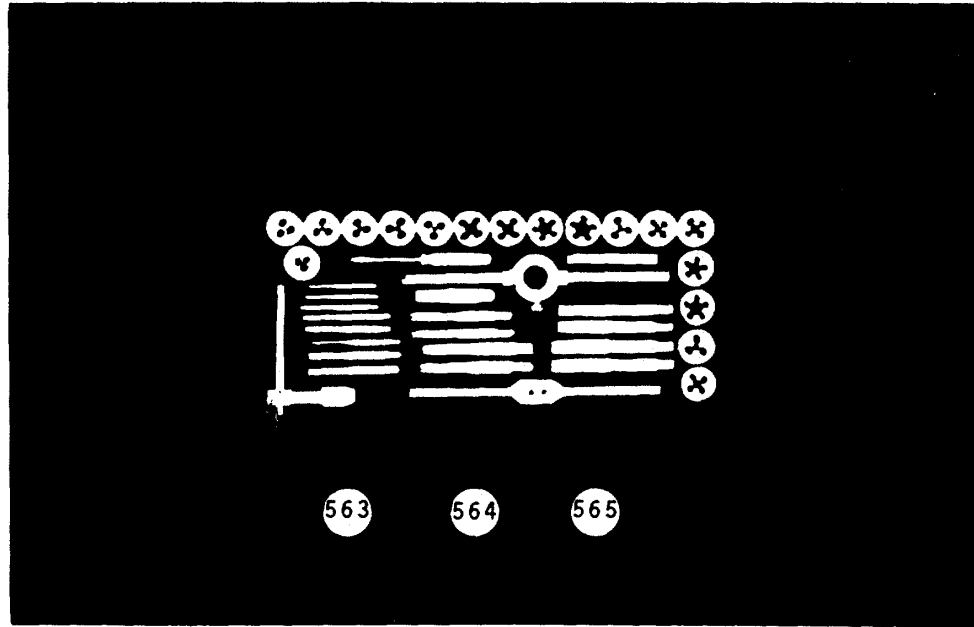

(1) ILLUS NO.	(2) NATIONAL STOCK NUMBER	(3) DESCRIPTION FSCM AND PART NUMBER	(4) USABLE ON CODE U/M	(5) QTY RQR
563	5180-00-422-4975	GGG-T-330, Type 1 (81348)	Threading Set Screw 1/4-28 to 1-12 NF	EA 1
564	5180-00-357-7514	GGG-T-581 Type 1 Class 1	Threading Set, Pipe 1/8-1 inch	EA 1
565	5180-00-387-9631	NO REF (33333)	Threading Set Pipe	EA 1

SECTION III. BASIC ISSUE ITEMS LIST (CONTINUED)

(1) ILLUS NO.	(2) NATIONAL STOCK NUMBER	(3) DESCRIPTION FSCM AND PART NUMBER	USABLE ON CODE	(4) U/M	(5) QTY RQR
566	5180-00-926-3552	SC5180-00-97-CL-E49 (81996)	Tool Kit, Air Conditioner	EA	1
567	5180-00-629-9783	SC578000-97-CL-E28 (81996)	Tool Kit, General Mech. Rail & Marine	EA	2
568	5180-00-691-1165	5144 (00624)	Tool Kit Hydraulic Hose	EA	1
569	5180-00-596-1474	SC5180-00-97-CL-E18 (81996)	Tool Kit, Service Refrig.	EA	1
570	3439-00-542-0531	GGG-T-570 (81348)	Torch Kit, Soldering LP Gas	EA	1

SECTION III. BASIC ISSUE ITEMS LIST (CONTINUED)

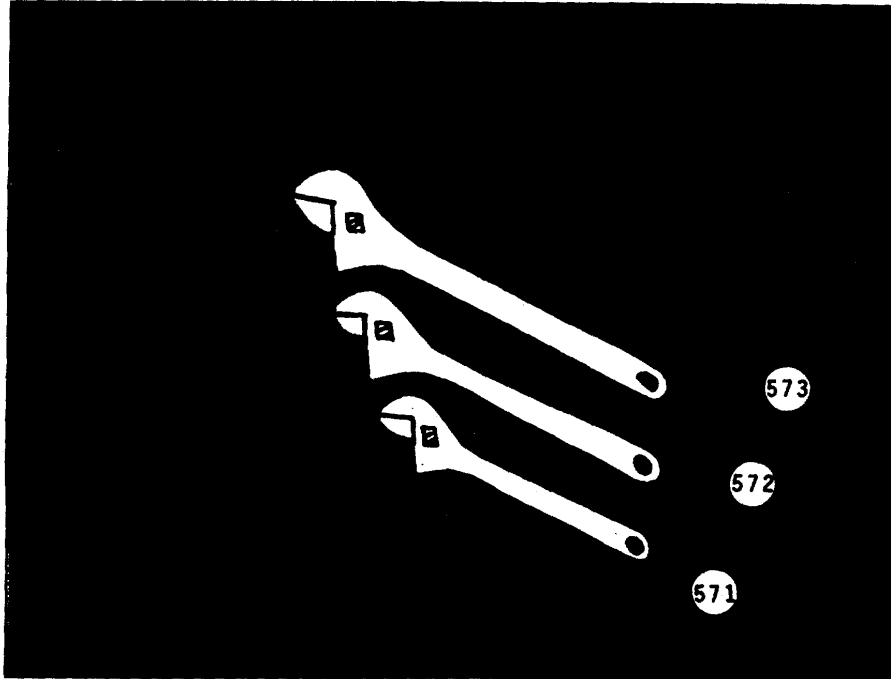

(1) ILLUS NO.	(2) NATIONAL STOCK NUMBER	(3) DESCRIPTION FSCM AND PART NUMBER	USABLE ON CODE	(4) U/M	(5) QTY RQR
571	5120-00-24-5328	GGG-W-631 Type C Class A Size 8	Wrench, (81348) Adjustable 7 1/2-8 1/2	EA	2
572	5120-00-449-8083	GGG-W-631 Type C Class A Size 10 (81348)	Wrench, Adjustable 9 1/2 10 1/2 inch	EA	2
573	5120-00-264-3796	GGG-W-Type C Class A Size 12 (81348)	Wrench, Adjustable 11 1/2- 12 1/2 inch	EA	2

SECTION III. BASIC ISSUE ITEMS LIST (CONTINUED).

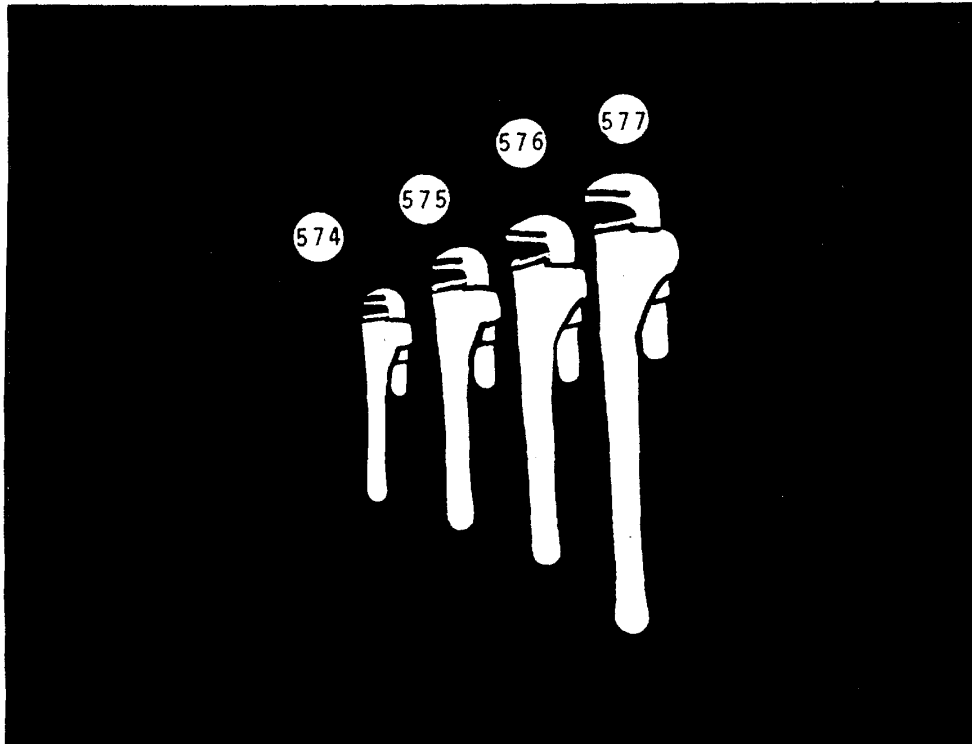

(1) ILLUS NO.	(2) NATIONAL STOCK NUMBER	(3) DESCRIPTION FSCM AND PART NUMBER	(4) USABLE ON CODE U/M	(5) QTY RQR
574	5120-00-277-1484	GGG-W-651 Type 2, Class A (81348)	Wrench Pipe 8 inch	EA 1
575	5120-00-277-1485	GGG-W-651 Type 2, Class A (81348)	Wrench Pipe 10 inch	EA 1
576	5120-00-277-1486	GGG-W-651 Type 2, Class A (81348)	Wrench Pipe 14 inch	EA 2
577	5120-00-277-1461	GGG-W-651 Type 2, Class A (81348)	Wrench Pipe 18 inch	EA 2

**SECTION III. BASIC ISSUE ITEMS LIST
(REFERENCE PUBLICATIONS).**

	DESCRIPTION
TM 55-1905-219-20P	Organizational, Repair Parts and Special Tools List for Landing Craft, Utility, Design LCU 1671 (NSN 1905-01-009-1056).
TM 55-1905-219-34P	Direct Support and General Support Repair Parts and Special Tools for Landing Craft Utility, Design LCU 1671 (NSN 1905-01-009-1056).
TM 55-1905-219-14	Operators and Organizational Direct Support and General Support Maintenance Manual: Landing Craft, Utility, Design LCU 1671 (NSN 1905-01-009-1056).
TM 9-6140-200-12	Operator and Organizational Maintenance Manual for Lead Acid Storage Battery.
TM 11-5820-401-12	(Sep 72) Operators and Organizational Maintenance Manual Including Repair Parts and Special Tools Lists: Radio Set AN/VRC-46 (NSN 5820-00-223-7433) and AN/VRC-47 (NSN 5820-223-7434).
TM 11-5820-401-ESC-2	(May 75) Equipment Service Ability Criteria for Radio Set AN/VRC-46 (NSN 5820-00-223-7433).
TM 11-5820-401-ESC-4	(May 75) Equipment Serviceability Criteria for Radio Set AN/VRC-47 (NSN 5820-00-223-7434).
TM 11-5820-820-12	(Aug 74) Operator and Organizational Maintenance Manual Including Repair Parts and Special Tools List: Radio Set AN/URC-80(v)1 (NSN 5820-00-097-0082) Change 11.
TM 11-5915-224-14	(Jan 73) Operators Organizational Direct Support and General Support Manual Including Repair Parts and Special Tools List. Suppressor, Electrical Transient MX7778/GRC. Changes 1 and 2. (NSN 5915-00-431-6718).
TM 11-5915-224-24P	Organizational, Direct Support and General Support Repair Parts and Special Tools List Including Depot Maintenance Repair Parts and Special Tools. For Suppressor, Electrical Transient MX7778/GRC. (NSN 5915-00-431-6718).
TM 11-5820-640-15	(May 69) Operators, Organizational, Direct Support, General Support and Depot Maintenance Manual: Radio Set AN/URC 10, Changes 1-5.
TM 11-5820-800-12	(Nov 73) Operators and Organizational Maintenance Manual Including Repair Parts and Special Tools List: Radio Set AN/PRC 90 NSN 5820-00-782-5308. Changes 1 and 2.

**SECTION III. BASIC ISSUE ITEMS LIST
(REFERENCE PUBLICATIONS).**

	DESCRIPTION
TM 11-6125-252-15	(Jul 71) Operator's, Organizational, DS, GS, and Depot Maintenance Manual Including Repair Parts and Special Tools Lists: Motor-Generator PU-724/G
TM 55-501	Sep 72) Marine Crewman's Handbook. Change 1.
TM 55-503	(Jul 66) Marine Salvage and Hull Repair. Change 1.
TM 55-509	(Mar 71) Marine Engineman's Handbook.
TM 746-186	(May 76) Procedures for Rapid Deployment, Redeployment and Retrograde for Floating Equipment.
TB 55-1900-20TB 5-4200-200-10	(Apr 77) Hand Portable Fire Extinguishers Approved for Army Users.
TB 55-1900-202-12/1	(Oct 64) U.S. Army Mobility Equipment Center Floating Craft: Preventive Maintenance.
TB 55-1900-204-24	(Apr 74) ARC Welding on Water Borne Vessels.
TB 55-1900-205-24	(Jan 77) Watercraft Information and Reporting System (WIRS) Data Collection for Configuration Control.
TB 55-1900-206-14	(Jan 75) Control and Abatement of Pollution by Army Watercraft.
TB 55-1900-207-24	(Jul 74) Treatment of Cooling Water in Marine Diesel Engines.
TB-TC15-17	(Dec 75) In-Service Testing of Engine Lubricating Oil.
TB 43-0144	(Jun 74) Painting of Vessels.
LO 55-1905-219-12	Landing Craft, Utility, Boston Marine Corporation. Hull Numbers 1667-1670 (NSN 1905-00-168-5764).
Change 5 C-119	

APPENDIX C
Section IV. BASIC ISSUE ITEMS LIST
Firefighting, Safety, and Damage Control Items

(1) ILLUS NUMBER	(2) NATIONAL STOCK NUMBER	(3) DESCRIPTION CAGEC AND PART NUMBER	(4) USABLE U/I ON CODE	(5) QTY RQR
	4210-00-209-5023	Adapter, 1-1/2n National Pipe Thread to 1-1/2" National Standard Thread	EA	2
	6840-01-315-9841	Bacteriostatic Additive, (Eye and Face Wash Fountain)	BX	1
		FIRE FIGHTERS ENSEMBLE		
	8460-00-606-8366	Bag, Fire Fighter Ensemble	EA	6
	8430-00-753-5935	Boots, Size 5	PR	6
	8430-00-753-5936	Boots, Size 6	PR	6
	8430-00-753-5937	Boots, Size 7	PR	6
	8430-00-753-5938	Boots, Size 8	PR	6
	8430-00-753-5939	Boots, Size 9	PR	6
	8430-00-753-5940	Boots, Size 10	PR	6
	8430-00-753-5941	Boots, Size 11	PR	6
	8430-00-753-5942	Boots, Size 12	PR	6
	8430-00-753-5943	Boots, Size 13	PR	6
	8430-00-753-5944	Boots, Size 14	PR	6
	8430-00-753-5945	Boots, Size 15	PR	6
	8415-01-300-6557	Coverall, Medium	EA	3
	8415-01-300-6558	Coverall, Large	EA	2
	8415-01-300-6559	Coverall, X-Large	EA	1
	8415-01-267-9661	Gloves, Anti-Flash	PR	6
	8415-01-335-7902	Gloves, Medium	PR	3
	8415-01-335-7903	Gloves, Large	PR	2
	8415-01-335-7904	Gloves, X-Large	PR	1
	8415-01-271-8069	Helmet	EA	6
	8415-01-268-3473	Hood, Anti-Flash	EA	6
	4220-00-276-8926	Buoyant Vest, Work Type	EA	6
	NA	Burn Dressing Kit, Contains two 8" X 18", one 4"X 16", four 4"X4", one 12"X 16" (Face Mask) Dressings, and one Package of Burn-jel Topical Dressing, (No NSN, Local Purchase Item). Ordering Informa- tion: "Water-jel AWK Kit", H & H. Associates Inc., P.O. Box 4469, Alexan- dria, VA22303, Phone: 1-800-326-5708	KT	1
	4240-00-238-9959	Canister, Training	EA	2
	4240-01-159-1986	Canister, Training, Locker	EA	1

APPENDIX C
Section IV. BASIC ISSUE ITEMS LIST
Firefighting, Safety, and Damage Control Items

(1) ILLUS NUMBER	(2) NATIONAL STOCK NUMBER	(3) DESCRIPTION CAGEC AND PART NUMBER	(4) USABLE ON CODE	(5) U/I QTY RQR
	2720-00-227-7225	Duct, 8" Dia. X 15' Long, With Carrier	EA	2
	4240-01-116-9888	Emergency Escape Breathing Device (EEBD)	EA	22
	NA	Emergency Position Radio Beacon (EPIRB), Category 1, 406 MHz Satellite, F.C.C. Approved (No NSN, Local Purchase Item)	EA	1
	4240-00-542-2048	Face Shield, Industrial, Tilting	EA	3
	4210-00-142-4949	Fire Ax	EA	6
	NA	Fire Blanket, 72" X 60", (No NSN, Local Purchase Item). Ordering Information: "Water-jel AWK Fire Blanker, H & H Associates Inc., PRO. Box 4469, Alexandria, VA 22303, Phone: 1-800-326-5708	EA	1
	4210-00-889-2491	Fire Extinguisher, Portable, 10lb., USCG Approved	EA	19
	4820-00-540-2381	Foot Valve with Strainer, 3" ID	EA	1
	4240-01-258-1245	Fountain, Eye and Face Wash, 16 Gal.	EA	1
	4240-00-190-6432	Goggle, Industrial, No Vents, (Chemical Flash)	EA	1
	4240-00-052-3776	Goggle, Safety, Vented, Clear	EA	15
	8415-00-935-3136	Hardhat, Orange	EA	10
	8415-00-935-3139	Hardhat, White	EA	5
	4240-00-022-2522	Harness, Safety, Torso	EA	6
	4240-00-540-0632	Helmet, Welder's	EA	1
	2040-00-268-9250	Hook, Boat	EA	2
	4210-00-776-0657	Hose, Exhaust, Engine, 2" ID X 20' Long	EA	1
	4210-01-131-0249	Hose, Fire, 1 1/2" X 50', Orange	EA	10
	4210-01-131-0247	Hose, Fire, 2 1/2" X 50', Orange	EA	4
	4210-01-248-8822	Hose, Potable Water, 1 1/2" X 50', Blue	EA	3
	4210-00-725-9234	Hose, Exhaust, Suction, 3" ID X 10' Long	EA	1
	NA	Hydrostatic Release Unit, Hammar H20, Liferaft (No NSN, Local Purchase Item), Hammar H20, MPN 6D887, Part Number HA2000H	EA	2
	8415-00-268-8264	Jacket, Welder's	EA	1
	6545-01-155-1598	Kit, Flotation Assembly, Includes two Flotation Tubes with Covers, five Restraint Straps, and one five pound Ballast Bar	KT	1

APPENDIX C
Section IV. BASIC ISSUE ITEMS LIST
Firefighting, Safety, and Damage Control Items

(1) ILLUS NUMBER	(2) NATIONAL STOCK NUMBER	(3) DESCRIPTION CAGEC AND PART NUMBER	(4) USABLE ON CODE	(5) U/I QTY RQR
	4730-00-542-3359	Kit, Pipe Repair, Emergency, P/N MIL-4-17882B (81349)		KT 1
	4240-00-022-2518	Lanyard, Safety Harness		EA 6
	4240-00-022-2521	Lanyard, Safety Harness, Dyna Brake		EA 4
	4010-00-285-9901	Life Line, OBA Tending		EA 2
	5510-00-260-8953	Plug, Soft Wood, 1" X 0" X 3" Long		EA 10
	5510-00-260-8958	Plug, Soft Wood, 2" X 0" X 4" Long		EA 10
	5510-00-260-8962	Plug, Soft Wood, 3" X 0" X 8" Long		EA 10
	5510-00-260-8969	Plug, Soft Wood, 7" X 3" X 10" Long		EA 10
	5510-00-260-8973	Plug, Soft Wood, 8" X 4" X 10" Long		EA 5
	5510-00-260-8949	Plug, Soft Wood, 10" X 7" X 12" Long		EA 5
	4220-00-275-3157	Ring Buoy, Life Saving, 30"		EA 8
	2090-00-052-1581	Shoring, Steel, Adjustable, Long, 6' to 11'		EA 5
	2090-00-058-3737	Shoring, Steel, Adjustable, Short, 3' to 5'		EA 5
	1670-01-226-5300	Sling, Rescue Helicopter Hoisting		EA 1
	9390-01-078-8660	Tape, Retro Reflective, 3" X 50 yds		RL 1
	9390-01-082-8927	Tape, Retro Reflective, 1" X 50 yds		RL 1
	4240-01-116-9889	Training Unit, EEBD		EA 1
	5510-00-268-3479	Wedge, Plug, Tapered, Hardwood, 2"X2" X 8" Long		EA 10
	5510-00-268-3485	Wedge, Plug, Tapered, Hardwood, 4"X2" X 8" Long		EA 10
	5510-00-268-3481	Wedge, Plug, Tapered, Hardwood, 3"X3" X 12" Long		EA 10
	5510-00-268-3475	Wedge, Shoring, Tapered, Hardwood, 1 1/2" X 2"X12" Long		EA 10
	5510-00-268-3476	Wedge, Shoring, Tapered, Hardwood, 1 1/2" X 3"X12" Long		EA 10
	5120-00-277-9075	Wrench, Spanner, Adj 1 1/2"to 3"		EA 10
	5120-00-277-9076	Wrench, Spanner, (P-250 Pump)		EA 10

APPENDIX C
SECTION V. BASIC ISSUE ITEMS LIST
COMMUNICATIONS, ELECTRONIC, NAVIGATION (CEN) COMMERCIAL
TECHNICAL MANUALS AND PUBLICATIONS

NUMBER	DESCRIPTION/TITLE
	Alden Electronics SATFIND-406 M3 EPIRB Owner's Manual
	Alden TR-IV Marinefax Technical Manual and Operator's Manual
Instruction Book No. 71261 Rev. C and Instruction Book Cat. No. 120 and 122 No. 509754	Belfort Instrument Company Aerovane Indicator Model 135
	Bendix/King EPH/EPI Series Portable Radio Owner's Manual
	Bendix/King EPH Series Portable Radio Service Manual
	Bendix/King LAA Series Battery Chargers Service Manual
	Dymek DA1 OOD All Wave Receiving Antenna Owner Information Manual
	Mackay Communications 403A Emergency Lifeboat Transceiver Instruction Manual
	Naval Electronics Inc. MK22CA/Pba 2205 System Installation and Service Manual
	Newmar Heavy Duty DC-DC Converters Operation and Installation Instructions
RMC Document Number G261404 Rev A	Raytheon Marine Company Radar Set Model R40X/R41 X AN/SPS-69 Description, Operation and Maintenance Technical Manual
	Ross Engineering DSC 500 Digital Selective Call Marine VHF Transceiver Operating Manual
TM-8080000701	Sunair Electronics, Inc. Digital Automatic Antenna Coupler DCU-100 Operation and Maintenance Manual

**APPENDIX D
ADDITIONAL AUTHORIZATION LIST.**

SECTION I. INTRODUCTION.

D-1. SCOPE

This appendix lists additional items you are authorized for the support of the Landing Craft.

D-2. GENERAL

This list identifies items that do not have to accompany the Landing Craft and that do not have to be turned in with it. These items are all authorized to you by CTA, MTOE, TDA, or JTA.

D-3. EXPLANATION OF LISTING

National stock numbers, descriptions, and quantities are provided to help you identify and request the additional items you require to support this equipment. The items are listed in alphabetical sequence by item name under the type document (i.e., CTA, MTOE, TDA, or JTA) which authorizes the item(s) to you.

SECTION II. ADDITIONAL AUTHORIZATION LIST

(1) NATIONAL STOCK NUMBER	(2) DESCRIPTION		(3)	(4)
	FSCM AND PART NUMBER	USABLE ON CODE	U/M	QTY AUTH
	No Ref (33333) Adapter, Hose, 1 1/2 Female to 2 1/2 Male		ea	1
4210-00-684-3997	800E1337 (02413) Adapter, Hose, Swivel, Female 1 1/2 to 2 1/2		ea	1
5120-00-293-0665	3257A (81348) Bar, Wrecking, 30 inches		ea	6
6140-00-234-7360	75 (72583) Battery Filler, Jug Type		ea	1
7510-00-889-3494	B43064 (81349) Binder, Looseleaf		ea	2
7195-00-224-5190	No Ref (33333) Board, Bulletin, Type A		ea	1
7195-00-224-5191	S3209-638101 (80064) Board, Bulletin, Type B		ea	1
7330-00-078-5706	LLL-B-568 (81348) Board, Food Chopping		ea	1
	8051749061 (81349) Book Rack, Type C (Modified to 30 inches width)		ea	2
7350-00-251-8746	L-T-48 (81348) Bowl, Eating Plastic		ea	14
7330-00-241-8168	B-2054 (81348) Bowl, Mixing w/cover, 7 1/2 Qt.		ea	1
	805-1636842 (80064) Cabinet, Filing, Stl, 4 Drawers w/Combination Lock		ea	1
7125-00-132-8973	S3209921643 (81348) Cabinet, Key, 75 Key		ea	1
5120-00-229-3054	GGG-C-105, Type 1 (81348) Caliper, Micrometer, 2-12 inch		ea	1
7105-00-663-5688	AA-C-291, Type 1, Class 2, (81348) Chair, Folding		ea	1
7110-00-273-8782	AA-C-275 (81348) Chair, Straight, W/Arms		ea	2
5110-00-554-7345	GG-C-313 Chisel, (81348) Cape, 6 3/4 in. x 1/4 in.		ea	2
5120-00-529-3744	GGG-C-406, Type 1, Class A (81348) Clamp, "C", Heavy		ea	2

SECTION II. ADDITIONAL AUTHORIZATION LIST

(1) NATIONAL STOCK NUMBER	(2) DESCRIPTION		(3)	(4)
	FSCM AND PART NUMBER	USABLE ON CODE	U/M	QTY AUTH
5940-00-195-9689	PP-10921 (80249) Clip, Elcl, Crocodile, 3 1/4 inches Long		ea	4
	MIL-C-1194 (81348) Clock, Mechanical, 12 hr. Battery Oper		ea	6
	CH2Y-M (14718) Coffee Maker, 2 Burner Electric Plate 12 OV AC		ea	1
4310-01-085-2032	FM10 (11568) Compressor, Air, Portable, Electric Motor Driven		ea	1
5110-00-188-2524	GGG-C-740 (81348) Cutter, Bolt, 36 inches Long		ea	1
5110-00-293-0460	GGG-C-171, Type 1, Class A Cutter, Pipe 1/8 inch-2 inches		ea	1
5110-00-541-1644	GGG-T-330 (81348) Cutting & Flaring Set, Tubing		ea	1
4510-00-585-6305	WW-P-541 (81348) Dispenser, Paper Towel		ea	1
-	SK-1 IMP (12864) Dispenser, Milk, 5 Gallon Refrigerated		ea	1
-	No Ref (33333) Flag Bag, Portable, Aluminum, 20 Gage 27 1/2 x13 x 26, Hinged, 72 Compart-		ea	1
-	ments 3 x 3 1/2 x 13, w/Lock & Handles			
7340-00-223-7791	U-10815, Type 1, Size 1 (81348) Fork, Cooks, Food Preparation 15 inches Long, 2 times		ea	1
	DDP12N (19177) Fountain, Drinking Size 10		ea	1
7240-00-527-9868	RR-F-800 (81 48) Funnel, Steel, W/Strainer, 1 Qt		ea	2
5120-00-992-5485	GG-M-B6, Type 1, Class 1-Hammer, Carpenter 1 Lb		ea	1
5120-00-243-2957	GGG-H-86 (81348) Hammer, Hand, Scaling, 1 Lb		ea	4
5120-00-243-2957	GGG-H-86 (81348) Hammer, Sledge, 10 Lb		ea	1

SECTION II. ADDITIONAL AUTHORIZATION LIST

(1) NATIONAL STOCK NUMBER	(2) DESCRIPTION FSCM AND PART NUMBER USABLE ON CODE	(3) U/M	(4) QTY AUTH
		7920-00-246-0930	NN-H-101, Type II, Class 1 (81348) Handle, Mop, 54 inches Long
3940-00-937-7978	MIL-S-23566 (81348) Heater, Immersion, Elcl, 2 inches IPS Vertical 1.2 & 1.0 KW, 120V AC	ea	1
4720-00-288-8532	115R (93601) Hoist, Lever/Ratchet, 1000 Lb Cap	ea	2
	ZZ-H-001 (81348) Hose, Assembly, (Fresh Water Fill) 1 1/2 x 50 feet	ea	2
	CG3264 (75324) Kit, Service, Line Throwing Device	ea	1
6210-00-153-6668	MS17114-1 SYM 229 (96906) Light, Berth	ea	14
	MIL-STD-16719 Light, Desk, Chart Table (W/Filter Assembly MIL-STD-16721)	ea	1
	S3605-630718 (80064) Locker, Cleaning Gear, Aluminum	ea	1
	805-1363771 (80064) Locker, Fuse, Aluminum 15 x 11 3/8	ea	1
	805-1360106 & 805-1360107 (80064) Locker, Hand Grenade, Aluminum, 26 1/8 x 13 15/16	ea	1
	805-1629989 (80064) Locker, Life Jacket	ea	1
2090-00-368-4792	No Ref 33333 Locker, Medical First Aid Box	ea	2
	No Ref 33333 Locker, OBA Storage, Type A	ea	2
	805-1360275 (80064) Locker, Pyrotechnic	ea	1
2090-00-243-2362	S3209860212 (80064) Locker, Safe, No. 7	ea	1
	805-1626432 (80064) Locker, Type B-1, Aluminum, 3 high, 12 openings	ea	4
	805-1400-952 (80064) Locker, Type K	ea	1

SECTION II. ADDITIONAL AUTHORIZATION LIST

(1) NATIONAL STOCK NUMBER	(2) DESCRIPTION		(3)	(4)
	FSCM AND PART NUMBER	USABLE ON CODE	U/M	QTY AUTH
	S3605 860080 (80064) Locker, Wash Deck Gear		ea	1
4930-00-253-2478	G-38590 (81349) Lubricating Gun, Hand, 16 Oz		ea	3
5120-00-221-2731	M-15926, Type 1 (81348) Marline spike, 8 inches		ea	2
	4M-155 (crane co.) Mirror, w/shelf 2 pc combination, plate glass		ea	4
	805-1636410 (80064) Modular Group 14		ea	1
	805-1637731 (80064) Modular Group 8			
4930-00-266-9182	GGG-0-591 (81348) Oiler, Hand, 8 Oz.		ea	3
7330-00-272-2590	FF-0-591 (81348) Opener, Can, Elcl, PTb1		ea	1
5340-00-582-2742	NS35647-1 (96906) Padlock, Keyed		ea	60
7330-00-205-3164	RR-P-54, Type 1 (81348) Pan. Baking & Roasting, 13 1/4 x 9 1/4 x 2 1/4		ea	1
7330-00-205-3150	RR-P-62 (81348) Pan, Cake, Round, 9 x 11 3/8		bx	1
7210-00-268-8675	V-P-356 (81348) Pillow, Bed		ea	14
7210-00-231-2373	DDD-P-351 (81348) Pillowcase, Bed		ea	28
7330-00-205-4146	RR-3-500 (81348) Pot, Cooking, w/Cover, 14 qt.		ea	1
7330-00-263-8505	RR-B-500 (81348) Pot, Cooking, no Cover, 24 qt.		ea	1
5120-00-243-2776	WW-P-796 (81348) Puller, Fuse, #3		ea	4
5120-00-595-9304	GGG-P-781 (81348) Puller, Mechanical, Gear 0-6 inch		ea	1
5110-00-449-7313	HP (45225) Punch Set, Gasket Cutting		ea	1
	HR200 (78790) Range, Elcl, Type B. 12 KW, 440Y		ea	1
7240-00-965-4427	L-W-25 (81348) Receptacle, Waste, w/Cover, 10 Gallon		ea	1

SECTION II. ADDITIONAL AUTHORIZATION LIST (Cont.)

(1) NATIONAL STOCK NUMBER	(2) DESCRIPTION		(3)	(4)
	FSCM AND PART NUMBER	USABLE ON CODE	U/M	QTY AUTH
7240-00-857-2277	L-W-25, Class A, Size 4 (81348) Receptacle, Waste w/cover, 24 Gallon		ea	2
	MLH-10-IOAD-U (89729) Refrigerator/Freezer		ea	2
7510-00-161-6215	GG-R-791 (81348) Ruler, Wood, 12 inches		ea	1
7520-00-162-6178	F-S-58 (81348) Sharpener, Pencil		ea	5
5110-00-161-6909	GGG-S-278 (81348) Shears, General Purpose		ea	3
	S3209-921650 (80064) No Ref (33333) Shelf, Plastic Top, Writing, Hinged, Steel		ea	1
3439-00-930-1638	450 (11103) Soldering Gun, Elcl, Trigger Opr.		ea	1
7240-00-177-6154	S-1285 (81349) Spout, Flexible		ea	5
7250-00-298-7043	RR-S-714 (81348) Stencil Set, Marking, 1 inch Letters		ea	1
7110-00-634-8596	AA-S-700 (81348) Stool, Wood, Revolving		ea	1
7310-00-224-9192	IBB4 (78770) Toaster, Elcl, Automatic, 4 Slice, 115 V, 60 Hz, Single Phase		ea	4
3439-00-542-0531	GGG-T-570 (81348) Torch Kit, Soldering L.P Gas		ea	1
7350-00-195-7334	T-46D (81349) Tray, Mess, Cres, 6 Compartments		ea	14
7350-00-823-7301	T-43259 (81349) Tray, Service		dz	1
7430-00-254-4321	No Ref (33333) Typewriter, Office Non-portable		ea	1
5120-00-221-1117	GGG-V-410 (81348) Vise, Machinist, 5 inch Jaw		ea	1
5120-00-288-6518	GGG-V-415 (81348) Vise, Pipe		ea	1
	LC2 (23671) Washer/Dryer, 110/115 V AC, White		ea	1
6605-00-273-6985	S-3717 (81348) Weight, Sounding, 7 Lb		ea	1
5120-00-293-0317	GGG-W-651, Type II, Class A (81348) Wrench, Pipe, Adjustable, 24 inches		ea	1

**APPENDIX D
Section II. ADDITIONAL AUTHORIZATION LIST
(CONTINUED)**

(1) ILLUS NUMBER	(2) NATIONAL STOCK NUMBER	(3) DESCRIPTION CAGEC AND PART NUMBER	USABLE ON CODE	(4) U/I	(5) QTY RQR
	5120-00-935-7333	OEXM709 (00770) Wrench Set, Combination Box and Open End, Metric		EA	1
	5130-00-081-2308	GGG-W-614 (81348) Wrench Set, Socket,.3/4 inch Drive		EA	1
	5120-00-132-0399	VM-820 (95021) Wrench Set, Socket Insert (For converting standard socket to metric sizes)		SE	1
	7910-00-530-0260	MIL-C-52074A, Type 1 (81349) Cleaner, Vacuum, Industrial Type, 120 V, 400 Hz		EA	1
		23-7245 (05083) Alarm, Gas, Oxygen With Probe		EA	1
		GE-V8(27020) Blower, Ventilating, Portable		EA	1
		160 016/212 (01752) Lamp, Flame Safety		EA	1
	4220-00-020-0538	MIL-L-18045 (81349) * Life Preserver, Vest (for Passengers)		EA	AR
	1005-00-879-2819	2663138 (53711)Gun Mount		EA	4
		5184210 (53711) Amo Locker * Order only amount needed for amount of passengers to be carried.		EA	1

*U.S.GOVERNMENT PRINTING OFFICE: 1994 -555-028/00343

APPENDIX E

EXPENDABLE SUPPLIES AND MATERIALS LIST

SECTION I. INTRODUCTION.

E-1. SCOPE

This appendix lists expendable supplies and materials you will need to operate and maintain the Landing Craft. These items are authorized to you CTA 50-970, Expendable Items (Except Medical, Class V, Repair Parts, and Heraldic Items).

E-2. EXPLANATION OF COLUMNS

- a. Column 1 - Item number.
- b. Column 2 - Level. This column identifies the lowest level of maintenance that requires the listed item.

C - Operator/Crew

F - Direct Support Maintenance

H - General Support Maintenance
- c. Column 3 - National Stock Number. This is the National stock number assigned to the item, use it to request or requisition the item.
- d. Column 4 - Description. Indicates the Federal item name and, if required, a description to identify the item. The last line for each item indicates the Federal Supply Code for Manufacturer (FSCM) in parentheses followed by the part number.
- e. Column 5 - Unit of Measure (DIM). Indicates the measure used in performing the actual maintenance function. This measure is expressed by a two-character, alphabetical abbreviation (e.g., ea. in, pr). If the unit of measure differs from the unit of issue, requisition the lowest unit of issue that will satisfy your requirements.

(1) ITEM	(2) LEVEL	(3) NATIONAL STOCK NO.	(4) DESCRIPTION	(5) U/M
1	C	6810-00-249-9354	Acid, Sulfuric (Electrolite) O-S-801 (81348)	8 gal
2	C		Antifreeze, Arctic Solution No Ref (33333) MIL-A-11755 (81349)	AR
3	C	6850-00-181-7929	Antifreeze, Ethylene Glycol, Inhibited, Heavy Duty 1 Gal Can MIL-A-46153 (81349)	AR
4	C	6850-00-181-7933	Antifreeze, Ethylene Glycol, Inhibited, Heavy Duty 5 Gal Can MIL-A-46153 (81349)	AR
5	C	6850-00-181-7940	Antifreeze, Ethylene Glycol, Inhibited, Heavy MIL-A-46153 (81349) 55 Gal Drum	AR
6	C	7520-00-281-5911	Basket, Waste Paper RR-B-181 (81349)	5 ea
7	C	6135-00-050-3280	Battery, Dry Cell, 6V BA200U (81350)	24 ea
8	C	6140-00-057-2553	Battery, Dry Storage, 12V U/O Portable Megaphone MS35000-1 (96906)	1 ea
9	C	6135-00-050-3280	Battery, Emergency Light BA-200U (81350)	6 ea
10	C	6135-00-120-1020	Battery, Flashlight, BA-30 (80063) (24 Box)	4 bx
11	C	6140-00-234-7360	Battery, Filler, Jug Type 75 (72583)	1 ea
12	C	3940-00-239-8769	Block, Tackle, Fr., 6 inches	2 ea
13	C	3940-00-068-9173	Block, Tackle, Fr., 8 inches	2 ea
14	C	7330-00-078-5706	Board, Food Chopping LL-B-563 (81348)	2 ea
15	C	6830-00-729-4377	Bottle, Freon 12, BB-F-421 (81348)	1 ea
16	C	7350-00-251-8746	Bowl, Eating, Plastic L-T-48 (81348)	14 ea
17	C	7330-00-685-5013	Bowl Set, Food Mixing RR-B-1242 (81348)	1 ea
18	C	7330-00-262-2323	Bowl, Mixing, 5 Qt MIL-B-2054 (81349)	1 ea

(1) ITEM	(2) LEVEL	(3) NATIONAL STOCK NO.	(4) DESCRIPTION	(5) U/M
19	C	7920-20-291-8305	* Broom, Push, Rattan (no handle) H-B-71 (81348)	2 ea
20	C	7920-00-291-8305	Broom, Upright, Corn H-B-51 (81348)	5 ea
21	C	7920-00-240-6358	Brush, Dusting, Bakery, H-B-190 (81348)	6 ea
22	C	7920-00-243-3407	* Brush, Floor Sweeping, 18 inches (no handle) H-B-651 (81348) * Handles are to be provided at time of vessel activation.	2 ea
23	C	7920-00-772-5800	Brush, Sanitary H-B-481 (81348)	2 ea
24	C	7920-00-240-7171	* Brush, Scrub, SQ End Deck (no handle) H-B-531 (81348)	4 ea
25	C	7920-00-240-7174	Brush, Scrub, Flr Hand H-B-1490 (81348)	2 ea
26	C	7920-00-291-5815	Brush, Wire, Curved Handle H-B-178, Type II, Class 1 (81348)	4 ea
27	C	7920-00-246-8501	Brush, Wire, 7 1/2 inch	2 ea
28	C	5130-00-293-0263	Brush, Wire, Rotary Wheel, 1/2 in. Arbor H-B-771, Type III, Class L (81348)	2 ea
29	C	7330-00-550-7592	Butchers Steel, 10 inches long	1 ea
30	C	7240-00-256-7700	Can, Flammable Waste, 10 Gal RR-C-114 (81348)	2 ea
31	C	7240-00-178-8288	Can, Gasoline, 5 Gal RR-S-30, Style 2 (81348)	2 ea
32	C	5120-00-529-4124	Carrier, Storage Battery, Size 20, MIL-C-19482 (81349)	1 ea
33	C	5940-00-195-9689	Clip, elcl Crocodile, 3 1/2 in. long PP-10921 (80249)	4 ea
34	C	7520-00-240-5503	Clipboard, File LLL-A-00650 (81348)	3 ea

(1) ITEM	(2) LEVEL	(3) NATIONAL STOCK NO.	(4) DESCRIPTION	(5) U/M
35	C	8030-00-307-8630	Compound Antisieze MIL-T-83483 (81349) (pipe joint & thread)	2 lb
36	C	7930-00-880-4454	Compound, Dishwashing, Hand Liquid P-D-410 (81348)	5 ea
37	C	4020-00-240-2164	Cord, Cotton 1/4 inch 200 ft. coil	1 coil
38	C	4020-00-240-2160	Cord, Cotton, 5/16 inch, 1200 ft. coil T-C-571 (81348)	1 coil
39	C	7350-00-935-6635	Crust, Condiment, 6 oz., DD-T-101 (81348)	3 ea
40	C	7350-00-823-7563	Cup, Drinking, Glass, 10 1/2 oz DD-T-90 (81348)	14 ea
41	C	7350-00-823-7394	Cup, Drinking, Glass, 6 1/2 oz DD-T-90 (81349)	14 ea
42	C	7350-00-223-7760	Cup, Drinking, Plastic 10 oz L-T-48, Class 2 (81348)	14 ea
43	C	7230-00-849-9839	Curtain, Shower, 48 inches x 72 in. t-C-780 (81348)	4 ea
44	C	7330-00-633-8904	Cutter, Doughnut, Stl, 3 inch MIL-C-40115 (81349)	2 ea
45	C	6830-00-584-3041	Cylinder, Replacement, Propane EB-G-110 (81348)	2 ea
46	C	7330-00-373-2488	Dipper, Kitchen, 1/2 qt. RR-D-400 (81348)	1 ea
47	C	7350-00-823-7398	Dish, Sauce, 5 9/16 inches Dia DD-T-90 (81348)	14 ea
48	C	5345-00-881-8378	Disk, Abrasive, #24 PD-455, Type 1, Class 1 (81348)	6 ea
49	C	5345-00-581-8377	Disk, Abrasive, #36 PD-455, Type 1, Class 1 (81348)	6 ea

(1) ITEM	(2) LEVEL	(3) NATIONAL STOCK NO.	(4) DESCRIPTION	(5) U/M
50	C	5345-00-881-8375	Disk, Abrasive, #60 PD-455, Type 1, Class 1 (81348)	6 ea
51	C	7330-00-190-5190	Dish Pan, Round, 10 qt. RR-D-450 (81348)	1 ea
52	C	7350-00-205-0928	Dispenser, Napkin RR-D-500 (81348)	3 ea
53	C	7350-00-641-6050	Dispenser, Sugar, 12 pz. DD-T-101 (81348)	3 ea
54	C	7330-00-305-3154	Double Boiler, Cooking, 3 qt. RR-B-500, Style A (81348)	1 ea
55	C	7330-00-984-4065	Double Boiler, Cooking, 5 1/2 qt. RR-B-500 Style B (81348)	1 ea
56	C	7290-00-224-8308	Dustpan, RR-D-800 (81348)	7 ea
57	C	7330-00-243-3408	Egg Beater, RR-E-300, Type 1 (81348)	1 ea
58	C	7330-00-815-1458	Egg Whip, RR-W-456, Size 3 (81348)	1 ea
59	C	8345-00-935-0445	Flag, Signal, "A" Intn'l Code, 512E6 MIL-F-2692	1 ea
60	C	8345-00-926-6803	Flag, Signal, "B" Intn'l Code, Size 6 MIL-F-2692 (81349)	1 ea
61	C	8345-00-935-0446	Flag, Signal, "C" Intn'l Code, Size 6 MIL-F-2692 (81349)	1 ea
62	C	8345-00-926-6805	Flag, Signal, "D" Intn'l Code, Size 6 MIL-F-2692 (81349)	2 ea
63	C	8345-00-935-0447	Flag, Signal, "E" Intn'l Code, Size 6 MIL-F-2692 (81349)	1 ea
64	C	8345-00-926-9218	Flag, Signal, "F" Intn'l Code, Size 6 MIE-F-2692 (81349)	1 ea
65	C	8345-00-926-9987	Flag, Signal, "G" Intn'l Code, Size 6 MIL-F-2692 (81349)	1 ea

(1) ITEM	(2) LEVEL	(3) NATIONAL STOCK NO.	(4) DESCRIPTION	(5) U/M
66	C	8345-00-935-0448	Flag, Signal, "H" Intn'l Code, Size 6 MIL-F-2692 (81349)	1 ea
67	C	8345-00-935-0449	Flag, Signal, "I" Intn'l Code, Size 6 MIL-F-2692 (81349)	1 ea
68	C	8345-00-026-6810	Flag, Signal, "J" Intn'l Code, Size 6 MIL-F-2692 (81349)	1 ea
69	C	8345-00-926-9988	Flag, Signal, "K" Intn'l Code, Size 6 MIL-F-2692 (81349)	1 ea
70	C	8345-00-935-0450	Flag, Signal, "L" Intn'l Code, Size 6 MIL-F-2692 (81349)	1 ea
71	C	8345-00-935-0444	Flag, Signal, "M" Intn'l Code, Size 6 MIL-F-2692 (81349)	1 ea
72	C	8345-00-926-0001	Flag, Signal, "N" Intn'l Code, Size 6 MIL-F-2692 (81349)	1 ea
73	C	8345-00-935-0451	Flag, Signal, "O" Intn'l Code, Size 6 MIL-F-2692 (81349)	1 ea
74	C	8345-00-935-0452	Flag, Signal, "P" Intn'l Code, Size 6 MIL-F-2692 (81349)	1 ea
75	C	8345-00-935-0453	Flag, Signal, "Q" Intn'l Code, Size 6 MIL-F-2692 (81349)	1 ea
76	C	8345-00-926-6812	Flag, Signal, "R" Intn'l Code, Size 6 MIL-F-2692 (81349)	1 ea
77	C	8345-00-933-0454	Flag, Signal, "S" Intn'l Code, Size 6 MIL-F-2692 (81349)	1 ea
78	C	8345-00-926-6002	Flag, Signal, "T" Intn'l Code, Size 6 MIL-F-2692 (81349)	1 ea
79	C	8345-00-926-6814	Flag, Signal, "U" Intn'l Code, Size 6	1 ea
80	C	8345-00-935-0955	Flag, Signal, "V" Intn'l Code, Size 6 MIL-F-2692 (81349)	1 ea

(1) ITEM	(2) LEVEL	(3) NATIONAL STOCK NO.	(4) DESCRIPTION	(5) U/M
81	C	8345-00-935-0456	Flag, Signal, "W" Intn'l Code, Size 6 MIL-F-2692 (81349)	1 ea
82	C	8345-00-926-6004	Flag, Signal, "X" Intn'l Code, Size 6 MIL-F-2692 (81349)	1 ea
83	C	8345-00-935-0457	Flag, Signal, "Y" Intn'l Code, Size 6 MIL-F-2692 (81349)	1 ea
84	C	8345-00-935-0458	Flag, Signal, "Z" Intn'l Code, Size 6 MIL-F-2692 (81349)	1 ea
85	C		Food Turner MIL-U-10815, Class B (81349)	2 ea
86	C	7340-00-240-7077	Fork, Cook's, 14 inches GGG-C-746, Type II (81348)	2 ea
87	C	7340-00-241-8169	Fork, Table RR-F-150 (81348)	2 ea
88	C	6230-00-264-8261	Flashlight, Watertight, 2 cell, MIL-F-3746 (81349)	5 ea
89	C	9140-00-286-5283	Fuel, Diesel, Bulk, Df-A Arctic No Ref (33333)	70 bl
90	C	9140-00-286-5286	Fuel, Diesel, Bulk, DF/Winter No Ref (33333)	70 bl
91	C	9140-00-286-5294	Fuel, Diesel, Bulk, DF2 Regular No Ref (33333)	70 bl
92	C	7240-00-233-4482	Funnel, Steel, W/Strainer, D gallon RR-F-800 Type 1, Class B (81348)	2 ea
93	C	7240-00-527-9868	Funnel, Steel, W/Strainer, 1 qt RR-F-800, Type 1, Class B (81348)	2 ea
94	C	7240-00-404-9793	Funnel, Plastic, 1 qt. L-F-1593 (81348)	1 ea
95	C	4930-00-287-5419	Gun, Fluid, Direct Delivery GGG-0-591 (81348)	1 ea

(1) ITEM	(2) LEVEL	(3) NATIONAL STOCK NO.	(4) DESCRIPTION	(5) U/M
96	C	4930-00-253-2478	Gun, Grease, Hand, 14 oz. Cap MIL-C-3359C (81349)	1 ea
97	C	9150-00-190-0900	Grease, Auto & Artillery, 5 lb Can MIL-C-10924 Symbol GAA	5 lb
98	C	9150-00-663-9795	Grease, Ball & Roller Bearing, BR 5 lb. Can, MIL-G-1870g (81349)	6 ea
99	C	9150-00-530-6814	Grease, Wire Rope, Exposed, 35 lb Pail No. Ref (33333) MIL-G-18458/Ships	2 ea
100	C	4020-00-240-2161	Halyard, Cotton, Braided, 1/4 inch MIL-H-226, Class 1 (81349)	1 C1
101	C	7920-00-263-0328	Handle, Wood, Acme Thread NN-B-104, Class 1 Type 1 (81348) for Brush Floor Sweeping	2 ea
102	C	7920-00-141-5452	Handle, Wood NN-H-5154, Type 1, Class 2 (81348)	6 ea
103	C	7230-00-252-3394	Hook, Shower Curtain No Ref t33333)	18 Bx
104	C	9150-00-252-0293	Hydraulic Fluid, Automatic Trans- mission (5 Gal Can) 5GM2C41A (00501	2 Cn
105	C	4730-00-470-6625	Kit, Fitting, Copper Tubing 51025 (30320)	1 ea
106	C	340-00-223-7771	Knife, Cook's 12 inch GGG-C-746 (81348)	1 ea
107	C	7340-00-223-7769	Knife, Paring, 3 1/2 inches GGG-C-746 (81348)	1 ea
108	C	7340-00-223-7766	Knife, Slicing, 12 inches GGG-C-746 (81348)	1 ea
109	C	7340-00-543-7004	Knife, Meat, Table Kings Pattern (31121)	1 Bx
110	C	7340-00-291-0625	Knife, Steak, 10 inch GGG-C-746 (81348)	1 ea

(1) ITEM	(2) LEVEL	(3) NATIONAL STOCK NO.	(4) DESCRIPTION	(5) U/M
111	C	7340-00-241-8170	Knife, Table 10 inch RR-F-450 (81348)	1 Bx
112	C	7330-00-254-4793	Ladle, Kitchen 2 oz. RR-L-30 (81348)	3 ea
113	C	7330-00-248-1153	Ladle, Kitchen 8 oz. RR-L-30 (81348)	2 ea
114	C	6220-00-299-7146	Lens, Marine, Navigational	1 ea
115	C	6220-00-299-7151	Lens, Marine, Navigational	1 ea
116	C	7330-00-170-8342	Liner, Baking Cup MIL-L-40610 (81349)	1 ea
117	C	4020-00-240-2185	Marline, Hemp T-R-605, Type 4, Class 1, 20 1b. coil (81348)	1 C1
118	C	7330-00-205-3093	Masher, Potato, Hand RR-W-456 (81348)	1 ea
119	C	7240-00-233-6025	Measure, Liquid, 1 Gal, RR-M-1850, Type 1, Class A (81348)	3 ea
120	C	7240-00-233-6013	Measure, Liquid, 1 qt. RR-M-190, Type 1, Class B (81348)	3 ea
121	C	7330-00-272-7876	Measuring Set, 4 spoon, MIL-M-40122 (81349)	1 ea
122	C	8465-00-238-3344	Megaphone, Hand, 18 inches M-1263 (81348)	1 ea
123	C	7920-00-171-1148	Mophead, Wet, T-M-561, Type 1, Style 1 (81348)	3 ea
124	C	8540-00-285-7001	Napkin, Table, Paper No Ref (33333)	1 ea
125	C	9150-00-117-8791	Oil Lubrication (for 2 cycle engine) 2 pts per 6 gallons of gasoline	2 Cn
126	C	9150-00-257-5440	Oil, Lubrication, GOS (5 gal. can) MIL-L-10324 (81349)	5 ea
127	C	150-00-264-3941	Oil, Lubricating, PE-10 (5 gal can) No Ref (33333)	5 ea

(1) ITEM	(2) LEVEL	(3) NATIONAL STOCK NO.	(4) DESCRIPTION	(5) U/M
128	C	9140-00-405-2987	Oil, Lubricating, gear G090, Can No ref (33333)	5 Gal
129	C	9150-00-577-5844	Oil, Lubrication, Gear OE/HDO 40 (185 GL required) No Ref (33333)	5 dl
130	C	9150-00-598-2911	Oil, Lubrication, Refrigerant Compressor, 1 qt can VY-L-825 (81348)	10 ea
131	C	9140-00-491-	Oil, Lubrication, Sub Zero OE/HDO-10 (185 GL required) EMERY 3908D (33358)	18 ea
132	C	7240-00-160-0455	Pail, Utility, Metal, 3 1/2 gal RR-P-30 (81348)	7 ea.
133	C	7330-00-634-4464	Pan, Baking Roasting, RR-P-94, Size 5 (81348)	2 ea
134	C	7330-00-255-5995	Pan, Bread, 10 3/8 inches long RR-P-58, Type 2 (81348)	2 ea
135	C	7330-00-246-2402	Pan, Fry, 6 3/4 inches RR-P-89, Size 1, (81348)	1 ea
136	C	7330-00-238-3805	Pan, Fry, 12 inches RR-P-89, Size 2 (81348)	1 ea
137	C	7330-00-244-4549	Pan, Muffin, 12 Cup RR-P-54 (81348)	2 ea
138	C	7330-00-823-6883	Pan, Pie, Alum, 9 inches RR-P-54, Type V (81348)	2 ea
139	C	6665-00-050-8529	Paper, Chemical Agent Determination	6 ea
140	C	8540-00-530-3769	Paper, Toilet UU-P-556 (81348)	1 bx
141	C	7330-00-238-8316	Peeler, Potato MIL-P-20583 (81349)	2 ea
142	C	6850-00-090-1361	Paste, Water Indicator No Ref (33333)	2 ea
143	C	8345-00-935-0401	Signal "1" Numerical, Intn'l Code, Size 6 Pennant, MIL-P-2692 (81349)	1 ea

(1) ITEM	(2) LEVEL	(3) NATIONAL STOCK NO.	(4) DESCRIPTION	(5) U/M
144	C	8345-00-935-0495	Pennant, Signal, "O" Numerical Intn'l Code Size 6 MIL-F-2692 (81349)	1 ea
145	C	8340-00-926-6023	Pennant, Signal, "2" Numerical Intn'l Code Size 6 MIL-F-2692 (81349)	1 ea
146	C	8345-00-935-0490	Pennant, Signal, "3" Numerical Intn'l Code Size 6 MIL-F-2692 (81349)	1 ea
147	C	8345-00-935-0491	Pennant, Signal, "4" Numerical Intn'l Code Size 6 MIL-F-2692 (81349)	1 ea
148	C	8345-00-935-0492	Pennant, Signal, "5" Numerical Intn'l Code Size 6 MIL-F-2692 (81349)	1 ea
149	C	8345-00-935-0493	Pennant, Signal, "6" Numerical Intn'l Code Size 6 MIL-F-2692 (81349)	1 ea
150	C	8345-00-026-9214	Pennant, Signal, "7" Numerical Intn'l Code Size 6 MIL-F-2692 (81349)	1 ea
151	C	8345-00-935-0494	Pennant, Signal, "8" Numerical Intn'l Code Size 6 MIL-F-2692 (81349)	1 ea
152	C	8345-00-935-0405	Pennant, Signal, "9" Numerical Intn'l Code Size 6 MIL-F-2692 (81349)	1 ea
153	C	8345-00-935-0410	Pennant, Signal Answering MIL-F-2692 (81349)	1 ea
154	C	8345-00-926-5900	Pennant, Signal Answering, 1st Repeater, Intn'l Code Size 6 MIL-F-2692 (81349)	1 ea
155	C	8345-00-935-0421	Pennant, Signal Answering, 2nd Repeater, Intn'l Code-Size 6 MIL-F-2692 (81349)	1 ea
156	C	8345-00-925-9207	Pennant, Signal Answering, 3rd Repeater, Intn'l Code Size 6 MIL-F-2692 (81349)	1 ea
157	C	7350-00-195-4763	Pitcher, Syrup, 20 pt. DD-T-101, Type 1, (81348)	3 ea
158	C	7350-00-249-5165	Pitcher, Water, Square RR-P-386, Size 2 (81348)	3 ea

(1) ITEM	(2) LEVEL	(3) NATIONAL STOCK NO.	(4) DESCRIPTION	(5) U/M
159	C	7930-00-266-7137	Polish, Metal, Type 2, Class 1, PP-536 (81348)	1 bx
160	C	7330-00-775-3941	Pot, Cooking, W/Cover, 9 qt. MIL-P-40686 (81349)	2 ea
161	C	7330-00-240-2134	Saucepan, W/Cover, 1 qt. MIL-S-40044, Size 1 (81349)	2 ea
162	C	7330-00-240-2137	Saucepan, W/Cover, 7 qt. MIL-P-40044	2 ea
163	C	7330-00-153-9760	Scoop, Kitchen, RR-S-121 (81348)	1 ea
164	C	4020-00-240-2015	Seizing Stuff, Hemp 1/4 inch	1 cl
165	C	7350-00-240-7068	Shaker, Pepper, 9 cu in. cap, RR-K-260 (81348)	1 ea
166	C	7350-00-240-7069	Shaker, Salt, 9 cu in. cap, RR-K-260 (81348)	1 ea
167	C	7350-00-680-2630	Shaker, Salt or Pepper, 2 oz. DD-T-101 (81348)	6 ea
168	C	7330-00-793-7356	Sharpener, Knife, Wall Mounted, RR-S-310 (81348)	1 ea
169	C	7330-00-184-0089	Sheet Plastic, (Food Wrap), L-P-370 (81348)	6 ea
170	C	7330-00-184-0089	Sifter, Flour, RR-S-345 (81348)	1 ea
171	C	7930-00-664-0337	Soap, Laundry, 100 lb. Drum, P-S-1792, Type 2, Class 2 (81348)	1 dr
172	C	3439-00-188-6986	Solder, Lead Alloy, Acid Core, QQ-S-771 (81349)	1 dr
173	C	3439-00-188-6988	Solder, Lead Alloy, Rosin Core, QQ-S-571 (81349)	1 sl
174	C	7330-00-684-8740	Spatula, Steel, 14 inches long, GGG-C-746 (81348) ,	1 ea

(1) ITEM	(2) LEVEL	(3) NATIONAL STOCK NO.	(4) DESCRIPTION	(5) U/M
175	C	7340-00-223-7800	Spoon, Basting, 21 inches long, MIL-U-10815 (81349)	1 ea
176	C	7340-00-241-8171	Spoon, Dessert, 7 inches long, RR-F-617 (81348)	1 bx
177	C	7340-00-240-7080	Spoon, Food Service, 15 inches long, RR-S-617 (81348)	2 ea
178	C	7340-00-599-8357	Spoon, Iced Tea, RR-F-450 (81348)	1 bx
179	C	7340-00-205-1421	Slotted Spoon, Servicing, 15 inches long, RR-F-617 (81348)	3 ea
180	C	7340-00-205-3341	Spoon, Table, CRES R-F-450 (81348)	1 bx
181	C	7340-00-205-3340	Teaspoon, CRES RR-F-455 (81348)	1 bx
182	C	6685-00-641-0189	Thermometer, Self-Indicating, Meat, GG-T-353 (81348)	1 ea
183	C	6685-00-255-9981	Thermometer, Self-Indicating, Oven GG-T-351 (81348)	1 ea
184	C	7330-00-616-0997	Tongs, Food Serving, MIL-T-40097, 12 inches long (81349)	4 ea
185	C	8540-00-291-0392	Towels, Paper, UU-T-591 (81348)	1 ea
186	C	7920-00-823-9773	Towel, Paper Machinery, Wiping, UU-T-595, Type V} (81348)	1 ea
187	C	7350-00-680-6545	Tumbler, Drinking, Plastic, 8 oz. L-T-800 (81348)	2 doz
188	C	7920-00-579-8484	Wringer & Bucker, Mop, RR-M-1075 (81348)	4 ea
189	C	6850-00-753-4967	Inhibitor, Corrosion Preventive, 8 1/2 oz. 0-I-490 (81348)	48 cn
190	C	8415-00-634-4658	Gloves, Leather, Welder's, JJ-C-451 (81348)	2 pr

(1) ITEM	(2) LEVEL	(3) NATIONAL STOCK NO.	(4) DESCRIPTION	(5) U/M
191	C	5110-00-203-6424	Chisel, Power Hammer, GGG-C-330, Type XV, Class A (81348)	2 ea
192	C	8010-00-239-5737	Lead, White (Paste in oil) TT-W-251, Type B (81348)	1 Cn
193	C	7520-00-298-7044	Stencil Set, Marking, 2 inch RR-S-714 (81348)	1 ea
194	C	7520-00-272-9683	Stencil Set, Marking, 3 inch RR-S-714 (81348)	1 ea
195	C	5640-00-409-4265	Tape, Duct No Ref (33333)	6 Ro
196	C	9905-00-182-5043	Tape, Reflector, Green, 6 x 3 inches No Ref (33333)	100 Ro
197	C	4720-00-277-4029	Tubing, Copper, 1/4 inch MIL-T-2410 (81349)	1 cl
198	C	4720-00-277-4030	Tubing, Copper, 5/16 inch MIL-T-24107 (81349)	1 cl
199	C	4720-00-277-4027	Tubing, Copper, 3/8 inch MIL-T-24107 (81349)	1 cl
200	C	4720-00-277-4026	Tubing, Copper, 1/2 inch MIL-T-24107 (81349)	1 cl
201		5330-00-641-1193	Asbestos Sheet, Compressed, 1/16 inch HH-P-466 (81348)	2 ea
202	C	5330-00-171-6551	Asbestos Sheet, Compressed, 1/8 inch HH-P-466 (81348)	2 ea
203	C	5330-00-641-3051	Rubber Sheet, Solid 1/16 inch MIL-G-1149, Type 1 Class 1 (81349)	10 ft
204	C	5330-00-729-5103	Rubber Sheet, Solid 1/8 inch MIL-G-1149, Type 1 Class 1 (8134S)	10 ft
205	C	5330-00-729-5103	Packing 406-04825 (71724)	24 ft
206	C	9515-00-237-1865	Steel Sheet, Carbon	15 h

(1) ITEM	(2) LEVEL	(3) NATIONAL STOCK NO.	(4) DESCRIPTION	(5) U/M
207	C	5330-00-244-9276	Rubber Sheet	1 sy
208	C	5330-00-244-9279	Rubber Sheet	1 sy
209	C	5330-00-270-8466	Gasket Paper .006 thick	1 sy
210	C	5330-00-270-8468	Gasket Paper 1/64 inch thick	1 sy
211	C	5330-00-270-8470	Gasket Material, Paper	1 sy
212	C	5330-00-585-9502	Asbestos Sheet	6 sh
213	C	5970-00-905-8762	Insulation Sheet electrical	1 sh
214	C	4240-00-285-9901	Lifeline (3/16 inch x 50 feet long for use "/Breathing Apparatus	3 ea
215	C	8030-00-829-4554	Compound Thread Locking	2 bt
216	C	6630-00-316-5831	Test Kit, Diesel Engine, Water	1 ea
217	C	4210-00-752-9343	Dry Chemical (Firefighting)	1 pl
218	C	8405-00-266-8691	Gloves, Rubber, Electricians	1 pr
219	C		Compound P/N 5198563 (72582)	1 cn
	220	8080-00-231-2345	Compound, Corrosion Preventative, MIL-C-16731	1 gal
221	C		Lamp, Fluorescent, 8w, P-1 (85213)	ea
222	C	6240-00-866-4143	Lamp, Incandescent, MS16524-2 (96906)	ea
223	C	6240-00-330-0139	Lamp, Incandescent, 12V 3022 (70623)	ea
224	C	6240-00-143-3119	Lamp, Incandescent, DOW, E-L-101 (81348)	ea
225	C	6240-00-143-3124	Lamp, Incandescent, 100w, W-L-101 (81348)	ea
226	C		Launcher, Rocket, Line Throwing Device, P/N CG3563 (75324)	ea

E-15

(1) ITEM	(2) LEVEL	(3) NATIONAL STOCK NO.	(4) DESCRIPTION	(5) U/M
227	C		Line, Service, Line Throwing Device, P/N CG3575 (75324)	ea
228	C	8540-00-965-4691	Napkin, Table, Paper No Ref (33333)	bx
229	C	9150-00-985-7234	Oil, Lubricating, General Purpose, Mineral Oil (2135TH)	ga
230	C	9150-00-985-7237	Oil, Lubricating, General Purpose, Mineral Oil (2110TH)	gl
231	C	7930-00-295-0442	Powder, Scouring, P-S-311, (81348)	cn
232	C		Rocket, Buoyant, Line Throwing Device, P/N CG3562 (75324)	ea
233	C		Rocket, Standard, Line Throwing Device, P/N CG3561 (752324)	ea
234	C	4020-00-270-8763	Rope, Manila, 5/8 inch, T-R-605, Type H. Class 2	ft
235	C	4020-00-231-9014	Rope, Manila, 3 inches, TT-R-605, Type M, Class 2	cl
236	C	4020-00-231-2568	Rope, Manila, 6 inches	cl
237	C	4020-00-752-8879	Rope, Nylon, Mooring, 4:, Each is to 50' long, and has 41,300 lbs breaking strength MIL-R-17343	cl

SECTION II.

EXPENDABLE SUPPLIES AND MATERIALS LIST (CONTINUED).

PUBLICATIONS

TB 5-4200-200-10	Hand Portable Fire Extinguishers Approved For Army Users
TB 43-0144	Painting of Vessels
TB 55-1900-202-12/1	US Army Mobility Equipment Center Floating Craft Preventive Maintenance
TB 55-1900-207-24	Treatment of Cooling Water in Marine Diesel Engines
TM 11-5820-401-10	Operator's Manual, Radio Sets AN/VRC-12, AY/VRC 43, 44, 45, 46, 47, 48 and 49
TM 11-5820-520-12	Operator & Organizational Manual, Radio Sets AN/GRC-106 & 106A
TM 11-5820-765-12	Operator & Organizational Manual, Power Supply, PP-4763/GRC, PP-4763A/GRC
TM 11-5841-268-25	Organizational (Field) Intermediate DS/GS & Depot Maintenance, Control, Transponder Set, C-6280(p)/APX, C-6280A/APX, C-6717/APX, C-7843/APX, C-6280A(P)APX
TM 11-5895-490-20	Organizational Maintenance Manual, RCVR/Transmitter - Radio, RT-859/APX-72 & Mountings MT-3809/APX-72 and MT-3948/APX-72
TM 11-6130-233-12	Operator & Organizational Maintenance Manual, Incl Repair Parts Power Supplies PP-2953C/U, Changes 2-4
TM 55-506 TM 55-509	Marine Electrical & Refrigeration Equipment Marine Engineers' Handbook
TM 55-1905-219-20P	Operator, Organizational Maintenance Repair Parts & Special Tools List, Landing Craft, Utility, Design LCU 1671, NSN 1905-01-009-1056
US Coast Guard	Oil Record Book For Non-Tankers
Form CG4602 DA Form 55-40	Deck Department Log
DA Form 55-44	Engine Department Log
TM 75-244-3	Procedures for Destruction of Equipment to Prevent Enemy Use
TBTC 15-17	Interservice Testing of Engine Lubricating Oil

SECTION II.

EXPENDABLE SUPPLIES AND MATERIALS LIST (CONTINUED).

PUBLICATIONS (CONTINUED).

7610-00-297-1545	Book, Medical
7610-00-263-9707	Book, American Practical Navigator
7610-00-680-0395	Book, Nautical Almanac
7610-00-227-1801	Book Set, Navigation Ships Medicine Chest & First Aid at Sea (US Public Health Service)
NAVSEA 0924-LP-038-1010	Technical Manual For MK27, MOD 1 Gyro Compass

LUBE ORDERS

Will be disseminated when developed.

APPENDIX F

MANUFACTURED TOOLS

This appendix includes complete instructions for making items authorized to be manufactured or fabricated at Organizational Maintenance level.

A part number index in alphanumerical order is provided for cross referencing the part number of the item to be manufactured to the figure which covers fabrication criteria.

All bulk materials needed for manufacture of an item are listed by part number or specification number in a tabular list on the illustration.

<u>TOOL PART NUMBER</u>	<u>FIGURE</u>
T8059	F-1
T6984	F-2
T9802	F-3
T6995	F-4
T6991	F-5
T9803	F-6
T10468-1	F-7
T10468-2	F-8
T6987	F-9

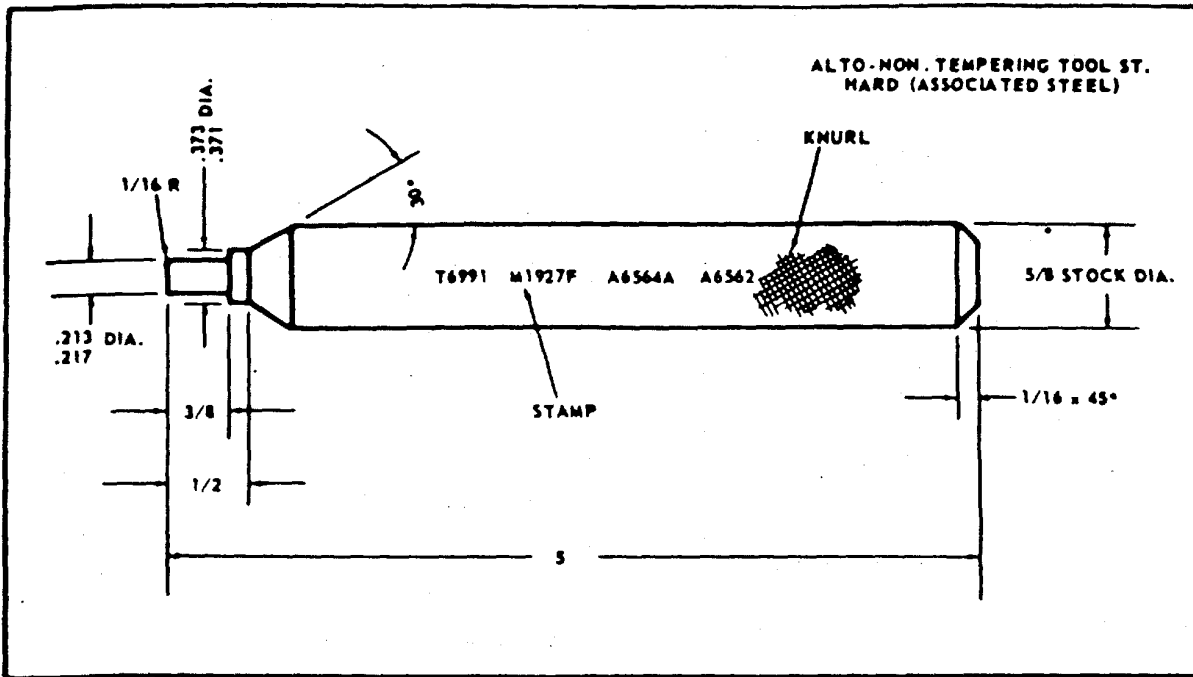

Figure F-5. Special Tool T-6991

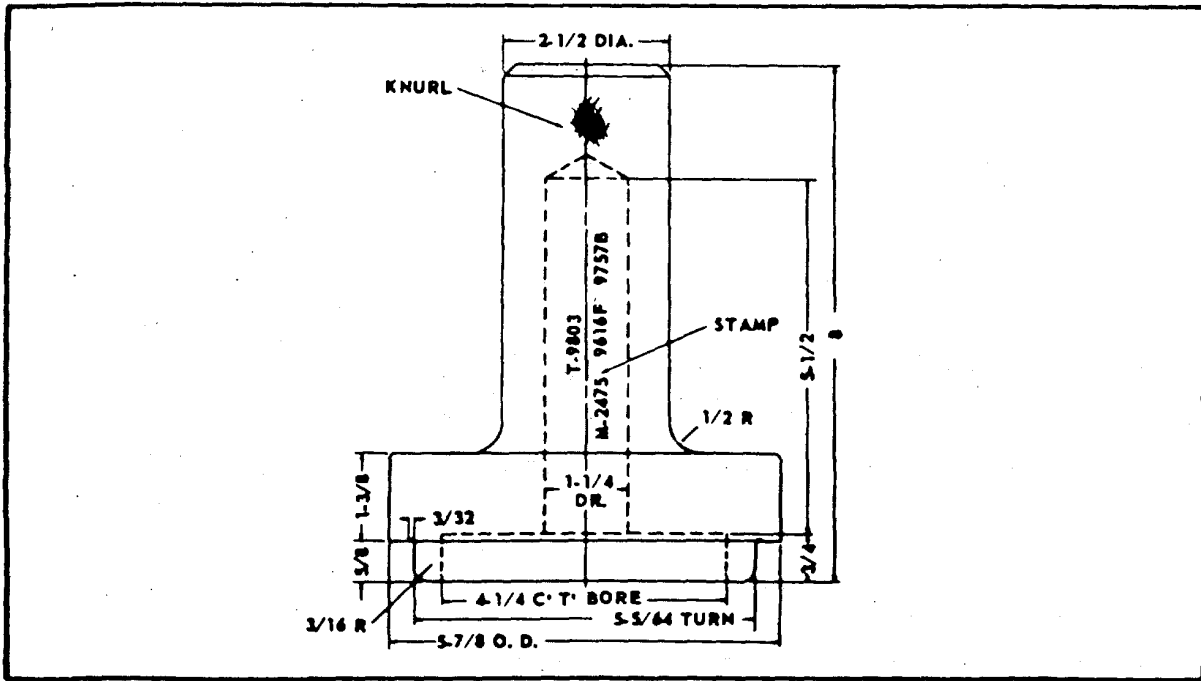

Figure F-6. Special Tool T-9803

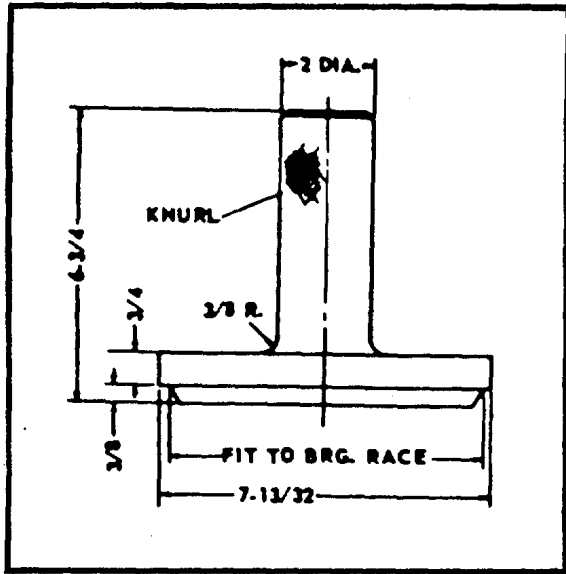

Figure F-7. Special Tool T-10468-1

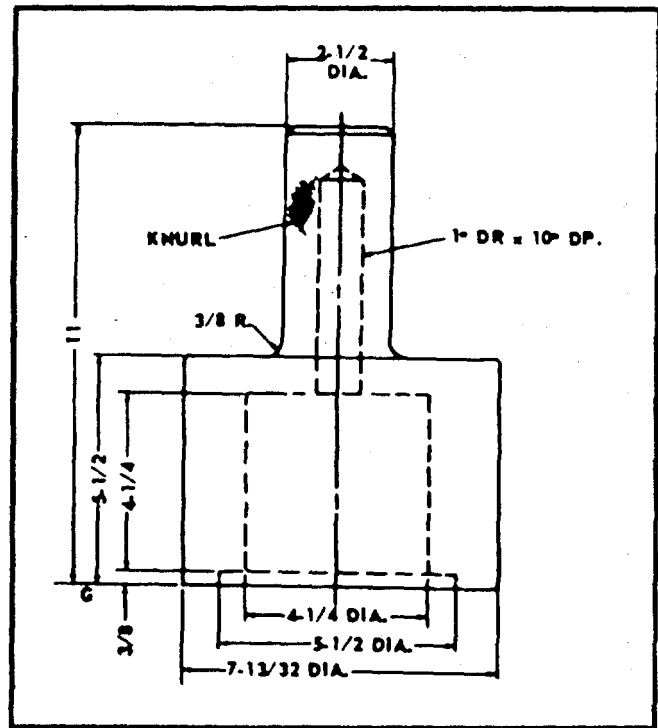

Figure F-8. Special Tool T-10468-2

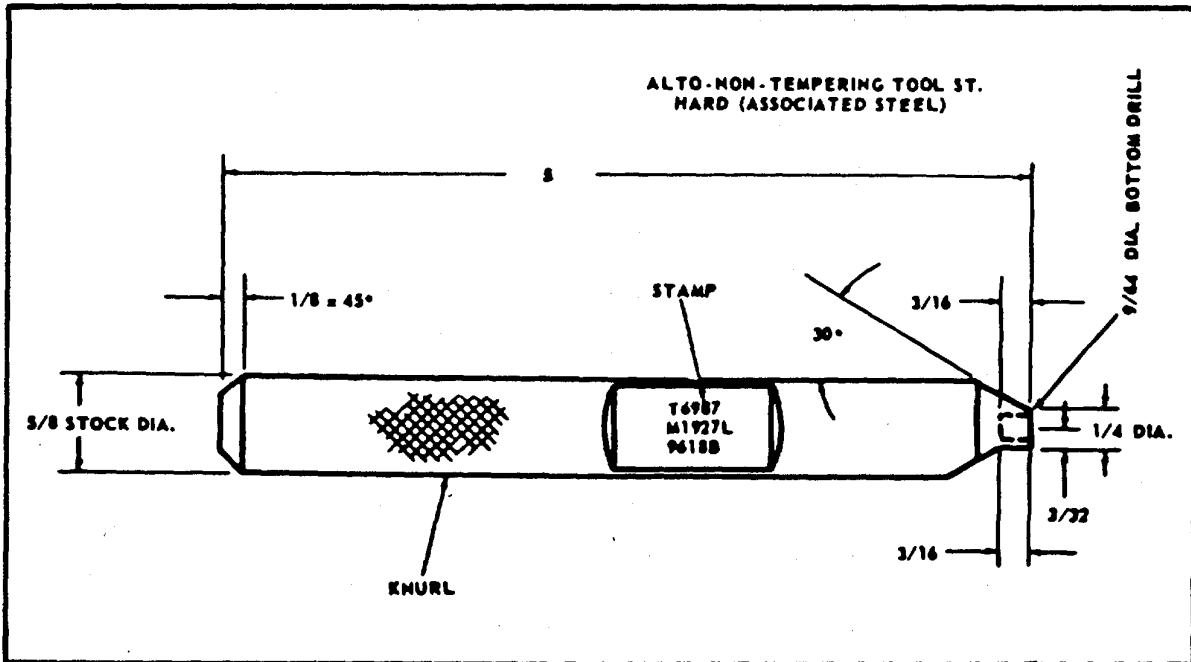

Figure F-9. Special Tool T-6987.

F-5/(F-6 Blank)

INDEX

HOW TO USE THE INDEX

The index is in alphabetic sequence and refers to volume, chapter, paragraph or table as follows:

CONTENTS

- Volume 1 - Introduction and Operating Instructions
- 2 - Operation Under Usual/Unusual Conditions
- 3 - Operator Maintenance Instructions - Troubleshooting
- 4 - Operator/Crew - Propulsion Engine and Marine Gear Maintenance Instructions
- 5 - Operator/Crew - Electric Power Generation and Distribution Maintenance Instructions
- 6 - Operator/Crew - Bow Ramp and Anchor Handling System Maintenance Instructions
- 7 - Operator/Crew - Mast, Centralized Hydraulic System, Steering System, and Anchor Handling System Maintenance Instructions
- 8 - Operator Maintenance Instructions for Auxiliary Equipment
- 9 - Operator Maintenance Instructions for Auxiliary Equipment
- 10 - Direct Support Maintenance Instructions
- 11 - Direct Support and General Support Maintenance Instructions

- Chapter 1 - Introduction
- 2 - Operating Instructions
- 3 - Operator/Organizational Maintenance - Propulsion Engine and Marine Gear, Generating System, Bow Ramp, Anchor Handling System, Central Hydraulic and Steering Systems
- 4 - Operator/Organizational Maintenance - Auxiliary Equipment
- 5 - Direct Support Maintenance Instructions
- 6 - General Support Maintenance Instructions

For Example:

Balance Weight Cover

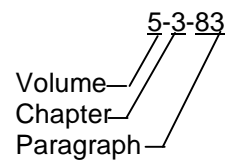

INDEX (Continued)

Volume - Chapter
-Paragraph
or Table

A

"A" Frame Hydraulic Winch	3-T3-83
"A" Frame - Principles of Operation	1-1-56
"A" Frame, Wire Rope and Anchor	7-3-182
Abbreviations - List of	1-1-6
Abnormal Engine Coolant Operating Temperature- Anchor Winch Engine	3-T3-66
Abnormal Engine Coolant Operating Temperature . Generator	3-T3-29
Abnormal Engine Coolant Operating Temperature- Propulsion.....	3-T3-8
Abnormal Engine Operation - Anchor Winch Engine	3-T3-61
Abnormal Engine Operation - Generator	3-T3-24
Abnormal Engine Operation - Propulsion	3-T3-3
Accumulator - Anchor Winch	7-3-177
Accumulator - Generator	5-3-102
Accumulator - Propulsion	4-3-47
Accumulator	10-5-22
Administrative Storage	7-3-221
Aft Engine Room - Controls and Indicators	1-2-11
- Interior Arrangement	1-1-31
Air Cleaner - Anchor Winch	6-3-156
Air Cleaner - Generator	5-3-81
Air Compressor Turn ON/OFF	2-2-146.5
Air Conditioner System	8-4-28
Compressor	8-4-29
Condenser	8-4-30
Dryer	8-4-32
Gage Board	8-4-33
Strainer	8-4-31
Air Conditioner Water Circulating Pump	8-4-12
Air Conditioner Water Pump Motor Controller	8-4-12.4
Air Conditioner Water Pump Motor	8-4-12.3
Air Conditioner Water Pump	8-4-12.2
Air Conditioner Water Pump Set	8-4-12.1
Air Conditioning Machinery Room - Controls and Indicators	1-2-7
Air Conditioning Machinery Room - Interior Arrangement	1-1-28
Air Conditioning System	2-2-105
Circulating Fans	2-2-107
Sea Water Cooling Pump	2-2-106
System Shut-down	2-2-109
System Start-up	2-2-108

INDEX (Continued)

Volume-Chapter
-Paragraph
or Table

A (continued)

Air Conditioning Water Circulation Pump Controller	11-5-128
Air Conditioning Water Circulation Pump Motor	11-5-127
Aircraft Flood Lights	2-2-162
Air Horn Air Compressor System	2-2-146.4
Air Horn Assembly	4-3-57.1
Air Horn Operation	2-2-146.6
Air Horn Compressor Assembly	9-4-71.1
Air Horn Compressor Assembly Hoses, Fittings and Piping	9-4-71.2
Air Intake-Anchor Winch	6-3-143
Air Intake-Propulsion	4-3-11
Air Intake Housing	4-3-11.2
Air Silencers	4-3-11.1
Air Intake and Emergency Shutdown Linkage-Generator	5-3-67
Air Intake Housing	4-3-11.2
Air Silencers	4-3-11.1
Alarms-Halon System	2-2-117
Alarm Switchboard	9-4-47
Alarm Switchboard	9-4-47.1
2-Line Alarm Panel	9-4-47.2
Alarm Switchboard	11-5-149
Alarm System	2-2-110
Alarm System-Test	2-2-113
-Turn-Off	2-2-114
-Turn-On	2-2-111
System Alarms	2-2-112
Amplifier/Loudspeaker	9-4-46.1
Amplifier/Loudspeaker	11-5-151
Anchor "A." Frame	2-2-67
Anchor "A" Frame and Cable	11-5-82
Anchor "A" Frame and Control Station-Exterior Orientation	1-1-17
Anchor "A" Frame Hydraulic Directional Control Valve	7-3-201
Anchor "A" Frame Hydraulic Hoses, Fittings and Piping	7-3-202
Anchor "A" Frame Hydraulic Winch	7-3-200
Anchor Handling System-Maintenance Instructions	6-3-128
Air Cleaners	6-3-156
Air Intake	6-3-143
Balance Weight Cover	6-3-158
Blower	6-3-144
Camshaft and Gear Train	6-3-166
Crankshaft Vibration Dampener.....	6-3-157
Cylinder Head	6-3-164
Drive Brake and Brake Control	6-3-130
Drive Gear	6-3-131
Drum Assembly	6-3-133
Disconnect Clutch	6-3-135

INDEX (Continued)

Volume-Chapter
-Paragraph
or Table

A (continued)

Anchor Handling System-Maintenance Instructions-(Continued)

Engine Assembly	6-3-140
Engine Controls	6-3-141
Engine Supports and Lifting Brackets	6-3-159
Exhaust Manifold	6-3-160
Flywheel and Housing	6-3-167
Fresh Water Pump	6-3-150
Fuel Filter, Fuel Strainer, Fuel Lines and Manifold Connections	6-3-146
Fuel Injector	6-3-147
Fuel Pump	6-3-145
Governor and Breather Tube	6-3-142
Hydraulic Tank Assembly and Piping	6-3-137
Hydraulic Pump, Hoses, and Fittings	6-3-139
Injector Controls	6-3-162
Level Wind	6-3-132
Lube Oil Cooler	6-3-149
Lube Oil Distribution System	6-3-170
Lube Oil Filters, Hoses, and Housing	6-3-148
Lube Oil Pressure Regulator and By-Pass.....	6-3-168
Lube Oil Pump	6-3-169
Oil Pan and Dipstick	6-3-163
Overspeed Governor	6-3-154
Rocker Arm Cover	6-3-161
Slack Puller	6-3-134
Tachometer Drive	6-3-155
Thermostat and Housing	6-3-153
Torque Converter	6-3-136
Valve Operation Mechanism	6-3-165
Water Connections	6-3-151
Water Manifold	6-3-152
Winch	6-3-129
Winch, Brake Control	6-3-138
Anchor Inhaul-Anchor Winch	2-2-50
Anchor Winch Assembly	10-5-58
Anchor Winch	10-5-57
Disconnect Clutch Assembly	10-5-65
Disconnect Clutch	3-T3-50
Drive Brake Assembly	10-5-60
Drive Gear Assembly	10-5-61
Frame and Drum Assembly	10-5-63
Hydraulic Pump	3-T3-58

INDEX (Continued)

Volume-Chapter
-Paragraph
or Table

A (continued)

Anchor Winch (Continued)	
Hydraulic Tank	10-5-67
Balanced Piston Relief Valves	3-T3-52
Check Valves	3-T3-53
Directional Control Valve	3-T3-56
Hydraulic Tank	3-T3-57
Pressure Control Valves	3-T3-54
Pressure Reducing Valves	3-T3-55
Level Wind Assembly	10-5-62
Slack Puller	3-T3-49
Slack Puller and Motor Assembly	10-5-64
Torque Converter	3-T3-51
Torque Converter	10-5-66
Universal Joint Assembly	10-5-59
Winch	3-T3-48
Winch Assembly	10-5-58
Anchor Winch and "A" Frame	2-2-46
Anchor Winch-Anchor Inhaul	2-2-50
Anchor Winch Engine-Local Start/Stop Cold Weather	2-2-48
Anchor Winch Engine-Local Start/Stop Warm Weather	2-2-47
Anchor Winch-Remote Operation and Payout.....	2-2-49
Anchor Winch-Stop	2-2-51
Anchor Winch Assembly	10-5-58
Anchor Winch Compartment-Hydraulic Starting System	1-1-87
Anchor Winch Compartment-Interior Arrangement	1-1-33
Anchor Winch Controls-Controls and Indicators	1-2-16
Anchor Winch Engine	11-5-68
Abnormal Engine Coolant Operating Temperature	3-T3-66
Abnormal Engine Operation	3-T3-61
Blower	11-5-71
Cylinder Block	11-5-79
Emergency Start	2-2-184
Emergency Stop	2-2-182
Engine Assembly-Removal and Run In	11-5-69
Excessive Crankcase Pressure	3-T3-64
Exhaust Manifold	11-5-76
Exhaust Smoke Analysis	3-T3-59
Flywheel and Housing	11-5-77
Fresh Water Pump	11-5-73
Fuel Injector	11-5-72
Governor	11-5-70

INDEX (Continued)

Volume-Chapter
-Paragraph
or Table

A (continued)

Anchor Winch Engine (Continued)

Hard Starting	3-T3-60
Hydraulic Filter and Piping	11-5-80
Hydraulic Reservoir	11-5-81
Hydrostarter	
Cranking Speed Too Low	3-T3-69
Fluid Emerges Around Rubber Boot of Hand Pump.....	3-T3-77
Fluid Emerges from the Reservoir Filler Cap When Starter Is Used	3-T3-76
Hand Pump Fails to Discharge Fluid	3-T3-72
High Pressure in System (3500 Psi (24,133 kPa) or above)	3-T3-75
Loss of Accumulator Precharge (Nitrogen)	3-T3-74
Loss of Fluid Pressure When Engine Is Not Running.....	3-T3-71
Loss of Fluid from Reservoir	3-T3-70
Starter Turns but Engine Does Not	3-T3-73
Local Start/Stop Cold Weather	2-2-48
Local Start/Stop Warm Weather	2-2-47
Low or High Exhaust Valve Opening Pressure	3-T3-67
Low or No Accumulator Pressure	3-T3-68
Low Oil Pressure	3-T3-65
Lube Oil Pump	11-5-78
No Fuel or Insufficient Fuel	3-T3-62
Principles of Operation	1-1-52
Restart After Emergency Stop	2-2-183
Thermostat and Housing	11-5-75
Water Manifold	11-5-74
Anchor Winch-Principles of Operation	1-1-55
Anchor Winch Room-Controls and Indicators	1-2-12
Anchor Winch-Stop	2-2-51
Anchor Winch System-Emergency Procedures	2-2-181
Anchor Winch Engine-Emergency Start	2-2-184
Anchor Winch Engine-Emergency Stop	2-2-182
Anchor Winch Engine-Restart After Emergency Stop.....	2-2-183
Cutting Anchor Cable	2-2-185
Anchor Winch System-Principles of Operation	1-1-51
"A" Frame	1-1-56
Anchor Winch	1-1-55
Anchor Winch Engine	1-1-52
Hydraulic System	1-1-54
Torque Converter	1-1-53

INDEX (Continued)

Volume-Chapter
Paragraph or
Table

A (continued)

Applications-Portable Fire Pump	2-2-199
Automatic Electrical Shut-down System	5-3-65.3
Automatic Steering	2-2-60

B

Balanced Piston Relief Valves-Hydraulic Tank-Anchor Winch	3-T3-52
Balance Weight Cover-Anchor Winch	6-3-158
Balance Weight Cover-Generator	5-3-83
Balance Weight Cover and Accessory Drive	4-3-26
Balance Weight Cover and Accessory Drive	10-5-13
Ballast System	2-2-91
Draining Ballast Tanks-Using Fire Pump	2-2-95
-Using Gravity	2-2-93
Filling Ballast Tanks-Using Fire Pump	2-2-94
-Using Gravity	2-2-92
Ballast System Piping-Principles Of Operation	1-1-76
Battery Charger/Exhaust	2-2-127
Battery-Fire Pump (PE-250)	8-4-7.8A
Berth Light	5-3-111.9
Bilge Draining	2-2-98
Bilge Draining	2-2-82
Bilge Pump Shutdown	2-2-84
Draining Bilge with Bilge Pump and Fire Pump	2-2-90
Draining Bilge with Bilge Pump	2-2-83
Draining Bilge with Fire Pump and Eductor	2-2-88
Draining Bilge with Fire Pump	2-2-85
Draining the Firemain System	2-2-87
Fire Pump, Bilge Draining Shutdown	2-2-86
Fire Pump and Eductor Shutdown	2-2-89
Bilge Pump	11-5-122
Bilge Pump	8-4-9
Bilge Pump Clutch	8-4-9.3
Bilge Pump Foundation and Drive	8-4-9.1
Bilge Pump	8-4-9.2
Bilge Pump Shutdown	2-2-84
Bilge System Piping-Principles of Operation	1-1-75
Blower-Anchor Winch	11-5-71
Blower-Generator.....	10 5-35
Blower-Propulsion.....	10-5-8

INDEX (Continued)

Volume-Chapter
-Paragraph
or Table

B (continued)

Blower-Anchor Winch	6-3-144
Blower-Generator	5-3-68
Blower-Propulsion	4-3-12
Bow Ramp	2-2-52, 10-5-47
Bow Ramp, Sheaves, and Fairleads	10-5-48
Controller	10-5-52
Lowering Bow Ramp-Local	2-2-55
-Remote	2-2-53
Raising Bow Ramp-Local	2-2-56
-Remote	2-2-54
Speed Reducer	10-5-50
Winch Assembly	10-5-49
Winch Motor	10-5-51
Bow Ramp and Winch	6-3-115
Bow Ramp, Sheaves, and Fairleads	6-3-116
Controller	6-3-121
Limit Switch	6-3-123
Master Switches (Disconnect)	6-3-122
Speed Reducer	6-3-119
Torque Coupler	6-3-118
Winch Assembly	6-3-117
Winch Brake and Motor	6-3-120
Bow Ramp-Exterior Orientation	1-1-19
Bow Ramp, Sheaves, and Fairleads	6-3-116
Bow Ramp, Sheaves, and Fairleads	10-5-48
Bow Ramp System-Emergency Procedures	2-2-187
Bow Ramp-Lowering	2-2-188
-Raising	2-2-189
Bow Ramp Winch Brake	3-T3-46
Bow Ramp Winch Compartment and Deck Locker-Interior Arrangement	1-1-27
Bow Ramp Winch Systems-Principles of Operation	1-1-57
Bow Winch	3-T3-45
Bow Winch Motor	3-T3-47
Brake-Bow Ramp Winch	3-T3-46
Brake Valve-Hydraulic Cup Pump Unit	11-5-106
Break-Glass, Shut-Down Stations	2-2-203
Break Glass Station	5-3-110.2
Breather Tube-Governor-Generator	6-3-142.2

INDEX (Continued)

Volume-Chapter
-Paragraph
or Table

C

Call System Major Components	9-4-46.4
Camshaft Assembly and Gear Train	10-5-19
Camshaft Assembly and Gear Train	10-5-19.1
Idler Gear	10-5-19.2
Idler Gear Hole Spacer	10-5-19.3
Camshaft Assembly and Gear Train	10-5-19.1
Camshaft and Balance Shaft-Anchor Winch	6-3-166.5
Camshaft and Balance Shaft-Generator	5-3-91.5
Camshaft and Gear Train-Anchor Winch	6-3-166
Camshaft and Balance Shaft	6-3-166.5
Crankshaft Timing Gear	6-3-166.4
Engine Timing	6-3-166.2
Gear Train ;.....	6-3-166.1
Idler Gear and Bearing Assembly	6-3-166.3
Camshaft and Gear Train-Generator	5-3-91
Camshaft and Balance Shaft	5-3-91.5
Crankshaft Timing Gear	5-3-91.4
Engine Timing	5-3-91.2
Gear Train	5-3-91.1
Idler Gear and Bearing Assembly	5-3-91.3
Carburetor Assembly-Fire Pump (P-250)	8-4-7.2
Carburetor-Fire Pump (PE-250)	8-4-7.7A
Carburetor Linkage, Control Panel and Manifold-Fire Pump (P-250).....	8-4-7.3
Centralized Hydraulic System	2-2-63
Anchor "A" Frame	2-2-67
Controller	3-T3-80
Hydraulic Power Unit	3-T3-79
Main Mast-Lowering	2-2-66
-Raising	2-2-65
Preliminary Adjustments	2-2-64
Stern Gate-Lowering	2-2-68
-Raising	2-2-69
Centralized Hydraulic System	7-3-186
Anchor "A" Frame Hydraulic System	
Hydraulic Control Valve	7-3-201
Hydraulic Winch	7-3-200
Hoses, Fittings and Piping	7-3-202
Mast Hydraulic System	
Hydraulic Control Valve	7-3-198
Hydraulic Ram	7-3-197
Hoses and Fittings	7-3-199

INDEX (Continued)

Volume-Chapter
-Paragraph
or Table

C (continued)

Centralized Hydraulic System (Continued)	
Ships' Hydraulic System	
Controller	7-3-191
Electric Motor and Coupling	7-3-188
Gauge	7-3-192'
Hydraulic Power Unit, Filters Return	7-3-187
Hydraulic Pump	7-3-189
Hydraulic Reservoir Tank	7-3-190
Pushbutton Switch	7-3-193
Stern Gate Hydraulic System	
Hydraulic Control Valve	7-3-194
Hydraulic Ram	7-3-196
Hoses and Fittings	7-3-195
Centralized Hydraulic System-Principles of Operation	1-1-80
Centrifugal Fan and Motor	8-4-27
Check Valves-Hydraulic Tank-Anchor Winch	3-T3-53
Check Valve-Hydraulic Tank-Anchor Winch	6-3-137.5
Circulating Fans	2-2-107
Clutch Hydraulic Cylinder	10-5-65.3
Coffee Maker	2-2-133, 9-4-40
Commissary Space Equipment	9-4-36, 11-5-143
Coffee Maker	9-4-40
Drinking Fountain	9-4-38
Galley Range	9-4-43
Milk Dispenser	9-4-39, 11-5-145
Refrigerator/Freezer	9-4-37, 11-5-144
Sanitizing Sink Heater	9-4-42
Toaster	9-4-44
Washer/Dryer	9-4-41
Communications (1JV and E)	2-2-149
Communication Systems-Principles of Operation	1-1-85
Compressor-Air Conditioner System	8-4-29
Compressor-HVAC	11-5-140
Compressor Controller-HVAC	11-5-142
Compressor Motor-HVAC	11-5-141
Condenser-Air Conditioner System	8-4-30
Connecting Rods-Anchor Winch	7-3-171.2
Connecting Rods-Generator	5-3-96.2
Connecting Rods-Propulsion	4-3-40.2
Connecting Rod Bearings-Anchor Winch	7-3-171.3
Connecting Rod Bearings-Generator	5-3-96.3
Connecting Rod Bearings-Propulsion	4-3-40.3

INDEX (Continued)

Volume-Chapter
-Paragraph
or Table

C (continued)

Conning Tower	1-1-23.1, 2-2-159
Conning Tower and Air Ports-Maintenance Instructions	9-4-73
Conning Tower Equipment	2-2-128.1
Contact-Fire Pump Controller	11-5-121.1
Control Station	4-3-9.1
Control Unit and Linkage	4-3-9.2
Controller	9-4-35.8
Controller	10-5-52
Controller-Anchor Winch	7-3-191
Controller-Bow Ramp	6-3-121
Controller-Centralized Hydraulic System.....	3-T3-80
Controller-Hydraulic Cub Pump Unit	11-5-104
Controller-Ship's Hydraulic System	11-5-89
Starter (NEMA, SIZE D, 3 POLE)	11-5-89.1
Corrosion Prevention Anodes	11-6-5
Cranking Speed Too Low-Hydrostarter-Anchor Winch.....	3-T3-69
Cranking Speed Too Low-Hydrostarter	3-T3-32
Crankshaft-Anchor Winch	7-3-172
Crankshaft	7-3-172.2
Crankshaft Bearings	7-3-172.1
Crankshaft Seals	7-3-172.3
Crankshaft-Generator.....	5-3-97
Crankshaft	5-3-97.2
Crankshaft Bearings	5-3-97.1
Crankshaft Seals	5-3-97.3
Crankshaft-Propulsion	4-3-42
Crankshaft and Main Bearings	7-3.172
Crankshaft and Piston-Fire Pump (P-250)	8-4-7.7
Crankshaft Bearings-Anchor Winch	7-3-172.1
Crankshaft Bearings-Propulsion	4-3-41
Crankshaft Pulley	5-3-82
Crankshaft Pulley and Vibration Damper	4-3-25
Crankshaft Seals-Anchor Winch	7-3-172.3
Crankshaft Seals-Generator	5-3-97.3
Crankshaft Seals-Propulsion	4-3-43
Crankshaft Timing Gear-Anchor Winch	6-3-166.4
Crankshaft Timing Gear-Generator	5-3-91.4
Crankshaft Vibration Damper ..O.....	6-3-157
Crew and Transient Berthing-Controls and Indicators	1-2-8
Crew and Transient Berthing-Interior Arrangement	1-1-29
Cub Hydraulic Pump Unit-Principles of Operation	1-1-59
Cutting Anchor Cable	2-2-185
Cylinder Assemblies	9-4-45.4

INDEX (Continued)

Volume-Chapter
-Paragraph
or Table

C (continued)

Cylinder Block-Anchor Winch	11-5-79
Cylinder Block-Generator.....	10-5-43
Cylinder Block-Propulsion	10-5-20
Cylinder Block-Anchor Winch	7-3-173
Cylinder Block-Generator.....	5-3-98
Cylinder Block-Propulsion	4-3-44
Cylinder Head-Anchor Winch	6-3-164
Cylinder Head	6-3-164.1
Fuel Injector Tube	6-3-164.2
Cylinder Head-Generator	5-3-89
Cylinder Head	5-3-88.1
Fuel Injector Tube	5-3-89.2
Cylinder Head-Propulsion	4-3-34
Fuel Injector Tube	4-3-34.1
Cylinder Liner-Anchor Winch	7-171.4
Cylinder Liner-Generator	5-3-96.4
Cylinder Liner-Propulsion	4-3-40.4
Cylinder and Linkage-Hydraulic Cub Pump Unit	11-5-108

D

Damage Control	2-2-191
Break-Glass, Shut-Down Stations	2-2-203
Emergency Lighting	2-2-202
Fire Fighting	2-2-192
Salvage Pump	2-2-204
Watertight Integrity	2-2-205
Darken Ship	2-2-126
Deck Fittings	9-4-63, 11-5-164
Deck and Sanitary Drains	11-5-167
Deck and Sanitary Drain Piping System-Principles of Operation	1-1-72
Destruction of Army Materiel to Prevent Enemy Use	1-1-3
Diesel Oil Cooling Piping	9-4-58
Diesel Oil Cooling Pump	8-4-13
Diesel Oil Cooling Pump Motor Controller	8-4-13.4
Diesel Oil Cooling Pump Motor	8-4-13.3
Diesel Oil Cooling Pump	8-4-13.2
Diesel Oil Cooling Pump Set	8-4-13.1
Diesel Oil Cooling Pump Motor	11-5-129

INDEX (Continued)

Volume-Chapter
-Paragraph
or Table

D (continued)

Diesel Generator and Propulsion Engine-Hydraulic Starting System-Principles of Operation	1-1-88
Diesel Oil Piping	9-4-57, 11-5-161
Diesel Oil Stowage Tank	9-4-56
Differences Between Models	1-1-37
Directional Control Valve-Hydraulic Tank-Anchor Winch	3-T3-56
Directional Control Valve	7-3-208
Directional Valve-Pilot Operated-Hydraulic Tank-Anchor Winch	6-3-137.6
Directional Valve-Spring Centered Solenoid-Hydraulic Tank-Anchor Winch	6-3-136.9
Discharge Valve-Fire Pump (PE-250)	8-4-7.3A
Disconnect Clutch Assembly	10-5-65.1
Disconnect Clutch-Anchor Winch	3-T3-50
Disconnect Clutch	6-3-135, 10-5-65, 10-5-65.2
Disconnect Clutch	10-5-65
Clutch Hydraulic Cylinder	10-5-65.3
Disconnect Clutch Assembly	10-5-65.1
Disconnect Clutch	10-5-65.2
Disconnect Switch	5-3-110.6
Distribution Lighting Panels	10-5-45
Distribution Panels Lighting	5-3-109
Fuse Panels	5-3-109.2
Lighting Distribution Panels	5-3-109.1
Terminal Boxes	5-3-109.3
Docking	2-2-154
Aircraft Flood Lights	2-2-162
Exhaust Stacks	2-2-168
Floodlight	2-2-167
Jack and Ensign Staff, Signal Flag	2-2-166
Lifeboats	2-2-158
Machine Gun Tripod Mount	2-2-160
Main Mast	2-2-66
Radar Mast	2-2-155
Ready Service Locker	2-2-161
Searchlight	2-2-163
Ships Course Indicator and Peloris	2-2-164
Stern Gate Davits	2-2-165
Voice Tube	2-2-157
Whip Antennas	2-2-156
Windscreen and Railings	2-2-159

INDEX (Continued)

Volume-Chapter
-Paragraph or
Table

D (continued)

Doors, Hatches, Scuttles and Manholes	9-4-72
Doors, Hatches, and Scuttles	11-5-170
Draining Ballast Tanks-Using Fire Pump	2-2-95
-Using Gravity	2-2-93
Draining Bilge with Bilge Pump and Fire Pump	2-2-90
Draining Bilge with Bilge Pump	2-2-83
Draining Bilge with Fire Pump and Eductor	2-2-88
Draining Bilge with Fire Pump	2-2-85
Draining the Fire Main System	2-2-79, 2-2-87
Drinking Fountain	2-2-136, 9-4-38
Drive Brake Assembly	10-5-60
Drive Brake and Brake Control	6-3-130
Drive Gear Assembly	10-5-61
Drive Gear	6-3-131
Drum Assembly	6-3-133
Dryer-Air Conditioner System	8-4-32
Dryer Mechanism	9-4-41.3
Dryer Operation	2-2-141
Duct Heaters	8-4-26.2
Duplex Receptacles	5-3-110.4
Duplex Strainer	9-4-59

E

Elastomeric Compensating Winch	11-6-6
Electric Motor	11-5-86
Electric Motor and Coupling	7-3-188
Electric Power Generation and Distribution	10-5-28
Blower	10-5-35
Cylinder Block	10-5-43
Distribution Lighting Panels	10-5-45
Engine Assembly	10-5-33
Exhaust Manifold	10-5-40
Flywheel and Housing	10-5-41
Fresh Water Pump	10-5-37
Fuel Injector	10-5-36
Generator	10-5-32
Governor	10-5-34
Lube Oil Pump	10-5-42
Main Switchboard	10-5-29
Power Panel Boards	10-5-31
Running Light Control Panel	10-5-46

INDEX (Continued)

Volume-Chapter
-Paragraph
or Table

E (continued)

Electric Power Generation and Distribution
(Continued)

Thermostat and Housing	10-5-39
Transformers	10-5-30
24-Volt Rectifier	10-5-44
Water Manifold	10-5-38
Electric Power Generation and Distribution-	
Maintenance Instructions	5-3-58
Accumulator	5-3-102
Air Cleaner	5-3-81
Air Intake	5-3-67
Balance Weight Cover	5-3-83
Blower	5-3-68
Camshaft and Gear Train	5-3-91
Crankshaft	5-3-97
Crankshaft Pulley	5-3-82
Cylinder Block	5-3-98
Cylinder Head	5-3-89
Distribution Panels Lighting	5-3-109
Emergency Lighting	5-3-112
Engine Assembly	5-3-64
Engine Controls	5-3-65
Exhaust Manifold	5-3-85
Expansion Tank Water Connections	5-3-76
Flywheel and Housing	5-3-92
Fresh Water Pump	5-3-75
Fuel Filter, Strainer and Fuel Lines	5-3-70
Fuel Injector	5-3-71
Fuel Lines and Manifold Connections	5-3-72
Fuel Pump	5-3-69
Generator (12 V)	5-3-62
Generator (40 Kw)	5-3-63
Governor (Hydraulic)	5-3-66
Hydrostarter	5-3-101
Hydrostarter Piping (Aft Engine Room)	5-3-106
Hydrostarter Piping (Forward Engine Room)	5-3-105
Hydrostarter Pump (Engine-Driven)	5-3-103
Hydrostarter Pump (Hand)	5-3-104
Hydrostarter Reservoir, Filter, and Solenoid	5-3-107
Injector Controls	5-3-87
Instrument Panel	5-3-99
Lifter Brackets and Supports	5-3-84

INDEX (Continued)

Volume-Chapter
-Paragraph
or Table

E (continued)

Electric Power Generation and Distribution-
Maintenance Instructions (Continued)

Lights	5-3-111
Lube Oil Cooler	5-3-74
Lube Oil Distribution System	5-3-95
Lube Oil Filters and Housing/Breather	5-3-73
Lube Oil Pump	5-3-94
Lube Oil Pressure Regulator and By-Pass	5-3-93
Navigational Light Control Panel	5-3-114
Oil Pan, Dipstick and Oil Filler	5-3-88
Overspeed Governor	5-3-79
Panel Boards-Power Distribution and Shore Power Connection Box	5-3-61
Pistons, Connecting Rods and Cylinder Liners	5-3-96
Rectifier 24 VDC	5-3-108
Rocker Arm Cover	5-3-86
Running Signal and Anchor Lights	5-3-113
Switches	5-3-110
Switchboard (Main)	5-3-59
Starting Aid	5-3-100
Tachometer Drive	5-3-80
Thermostat and Housing	5-3-78
Transformers	5-3-60
Valve Operating Mechanism	5-3-90
Water Manifold	5-3-77
Electric Range	2-2-132
Electric Turret Heaters	8-4-26.1
Electronic Devices	2-2-128
Electronic and Navigation Systems	9-4-48
Electronics Foundations	9-4-48.1
Navigation Horn	9-4-48.2
24 Volt Distribution Panel	9-4-48.3
Electronics Foundations	9-4-48.1
Emergency Life Saving Equipment-Exterior Orientation	1-1-13
Emergency Lighting	2-2-202, 5-3-112
Incandescent Lighting Fixture-Symbol 98.1	5-3-112.1
Portable Lantern	5-3-112.3
Relay Operated Lantern	5-3-112.2

INDEX (Continued)

Volume-Chapter
-Paragraph
or Table

E (continued)

Emergency Procedures	2-2-171
Anchor Winch System	2-2-181
Bow Ramp System	2-2-187
Emergency Steering	2-2-186
Generating System	2-2-177
Propulsion System	2-2-172
Stern Gate	2-2-190
Emergency Shutdown-Controls and Indicators	1-2-15
Emergency Shutdown-Head and Linkage-Generator.....	5-3-65.1
Emergency Shutdown Head and Linkage-Propulsion	4-3-9.3
Emergency Steering	2-2-186
Emergency Steering Components-Exterior Orientation.....	1-1-18
Emergency Steering System	7-3-218
Emptying Holding Tank	2-2-100
Engine Access Room-Controls and Indicators	1-2-5
-Interior Arrangement	1-1-26
Engine Assembly-Anchor Winch	6-3-140
Engine Assembly-Generator	5-3-64
Engine Assembly-Removal and Run-In-Generator	5-5-69, 10-5-33
Engine Clutch and Throttle Controls	6-3-141.1
Engine Controls-Anchor Winch	6-3-141
Engine Clutch and Throttle Controls	6-3-141.1
Engine Throttle Linkage	6-3-141.2
Stop Cable and Linkage	6-3-141.3
Engine Controls-Generator.....	5-3-65
Automatic Electrical Shut-down System	5-3-65.3
Fuel Oil Pressure Alarm Switch	5-3-65.3.3
Lubricating Oil Pressure Alarm Switch	5-3-65.3.4
Time Delay Relay	5-3-65.3.1
Water Temperature Alarm Switch	5-3-65.3.2
Emergency Shut-down-Head and Linkage.....	5-3-65.1
Shut-down Solenoid	5-3-65.2
Engine Control Panel-Fire Pump (PE-250)	8-4-7.1A
Engine Cooling Water System-Principles of Operation	1-1-66
Engine Exhaust	9-4-60
Engine Exhaust Piping	11-5-162
Engine-Fire Pump (PE-250)	8-4-7.10A
Engine Lube Oil Transfer System-Principles of Operation	1-1-69
Engine Supports and Lifting Brackets-Anchor Winch.....	6-3-159

INDEX (Continued)

Volume-Chapter
-Paragraph
or Table

E (continued)

Engine Supports, Lifter Brackets and Crankshaft	
Front Cover-Main Propulsion	4-3-27
Engine Supports, Lifter Bracket, and Crankshaft Front Cover	10-5-14
Engine Throttle Linkage	6-3-141.2
Engine Timing-Anchor Winch	6-3-166.2
Engine Timing-Generator	5-3-91.2
Engine/Transmission Controls	4-3-9
Control Station	4-3-9.1
Control Unit and Linkage	4-3-9.2
Emergency Shutdown Head and Linkage	4-3-9.3
Hydrostarter Deactivate Switch	4-3-9.6
Lubricating Oil Pressure Switch	4-3-9.5
Water Temperature Switch	4-3-9.4
Engine and Transmission Controls	10-5-6
Entertainment Amplifier	2-2-131
Equipment Data	1-1-38
Equipment Purpose, Capabilities and Features	1-1-8
Excessive Crankcase Pressure-Anchor Winch Engine	3-T3-64
Excessive Crankcase Pressure-Generator	3-T3-27
Excessive Crankcase Pressure-Propulsion	3-T3-6
Exhaust Fan Controller-HVAC	11-5-138
Exhaust Fan Motor-HVAC	11-5-139
Exhaust Manifold-Anchor Winch	11-5-76
Exhaust Manifold-Generator	10-5-40
Exhaust Manifold-Anchor Winch	6-3-160
Exhaust Manifold-Generator	5-3-85
Exhaust Manifold and Fittings	4-3-28
Exhaust Pipe Hangers	11-5-157
Exhaust Piping System-Principles of Operation	1-1-67
Exhaust Smoke Analysis-Anchor Winch Engine	3-T3-59
Exhaust Smoke Analysis-Generator	3-T3-22
Exhaust Smoke Analysis-Propulsion	3-T3-1
Exhaust Stacks	2-2-168
Exhaust Valve-Anchor Winch	6-3-165.2
Exhaust Valve-Generator	5-3-90.2
Exhaust Valve-Propulsion	4-3-33.2
Expansion Tank	10-5-10
Expansion Tank	4-3-19
Expansion Tank and Water Connections	5-3-76
Exterior Cabinet Removal	9-4-41.1

INDEX (Continued)

Volume-Chapter
-Paragraph
or Table

E (continued)

Exterior Orientation

Anchor "A" Frame and Control Station	1-1-17
Bow Ramp	1-1-19
Emergency/Life Saving Equipment	1-1-13
Emergency Steering Components	1-1-18
First Aid Equipment	1-1-16
Machine Gun, Ready Service Lockers and Grenade Lockers	1-1-14
Miscellaneous Components on Cargo Deck	1-1-21
Mooring, Towing, Causeway Fittings and Locking Gear	1-1-12
Running Lights, Peloris, Masts, Flags and Ensigns.....	1-1-15
Stern Gate	1-1-20

F

Fairleader	7-3-183
Fairleader-Anchor "A" Frame	11-5-83
Filling Ballast Tanks-Using Fire Pump	2-2-94
Filling Ballast Tanks-Using Gravity	2-2-92
Fire Alarm Panel	9-4-45.2
Fire Alarm Switch Box	2-2-128.1
Fire, Ballast and Bilge Piping	11-5-158
Fire, Bilge and Ballast Piping	9-4-53
Fog Nozzle	9-4-53.5
Gauge Piping	9-4-53.2
Piping	9-4-53.1
Simplex Strainer	9-4-53.3
Wye Strainer	9-4-53.4
Fire, Bilge, and Ballast System.....	2-2-75
Ballast System	2-2-91
Bilge System	2-2-82
Fire System	2-2-76
Fire Detection/Extinguishing System	11-5-146
Fire Detection/Extinguishing System	9-4-45
Cylinder Assemblies	9-4-45.4
Fire Fighting System	9-4-45.1
Fire Alarm Panel	9-4-45.3

INDEX (Continued)

Volume-Chapter-
-Paragraph
or Table

F (continued)

Fire Fighting	2-2-192
Fire Main System	2-2-193
Halon Fixed System	2-2-194
Liquid Foam	2-2-201
Portable Extinguishers	2-2-195
Portable Fire Pump	2-2-196
Fire Fighting System	9-4-45.1
Fire Fighting Systems-Interior Arrangements	1-1-36
Fire Mains and Fire Plugs	2-2-77
Fire Main System	2-2-193
Draining the Firemain System	2-2-79
Fire Mains and Fire Plugs	2-2-77
Fire Pump-Shutdown	2-2-78
Fire Pump	11-5-119
Fire Pump	8-4-8
Fire Pump Motor Controller	8-4-8.4
Fire Pump Motor	8-4-8.3
Fire Pump	8-4-8.2 '4_-J3
Fire Pump Set	8-4-8.1
Simplex Strainer	8-4-8.5
Fire Pump, Bilge Draining Shutdown	2-2-86
Fire Pump Controller	11-5-121
Contactor	11-5-121.1
M-Type Relay	11-5-121.3
Starter (NEMA, Size 3, 3 Pole Reversing)	11-5-121.2
Fire Pump and Educator Shutdown	2-2-89
Fire Pump Motor	11-5-120
Fire Pump-Shutdown	2-2-78
Fire System	2-2-76
Draining the Fire Main System	2-2-79
Fire Mains and Fire Plugs	2-2-77
Fire Pump-Shutdown	2-2-78
Magazine Sprinkler	2-2-80
Peak Ballast Tank Filling	2-2-81
Fire System Piping-Principles of Operation	1-1-74
First Aid Equipment-Exterior Orientation	1-1-16
Flanking Rudder Limit Switch	7-3-214
Flanking Rudder Limit Switch	11-5-113
Flanking Rudder Limit Switch Assembly-Principles of Operation	1-1-62
Floodlight	2-2-167
Floodlight	5-3-111.4

INDEX (Continued)

Volume-Chapter
-Paragraph
or Table

F (continued)

Fluid Emerges Around Rubber Boot of Hand Pump- Hydrostarter-Anchor Winch	3-T3-77
Fluid Emerges Around Rubber Boot of Hand Pump- Hydrostarter	3-T3-40
Fluid Emerges Around Rubber Boot of Hand Pump- Propulsion	3-T3-20
Fluid Emerges from Ends of Starter Control Valve When Starter Is Operated-Hydrostarter	3-T3-41
Fluid Emerges from Ends of Starter Control Valve When Starter is Operated-Propulsion	3-T3-21
Fluid Emerges from the Reservoir Filler Cap When Starter Is Used-Hydrostarter-Anchor Winch	3-T3-76
Fluid Emerges from Reservoir Filler Cap When Starter Is Used-Hydrostarter	3-T3-39
Fluid Emerges from the Reservoir Filler Cap When Starter Is Used-Propulsion	3-T3-19
Fluorescent Desk Lamp	5-3-111.5
Flush Valve	8-4-21
Flushing System Piping-Principles of Operation	1-1-77
Flywheel-Anchor Winch	6-3-167.1
Flywheel-Generator	5-3-92.1
Flywheel and Housing-Anchor	11-5-77
Flywheel and Housing-Generator.....	10-5-41
Flywheel and Housing-Propulsion	10-5-18
Flywheel and Housing-Anchor	6-3-167
Flywheel	6-3-167.1
Flywheel Housing	6-3-167.2
Flywheel and Housing-Generator	5-3-92
Flywheel	5-3-92.1
Flywheel Housing	5-3-92.2
Flywheel and Housing-Propulsion	4-3-32.1
Flywheel and Housing and Oil Breather	4-3-32
Flywheel and Housing	4-3-32.1
Oil Breather	4-3-32.2
Flywheel Housing-Anchor Winch	6-3-167.2
Flywheel Housing-Generator	5-3-92.2
Fog Nozzle	9-4-53.5
Foot Valve Assembly-Fire Pump (P-250)	8-4-7.8
Forward Engine Room-Controls and Indicators	1-2-10
Forward Engine Room-Interior Arrangement	1-1-31
Frame and Drum Assembly	10-5-63

INDEX (Continued)

Volume-Chapter '
-Paragraph
or Table

F (continued)

Fresh and Flush Water Piping	9-4-62, 11-5-163
Fresh Water Pump-Anchor Winch	6-3-150
Fresh Water Pump-Generator	5-3-75
Fresh Water Pump-Propulsion	4-3-18
Fresh Water Pump-Anchor Winch	11-5-73
Fresh Water Pump-Generator	10-5-37
Fresh Water Pump	8-4-11
Fresh Water Pump Motor Controller	8-4-11. 4
Fresh Water Pump Motor	8-4-11.3
Fresh Water Pump	8-4-11.2
Fresh Water Pump Set	8-4-11.1
Fresh Water Pump Controller	11-5-126
Fresh Water Pump Motor	11-5-125
Fresh Water System	2-2-73
Fresh Water System Piping-Principles of Operation	1-1-71
Fuel Filter, Fuel Strainer, Fuel Lines and Manifold Connections	6-3-146
Fuel Filter	6-3-146.1
Fuel Lines and Manifold Connections	6-3-145.3
Fuel Strainer	6-3-145.2
Fuel Filter and Strainer-Generator	5-3-70
Fuel Filter	5-3-70.1
Fuel Strainer	5-3-70.2
Fuel Filter, Strainer and Fuel Lines-	4-3-14
Fuel Filter	4-3-14.1
Fuel Lines	4-3-14.3
Fuel Strainer	4-3-14.2
Fuel Filter-Anchor Winch	6-3-146.1
Fuel Filter-Generator	5-3-70.1
Fuel Filter-Propulsion	4-3-14.1
Fuel Injector-Anchor Winch	6-3-147
Fuel Injector-Generator	5-3-71
Fuel Injector-Propulsion	4-3-15
Fuel Injector-Anchor Winch	11-5-72
Fuel Injector-Generator.....	10-5-36
Fuel Injector-Propulsion.....	10-5-9
Fuel Injector Controls-Generator	4-3-87
Fuel Injector Controls-Propulsion	4-3-31
Fuel Filter/Water Separator	9-4-61.1
Fuel Injector Tube-Anchor Winch	6-3-164.2
Fuel Injector Tube-Generator	5-3-89.2
Fuel Injector Tube-Propulsion	4-3-34.1

INDEX (Continued)

Volume-Chapter
-Paragraph
or Table

F (continued)

Fuel Lines	4-3-14.3
Fuel Lines and Manifold Connections-Anchor Winch	6-3-146.3
Fuel Lines and Manifold Connections-Generator	5-3-72
Fuel Oil Pressure Alarm Switch	5-3-65.3.3
Fuel Pump-Generator	5-3-69
Fuel Pump-Propulsion	4-3-13
Fuel Pump and Drain Lines-Anchor Winch	6-3-145
Fuel Tank Assembly-Fire Pump (P-250)	8-4-7.4
Fuel Strainer-Anchor Winch	6-3-146.2
Fuel Strainer-Generator	4-3-70.2
Fuel Strainer-Propulsion	4-3-14.2
Fuel System	2-2-27
Fuel System-Principles of Operation	1-1-68
Furniture and Miscellaneous Furnishings	9-4-70, 11-5-169
Fuse Panels	5-3-109.2

G

Gauges	11-5-90
Gauge Boards-Air Conditioner System	8-4-33
Gauge and Isolator	7-3-192
Gauge Panel-Fire Pump (PE-250)	8-4-7.2A
Gauge Piping	9-4-53.2
Galley and Mess	2-2-129
Coffee Maker	2-2-133
Drinking Fountain	2-2-136
Electric Range	2-2-132
Entertainment Amplifier	2-2-131
Milk Dispenser	2-2-134
Refrigerator/Freezer	2-2-135
Sanitizing Sink Heater	2-2-137
Toaster	2-2-131
Galley and Mess Room-Controls and Indicators	1-2-3
-Interior Arrangement	1-1-24
Galley Range	9-4-43
Gate, Hinges and Springs	10-5-55
Gate, Hinges, Springs-Stern Gate	6-3-126
Gear Train-Anchor Winch	6-3-166.1
Gear Train-Generator	5-3-91.1

INDEX (Continued)

Volume-Chapter
-Paragraph
or Table

G (continued)

General	7-3-220, 8-4-1, 8-4-4, 8-4-5
Operations Under Unusual Conditions	2-2-170
Operations Under Usual Conditions	2-2-19
General Familiarization	1-1-10
General Information-Scope	1-1-1
General Lubrication	3-3-4
General Repair Parts, Special Tools, TMDE and Support Equipment	3-3-1
General-Repair Parts, Special Tools, TMDE and Support Equipment	10-5-1
General Support Maintenance Instructions	
Corrosion Prevention Anodes	11-6-5
Propeller Shaft and Bearings	11-6-1
Remote Magnetic Heading Compass	11-6-4
Shaft Seals	11-6-2
Steering Control Panel and Gyro Computer	11-6-3
General Purpose Fluorescent Fixture (2 Tube)	5-3-111.6
General Troubleshooting-Symptom Index	3-3-5
General-Troubleshooting	10-5-2
Generator	3-T3-42
Generator (12-DC).....	5-3-62
Generator (12 VDC)	5-3-62.1
Voltage Regulator	5-3-62.2
Generator (40 Kw)	5-3-63
Generator (40 Kw)	10-5-32
Generator-Principles of Operation	1-1-47
Generator Engine	
Abnormal Engine Coolant Operating Temperature	3-T3-29
Abnormal Engine Operation	3-T3-24
Cold Weather Start	2-2-38
Emergency Start	2-2-180
Emergency Stop	2-2-179
Excessive Crankcase Pressure	3-T3-27
Exhaust Smoke Analysis	3-T3-22
Hard Starting	3-T3-23
High Lubricating Oil Consumption	3-T3-26
Local Start	3-3-37
Local Stop	2-2-44
Generator Engine-Principles of Operation	1-1-46

INDEX (Continued)

Volume-Chapter
-Paragraph
or Table

G (continued)

Generating System-Emergency Procedures	2-2-177
Generator Engine-Emergency Start	2-2-180
-Emergency Stop	2-2-178
-Reset After Emergency Stop	2-2-179
Generating System	2-2-34
Generator Engine-Cold Weather Start	2-2-38
-Local Starting	2-2-37
-Local Stop	2-2-44
Ground Detector Lights	2-2-45
Paralleling Generator	2-2-41
Preliminary Adjustments	2-2-36
Remote Operation-Generator #1	2-2-39
-Generator #2	2-2-40
Shore Power	2-2-35
Stopping Generator-Operating Non-Parallel	2-2-42
-Operating Parallel	2-2-43
Governor-Anchor Winch	11-5-70
Governor-Generator	10-5-34
Governor-Anchor Winch	6-3-142.1
Governor-Hydraulic-Generator	5-3-66
Governor (Hydraulic)	5-3-66.1
Governor Oil Filter	5-3-66.2
Synchronizing Motor	5-3-66.3
Governor-Propulsion	4-3-10
Governor and Breather Tubes	6-3-142
Breather Tubes	6-3-142.2
Governor	6-3-142.1
Governor (Hydraulic)-Generator	5-3-66.1
Governor Oil Filter	5-3-66.2
Ground Detector Lights	2-2-45

H

Halon Control Panel	9-4-45.2
Halon Fixed System	2-2-194
Alarms	2-2-117
Halon System	2-2-115
Reactivation	2-2-118
Testing	2-2-119
Turn-On	2-2-116

INDEX (Continued)

Volume-Chapter
-Paragraph
or Table

H (continued)

Halon System	2-2-115
Alarms (Automatic-Manual-Remote Manual)	2-2-117
Reactivation	2-2-118
Testing	2-2-119
Halon Warning System Turn On	2-2-116
Halon Systems	1-1-81
Hand Crank Interlock Limit Switch	6-3-123.2
Hand Pump Fails to Discharge Fluid-Hydrostarter-	
Anchor Winch	3-T3-72
Hand Pump Fails to Discharge Fluid-Hydrostarter	3-T3-35
Hand Pump Fails to Discharge Fluid-Propulsion A.....	3-T3-15
Hand Receipts	1-1-7
Hard Starting-Anchor Winch Engine	3-T3-60
Hard Starting-Generator	3-T3-23
Heading Selector	3-T3-89
Heading Selector	7-3-216
Heading Selector-Principles of Operation	1-1-60
Heat Exchanger Tank	4-3-19
Heat Interchanger	9-4-35.3
Heaters	2-2-121
Heating, Ventilation and Air Conditioning Systems-	
Principles of Operation	1-1-79
Heating, Ventilation, and Air Conditioner System	8-4-22
Air Conditioner System	8-4-28
Centrifugal Fan and Motor	8-4-27
HVAC Ducting	8-4-24
HVAC Exhaust Fan and Motor	8-4-25
HVAC Heating System	8-4-26
HVAC Supply Fan and Motor	8-4-23
Heating, Ventilation and Air Conditioning System.....	11-5-134
Compressor	11-5-140
Compressor Controller	11-5-142
Compressor Motor	11-5-141
Exhaust Fan Controller	11-5-138
Exhaust Fan Motor	11-5-139
HVAC Ducting	11-5-137
Recirculating Fan Controller	11-5-135
Recirculating Fan Motor	11-5-136
High Intensity Light	9-4-75
High Lubricating Oil Consumption-Generator	3-T3-26

INDEX (Continued)

Volume-Chapter
-Paragraph
or Table

H (continued)

High Pressure in System (3500 Psi (24,133 kPa) or above)-Hydrostarter-Anchor Winch	3-T3-75
High Pressure in System (3500 psi (24,133 kPa) or above)-Hydrostarter	3-T3-38
High Pressure in System (3500 psi (24,133 kPa) or above)-Propulsion	3-T3-18
Hood Assembly	2-2-146
Horns (NH and 5U)	2-2-151
Hose and Fittings-Mast Hydraulic System	11-5-98
Hose and Fittings-Stern Anchor Hydraulic System	11-5-101
Hose, Fittings, and Piping	11-5-94
Hose, Piping, and Valves-Hydraulic Cub Pump Unit	11-5-109
Hoses, Lines and fittings	6-3-139.2
Hot Water Heater	11-5-166
Hot Water Heater	9-4-65
Housing/Breather	6-3-73.2
Hull and Outfit	9-4-68
Conning Tower and Air Ports	9-4-73
Doors, Hatches, and Scuttles and Manholes	9-4-72
Furniture and Miscellaneous Furnishings	9-4-70
High Intensity Light	9-4-75
Lashing Gear	9-4-70
Mooring and Towing Fittings	9-4-74
Portable Air Compressor	9-4-71
Searchlight	9-4-77
Stanchions and Railings	9-4-69
Windshield Wiper	9-4-76
HVAC Ducting	11-5-137
HVAC Ducting	8-4-24
HVAC Exhaust Fan and Motor	8-4-25
HVAC Heating System	8-4-26
Duct Heaters	8-4-26.2
Electric Turret Heaters	8-4-26.1
Thermostats	8-4-26.3
HVAC Supply Fan and Motor	8-4-23
Hydraulic Cub Pump Unit-Brake Valve	7-3-207
Hydraulic Cub Pump Unit-Directional Control Valve.....	7-3-208
Hydraulic Cub Pump Unit-Hydraulic Pump	7-3-206
Hydraulic Cub Pump Unit-Hydraulic Reservoir, Tank and Strainer	7-3-209
Hydraulic Cub Pump Unit-Motor	7-3-204
Hydraulic Cub Pump Unit-Motor Controller	7-3-205

INDEX (Continued)

Volume-Chapter En-
-Paragraph
or Table

H (continued)

Hydraulic Cub Pump Unit-	
Brake Valve	11-5-106
Controller	11-5-104
Cylinder and Linkage	11-5-108
Hoses, Piping and Valves	11-5-109
Motor	11-5-103
Pump	11-5-105
Reservoir, Tank and Strainer	11-5-107
Hydraulic Control.....	11-5-93
Hydraulic Cylinder-Mast Hydraulic System	11-5-97
Hydraulic Cylinder-Stern Gate Hydraulic System	11-5-95
Hydraulic Directional Control Valve	3-T3-86
Hydraulic Filter-Hydraulic Tank-Anchor Winch	6-3-137.2
Hydraulic Filter and Piping-Anchor Winch	11-5-80
Hydraulic Motor	7-3-189
Hydraulic Power Unit-Centralized Hydraulic System	3-T3-79
Hydraulic Power Unit and Return	7-3-187
Hydraulic Pump-Anchor Winch	3-T3-58
Hydraulic Pump-Anchor Winch	6-3-139.1
Hydraulic Pump	11-5-87
Hydraulic Pump, Hoses, and Fittings	6-3-139
Hydraulic Pump	6-3-139.1
Hoses, Lines and Fittings	6-3-139.2
Hydraulic Reservoir-Anchor Winch	11-5-81
Hydraulic Reservoir-Hydrostarter	10-5-25
Hydraulic Reservoir-Ship's Hydraulic System	11-5-88
Hydraulic Reservoir Tank and Suction Filter	7-3-190
Hydraulic Starting System	2-2-20
Aft Engine Room-Preliminary Adjustments	2-2-23
-Shut Down	2-2-24
Anchor Winch Compartment-Preliminary Adjustments.....	2-2-25
-Shut Down	2-2-26
Forward Engine Room-Preliminary Adjustments	2-2-21
-Shut Down	2-2-22
Hydraulic Starting System Piping (Aft Engine Room)	1 0-5-27
Hydraulic Starting System Piping (Forward Engine Room)	10-5-26
Hydraulic Starting Systems-Principles of Operation	1-1-86
Anchor Winch Compartment	1-1-87
Diesel Generator And Propulsion Engines	1-1-88
Hydraulic Steering Cylinder and Adjustable Links	3-T3-87
Hydraulic Systems-Principles of Operation	1-1-54
Hydraulic Tank-Anchor Winch	3-T3-57

INDEX (Continued)

Volume-Chapter
Paragraph or
Table

H (continued)

Hydraulic Tank Assembly	6-3-137
Check Valve	6-3-137.5
Directional Valve-Pilot Operated	6-3-137.6
Directional Valve-Spring Centered Solenoid	6-3-137.9
Hydraulic Filter	6-3-137.2
Pilot Valve and Manifold	6-3-137.3
Pressure Control Valve	6-3-137.4
Pressure Reducing Valve	6-3-137.8
Relief Valve	6-3-137.7
Tank Assembly	6-3-137.1
Hydraulic Winch	11-5-100
Hydrostarter	
Cranking Speed Too Low	3-T3-32
Fluid Emerges Around Rubber Boot of Hand Pump	3-T3-40
Fluid Emerges from Ends of Starter Control	
Valve When Starter Is Operated	3-T3-41
Fluid Emerges from Reservoir Filler Cap	
When Starter Is Used	3-T3-39
Hand Pump Fails to Discharge Fluid	3-T3-35
High Pressure in System (3500 psi (24,133 kPa or above)	3-T3-38
Loss of Accumulator Precharge (Nitrogen)	3-T3-37
Loss of Fluid Pressure When Engine Is Not Running.....	3-T3-34
Loss of Fluid from Reservoir	3-T3-33
Loss or No Accumulator Pressure	3-T3-31
Starter Turns but Engine Does Not	3-T3-36
Low or High Exhaust Valve Opening Pressure	3-T3-30
Low Oil Pressure	3-T3-28
No Fuel or Insufficient Fuel	3-T3-25
Hydrostarter	10-5-21
Hydrostarter-Anchor Winch	7-3-176
Hydrostarter-Engine Driven Pump	10-5-23
Hydrostarter-Generator	5-3-101
Hydrostarter-Propulsion	4-3-46
Hydrostarter Filter-Anchor Winch	7-3-180.2
Hydrostarter Filter-Generator	5-3-107.2
Hydrostarter Filter-Propulsion	4-3-52.2
Hydrostarter Deactivate Switch	4-3-9.6
Hydrostarter Hand Pump-Anchor Winch	7-3-179
Hydrostarter Piping-Anchor Winch	7-3-181
Hydrostarter Piping (Aft Engine Room)-Generator	5-3-106
Hydrostarter Piping (Aft Engine Room)-Propulsion	4-3-51

INDEX (Continued)

Volume-Chapter
-Paragraph
or Table

H (continued)

Hydrostarter Piping (Forward Engine Room)- Generator	5-3-105
Hydrostarter Piping (Forward Engine Room)- Propulsion	4-3-50
Hydrostarter Pump (Engine-Driven)-Anchor Winch	7-3-178
Hydrostarter Pump (Engine-Driven)-Generator	5-3-103
Hydrostarter Pump (Engine-Driven)-Propulsion	4-3-48
Hydrostarter Pump (Hand)-Generator	5-3-104
Hydrostarter Pump (Hand)-Propulsion	4-3-49
Hydrostarter Reservoir-Anchor Winch	7-3-180.1
Hydrostarter Reservoir-Generator	5-3-107.1
Hydrostarter Reservoir-Propulsion	4-3-52.1
Hydrostarter Reservoir and Filter-Anchor Winch	7-3-180
Hydrostarter Filter	7-3-180.2
Hydrostarter Reservoir	7-3-180.1
Hydrostarter Reservoir and Filter-Generator	5-3-107
Hydrostarter Filter	5-3-107.2
Hydrostarter Reservoir	5-3-107.1
Hydrostarter Reservoir and Filter-Propulsion	4-3-52
Hydrostarter Filter	4-3-52.2
Hydrostarter Reservoir	4-3-52.1
Hydrostarter Reservoir, Filter, and Solenoids- Generator	5-3-107
Hydrostarter Solenoid	10-5-24

I

Idler Gear	10-5-19.2
Idler Gear and Bearing Assembly-Anchor Winch	6-3-166.3
Idler Gear and Bearing Assembly-Generator	5-3-91.3
Idler Gear Hole Spacer	10-5-19.3
Incandescent Bulkhead Fixture-Numbers 3532F6 and 3532F6R	5-3-111.1
Incandescent Bulkhead Fixture-Number 3541	5-3-111.2
Incandescent Ceiling Fixture	5-3-111.3
Incandescent Lighting Fixture-Symbol 98.1	5-3-112.1
Injector Controls-Anchor Winch	6-3-162
Injector Controls-Generator	5-3-87
Injector Controls-Propulsion	4-3-31

INDEX (Continued)

Volume-Chapter
-Paragraph
or Table

I (continued)

Installation of Separately Packed Components	3-3-3, 8-4-3
Instrument Panel-Anchor Winch	7-3-174
Instrument Panel-Generator	5-3-99
Instrument Panel-Propulsion	4-3-24
Interior Arrangements	1-1-22
Aft Engine Room	1-1-32
Air Conditioning Machinery Room	1-1-28
Anchor Winch Compartment	1-1-33
Bow Ramp Winch Compartment and Deck Locker	1-1-27
Crew and Transient Berthing	1-1-29
Engine Access Room	1-1-26
Fire Fighting Systems	1-1-36
Forward Engine Room	1-1-31
Galley	1-1-24
Pilot House	1-1-23
Propellers, Rudders and Keel Coolers	1-1-35
Steering Gear Compartment	1-1-34
Tank and Auxiliary Machinery Compartment	1-1-30
Wash Room, Water Closet and Shower	1-1-25
Interior Communications	2-2-147
Communications (1JV and E)	2-2-149
Horns (NH and 5U)	1-2-150
Interior Communications Turn ON/OFF	2-2-148
Interior Communication System	9-4-46, 11-5-148
Amplifier/Loudspeaker	9-4-46.1
Call System Major Components	9-4-46.4
Loudhailer	9-4-46.3
Sound Powered Phones	9-4-46.2
Voice Tube	9-4-46.5
Interior Communication Systems	11-5-147
Alarm Switchboard	11-5-149
Amplifier/Loudspeaker	11-5-151
Interior Communication System	11-5-148
Loudhailer.....	11-5-152
Thermostat Switch and Magazine Alarm	11-5-150
Interior Communication Systems-Principles of Operation	1-1-83
Interior Communications Turn ON/OFF	2-2-148
Interlock Door Operated Switch	5-3-110.5
Intermediate Storage	7-3-222

-INDEX (Continued)

Volume-Chapter
-Paragraph
or Table

K

Kort Nozzles, Rudders and Fences-Principles of Operation

1-1-44

L

Lashing Gear

9-4-78

Level Wind

6-3-132

Level Wind Assembly

10-5-62

Life Boats

2-2-158, 2-2-209

Life Preservers

2-2-207

Life Rings

2-2-208

Life Saving Equipment

2-2-206

 Life Boats

2-2-209

 Life Preservers

2-2-207

 Life Rings

2-2-208

 Oxygen Breathing Apparatus

2-2-210

 Pyrotechnic

2-2-211

Lifter Brackets and Supports

5-3-84

Lighting

2-2-122

Lighting Distribution Panels

5-3-109.1

Lighting Distribution Systems-Principles of Operation

1-1-50

Lights

5-3-111

 Berth Light

5-3-111.9

 Floodlight

5-3-111.4

 Fluorescent Desk Lamp

5-3-111.5

 General Purpose Fluorescent Fixture (2 Tube)

5-3-111.6

 Incandescent Bulkhead Fixture-Numbers 3532F6 and 3532F6R

5-3-111.1

 Incandescent Bulkhead Fixture-Number 3541

5-3-111.2

 Incandescent Ceiling Fixture-Number 3528F6

5-3-111.3

 Mirror Light Fixture

5-3-111.7

 Secretary Light Fixture

5-3-111.8

Limit Switches and Wire Rope Guards-Bow Ramp

6-3-123

 Hand Crank Interlock Limit Switch

6-3-123.2

 Slack Cable Interlock Limit Switch

6-3-123.1

 Wire Rope Guard and Slack Cable Interlock Limit Switch Bracket

6-3-123.3

2-Line Alarm Panel

9-4-47.2

Liquid Foam

2-2-201

INDEX (Continued)

Volume - Chapter
Paragraph or Table

L (continued)

Liquid Solenoid Valve	9-4-35.1
List of Abbreviations	1-1-6
Local Controller Switches - Winch Compartment and Deck Locker - Bow Ramp	6-3-122.2
Location and Description of Major Components	1-1-9
Loss of Accumulator Precharge (Nitrogen) - Hydrostarter - Anchor Winch	3-T3-75
Loss of Accumulator Precharge (Nitrogen) - Hydrostarter	3-T3-37
Loss of Accumulator Precharge (Nitrogen) - Propulsion	3-T3-17
Loss of Fluid Pressure - Engine Not Running - Propulsion	3-T3-14
Loss of Fluid Pressure When Engine Is Not Running - Hydrostarter - Anchor Winch	3-T3-71
Loss of Fluid Pressure When Engine Is Not Running - Hydrostarter	3-T3-34
Loss of Fluid from Reservoir - Hydrostarter - Anchor Winch	3-T3-70
Loss of Fluid from Reservoir - Hydrostarter	3-T3-33
Loss of Fluid from Reservoir - Propulsion	3-T3-13
Loss or No Accumulator Pressure - Hydrostarter	3-T3-31
Loss or No Accumulator Pressure - Propulsion	3-T3-11
Loudhailer	11-5-152
Loudhailer	9-4-46.3
Low or High Exhaust Valve Opening Pressure - Anchor Winch Engine	3-T3-67
Low or High Exhaust Valve Opening Pressure - Hydrostarter	3-T3-30
Low or High Exhaust Valve Opening Pressure - Propulsion	3-T3-9
Lowering Bow Ramp - Emergency Procedures	2-2-188
-Local	2-2-55
-Remote	2-2-53
Low or No Accumulator Pressure - Anchor Winch Engine.....	3-T3-68
Low Oil Pressure - Anchor Winch Engine	3-T3-65
Low Oil Pressure - Hydrostarter.....	3-T3-28
Low Oil Pressure - Propulsion	3-T3-7
Lube Oil Cooler - Anchor Winch	6-3-149
Lube Oil Cooler - Generator	5-3-74
Lube Oil Distribution System - Anchor Winch	6-3-170
Lube Oil Distribution System - Generator	5-3-95
Lube Oil Distribution System - Propulsion	4-3-39

INDEX (Continued)

Volume - Chapter
Paragraph or Table

L (continued)

Lube Oil Filter	5-3-70.1
Lube Oil Filters, Hoses, and Housing - Anchor Winch.....	6-3-148
Oil Filter (By-pass) - Hoses and Housing	6-3-148.2
Oil Filter (Full Flow)	6-3-148.1
Lube Oil Filters and Housing - Propulsion	4-3-16
Lube Oil Filters and Housing/Breather - Generator.....	5-3-73
Housing/Breather	5-3-73.2
Lube Oil Filter	5-3-73.1
Lube Oil Piping	11-5-160
Lube Oil Piping System	9-4-55
Lube Oil Pressure Relief Valve	4-3-36
Lube Oil Pressure Regulator - Anchor Winch	6-3-168.1
Lube Oil Pressure Regulator - Generator	5-3-93.1
Lube Oil Pressure Regulator - Propulsion	4-3-37
Lube Oil Pressure Regulator and By-Pass - Generator.....	5-3-93
Lube Oil Pressure Regulator	5-3-93.1
Oil By-pass Valve	5-3-93.2
Lube Oil Pressure Regulator and Oil By-Pass - Anchor Winch	6-3-168
Lube Oil Pressure Regulator	6-3-168.1
oil By-pass Valve	6-3-168.2
Lube Oil Pressure Regulator and Relief Valve	10-5-17
Lube Oil Pump - Anchor Winch	11-5-78
Lube Oil Pump - Generator	10-5-42
Lube Oil Pump - Propulsion	10-5-16
Lube Oil Pump - Anchor Winch	6-3-169
Lube Oil Pump - Generator	5-3-94
Lube Oil Pump - Propulsion	4-3-38
Lube Oil Pump Controller	11-5-124
Lube Oil Pump Controller	8-4-10.4
Lube Oil Pump Motor.....	11-5-123
Lube Oil Pump Motor.....	8-4-10.4
Lube Oil Pump	8-4-10.2
Lube Oil Pump Set	8-4-10.1
Lube Oil Transfer Pump	8-4-14
Lube Oil Transfer System	2-2-62
Lubricating Oil Cooler	4-3-17
Lubricating Oil Pressure Alarm Switch	5-3-65.4
Lubricating Oil Pressure Switch	4-3-9.5

INDEX (Continued)

Volume - Chapter
Paragraph or Table

M

Macerator/Transfer Pump	8-4-17
Macerator/Transfer Pump	8-4-17.2
Macerator/Transfer Pump Set	8-4-17.1
Macerator/Transfer Timer	8-4-17.3
Machine Gun Tripod Mount	2-2-160
Machine Gun, Ready Service Lockers and Grenade	
Lockers - Exterior Orientation	1-1-14
Machinery Cooling and Keel Coolers	9-4-54
Machinery and Keel Coolers	11-5-159
Magneto Assembly - Fire Pump (P-250)	8-4-7.5
Magazine Sprinkler	2-2-80
Main and Flanking Rudders	11-5-110
Main Mast	
-Lowering	2-2-66
-Raising	2-2-65
Main Switchboard	10-5-29
Maintenance Forms, Records and Reports	1-1-2
Marine Gear	10-5-5
Marine Gear	3-T3-10
Marine Gear	4-3-8
Marine Gear Oil Lines	4-3-8.1
Marine Gear - Come Home	2-2-176
Marine Gear Oil Lines	4-3-8.1
Marine Gear - Principles of Operation	1-1-42
Mast	11-5-84
Mast	7-3-185
Mast Controls - Controls and Indicators	1-Z-14
Mast Hydraulic Directional Control Valve	7-3-198
Mast Hydraulic Hoses, Fittings and Piping	7-3-199
Mast Hydraulic Ram	7-3-197
Mast Hydraulic System	3-T3-82
Mast Hydraulic System	11-5-96
Hose and Fittings	11-5-98
Hydraulic Control	11-5-93
Hydraulic Cylinder	11-5-97
Master Controller Switches - Bow Ramp	6-3-122
Local Controller Switches - Winch Compartment and	
Deck Locker	6-3-122.2
Remote Controller Switch - Pilot House	6-3-122.1
Milk Dispenser	2-2-134
Milk Dispenser	9-4-39
Milk Dispenser	11-5-145

INDEX (Continued)

Volume - Chapter
Paragraph or Table

M (continued)

Mirror Light Fixture	5-3-111.7
Miscellaneous Components on Cargo Deck -	
External Orientation	1-1-21
Miscellaneous Valves and Headers	9-4-35
Controller	9-4-35.8
Heat Interchanger	9-4-35.3
Liquid Solenoid Valve	9-4-35.1
Packless Valve	9-4-35.7
Receiver	9-4-35.2
Refrigerant Tubing	9-4-35.6
Thermometers	9-4-35.5
Water Regulating Valve	9-4-35.4
Mooring, Towing, Causeway Fittings and Lashing	
Gear - Exterior Orientation	1-1-12
Mooring and Towing Fittings.....	9-4-74
Motor Controller - Principles Of Operation	1-1-61
Motor - Hydraulic Cub Pump Unit	11-5-103
M-Type Relay - Fire Pump Controller	11-5-121.3
Muffler	10-5-15
Muffler, Exhaust - Fire Pump (PE-250)	8-4-7.6A
Muffler - Propulsion	4-3-29

N

Navigation Horn	9-4-48.2
Navigation Light - Anchor and Boom	5-3-113.7
Navigation Light - Blinker	5-3-113.9
Navigation Light - Masthead	5-3-113.4
Navigation Light - Port	5-3-113.2
Navigation Light - Starboard	5-3-113.1
Navigation Light - Stern	5-3-113.5
Navigation Light - Towing	5-3-113.3
Navigation Lights	2-2-125
Navigation System - Principles of Operation	1-1-84
Navigational Light Control Panel	5-3-114
Navigational Light Panel - LCU1667 Only	5-3-114.1
Navigational Light Panel - LCU1668 thru 1670	5-3-114.2
Navigational - Searchlight	2-2-145
Night Vision Lights	2-2-151

INDEX (Continued)

Volume - Chapter
Paragraph or Table

N (continued)

No Fuel or Insufficient Fuel - Anchor Winch Engine.....	3-T3-62
No Fuel or Insufficient Fuel - Hydrostarter	3-T3-25
No Fuel or Insufficient Fuel - Propulsion	3-T3-4
Non-follow-up Steering	2-2-59
Nomenclature Cross Reference.....	1-1-5
Normal Operation - Sewage System.....	2-2-102
Normal Steering	2-2-58

O

Oil Breather	4-32.2
Oil By-pass Valve - Anchor Winch	6-3-168.2
Oil By-pass Valve - Generator	5-3-93.2
Oil Cooler and Lines	4-3-17
Oil Filler - Anchor Winch	6-3-163.2
Oil Filler - Generator	5-3-88.2
Oil Filter (By-pass) - Hoses and Housing	6-3-148.2
Oil Filter (Full Flow)	6-3-148.1
Oil Pan and Dipstick - Anchor Winch	6-3-163.1
Oil Pan and Dipstick - Generator	5-3-88.1
Oil Pan and Dipstick - Propulsion.....	4-3-35
Oil Pan, Dipstick and Oil Filler - Anchor Winch	6-3-163
Oil Filler	6-3-163.2
Oil Pan and Dipstick.....	6-3-163.1
Oil Pan, Dipstick and Oil Filler - Generator	5-3-88
Oil Filler	5-3-88.2
Oil Pan and Dipstick.....	5-3-88.1
Oil Water Separation System	11-5-155
Oil/Water Separation System	2-2-96
Bilge Draining.....	2-2-98
Emptying Holding Tank	2-2-100
Pre-start Adjustments.....	2-2-97
Used Engine Oils.....	2-2-99
Oil/Water Separator.....	9-4-50
Oil/Water Separator Piping.....	9-4-61
Oil/Water Separator System Piping - Principles of Operation	1-1-78

INDEX (Continued)

Volume - Chapter
Paragraph or Table

O (continued)

Operator's Controls and Indicators	1-2-1
Aft Engine Room	1-2-11
Air Conditioning Machinery Room	1-2-7
Anchor Winch Controls	1-2-16
Anchor Winch Room	1-2-12
Crew and Transient Berthing	1-2-8
Emergency Shutdown	1-2-15
Engine Room Access	1-2-5
Equipment and Repair Parts Stores	1-2-8
Forward Engine Room	1-2-10
Galley and Mess Room	1-2-3
Mast Controls	1-2-14
Pilot House	1-2-2
Ramp Handling Machinery Compartment and Bow Ramp	1-2-6
Steering Gear Compartment.....	1-2-13
Stern Gate Controls	1-2-17
Tank and Auxiliary Machinery Compartment	1-2-9
Washroom, Water Closet and Shower	1-2-4
Operating Instructions on Decals and Instruction	
Plates	2-2-169
Operation Under Unusual Conditions	2-2-170
Damage Control Procedures	2-2-191
Emergency Procedures	2-2-171
Life Saving Equipment	2-2-197
Operation Under Usual Conditions	2-2-19
Air Conditioning System	2-2-105
Alarm System	2-2-110
Anchor Winch "A" Frame	2-2-46
Bow Ramp Winch	2-2-52
Central Hydraulic System - Including Main Mast	
and Stern Gate	2-2-63
fire, Bilge and Ballast System	2-2-75
Fresh Water Pressure System	2-2-73
Galley and Mess Equipment	2-2-129
Generating System	2-2-34
Halon System	2-2-115
Heaters	2-2-121
Hydraulic Starting System	2-2-20
Interior Communications	2-2-147
Lighting	2-2-122
Lube Oil Transfer System	2-2-62

INDEX (Continued)

Volume - Chapter
Paragraph or Table

O (continued)

Operation Under Usual Conditions (Continued)	
Night Vision Lights	2-2-151
Oil/Water Separator System	2-2-96
Pilot House Equipment	2-2-123
Preparation for Movement	2-2-152
Propulsion System	2-2-28
Sewage System	2-2-101
Signaling Searchlight	2-2-142
Stand-by Lube Oil System	2-2-70
Steering	2-2-57
Tank Level Indicating System	2-2-74
Ventilating Fans	2-2-120
Wash Room , Water Closet, and Shower Equipment	2-2-138
Over-board Discharge - Sewage System	2-2-103
Overspeed Governor - Anchor Winch	6-3-154
Overspeed Governor - Generator	5-3-79
Oxygen Breathing Apparatus	2-2-211

P

Packless Valve	9-4-35.7
Panel Boards - Power Distribution and Shore Power	
Connection Box	5-3-61
Paralleling Generator	2-2-41
Peak Ballast Tank Filling	2-2-81
Pilot House - Controls and Indicators	1-2-2
Pilot House Equipment	2-2-123
Battery Charger/Exhaust	2-2-127
Darken Ship	2-2-126
Electronic Devices	2-2-128
Navigation Lights	2-2-125
Windshield Wiper	2-2-124
Pilot House - Interior Arrangements	1-1-23
Pilot Valve and Manifold - Hydraulic Tank - Anchor	
Winch	6-3-137.3
Pipe Hangers	9-4-52
Piping Systems	9-4-51, 11-5-156
Deck Fittings	9-4-63, 11-5-164
Diesel Oil Cooling Piping	9-4-58
Diesel Oil Piping	9-4-57, 11-5-161
Diesel Oil Stowage Tank	9-4-56

INDEX (Continued)

Volume - Chapter
Paragraph or Table

P (continued)

Piping Systems (Continued)	
Duplex Strainers	9-4-59
Engine Exhaust	9-4-60
Engine Exhaust Piping	11-5-162
Exhaust Pipe Hangers	11-5-157
Fire, Ballast and Bilge Piping	11-5-158
Fire, Bilge and Ballast Piping	9-4-53
Fresh and Flush Water Piping	9-4-62, 11-5-163
Lube Oil Piping	9-4-55, 11-5-160
Machinery and Keel Coolers	11-5-159
Machinery Cooling and Keel Coolers	9-4-54
Oil Water Separator Piping System	9-4-61
Pipe Hangers	9-4-52
Sewage System	9-4-15
Piping Systems - Principles of Operation	1-1-65
Piston - Anchor Winch	7-3-171.1
Piston - Generator	5-6-96.1
Piston - Propulsion	4-3-40.1
Piston, Connecting Rods and Cylinder Liners - Anchor	
Winch	7-3-171
Connecting Rod Bearings	7-3-171.3
Connecting Rods	7-3-171.2
Cylinder Liner	7-3-171.4
Piston	7-3-171.1
Piston, Connecting Rods and Cylinder Liners -	
Generator	5-3-96
Connecting Rod Bearings	5-3-96.3
Connecting Rods	5-3-96.2
Cylinder Liner	5-3-96.4
Piston	5-3-96.1
Pistons, Connecting Rods and Liners.....	
Connecting Rod Bearings	4-3-40
Connecting Rods	4-3-40.3
Cylinder Liner	4-3-40.2
Cylinder Liner	4-3-40.4
Piston	4-3-40.1
Plumbing and Deck Drains	9-4-66
Port Engine - Stand-by Lube Oil System	2-2-72
Port Line Shaft	4-3-54
Portable Air Compressor	9-4-71
Portable Davit	6-3-127, 10-5-56
Portable Extinguishers	2-2-195

INDEX (Continued)

Volume - Chapter
Paragraph or Table

P (continued)

Portable Fire Pump	2-2-196
Applications	2-2-199
Preliminary Adjustments (Fuel and Assembly)	2-2-197
Starting	2-2-198
Stopping and Storage	2-2-200
Portable Fire Pump (P-250)	8-4-7
Carburetor Assembly	8-4-7.2
Carburetor Linkage, Control Panel and Manifold	8-4-7.3
Crankshaft and Piston	8-4-7.7
Foot Valve Assembly	8-4-7.8
Fuel Tank Assembly	8-4-7.4
Magneto Assembly	8-4-7.5
Power Head and Receiver Assembly	8-4-7.6
Pressure Regulating and Operating Cylinder.....	8-4-7.9
Priming Pump and Gear Housing	8-4-7.11
Pump and Water Outlet Valve.....	8-4-7.10
Starter Assembly.....	8-4-7.1
Portable Fire Pump (PE-250).....	8-4-7A
Battery	8-4-7.8A
Carburetor.....	8-4-7.7A
Discharge Valve	8-4-7.3A
Engine.....	8-4-7.10A
Engine Control Panel.....	8-4-7.1A
Gage Panel.....	8-4-7.2A
Muffler, Exhaust	8-4-7.6A
Priming Pump	8-4-7.5A
Pump	8-4-7.4A
Retractable Starter	8-4-7.11A
Solenoid and Electric Starter	8-4-7.9A
Portable Lantern	5-3-112.3
Power Distribution Panel Boards.....	10-5-31
Power Distribution Panel Boards.....	5-3-61
Power Distribution Panel	5-3-61.1
Shore Power Distribution Box.....	5-3-61.2
Power Distribution Panel.....	5-3-61.1
Power Distribution System - Principles of Operation	1-1-49
Power Head and Receiver Assembly - Fire Pump (P-250).....	8-4-7.6
Preliminary Adjustments - Centralized Hydraulic System	2-2-64
Preliminary Adjustments - Generating System	2-2-36
Preliminary Adjustments - Portable Fire Pump	2-2-197

INDEX (Continued)

Volume - Chapter
Paragraph or Table

P (continued)

Preliminary Servicing of Equipment	3-3-2, 8-4-2
Preparation for Movement	2-2-152
Docking	2-2-154
Lifting	2-2-153
Pre-Start Adjustments - Oil/Water Separator System	2-2-97
Pressure Control Valves - Hydraulic Tank - Anchor	
Winch	3-T3-54
Pressure Control Valve - Hydraulic Tank - Anchor	
Winch	6-3-137.4
Pressure Reducing Valves - Hydraulic Tank - Anchor	
Winch	3-T3-55
Pressure Reducing Valve - Hydraulic Tank - Anchor	
Winch	6-3-137.8
Pressure Regulating and Operating Cylinder - Fire	
Pump (P-250).....	8-4-7.9
Preventive Maintenance Checks and Services	1-2-18
Priming Pump - Fire Pump (PE-250)	8-4-7.5A
Priming Pump and Gear Housing - Fire Pump (P-250)	8-4-7.11
Principles of Operation	
"A" Frame	1-1-56
Anchor Winch Engine	1-1-52
Anchor Winch System	1-1-51
"A" Frame	1-1-56
Anchor Winch	1-1-55
Anchor Winch Engine	1-1-52
Hydraulic System	1-1-54
Torque Converter	1-1-53
Ballast System Piping	1-1-76
Bilge System Piping	1-1-75
Bow Ramp Winch Systems	1-1-57
Centralized Hydraulic System	1-1-80
Communication Systems	1-1-85
Cub Hydraulic Pump Unit	1-1-59
Deck and Sanitary Drain Piping System	1-1-72
Diesel Generator and Propulsion Engine -	
Hydraulic Starting System	1-1-88
Engine Cooling Water System	1-1-66
Engine Lube Oil Transfer System	1-1-69
Exhaust Piping System	1-1-67
Fire System Piping	1-1-74
Flanking Rudder Limit Switch Assembly	1-1-62
Flushing System Piping	1-1-77

INDEX (Continued)

Volume - Chapter
Paragraph or Table

P (continued)

Principles of Operation (Continued)	
Fresh Water System Piping	1-1-71
Fuel System	1-1-68
Generator	1-1-47
Generator Engine	1-1-46
Halon Systems	1-1-81
Heading Selector	1-1-60
Heating, Ventilation and Air Conditioning Systems	1-1-79
Hydraulic Starting Systems	1-1-86
Anchor Winch Compartment	1-1-87
Diesel Generator and Propulsion Engines	1-1-88
Hydraulic Systems	1-1-54
Interior Communication Systems	1-1-83
Kort Nozzles, Rudders and Fences	1-1-44
Lighting Distribution Systems	1-1-50
Marine Gear	1-1-42
Motor Controller	1-1-61
Navigation System	1-1-84
Oil/Water Separator System Piping	1-1-78
Piping Systems	1-1-65
Power Distribution System	1-1-49
Propeller Shafts and Miscellaneous Components	1-1-43
Propulsion Engine	1-1-41
Propulsion Systems	1-1-40
Kort Nozzles, Rudders and Fences	1-1-44
Marine Gear	1-1-42
Propeller Shaft and Miscellaneous Components	1-1-43
Propulsion Engine	1-1-41
Rudder Angle Indicator and Transmitter	1-1-64
Sewage System Piping	1-1-73
Ship's Piping System	1-1-65
Ballast System	1-1-76
Bilge System	1-1-75
Centralized Hydraulic System	1-1-80
Deck and Sanitary Drain Piping System	1-1-72
Engine Cooling Water System	1-1-66
Engine Lube Oil Transfer System	1-1-69
Exhaust Piping System	1-1-67
Fire System	1-1-74
Flushing System	1-1-77
Fresh Water System	1-1-71
Fuel System	1-1-68

INDEX (Continued)

Volume - Chapter
Paragraph or Table

P (continued)

Principles of Operation (Continued)	
Ship's Piping System (Continued)	
Halon System	1-1-81
Heating, Ventilation and Air Conditioning Systems	1-1-79
Oil/Water Separator System	1-1-78
Sewage System	1-1-73
Standby Lube Oil Pump	1-1-70
Tank Level Indicating System	1-1-82
Ship's Service Generating Systems	1-1-45
Generator	1-1-47
Generator Engine	1-1-46
Lighting Distribution	1-1-50
Power Distribution	1-1-49
Switchboard	1-1-48
Ship's Steering Systems	1-1-58
Cub Hydraulic Pump Unit	1-1-59
Flanking Rudder Limit Switch Assembly	1-1-62
Heading Selector	1-1-60
Motor Controller	1-1-61
Rudder Angle Indicator and Transmitter	1-1-64
Steering Rudder Repeatback Unit	1-1-63
Standby Lube Oil Pump	1-1-70
Steering Rudder Repeatback Unit	1-1-63
Switchboard	1-1-48
Tank Level Indicating System	1-1-82
Technical Principles of Operation - General	1-1-39
Anchor Winch Systems	1-1-51
Bow Ramp Systems	1-1-57
Communication Systems	1-1-85
Hydraulic Starting Systems	1-1-86
Interior Communication Systems	1-1-83
Navigation Systems	1-1-84
Piping Systems	1-1-65
Propulsion Systems	1-1-40
Kort Nozzles, Rudders and Fences	1-1-44
Marine Gear	1-1-42
Propeller Shafts and Miscellaneous Components.....	1-1-43
Propulsion Engine	1-1-41
Ship's Service Generating System	1-1-45
Generator	1-1-47
Generator Engine	1-1-46

INDEX (Continued)

Volume - Chapter
Paragraph or Table

P (continued)

Principles of Operation (Continued)	
Technical Principles of Operation - General (Continued)	
Ship's Service Generating System (Continued)	
Lighting Distribution	1-1-50
Power Distribution	1-1-49
Switchboard	1-1-48
Steering Systems	1-1-58
Torque Converter	1-1-53
Propellers, Rudders and Keel Coolers - Interior	
Arrangement	1-1-35
Propeller Shaft	4-3-53
Propeller Shaft and Bearings	11-6-1
Propeller Shafts and Miscellaneous Components - Principles of Operation	1-1-43
Propulsion Engine	
Abnormal Engine Coolant Operating Temperature	3-T3-8
Abnormal Engine Operation	3-T3-3
Cold Weather - Local Starting	2-2-30
Emergency Start	2-2-175
Emergency Stop	2-2-173
Excessive Crankcase Pressure	3-T3-6
Exhaust Smoke Analysis	3-T3-1
Hard Starting	3-T3-2
High Lubricating Oil Consumption	3-T3-5
Cranking Speed Too Low	3-T3-12
Fluid Emerges Around Rubber Boot of Hand Pump	3-T3-20
Fluid Emerges from Ends of Starter Control Valve When Starter is Operated	3-T3-21
Fluid Emerges from the Reservoir Filler Cap When Starter Is Used	3-T3-19
Hand Pump Fails to Discharge Fluid	3-T3-15
High Pressure in System (3500 psi (24,133 kPa) or above)	3-T3-18
Loss of Accumulator Precharge (Nitrogen)	3-T3-17
Loss of Fluid Pressure - Engine Not Running	3-T3-14
Loss of Fluid from Reservoir	3-T3-13
Loss or No Accumulator Pressure	3-T3-11
Starter Turns but Engine Does Not	3-T3-16
Low or High Exhaust Valve Opening Pressure	3-T3-9
Low Oil Pressure	3-T3-7
No Fuel or Insufficient Fuel	3-T3-4

INDEX (Continued)

Volume - Chapter
Paragraph or Table

P (continued)

Propulsion Engine (Continued)	
Local Stop	2-2-31
Principles of Operation	1-1-41
Remote Starting	2-2-32
Remote Stop	2-2-33
Reset After Emergency Stop	2-2-174
Warm Weather - Local Starting	2-2-29
Propulsion Engine Maintenance Instructions	4-3-6
Accumulator	4-3-47
Air Intake	4-3-11
Balance Weight Cover and Accessory Drive	4-3-26
Blower	4-3-12
Crankshaft	4-3-42
Crankshaft Bearings	4-3-41
Crankshaft Pulley and Vibration Damper	4-3-25
Crankshaft Seals	4-3-43
Cylinder Block	4-3-44
Cylinder Head	4-3-34
Engine Supports Lifter Brackets/Crankshaft Front Cover	4-3-27
Engine/Transmission Controls	4-3-9
Exhaust Manifold and Fittings	4-3-28
Flywheel and Housing Oil Breather	4-3-32
Fresh Water Pump	4-3-18
Fuel Filter, Strainer and Fuel Lines	4-3-14
Fuel Injector	4-3-15
Fuel Pump	4-3-13
Governor	4-3-10
Heat Exchanger Tank	4-3-19
Hydrostarter	4-3-46
Hydrostarter Piping (Aft Engine Room).....	4-3-51
Hydrostarter Piping (Forward Engine Room)	4-3-50
Hydrostarter Pump (Engine-Driven)	4-3-48
Hydrostarter Pump (Hand)	4-3-49
Hydrostarter Reservoir, Filter, Solenoids	4-3-52
Injector Controls	4-3-31
Instrument Panel	4-3-24
Lube Oil Distribution System	4-3-39
Lube Oil Filters and Housing	4-3-16
Lube Oil Pump	4-3-38
Lube Oil Regulator	4-3-37
Lube Oil Relief Valve	4-3-36

INDEX (Continued)

Volume - Chapter
Paragraph or Table

P (continued)

Propulsion Engine Maintenance Instructions (Continued)	
Marine Gear	4-3-8
Muffler	4-3-29
Oil Cooler and Liners	4-3-17
Oil Pan & Dipstick	4-3-35
Pistons, Connecting Rods and Liners	4-3-40
Port Line Shaft	4-3-54
Propeller Shaft	4-3-53
Rocker Arm Cover	4-3-30
Shaft Inflatable Seal	4-3-55
Shaft Lock	4-3-57
Shaft Seals - Preformed	4-3-56
Starting Aid	4-3-45
Tachometer Drive	4-3-23
Thermostat and Housing	4-3-22
Valve Operating Mechanism	4-3-33
Water Connections	4-3-20
Water Manifold	4-3-21
Propulsion Engine and Marine Gear	10-5-3
Accumulator	10-5-22
Balance Weight Cover and Accessory Drive	10-5-13
Blower	10-5-8
Camshaft and Gear Train	10-5-19
Cylinder Block	10-5-20
Engine Supports, Lifter Brackets and Crankshaft	
Front Cover	10-5-14
Engine and Transmission Controls	10-5-6
Expansion Tank	10-5-10
Flywheel and Housing	10-5-18
Fuel Injector	10-5-9
Hydrostarter	10-5-21
Hydrostarter Piping (Aft Engine Room)	10-5-27
Hydrostarter Piping (Forward Engine Room)	10-5-26
Hydrostarter Pump (Engine Driven)	10-5-23
Hydrostarter Solenoid	10-5-24
Lube Oil Pressure Regulator and Relief Valve	10-5-17
Lube Oil Pump	10-5-16
Marine Gear	10-5-5
Muffler	10-5-15
Propulsion/Marine Gear - Removal and Run -In	
Instructions	10-5-4

INDEX (Continued)

Volume - Chapter
Paragraph or Table

P (continued)

Propulsion Engine and Marine Gear (Continued)	
Reservoirs and Filters	10-5-25
Thermostat and Housing	10-5-12
Variable Speed Mechanical Governor	10-5-7
Water Manifold	10-5-11
Propulsion Engine/Marine Gear - Removal and Run-In	
Instructions	10-5-4
Propulsion System	2-2-28
Propulsion Engine - Cold Weather - Local Starting.....	2-2-30
-Local Stop.....	2-2-31
-Remote Starting	2-2-32
-Remote Stop	2-2-33
-Warm Weather - Local Starting.....	2-2-29
Propulsion System - Emergency Procedures	2-2-172
Marine Gear - Come Home	2-2-176
Propulsion Engine -Emergency Start	2-2-175
-Emergency Stop	2-2-173
-Reset After Emergency Stop	2-2-174
Propulsion Systems - Principles of Operation	1-1-40
Kort Nozzles, Rudders and Fences	1-1-44
Marine Gear	1-1-42
Propeller Shaft and Miscellaneous Components	1-1-43
Propulsion Engine	1-1-41
Pump - Fire Pump (PE-250)	8-4-7.4A
Pump - Hydraulic Cub Pump Unit	11-5-105
Pump Sets	8-4-6, 11-5-118
Air Conditioning Water Circulation Pump Controller	11-5-128
Air Conditioning Water Circulation Pump Motor	11-5-127
Air Conditioner Water Circulation Pump Set	8-4-12
Bilge Pump	8-4-9
Bilge Pumps	11-5-122
Diesel Oil Cooling Pump Motor	11-5-129
Diesel Oil Cooling Pump Set	8-4-13
Fresh Water Pump	8-4-11
Fire Pump	8-4-8, 11-5-119
Fire Pump Controller	11-5-121
Fire Pump Motor	11-5-120
Fresh Water Pump Controller	11-5-126
Fresh Water Pump Motor	11-5-125
Lube Oil Pump Controller	11-5-124
Lube Oil Pump Motor	11-5-123
Lube Oil Pump Set (Stand-by)	8-4-10
Lube Oil Transfer Pump	8-4-14

INDEX (Continued)

Volume - Chapter
Paragraph or Table

P (continued)

Pump Sets (Continued)	
Portable Fire Pump Set (P-250)	8-4-7
Portable Fire Pump Set (PE-250)	8-4-7A
Pump and Water Outlet Valve - Fire Pump (P-250)	8-4-7.10
Pushbutton Switch	7-3-193, 11-5-91
Pyrotechnic	2-2-211

R

Radar Mast	2-2-155
Radio and Radar Communication Systems	11-5-153
Raising Bow Ramp -Emergency Procedures	2-2-189
-Local	2-2-56
-Remote	2-2-54
Ramp Handling Machinery Compartment and Bow Ramp - Controls and Indicators	1-2-6
Reactivation from Storage	7-3-223
Reactivation - Halon System	2-2-118
Ready Service Locker	2-2-161
Receiver	9-4-35.2
Recalculating Fan Controller	11-5-135
Recalculating Fan Motor	11-5-136
Rectifier 24 VDC	5-3-108
Rectifier - 24 VDC	3-T3-44
Refrigerator/Freezer	2-2-135, 9-4-37
Refrigerator/Freezer	11-5-144
Refrigerant Tubing	9-4-35.6
Relay Operated Lantern	5-3-112.2
Relief Valve - Hydraulic Tank - Anchor Winch	6-3-137.7
Remote Controller Switch - Pilothouse - Bow Ramp	6-3-122.1
Remote Magnetic Heading Compass (RHMS)	7-3-217
Remote Magnetic Heading Compass	11-5-116, 11-6-4
Remote Magnetic Heading System	3-T3-91
Remote Operation -Generator #1	2-2-39
-Generator #2	2-2-41
Remote Operation and Payout - Anchor Winch	2-2-49
Reporting Equipment Improvement Recommendations (EIR)	1-1-4
Reservoir, Tank and Strainer - Hydraulic Cub Pump Unit	11-5-107

INDEX (Continued)

Volume - Chapter
Paragraph or Table

R (continued)

Reset After Emergency Stop	-Anchor Winch Engine	2-2-183
	-Generator Engine	2-2-179
	-Propulsion Engine	2-2-174
Retractable Starter- Fire Pump (PE-250)		8-4-7.11A
Rocker Arm Cover - Anchor Winch		6-3-161
Rocker Arm Cover - Generator		5-3-86
Rudder Angle Indicator		7-3-212, 11-5-111
Rudder Angle Indicator and Repeatback Transmitter.....		3-T3-88
Rudder Angle Indicator and Transmitter - Principles of Operation		1-1-64
Rudder Angle Transmitter		7-3-213, 11-5-112
Rudders - Main and Flanking		11-5-110
Running Light Control Panel		10-5-46
Running Lights, Peloris, Masts, Flags and Services - Exterior Orientation		1-1-15
Running, Signal and Anchor Lights		5-3-113
Navigation Light - Anchor and Boom		5-3-113.7
Navigation Light - Blinker		5-3-113.9
Navigation Light - Masthead		5-3-113.4
Navigation Light - Port		5-3-113.2
Navigation Light - Starboard		5-3-113.1
Navigation Light - Stern		5-3-113.5
Navigation Light - Towing		5-3-113.3
Signal Light - Manoverboard.....		5-3-113.8
Signal Light - Task		5-3-113.6
Wake Light		5-3-113.10

S

Salvage Pump		2-2-204
Sanitizing Sink Heater		9-4-42
Sanitizing Sink Heater		2-2-137
Scope - General Information.....		1-1-1
Searchlight		2-2-163
Searchlight		9-4-77
Drum Assembly		9-4-77.4
Hood Assembly		9-4-77.2
Mounting and Yoke Assembly		9-4-77.1
Shutter Assembly		9-4-77.3

INDEX (Continued)

Volume - Chapter
Paragraph or Table

S (continued)

Searchlight	-Navigational	2-2-145
	-Turn ON/OFF	2-2-143
Sea Water Cooling Pump		2-2-106
Secretary Light Fixture		5-3-111.8
Sewage Air Pump		8-4-18
Sewage Air Pump Motor		8-4-18.2
Sewage Air Pump		8-4-18.1
Sewage Pump		8-4-16
Sewage Sanitary Drain Piping		11-5-132
Sewage System		11-5-130
Sewage Sanitary Drain Piping		11-5-132
Sewage System Discharge Piping		11-5-131
Sewage Tank		11-5-133
Sewage System	2-2-101, 8-4-15	
Flush Water Pump		8-4-21
Macerator/Transfer Pump		8-4-17
Normal Operation		2-2-102
Over-board Discharge Holding Tank		2-2-103
Over-board Discharge - Macerator Pump(s)		2-2-104
Sewage Air Pump		8-4-18
Sewage Pump		8-4-16
Toilet		8-4-19
Urinal		8-4-20
Sewage System Discharge Piping		11-5-131
Sewage System Piping - Principles Of Operation		1-1-73
Sewage Tank		11-5-133
Shaft Inflatable Seal		4-3-55
Shaft Lock		4-3-57
Shaft Seals		11-6-2
Shaft Seals		4-3-56
Ship's Course Indicator		3-T3-92
Ship's Course Indicator		7-3-219
Ship's Course Indicator		11-5-117
Ships Course Indicator and Peloris		2-2-164
Ship's Hydraulic System		11-5-85
Controller		11-5-89
Electric Motor		11-5-86
Gages		11-5-90
Hydraulic Pump		11-5-87
Hydraulic Reservoir		11-5-88
Push Button Switch		11-5-91

INDEX (Continued)

Volume - Chapter
Paragraph or Table

S (continued)

Ship's Piping System - Principles of Operation	1-1-65
Ballast System	1-1-76
Bilge System	1-1-75
Centralized Hydraulic System	1-1-80
Deck and Sanitary Drain Piping System	1-1-72
Engine Cooling Water System	1-1-66
Engine Lube Oil Transfer System	1-1-69
Exhaust Piping System	1-1-67
Fire System	1-1-74
Flushing System	1-1-77
Fresh Water System	1-1-71
Fuel System	1-1-68
Halon System	1-1-81
Heating, Ventilation and Air Conditioning Systems	1-1-79
Oil/Water Separator System	1-1-78
Sewage System	1-1-73
Standby Lube Oil Pump	1-1-70
Tank Level Indicating System	1-1-82
Ship's Service Generating Systems - Principles of Operation	1-1-45
Generator	1-1-47
Generator Engine	1-1-46
Lighting Distribution	1-1-50
Power Distribution	1-1-49
Switchboard	1-1-48
Ship's Steering Systems - Principles of Operation	1-1-58
Cub Hydraulic Pump Unit	1-1-59
Flanking Rudder Limit Switch Assembly	1-1-62
Heading Selector	1-1-60
Motor Controller	1-1-61
Rudder Angle Indicator And Transmitter	1-1-64
Steering Rudder Repeatback Unit	1-1-63
Shore Power	2-2-35
Shore Power Distribution Box	5-3-61.2
Shut-down Solenoid	5-3-65.2
Signal Light - Manoverboard	5-3-113.8
Signal Light - Task	5-3-113.6
Signaling Searchlight	2-2-142
Hood Assembly	2-2-146
Searchlight - Navigational	2-2-145
Searchlight Turn ON/OFF	2-2-143
Signaling	2-2-144

INDEX (Continued)

Volume - Chapter
Paragraph or Table

S (continued)

Simplex Strainer	9-4-53.3
Simplex Strainer	8-4-8.5
Slack Cable Interlock Limit Switch	6-3-123.1
Slack Puller - Anchor Winch	3-T3-49
Slack Puller	6-3-134
Slack Puller and Motor	10-5-64
Smoke Detector	9-4-45.3
Solenoid and Electric Starter - Fire Pump (PE-250)	8-4-7.9A
Sound Powered Phones.....	9-4-46.2
Speed Reducer - Bow Ramp	6-3-119
Speed Reducer	10-5-50
Spot Light	2-2-146.1
Spot Light Turn ON/OFF	2-2-146.2
Spot Light Operation	2-2-146.3
Stanchions and Railings	9-4-69
Stand-by Lube Oil Pump	8-4-10
Lube Oil Pump Controller	8-4-10.4
Lube Oil Pump Motor	8-4-10.3
Lube Oil Pump	8-4-10.2
Lube Oil Pump Set	8-4-10.1
Stand-by Lube Oil Pump - Principles of Operation	1-1-70
Stand-by Lube Oil System	2-2-70
Stand-by Lube Oil System -Port Engine	2-2-72
Stand-by Lube Oil System -Starboard Engine	2-2-71
Starboard Engine - Stand-by Lube Oil System	2-2-71
Starter Assembly Fire Pump (P-250)	8-4-7.11
Starter (NEMA, SIZE D, 3 POLE) - Ships Hydraulic System Controller	11-5-89.1
Starter (NEMA, Size 3, 3 Pole Reversing) - Fire Pump Controller	11-5-121.2
Starter Turns but Engine Does Not - Hydrostarter - Anchor Winch	3-T3-73
Starter Turns but Engine Does Not - Hydrostarter	3-T3-36
Starter Turns but Engine Does Not - Propulsion	3-T3-16
Starting Aid - Anchor Winch	7-3-175
Starting Aid - Generator	5-3-100
Starting Aid - Main Propulsion	4-3-45
Starting - Portable Fire Pump	2-2-198
Steering 2-2-57	
Automatic Steering	2-2-60
Non-follow-up Steering	2-2-59
Normal Steering	2-2-58
Steering Shutdown	2-2-61
Steering Controller	3-T3-84

INDEX (Continued)

Volume - Chapter
Paragraph or Table

S (continued)

Steering Control Panel	3-T3-90
Steering Control Panel	7-3-215
Steering Control Panel and Gyro Computer	11-5-114, 11-6-3
Steering Cub Hydraulic Pump	3-T3-85
Steering Gear Compartment - Controls and Indicators.....	1-2-13
- Interior Arrangement	1-1-34
Steering Rudder Repeatback Unit - Principles of	
Operation	1-1-63
Steering Shutdown	2-2-61
Steering System	7-3-203
Hydraulic Cylinder and Linkage	7-3-210
Hydraulic Hoses, Piping and Valves	7-3-211
Steering Systems	11-5-102
Flanking Rudder Limit Switch	11-5-113
Heading Selector	11-5-115
Hydraulic Cub Pump Unit - Brake Valve	11-5-106
Hydraulic Cub Pump Unit - Controller	11-5-104
Hydraulic Cub Pump Unit - Cylinder and Linkage	11-5-108
Hydraulic Cub Pump Unit - Hoses, Piping and Valves	11-5-109
Hydraulic Cub Pump Unit - Motor	11-5-103
Hydraulic Cub Pump Unit - Pump	11-5-105
Hydraulic Cub Pump Unit - Reservoir, Tank and	
Strainer	11-5-107
Main and Flanking Rudders	11-5-110
Remote Magnetic Heading Compass	11-5-116
Rudder Angle Indicator	11-5-111
Rudder Angle Transmitter	11-5-112
Ship's Course Indicator	11-5-117
Steering Control Panel and Gyro Computer	11-5-114
Steering System - Hydraulic Directional Control	
Valve	3-T3-86
Stern Anchor Hydraulic System	11-5-99
Hose and Fittings	11-5-101
Hydraulic Control	11-5-93
Hydraulic Winch	11-5-100
Stern Gate	10-5-54
Stern Gate Controls - Controls and Indicators	1-2-17
Stern Gate	
-Davits	2-2-165
-Emergency Procedures	2-2-190
-External Orientation	1-1-20
-Lowering	2-2-68
-Raising	2-2-69

INDEX (Continued)

Volume - Chapter
Paragraph or Table

S (continued)

Stern Gate Hydraulic Directional Control Valve	7-3-194
Stern Gate Hydraulic Hoses, Fittings and Piping	7-3-195
Stern Gate Hydraulic Ram	7-3-196
Stern Gate Hydraulic System	3-T3-81
Stern Gate Hydraulic System	11-5-92
Hose, Fittings, and Piping	11-5-94
Hydraulic Control	11-5-93
Hydraulic Cylinder	11-5-95
Stern Gate - Overall	10-5-53
Gate Hinges and Springs	10-5-55
Portable Davit	10-5-56
Stern Gate	10-5-54
Stern Gate Overall	6-3-124
Gate, Hinge, Springs	6-3-126
Portable Davit	6-3-127
Stern Gate	6-3-125
Stop Cable and Linkage	6-3-141.3
Stopping Generator -Operating Non-Parallel	2-2-42
-Operating Parallel	2-2-43
Stopping and Storage - Portable Fire Pump	2-2-200
Strainer - Air Conditioner System	8-4-31
Switch	5-3-110
Break Glass Station	5-3-110.2
Disconnect Switch	5-3-110.6
Duplex Receptacles	5-3-110.4
Interlock Door Operated Switch	5-3-110.5
Toggle Switch	5-3-110.1
Water Tight Receptacles	5-3-110.3
Switchboard	3-T3-43
Switchboard (Main)	5-3-59
Switchboard - Principles of Operation	1-1-48
Symptom Index - Troubleshooting	3-3-5
Synchronizing Motor	5-3-66.3
System Alarms	2-2-112
System Shutdown - Air Conditioning	2-2-109
System Startup - Air Conditioning	2-2-108

INDEX (Continued)

Volume - Chapter
Paragraph or Table

T

Tachometer Drive - Anchor Winch	6-3-155
Tachometer Drive - Generator	5-3-80
Tachometer Drive - Main Propulsion	4-3-23
Tank Assembly - Hydraulic Tank - Anchor Winch	6-3-137.1
Tank and Auxiliary Machinery Compartment - Interior Arrangement	1-1-30
Tank and Auxiliary Machinery Compartment - Controls and Indicators	1-2-9
Tank Level Indicators	11-5-165
Tank Level Indicating System	2-2-74
Tank Level Indicating System - Principles of Operation	1-1-82
Tanks and Voids	9-4-64
Tank Level Indication - Cable Assembly	9-4-64.3
Tank Level Indication - Penetration Assembly	9-4-64.4
Tank Level Indication - Receiver	9-4-64.1
Tank Level Indication - Transmitter	9-4-64.2
Technical Principles of Operation - General	1-1-39
Anchor Winch Systems	1-1-51
Bow Ramp Systems	1-1-57
Communication Systems	1-1-85
Hydraulic Starting Systems	1-1-86
Interior Communication Systems	1-1-83
Navigation Systems	1-1-84
Piping Systems	1-1-65
Propulsion Systems	1-1-40
Kort Nozzles, Rudders and Fences	1-1-44
Marine Gear	1-1-42
Propeller Shafts And Miscellaneous Components	1-1-43
Propulsion Engine	1-1-41
Ship's Service Generating System	1-1-45
Generator	1-1-47
Generator Engine	1-1-46
Lighting Distribution	1-1-50
Power Distribution	1-1-49
Switchboard	1-1-48
Steering Systems	1-1-58
Terminal Boxes	5-3-109.3
Thermal Expansion Valve - Air Conditioning	9-4-34
Thermometers	9-4-35.5
Thermostats	8-4-26.3

INDEX (Continued)

Volume - Chapter
Paragraph or Table

T (continued)

Thermostat and Housing - Anchor Winch	11-5-75
Thermostat and Housing - Generator	10-5-39
Thermostat and Housing - Propulsion	10-5-12
Thermostat and Housing - Anchor Winch	6-3-153
Thermostat and Housing - Generator	5-3-78
Thermostat and Housing - Propulsion	4-3-22
Thermostat Switch and Magazine Alarm	11-5-150
Time Delay Relay	5-3-65.3.1
Toaster	2-2-131, 9-4-44
Toggle Switch	5-3-110.1
Toilet	8-4-19
Torque Converter - Anchor Winch	3-T3-51
Torque Converter	10-5-66
Torque Converter	6-3-136
Torque Converter - Principles of Operation	1-1-53
Torque Coupling - Bow Ramp	6-3-118
Transformer	5-3-60
Transformers	10-5-30
24-Volt Rectifier	10-5-44

U

Universal Joint Assembly	10-5-59
Urinal	8-4-20
Used Engine Oils	2-2-99

V

Valve Operating Mechanism - Exhaust Valves -	
Anchor Winch	6-3-165
Exhaust Valve	6-3-165.2
Valve and Injector Operating Mechanism	6-3-165.1
Valve Operating Mechanism - Exhaust Valves -	
Generator	5-3-90
Exhaust Valve	5-3-90.2
Valve and Injector Operating Mechanism	5-3-90.1
Valve and Injector Operating Mechanism	4-3-33
Exhaust Valve	4-3-33.2
Valve and Injector Operating Mechanism	4-3-33.1

INDEX (Continued)

Volume - Chapter
Paragraph or Table

V (continued)

Valve Rocker Arm Cover - Generator	5-3-86
Valve Rocker Arm Cover - Propulsion	4-3-30
Variable Speed Mechanical Governor	10-5-7
Ventilating Fans	2-2-120
Vents and Soundings	9-4-67
Vents and Sounding Tubes	11-5-168
VHF Antenna	9-4-49, 11-5-154
Voice Tube	2-2-157
Voice Tube	9-4-46.4
24 Volt Distribution Panel	9-4-48.3
Voltage Regulator	10-5-29.1
Voltage Regulator	5-3-62.2

W

Wake Light	5-3-113.10
Washdown Countermeasure Sprinkling System	2-2-80.1
Washer/Dryer	9-4-41
Dryer Mechanism	9-4-41.3
Exterior Cabinet Removal	9-4-41.1
Washer/Dryer Controls	9-4-41.4
Washer Mechanism	9-4-41.2
Washer/Dryer Controls	9-4-41.4
Washer/Dryer Turn ON/OFF	2-2-139
Washer Operation	2-2-140
Washer Mechanism	9-4-41.2
Wash Room, Water Closet and Shower - Controls and Indicators	1-2-4
Wash Room, Water Closet and Shower - Interior Arrangement	1-1-25
Wash Room, Water Closet and Shower	2-2-138
Dryer Operation	2-2-141
Washer/Dryer Turn ON/OFF	2-2-139
Washer Operation	2-2-140
Water Connections - Anchor Winch	6-3-151
Water Connections - Main Propulsion	4-3-20
Water Temperature Alarm Switch	5-3-65.3.2
Water Temperature Switch	4-3-9.4
Water Manifold - Anchor Winch	11-5-74
Water Manifold - Generator	10-5-38
Water Manifold - Main Propulsion	10-5-11

INDEX (Continued)

Volume - Chapter
Paragraph or Table

W (continued)

Water Manifold - Anchor Winch	6-3-152
Water Manifold - Generator	5-3-77
Water Manifold - Main Propulsion	4-3-21
Water Regulating Valve	9-4-35.4
Watertight Integrity	2-2-205
Water Tight Receptacles	5-3-110.3
Whip Antennas	2-2-156
Winch - Anchor Winch	3-T3-48
Winch Assembly	10-5-49
Winch Assembly - Bow Ramp	6-3-117
Winch Brake and Motor - Bow Ramp	6-3-120
Winch Motor	10-5-51
Windscreen and Railings	2-2-159
Windscreen and Airports	9-4-73
Windshield Wiper	2-2-124
Windshield Wiper	9-4-76
Windshield Wiper Assembly (Pilothouse)	9-4-76.2
Windshield Wiper Control (Pilothouse)	9-4-76.1
Windshield Wiper Motor (Pilothouse)	9 4-76.3
Windshield Wiper Assembly (Conning Tower)	9-4-76.4
Windshield Wiper Control (Conning Tower)	9 4-76.5
Wire Rope Cutter	7-3-184
Wire Rope Guard and Slack Cable Interlock Limit Switch Bracket	6-3-123.3
Wye Strainer	9-4-53.4

By Order of the Secretary of the Army:

JOHN A. WICKHAM, JR.
General, United States Army
Chief of Staff

Official:

DONALD J. DELANDRO
Brigadier General, United States Army
The Adjutant General

DISTRIBUTION:

To be distributed in accordance with DA Form 12-25D, Operator, Organizational' Direct and General Support Maintenance Requirements for Marine Equipment All.

These are the instructions for sending an electronic 2028

The following format must be used if submitting an electronic 2028. The subject line must be exactly the same and all fields must be included; however only the following fields are mandatory: 1, 3, 4, 5, 6, 7, 8, 9, 10, 13, 15, 16, 17, and 27.

From: "Whomever" <whomever@avma27.army.mil>
To: mpmt%avma28@st-louis-emh7.army.mil

Subject: DA Form 2028

1. **From:** Joe Smith
2. **Unit:** home
3. **Address:** 4300 Park
4. **City:** Hometown
5. **St:** MO
6. **Zip:** 77777
7. **Date Sent:** 19-OCT-93
8. **Pub no:** 55-2840-229-23
9. **Pub Title:** TM
10. **Publication Date:** 04-JUL-85
11. **Change Number:** 7
12. **Submitter Rank:** MSG
13. **Submitter FName:** Joe
14. **Submitter MName:** T
15. **Submitter LName:** Smith
16. **Submitter Phone:** 123-123-1234
17. **Problem:** 1
18. **Page:** 2
19. **Paragraph:** 3
20. **Line:** 4
21. **NSN:** 5
22. **Reference:** 6
23. **Figure:** 7
24. **Table:** 8
25. **Item:** 9
26. **Total:** 123
27. **Text:**

This is the text for the problem below line 27.

The Metric System and Equivalents

Linear Measure

1 centimeter = 10 millimeters = .39 inch
 1 decimeter = 10 centimeters = 3.94 inches
 1 meter = 10 decimeters = 39.37 inches
 1 dekameter = 10 meters = 32.8 feet
 1 hectometer = 10 dekameters = 328.08 feet
 1 kilometer = 10 hectometers = 3,280.8 feet

Weights

1 centigram = 10 milligrams = .15 grain
 1 decigram = 10 centigrams = 1.54 grains
 1 gram = 10 decigrams = .035 ounce
 1 decagram = 10 grams = .35 ounce
 1 hectogram = 10 decagrams = 3.52 ounces
 1 kilogram = 10 hectograms = 2.2 pounds
 1 quintal = 100 kilograms = 220.46 pounds
 1 metric ton = 10 quintals = 1.1 short tons

Liquid Measure

1 centiliter = 10 milliliters = .34 fl. ounce
 1 deciliter = 10 centiliters = 3.38 fl. ounces
 1 liter = 10 deciliters = 33.81 fl. ounces
 1 dekaliter = 10 liters = 2.64 gallons
 1 hectoliter = 10 dekaliters = 26.42 gallons
 1 kiloliter = 10 hectoliters = 264.18 gallons

Square Measure

1 sq. centimeter = 100 sq. millimeters = .155 sq. inch
 1 sq. decimeter = 100 sq. centimeters = 15.5 sq. inches
 1 sq. meter (centare) = 100 sq. decimeters = 10.76 sq. feet
 1 sq. dekameter (are) = 100 sq. meters = 1,076.4 sq. feet
 1 sq. hectometer (hectare) = 100 sq. dekameters = 2.47 acres
 1 sq. kilometer = 100 sq. hectometers = .386 sq. mile

Cubic Measure

1 cu. centimeter = 1000 cu. millimeters = .06 cu. inch
 1 cu. decimeter = 1000 cu. centimeters = 61.02 cu. inches
 1 cu. meter = 1000 cu. decimeters = 35.31 cu. feet

Approximate Conversion Factors

<i>To change</i>	<i>To</i>	<i>Multiply by</i>	<i>To change</i>	<i>To</i>	<i>Multiply by</i>
inches	centimeters	2.540	ounce-inches	Newton-meters	.007062
feet	meters	.305	centimeters	inches	.394
yards	meters	.914	meters	feet	3.280
miles	kilometers	1.609	meters	yards	1.094
square inches	square centimeters	6.451	kilometers	miles	.621
square feet	square meters	.093	square centimeters	square inches	.155
square yards	square meters	.836	square meters	square feet	10.764
square miles	square kilometers	2.590	square meters	square yards	1.196
acres	square hectometers	.405	square kilometers	square miles	.386
cubic feet	cubic meters	.028	square hectometers	acres	2.471
cubic yards	cubic meters	.765	square meters	cubic feet	35.315
fluid ounces	milliliters	29.573	cubic meters	cubic yards	1.308
pints	liters	.473	milliliters	fluid ounces	.034
quarts	liters	.946	liters	pints	2.113
gallons	liters	3.785	liters	quarts	1.057
ounces	grams	28.349	liters	gallons	.264
pounds	kilograms	.454	grams	ounces	.035
short tons	metric tons	.907	kilograms	pounds	2.205
pound-feet	Newton-meters	1.356	metric tons	short tons	1.102
pound-inches	Newton-meters	.11296			

Temperature (Exact)

°F	Fahrenheit temperature	5/9 (after subtracting 32)	Celsius temperature	°C
----	------------------------	----------------------------	---------------------	----

PIN: 057586-003

This fine document...

Was brought to you by me:



[Liberated Manuals -- free army and government manuals](#)

Why do I do it? I am tired of sleazy CD-ROM sellers, who take publicly available information, slap “watermarks” and other junk on it, and sell it. Those masters of search engine manipulation make sure that their sites that sell free information, come up first in search engines. They did not create it... They did not even scan it... Why should they get your money? Why are not letting you give those free manuals to your friends?

I am setting this document FREE. This document was made by the US Government and is NOT protected by Copyright. Feel free to share, republish, sell and so on.

I am not asking you for donations, fees or handouts. If you can, please provide a link to liberatedmanuals.com, so that free manuals come up first in search engines:

<A HREF=<http://www.liberatedmanuals.com/>>Free Military and Government Manuals

– Sincerely
Igor Chudov
<http://igor.chudov.com/>