



HEARTSTART XL

INSTRUCTIONS FOR USE

AED Superstore[®]
an **ALLIED 100**[™] company

**M4735A HeartStart XL
Defibrillator/Monitor**

AED Superstore®
an **ALLIED 100™** company

PHILIPS

Notice

About This Edition

Edition 7

Printed in the USA

Publication number M4735-91900

The information in this guide applies to the M4735A HeartStart XL, release Main 20 and earlier. This information is subject to change without notice.

Philips shall not be liable for errors contained herein or for incidental or consequential damages in connection with the furnishing, performance, or use of this material.

Edition History

Edition 1, September, 2000

Edition 2, May, 2001

Edition 3, June, 2002

Edition 4, September, 2002

Edition 4.1, February, 2003

Edition 5, August, 2004

Edition 6, May, 2005

Edition 7, April, 2006

Copyright

Copyright © 2006

Koninklijke Philips Electronics N.V.

All rights are reserved. Reproduction in whole or in part is prohibited without the prior written consent of the copyright holder.

SMART Biphasic is a registered trademark of Philips.

Use of supplies or accessories other than those recommended by Philips may compromise product performance.

THIS PRODUCT IS NOT INTENDED FOR HOME USE.

IN THE U.S., FEDERAL LAW RESTRICTS THIS DEVICE TO SALE ON OR BY THE ORDER OF A PHYSICIAN.

Medical Device Directive

The M4735A HeartStart XL Defibrillator/Monitor complies with the requirements of the Medical Device Directive

93/42/EEC and carries the  0123 mark accordingly.

For the Declaration of Conformity Statement, please see the Philips Medical web site at <http://incenter.medical.philips.com/PMSPublic>. Scroll over the Quality and Regulatory Tab located in the upper left corner of the window. Click to select Regulatory by Modality. Then click to select Defibrillators and select the entry for Declaration of Conformity (DoC).

Manufacturer

Philips Medical Systems
3000 Minuteman Road
Andover, MA USA 01810-1099

Authorized EU-representative

Philips Medizin Systeme Böblingen GmbH
Hewlett Packard Str. 2
71034 Böblingen
Germany

Canada EMC:ICES-001

China:

After sales service: Beijing MEHECO-PHILIPS Medical Equipment Service Center

After sales service address: No. 208, 2nd District, Wang Jing Li Ze Zhong Yuan, Chao Yang District, Beijing

Postal Code: 100102

Telephone: 010-64392415

Registration Number:

SFDA(I)20043212740

Product standard number:

YZB/USA 2764-21

Warning

Radio frequency (RF) interference from nearby transmitting devices may degrade the performance of the M4735A HeartStart XL Defibrillator/Monitor. Electromagnetic compatibility with surrounding devices should be assessed prior to using the defibrillator/monitor.

This guide uses the following conventions:

WARNING

Warning statements describe conditions or actions that can result in personal injury or loss of life.

CAUTION

Caution statements describe conditions or actions that can result in damage to the equipment or loss of data.

NOTE

Notes contain additional information on usage.

TEXT

represents messages that appear on the display

Softkey

represents softkey labels that appear on the display above or below the button to which they correspond

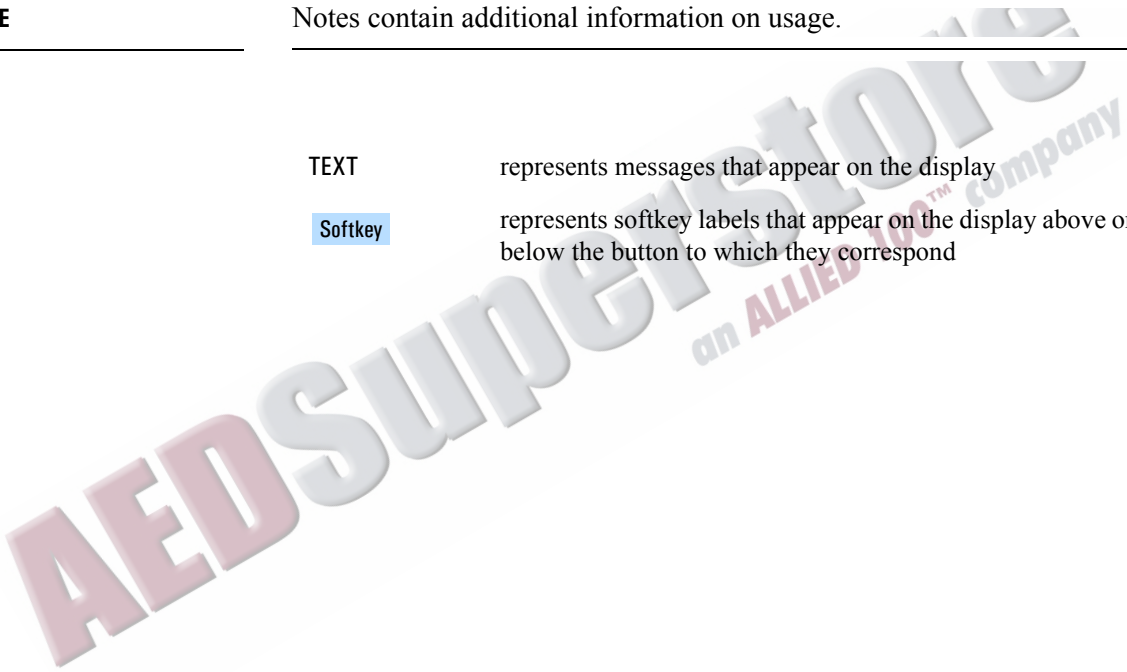

AED Superstore[®]
an **ALLIED 100**[™] company

Introduction

Overview	1-2
Intended Use	1-4
Defibrillation Therapy	1-4
Indications for AED Therapy	1-5
Contraindications for AED Therapy	1-5
Precautions for AED Therapy	1-5
Indications for Manual Defibrillation Therapy	1-6
Contraindications for Manual Defibrillation Therapy	1-6
Precautions for Manual Defibrillation Therapy	1-6
Noninvasive Pacing Therapy (Optional)	1-7
Indications	1-7
Contraindications	1-7
SpO2 Monitoring (Optional)	1-7
Indications	1-8
Contraindications	1-8
Safety Considerations	1-8
Documentation and Training	1-9

Getting Started

Getting Acquainted	2-2
Basic Orientation	2-2
Manual Mode Controls	2-5
Display Buttons	2-6
Display Layout	2-7
Connecting to Power	2-9
Inserting the Battery	2-10
Removing the Battery	2-11
Low Battery Warning	2-12
Continued Use	2-13
Using a Data Card (Optional)	2-14
Inserting a Data Card	2-15
Removing a Data Card	2-16

Defibrillating in AED Mode

Overview	3-3
Defibrillation (using the default configuration)	3-4
Defibrillation (with a modified configuration)	3-5
Preparation	3-6
Defibrillating	3-8
Automatic Re-analysis On	3-14
Automatic Re-analysis Off	3-14
Pausing for CPR	3-15
Monitoring Rhythm	3-17
ERC Protocol	3-19
Troubleshooting	3-21

Monitoring the ECG

Overview	4-2
Connecting the ECG Patient Cable	4-3
Applying Monitoring Electrodes	4-4
Electrode Placement	4-5
Using External ECG Monitors	4-7
Selecting the Lead	4-8
Setting the Heart Rate Alarm	4-10
Disabling the HR Alarm	4-11
Adjusting the ECG Size	4-11
Adjusting QRS Beeper and Voice Prompt Volume	4-11
Troubleshooting	4-12

Monitoring SpO2

Introduction	5-2
Understanding Pulse Oximetry	5-3
Selecting a Sensor	5-4
Reusable Sensors	5-5
Disposable Sensors	5-5
Applying the Sensor	5-6

Connecting the Sensor Cable	5-7
Monitoring	5-8
Setting Alarms	5-9
Responding to an Alarm	5-9
Discontinuing SpO2 Monitoring	5-10
Caring for Sensors	5-10
Troubleshooting	5-11

Defibrillating in Manual Mode

Manual Mode Display	6-2
Enabling Manual Mode	6-2
Defibrillating in Manual Mode	6-3
Using External Paddles	6-3
Using Pediatric Paddles	6-4
Using Multifunction Defib Electrode Pads	6-5
Using Switched Internal Paddles	6-6
Using Switchless Internal Paddles	6-8
Defibrillation Procedure	6-9
1. Select Energy	6-9
2. Charge	6-10
3. Shock	6-11
Entering AED Mode	6-12

Performing Synchronized Cardioversion

Monitoring the ECG	7-2
Using Multifunction Defib Electrode Pads	7-2
Using 3 or 5-wire ECG Leads	7-3
Using External Paddles	7-4
Using External ECG Monitors	7-5
Delivering a Synchronized Shock	7-6
Delivering Additional Synchronized Shocks	7-8
Disabling Sync Mode	7-8

Pacing (Optional)

Contents

Pacing Operational Controls	8-2
Demand Mode Versus Fixed Mode	8-2
Monitoring During Pacing	8-3
Preparing for Pacing	8-3
Performing Pacing	8-5
Changing Pacing Modes	8-8
Defibrillating During Pacing	8-8
Troubleshooting	8-9

Storing, Retrieving & Printing

Overview	9-2
Marking Events	9-3
Events Recorded	9-4
Creating a Patient Record	9-6
Printing the Internal Event Summary	9-7
Printing Events	9-9

Setting Up and Configuring the HeartStart XL

Connecting/Disconnecting Patient Cables	10-2
Connecting Cables to the Patient Cable Connector	10-3
Connecting the SpO2 Patient Cable	10-5
Connecting the ECG Patient Cable	10-6
Configuring the HeartStart XL	10-7
Accessing the Configuration Menu	10-7
Configurable Parameters	10-8
Modifying the Configuration	10-15
Returning to the Default Configuration	10-15
Saving Settings to a Data Card	10-16
Loading Settings from a Data Card	10-16
Printing Settings	10-16

Maintaining the HeartStart XL

Operational Checks	11-2
Before You Begin	11-2

Every Shift	11-3
Every Month	11-3
Using External Paddles	11-4
Using Pads	11-5
Using Internal Paddles	11-7
Battery Maintenance	11-8
Recharging Batteries	11-9
Battery Capacity Test	11-9
Battery Capacity	11-12
Battery Life Expectancy	11-12
Storing Batteries	11-12
Discarding Batteries	11-12
Loading Printer Paper	11-13
Cleaning Instructions	11-15
Cleaning the HeartStart XL	11-15
Cleaning the Printer Printhead	11-15
Cleaning Defib Pads & Monitoring Electrodes	11-16
Cleaning the External and Internal Paddles	11-16
Cleaning the Pads Cable	11-17
Cleaning the ECG Cable	11-17
Cleaning the SpO2 sensor and cable	11-17
Supplies & Accessories	11-18
Disposing of the HeartStart XL	11-23

Troubleshooting

System Messages	12-2
Momentary Messages	12-5
Troubleshooting Tips	12-7
Calling for Service	12-10
Asia/Asia Pacific	12-11

Specifications & Safety

Specifications	13-2
Defibrillator	13-2

Contents

ECG Monitoring	13-6
Display	13-9
Battery	13-10
Noninvasive Pacing	13-12
SpO2 Pulse Oximetry	13-13
Event Storage	13-14
General	13-14
Environmental	13-14
Symbol Definitions	13-16
Clinical Performance Summary - Defibrillation	13-21
Methods	13-21
Results	13-21
Conclusion	13-22
Clinical Performance Summary - Cardioversion	13-23
Methods	13-23
Results	13-23
Conclusion	13-25
Clinical Performance Summary - Internal Defibrillation	13-26
Overview	13-26
Methods	13-26
Results	13-27
Conclusion	13-27
Safety Considerations	13-28
Electromagnetic Compatibility	13-32
(Devices with Serial Numbers US001XXXXX)	13-32
Reducing Electromagnetic Interference	13-33
Restrictions for Use	13-34
Immunity Level	13-34
Electromagnetic Compatibility	13-35
(Devices with Serial Numbers US002XXXXX)	13-35
Reducing Electromagnetic Interference	13-36
Restrictions for Use	13-36
Emissions and Immunity	13-37
Guidance and Manufacturer's Declaration	13-38
Recommended Separation Distances	13-45

1 Introduction

The M4735A HeartStart XL Defibrillator/Monitor is designed to meet your resuscitation and monitoring needs. This guide provides instructions for safe and proper operation, set-up, configuration, and care of your M4735A HeartStart XL Defibrillator/Monitor.

In this chapter, you'll find general information that you should become familiar with before using the defibrillator/monitor.

AED Superstore®
an ALLIED 100™ company

Overview

The M4735A HeartStart XL Defibrillator/Monitor is a lightweight, portable, semi-automatic external defibrillator. It offers two modes of operation for defibrillation:

- Automated External Defibrillation (AED) Mode
- Manual Mode

Both modes incorporate a low energy SMART Biphasic waveform for defibrillation.

In AED Mode, the M4735A HeartStart XL Defibrillator/Monitor analyzes the patient's ECG and advises you whether or not to deliver a shock. Voice prompts guide you through the defibrillation process by providing instructions and patient information. Voice prompts are reinforced by messages that appear on the display.

In Manual Mode, the M4735A HeartStart XL Defibrillator/Monitor turns control of the defibrillation process over to you. You assess the patient's ECG, and select the energy setting for defibrillation if necessary. Manual Mode also allows you to perform synchronized cardioversion and offers noninvasive pacing (optional).

Defibrillation is performed through external or internal paddles (both optional), or through multifunction defib electrode pads. Monitoring is available in AED and Manual Mode through pads, 3-lead ECG monitoring electrodes, or optional 5-lead ECG monitoring electrodes. Optional pulse oximetry (SpO₂) monitoring is also available in AED and Manual Modes. While monitoring ECG or SpO₂, you may set heart rate and/or SpO₂ alarms to alert you when these parameters are outside the defined limits.

The M4735A HeartStart XL Defibrillator/Monitor automatically stores critical events in its internal memory, such as shocks and alarm violations. Additional events of interest may also be marked for storage. These events can be printed as they occur or as part of an Event Summary. The M4735A HeartStart XL Defibrillator/Monitor also allows you to store data and events on an optional HeartStart XL-compatible data card (see Chapter 11 for a listing) for downloading to HeartStart Event Review Data Management Systems.

The versatile M4735A HeartStart XL Defibrillator/Monitor is highly configurable to better meet the needs of diverse users. The messages and softkeys vary, depending on how the M4735A HeartStart XL Defibrillator/Monitor is configured. Be sure to familiarize yourself with your configuration before using the M4735A HeartStart XL Defibrillator/Monitor (see “Configuring the HeartStart XL” on page 10-7).

The M4735A HeartStart XL Defibrillator/Monitor is powered by AC power and a rechargeable sealed lead acid (SLA) battery which allows the defibrillator to charge to 200 joules in less than three seconds. Proper care of your batteries will ensure that they have the energy required to operate the M4735A HeartStart XL Defibrillator/Monitor and to deliver the appropriate therapy. (See “Battery Maintenance” on page 11-8.) Similarly, performing the specified operational checks will ensure that the M4735A HeartStart XL Defibrillator/Monitor is functioning properly and ready for use. (See “Operational Checks” on page 11-2.)

Intended Use

The M4735A HeartStart XL Defibrillator/Monitor is for use in the hospital by qualified medical personnel trained in the operation of the device and qualified by training in basic life support, advanced cardiac life support, or defibrillation. It must be used by or on the order of a physician.

When operating as a semi-automatic external defibrillator in AED Mode, the M4735A HeartStart XL Defibrillator/Monitor is suitable for use by medical personnel trained in basic life support that includes the use of an AED.

When operating as a defibrillator/monitor in Manual Mode, the M4735A HeartStart XL Defibrillator/Monitor is suitable for use by healthcare professionals trained in advanced cardiac life support.

Defibrillation Therapy

Defibrillation therapy is the definitive method for termination of a variety of potentially fatal arrhythmias. The M4735A HeartStart XL Defibrillator/Monitor provides this therapy through the application of a brief biphasic pulse of electricity to the cardiac muscle. This electrical energy is transferred through attached internal paddles applied directly to the patient's heart, or through attached paddles or disposable multifunction defib electrode pads applied to the patient's bare chest.

NOTE

Successful resuscitation is dependent on many variables specific to the patient's physiological state and the circumstances surrounding the patient event. Failure to have a successful patient outcome is not a reliable indicator of defibrillator/monitor performance. The presence or absence of a muscular response to the transfer of energy during electrical therapy is not a reliable indicator of energy delivery or device performance.

Indications for AED Therapy

An AED is to be used in the presence of a suspected cardiac arrest on patients of at least 8 years of age that are:

- Unresponsive
- Not breathing
- Pulseless

Contraindications for AED Therapy

An AED is not to be used on patients that exhibit one or any combination of the following:

- Responsiveness
- Spontaneous breathing
- Palpable pulse

Precautions for AED Therapy

The AED algorithm is not designed to handle erratic spiking problems caused by a properly or improperly functioning pacemaker. In patients with cardiac pacemakers, the M4735A HeartStart XL Defibrillator/Monitor may have reduced sensitivity and not detect all shockable rhythms.

NOTE

The Philips HeartStart XL AED algorithm is not intended for children under 8 years of age. For children older than 8 years, the American Heart Association recommends that standard operating procedures for AEDs be followed. American Heart Association *Guidelines 2005 for Cardiopulmonary Resuscitation and Emergency Cardiovascular Care*. Dallas, Texas; AHA; 2005.

Indications for Manual Defibrillation Therapy

Asynchronous defibrillation is the initial treatment for ventricular fibrillation and ventricular tachycardia, in patients who are pulseless and unresponsive.

Synchronous defibrillation is indicated for termination of atrial fibrillation. The SMART Biphasic waveform utilized in the HeartStart XL Defibrillator/Monitor has undergone clinical testing demonstrating its effectiveness for cardioversion of atrial fibrillation.

The SMART Biphasic waveform utilized in the M4735A HeartStart XL Defibrillator/Monitor has undergone clinical testing in adults. These trials support the waveform's effectiveness for defibrillation of ventricular tachyarrhythmias at the 150J setting.

In Manual mode operation, the M4735A HeartStart XL Defibrillator/Monitor incorporates some user selectable lower energy levels that were not used in the clinical trials.

There are currently no clinical studies related to the use of the SMART Biphasic waveform in pediatric applications.

Contraindications for Manual Defibrillation Therapy

Asynchronous defibrillation therapy is contraindicated in patients that exhibit one or any combination of the following:

- Responsiveness
- Spontaneous breathing
- Palpable pulse

Precautions for Manual Defibrillation Therapy

Defibrillating asystole can inhibit the recovery of natural pacemakers in the heart and completely eliminate any chance of recovery. Asystole should not be routinely shocked.

Noninvasive Pacing Therapy (Optional)

The M4735A HeartStart XL Defibrillator/Monitor provides noninvasive transcutaneous pacing by delivering a monophasic, electrical stimulus to the heart. This stimulus is intended to cause cardiac depolarization and myocardial contraction. The medical care provider selects the stimulus current and rate settings. The energy is delivered through multifunction defib electrode pads applied to the patient's bare chest.

Indications

Noninvasive pacing is one method of treating patients with symptomatic bradycardia. It can also be helpful in patients with asystole, if performed early.

Contraindications

Noninvasive pacing is contraindicated in the treatment of ventricular fibrillation. Noninvasive pacing in the presence of severe hypothermia may be contraindicated.

SpO₂ Monitoring (Optional)

A pulse oximeter is a noninvasive device that indicates the oxygen saturation (SpO₂) of arterial blood. This measurement is obtained through a probe that directs red and near infrared light through arterial beds. Hemoglobin absorbs these lights differently when it is bound with oxygen. Pulse oximetry measures this difference and translates the measurement into a saturation percentage that is displayed as an SpO₂ reading.

Indications

SpO₂ monitoring is indicated for use when it is beneficial to assess a patient's oxygen saturation level.

Contraindications

There are no known contraindications for SpO₂.

NOTE

Readings should be carefully considered in the presence of certain circumstances. Inaccuracies may result from the use of pulse oximeters in the presence of certain circumstances, such as hemoglobin saturated with compounds other than oxygen, (such as carbon monoxide), hypothermia, hypovolemia, patient movement, nail polish and excessive ambient light.

Safety Considerations

General warnings and cautions that apply to use of the M4735A HeartStart XL Defibrillator/Monitor are provided in Chapter 13. Additional warnings and cautions specific to a particular feature are provided in the appropriate section of this guide.

Documentation and Training

Documentation for the M4735A HeartStart XL Defibrillator/Monitor includes:

- *M4735A HeartStart XL Defibrillator/Monitor Instructions for Use*
- *M4735A HeartStart XL Defibrillator/Monitor Quick Reference Card*, and
- *About Sealed Lead Acid Batteries*, an application note on battery maintenance.

Training tools available for use with the M4735A HeartStart XL include:

- *Using the M4735A HeartStart XL Defibrillator/Monitor*, a workbook
- *HeartStart XL User Training CD-ROM*
- *HeartStart XL User Training Video*

For additional online documentation and training, please visit our website:
www.medical.philips.com/cms.

Available online training materials include:

- AED Application Note
- SpO₂ Concept Guide
- Pacing Application Note

AED Superstore[®]
an **ALLIED 100**[™] company

2 Getting Started

Congratulations on purchasing your HeartStart XL!

This chapter will give you a quick tour of your new defibrillator/monitor's controls and display.

The HeartStart XL ships complete with the cables, battery, and paper necessary for easy operation. This chapter will help you get your HeartStart XL up and running by following a few easy steps, including:

- Connecting to AC Power
- Inserting the battery
- If desired, inserting the optional HeartStart XL-compatible Data Card (see Chapter 11 for a listing).

NOTE

To connect cables to the HeartStart XL, refer to “Setting Up and Configuring the HeartStart XL” in Chapter 10.

Getting Acquainted

This section provides an overview of the HeartStart XL controls, connections, and display layout. A review of control functionality is also provided.

Basic Orientation

Review the figure for a general layout of the controls, where the patient cables connect, and where to insert the battery and Data Card.

Figure 2-1 Basic Orientation (Front)

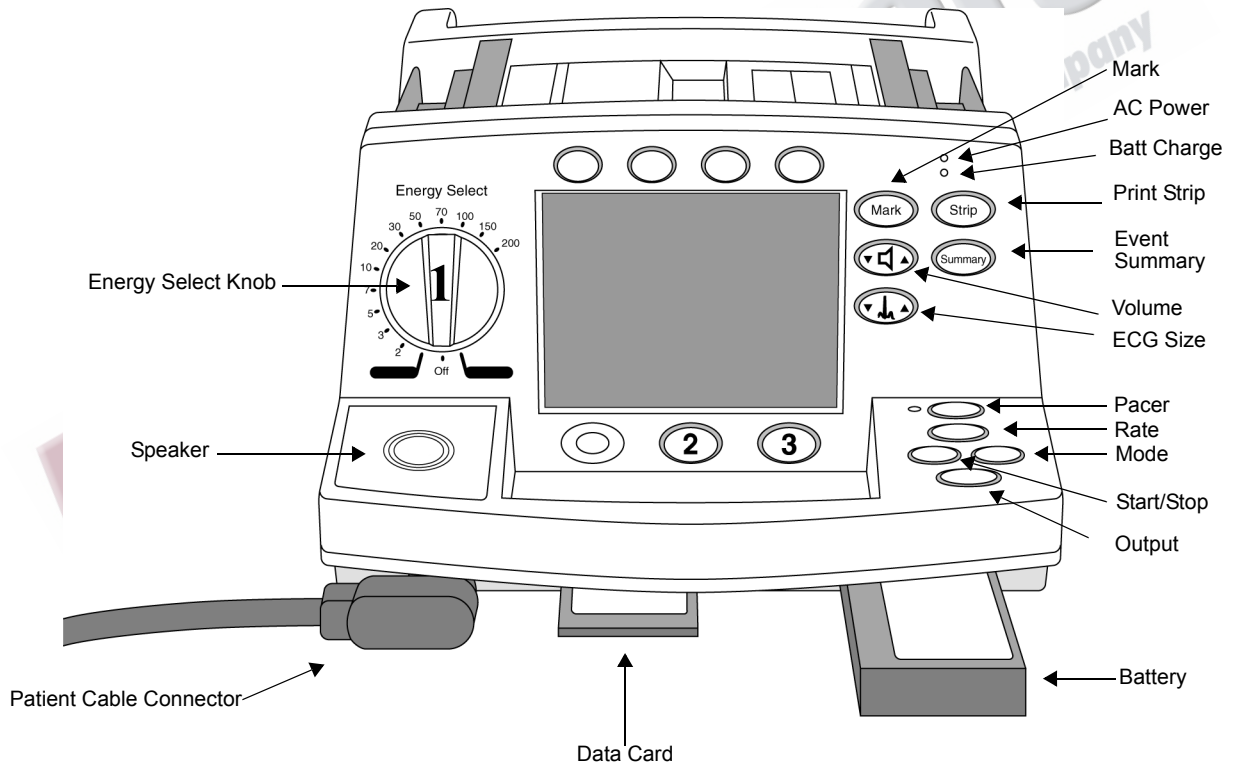
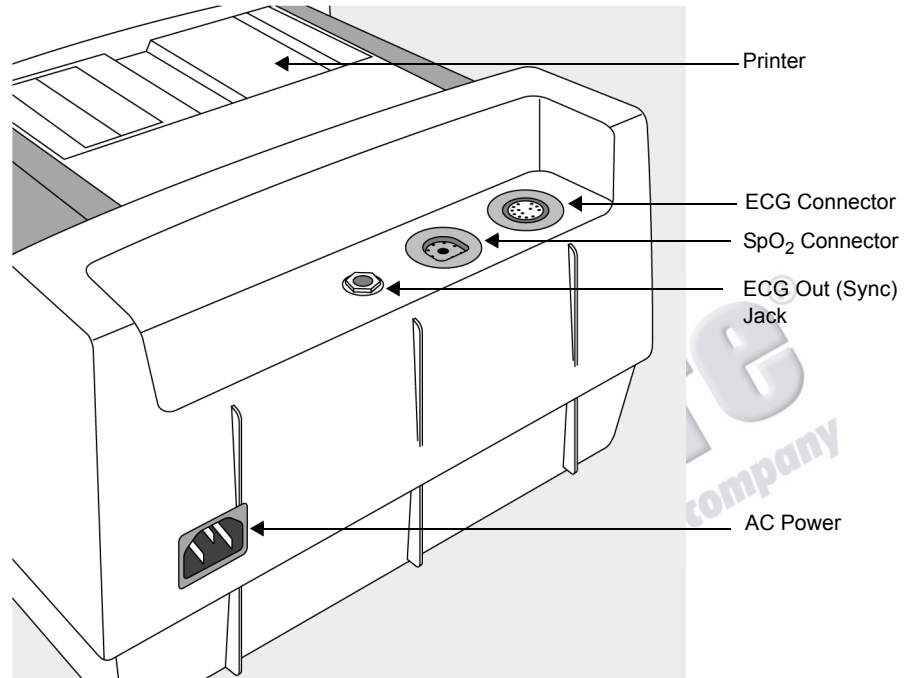

Figure 2-2 HeartStart XL (Back)



NOTE

If your HeartStart XL does not have the SpO₂ or Pacing option, disregard these controls and the related information described in this section.

Defibrillation Controls

Defibrillation controls consist of an energy select knob and a set of softkeys that perform the function displayed as a label above each button. These controls assist in both AED and Manual Mode defibrillation.

Audiovisual Controls



Adjusts the volume of voice prompts and the QRS beeper. At the lowest setting, the QRS beeper is muted. The voice prompts and other alert tones cannot be muted.



Adjusts the size of the ECG waveform displayed, printed, and stored. Pressing ▲ and ▼ simultaneously generates a 1 mV calibration pulse.

NOTE



To permanently turn the QRS beeper off, use the General settings in Configuration mode. See Chapter 10 “Setting Up and Configuring the Heart-Start XL”.

Monitoring Controls

Monitoring controls consist of a set of softkeys that perform monitoring functionality. These functions are displayed in the softkey label below each button. Monitoring softkeys also control heart rate and SpO₂ alarms, and selection of the ECG source to monitor.

Print Controls

Print controls perform the function shown on each button. The print controls from are:

- 
 Prints ECG data, defibrillation events, and marked events real-time or with a 6 second delay (as configured). Press to start printing; press again to stop printing.
- 
 Prints the Event Summary. (See “Storing, Retrieving & Printing” for more information.) Printing may be stopped by pressing the **Summary** or **Strip** button.
- 
 Inserts a time-stamped annotation in the Event Summary. May be configured to print an annotated ECG strip when pressed.

Manual Mode Controls

Manual Mode controls provide access to manual defibrillation, and synchronized cardioversion and optional pacing functionality.

Figure 2-3 Manual Mode Controls: Energy Select Knob and Pacing Controls

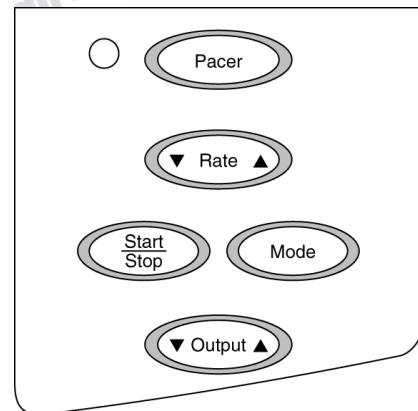
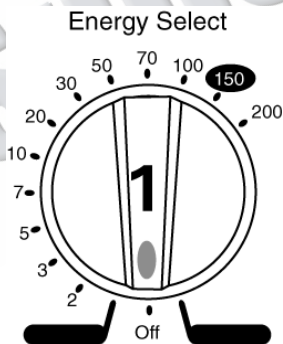

Display Buttons

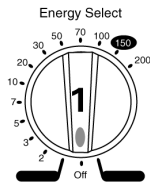

Can enable both Manual Mode and AED Mode. The AED On position activates AED Mode. Manual On enables Manual Mode, synchronized cardioversion and pacing (optional).

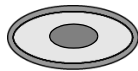

Button below the display (far left) that enables synchronized cardioversion when first pressed in Manual Mode; disables synchronized cardioversion when pressed again.



Activates the pacing function buttons (as indicated by the green LED), allowing you to use the buttons below to define pacing rate, mode, and current output. Also turns off the Pacer function when pressed a second time.



Adjusts the pacing rate.



Starts pacing. Delivers pacer pulses when first pressed; stops pacing when pressed again.



Selects Demand or Fixed Mode for pacing.



Adjusts the current output for pacing.

NOTE

Synchronized cardioversion and pacing controls only function when Manual Mode is enabled.

Display Layout

The following figures show the layout of the display in:

- AED Mode, with ECG and SpO₂ monitoring capabilities enabled
- AED Mode, with ECG and SpO₂ monitoring capabilities disabled
- Manual Mode

NOTE

ECG and SpO₂ monitoring capabilities for AED Mode may be enabled and disabled independently in the configuration.

Figure 2-4 AED Mode Display Layout (ECG and SpO₂ Enabled)

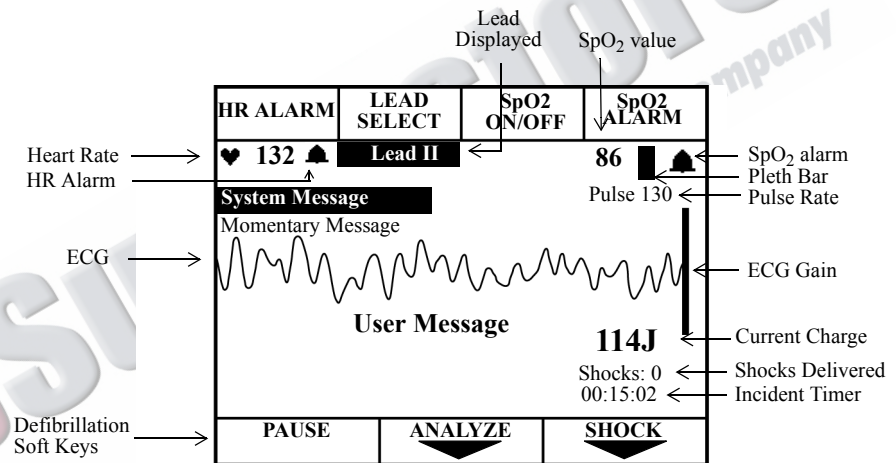

The Incident Timer shows the elapsed time since the HeartStart XL was turned on, provided patient contact was established. If the HeartStart XL is powered on after being off for less than two minutes, the Incident Timer resumes where it left off. If power is off for more than two minutes, the Incident Timer resets to zero (00:00:00). If an Event Summary is printed, the incident timer will be set to zero the next time the unit is turned on.

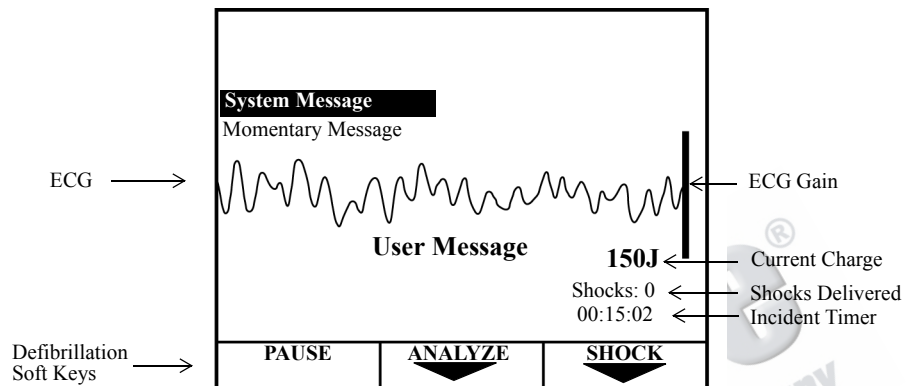
Figure 2-5 AED Mode Display Layout (ECG and SpO₂ disabled)

User messages accompany voice prompts to guide you through the defibrillation process.

System and Momentary Messages:

- alert you to conditions that require your attention,
- provide status information, or
- offer recommendations.

A System Message remains on the display until the condition that generated the message no longer exists. A Momentary Message is temporary and appears on the display for a minimum of 3 seconds. For a list of system and momentary messages, see Chapter 12.

Figure 2-6 Manual Mode Display Layout

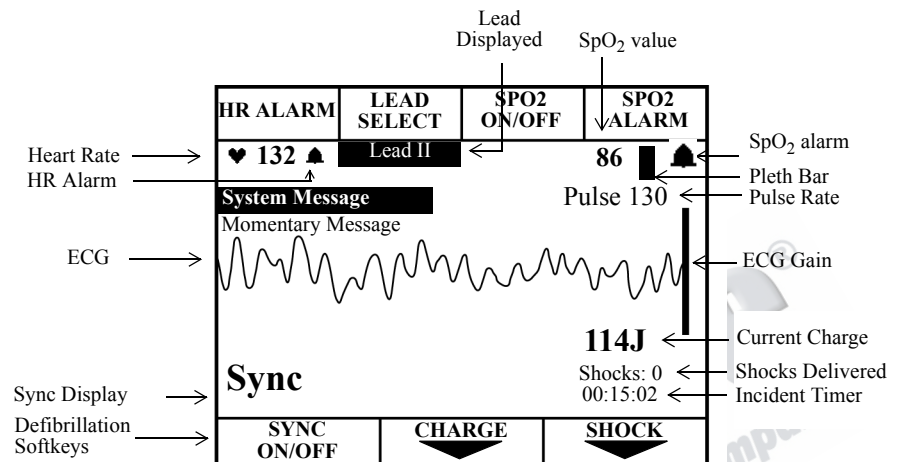

Connecting to Power

The HeartStart XL is powered by AC Power and the M3516A battery. Prior to inserting the battery, make sure that the battery is charged and has been properly maintained (See “Battery Maintenance” on page 11-8). It is recommended that a second, charged battery be available at all times.

NOTE

The HeartStart XL will take longer to charge to the desired energy level when using only AC Power and without the battery.

Inserting the Battery

To insert the battery, slide it into the battery receptacle as shown in Figure 2-7. Then push the battery in until you hear an audible click.

Figure 2-7 Inserting the Battery

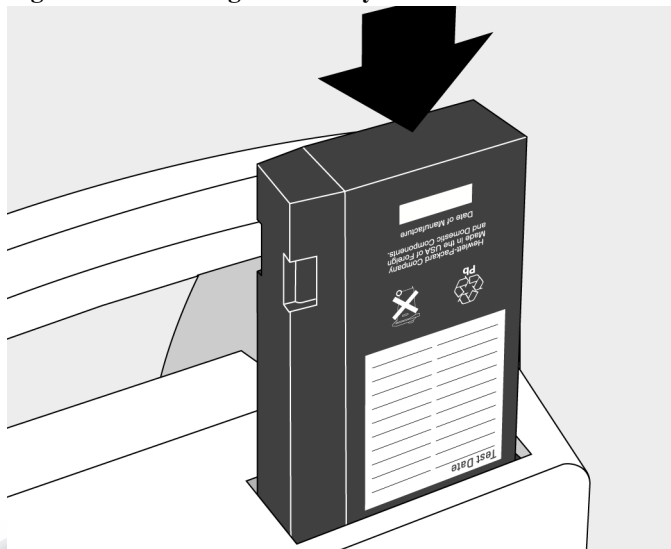

Removing the Battery

To remove the battery from the HeartStart XL, press the black battery eject button and pull the battery out, as shown in Figure 2-8.

Figure 2-8 Removing the Battery

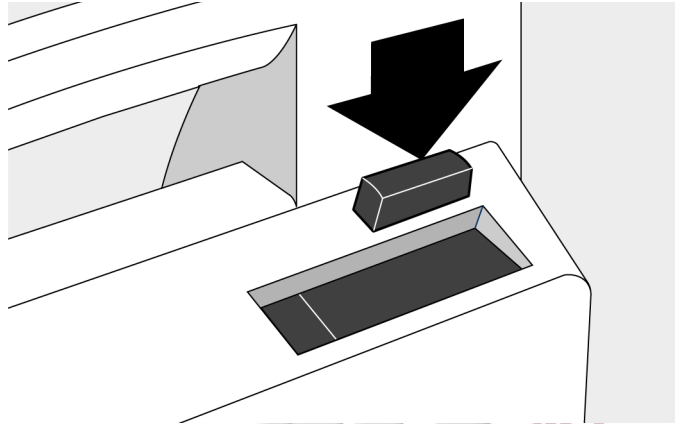

Low Battery Warning

The message **Low Battery** is displayed when the battery is low and needs recharging. This message indicates that the battery has sufficient remaining capacity to provide only about ten minutes of monitoring time and five shocks before the HeartStart XL shuts off. Replace the battery or get access to AC power as soon as possible.

If the power is off for less than 2 minutes, while you change the battery, the HeartStart XL assumes that you are continuing to treat the same patient, provided patient contact was established and the Event Summary was not printed prior to turning the power off. It continues to store data on the Data Card if being used and append events to the existing Event Summary. Alarms set prior to the power loss remain active.

If power remains off for more than 2 minutes, the HeartStart XL assumes you are treating a different patient and assigns a new incident number. A new Event Summary begins when patient contact is made.

AEDSupersource
an ALLIED 100™ company

Continued Use

Once a patient event is started, the Continued Use feature is activated. This feature facilitates continued care of the same patient by retaining settings and the patient record when the HeartStart XL is powered off for less than 2 minutes, such as to change a battery or transition between AED and Manual Modes. When power is restored within the 2 minute time period, the HeartStart XL retains the most recent settings, including:

- Alarms
- ECG lead displayed
- Incident time
- QRS and voice prompt volumes (including muting of the QRS, if set)
- ECG gain
- Patient record, in the event summary and on the data card (if used); new data is appended to the record

NOTE

Sync Mode remains active if power is disrupted in Manual Mode for less than 2 minutes. However, Sync is disabled when AED Mode is activated, and remains disabled even if you return to Manual Mode.

Using a Data Card (Optional)

Use of a Data Card is optional; the defibrillator will power up without a Data Card inserted. If you would like to collect patient information on a Data Card, the card must be inserted into the HeartStart XL *before* the device is turned on.

CAUTION

Inserting or removing the data card while the defibrillator is on can corrupt the Data Card and prevent the unit from powering on again. If this occurs, see Table 12-3, Troubleshooting Tips.

The recommended practice is to use one Data Card per patient. Once a Data Card fills, recording stops; a second Data Card may not be inserted for the current incident, because the device will only allow the use of one Data Card per incident. Data Cards hold a minimum of two hours of patient information. Multiple incidents can be recorded on a single Data Card. Each incident is assigned a unique incident number.

Patient data from a HeartStart XL-compatible Data Card may be downloaded to a HeartStart Event Review Data Management system. HeartStart Event Review also allows you to erase patient data from a Data Card, allowing the card to be reused for another patient.

It's recommended that you use a designated Data Card to configure one or more defibrillators/monitors.

CAUTION

Use only a HeartStart XL-compatible Data Card (see Chapter 11 for a listing). These cards are specifically formatted to work with your Philips defibrillator. Generic cards, or other types of cards (such as modem cards) will not work, and may cause the defibrillator to malfunction.

Inserting a Data Card

To insert a Data Card:

1. Make sure the HeartStart XL is turned off.
2. Press up on the release latch to open the door to the Data Card compartment.
3. If a Data Card is already in the compartment, press the black button to the left of the card to eject the card (see Figure 2-9). Then pull the card out.
4. With the yellow label facing up and the ▲ pointing towards the HeartStart XL, slide the Data Card into the compartment. Be sure the card is seated securely within the compartment.
5. Close the Data Card compartment door. Make sure that you hear a click, indicating that the door is latched shut.

Figure 2-9 Inserting a Data Card

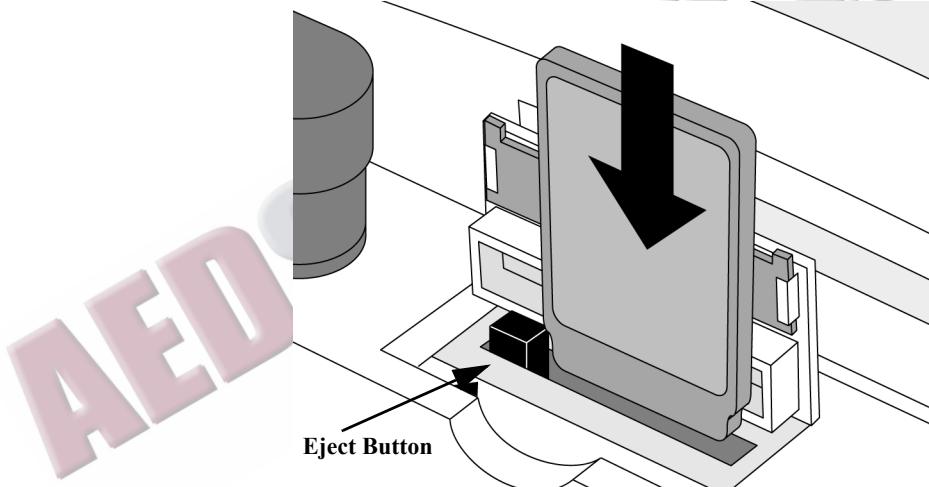

Removing a Data Card

To remove the Data Card:

1. Make sure the HeartStart XL is turned off, (wait 2 seconds).
2. Press the black eject button (see Figure 2-10).
3. Pull the Data Card from the compartment.

Figure 2-10 Removing the Data Card

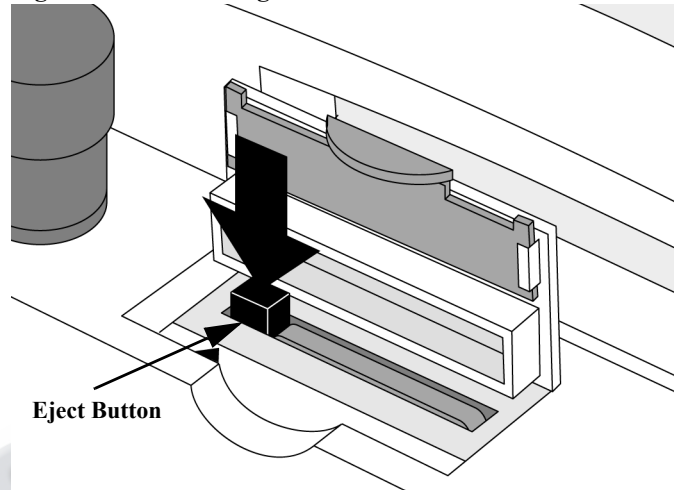

AED

3 Defibrillating in AED Mode

The HeartStart XL's AED Mode is designed to guide you through standard treatment algorithms for cardiac arrest, including those provided by the American Heart Association and the European Resuscitation Council. Configuration choices allow you to customize AED Mode to better follow a specific treatment algorithm and to meet the unique needs of your life-saving team.

This chapter describes how to use the HeartStart XL to defibrillate in AED Mode. It explains the prompts that guide you through the defibrillation process and describes how prompts vary depending upon the condition of the patient and the configuration of your device.

For information on storing, retrieving, and printing patient information acquired in AED Mode, see Chapter 9.

Figure 3-1 AED Mode Overview

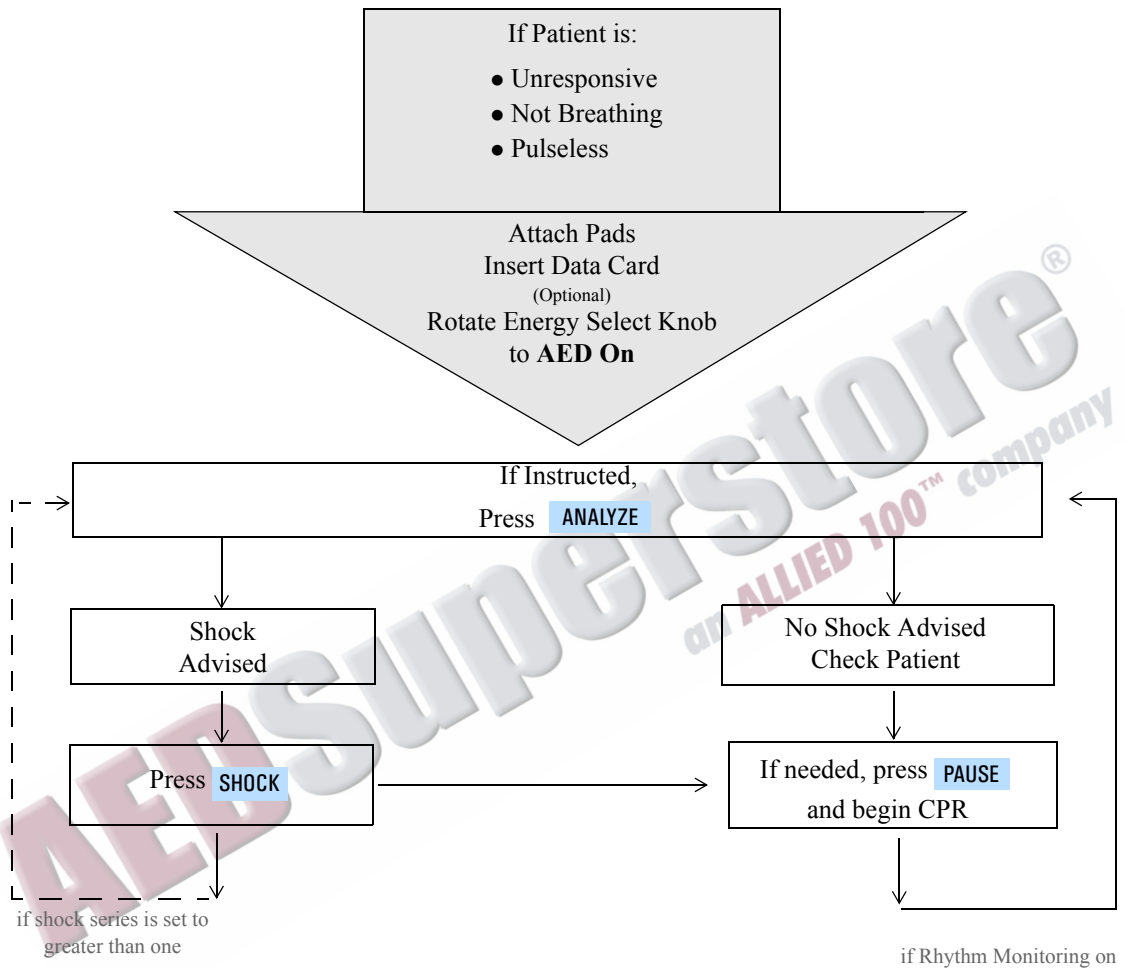

Overview

An overview of the AED Mode defibrillation process is shown in Figure 3-1.

The process begins only after you have:

- assessed that the patient is unresponsive, not breathing, and pulseless,
- prepared for defibrillation by attaching pads and cables,
- inserted a Data Card (if desired), and
- turned the Energy Select knob to AED On.

NOTE

If AED prompts are not active in AED Mode, press ANALYZE to activate voice and text prompts.

AED Superstore[®]
an ALLIED 100[™] company

The defibrillation process is dependent upon the configuration of your HeartStart XL, as described in the following paragraphs.

Defibrillation (using the default configuration)

In its default configuration, the defibrillation process is:

Turn the Energy Select knob to AED On.

Figure 3-2 Energy Select Knob

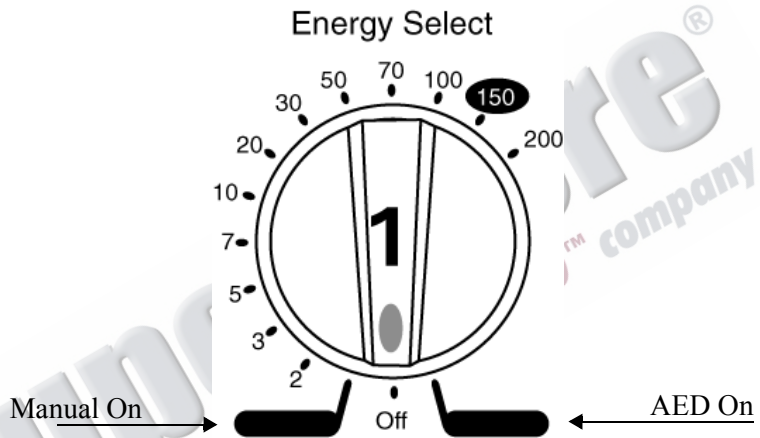

The HeartStart XL checks to see if the pads patient cable and multifunction defib electrode pads are properly connected. If either connection is compromised, you are prompted to fix the problem.

- 2** Analysis begins automatically - there is no need to press **ANALYZE**.
Once analysis is complete, the HeartStart XL tells you **Shock Advised** or **No Shock Advised**.
- 3** If a shock is advised, press **SHOCK**.
After a shock is delivered, the HeartStart XL automatically prompts you to press pause and begin CPR, if needed.

Defibrillation (with a modified configuration)

Chapter 10 details the configurable parameters for AED Mode. Three parameters significantly impact the defibrillation process. They are:

Device Initiated Analysis - initiates ECG analysis when the HeartStart XL is first turned on. The default configuration setting is **On**. If you choose to set this parameter to **Off**, you need to press **ANALYZE** to initiate analysis in step 2 of the defibrillation process.

Automatic Re-analysis - initiates ECG analysis in between shocks within a multi-shock series. The default configuration setting is **On**. If you choose to set this parameter to **Off**, you need to press **ANALYZE** to initiate analysis in between shocks within a multi-shock series (i.e. after the first and second shock of a three shock series).

Rhythm Monitoring - monitors the ECG for potentially shockable rhythms when the HeartStart XL is not analyzing, defibrillating, or paused. The default setting is **On**. If you choose to set this parameter to **Off**, the HeartStart XL will not look for potentially shockable rhythms during these idle times. Idle times also include:

- power on, when Device Initiated Analysis is off.
- in between shocks within a multi-shock series, when Auto Re-analysis is off.

If Rhythm Monitoring is off, you need to observe the patient during idle times and determine when to press **ANALYZE**.

The following sections describe the defibrillation process in detail.

Preparation

If the patient is:

- unresponsive
- not breathing
- pulseless

Then:

1. Apply multifunction defib electrode pads to the patient, as directed on the package. Use the anterior-anterior electrode placement.
2. Connect the pads to the pads patient cable, as shown in Figure 3-3.
3. Connect the patient cable to the patient cable connector on the defibrillator, as described in "Connecting Cables to the Patient Cable Connector" on page 10-3.
4. If needed, insert a Data Card (as described in "Using a Data Card (Optional)" on 2-14).

Figure 3-3 Connecting Pads to the Patient Cable

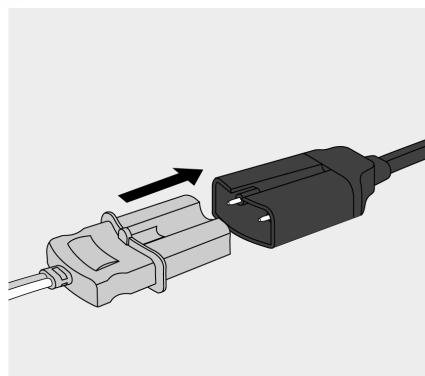
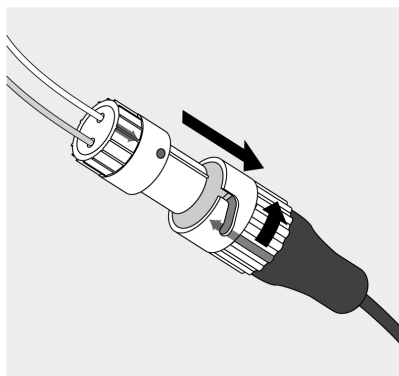

NOTE

Impedance is the resistance between the defibrillator's pads or paddles that the defibrillator must overcome to deliver an effective discharge of energy. The degree of impedance differs from patient to patient and is affected by several factors including the presence of chest hair, moisture, and lotions or powders on the skin.

The low-energy SMART Biphasic waveform is an impedance-compensating waveform that is designed to be effective across a wide range of patients. However, if you receive a "No Shock Delivered" message, check that the patient's skin has been washed and dried and that any chest hair has been clipped. If the message persists, change the pads and/or the pads cable.

AED Superstore
an ALLIED 100™ company

Defibrillating

Follow the voice and screen prompts as they guide you through the following steps:

1. Turn the Energy Select knob to AED On.

In this first step of the defibrillation process, the HeartStart XL checks to see if the pads patient cable and the pads are connected. If they are, it proceeds to step 2.

If the pads patient cable is not properly attached, you are prompted to **Connect Pads Cable**.

Figure 3-4 Connect Pads Cable Display

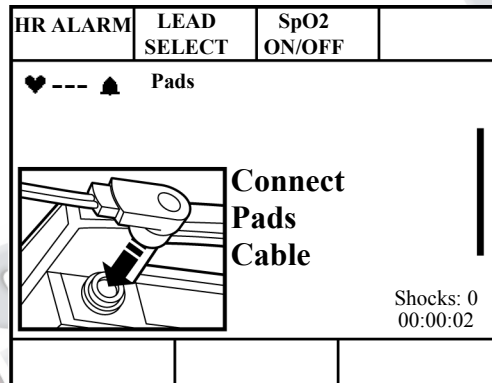

Once the cable is connected, the HeartStart XL will ensure the pads have adequate contact with the patient's skin. Contact quality is measured by monitoring the electrical impedance between the two pads.

If the pads have not been applied or are not making proper contact with the patient, you are prompted to **Apply Pads** and **Check Connections**.

Figure 3-5 Apply Pads Display

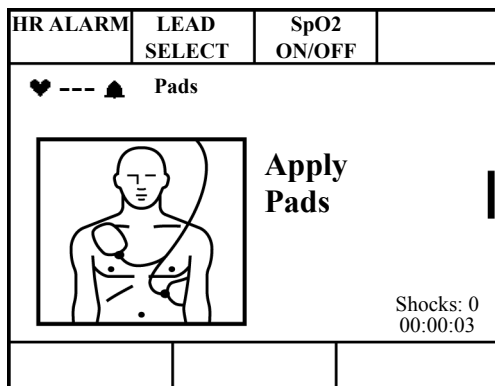

2. If instructed, press ANALYZE .

If device-initiated analysis is **off**, the HeartStart XL monitors the rhythm provided Rhythm Monitoring is on. The HeartStart XL prompts you to press **ANALYZE** if a potentially shockable rhythm is detected.

Figure 3-6 Press ANALYZE Display

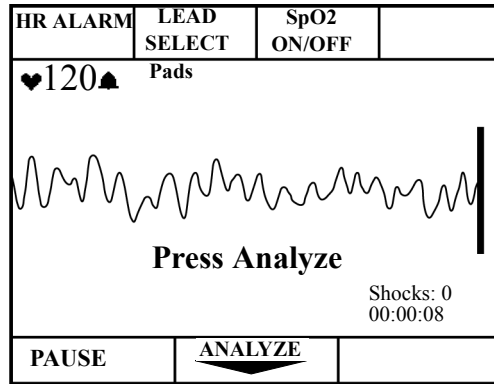

NOTE

ECG Analysis is always performed through multifunction defib electrode pads. Analysis can not be performed through monitoring electrodes.

If device-initiated analysis is **on**, you do not need to press **ANALYZE**; ECG analysis begins automatically.

Figure 3-7 Analyzing Display

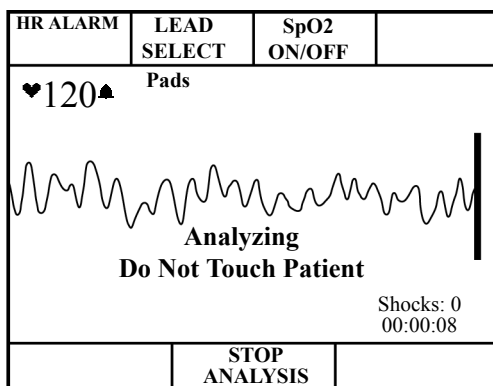

WARNING

Handling or transporting the patient during ECG analysis can cause incorrect or delayed diagnosis.

3. If no shock is advised

If a non-shockable rhythm is detected, the message **No Shock Advised Check Patient**, will appear. You will then be instructed to press **PAUSE** and begin CPR if needed (see page 3-15).

Figure 3-8 No Shock Advised

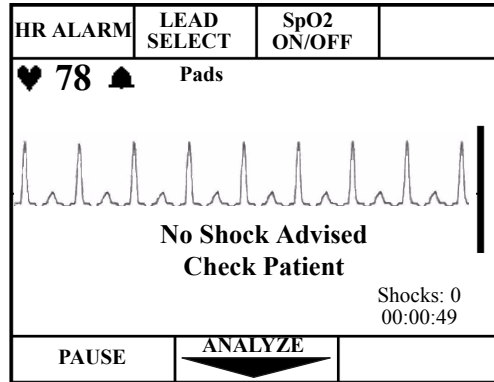

AED SUPPLY
an ALLIED

4. If a shock is advised

If a shockable rhythm is detected, the message **Shock Advised** will appear. Analysis stops and the HeartStart XL automatically charges to 150J. Charging is accompanied by an intermittent charge tone.

Figure 3-9 Charging Display

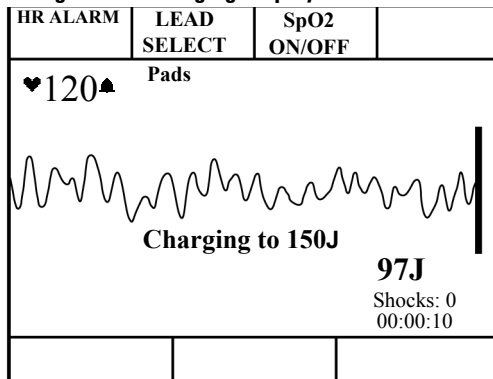

Once charging is complete, the charge tone becomes continuous. Make sure no one is touching the patient or anything connected to the patient. Call out clearly and loudly "Stand Clear." Then press **SHOCK** to deliver a shock to the patient.

Figure 3-10 Press SHOCK Display

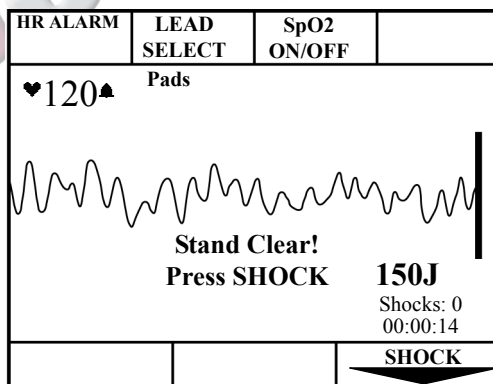

WARNING

Defibrillation current can cause operator or bystander injury. Do not touch the patient or equipment connected to the patient during defibrillation.

The defibrillator automatically disarms within 30 seconds if you do not press **SHOCK**.

Delivery of the shock is confirmed by the message **Shock Delivered** and the shock counter is updated. You will then be instructed to press **PAUSE** and begin CPR if needed (see page 3-15).

Figure 3-11 Shock Delivered Display

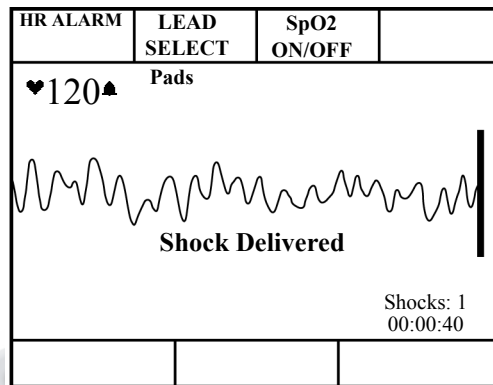

Automatic Re-analysis On

If Automatic Re-analysis is on and you have a shock series of two or more, the HeartStart XL analyzes the ECG following delivery of the shock. You are prompted to press **SHOCK**, if an additional shock is advised. This cycle repeats until the rhythm converts or a shock series is complete. (A shock series may be configured to 1, 2, 3, or 4 shocks.)

Automatic Re-analysis Off

If Automatic Re-analysis is off, the HeartStart XL monitors the ECG for potentially shockable rhythms (provided Rhythm Monitoring is on) and prompts you to press **ANALYZE** if one is detected. You can initiate analysis without being prompted by pressing **ANALYZE**.

Pausing for CPR

After a shock or when no shock advised, the HeartStart XL prompts **If Needed Press Pause and Begin CPR**:

Figure 3-12 Press Pause Display

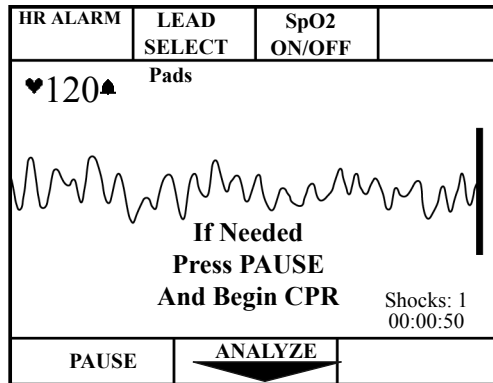

If CPR is needed, press **PAUSE**. While paused, the Pause Timer indicates the elapsed time and the total duration of the pause state, in seconds. The Pause Timer is configurable to meet your local CPR protocol needs. Rhythm, SpO₂ and heart rate monitoring alarms are suspended for the duration of the pause.

NOTE

* If your HeartStart XL is configured to support the European Resuscitation Council Guidelines for Resuscitation, refer to the “ERC Protocol” section on page 3-19 for details.

Figure 3-13 Pause Display

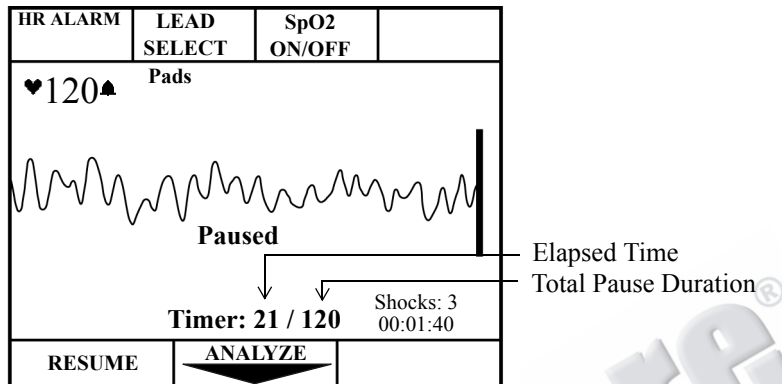

The pause state ends when the Pause Timer reaches the preconfigured pause state duration, or if you press **RESUME** or **ANALYZE**. At the completion of the pause state, the defibrillation process begins again. If instructed, press **ANALYZE**.

If you do not press **PAUSE**, the HeartStart XL begins monitoring the ECG rhythm provided Rhythm Monitoring is on.

You may initiate ECG analysis at any time by pressing **ANALYZE**.

Monitoring Rhythm

When the HeartStart XL is not analyzing, defibrillating, or paused, Rhythm Monitoring alerts you to potentially shockable rhythms (provided Rhythm Monitoring is set to the default configuration, **On**). The message **Monitoring Rhythm** appears on the display to let you know this feature is active and remains on the display for the duration of the monitoring.

Figure 3-14 Monitoring Rhythm Display

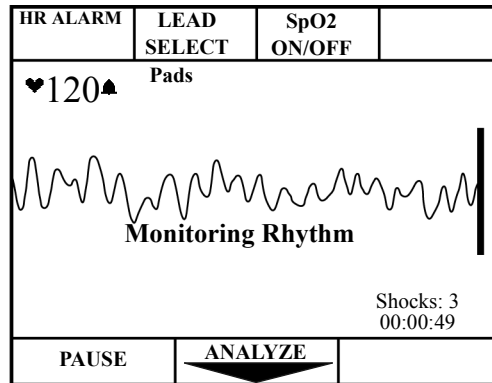

WARNING

The recommended configuration setting for Rhythm Monitoring is On. If Rhythm Monitoring is off, you are not alerted when a patient's rhythm changes from non-shockable to shockable (as in refribrillation or an initially nonshockable rhythm that deteriorates to a shockable rhythm).

If Rhythm Monitoring detects a shockable rhythm, you are prompted as follows:

Figure 3-15 Shockable Rhythm

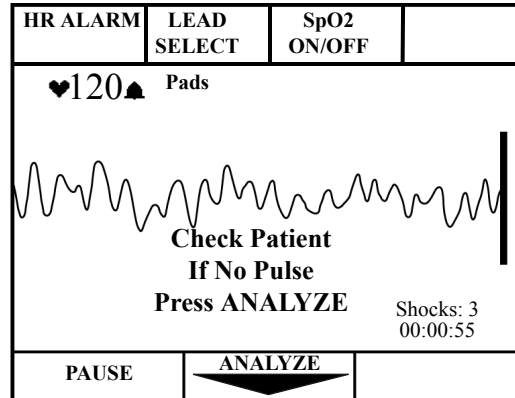

This prompt is repeated periodically, as configured, until **ANALYZE** or **PAUSE** is pressed. If you press **ANALYZE**, the defibrillation process starts again.

If you press **PAUSE**, rhythm monitoring is suspended for the duration of the pause. **PAUSE** is used when administering CPR, as noted earlier. It may also be useful when performing medical procedures or encountering artifact during patient transport. Active SpO₂ and heart rate alarms are suspended during the pause duration, as well.

Press **RESUME** to restore Rhythm Monitoring. Active SpO₂ and heart rate alarms are also restored.

ERC Protocol

The HeartStart XL can be configured to support the European Resuscitation Council (ERC) Guidelines for Resuscitation (2005). If **European Protocol** is configured to **On**, the defibrillation process described in this chapter is the same, with the exception of how the Pause state functions (see “Pausing for CPR” on 3-15).

As described, you can enter a Pause state:

- after a shock, or
- when no shock is advised

In both cases, the ERC protocol prompts you to press **PAUSE** and begin CPR of needed:

Figure 3-16 Check Patient Message

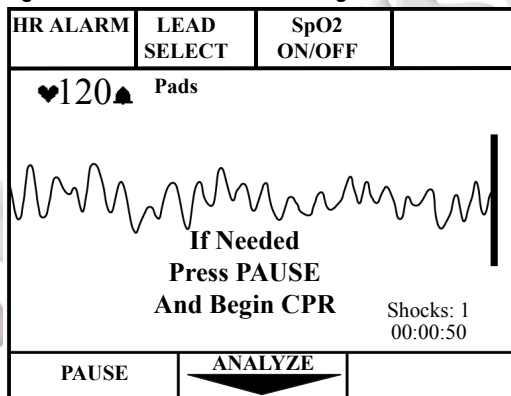

If CPR is needed, press **PAUSE**. While paused, a timer indicates the elapsed time and the total duration of the Pause state, as shown:

Figure 3-17 Display in Paused State

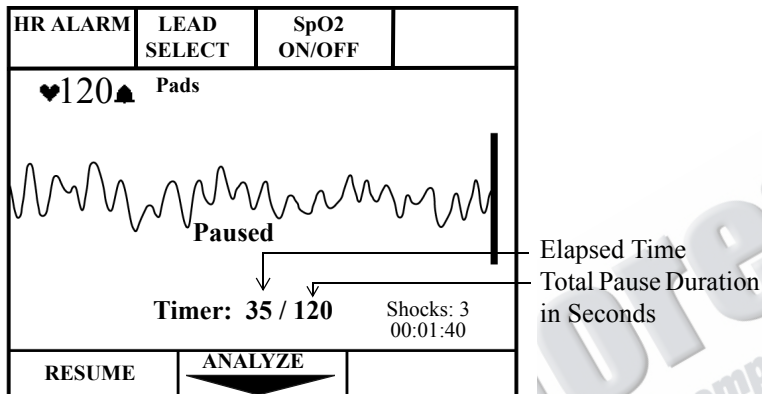

The total pause duration depends on the event preceding the Pause state. If you entered the Pause state:

- shortly after a shock is delivered, the duration is equal to the **Post Shock CPR Timer** configuration setting. The default setting is 120 seconds (60 seconds for software versions Main 19 and lower).
- when no shock was advised, the duration is equal to the **"NSA" Timer** configuration setting, where NSA is an acronym for No Shock Advised (the default setting is 180 seconds).

Troubleshooting

When the HeartStart XL detects a problem, it provides display and/or voice prompts to guide you to resolution. Table 3-1 lists the prompts you may encounter in AED Mode, the cause, and the suggested corrective action. Prompts related to the battery and Data Card are discussed in Chapter 12.

Table 3-1: Troubleshooting in AED Mode

Prompt	Possible Cause	Corrective Action
Pads Off (display) <i>or</i> Apply Pads (voice)	<ul style="list-style-type: none"> The multifunction defib electrode pads are not properly applied to the patient. 	<ul style="list-style-type: none"> Check that the pads are applied to the patient's bare chest, as directed on the pads' package. Replace the pads if the prompt continues.
Pads Cable Off (display) <i>or</i> Apply Pads (voice)	<ul style="list-style-type: none"> The pads cable is not connected to the defibrillator. 	<ul style="list-style-type: none"> Check that the defibrillation pads connector is locked in place.
Artifact Detected/ Do Not Touch Patient	<ul style="list-style-type: none"> Patient motion interferes with analysis. Electrical sources are causing interference. 	<ul style="list-style-type: none"> Attempt to eliminate patient motion. Avoid analyzing while transporting or performing CPR. Move suspected devices away from the defibrillator, when possible.
Shock Canceled	<ul style="list-style-type: none"> Shock key not pressed within 30 seconds. 	<ul style="list-style-type: none"> Press within 30 seconds of prompt.

Table 3-1: Troubleshooting in AED Mode (Continued)

Prompt	Possible Cause	Corrective Action
No Shock Delivered	<ul style="list-style-type: none"> Poor skin contact; pads are not properly connected to the patient. Minimal patient movement is possible in this situation as the defibrillator attempts to deliver a shock. The shock counter will remain at zero. 	<ul style="list-style-type: none"> Check pads connection.
Key Inactive	<ul style="list-style-type: none"> The key pressed only functions in Manual Mode. The key pressed does not function during analysis or charging. The key pressed does not function while in a pause state. 	<ul style="list-style-type: none"> Turn the Energy Select knob to Manual on prior to pressing the key. Wait for analysis or charging to complete prior to pressing the key. Press RESUME prior to pressing the key.

AED SuperSaver[®]
an ALLIED HEALTH COMPANY

4 Monitoring the ECG

This chapter provides information about:

- applying monitoring electrodes,
- selecting the correct lead,
- setting and disabling the heart rate (HR) alarm, and
- adjusting the ECG size.

For information on how to apply multifunction defib electrode pads, follow the directions on the pads packaging.

NOTE

For information on storing, and retrieving, and printing patient information acquired while monitoring, see Chapter 9.

Overview

The HeartStart XL can be used for short or long-term ECG monitoring. The ECG monitoring function allows you to monitor through:

- multifunction defib electrode pads, or
- 3- or 5-lead ECG monitoring electrodes, as configured.

When the HeartStart XL is turned on, the ECG acquired is shown on the display. ECG can be monitored through pads, 3-lead (I, II, III) or 5-lead (I, II, III, aVR, aVL, aVF or V) . Default is Lead II. ECG monitoring also displays the heart rate (HR) and allows you to set HR alarms.

ECG monitoring is always active in Manual Mode. In AED Mode, ECG monitoring is only active if **Lead Select** is configured to on (the default is on). Plug the 3 or 5-lead ECG patient cable into the connector marked ECG as shown in Figure 4-1.

A new, fully-charged battery provides approximately 100 minutes of continuous monitoring.

Connecting the ECG Patient Cable

To connect a 3- or 5-lead ECG patient cable:

1. Align the keyed patient cable connector with the slot on the ECG receptacle, as shown in Figure 4-1.
2. Push the patient cable firmly into the ECG receptacle, until the white portion is no longer visible.

Figure 4-1 ECG Patient Cable Connector/Receptacle

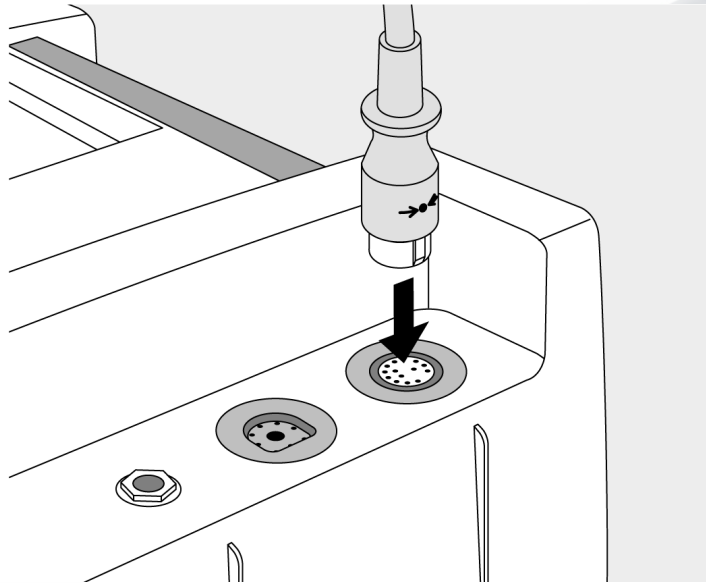

To disconnect the ECG patient cable, gently pull the white patient cable connector out of the ECG receptacle.

Applying Monitoring Electrodes

Proper application and placement of electrodes is essential for reliable monitoring. Good contact between the electrode and the skin reduces the effects of motion artifact and signal interference.

WARNING

Be sure that the electrodes do not come in contact with other conductive materials, especially when connecting or disconnecting the electrodes to or from the patient.

To apply electrodes:

1. Identify the appropriate electrode sites. (See Figure 4-2 and Figure 4-3.)
2. Shave the electrode sites or clip hair, if necessary.
3. Clean and abrade the skin at the electrode sites.
4. Dry the skin at the electrode sites.
5. Open a new package of monitoring electrodes; verify that the “Use Before” date has not passed.
6. Snap the lead wires onto the electrodes.
7. Apply the electrodes by peeling them, one at a time, from the protective backing and sticking them firmly to the patient’s skin. Press around the entire edge of each electrode to ensure that they are secure. Make sure the lead wires do not pull on the electrodes.

NOTE

If monitoring for long periods of time, new monitoring electrodes and multi-function defib electrode pads may need to be changed periodically. Refer to the manufacturer’s documentation for how often to replace the monitoring electrodes or defib pads.

Electrode Placement

Figure 4-2 shows typical electrode placement for the limb leads of a 3- or 5-lead patient cable. The V/C lead of the 5-lead cable can be placed in any of the precordial lead positions (V1/C1 through V6/C6) shown in Figure 4-3.

Figure 4-2 Limb Lead Electrode Placement

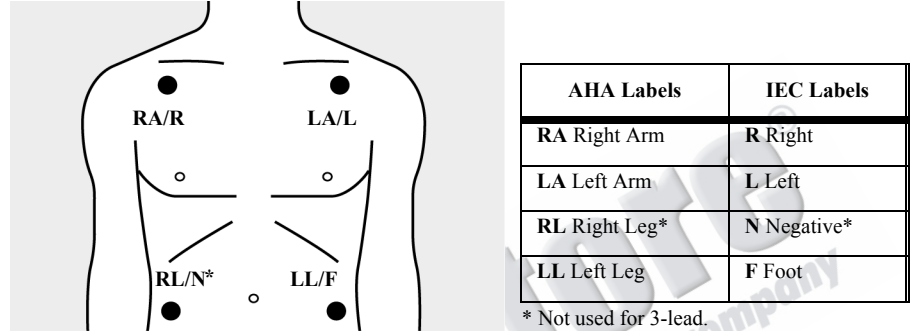
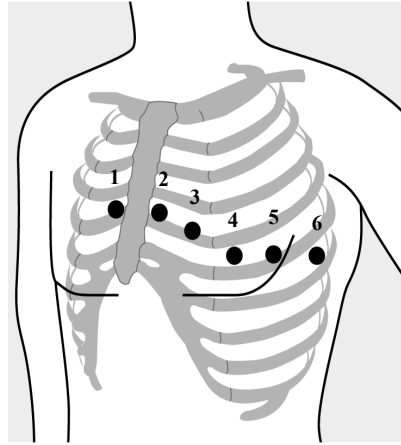

Table 4-1: 3-Lead ECG Lead Formation

Lead	+	-	Reference
I	LA	RA	LL
II	LL	RA	LA
III	LL	LA	RA

Figure 4-3 Precordial Lead Electrode Placement



Lead		Location
V1	C1	fourth intercostal space, at right sternal margin
V2	C2	fourth intercostal space, at left sternal margin
V3	C3	midway between V2/C2 and V4/C4
V4	C4	fifth intercostal space, at left midclavicular line
V5	C5	same level as V4/C4, on anterior axillary line
V6	C6	same level as V4/C4, at left mid axillary line

Table 4-2: 5-Lead ECG Lead Formation

Lead	Lead Formation
I	LA - RA
II	LL - RA
III	LL - LA
aVR	$RA - \frac{LA + LL}{2}$
aVF	$LL - \frac{RA + LA}{2}$
aVL	$LA - \frac{RA + LL}{2}$
V _x	$V/C - \frac{RA + LA + LL}{3}$

Using External ECG Monitors

An external Philips (Agilent or Hewlett-Packard branded) monitor can be connected to the HeartStart XL for the purposes of sending or receiving an ECG signal between the two devices. A sync cable is used to make this connection.

To send an ECG signal from:

An external monitor to the HeartStart XL

1. Plug one end of the sync cable into the ECG Out connector on the external monitor.
2. Plug the other end of the sync cable into the ECG Connector on the HeartStart XL.

Then, select Lead I or Lead II on the HeartStart XL to view the selected lead coming from the monitor.

The HeartStart XL to an external monitor

1. Plug one end of the sync cable into the ECG Out (Sync) connector on the HeartStart XL.
2. Plug the other end of the sync cable into the ECG In connector on the external monitor.

NOTE

The signal from the external monitor is labelled Lead I or Lead II on the HeartStart XL, even though it is not necessarily Lead I or II coming from the external monitor.

Selecting the Lead

Available monitoring leads depend upon how your device is configured.

Table 4-3: Lead Select Choices

Lead Select Choices are:	If Configured for a:
Paddles, Pads, Lead I, Lead II, Lead III	3-lead ECG cable
Paddles, Pads, Lead I, Lead II, Lead III, aVR, aVL, aVF, V lead.	5-lead ECG cable

To select a lead to monitor, cycle through the choices by pressing **LEAD SELECT** until the desired lead is displayed.

Figure 4-4 ECG Monitoring Display in AED Mode

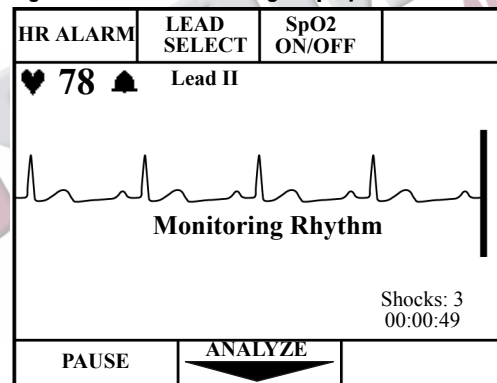

WARNING

The Power On Lead must be set to Paddles if you want to ensure that the waveform acquired from pads is displayed, and voice and text prompts are active, when entering AED Mode within 2 minutes of exiting Manual Mode. If Power On Lead is not set to Paddles, voice and text prompts are suspended and no waveform analysis occurs, until you either press **ANALYZE**, select Pads as the lead, or attach monitoring electrodes.

NOTE

When V Lead is selected, change to a different V Lead by moving the electrode to the new location rather than pressing the Lead Select softkey.

Figure 4-5 ECG Monitoring Display in Manual Mode

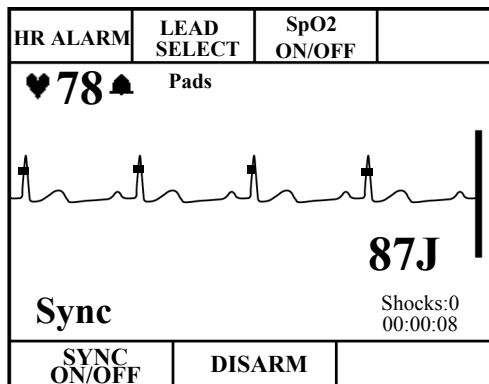

The message Leads Off is displayed in the System Message area accompanied by a beep when a lead is disconnected or the electrodes have poor patient contact. A dashed line on the display indicates that there is no ECG signal as shown in Figure 4-6.

Figure 4-6 Leads Off Display in AED Mode

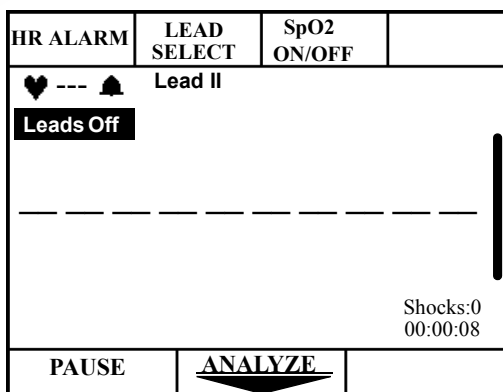

Setting the Heart Rate Alarm

The computed heart rate (the number of detected QRS complexes per minute) is displayed below the **HR ALARM** softkey, next to the . The heart rate represents the number of QRS complexes detected in a minute. If configured to on, a QRS beeper identifies each QRS complex detected.

WARNING

Heart rate displays and alarms function with internal and external pacemakers, but they can be unreliable. Observe the patient closely if pacemakers are used.

The HR alarm may be configured to alert you when the heart rate is outside the specified limits. Limit choices are listed in Table 4-4 HR Alarm Limit Choices.

Table 4-4: HR Alarm Limit Choices

Alarm If Under:	Or Over:
30	100
60	140
90	160
120	200

To set an HR alarm, cycle through the limit choices by pressing **HR ALARM** until the desired limits are shown. The  then appears next to the heart rate value to indicate that the HR alarm is set.



WARNING

Heart rate alarms are temporarily suspended in AED Mode during ECG analysis or when **PAUSE is pressed (for the duration of the paused period). Heart rate alarms are also suspended while the unit is charging for defibrillation and delivering a shock.**



Disabling the HR Alarm

If the heart rate is outside the HR alarm limits, an alarm sounds. To disable the alarm, press **HR ALARM**.  appears to indicate that the alarm is disabled.

Adjusting the ECG Size

To increase or decrease the size of the ECG, press  or  on the gain control, . Preset ECG sizes are x.25, x.5, x1.0, x2.0, and x4.0. The default setting at power on is x1.0.

Adjusting QRS Beeper and Voice Prompt Volume

To increase or decrease the volume of the QRS Beeper and voice prompts used in AED Mode, press  or  on the volume control, . The lowest volume setting will silence the QRS Beeper, however voice prompts will remain audible.

NOTE

When using the HeartStart XL during a new event, the ECG volume is set at the default volume level. However, if the unit is turned off and then back on within 2 minutes (continued use), the volume settings will remain where you left them when the unit was turned off.

Troubleshooting

Table 4-5 provides troubleshooting tips for ECG Monitoring.

Table 4-5: Troubleshooting when Monitoring the ECG

Situation	Cause	Solution
<p>Leads Off message or dashed line (-----)</p>	<ul style="list-style-type: none"> • The monitoring electrodes are not applied or are not making proper contact with the patient. • The monitoring cable is not connected. 	<ul style="list-style-type: none"> • Check that the monitoring electrodes are properly applied. • Check that the monitoring cable is properly connected.
<p>Pads Off message</p>	<ul style="list-style-type: none"> • The pads are not making proper contact with the patient. 	<ul style="list-style-type: none"> • Check that the pads are properly applied.
<p>Poor ECG signal quality</p>	<ul style="list-style-type: none"> • The monitoring electrodes are not making proper contact with the patient. • The monitoring electrodes are outdated or dried-out. • Radio frequency interference (RFI) is causing artifact. 	<ul style="list-style-type: none"> • Check that the monitoring electrodes are properly applied. If necessary, prepare the patient's skin and apply new electrodes. • Check the date code on the electrodes. Do not open the electrode package until immediately prior to use. • Relocate or turn off equipment that may be causing RFI.

Table 4-5: Troubleshooting when Monitoring the ECG (Continued)

Situation	Cause	Solution
QRS Volume	<ul style="list-style-type: none"> • No sound • Too low • Too loud 	<ul style="list-style-type: none"> • Adjust the volume. • Check configurations.
QRS beeper inaudible or beeps do not occur with each QRS complex.	<ul style="list-style-type: none"> • The QRS beeper is configured to Off. • The amplitude of the QRS complex is too small to detect. 	<ul style="list-style-type: none"> • Check that the QRS beeper is configured to On. • Adjust the volume. • Adjust the size of the ECG.

AED Superstore®
 an ALLIED 100™ company

AED Superstore[®]
an **ALLIED 100**[™] company

5 Monitoring SpO₂

This chapter provides information about:

- how pulse oximetry works
- selecting and applying the correct sensor
- monitoring SpO₂
- discontinuing SpO₂

AED Superstore[®]
an **ALLIED 100**[™] company

Introduction

Pulse oximetry is a noninvasive method of continuously measuring oxygen saturation (SpO₂) in arterial blood. The resultant SpO₂ reading indicates the percentage of hemoglobin molecules in the arterial blood which are saturated with oxygen. SpO₂ monitoring is one of the tools available to assist in assessing a patient's cardiac and respiratory systems. This chapter explains how pulse oximetry works and describes how to use the HeartStart XL to monitor SpO₂.

SpO₂ monitoring is always available both in AED and Manual Mode (if the option is purchased).

For information on printing, storing, and retrieving patient information acquired while monitoring, see Chapter 9.

WARNING

Do not rely solely on SpO₂ readings; assess the patient at all times. SpO₂ readings may be inaccurate in the presence of significant levels of carboxyhemoglobin or methemoglobin, in patients with restricted blood flow to the extremities (such as those in severe shock or hypothermia), or in the presence of excessive motion.

Understanding Pulse Oximetry

A pulse oximetry sensor sends light through patient tissue to a receiver on the other side of the sensor. As Figure 5-1 shows, light emitting diodes transmit red and infrared light through peripheral areas of the body, such as a finger.

Figure 5-1 Pulse Oximetry Sensor

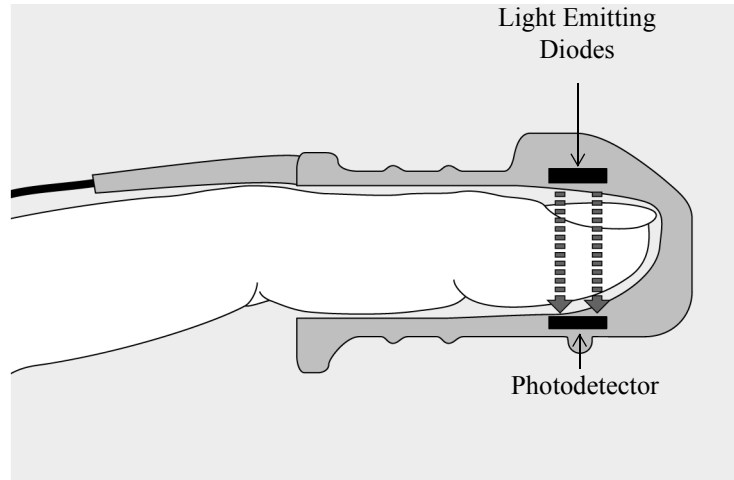

A photodetector positioned opposite the light emitting diodes compares light absorption before and after pulsation. The amount of light getting through reflects the blood flow in the arterioles. This measurement of light absorption during pulsation is translated into an oxygen saturation percentage and an SpO₂ value is displayed.

For accurate SpO₂ measurements, the following conditions must apply:

- The patient must have perfusion in that extremity.
- The light emitter and the photodetector must be directly opposite each other.
- All of the light from the emitter must pass through the patient's tissue.
- The sensor site should be free of vibration and excessive motion.
- Power cables should be kept away from the sensor cable and connector.

Selecting a Sensor

Table 5-1 shows the SpO₂ sensors that may be used with the HeartStart XL.

Table 5-1: Approved Sensors

Sensor	Type	Patient	Patient Size	Ideal Site
M1191A	Reusable	Adult	> 50 kg	Finger
M1192A	Reusable	Small adult Pediatric	15-50 kg	Finger
M1194A	Reusable	Pediatric Adult	> 40 kg	Fleshy part of ear
M1903B (Nellcor D-20)	Disposable	Pediatric	10-50 kg	Toe/Finger
M1904B (Nellcor D-25)	Disposable	Adult	>30 kg	Toe/Finger
M1131A	Disposable	Pediatric Adult	> 20 kg	Finger

NOTE

To use Nellcor sensors, you must connect the M1943A Nellcor Adaptor patient cable to the HeartStart XL. (See “Connecting the SpO₂ Patient Cable” on page 10-5.)

NOTE

A 2-meter SpO₂ extension cable (M1941A) is available for use with the HeartStart XL.

The most important factor when selecting a sensor is the position of the light emitting diodes in relation to the photodetector; when a sensor is applied, the diodes and the photodetector must be opposite each other. Sensors are designed for patients within a specific weight range and for specific sites. Be sure to:

- Select a sensor appropriate for the patient's weight.
- Select a sensor site with adequate perfusion.
- Avoid application to sites with edematous tissue.
- Do not use disposable sensors on patients who have allergic reactions to adhesives.

Reusable Sensors

Reusable sensors may be reused on different patients after they have been cleaned and disinfected (see the manufacturer's instructions supplied with the sensor).

Disposable Sensors

Disposable sensors should be used only once and then discarded. They can be relocated to a different application site on the patient if the first location does not give the desired results. Disposable sensors must not be reused on different patients.

Applying the Sensor

Follow the manufacturer's directions for applying and using the sensor, making sure to observe any warnings or cautions. For the best results:

- Make sure the sensor is dry.
- If the patient is moving, secure the sensor cable loosely to the patient.
- Avoid excessive pressure at the sensor site; ensure that circulation is not obstructed.
- Keep power cables away from the sensor cable and connection.
- Avoid placing the sensor in an environment with bright lights (if necessary, cover the sensor with opaque material).
- Avoid placing the sensor on any extremity with an arterial catheter, blood pressure cuff, or intravascular venous infusion line.

WARNING

Failure to apply the sensor properly may reduce the accuracy of the SpO₂ measurement.

WARNING

Inspect the sensor application site at least every two hours for changes in skin quality, correct optical alignment, and proper sensor application. If skin quality is compromised, change the sensor site. Change the application site at least every four hours. More frequent checking may be required due to an individual patient's condition.

Connecting the Sensor Cable

To connect a sensor cable:

1. Hold the connector with the flat side up so that the part number is visible.
2. Insert the connector into the receptacle and push until the blue portion of the connector is no longer visible.

Figure 5-2 Connecting the Sensor Cable

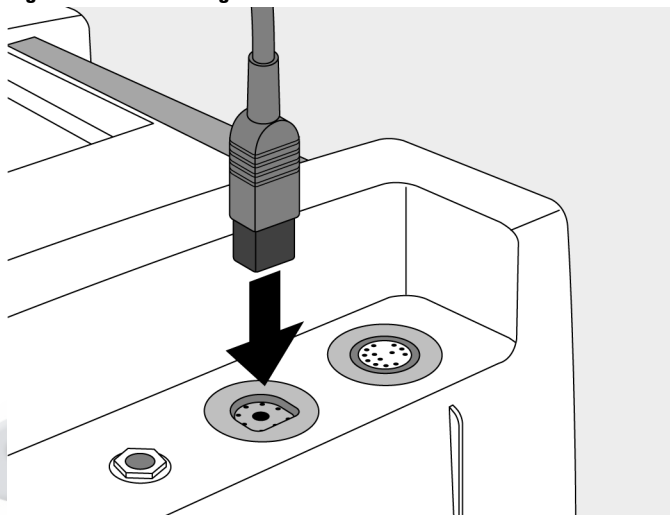

Monitoring

To monitor SpO₂:

1. If the HeartStart XL is not on, turn the Energy Select knob to AED On or Manual On.
2. Apply the appropriate sensor to the patient.
3. Make sure the sensor cable is connected to the HeartStart XL.
4. Press **SpO₂ ON/OFF** to turn on SpO₂ monitoring.

A dashed line (---) is displayed under **SpO₂ ALARM**, while the oxygen saturation is measured and an SpO₂ value is calculated. In a few seconds the SpO₂ value is displayed in place of the dashed line. As the patient's oxygen saturation changes, the SpO₂ value is updated continuously.

Figure 5-3 SpO₂ Monitoring Display in AED Mode

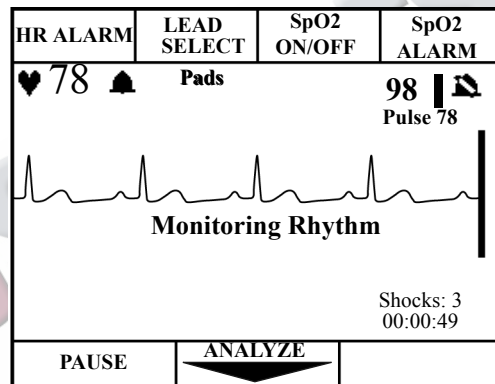



To the right of the SpO₂ value, a pleth bar and SpO₂ alarm indicator are displayed. The pleth bar should be observed for fluctuation. It is an indication of pulsation detected by the sensor. The pleth bar should not be used as the sole indicator of pulsation because it can be influenced by movement and artifact.

The symbol indicates no alarm is set.

Below the SpO₂ value is the pulse rate derived from the pulse oximetry.

Setting Alarms

An alarm may be set to alert you if the SpO₂ value falls below a specified lower limit. Lower limit alarm choices are  (no alarm), 90, 85, or 80. The defaulted high limit is 100 and cannot be changed. Press **SpO₂ ALARM** repeatedly to cycle through the choices. Stop when the desired choice is displayed. A  appears in three seconds, indicating that the selected alarm is active. To review the alarm limit, press **SpO₂ ALARM**.

WARNING

SpO₂ alarms are temporarily suspended in AED Mode during ECG analysis or when **PAUSE is pressed (for the duration of the paused period). SpO₂ alarms are also suspended while the unit is charging for defibrillation and delivering a shock.**

Responding to an Alarm

When the SpO₂ value falls below the alarm limit, a continuous tone alerts you and the SpO₂ value is displayed in inverse video.

Figure 5-4 SpO₂ Alarm Triggered

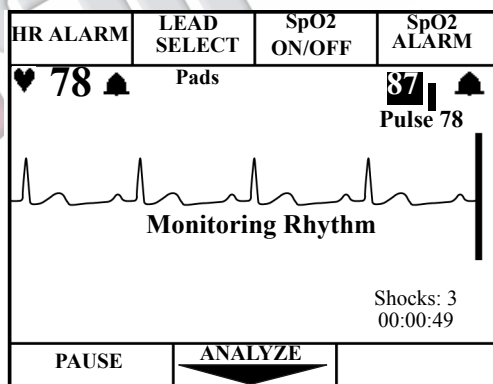

Press **SpO₂ ALARM** to turn off the alarm. Refer to “Setting Alarms” if subsequent alarms are desired.

Discontinuing SpO₂ Monitoring

To shut off SpO₂ monitoring, press **SpO₂ ON/OFF** once. The **SpO₂ ALARM** softkey and related information will disappear.

Figure 5-5 SpO₂ Monitoring Off

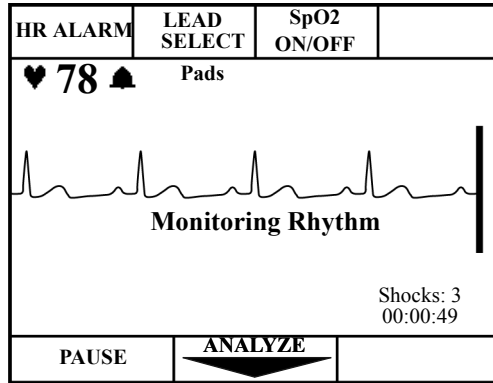

Caring for Sensors

Refer to the manufacturer's instructions for care and cleaning of sensors. To get the best results from your SpO₂ reusable sensors, always handle the sensor and cable with care and protect them from sharp objects. The sensor sleeve houses a sensitive electronic device that can be damaged. Harsh treatment of sensors will drastically reduce their lifetime.

WARNING

Do not use a damaged sensor or one with exposed electrical circuits.

Troubleshooting

Table 5-2 lists system messages that you may encounter when monitoring SpO₂.

Table 5-2: Troubleshooting when Monitoring SpO₂

Problem or Message	Possible Cause	Corrective Action
Non Pulsatile	<ul style="list-style-type: none"> Pulse absent or too weak to be detected. 	<ul style="list-style-type: none"> Check that the sensor is applied properly. Make sure the sensor site has a pulse. Relocate the sensor to a site with improved circulation. Try another sensor type. Make sure nail polish is not present.
SpO ₂ Low Signal	<ul style="list-style-type: none"> SpO₂ signal is too low to give an accurate reading. 	<ul style="list-style-type: none"> Check that the sensor is applied properly. Try another sensor type.
SpO ₂ Noisy Signal	<ul style="list-style-type: none"> Excessive patient movement, electrical interference, RF interference, or optical interference. 	<ul style="list-style-type: none"> Minimize patient motion or apply sensor to site with less movement. Secure the sensor cable loosely to the patient. Reduce sources of electrical, RFI, or optical interference.

Table 5-2: Troubleshooting when Monitoring SpO₂ (Continued)

Problem or Message	Possible Cause	Corrective Action
SpO ₂ Light Interf	<ul style="list-style-type: none"> • The level of ambient light is so high that the sensor cannot obtain an SpO₂ reading. • Sensor or cable is damaged. 	<ul style="list-style-type: none"> • Cover sensor with an opaque material. • Check sensor for damage; try another sensor.
SpO ₂ Cable Off	<ul style="list-style-type: none"> • The SpO₂ cable is not connected to the device. 	<ul style="list-style-type: none"> • Attach the cable to the HeartStart XL.
SpO ₂ Sensor Fail	<ul style="list-style-type: none"> • The transducer is broken. 	<ul style="list-style-type: none"> • Apply a new transducer.

AED Superstore

an ALLIED 100™ company

6 Defibrillating in Manual Mode

In Manual Mode you assess the ECG, decide if defibrillation is indicated, select the energy level, charge the device, and deliver the shock. The defibrillation process is under your control. There are no voice prompts. However, system and momentary messages provide relevant information throughout the process. It is important to be attentive to these messages.

This chapter describes how to defibrillate using Manual Mode. For Manual Mode features such as synchronized cardioversion and pacing, see Chapter 7: Performing Synchronized Cardioversion and Chapter 8: Pacing (Optional).

For information on storing, retrieving, and printing patient information acquired in Manual Mode, see Chapter 9: Storing, Retrieving, and Printing.

AED Superstore
an ALLIED health company

Manual Mode Display

The following figure (Figure 6-1) identifies the major elements for the Manual Mode display. Unlike the AED Mode display, Manual Mode gives you access to synchronized cardioversion and self-selected energy levels.

Figure 6-1: Manual Mode Display

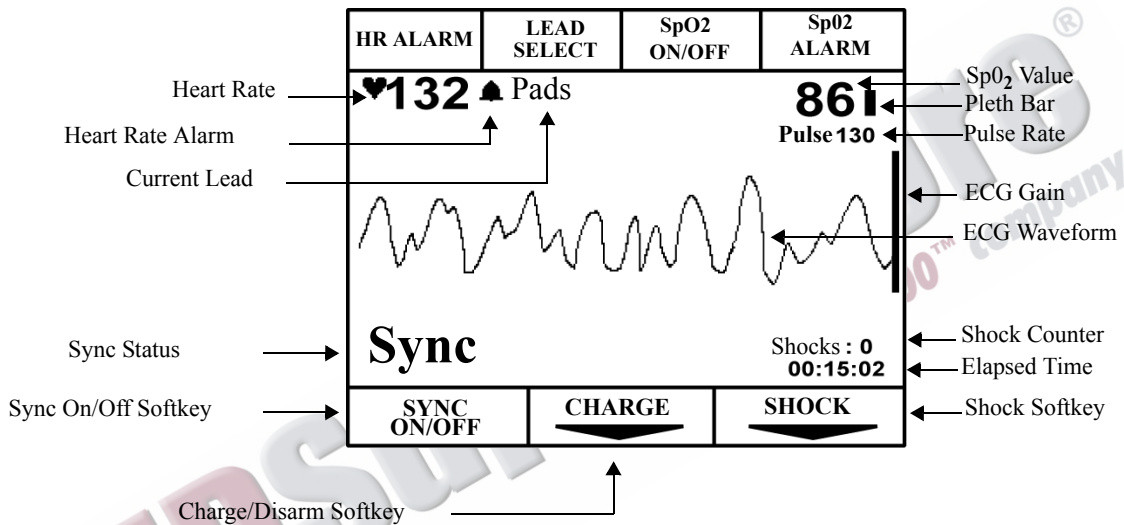

Enabling Manual Mode

To enable Manual Mode, turn the Energy Select knob to Manual On.

Defibrillating in Manual Mode

This section will explain how to prepare for and perform asynchronous defibrillation in Manual Mode using multifunction defib electrode pads, and paddles.

NOTE

In Manual Mode, defibrillation is always performed through paddles or pads. However, during defibrillation, you may choose to monitor ECG using an alternate ECG source (3- or 5-lead monitoring electrodes).

NOTE

Impedance is the resistance between the defibrillator's pads or paddles that the defibrillator must overcome to deliver an effective discharge of energy. The degree of impedance differs from patient to patient and is affected by several factors including the presence of chest hair, moisture, and lotions or powders on the skin.

The low-energy SMART Biphasic waveform is an impedance-compensating waveform that is designed to be effective across a wide range of patients. However, if you receive a "No Shock Delivered" message, check that the patient's skin has been washed and dried and that any chest hair has been clipped. If the message persists, change the pads and/or the pads cable.

Using External Paddles

In preparation for defibrillation in Manual Mode using external paddles, perform the following steps:

1. If needed, insert a Data Card (as described in "Using a Data Card (Optional)" on 2-14).
2. Turn the Energy Select knob to Manual On.
3. Remove paddles by simultaneously pulling them up and out of the holders.
4. Make sure the paddles are connected to the defibrillator. See "Connecting Cables to the Patient Cable Connector" on page 10-3.

5. Apply conductive matter.

NOTE

Do not apply conductive matter by rubbing paddles together. Improper usage will result in a “Paddles On” event that will be registered in the Event Summary and may damage paddles.

6. Apply paddles to patient’s chest, using the anterior-anterior placement.

NOTE

To optimize patient contact, adjust paddle pressure and placement. Once proper contact has been made, the patient contact indicator (PCI) located on the Sternum paddle will show a green LED. (See Figure 6-2).

Figure 6-2 Patient Contact Indicator on Sternum Paddle

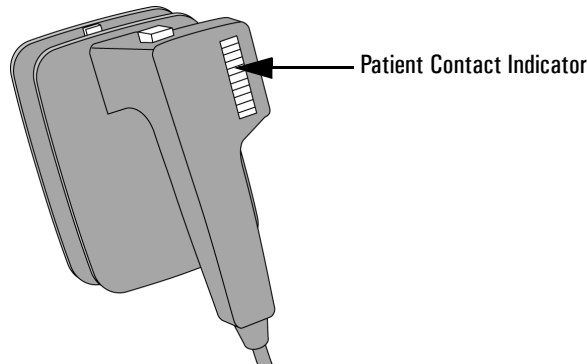

Using Pediatric Paddles

The HeartStart XL’s external paddle set comes with pediatric paddles included. To use the pediatric paddles set:

1. Depress the latch at the front of the external paddle set while pulling forward on the adult paddle electrode.
2. Store the adult paddle electrodes in the paddle tray pockets.
3. To defibrillate, see “Using External Paddles” on page 6-3.

Using Multifunction Defib Electrode Pads

In preparation for defibrillation in Manual Mode using pads, perform the following steps:

1. If needed, insert a Data Card (as described in “Using a Data Card (Optional)” on page 2-14).
2. Turn the Energy Select knob to Manual On.
3. If you are using multifunction electrode pads, apply as directed on the package. Use either the anterior-anterior or anterior-posterior electrode placement, as appropriate.
4. Connect the pads to the pads patient cable, as shown in Figure 6-3.

Figure 6-3 Connecting Pads to the Patient Cable

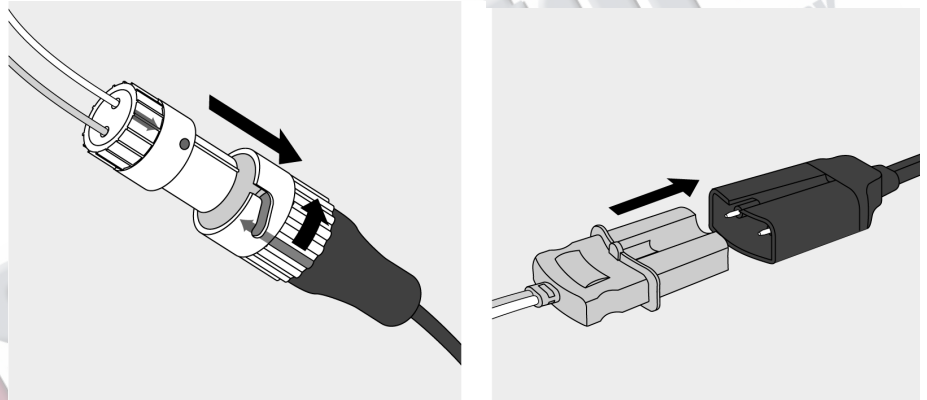

5. Connect the patient cable to the patient cable connector on the defibrillator, as follows:
 - a. Align the white pointer on the cable with the white arrow on the defibrillator's patient cable connector, as shown in Figure 6-4.
 - b. Insert the cable into the patient cable connector. Push until you hear it click in place.

Using Switched Internal Paddles

In preparation for defibrillation in Manual Mode using switched internal paddles, perform the following steps:

1. If needed, insert a Data Card (as described in “Using a Data Card (Optional)” on page 2-14).
2. Turn the Energy Select knob to Manual On.
3. Align the white pointer on the patient cable with the white arrow on the defibrillator’s patient cable connector, as shown in Figure 6-4.
4. Insert the cable into the patient cable connector. Push until you hear it click in place.

Figure 6-4 Attaching the paddles cable to the Patient Cable Connector

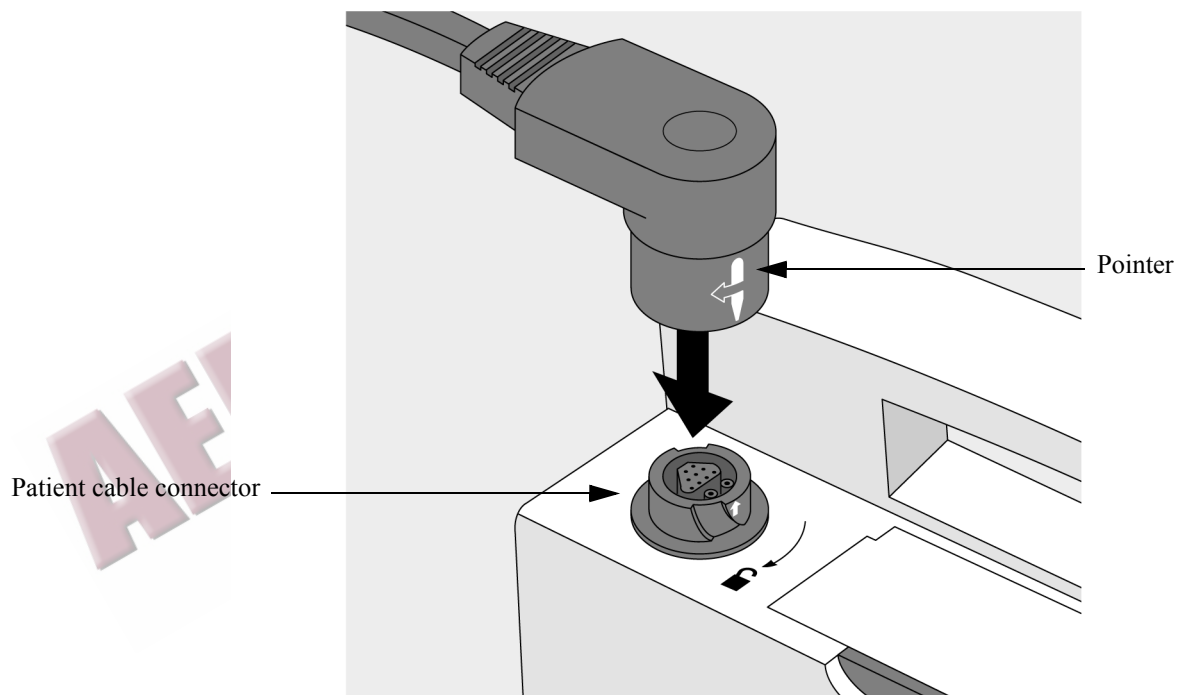

WARNING

Clinicians must select an appropriate energy level for pediatric patients.

WARNING

The HeartStart XL has a built-in limitation of 50 Joules when using internal paddles.

AED Superstore[®]
an **ALLIED 100[™]** company

Using Switchless Internal Paddles

In preparation for defibrillation in Manual Mode using switchless internal paddles, perform the following steps:

1. If needed, insert a Data Card (as described in “Using a Data Card (Optional)” on page 2-14).
2. Turn the Energy Select knob to Manual On.
3. Connect the paddles to the paddle adapter cable.
4. Connect the paddle adapter cable to the patient cable connector on the defibrillator, as follows:
 - a. Align the white pointer on the cable with the white arrow on the defibrillator’s patient cable connector, as shown in Figure 6-4.
 - b. Insert the cable into the patient cable connector. Push until you hear it click in place.

WARNING

Clinicians must select an appropriate energy level for pediatric patients.

WARNING

The HeartStart XL has a built-in limitation of 50 Joules when using internal paddles.

Defibrillation Procedure

Once you have prepared to defibrillate in Manual Mode, perform the following steps.

1. Select Energy

To select the energy setting, move the Energy Select knob to the desired energy level as shown in Figure 6-5. Energy choices range from 2 to 200 joules, with the suggested level for adults being 150 joules.

Figure 6-5 Energy Select Knob

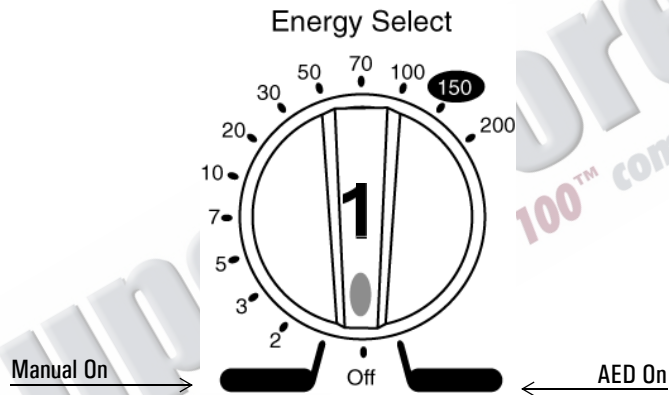

2. Charge

Press **CHARGE** or charge button on paddles.

As the defibrillator charges, the current charge is displayed above the shock counter (if configured on) as shown in Figure 6-6. A charging tone beeps until the desired energy level is reached, at which point you'll hear a continuous charge tone.

Figure 6-6 Charging Display

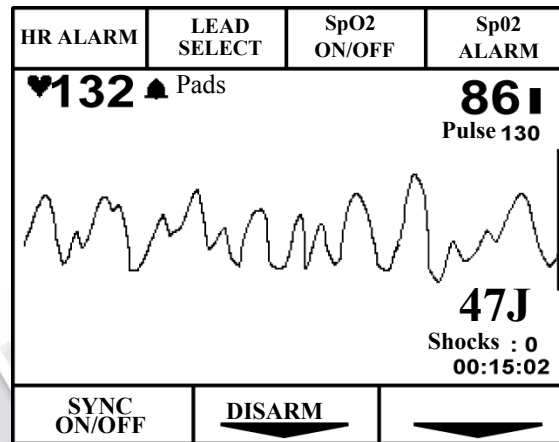

You may increase or decrease the selected energy level after pressing the **CHARGE** button. Simply move the Energy Select knob to desired energy level as before.

The defibrillator charges to the selected energy level automatically.

WARNING

Wait until the current charge reaches the selected energy level before readjusting the selected energy level.

3. Shock

Confirm that a shock is still indicated and that the current charge has reached the selected energy level. Make sure no one is touching the patient or anything connected to the patient. Call out loudly and clearly "Stand Clear!"

If using pads or switchless internal paddles, press **SHOCK** to deliver a shock to the patient.

If using external paddles, simultaneously press the shock buttons located on the paddle/s to deliver the shock.

If using switched internal paddles, press the shock button located on the paddles.

Figure 6-7 Manual Mode Shock Display.

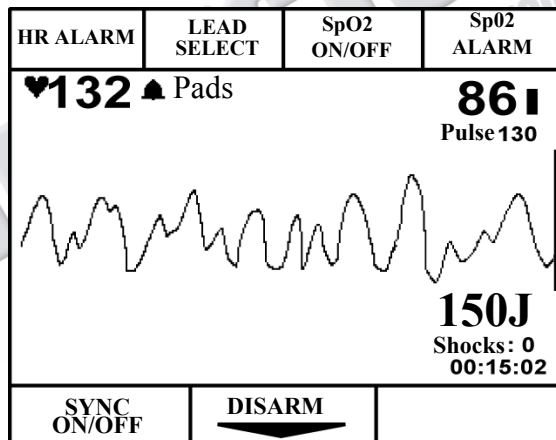

To disarm the defibrillator, press **DISARM**. If **SHOCK** or the shock buttons are not pressed within 30 seconds, the defibrillator disarms automatically.

If additional shocks are indicated, repeat the defibrillation process.

WARNING

Defibrillation current can cause operator or bystander injury. Do not touch the patient, or equipment connected to the patient, during defibrillation.

Entering AED Mode

To enter AED Mode from Manual Mode, simply turn the Energy Select knob from Manual On to AED On.

ECG and/or SpO₂ monitoring are defaulted enabled in AED Mode. If these settings are still active, the alarms set in Manual Mode remain active when you switch to AED Mode.

AED Superstore[®]
an **ALLIED 100**[™] company

7 Performing Synchronized Cardioversion

This chapter describes how to perform synchronized cardioversion with the HeartStart XL.

Synchronized cardioversion is a Manual Mode function that allows you to synchronize the defibrillator shock with the R-wave of the ECG being monitored.

To perform synchronized cardioversion, you must select a means of monitoring ECG, and a means of delivering the synchronized shock.

The HeartStart XL provides three ways to monitor ECG: using defib electrode pads, monitoring electrodes, or the external paddles

The synchronized shock is delivered through the multifunction defib electrode pads, or through the external paddles.

NOTE

See Chapter 4, “Monitoring the ECG” for information on how to apply electrodes and select a lead.

Monitoring the ECG

The HeartStart XL provides three ways to monitor ECG for synchronized cardioversion:

- multifunction defib electrode pads, through the patient cable
- monitoring electrodes, through a 3- or 5-lead ECG cable and leads, or
- external paddles.

In addition, you may monitor ECGs using an external Philips (Agilent or Hewlett-Packard branded) ECG monitor.

When selecting an ECG lead, choose the lead that provides the clearest signal and the largest QRS complex.

Using Multifunction Defib Electrode Pads

To monitor ECG for cardioversion using multifunction defib electrode pads, perform the following steps:

1. If needed, insert a Data Card (as described in “Using a Data Card (Optional)” on 2-14).
2. Turn Energy Select knob to Manual On.
3. Apply multifunction defib electrode pads to the patient as directed on the package. Use either the anterior-anterior or anterior-posterior placement, as appropriate.
4. Connect the pads to the patient cable. (See Figure 6-3.)
5. Use **LEAD SELECT** to select Pads. (See “Selecting the Lead” on page 4-8.)

Using 3 or 5-wire ECG Leads

To monitor ECG for cardioversion using monitoring electrodes and 3 or 5-wire ECG leads, perform the following steps:

1. If needed, insert a Data Card (as described in “Using a Data Card (Optional)” on 2-14).
2. Apply monitoring electrodes. (See “Applying Monitoring Electrodes” on page 4-4.)
3. Turn Energy Select knob to Manual On.
4. Connect the ECG cable to the HeartStart XL. (See Figure 4-1.)
5. Use **LEAD SELECT** to select the best lead that displays a large QRS complex. (See “Selecting the Lead” on page 4-8.)

AED Superstore[®]
an ALLIED 100[™] company

Using External Paddles

To monitor ECG for cardioversion using the external paddles, perform the following steps.

1. If needed, insert a Data Card (as described in “Using a Data Card (Optional)” on 2-14).
2. Turn the Energy Select knob to Manual On.
3. Use **LEAD SELECT** to select **Paddles**. (See “Selecting the Lead” on page 4-8.)
4. Remove paddles from pockets by simultaneously pulling out and up.
5. Apply conductive material to paddles.

NOTE

Do not apply conductive matter by rubbing paddles together. Improper usage will result in a "Paddles On" event that will be registered in the Event Summary and may cause paddle damage.

6. Apply paddles to patient’s bare skin.

WARNING

Artifact introduced by paddle movement may resemble an R-wave and trigger a defibrillation shock. When performing synchronized cardioversion, pads or ECG electrodes are recommended for ECG monitoring.

Using External ECG Monitors

An external Philips (Agilent or Hewlett-Packard branded) monitor can be connected to the HeartStart XL for the purposes of sending or receiving an ECG signal between the two devices. A sync cable is used to make this connection. One end of the sync cable plugs into the ECG Output connector on the bedside monitor and the other end plugs into the ECG Connector on the HeartStart XL. This cable connects the ECG signal from the monitor into the HeartStart XL, where the signal is displayed and synchronization occurs.

NOTE

The signal from the external monitor is labelled Lead I or Lead II on the HeartStart XL, even though it is not necessarily Lead I or II coming from the external monitor.

To use an external monitor with the HeartStart XL, perform the following steps:

1. If needed, insert a Data Card (as described in “Using a Data Card (Optional)” on 2-14).
2. Turn Energy Select knob to Manual On.
3. Use **LEAD SELECT** to select Lead I or Lead II on the HeartStart XL. (See “Selecting the Lead” on page 4-8.)
4. Plug the cable into the ECG Output jack of the external monitor.
5. Plug the other end of the cable into the ECG Connector on the HeartStart XL. (See Figure 2-2.)

WARNING

Whenever possible, we recommend that you perform synchronized cardioversion procedures while directly monitoring the patient through the defibrillator’s electrodes or lead inputs.

If you use an external monitor as the ECG source, the biomedical technician must verify that the external monitor and the HeartStart XL combination will deliver a synchronized shock within 60 ms of the peak of the R-wave. Use a 1 mV QRS complex with a QRS width of 40 ms. This performance cannot be guaranteed with all commercially available monitors.

Delivering a Synchronized Shock

Once ECG monitoring is connected and operating properly, perform the following steps:



1. Press  (located below the display) to enable Sync Mode. The message **SYNC** appears on the display.
2. Use the gain control, , to adjust the ECG size so that the marker dot appears only once with each R-wave.
3. Select the desired energy level.
4. Press **CHARGE** or the yellow charge button located on the Apex paddle. Wait until the current charge has reached the energy level selected and you hear a continuous charge done tone.

Figure 7-1: Charging in Sync Mode



If desired, you may increase or decrease the selected energy level after pressing **CHARGE** by moving the Energy Select knob until the desired energy level is displayed. The defibrillator charges to the modified energy level automatically. Wait until the current charge reaches the selected energy level before proceeding.

5. Make sure no one is touching the patient or anything connected to the patient. Call out clearly and loudly “Stand Clear!”.
6. Press and hold **SHOCK** . If you are using external paddles, press and hold the orange buttons on both paddles. The shock will be delivered when the next R-wave is detected.

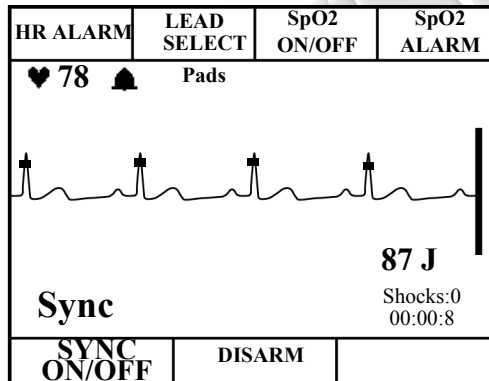
NOTE

It is important to continue to hold **SHOCK** (or the paddle buttons) until the shock is delivered. The defibrillator shocks with the next detected R-wave.

WARNING

Defibrillation current can cause operator or bystander injury. Do not touch the patient, or equipment connected to the patient, during defibrillation.

Delivering Additional Synchronized Shocks

If additional synchronized shocks are indicated, perform the following steps:

1. Make sure Sync Mode is still enabled, as indicated by the message **Sync** on the display.
2. Repeat steps 2-6 under “Delivering a Synchronized Shock” .

In its default configuration, the HeartStart XL remains in Sync Mode after a shock is delivered. The HeartStart XL can also be configured to exit Sync Mode after each shock is delivered.

Disabling Sync Mode

To disable Sync Mode, press  located below the display. The message **Sync** is no longer displayed.

Sync Mode is also disabled when you exit Manual Mode.

8 Pacing (Optional)

Noninvasive transcutaneous pacing is a Manual Mode function that is used to deliver paced pulses to the heart. Paced pulses are delivered through multi-function defib electrode pads that are applied to the patient's bare chest.

This chapter explains the pacing option available with the HeartStart XL and describes how to perform pacing.

Pacing Operational Controls

In Manual Mode, the following pacing operational controls are displayed on the handle of the HeartStart XL.

Figure 8-1 Pacing Controls (Manual Mode only)

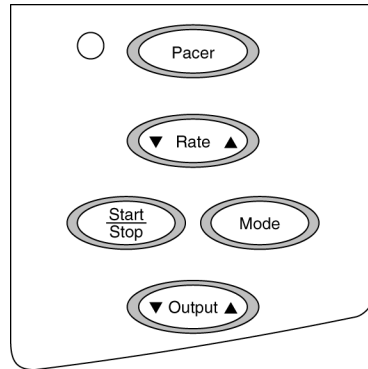

Demand Mode Versus Fixed Mode

The HeartStart XL can deliver paced pulses in either demand or fixed mode.

In **demand mode**, the pacer only delivers paced pulses when the patient's heart rate is lower than the selected pacing rate.

In **fixed mode**, the pacer delivers paced pulses at the selected rate.

Monitoring During Pacing

Multifunction defib electrodes pads cannot be used to monitor the ECG and deliver paced pulses simultaneously. The HeartStart XL always uses the 3- or 5-lead ECG cable and monitoring electrodes as the source of ECG during pacing.

In **demand mode**, ECG electrodes must be used, because the HeartStart XL uses the R-wave detection from this monitoring source to determine if a paced pulse should be delivered.

In **fixed mode**, ECG electrodes may or may not be used; however, an ECG will only be displayed if ECG monitoring electrodes are used.

WARNING

Use demand mode pacing whenever possible. Use fixed mode pacing when motion artifact or other ECG noise makes R-wave detection unreliable.

WARNING

Heart rate displays and alarms function during pacing, but they can be unreliable. Observe the patient closely while pacing. Do not rely on heart rate alarms or the indicated heart rate as a measure of the patient's perfusion status.

WARNING

When pacing in demand mode, the ECG cable must be directly connected from the patient to the HeartStart XL.

Preparing for Pacing

To prepare for pacing, perform the following steps.

1. Apply multifunction defib electrode pads as directed on the package. Use either the anterior-anterior or anterior-posterior placement, as appropriate.
2. Connect the pads to the patient cable. (See Figure 6-3.)
3. If needed, insert a Data Card (as described in “Using a Data Card (Optional)” on 2-14).
4. Turn the Energy Select knob to Manual On.

In addition, for demand mode pacing:

1. Apply monitoring electrodes. (See “Applying Monitoring Electrodes” on page 4-4.)
2. Use **LEAD SELECT** to select the best lead with an easily detectable R-wave (See “Selecting the Lead” on page 4-8.) If you do not select a lead (i.e. pads is the selected ECG source), Lead I is automatically selected when the pacing function is turned on.

NOTE

If pacing for long periods of time, you may need to periodically apply new monitoring electrodes and multifunction defib electrode pads. Refer to the manufacturer’s documentation for how often to replace the monitoring electrodes or defib pads.

Performing Pacing

To use pacing, perform the following steps.

1. Press **Pacer**. The green LED next to **Pacer** lights up and a dialogue box appears on the display.

Figure 8-2: Pacing with ECG Monitoring Electrodes Display

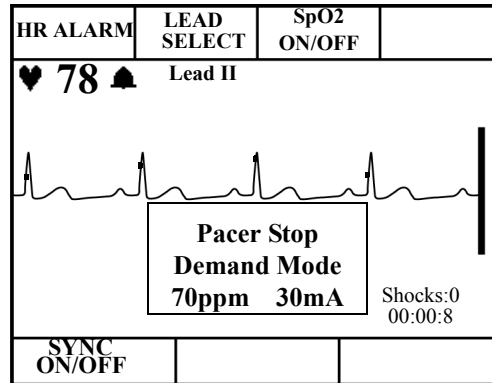

The **Pacer Stop** message indicates that the pacing function is on but paced pulses are not being delivered. The pacer turns on in the mode last used.

2. Verify that the dot markers appear near the middle of the QRS complexes of the ECG.

If the dot markers do not appear, or are in the wrong location, adjust the ECG size or select another lead. (See “Monitoring the ECG” in Chapter 4.)

3. Adjust the rate to the desired number of paced pulses per minute (ppm).

Press up (▲) or down (▼), on **Rate** to increase or decrease the number of paced pulses per minute.

- To start pacing, press **Start/Stop**.





The message **Pacing** indicates that paced pulses are being delivered in the selected mode at the rate and output level displayed.

If fixed pacing is desired or R-wave detection is unreliable, press **Mode** to change to fixed mode.

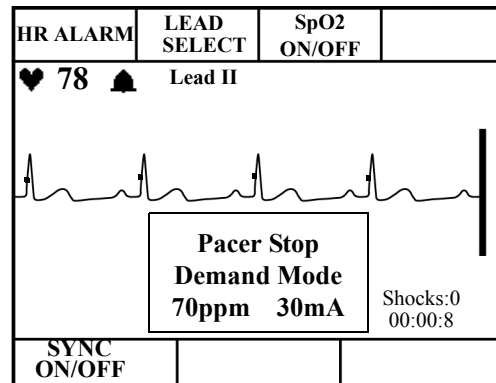
To switch back to demand mode, press **Mode** again.

Figure 8-3: Pacing with Pads Display



5. Increase the output until cardiac capture occurs.
Press ▲ on  to increase the output in increments of 10 mA.
6. Decrease the output to the lowest level that still maintains capture.
Press ▼ on  to decrease the output in increments of 5 mA.
7. Press  to stop pacing.
8. Press  to exit the pacing function. The green LED next to the button goes out, indicating pacing is no longer active.

NOTE

Pacing will not start if there is a problem with the multifunction defib electrode pads connections. If in demand mode, pacing will not start if there is a problem with the ECG monitoring electrodes connections. In either case, if a problem occurs a system message is displayed.

NOTE



The pacing window remains on as long as the pacing function is enabled.

CAUTION

If you are using the pacing function with battery power and the **Low Battery** message appears, plug the device into AC power. When the device powers back up, pacing **is no longer** activated. Press  to re-activate the pacing function.

Changing Pacing Modes

If paced pulses are being delivered, you must stop pacing before changing the pacing mode. For example:

1. Press  to stop pacing.
2. Press  to change the Mode.
3. Adjust the rate, if needed.
4. Press  to resume pacing.
5. Adjust the output, as needed to obtain capture.

Defibrillating During Pacing

If the patient must be defibrillated during pacing, follow the procedure for defibrillating in Manual Mode on page 6-1.



Pacing is automatically turned off when you charge the defibrillator and the pacing dialogue box is removed from the display. After a shock, pacing remains off.

To resume pacing, refer to “Performing Pacing” on page 8-5. When you resume, settings selected prior to defibrillation (rate, mode, and output) remain the same.

Troubleshooting

Table 8-1 lists the pacing-related system and momentary messages that you may encounter when using the pacing function.

Table 8-1: Pacing System Messages

Message	Possible Cause	Corrective Action
Leads Off	<ul style="list-style-type: none"> The selected monitoring lead is not making proper contact with the patient. Pacing was attempted in demand mode without monitoring electrodes attached. 	<ul style="list-style-type: none"> Check that the monitoring electrodes are properly applied. Check that the monitoring cable and electrodes are properly connected.
Pacer Failure	The pacing system is not functioning.	Remove the device from active use and call for service.
Pacer Output Low	High patient impedance results in delivering less current to the patient than specified in the output current setting.	Check that the pads are applied properly.
Stop Pacer	 is pressed while paced pulses are being delivered.	Stop pacing before changing the pacing mode.
Key Inactive	 , or one of the other pacing function keys, is pressed when Manual Mode is not active.	Make sure Manual Mode is active before pressing  or one of the other pacing function keys.

AED Superstore[®]
an **ALLIED 100**[™] company

9 Storing, Retrieving & Printing

This chapter describes how the HeartStart XL creates an Event Summary, or patient record, for later retrieval and printing. Marking events for storage in the Event Summary and printing individual events as they occur are also discussed.

AED Superstore®
an **ALLIED 100™** company

Overview

The HeartStart XL automatically creates an Event Summary for each patient. The Event Summary is stored in both internal memory and on a Data Card (if one is used).

The HeartStart XL's internal Event Summary stores:

- up to 300 events (pieces of critical information), and
- 50 ECG strips (at 11 seconds each).

Events include things such as charging, shocks, and alarm violations. You also trigger an event each time you press **Mark** or **Strip**.

Storage on a Data Card is limited only by available space on the card. In addition to storing all of the events that occur, a continuous copy of the displayed ECG and Patient Contact Impedance are stored.

You can print the internal Event Summary at any time. You can also configure your HeartStart XL to print individual events automatically as they occur.

Finally, you can activate printing of individual events and patient information at any time by pressing **Summary**.

To print an Event Summary stored on the Data Card, the information must first be downloaded to the HeartStart Event Review Data Management system. Refer to the *HeartStart Event Review Instructions for Use* for download instructions.

Marking Events

The **Mark** button allows you to annotate the ECG strip at the point in time the button is pressed. In AED Mode, when monitoring is disabled, the event is marked with a ▲. In Manual Mode, or when monitoring is enabled in AED Mode, you can use the softkeys to select the annotation from the choices displayed (See Figure 9-1)*. If no selection is made, the event is marked with just a ▲.

Figure 9-1 Annotations

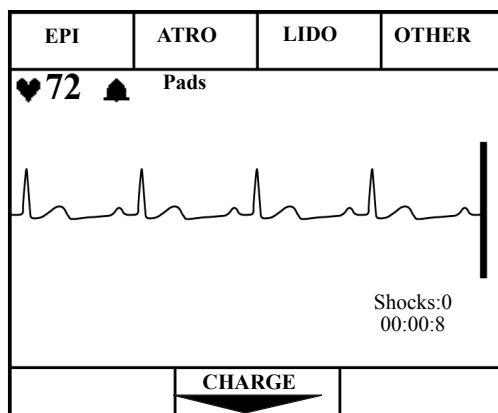

NOTE

* In Australia and the U.K., EPI is replaced by **ADRN** (adrenaline).

The marked event is stored in the Event Summary. If the printer is configured to **Print on Mark**, an ECG strip prints when **Mark** is pressed. If the printer is configured to **6 second delay**, the strip is 9 seconds and includes 6 seconds preceding the event and 3 seconds following the event. If **No Delay** is configured, a 3 second ECG strip prints in real time. To stop printing before the entire strip is printed, press **Strip**.

Events Recorded

The following events and related information are stored in the Event Summary:

Table 9-1: Event Information

Event Types	Related Information Stored
Power Change	Power on, Power off, Continued use, Battery low.
Pads Change	Pads on, Pads off.
AED Mode Analysis	Analyzing, Analysis Stopped, Artifact Detected, Cannot Analyze, Shock Advised, No Shock Advised.
Mode Change	AED Mode or Manual Mode.
Rhythm Monitoring	Check Patient, Pause, Resume.
Charging	ECG waveform, Energy charged to.
Shock	ECG waveform, Shock#, Delivered energy, Peak current, and Patient impedance.
Shock Failed	No Shock Delivered.
Disarm	ECG waveform.
ECG Monitoring	Leads on/off.
Heart Rate Alarm Violation	Lead, Heart Rate, and Heart Rate alarm limits.

Table 9-1: Event Information (Continued)

Event Types	Related Information Stored
SpO ₂ Violation	SpO ₂ value and SpO ₂ alarm limit.
Mark	ECG waveform with annotation (▲, Epi, Atro, Lido, or Other).
Print Strip	ECG waveform.
Sync	Sync on, Sync off, Sync marker.
Pacing	Pacer start, Pacer stop, Pacer settings.

AED Superstore
an ALLIED 100™ company

Creating a Patient Record

The HeartStart XL creates an Event Summary patient record for each new patient. Each record is assigned a unique incident number. The HeartStart XL keeps the Event Summary in its internal memory until you begin caring for a new patient. It assumes the following:

Table 9-2: Power Status and Patient Records

If:	Then:
Power is off for more than 2 minutes and a new event is recorded	The HeartStart XL assumes you are caring for a new patient. The last internal Event Summary is deleted; a new Event Summary is started and a new incident record is created
Power is off less than 2 minutes	The HeartStart XL assumes you are continuing to care for the same patient. Additional events are appended to the Event Summary; the annotation "Continued Use" is printed on the Event Summary, provided it wasn't printed prior to turning the HeartStart XL off and/or patient contact was never made.

If the HeartStart XL is off for more than two minutes and turned on with no new event the data is saved.

The Continued Use feature allows you to change batteries or shut the HeartStart XL off briefly (for 2 minutes or less), while preserving the current patient record. Events recorded after the power interruption are appended to the patient record. Continued use also preserves alarm settings.

Printing the Internal Event Summary

To print the internal Event Summary, press **Summary**. To stop printing before the complete summary is printed, press **Summary** again or press **Strip**.

The Event Summary includes the following information, in the order listed:

- a header with a place for you to write in the patient’s name and the operator’s name.
- a directory list of events that occurred during the incident and the time of their occurrence.
- ECG strips of the events in the directory list, where relevant.







Figure 9-2 shows the beginning of an Event Summary.

Figure 9-2 Event Summary

Patient _____				Device On		12:41:00	
				AED Mode		12:41:00	
Operator _____				Pads On		12:41:01	
				Leads On		12:41:03	
Device On	03 Jan 00	12:41:00		Analyzing		12:41:03	
				Shock Advised		12:41:11	
Last Event	03 Jan 00	01:09:04		Shock #1		12:41:17	
				Analyzing		12:41:24	
Total Shocks	2			Shock Advised		12:41:31	
Incident:	0000045			Shock #2		12:41:38	
Serial Number	123456789			Manual Mode		12:41:42	

The Event Summary also includes waveforms and the appropriate annotation for each of the following events:

Table 9-3: Event Summary Information

Event	Waveform Information Stored
Shock Advised	11 seconds of ECG just prior to the message Shock Advised .
No Shock Advised	11 seconds of ECG just prior to the message No Shock Advised .
Cannot Analyze	11 seconds of ECG just prior to the message Cannot Analyze .
Shock Delivered	11 seconds; 3 seconds prior to the shock, plus 8 seconds after the shock.
 pressed	11 seconds; 3 seconds prior to  being pressed, plus 8 seconds after  is pressed.
 pressed	11 seconds; 3 seconds prior to  being pressed, plus 8 seconds after  is pressed.
Heart Rate or SpO ₂ Alarm	11 seconds; 3 seconds prior to the alarm, plus 8 seconds after the alarm.

Printing Events

The HeartStart XL can be configured to print automatically when certain events occur. The table below lists these events and the length of the strip printed, depending on whether the printer is configured to print real-time or with a 6-second delay.



Table 9-4: Configurations for Length of Printed Strips

Event	Real-Time Strip Length	Delayed Strip Length
Defibrillator charges	continuous	6 seconds just prior to charging, plus continuous printing throughout the charge duration.
Shock Delivered	12 seconds	6 seconds just prior to shock, plus 12 seconds after shock.
Shock Failed	6 seconds	6 seconds just prior to the message No Shock Delivered , plus 6 seconds after the message.
Defibrillator disarmed	6 seconds	6 seconds just prior to disarm, plus 6 seconds after disarm.
SpO2 or Heart Rate Alarm Violation	6 seconds	6 seconds just prior to alarm violation, plus 6 seconds after alarm violation.
 pressed	6 seconds	6 seconds just prior to marking, plus 6 seconds after button pressed.

Printing is configured independently for each of these events. You can stop the printing before it has printed the entire strip by pressing .

To print additional events that you observe in the course of caring for your patient, press .

NOTE

An ECG strip will print continuously until you press  a second time to stop printing. If the printer is configured to have a 6-second delay, the print-out contains an additional 6 seconds of the ECG that occurred just prior to pressing .

AED Superstore
an ALLIED 100™ company

10 Setting Up and Configuring the HeartStart XL

This chapter describes how to set-up and configure your HeartStart XL. Chapter 10 covers:

- Connecting Patient Cables
- Configuring the HeartStart XL

AED Superstore®
an **ALLIED 100™** company

Connecting/Disconnecting Patient Cables

This section describes how to connect and disconnect the:

- Pads cable and Paddle Cables to the Patient Cable connector
- SpO₂ Patient Cable to the SpO₂ connector
- ECG Patient Cable (3- or 5-lead) to the ECG connector

AED Superstore®
an **ALLIED 100™** company

Connecting Cables to the Patient Cable Connector

You connect the pads and internal/external paddles to the HeartStart XL using the patient cable connector on the defibrillator. An adapter cable is required for switchless paddles.

The patient cable connector on the HeartStart XL is used to connect:

- Pads patient cable for use with multifunction defib electrode pads
- External paddles
- Switchless internal paddles adapter cable
- Switched internal paddles

To connect any of these cables to the defibrillator:

1. Align the white pointer on the cable with the white arrow on the defibrillator's patient cable connector, as shown in Figure 10-1.
2. Insert the cable into the patient cable connector. Push until you hear it click in place.

Figure 10-1 Attaching Cables to the Patient Cable Connector

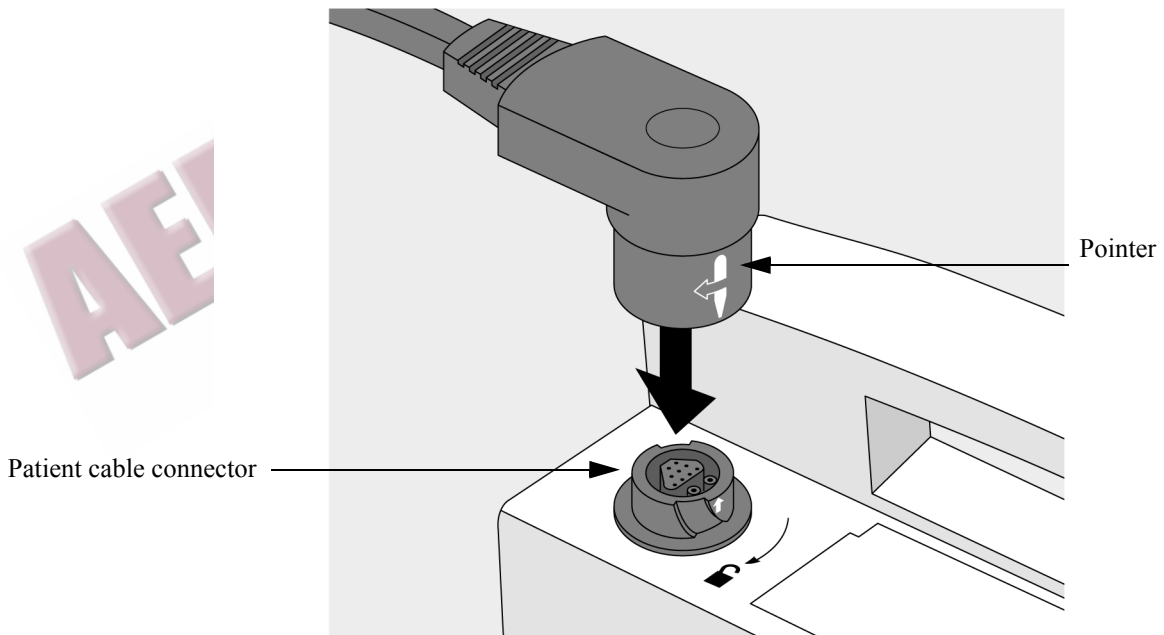

To disconnect the cable from the defibrillator:

1. Rotate the green locking mechanism on the cable in the direction (clockwise) of the blue arrow on the defibrillator, until it stops (as shown in Figure 10-2).
2. Hold the locking mechanism in this position as you pull the cable away from the defibrillator.

Figure 10-2 Disconnecting Cables from the Patient Cable Connector

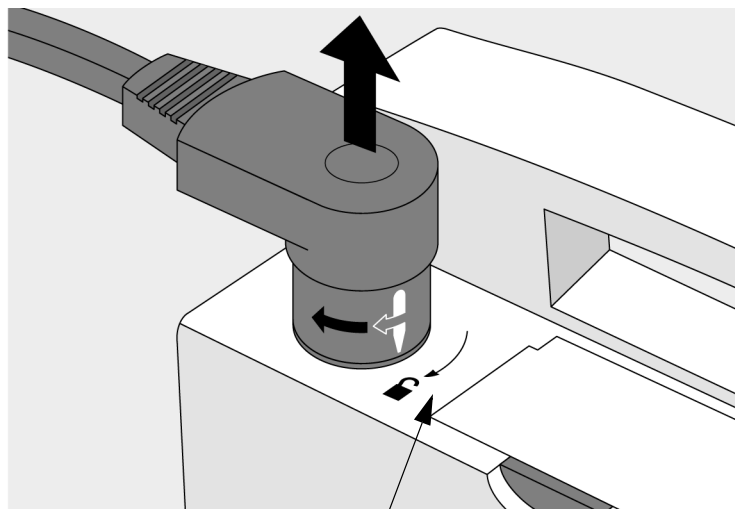

Blue arrow

AE

Connecting the SpO₂ Patient Cable

To connect the SpO₂ patient cable:

1. Hold the connector with the flat side facing away from the HeartStart XL, as shown in Figure 10-3.
2. Insert the cable into the SpO₂ connector on the HeartStart XL and push until the blue portion of the cable connector is no longer visible.

Figure 10-3 Connecting the SpO₂ Patient Cable

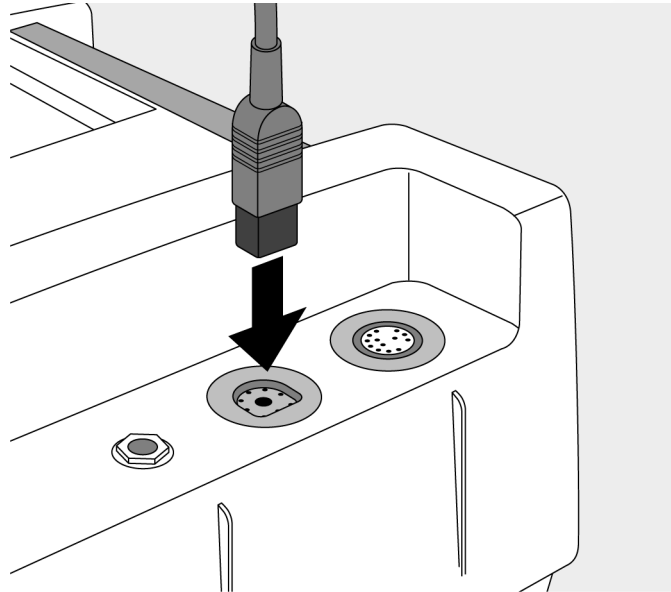

To disconnect the SpO₂ patient cable, gently pull the cable out of the SpO₂ connector.

Connecting the ECG Patient Cable

To connect a 3- or 5-lead ECG patient cable:

1. Align the keyed ECG patient cable with the ECG connector, as shown in Figure 10-4.
2. Push the ECG patient cable firmly into the ECG connector, until the white portion is no longer visible.

Figure 10-4 ECG Patient Cable Connector/Receptacle

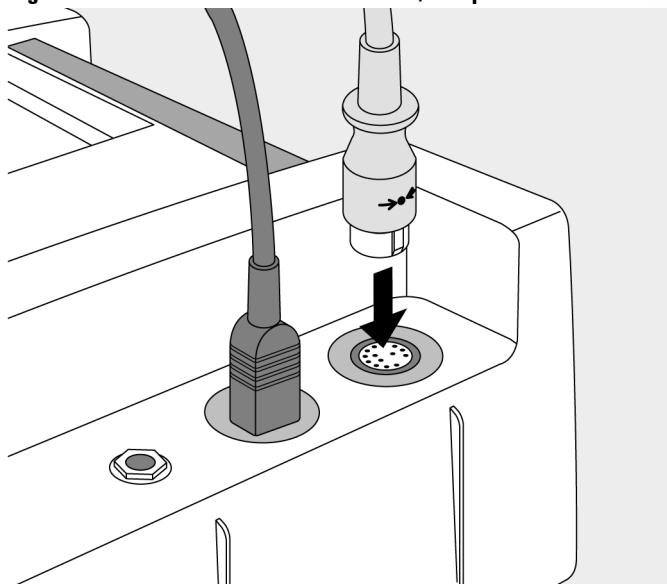

To disconnect the ECG patient cable, gently pull the cable out of the ECG connector.

Configuring the HeartStart XL

Configuration options allow you to customize the HeartStart XL to best meet your needs. This section describes:

- how to access the configuration menu
- configurable items and their setting options
- how to change the configuration
- how to save the configuration to a Data Card
- how to load the configuration from a Data Card
- how to print the configuration

Accessing the Configuration Menu

There is a special combination of softkeys that, when pressed simultaneously, turn the HeartStart XL on in Configuration Mode. For the purposes of executing this procedure, softkeys are assigned numbers as shown in Figure 10-5.

Figure 10-5 Softkey Numbers

④ ⑤ ⑥ ⑦

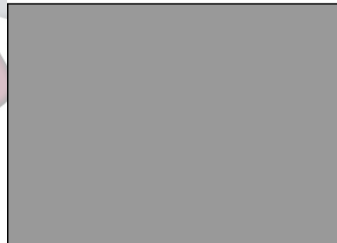

① ② ③

To turn the HeartStart XL on in Configuration Mode:

1. If the device is already on, turn the Energy Select knob to Off.
2. While holding down softkeys 4 & 5, turn the Energy Select knob to AED On.

The configuration menu appears as shown in Figure 10-6. The menu lists the categories of settings that may be configured.

Figure 10-6 Configuration Menu

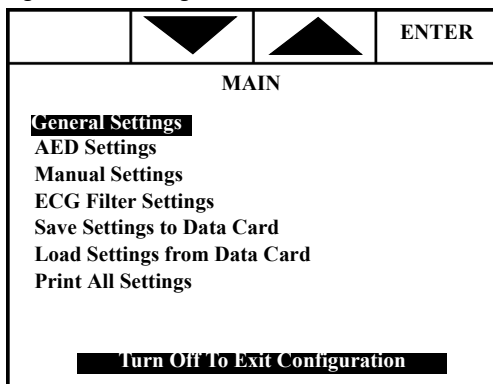

Configurable Parameters

The following tables show the configurable parameters for each category of settings. A description of each parameter is provided, along with the possible choices. Default settings are in bold.

Table 10-1: General Settings

Parameter	Description	Setting Choices
Date (dd mmm yyyy)	Current date, where dd is the day, mmm is the month, and yyyy is the year.	any valid date
Time (hh:mm)	Current time, where hh is the hour and mm is the minutes. Time is based on a 24 hour clock.	any valid time

Table 10-1: General Settings (Continued)

Parameter	Description	Setting Choices
Print on Mark	Prints a 3 second strip when Mark is pressed.	On / Off
Print on Charge	Prints a continuous strip during charging. Printing continues until a shock is delivered, the device is disarmed, or Strip is pressed.	On / Off
Print on Shock	Prints a 12 second strip when a shock is delivered.	On / Off
Print on Alarm	Prints a 6 second strip during alarms.	On / Off
Printer Delay	Captures what you just saw. All printed strips, including those generated by an event (mark, charge, shock or alarm), include an additional 6 seconds of information - the 6 seconds of information that occurred just prior to printing being initiated.	6 Sec Delay / No Delay
Pace Pulse Markers	Shows pace pulse markers on the ECG displayed, if an internal pacemaker is detected.	Leads & Pads / Leads Only
ECG Lead Cable	Selects the monitoring electrodes source.	3-lead / 5-lead

Table 10-1: General Settings (Continued)

Parameter	Description	Setting Choices
Power On Lead	Allows you to select the ECG lead displayed when the HeartStart XL is powered on in Manual Mode.	Paddles*/any lead available/ Lead II **
QRS Beeper	Provides an audible beep with each QRS complex detected.	On / Off

*If the Paddles setting choice is selected, the HeartStart XL will display the waveform acquired through either paddles *or* multifunction defib electrode pads.

**The default configuration setting is Lead II. If the HeartStart XL will be used by BLS users, it is recommended that the configuration setting be changed to Paddles. This ensures that, if a BLS user inadvertently enters Manual Mode prior to AED Mode, the ECG waveform acquired through the multifunction defib electrode pads is displayed and AED Mode voice and text prompts are active.

WARNING

The Power On Lead must be set to Paddles if you want to ensure that the waveform acquired from pads is displayed, and voice and text prompts are active, when entering AED Mode within 2 minutes of exiting Manual Mode. If Power On Lead is not set to Paddles, voice and text prompts are suspended and no waveform analysis occurs, until you either press ANALYZE, select Pads as the lead, or attach monitoring electrodes.

Table 10-2: AED Settings

Parameter	Description	Setting Choices
AED Shock Series (For software version - Main 20)	Defines the maximum number of shocks to deliver before prompting If Needed Press PAUSE And Begin CPR.	1, 2, 3, 4
AED Shock Series (For software versions - Main 19 and lower)	Defines the maximum number of shocks to deliver before prompting Check Patient, Check Pulse, If Needed Press PAUSE And Begin CPR.	2, 3, 4
Shock Series Timer	Defines the number of seconds that must pass before the next shock is considered the first shock of a new shock series, rather than the next shock of the current shock series.	30, 60, 90, 120, 150, 180, 210, Off
Device Initiated Analysis	Initiates ECG analysis when the HeartStart XL is turned on in AED Mode for new use.	On, Off
Automatic Re-Analysis	Initiates ECG analysis in between shocks within a shock series.	On, Off
Rhythm Monitoring	Monitors the ECG for potentially shockable rhythms when the HeartStart XL is not analyzing, defibrillating, or paused.	On, Off
"Check Patient" Timer	Defines how often (in seconds) the Check Patient prompt is repeated when Rhythm Monitoring detects a potentially shockable rhythm.	30, 45, 60, 90, Off
European Protocol	Modifies Pause state prompts and replaces the Pause Timer with either the Post Shock CPR Timer or the "NSA" Timer, depending on the event preceding the Pause state	Off/On

Table 10-2: AED Settings (Continued)

Parameter	Description	Setting Choices
If European Protocol is set to On, the following two configuration choices appear:		
Post Shock CPR Timer* (For software version - Main 20)	Appears only when European Protocol is on. Defines the duration of the Pause time (in seconds) when PAUSE is pressed and the time since the last shock is less than or equal to the Shock Series Timer setting - typically at the completion of a shock series.	30, 60, 120 , 180
Post Shock CPR Timer* (For software versions - Main 19 and lower)	Appears only when European Protocol is on. Defines the duration of the Pause time (in seconds) when PAUSE is pressed and the time since the last shock is less than or equal to the Shock Series Timer setting - typically at the completion of a shock series.	30, 60 , 120, 180
"NSA" Timer*	Appears only when European Protocol is on. Defines the duration of the Pause time (in seconds) when PAUSE is pressed and the time since the last shock is greater than the Shock Series Timer setting - typically when No Shock Advised.	30, 60, 120, 180
If European Protocol is set to Off, the following configuration choice appears:		
"Pause" Timer* (For software version Main 20)	Defines the duration of the pause time (in seconds), when PAUSE is pressed (when European Protocol is set to Off). Appears only when European Protocol is configured off. Pause Timer is the default.	30, 60, 120 , 180
"Pause" Timer* (For software versions Main 19 and lower.)	Defines the duration of the pause time (in seconds), when PAUSE is pressed (when European Protocol is set to Off). Appears only when European Protocol is configured off. Pause Timer is the default.	30, 60 , 120, 180

Table 10-2: AED Settings (Continued)

Parameter	Description	Setting Choices
The following two configuration choices are always available regardless of the European Protocol setting:		
Lead Select	Turns on ECG monitoring via ECG Leads.	On, Off
SpO ₂	Turns on SpO ₂ monitoring. Only listed as a configurable item if the SpO ₂ option was purchased.	On, Off

* If European Protocol is set to Off, the Pause Timer is used during the Pause state and appears as a configurable parameter. If European Protocol is set to On, either the Post Shock CPR Timer or the "NSA" Timer are used during the Pause state and appear as configurable parameters in place of Pause Timer.

NOTE

If European Protocol is set to On, the setting for the Shock Series Timer must be \leq Post Shock CPR Timer \leq NSA Timer. Also, the Shock Series Timer can not be configured to either Off or 210.

Table 10-3: Manual Settings

Parameter	Description	Choices
Sync After Shock	Determines if the Sync function stays on after a synchronized shock is delivered.	On, Off
Display Shock Counter	Determines if the number of shocks delivered appears on the display during an event.	On, Off
Display Incident Timer	Determines if the elapsed time appears on the display during an event.	On, Off

Table 10-4: ECG Filter Settings

Item	Description	Setting Choices
AC Line Filter	Selects the setting used to filter out AC line noise.	60 Hz, 50 Hz
Pads ECG for Display	Selects the display filter frequency for the therapy cable attached.	Monitor (.15-40Hz), EMS (1-30 Hz)
Pads ECG for Printer	Selects the printer filter frequency for the therapy cable attached.	Monitor (.15-40Hz), EMS (1-30 Hz)
Leads ECG for Display	Selects the display filter frequency for the monitoring electrodes ECG.	Monitor (.15-40Hz), EMS (1-30 Hz)
Leads ECG for Printer	Selects the printer filter frequency for the monitoring electrodes ECG.	Diag (.05 - 150 Hz), EMS (1 - 30 Hz), Monitor (.15 - 40 Hz)

Modifying the Configuration

To modify the configuration, from the main menu:

1. Use the softkeys (▲ and ▼) to highlight the desired category of settings.
2. Press **ENTER**.
3. Use the softkeys to highlight the item you want to change.
4. Press **CHANGE**.
5. Use the softkeys to select the desired setting.
6. Press **SAVE** to save the change. To exit without making the change, press **CANCEL**.
7. Press **MAIN** to return to the main menu.

To make additional changes, repeat steps 1-7.

Returning to the Default Configuration

Press ▲ and ▼ on **ESC** simultaneously, while in the main configuration menu, to return all settings to their default settings. Although there is no visible change in the display, default settings are restored.

Saving Settings to a Data Card

Configuration settings may be saved to a Data Card and used to load the same configuration into other HeartStart XLs or to restore the configuration, if necessary.

To save the configuration:

1. Make sure a Data Card is in the HeartStart XL before you turn the defibrillator/monitor on.
2. Select **Save Settings to Data Card** from the main configuration menu.
3. Press **SAVE** in response to the question **Save Settings to Data Card?**

The HeartStart XL saves the configuration settings to the Data Card and returns to the main configuration menu.

NOTE

To avoid possible confusion, designate one Data Card as the "Configuration Card" and label it clearly. Keep this card physically separate from cards used for storing patient data.

Loading Settings from a Data Card

To load configuration settings:

1. Make sure a Data Card is in the HeartStart XL before you turn the defibrillator/monitor on.
2. Select **Load Settings from Data Card** from the main configuration menu.
3. Press **LOAD** in response to the question **Load Settings from Data Card?**

The HeartStart XL loads the configuration settings from the Data Card and returns to the main configuration menu.

Printing Settings

To print the configuration settings, select **Print All Settings** from the main configuration menu.

11 Maintaining the HeartStart XL

This chapter describes how to care for your HeartStart XL Defibrillator/Monitor and its accessories, including:

- operational checks
- battery maintenance procedures
- instructions on loading printer paper
- cleaning instructions
- a list of approved supplies and accessories, and
- instructions for disposal of the device

You must perform the operational checks described at the specified intervals in order to help prevent and detect electrical and mechanical problems. You must adhere to the battery maintenance procedures specified in order to ensure that your batteries have the energy required to operate the defibrillator and deliver the appropriate therapy.

Operational Checks

The following operational checks are intended to quickly verify the viability of the HeartStart XL. Perform these checks regularly, at the intervals specified, along with visual inspection of the device and all cables, controls, accessories and supplies. Also regularly check expiration dates of all supplies, such as multifunction defib electrode pads and monitoring electrodes.

Before You Begin

Before you run the Shift/System Check, be aware of the following conditions:

- Do **not** touch any of the controls on the HeartStart XL while the Shift/System Check is running.
- If a **Failure** or **Service Unit** message is displayed, or if an unexpected **Not Tested** result is displayed, check that the test is set up correctly. Make sure that:
 - the paper is in the printer
 - the test load is attached
 - a Data Card with enough space is inserted into the HeartStart XL
 - a charged battery is inserted into the HeartStart XL

Run the Shift/System Check again, ensuring that no one touches any of the controls on the defibrillator unless prompted to do so.

- The Pacing function is **not** tested with external paddles. The Pacing function is **only** tested when using the patient cable for external pads.
- If the Data Card is full, the message **Service Unit** appears at the bottom of the screen and the message **Data Card Full** appears at the top of the screen. Replace the Data Card and perform the Shift/System Check again. If the message **Service Unit** continues to appear, do not use the device and call for service.

Every Shift

Perform a “Shift/System Check” every shift to verify that the HeartStart XL is functioning properly and to ensure that necessary supplies and accessories are present and ready for use. You should test every shock delivery method that is used with this unit:

- If you only use external paddles, test only with external paddles (see “Using External Paddles” on page 11-4).
- If you only use defib pads, test only with defib pads (see “Using Pads” on page 11-5).
- If you use both pads and external paddles, test both.
- If your usage also includes internal paddles, perform the “Shift/System Check” with the pads patient cable as described in “Using Pads” on page 11-5. Then, test the unit and the internal paddles just before use, as described in “Using Internal Paddles” on page 11-7.

Every Month

Check expiration dates on multifunction defib electrode pads and monitoring electrodes every month. Replace them if the expiration date has passed.

Using External Paddles

To perform the Shift/System Check using external paddles:

1. Turn the HeartStart XL off.
2. If routinely used, insert a Data Card into the HeartStart XL.
3. Unplug the AC power cord.
4. Insert a charged battery.
5. Be sure the paddles are both fully seated in their holders.
6. While pressing , turn the Energy Select knob to either Manual On or AED On to start the test.
7. Follow the prompts on the display to proceed with the test. If the message **Service Unit** appears, check the information in Table 12-2 and Table 12-3. If the message continues to appear, do not use the device, and call for service.
8. Reconnect the HeartStart XL to AC power.

The test takes less than a minute to complete. When it is done, a report is printed, as shown in Figure 11-1.

Figure 11-1 Shift/System Check Report Using External Paddles

Shift/System Check	8 Jan 1999 13:52:17	M4735A Serial Number:00000001
Last Checked 25 Nov 00	1:25:30 Pass	Qty/Check List:
Current Tests:		
General System Test:	Pass	___ Defibrillator Inspection
ECG Test:	Pass	___ Cables/Connectors
Backup Power Test:	Pass	___ Paddles/Pads
SpO2 Test:	Pass	___ Monitoring Electrodes
Data Card Test:	2:07 (h:mm remaining)	___ Charged Batteries
Defib Test:	Pass/External Paddles	___ AC Power Cord
Pacer Test:	Not tested	___ Printer Paper
		___ Data Card
		___ Ancillary Supplies
		___ SpO2 Sensor

WARNING

Be sure to safely discharge external paddles.

Using Pads

To perform the Shift/System Check using multifunction defib electrode pads:

1. Turn the HeartStart XL off.
2. Connect a 50 ohm test load to the pads patient cable (instead of pads).
3. If a Data Card is routinely used, insert a Data Card into the HeartStart XL.
4. Unplug the AC power cord.
5. Insert a charged battery.
6. While pressing **Strip**, turn the Energy Select knob to either Manual On or AED On to start the test.
7. Follow the prompts on the display to proceed with the test. If the message **Service Unit** appears, check the information in Table 12-2 and Table 12-3. If the message continues to appear, do not use the device, and call for service.
8. Reconnect the HeartStart XL to AC power.

The test takes less than a minute to complete. When it is done, a report is printed, as shown in Figure 11-2.

Figure 11-2 Shift/System Check Report Using Pads

Shift/System Check	8 Jan 1999 13:52:17	SN:00000001							
Current Tests:		Qty/Check List:							
General System Test	Pass	Defibrillator Inspection							
ECG Test	Pass	Cables/Connectors							
Backup Power Test	Pass	Defibrillation Pads/Paddles							
Data Card Test	Pass	Monitoring Electrodes							
Defib Test	Pass/Pads	Charged Batteries							
Pacer Test	Pass	AC Power Cord							
		Printer Paper							
		Data Card							
		Ancillary Supplies							
		Pads							

The Shift/System Check report lists the results of the test and additional checks that you should do. Perform each of these checks and record the results. The guidelines for completing the checks are as follows:

Defibrillator Inspection - make sure the HeartStart XL is clean, clear of objects on top and has no visible signs of damage.

Paddles/Cables/Connectors - make sure there are no cracks, broken wires, or other visible signs of damage. Make sure the connectors engage securely.

Battery - make sure:

- a charged battery is in the HeartStart XL
- another battery is charged or being charged
- the batteries have no visible signs of damage

AC Power

1. Make sure a battery is in the HeartStart XL.
2. Plug the power cord into a power outlet and connect it to the HeartStart XL.
3. Verify that the power and charging indicators on the front of the defibrillator/monitor are lit.
4. Remove the battery from the HeartStart XL and verify that the charging indicator on the front of the defibrillator/monitor is no longer lit. Replace the battery.

Audio - verify there is an audible tone when the HeartStart XL is turned on.

Printer - make sure the printer:

- has sufficient paper
- prints properly

Using Internal Paddles

Since internal paddles are sterilized, testing them prior to use requires a different procedure than the usual Shift/System Check. Follow the steps below to verify performance of either switched or switchless internal paddles.

NOTE

See the *Sterilizable Defibrillator Paddles Instructions for Use* for sterilization recommendations.

1. Use your institution's approved sterile defibrillator paddle test device to perform this test.
2. Connect the internal paddles to the defibrillator.
3. Turn the Energy Select knob to Manual and select 2 Joules.
4. Place the paddles on the test device.
5. Press **CHARGE**.
6. Press the Shock button on the right handle (switched paddles) or on the defibrillator (switchless paddles).
7. Observe the test device.
8. Follow the test device requirements for completion of the test.

Refer to your institution's policy and procedure for testing internal paddles.

WARNING

Do not use or test the defibrillator in a flammable atmosphere (for example, oxygen tents or other areas of concentrated flammable anesthetics).

WARNING

Be sure to safely discharge internal paddles.

Battery Maintenance

The HeartStart XL uses the M3516A Battery Pack. It is a rechargeable sealed lead acid battery. Battery maintenance begins when you receive a new battery and continues throughout the life of the battery. Detailed information on battery care is provided in the application note *"About Sealed Lead Acid Batteries,"* that came with your HeartStart XL.

Table 11-1 lists battery maintenance activities and when they should be performed.

Table 11-1: Battery Maintenance Activities

Activity:	When to Perform:
Perform a visual inspection	Daily, as part of the Shift/System Check.
Charge the battery	After each use, or if the message Low Battery is displayed.
Perform a Battery Capacity Test	Periodically, as appropriate for your institution (see "Battery Capacity Test").
Store the battery appropriately	When not in use.

Recharging Batteries

You may charge batteries while they are in either the HeartStart XL or the optional M4747A Battery Charger Kit.

If the battery is being charged while in the defibrillator/monitor (with the HeartStart XL powered off) a discharged battery will typically be 90% charged after 3 hours (at 25°C). This is indicated by the Batt Charge LED on the front panel turning from amber to green. After the LED turns green, the battery will typically be fully recharged after an additional 12 hours at (25°C).

CAUTION

The battery should be fully charged whenever possible. Repeated charges to just the 90% level will degrade the battery, reducing its life and capacity.

Refer to the charging procedures provided in the operating instructions for the Battery Charger Kit.

Battery Capacity Test

As sealed lead acid batteries age due to usage and storage conditions, their capacity to store and deliver energy diminishes. The Battery Capacity Test provides a quantitative measure of battery capacity. Performing a Battery Capacity Test periodically over the life of the battery gives you an indication of how that battery is aging, and what level of performance it is capable of delivering.

A battery's capacity is most affected by the duration of use and how deeply it is discharged before recharging. Therefore, some general guidelines for performing the Battery Capacity Test are as follows:

Perform a Battery Capacity Test	Average Usage
Every 6 months	Infrequent use for short duration*
Every 3 months	Frequent use, or for longer duration

* "Infrequent use" is less than once per day. "Short duration" is ≤ 15 shocks, or ≤ 30 minutes of monitoring, or ≤ 6 shocks and 20 minutes of monitoring.

You should perform a Battery Capacity Test any time you are concerned about the battery's performance.

You may choose to perform the Battery Capacity Test less frequently if your storage and usage procedures ensure another charged battery is always available.

To perform a Battery Capacity Test (CT):

1. Turn the HeartStart XL off.
2. Label the HeartStart XL to indicate to others that testing is in progress and the battery may not be used.
3. Insert a charged battery.
4. If an AC power cord is connected, unplug it. While pressing , turn the Energy Select knob to AED On to start the test.

5. Allow the test to proceed to completion. The test takes approximately three hours and is complete when test results print out and the device turns itself off.
6. Review the test results and take the appropriate action, as follows:

Table 11-2: Battery Capacity Test Results

If	Then...
Elapsed Time \geq 95 minutes and Low Battery Time \geq 10 minutes	<ol style="list-style-type: none"> 1. The battery passed the test. 2. Record "pass CT" and the date on the bottom of the battery. 3. Recharge the battery before use.
Elapsed Time $<$ 95 minutes or Low Battery Time $<$ 10 minutes	<ol style="list-style-type: none"> 1. The battery failed the test. 2. Record "fail CT" and the date on the bottom of the battery. 3. Discard the battery appropriately.

Battery Capacity

A new, fully-charged M3516A battery, operating at room temperature (25°C), provides 100 minutes of monitoring or more than 50, 200-joule charge-shock cycles.

Battery Life Expectancy

Life-expectancy of a battery depends on the frequency and duration of use. When properly maintained and stored, the life-expectancy of a battery is about 1.5 years. For more aggressive use models, life-expectancy may be less. The date of manufacture is located at the bottom of the battery's back label.

Storing Batteries

Batteries should be used regularly and rotated to distribute the use evenly. When storing batteries, make sure that the battery terminals do not come in contact with metallic objects.

Do not store batteries for more than one month without charging them, if the batteries are installed in the defibrillator. Do not store batteries for more than three months without charging them, if the batteries are *not* installed in the defibrillator. Storage at temperatures between 15°C (59°F) and 30°C (86°F) is recommended to maximize life expectancy.

CAUTION

Storing at temperatures above 40°C (104°F) for extended periods of time will significantly reduce a battery's life-expectancy.

Discarding Batteries

Discard batteries if there are visual signs of damage or if they fail the Battery Capacity Test. Discard batteries in an environmentally safe manner. Properly dispose of batteries according to local regulations.

WARNING

Do not disassemble, puncture, or incinerate batteries. Be careful not to short the battery terminals because this could result in a fire hazard.

Loading Printer Paper

To load printer paper:

1. Slide the printer door to the right until the paper roller pops up.
2. If there is an empty or low paper roll in the printer, pull up on the plastic removal tab to remove the roll.

Figure 11-3 Opening the Printer

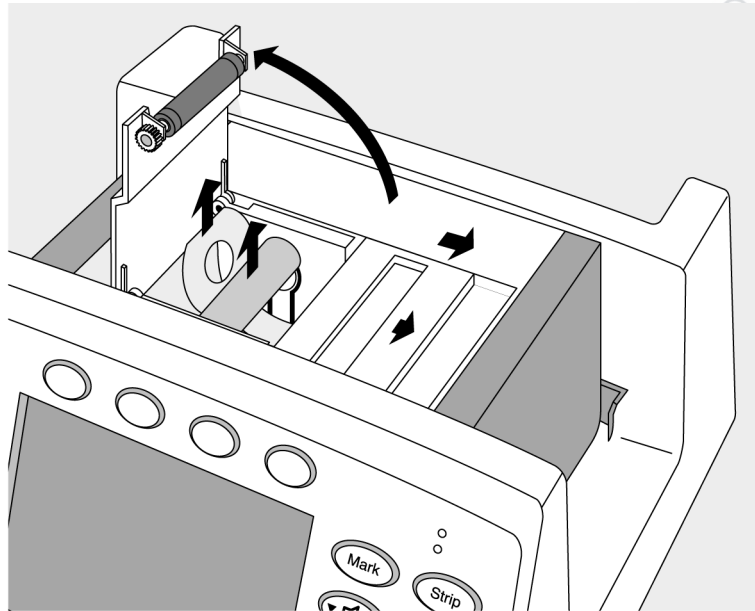

3. Place a new roll of printer paper (40457C/D) into the printer paper well, positioning the roll so that the end of the roll is on the top and the grid faces down. Be sure to push the roll down so that it is firmly seated in the paper well.
4. Pull the end of the paper past the paper roll.
5. Slide the printer door to the right and hold it open. Press the roller down over the paper and release the door.

Figure 11-4 Loading Paper

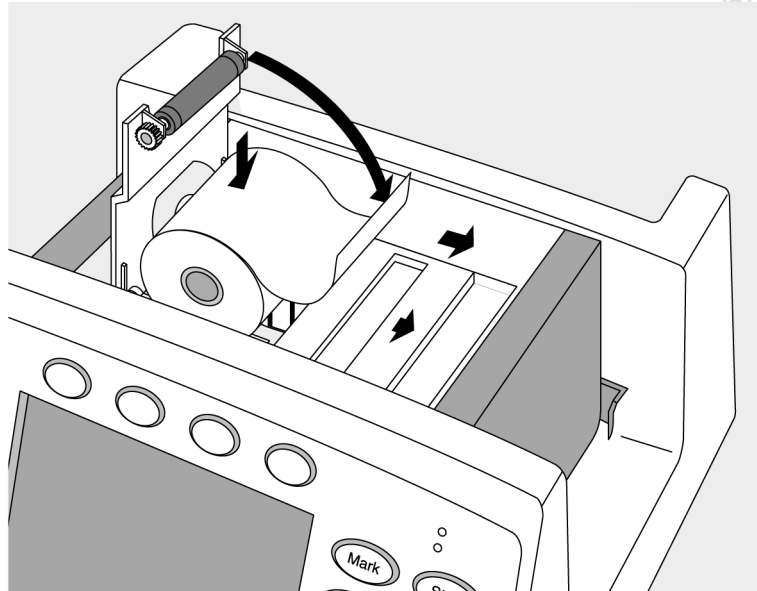

Cleaning Instructions

Use the following recommendations to clean the HeartStart XL and its associated cables, paddles, etc.

Cleaning the HeartStart XL

You may use the following cleaning products to clean the exterior surfaces of the HeartStart XL, as well as the battery and Data Card:

- Isopropyl alcohol (70% in water)
- Mild soap and water
- Chlorine bleach (3% in water)
- Quaternary ammonium compounds, such as Lysol (10% in water)

When cleaning, be sure to avoid pouring fluids on the device and do not allow fluids to penetrate the exterior surfaces of the device. Use of a soft cloth is recommended for cleaning the display, to prevent scratching.

CAUTION

Do not autoclave, ultrasonically clean, or immerse the HeartStart XL. Do not use abrasive cleaners or strong solvents such as acetone or acetone-based cleaners.

Cleaning the Printer Printhead

If the printout has light or varying density printing, clean the printhead to remove any buildup of paper residue.

To clean the printhead:

1. Slide the printer door to the right until the paper roller pops up.
2. Pull up on the plastic removal tab to remove the roll of paper.
3. Clean the printhead surface (above the brush) with a cotton swab dipped in rubbing alcohol.
4. Replace the roll of paper (see “Loading Printer Paper” on page 11-13).

Cleaning Defib Pads & Monitoring Electrodes

Defibrillation pads and monitoring electrodes are single use and do not require cleaning.

Cleaning the External and Internal Paddles

The following procedure for general cleaning of the paddle sets is recommended.

- Clean the electrode surface and handle with standard hospital solution. Do not use acetone, enzymatic, or ammonia-based cleaners.
- Use a small, soft brush with cleaning solution to clean any contamination from the electrode surface and edges.
- Before sterilizing, remove any excessive residue accumulated on the handles or electrode surfaces.
- Do not immerse the connector in cleaning solution. This product was not designed to be soaked in cleaning fluid and should only be surface cleaned.

CAUTION

Do not ultrasonically clean or immerse the paddles and paddles cables.

NOTE

For information about paddle sterilization procedures, see the *M4741-91000 Sterilizable Paddles Instructions for Use*.

Cleaning the Pads Cable

The defib pads cable may be cleaned with:

- Alcohol-free hand soap
- 2% glutaraldehyde solution (such as Cidex)
- Sodium hypochlorite (chlorine bleach) solution 10% in water
- Quaternary ammonium compounds (such as Lysol)
- Isopropyl alcohol

CAUTION

Do not ultrasonically clean, immerse, autoclave or steam sterilize the pads cable.

Cleaning the ECG Cable

The ECG cable may be cleaned by wiping it with any of the following:

- 2% glutaraldehyde solution (such as Cidex[®])
- Alcohol-free hand soap
- Chlorine bleach (100ml/l)

CAUTION

Do not ultrasonically clean, immerse, autoclave or steam sterilize the ECG cable. Do not clean the ECG cable with alcohol. Alcohol can cause the plastic to become brittle and may cause the cable to fail prematurely.

Cleaning the SpO₂ sensor and cable

To clean the SpO₂ sensor and cable, follow the manufacturer's instructions.

Supplies & Accessories

Approved supplies and accessories for the HeartStart XL are listed in Table 11-3 . To order:

- In the USA, call 1-800-225-0230 (pads, electrodes, cables, paper, etc.).
- Outside the USA, contact your local Philips Medical Systems Sales Office, your authorized Philips Medical Systems Dealer or Distributor, or visit our website at: www.medical.philips.com/cms and follow the Supplies link.

Table 11-3: Upgrades, Supplies, and Accessories

Part Number	Description
Upgrades	
M4738A	Pacing Upgrade
M4739A	SpO ₂ Upgrade
Defibrillation Pads, Pads Cables and Test Load (white twist lock connector) 	
M3501A	Multifunction Adult defib pads, AAMI.
M3502A	Multifunction Adult defib pads, IEC.
M3503A	Multifunction Pediatric defib pads, IEC.
M3504A	Multifunction Pediatric defib pads, AAMI.
M3507A	Defib pads cable, barrel connector.
M1781A	Defibrillator test load, barrel connector
05-10200	HeartStart Pads Adapter, barrel connector. Connects to M3507A pads connector cable.

Table 11-3: Upgrades, Supplies, and Accessories (Continued)

Part Number	Description
Defibrillation Pads, Pads Cables, Adapters and Test Load (gray flat connector)	
M3713A	Multifunction Adult Plus Pads - Adult Plus multifunction defib pads (general use).
M3716A	Multifunction Adult Radiolucent Pads - Adult Radiolucent multifunction defib pads (special purpose - for X-ray and special procedures).
M3717A	Multifunction Pediatric Plus Pads - Pediatric multifunction defib pads (general use).
M3718A	Multifunction Adult Radiotransparent/Reduced Skin Irritation Pads - Adult Radiotransparent/Reduced Skin Irritation multifunction defib pads (special purpose - for X-ray and special procedures).
M3719A	Multifunction Pediatric Radiotransparent/Reduced Skin Irritation Pads - Pediatric Radiotransparent/Reduced Skin Irritation multifunction defib pads (special purpose - for X-ray and special procedures).
M3508A	Defibrillator pads cable, plug connector.
M3725A	Defibrillator test load, plug connector.
Paper	
40457C	50 mm Strip Chart Thermal Paper -1 box (10 rolls)
40457D	50 mm Strip Chart Thermal Paper -1 box (80 rolls)

Table 11-3: Upgrades, Supplies, and Accessories (Continued)

Part Number	Description
External Paddles	
M4745A	Sterilizable External Paddles with PCI
M4746A	External Paddles with PCI
M1789A	Replacement Adult Paddle Electrode (clips onto external paddle)
Internal Paddles (Switched/Switchless)	
M1741A	7.5 cm Switchless Internal Paddles
M1742A	6.0 cm Switchless Internal Paddles
M1743A	4.5 cm Switchless Internal Paddles
M1744A	2.8 cm Switchless Internal Paddles
M4741A	7.5 cm Switched Internal Paddles
M4742A	6.0 cm Switched Internal Paddles
M4743A	4.5 cm Switched Internal Paddles
M4744A	2.8 cm Switched Internal Paddles
M4740A	Internal Paddles Adapter Cable
989803127121	Large Disposable Switched
989803127131	Medium Disposable Switched
989803127141	Small Disposable Switched
989803127151	Large Disposable Switchless
989803127161	Medium Disposable Switchless
989803127171	Small Disposable Switchless

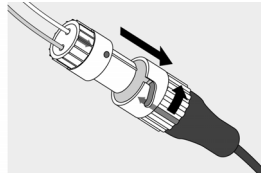
Table 11-3: Upgrades, Supplies, and Accessories (Continued)

Part Number	Description
ECG Cables	
M1500A	3-lead ECG Trunk Cable (AAMI)
M1510A	3-lead ECG Trunk Cable (IEC)
M1520A	5-lead ECG Trunk Cable (AAMI)
M1530A	5-lead ECG Trunk Cable (IEC)
Sync Cable	
M1783A	12-pin Sync Cable
Monitoring Electrodes	
M2202A	High-Tack Foam ECG Electrodes - 5 electrodes/pouch (300 electrodes/case)
SpO₂ Cables/Sensors	
M1191A	Adult Reusable SpO ₂ Sensor (length = 2m)
M1192A	Pediatric Reusable SpO ₂ Sensor
M1131A	Adult/Pediatric Disposable SpO ₂ Sensor (length = 45cm)
M1194A	Adult/Pediatric Ear Clip, Reusable SpO ₂ Sensor
M1903B	Disposable SpO ₂ Sensor - Pediatric Finger (Available outside the U.S. only)
M1904B	Disposable SpO ₂ Sensor - Adult Finger (Available outside the U.S. only)
M1941A	SpO ₂ 2-meter extension cable
M1943A	Nellcor SpO ₂ Sensor Adapter Cable (length = 1.1m)
Data Card	
989803147711	Data Card

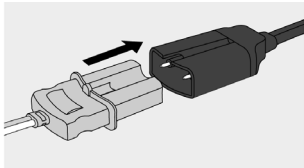
Table 11-3: Upgrades, Supplies, and Accessories (Continued)

Part Number	Description
Battery	
M3516A	Sealed Lead Acid Battery
M4747A	Battery Charger Kit
M3506A	Battery charger adapter
Battery Chargers	
989803135291	Cadex C7200 Battery Charger (holds 2 XL batteries)
989803135321	Cadex C7400 Battery Charger (holds 4 XL batteries)
989803135341	Cadex C7400 Battery Charger (holds 2 XL and 2 MRx batteries)
Accessory Pouch	
M4751A	Accessory pouch
Extension Cable	
M4748A	Adapter extension cable
User Training CD-ROM	
M4735-91000	User Training CD-ROM Kit

Disposing of the HeartStart XL

Prior to disposing of the HeartStart XL, remove the battery. Then dispose of the device and its accessories in accordance with local regulations.

WARNING

Disposal of the device with the battery inserted presents a potential shock hazard.

AED Superstore®
an **ALLIED 100™** company

AED Superstore[®]
an **ALLIED 100**[™] company

12 Troubleshooting

If the HeartStart XL detects an error or potential problem during use, it displays a system or momentary message. These messages are often accompanied by a voice prompt. This chapter describes the messages and what you should do in response. In addition, this chapter provides general troubleshooting tips and information on calling for service.

NOTE

For repair instructions or for additional technical information, refer to the *M4735-90900 HeartStart XL Service Manual*.

AED SuperStart
an ALLIED 100™ company

System Messages

System messages remain on the display until the specified action is taken or no longer relevant. Each new message displayed is accompanied by three beeps to alert you. Table 12-1 lists System messages.

Table 12-1 System Messages

Message	Description	Corrective Action
Attach Pads Cable	The pads cable is not properly attached to the device.	Check the cable connections.
Configuration Lost	The configuration is reset to the default settings.	<ul style="list-style-type: none"> • Reconfigure the HeartStart XL. • Check to see if the battery is properly charged. • Replace the battery. • If the message persists, call for service.
Data Card Disabled	The Data Card is not in use because it is full, incompatible, absent, or inserted after the HeartStart XL was turned on.	<p>If possible, turn the HeartStart XL off for more than 2 minutes, insert an empty, compatible Data Card, and turn the device on.</p> <p>You may also enter configuration mode and turn the machine off, then on again.</p>
ECG Fault	The ECG data acquisition system failed and data is unavailable from the 3- or 5-wire monitoring electrodes, multifunction defib electrode pads, or both.	Remove the device from active use and call for service.
Low Battery	The battery has sufficient capacity remaining to provide only about ten minutes of monitoring time and 5 shocks before the HeartStart XL shuts off.	<ul style="list-style-type: none"> • Replace the battery with a fully charged battery. • Plug in AC power.

Table 12-1 System Messages (Continued)

Message	Description	Corrective Action
Leads Off	<ul style="list-style-type: none"> • The monitoring electrodes are not applied. • The monitoring electrodes are not making proper contact with the patient. • The monitoring cable is not connected. 	<ul style="list-style-type: none"> • Check the monitoring electrodes are properly applied. • Check the monitoring cable is properly connected.
No Pads	The multifunction defib electrode pads are not properly connected to the HeartStart XL.	Check the pads cable connection.
Pads Cable Off	The pads cable is not connected to the defibrillator.	Check that the pads connector is locked in place.
Pads Off	The pads are not making proper contact with the patient.	Make sure the pads are properly applied to the patient.
50J Maximum	When using internal paddles, the maximum energy delivered is limited to 50J.	Select a lower energy.
Pacer Failure	The pacing system is not functioning.	Remove the device from active use and call for service.
Pacer Output Low	High patient impedance is resulting in the pacer delivering less current to the patient than specified in the output current setting.	Check that the pads are applied properly.
No Paddles Connected	The paddles are not properly connected to the HeartStart XL.	Check that external paddles are connected.
Service Unit	Appears during a Shift/System Check. May indicate that the Data Card is full.	<ul style="list-style-type: none"> • Replace the Data Card. • Perform a Shift/System Check • If Service Unit continues to appear, do not use the device and call for service.

Table 12-1 System Messages (Continued)

Message	Description	Corrective Action
SpO ₂ Cable Off	The SpO ₂ cable is not connected to the device.	Attach the SpO ₂ cable to the HeartStart XL.
SpO ₂ Light Interf	The level of ambient light is so high that the sensor cannot obtain an SpO ₂ reading or the sensor or cable is damaged.	<ul style="list-style-type: none"> • Cover the sensor with an opaque material. • Check the sensor for damage; try another sensor.
SpO ₂ Non Pulsatile	The patient's pulse is absent or too weak to be detected.	<ul style="list-style-type: none"> • Check that the sensor is applied properly. • Make sure the sensor site has a pulse. • Relocate the sensor to a site with improved circulation. • Try another sensor.
SpO ₂ Failure	A failure has occurred in the SpO ₂ circuitry.	Remove the device from active use and call for service.
SpO ₂ Low Signal	SpO ₂ signal is too low to give an accurate reading.	<ul style="list-style-type: none"> • Check that the sensor is applied properly. • Try another sensor type.
SpO ₂ Noisy Signal	Excessive patient movement, electrical interference, or optical interference is present.	<ul style="list-style-type: none"> • Minimize patient movement or apply the sensor to a site with less movement. • Secure the sensor cable loosely to the patient. • Reduce sources of electrical or optical interference.
SpO ₂ Sensor Fail	The SpO ₂ transducer is broken.	Try another sensor.



Momentary Messages

Momentary messages are temporary and only appear on the display for a few seconds. Each message is accompanied by a three second beep to alert you. Table 12-2 lists momentary messages.

Table 12-2 Momentary Messages

Message	Possible Cause	Corrective Action
Attach Pads	The multifunction defib electrode pads are not making proper contact with the patient.	<ul style="list-style-type: none"> Check that the pads are applied to the patient, as directed on the pads' package. Replace the pads if the prompt continues.
Attach Leads	An attempt was made to begin pacing in Demand Mode without ECG leads attached to the patient.	Attach leads to patient.
Attach Paddles	An attempt was made to charge the defib in Manual Mode with no paddles connected.	Connect paddles.
Select Leads	<p>An attempt was made to activate Synchronized Cardioversion with paddles connected and selected as the ECG input.</p> <p>With no leads connected, the user connected paddles and selected them as the ECG input, then connected the leads.</p>	<p>Use leads for ECG.</p> <p>Use leads for ECG.</p>
Defib Disarmed	<ul style="list-style-type: none"> The pads connection is compromised. The mode is changed from Manual to AED while the defibrillator is charged. SHOCK or shock buttons are not pressed within 30 seconds of the defibrillator being charged. DISARM is pressed. 	<ul style="list-style-type: none"> Check that the pads are applied to the patient properly. If a shock is indicated, deliver the shock before changing modes. To deliver a shock, press SHOCK or shock buttons on paddles within 30 seconds of the defibrillator being charged.

Table 12-2 Momentary Messages (Continued)

Message	Possible Cause	Corrective Action
No Shock Delivered	Poor skin contact; pads are not properly connected to the patient, Minimal patient movement is possible in this situation as the defibrillator attempts to deliver a shock. The shock counter will remain at zero.	<ul style="list-style-type: none"> • Make sure the pads are applied properly. • Replace the pads, if necessary
Check Printer	Printer paper is absent or jammed; the printer door is not closed properly.	<ul style="list-style-type: none"> • Reload the printer paper. • Make sure the door is closed properly.
Data Card Full	<ul style="list-style-type: none"> • The incident is more than 2 hours in duration, causing the Data Card to fill. • An empty Data Card was not inserted for the incident, causing the Data Card to fill sooner. 	<ul style="list-style-type: none"> • None. A new Data Card cannot be inserted during an incident. • Use one Data Card per incident/patient to decrease the chance of the card filling.
Data Card Interrupted	The Data Card is removed during an incident.	<ul style="list-style-type: none"> • None. The Data Card cannot be re-inserted during an incident. • Do not remove the Data Card during an incident.
Data Card Not In Service	The Data Card is inserted while the HeartStart XL is on.	None. A Data Card must be inserted prior to turning the HeartStart XL on for the current patient.
Incompatible Data Card	A Data Card other than a HeartStart XL-compatible Data Card is inserted.	Use only HeartStart XL-compatible Data Cards (see Chapter 11 for listing).
No Data Card Present	A Data Card is not in the HeartStart XL.	Turn the HeartStart XL off and insert a Data Card prior to the first event for the patient.
Key Inactive	The key pressed is currently inactive (i.e.  is inactive in AED Mode).	Use the appropriate mode for the key.
Stop Pacer	 is pressed while pacing pulses are being delivered.	Stop pacing before changing the pacing mode.
Attach Cable	Patient cable is not properly attached to HeartStart XL.	Check cable connections.

Troubleshooting Tips

Table 12-3 lists some situations that you may encounter, their possible causes, and a few suggested solutions.

Table 12-3 Troubleshooting Tips

Situation	Cause	Possible Solution
<p>The HeartStart XL does not turn on or turns itself off.</p>	<p>There is no power.</p> <p>The Data Card is corrupt.</p> <p>Hardware failure.</p>	<ul style="list-style-type: none"> • Insert a fully charged battery. Attach AC Power cord • Turn the Energy Select Knob to the Off position. • Remove the Data Card. • Insert a new Data Card, if available. • Turn on the device. • If the unit does not turn on normally, it cannot be used. • Remove this unit from clinical use and call for service.

Table 12-3 Troubleshooting Tips (Continued)

Situation	Cause	Possible Solution
The display is blank except for “SYSTEM FAILURE - CYCLE POWER” or “DEFIB FAILURE - CYCLE POWER”	An internal error occurred. The Data Card is corrupt.	If this occurs during actual use: <ul style="list-style-type: none"> ● Substitute another defib, if possible. Remove this unit from clinical use and call for service. If this occurs during routine testing: <ul style="list-style-type: none"> ● Remove this unit from clinical use and call for service. ● If pacing, continue pacing while printing a continuous ECG strip until it is safe to discontinue pacing. ● Turn the Energy Select Knob to the Off position. ● Remove the Data Card. ● Insert a new Data Card, if available. ● Turn on the device. ● If the unit does not turn on normally, it cannot be used. ● Remove this unit from clinical use and call for service.
There is a dashed (----) line on the display instead of an ECG.	ECG data is not being acquired.	<ul style="list-style-type: none"> ● Check the patient cable is connected. ● Check the pads, paddles or electrodes are properly applied. ● Check that the desired lead is selected.
The HeartStart XL does not appear to be functioning properly.	<ul style="list-style-type: none"> ● The battery is low. ● There is a system failure. 	<ul style="list-style-type: none"> ● Change the battery. ● Take the device out of use and call for service.
The displayed time is incorrect.	The time was not correctly set in the configuration.	Set the time in the General Settings menu of the Configuration Mode.
The printed date is incorrect.	The date was not correctly set in the configuration.	Set the time in the General Settings menu of the Configuration Mode.

Table 12-3 Troubleshooting Tips (Continued)

Situation	Cause	Possible Solution
<p>The message Service Unit or Failure is displayed or an unexpected Not Tested result is displayed during a Shift/System Check.</p>	<p>Someone touched the controls on the HeartStart XL during a Shift/System Check.</p>	<p>Check that the test is set up correctly. Make sure that:</p> <ul style="list-style-type: none"> • paper is in the printer • the test load is attached • a Data Card with enough space is inserted into the device • a charged battery is inserted into the device <p>Run the Shift/System Check again ensuring that no one touches any of the controls on the defibrillator while the test is running.</p>

AED SuperStart[®]
 an ALLIED 100™ company

Calling for Service

For telephone assistance, call the Response Center nearest to you, or visit our website at: www.medical.philips.com/cms and follow the link for services.

North America

Canada	800-323-2280
United States of America	800-722-9377

Latin America

Medical Response Center	954-835-2600
--------------------------------	--------------

Europe

European International Sales	800-323-2280
Austria	01 25125 333
Belgium	02 778 3531
Finland	09 615 80 400
France	0803 35 34 33
Germany	01805 47 50 00
Italy	0800 825087
Netherlands	040 278 7630
Switzerland	0800 80 3000 (German) 0800 80 3001 (French)
United Kingdom	07002 43258472

Asia/Asia Pacific

Australia	1800 251 400
China (Beijing)	800 810 0038
Hong Kong Macau	852 2876 7578 0800 923
India New Delhi Mumbai Calcutta Chennai Bangalore Hyderabad	011 6295 9734 022 5691 2463/2431 033 485 3718 044 823 2461 080 5091 911 040 5578 7974
Indonesia	021 794 7542
Japan	0120 381 557
Korea	080 372 7777 02 3445 9010
Malaysia	1800 886 188
New Zealand	0800 251 400
Philippines	02 845 7875
Singapore	1800 PHILIPS
Thailand	02 614 3569
Taiwan	0800 005 616

AED Superstore[®]
an **ALLIED 100**[™] company

13 Specifications & Safety

This section provides:

- specifications for the HeartStart XL
- definitions for symbols appearing on the HeartStart XL
- clinical Performance Summary data
- safety related information
- electromagnetic compatibility information

AED Superstore[®]
an **ALLIED 100**[™] company

Specifications

Defibrillator

Waveform: Biphasic Truncated Exponential. Waveform parameters adjusted as a function of patient impedance.

Shock Delivery: Via multi-function defib electrode pads or paddles.

Delivered Energy Accuracy:

Selected Energy	Delivered Energy (J)					Accuracy
	Load Impedance (ohms)					
(J)	25	50	100	125	150	
5	4.7	5	5.2	5.4	5.2	+2J
10	9.3	10	10.4	10.7	10.4	+2J
20	18.6	20	20.8	21.4	20.8	+4J
30	27.9	30	31.2	32.1	31.2	+4J
50	46.7	50	52.3	53.5	52.1	+15%
70	65.4	70	73.1	75.0	72.9	+15%
100	93.5	100	104.7	107.2	104.4	+15%
150	140.3	150	156.8	161.0	156.5	+15%
200	187	200	209.3	214.6	208.6	+15%

Charge Time:

- Less than 3 seconds to 200 Joules with a new, fully charged M3516A SLA battery pack at 25°C.
- Less than 15 seconds when operating without a battery, using AC power alone at 90-100% rated mains voltage.
- Less than 15 seconds with a new, fully charged M3516A SLA battery pack at 25°C, depleted by up to 15 200 Joule discharges.
- Less than 25 seconds from initial power on, with a new, fully charged M3516A SLA battery pack at 25°C, depleted by up to 15 200 Joule discharges.
- Less than 25 seconds from initial power on when operating without a battery, using AC power alone at 90-100% rated mains voltage.
- Less than 30 seconds from initiation of rhythm analysis (AED Mode) with a new, fully charged M3516A SLA battery pack at 25°C, depleted by up to 15 200 Joule discharges.
- Less than 30 seconds from initiation of rhythm analysis (AED Mode) when operating without a battery, using AC power alone at 90-100% rated mains voltage.
- Less than 40 seconds from initial power on (AED Mode) with a new, fully charged M3516A SLA battery pack at 25°C, depleted by up to 15 200 Joule discharges.
- Less than 40 seconds from initial power on (AED Mode) when operating without a battery, using AC power alone at 90-100% rated mains voltage.

Patient Impedance Range:

- Minimum: 10-25 Ohm, depending upon energy level
- Maximum: 180 Ohm

Manual Mode

Manual Output Energy (Delivered): 2, 3, 5, 7, 10, 20, 30, 50, 70, 100, 150, 200 Joules. When using internal paddles, delivered energy is limited to 50 Joules.

Controls: Manual/AED On/Energy Select knob, Charge/Disarm, Shock, ECG Lead Select, SpO2 On/Off, SpO2 Alarm, HR Alarm, Sync On/Off, Pacer, Pacer Start/Stop, Pacer Rate, Pacer Current, Pacer Mode, ECG Gain, Volume, Strip, Summary, Mark.

Indicators: EL display for ECG waveform and text prompts, Audio alerts, QRS Beeper, Charging tones (for sync and asynchronous modes), AC Power LED, Battery Charging LED, Sync LED, Pacer LED.

Armed Indicators: Charge done tone and available energy indicated on display.

Energy Selection: Front panel rotary knob.

Charge Control: Front panel "2" key or buttons on paddles.

Shock Control: Front panel "3" key or buttons on paddles.

Synchronizer: SYNC message appears on the monitor and is annotated on the printer (if printing while in Sync mode). An audible beep sounds with each detected R-wave, while a tick mark on the monitor and printed strip indicate the discharge points. Synchronizer delay is less than 60 msec from peak R-wave to peak current of the defibrillation discharge.

AED Mode

AED Energy Profile: Fixed energy (150 Joules).

AED Shock Series: 1, 2, 3, or 4 shocks per series.

Shock Series Timer: off, 30, 60, 90, 120, 150, 180, or 210 seconds.

Text and Voice Prompts: Extensive text/audible messages guide user through protocol.

AED Controls: On, Off, Pause/Resume, Analyze/Stop Analysis, Shock, Lead Select, SpO2 On/Off, SpO2 Alarms, HR Alarms, ECG Gain, Volume, Strip, Summary, Mark.

Indicators: EL display for ECG waveform and text prompts, Audio alerts, Voice Prompts, QRS Beeper, Charging Tone, Charge Done Tone, Printer, AC Power LED, Battery Charging LED.

Armed Indicators: Charge Done Tone, Available Energy indicated on display, Voice Message.

Patient Analysis: Per protocol, evaluates patient ECG and signal quality to determine if a shock is appropriate and evaluates connection impedance for proper defibrillation pad contact.

Shockable Rhythms: Ventricular Fibrillation with amplitude $>100 \mu\text{V}$ and shockable wide-complex tachycardias. Shockable tachycardias include wide-complex rhythms of ventricular or unknown origin with heart rate greater than 150 bpm and polymorphic ventricular tachycardia at any heart rate.

Sensitivity and Specificity: Meets AAMI guidelines.

ECG Monitoring

Inputs: Single channel ECG may be viewed on display and printed. Pads ECG is obtained through 2 multifunction defibrillation electrode pads. Lead I, II, or III is obtained through the 3-lead ECG cable and separate monitoring electrodes. With a 5-lead cable, lead aVR, aVL, aVF, and any one of the V (1-6) leads can also be obtained.

Lead Fault: LEADS OFF message and dashed line appear on the display if an electrode or lead wire becomes disconnected.

Paddle Fault: NO PADDLES CONNECTED message and dashed line appear on the display if paddles become disconnected.

Pad Fault: PADS OFF message and dashed line appear on the display if a pad becomes disconnected.

Heart Rate Display: Digital readout on display from 15 to 300 bpm, with an accuracy of $\pm 10\%$.

Heart Rate Alarms: Configurable pairs of low and high heart rate alarm limits: 30 to 100, 60 to 140, 90 to 160, and 120 to 200 bpm.

Hands Free Defibrillation Patient Cable Length: 9 ft (2.74 m).

ECG Cable Length: 12 ft (3.7 m).

Common Mode Rejection: Greater than 90 dB measured per AAMI standard for cardiac monitors (EC 13).

ECG Size: 2.5, 5, 10, 20, 40 mm/mV.

Frequency Response:

AC Line Filter: 60 Hz or 50 Hz.

Pads ECG for Display: Monitor (.15-40 Hz) or
EMS (1-30 Hz).

Pads ECG for Printer: Monitor (.15-40 Hz) or
EMS (1-30 Hz).

Leads ECG for Display: Monitor (.15-40 Hz) or
EMS (1-30 Hz).

Leads ECG for Printer: Diagnostic (.05-150 Hz) or EMS (1-30 Hz) or
Monitor (.15-40 Hz).

Patient Isolation (defibrillation proof):

ECG: Type CF

SpO₂: Type CF

Defib: Type BF

Other Considerations: The HeartStart XL is suitable for use in the presence of electrosurgery. Burn hazard protection is provided via a 1K current limiting resistor contained in each ECG lead wire.

ECG Analysis Performance

Rhythm Class	ECG TEST SAMPLE ^a SIZE	Nominal Specifications
Shockable Rhythm — ventricular fibrillation	600	Meets AAMI DF39 requirement and AHA recommendation ^b (sensitivity >90%) for adult defibrillation
Shockable Rhythm — ventricular tachycardia	300	Meets AAMI DF39 requirement and AHA recommendation ^b (sensitivity >75%) for adult defibrillation
Non-Shockable Rhythm — Normal Sinus Rhythm	250	Meets AAMI DF39 requirement (specificity > 95%) and AHA recommendation ^b (specificity >99%) for adult defibrillation
Non-Shockable Rhythm — Asystole	500	Meets AAMI DF39 requirement and AHA recommendation ^b (specificity >95%) for adult defibrillation
Non-Shockable Rhythm — All other non-shockable rhythms	600	Meets AAMI DF39 requirement and AHA recommendation ^b (specificity >95%) for adult defibrillation

a. From Philips Medical Systems ECG rhythm databases.

b. American Heart Association (AHA) AED Task Force, Subcommittee on AED Safety & Efficacy. Automatic External Defibrillators for Public Access Use: Recommendations for Specifying and Reporting Arrhythmia Analysis Algorithm Performance, Incorporation of New Waveforms, and Enhancing Safety. American Heart Association (AHA) AED Task Force, Subcommittee on AED Safety & Efficacy. *Circulation* 1997;95:1677-1682.

Display

Type: EL - Electroluminescent*

Size: 115 mm x 86 mm

Resolution: 320 x 240 pixels

Sweep Speed: 29 mm/s nominal (stationary trace; sweeping erase bar).

Viewing Time: 4 seconds.

OR

Type: LCD - TFT Color Liquid Crystal Display*

Size: 111.4 mm x 83.5 mm

Resolution: 320 x 240 pixels

Sweep Speed: 29 mm/s nominal (stationary trace; sweeping erase bar).

Viewing Time: 4 seconds.

*The presence of display information on the primary label located on the bottom of the device indicates that the HeartStart XL contains an LCD display.

Battery

Type: 2 Ah, 12V, rechargeable, Sealed Lead Acid.

Dimensions: 2.4" (H) x 0.94" (W) x 7.2" (D) (61.7mm x 23.9mm x 182mm).

Weight: 1.4 lb. (0.65 kg).

Charge Time: Approximately 14.5 hours to 100%. Approximately 3 hours to 90%, indicated by LED on front panel.

Capacity: 100 minutes ECG monitoring or 50 full-energy discharges or 75 minutes ECG monitoring while pacing (with a new, fully charged battery at room temperature, 25° C).

Battery Indicators: LOW BATTERY message appears on display when at least 10 minutes of monitoring time and 5 maximum energy discharges remain (with a new battery at room temperature, 25° C).

Battery Storage: Should not be stored above 40° C for extended periods of time.

Charger Output: Unit can be operated using only AC Power, with no battery installed.

Thermal Array Printer

Continuous Real Time Strip: User starts and stops the strip. The strip prints the selected ECG lead with the following data:

Header 1: Date, Time, Heart Rate, the SPO₂ Value (if available), and the text "Delayed" if printing has been configured for Delayed Mode. Prints every 12 seconds.

Header 2: Current mode (AED/Manual), Lead, Gain, filter setting, the text "Sync" (if Sync has been enabled), and Pacer Settings (consisting of the Pacer Mode, Rate, and Current, if presently pacing the patient). Prints every 12 seconds, with Header 1.

Header 3: Changes in Mode, Gain, Lead, Sync, and Pacer Settings.

Footer: Drug Annotations, HR/SpO₂ limits on a Limit Alarm, the Results of Analysis in AED Mode (No Shock Advised, Shock Advised, or Cannot Analyze), Charging to xxx J, Shock Delivered, No Shock Delivered, Disarm, Battery Low.

Symbols: Mark Triangle (for presses of the Mark key), an Alarm Bell (Alarm Limit Violations), Lightning Bolt (Shock Delivered; followed by b for biphasic), Vertical Stripe Boundaries/Pacer/Sync Tick Marks.

Event Printing: Mark key automatically documents ECG and events during defibrillation episodes. The Mark key can annotate the event with one of the following labels: Epinephrine (Adrenaline), Atropine, Lidocaine, and Other.

Auto Printing: The printer can be configured to automatically print on Mark, Charge, Shock and Alarm.

Delayed Printing: The printer can be configured to run real time or with a 6 second delay.

Reports: The following can be printed: Event Summary, Configuration, Extended Self Test, System Log, Battery Capacity Test, Shift/System Check.

Speed: 25 mm/s with an accuracy of $\pm 5\%$.

Amplitude Accuracy: $\pm 10\%$ or ± 50 uV, whichever is greater.

Paper Size: 50 mm by 30 m (100 ft).

Noninvasive Pacing

Waveform: Monophasic Truncated Exponential.

Current Pulse Amplitude: 10 mA to 200 mA (5 mA resolution); accuracy 10 mA to 50mA ± 5 mA, 50mA - 200mA $\pm 10\%$.

Pulse Width: 20 ms with accuracy +0, -5 ms.

Rate: 30 ppm to 180 ppm (10 ppm increments); accuracy $\pm 1.5\%$.

Modes: Demand or Fixed Rate.

Refractory Period: 340 msec (30 to 80 ppm); 240 msec (90 to 180 ppm).

SpO₂ Pulse Oximetry

Range:

SpO₂ - 0 to 100%.

Pulse Rate - 30 to 300 bpm.

Accuracy with:

M1191A sensor - 1 standard deviation 70% to 100%, $\pm 2.5\%$.

M1192A sensor - 1 standard deviation 70% to 100%, $\pm 2.5\%$.

M1194A sensor - 1 standard deviation 70% to 100%, $\pm 4.0\%$.

M1131A sensor - 1 standard deviation 70% to 100%, $\pm 3.0\%$.

M1903B sensor - 1 standard deviation 70% to 100%, $\pm 3.0\%$.

M1904B sensor - 1 standard deviation 70% to 100%, $\pm 3.0\%$.

Pulse Rate Accuracy: 2% or 1 bpm (whichever is greater).

Wavelength Range: 500 to 1000 nm.

Emitted Light Energy: \leq to 15 mW.

Display Update Interval: \leq 60 seconds.

Resolution: 1%.

SpO₂ Alarm Limits: Three preset low alarm limits: 90%, 85%, and 80%.

INOP Alerts: Triggered by disconnected sensor, noisy signal, light interference or low signal (non-pulsatile).

Alarm delay: \leq 10 seconds.

Event Storage

Internal Event Summary: The internal Event Summary stores up to 300 events and up to 50 waveforms.

Events can be marked with a Mark symbol and, if configured for drug annotation, the following labels can be added: Epinephrine (Adrenaline in U.K. & Australia), Atropine, Lidocaine, or Other.

The Summary key on the front panel is used to print the internal Event Summary.

Data Card Event Summary: One Data Card can store a minimum of 2 hours of continuous ECG waveforms and events.

General

Dimensions: 19.0 cm(H) x 37.6 cm(W) x 34.6 cm(L)
(7.5 in. x 14.8 in. x 13.7 in.)

Weight: 6.0 kg (13.2 lbs.) including battery and one roll of paper.

Environmental

Temperature: 0° C to 55°C operating, -20° to 70°C storage.

- Charging the battery at temperatures above 35°C may degrade battery life
- Storing the battery for extended periods at temperatures above 40°C will reduce battery capacity and degrade battery life.

Humidity: Up to 95% Relative Humidity

- Printer paper may jam if paper is wet.
- Thermal Printer may be damaged if wet paper is allowed to dry while in contact with printer elements.

Altitude:**Operating:** up to 15,000 ft.**Storage:** up to 15,000 ft.**Shock:** Philips Medical Systems, Section 760 Class B1 Drop Test (200 G's, < 3 msec pulse).**Vibration:** Philips Medical Systems, Section 759 Class B1 Vibration.**Water Resistance:** Meets IEC 601-2-4, IPX0.**EMC:** Meets EN 60601-1-2.**Safety:** Meets IEC 601-1 (EN 60601-1), UL 2601-1, CAN/CSA C22.2 No. 601-1.**Other Considerations:** Equipment not suitable for use in the presence of a flammable anesthetic mixture with air, oxygen, or nitrous oxide.**Mode of Operation:** Continuous.**AC Line Powered:** 100-240 VAC, 50/60 Hz, 1.5 A (Class 1)**Battery Powered:** 12 V Rechargeable, SLA

Symbol Definitions

The following table lists the meaning of each symbol shown on the HeartStart XL and the M3516A battery:

Table 13-1: Defibrillator and Battery Symbols









Symbol	Definition
	Defibrillation Shock.
	Attention - See operating instructions in user's guide.
	Input.
	Meets IEC type BF leakage current requirements and is defibrillator protected (Patient Applied Part is isolated and defib-proof suitable for direct patient contact except the heart or major arteries.)
	Meets IEC type CF leakage current requirements and is defibrillator protected (Patient Applied Part is isolated and defib-proof suitable for direct patient contact including the heart and major arteries).
	Alarms are active.
	Alarms are inactive.
	Recyclable material.

Table 13-1: Defibrillator and Battery Symbols (Continued)







Symbol	Definition
	Biphasic energy is being used.
	Must be recycled or disposed of properly.
	Unlock.
	Audio Speaker
	Protective earth ground.
	Alternating current.
	Dangerous voltage.

Table 13-2: Abbreviations and Acronyms

Abbreviation/ Acronym	Definition
AC	Alternating Current
AED	Automated External Defibrillator
ECG	Electrocardiogram
SpO ₂	Pulse oximetry
Batt	Battery
ECG Out	Monitoring Signal from Defibrillator

AED Superstore[®]
an ALLIED 100[™] company

The following table lists the symbols that may appear on the HeartStart XL shipping carton:

Table 13-3: Shipping Carton Symbols







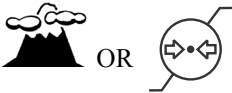
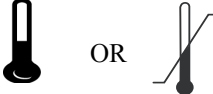
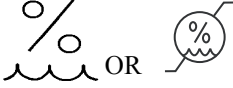

Symbol	Definition
 OR	Atmospheric pressure range.
 OR	Temperature range.
 OR	Relative humidity range.
	Recyclable paper product.
	Fragile.
	Right side up.
	Do not get wet.

Table 13-3: Shipping Carton Symbols (Continued)

Symbol	Definition
	Shelf life.
	Long-term storage conditions.
	Short-term transport storage.

AED Superstore®

an ALLIED 100™ company

Clinical Performance Summary - Defibrillation

An international, multicenter, prospective, randomized, clinical study was conducted to assess the effectiveness of the SMART Biphasic waveform in out-of-hospital sudden cardiac arrests (SCAs), as compared to monophasic waveforms. The primary objective of the study was to compare the percent of patients with ventricular fibrillation (VF) as the initial monitored rhythm that were defibrillated in the first series of three shocks or less.

This section summarizes the methods and results of this study. [®]

Methods

Victims of out-of-hospital SCA were prospectively enrolled in four emergency medical service (EMS) systems. Responders used either 150J SMART Biphasic AEDs or 200-360J monophasic waveform AEDs. A sequence of up to three defibrillation shocks were delivered. For the biphasic AEDs, there was a single energy output of 150J for all shocks. For monophasic AEDs, the shock sequence was 200, 200, 360J. Defibrillation was defined as termination of VF for at least five seconds, without regard to hemodynamic factors.

Results

Randomization to the use of monophasic or SMART Biphasic automatic external defibrillators (AEDs) was done in 338 SCAs from four emergency medical service systems. VF was observed as the first monitored rhythm in 115 patients. The biphasic and monophasic groups for these 115 patients were similar in terms of age, sex, weight, primary structural heart disease, cause or location of arrest, and bystanders witnessing the arrest or performing CPR.

The 150J SMART Biphasic waveform defibrillated 98% of VF patients in the first series of three shocks or less, compared with 69% of patients treated with monophasic waveform shocks. Outcomes are summarized in Table 13-4.

Table 13-4: Clinical Summary - Defibrillation

	Biphasic Patients Number (Percent)	Monophasic Patients Number (Percent)	P Value (chi-square)
Defibrillation Efficacy			
Single shock only	52/54 (96%)	36/61 (59%)	<0.0001
≤2 shocks	52/54 (96%)	39/61 (64%)	<0.0001
≤3 shocks	53/54 (98%)	42/61 (69%)	<0.0001
Patients Defibrillated	54/54 (100%)	49/58 (84%)	0.003
Return of Spontaneous Circulation	41/54 (76%)	33/61 (54%)	0.01
Survival to Hospital Admission	33/54 (61%)	31/61 (51%)	0.27
Survival to Hospital Discharge	15/54 (28%)	19/61 (31%)	0.69
CPC = 1 (Good)	13/15 (87%)	10/19 (53%)	0.04

Conclusion

The 150J SMART Biphasic waveform defibrillated at higher rates than 200-360J monophasic waveforms, resulting in more patients achieving return of spontaneous circulation (ROSC) (p=0.01). EMS system outcomes of survival discharge were not significantly different statistically. However, patients resuscitated with the lower energy SMART Biphasic waveform were more likely to have good cerebral performance (CPC, cerebral performance category) (p=0.04).

Clinical Performance Summary - Cardioversion

An international, multicenter, prospective, double-blinded, randomized, clinical trial was conducted to assess the effectiveness of the SMART Biphasic waveform in treatment of atrial fibrillation (AF), as compared to monophasic waveforms. The primary objective of the study was to determine the required energy for cardioversion of AF using the SMART Biphasic waveform, as compared with a monophasic damped sine waveform.

This section summarizes the methods and results of this study. [®]

Methods

Patients enrolled for this study were adults scheduled for elective cardioversion of AF at one of 11 clinical sites. Clinicians used both a defibrillator delivering the SMART Biphasic waveform, and one delivering a monophasic waveform. A sequence of up to five shocks was administered: four with the initial defibrillator, and a fifth cross-over shock was delivered with the other defibrillator if necessary. The sequence of energy settings was 100J, 150J, 200J through the first three shocks on either type of defibrillator. A fourth shock, if necessary, was delivered at 200J if the initial defibrillator was biphasic, and at 360J if the initial defibrillator was monophasic. The cross-over shock was 360J monophasic if the initial defibrillator was biphasic, and 200J biphasic if the initial defibrillator was monophasic. Successful cardioversion was defined as the occurrence of two P waves uninterrupted by atrial fibrillation within 30 seconds of the shock.

Results

Randomization to the use of monophasic or SMART Biphasic defibrillators was done in 212 elective cardioversions involving 210 patients at eleven clinical sites in the United States and Europe. Of these, 203 results met the protocol criteria for inclusion in this analysis. The biphasic and monophasic groups were similar in terms of age, sex, weight, current medical history, cause of heart disease, and estimated ejection fraction.

The 150J SMART Biphasic waveform successfully converted far more patients with an initial 100J shock (60% compared with 22% for the monophasic waveform), and successfully converted patients at least as well with a maximum energy of 200J as the monophasic did with its maximum energy of 360J (91% compared to 85% for the monophasic waveform). Overall, the biphasic waveform required fewer shocks (1.7, compared to 2.8 for the monophasic waveform) and lower delivered energy (217J, compared to 548J for the monophasic waveform). Outcomes are summarized in Table 13-5.

Table 13-5: Clinical Summary - Cardioversion

	Biphasic Patients Number (Percent)	Monophasic Patients Number (Percent)	P Value
Cumulative Cardioversion Efficacy			
Single shock only	58/96 (60%)	24/107 (22%)	<0.0001
≤2 shocks	74/96 (77%)	47/107 (44%)	<0.0001
≤3 shocks	86/96 (90%)	57/107 (53%)	<0.0001
≤4 shocks	87/96 (91%)	91/107 (85%)	.29
Skin “burn”			
None	25/90 (28%)	15/105 (14%)	0.0001
Mild	50/90 (56%)	47/105 (45%)	
Moderate	15/90 (17%)	41/105 (39%)	
Severe	0/90 (0%)	2/105 (2%)	
Number of shocks	1.7 ± 1.0	2.8 ± 1.2	<0.0001
Cumulative delivered energy	217 ± 176J	548 ± 331J	<0.0001
Skin reaction definitions: (Evaluated 24 - 48 hours after procedure)			
Mild - erythema, no tenderness			
Moderate - erythema, tenderness			
Severe - blistering or necrosis, tenderness			

Conclusion

The SMART Biphasic waveform cardioverted at higher rates than the monophasic damped sine waveform at each step of the protocol, although the cumulative biphasic rate after 4 shocks was not significantly different from the monophasic rate. Tissue damage was more pronounced in the monophasic population.

AED Superstore[®]
an **ALLIED 100**[™] company

Clinical Performance Summary - Internal Defibrillation

Overview

A study was conducted during the first half of 2002 to assess the effectiveness of the HeartStart XL (biphasic) for use in intra-thoracic application, as compared to a control biphasic waveform. This appendix summarizes the methods and results of the study.

Methods

Twelve swine, each weighing approximately 30 kg, were anesthetized and intubated. A sternotomy was performed to expose the heart. VF was induced electrically by 60 Hz current via a pacemaker catheter in the right ventricle. After 15 seconds of VF, a defibrillating shock was applied, using hand-held (2-inch diameter) "surgical" electrode paddles applied directly to the epicardium. Shock energies of 2, 5, 10, 20, and 30 J were used in random order. At least 4 shocks at each energy level were administered for 4 separate VF episodes to derive a "% success" data point at that energy. Success was defined as conversion of fibrillating rhythm to non-fibrillating rhythm five seconds after the shock.

Results

The results showed that the average impedance was about 40 ohms in this study, which is similar to the human impedance data encountered in direct heart defibrillation. The efficacy results of the HeartStart XL are shown in the following table, along with historical efficacy results of a standard monophasic damped sine (MDS) waveform.¹

	Energy				
	2J	5J	10J	20J	30J
HeartStart XL (biphasic) Mean Success	4%	47%	77%	86%	88%
Sample Size	48	53	53	51	41
Control Biphasic Mean Success	10%	60%	93%	92%	92%
Sample Size	49	48	54	49	40
p-value Fisher's Exact (p<0.050)	0.436	0.232	0.032	0.526	0.712
Historical MDS Mean Success	3%	25%	34%	57%	76%

Conclusion

Overall, the intra-thoracic defibrillation success rate for the HeartStart XL (Biphasic) versus a control biphasic waveform had no significant difference (p<0.05) except at 10J.

1. Zhang, Y., Davies R., Coddington W., Jones J., Kerber RE., Open Chest Defibrillation: Biphasic versus Monophasic Waveform Shocks, JACC 2001;37;320A.

Safety Considerations

The following general warnings and cautions apply to use of the HeartStart XL. Additional warning and cautions specific to a particular feature are provided in the appropriate section.

WARNING

The HeartStart XL is not intended to be deployed in settings or situations that promote use by untrained personnel. Operation by untrained personnel can result in injury or death.

WARNING

Use of the HeartStart XL is restricted to a single patient at a time.

WARNING

Remain attentive to the patient during the delivery of therapy. Delay in delivering a shock may result in a rhythm that was analyzed as shockable converting spontaneously to non-shockable and could result in inappropriate delivery of a shock.

WARNING

Use only the multifunction defib electrode pads, battery, and accessories listed in "Outside the USA, contact your local Philips Medical Systems Sales Office, your authorized Philips Medical Systems Dealer or Distributor, or visit our website at: www.medical.philips.com/cms and follow the Supplies link." on page 11-18. Substitutions may cause the HeartStart XL to function improperly.

WARNING

Use multifunction defib electrode pads prior to their expiration date. Discard pads after use. Do not reuse pads. Do not use for more than 8 hours of continuous pacing.

WARNING

In AED Mode, the multifunction defib electrode pads must be in the anterior-anterior position as shown on the packaging. The HeartStart XL was not designed to assess data acquired from pads in an anterior-posterior position.

WARNING

Use only 3-wire AC power cords with 3-pronged grounded plugs.

WARNING

Keep hands and feet clear of paddle electrode edges. Use your thumbs to depress the shock buttons on the paddle handle.

CAUTION

Conductive parts of electrodes and associated connectors for applied parts, including the neutral electrode, should not contact other conductive parts including earth.

WARNING

Do not allow multifunction defib electrode pads to touch each other or to touch other ECG monitoring electrodes, lead wires, dressings, etc. Contact with metal objects may cause electrical arcing and patient skin burns during defibrillation and may divert current away from the heart.

WARNING

During defibrillation, air pockets between the skin and multifunction defib electrode pads may cause patient skin burns. To help prevent air pockets, make sure the pads completely adhere to the skin. Do not use dried out pads; do not open pads package until just prior to use.

WARNING

Never touch the patient or any equipment connected to the patient (including the bed or gurney) during defibrillation.

WARNING

Never operate the HeartStart XL in standing water.

Do not immerse, or pour fluids on, any portion of the HeartStart XL.

WARNING

Do not use the HeartStart XL in a flammable or oxygen-rich atmosphere. This can cause an explosion hazard.

WARNING

Avoid connecting the patient to several devices at once. Leakage current limits may be exceeded. Do not use a second defibrillator on the patient while pacing with the HeartStart XL.

NOTE

The HeartStart XL can be operated with only AC line power, only 12v M3516A SLA Battery or AC power and M3516A SLA battery simultaneously.

WARNING

Avoid contact between the patient and conductive fluids and/or metal objects, such as the gurney. Contact with metal objects could cause unintentional current pathways.

WARNING

Operating the HeartStart XL or its accessories in conditions outside the environmental specifications can result in device or accessory malfunction. The HeartStart XL should be allowed to stabilize within the operating temperature range for 30 minutes prior to operation.

WARNING

Medical electrical equipment which does not incorporate defibrillator protection should be disconnected during defibrillation.

WARNING

Electric shock hazards exist internally. Do not remove assembly screws. Refer servicing to qualified personnel.

CAUTION

This device has not been evaluated for use with electrosurgery equipment.

NOTE

This device and accessories are not intended for home use.

CAUTION

Do not discharge the defibrillator with the paddles shorted together.

WARNING

Properly dispose of or recycle depleted batteries according to local regulations. Do not puncture, disassemble, or incinerate batteries.

WARNING

Where the integrity of the external protective earth conductor is in doubt, the device shall be operated from its internal power source.

NOTE

For operation in the U.S., the attachment plug must be the proper NEMA type for connection to the alternative voltage.

CAUTION

Be aware of patient cables, including ECG monitoring equipment when used with high frequency surgical equipment.

WARNING

To break connection with main power remove plug from wall outlet.

Electromagnetic Compatibility

(Devices with Serial Numbers US001XXXXX)

When using the M4735A HeartStart XL Defibrillator/Monitor, electromagnetic compatibility with surrounding devices should be assessed.

A medical device can either generate or receive electromagnetic interference. Testing for electromagnetic compatibility EMC with and without the appropriate accessories has been performed according to the international standard for EMC for medical devices (IEC 60601-1-2:1993). This IEC standard has been adopted in Europe as the European Norm (EN 60601-1-2:1993).

The EMC standards describe tests for both emitted and received interference. Emission tests deal with interference generated by the device being tested.

WARNING

Radio frequency (RF) interference from nearby transmitting devices may degrade performance of the M4735A HeartStart XL Defibrillator/Monitor. Electromagnetic compatibility with surrounding devices should be assessed prior to using the defibrillator.

Reducing Electromagnetic Interference

The M4735A HeartStart XL Defibrillator/Monitor and associated accessories may be susceptible to interference from other RF energy sources and continuous, repetitive, power line bursts. Examples of other sources of RF interference are medical devices, cellular products, information technology equipment and radio/television transmission. Should interference be encountered, as demonstrated by artifact on the ECG or dramatic variations in SpO₂ values, attempt to locate the source. Assess:

- Is the interference intermittent or constant?
- Does the interference occur only in certain locations?
- Does the interference occur only when in close proximity to certain medical devices?
- Does the SpO₂ value change dramatically when the AC line cord is unplugged?

Once the source is located, attempt to attenuate the EMC coupling path by distancing the defibrillator from the source as much as possible. If assistance is needed, call your local service representative.

Restrictions for Use

Artifact on the ECG caused by electromagnetic interference should be evaluated by a physician or physician authorized personnel to determine if it will negatively impact patient diagnosis or treatment.

Immunity Level

The EMC standards state that manufacturers of patient-coupled equipment must specify immunity levels for their systems. It is recognized that the Heart-Start XL defibrillator/monitor is designed to receive and amplify low level signals in the same bandwidth as the interference.

Immunity is defined in the standard as the ability of a system to perform without degradation in the presence of an electromagnetic disturbance. Degradation in ECG quality is a qualitative assessment which can be subjective.

Caution should, therefore, be taken in comparing immunity levels of different devices. The criteria used for degradation is not specified by the standard and may vary with the manufacturer.

AED Super ECG/HR
an ALLIED 100™

Electromagnetic Compatibility

(Devices with Serial Numbers US002XXXXX)

When using the M4735A HeartStart XL Defibrillator/Monitor, electromagnetic compatibility with surrounding devices should be assessed.

A medical device can either generate or receive electromagnetic interference. Testing for electromagnetic compatibility EMC with and without the appropriate accessories has been performed according to the international standard for EMC for medical devices (IEC 60601-1-2:2001). This IEC standard has been adopted in Europe as the European Norm (EN 60601-1-2:2002).

The EMC standards describe tests for both emitted and received interference. Emission tests deal with interference generated by the device being tested.

WARNING

Radio frequency (RF) interference from nearby transmitting devices may degrade performance of the M4735A HeartStart XL Defibrillator/Monitor. Electromagnetic compatibility with surrounding devices should be assessed prior to using the defibrillator.

Fixed, portable, and mobile frequency communications equipment can affect the performance of medical equipment. See Table 13-10 for the minimum recommended separation distance between RF communications equipment and the HeartStart XL.

Reducing Electromagnetic Interference

The M4735A HeartStart XL Defibrillator/Monitor and associated accessories may be susceptible to interference from other RF energy sources and continuous, repetitive, power line bursts. Examples of other sources of RF interference are medical devices, cellular products, information technology equipment and radio/television transmission. Should interference be encountered, as demonstrated by artifact on the ECG or dramatic variations in SpO₂ values, attempt to locate the source. Assess:

- Is the interference intermittent or constant?
- Does the interference occur only in certain locations?
- Does the interference occur only when in close proximity to certain medical devices?
- Does the SpO₂ value change dramatically when the AC line cord is unplugged?

Once the source is located, attempt to attenuate the EMC coupling path by distancing the defibrillator from the source as much as possible. If assistance is needed, call your local service representative.

Restrictions for Use

Artifact on the ECG caused by electromagnetic interference should be evaluated by a physician or physician authorized personnel to determine if it will negatively impact patient diagnosis or treatment.

Emissions and Immunity

The HeartStart XL (with serial numbers appearing as US002XXXXX) is designed and tested to comply with the radiated and conducted emissions requirement of international and national standards IEC 60601-1-2:2001 and EN 60601-1-2:2002. See Tables 13-6 through 13-10 for detailed information regarding declaration and guidance.

WARNING

The use of accessories, transducers and cables other than those specified below may result in increased emissions or decreased immunity of the HeartStart XL.

The list of cables, transducers, and other accessories with which Philips claims compliance with the emissions and immunity requirements of IEC standard 60601-1-2 are listed in “Maintaining the HeartStart XL”.

The EMC standards state that manufacturers of patient-coupled equipment must specify immunity levels for their systems.

Immunity is defined in the standard as the ability of a system to perform without degradation in the presence of an electromagnetic disturbance. Degradation in ECG quality is a qualitative assessment which can be subjective.

Caution should, therefore, be taken in comparing immunity levels of different devices. The criteria used for degradation is not specified by the standard and may vary with the manufacturer.

Guidance and Manufacturer's Declaration

The HeartStart XL is intended for use in the electromagnetic environment specified in the tables below. The customer or the user of the HeartStart XL should assure that it is used in such an environment.

Table 13-6: Electromagnetic Emissions

Emissions Test	Compliance	Electromagnetic Environment - Guidance
RF emissions CISPR 11	Group 1	The HeartStart XL uses RF energy only for its internal function. Therefore, its RF emissions are very low and not likely to cause interference in nearby electronic equipment.
RF emissions CISPR 11	Class B	The HeartStart XL is suitable for use in all establishments, including domestic and those directly connected to the public low-voltage power supply network that supplies buildings used for domestic purposes.
Harmonic emissions IEC 61000-3-2	Class A	
Voltage fluctuations/flicker emissions IEC 61000-3-3	Complies	

Table 13-7: Electromagnetic Immunity - General

Immunity Test	IEC 60601 Test Level	Compliance Level	Electromagnetic Environment - Guidance
Electrostatic discharge (ESD) IEC 61000-4-2	± 6 kV contact ± 8 kV air	± 6 kV contact ± 8 kV air	Floors should be wood, concrete, or ceramic tile. If floors are covered with synthetic material, the relative humidity should be at least 30%.
Electrical fast transient/burst IEC 61000-4-4	± 2 kV for power supply lines ± 1 kV for input/output lines	± 2 kV for power supply lines ± 1 kV for input/output lines	Mains power quality should be that of a typical commercial or hospital environment.
Surge IEC 61000-4-5	± 1 kV differential mode ± 2 kV common mode	± 1 kV differential mode ± 2 kV common mode	Mains power quality should be that of a typical commercial or hospital environment.
Voltage dips, short interruptions, and voltage variations on power supply input lines IEC 61000-4-11	$< 5\% U_T^a$ ($> 95\%$ dip in U_T) for 0,5 cycle $40\% U_T$ (60% dip in U_T) for 5 cycles $70\% U_T$ (30% dip in U_T) for 25 cycles $< 5\% U_T$ ($> 95\%$ dip in U_T) for 5 sec	$< 5\% U_T^a$ ($> 95\%$ dip in U_T) for 0,5 cycle $40\% U_T$ (60% dip in U_T) for 5 cycles $70\% U_T$ (30% dip in U_T) for 25 cycles $< 5\% U_T$ ($> 95\%$ dip in U_T) for 5 sec	Mains power quality should be that of a typical commercial or hospital environment. If the user of the HeartStart XL requires continued operation during power mains interruptions, it is recommended that the HeartStart XL be powered from an uninterruptible power supply or a battery.
Power frequency (50/60 Hz) magnetic field IEC 61000-4-8	3 A/m	3 A/m	Power frequency magnetic fields should be at levels characteristic of a typical location in a typical commercial or hospital environment.
^a U_T is the AC mains voltage prior to application of the test level.			

Table 13-8: Electromagnetic Immunity - Life Supporting Functions

Immunity Test	IEC 60601 Test Level	Compliance Level	Electromagnetic Environment - Guidance
			Portable and mobile RF communications equipment should be used no closer to any part of the HeartStart XL, including cables, than the recommended separation distance calculated from the equation applicable to the frequency of the transmitter.
Conducted RF IEC 61000-4-6	3 Vrms 150 kHz to 80 MHz outside ISM bands ^a	3 Vrms	Recommended Separation Distance $d = 1.2\sqrt{P}$
	10 Vrms 150 kHz to 80 MHz in ISM bands ^a	10 Vrms	Recommended Separation Distance $d = 1.2\sqrt{P}$

Immunity Test	IEC 60601 Test Level	Compliance Level	Electromagnetic Environment - Guidance
Radiated RF IEC 61000-4-3	10 V/m 80 MHz to 2.5 GHz	10 V/m	$d = 1.2\sqrt{P}$ 80 MHz to 800 MHz $d = 2.3\sqrt{P}$ 800 MHz to 2.5GHz where P is the maximum output power rating of the transmitter in watts (W) according to the transmitter's specified output power and d is the recommended separation distance in meters (m). ^b Field strengths from fixed RF transmitters, as determined by an electromagnetic site survey, ^c should be less than the compliance level in each frequency range. ^d Interference may occur in the vicinity of equipment marked with the following symbol: 
<p>At 80 MHz and 800 MHz, the higher frequency range applies. These guidelines may not apply in all situations. Electromagnetic propagation is affected by absorption and reflection from structures, objects and people.</p>			

Immunity Test	IEC 60601 Test Level	Compliance Level	Electromagnetic Environment - Guidance
<p>^a The ISM (industrial, scientific, and medical) bands between 150 kHz and 80 MHz are 6.765 MHz to 6.795 MHz; 13.553 MHz to 13.567 MHz and 26.957 MHz to 27.283 MHz; and 40.66 MHz to 40.70 MHz.</p> <p>^b The compliance levels in the ISM frequency bands between 150 kHz and 80 MHz and in the frequency range 80 MHz to 2.5 GHz are intended to decrease the likelihood that mobile/portable communications equipment could cause interference if it is inadvertently brought into patient areas. For this reason, an additional factor of 10/3 is used in calculating the recommended separation distance for transmitters in these frequency ranges.</p> <p>^c Field strengths from fixed transmitters, such as base stations for radio (cellular/cordless) telephones and land mobile radios, amateur radio, AM and FM radio broadcast and TV broadcast cannot be predicted theoretically with accuracy. To assess the electromagnetic environment due to fixed RF transmitters, an electromagnetic site survey should be considered. If the measured field strength in the location in which the HeartStart XL is used exceeds the applicable RF compliance level above, the HeartStart XL should be observed to verify normal operation. If abnormal performance is observed, additional measures may be necessary, such as re-orienting or relocating the HeartStart XL.</p> <p>^d Over the frequency range 150 kHz to 80 MHz, field strengths should be less than 3 V/m.</p>			

Table 13-9: Electromagnetic Immunity - Nonlife Supporting Functions

Immunity Test	IEC 60601 Test Level	Compliance Level	Electromagnetic Environment - Guidance
			Portable and mobile RF communications equipment should be used no closer to any part of the HeartStart XL, including cables, than the recommended separation distance calculated from the equation applicable to the frequency of the transmitter.
Conducted RF IEC 61000-4-6	3 Vrms 150 kHz to 80 MHz	3 Vrms	Recommended Separation Distance $d = 1.2\sqrt{P}$
Radiated RF IEC 61000-4-3	3 V/m 80 MHz to 2.5 GHz	3 V/m	$d = 1.2\sqrt{P}$ 80 MHz to 800 MHz $d = 2.3\sqrt{P}$ 800 MHz to 2.5 GHz where P is the maximum output power rating of the transmitter in watts (W) according to the transmitter's specified output power and d is the recommended separation distance in meters (m). Field strengths from fixed RF transmitters, as determined by an electromagnetic site survey, ^a should be less than the compliance level in each frequency range. ^b Interference may occur in the vicinity of equipment marked with the following symbol: 

Immunity Test	IEC 60601 Test Level	Compliance Level	Electromagnetic Environment - Guidance
<p>At 80 MHz and 800 MHz, the higher frequency range applies. These guidelines may not apply in all situations. Electromagnetic propagation is affected by absorption and reflection from structures, objects and people.</p>			
<p>^a Field strengths from fixed transmitters, such as base stations for radio (cellular/cordless) telephones and land mobile radios, amateur radio, AM and FM radio broadcast and TV broadcast cannot be predicted theoretically with accuracy. To assess the electromagnetic environment due to fixed RF transmitters, an electromagnetic site survey should be considered. If the measured field strength in the location in which the HeartStart XL is used exceeds the applicable RF compliance level above, the HeartStart XL should be observed to verify normal operation. If abnormal performance is observed, additional measures may be necessary, such as re-orienting or relocating the HeartStart XL.</p> <p>^b Over the frequency range 150 kHz to 80 MHz, field strengths should be less than 3 V/m.</p>			

Recommended Separation Distances

The HeartStart XL is intended for use in an electromagnetic environment in which radiated RF disturbances are controlled. The customer or the user of the HeartStart XL can help prevent electromagnetic interference by maintaining a minimum distance between portable and mobile RF communications equipment (transmitters) and the HeartStart XL as recommended below, according to the maximum output power of the communications equipment.

Table 13-10: Recommended Separation Distances

Rated Maximum Output Power of Transmitter (W)	Separation Distance According to Frequency of Transmitter (m)	
	150 kHz to 800 MHz $d = 1.2\sqrt{P}$	800 MHz to 2.5 GHz $d = 2.3\sqrt{P}$
0.01	0.1 m	0.2 m
0.1	0.4 m	0.7 m
1	1.2 m	2.3 m
10	4 m	7 m
100	12 m	23 m
<p>For transmitters rated at a maximum output power not listed above, the recommended separation distance d in meters (m) can be determined using the equation applicable to the frequency of the transmitter, where P is the maximum output power rating of the transmitter in watts (W) according to the transmitter's manufacturer.</p> <p>At 80 MHz and 800 MHz, the higher frequency range applies.</p> <p>These guidelines may not apply in all situations. Electromagnetic propagation is affected by absorption and reflection from structures, objects and people.</p>		

AED Superstore[®]
an **ALLIED 100**[™] company

Index

- A**
- AC Power Module. See Power modules
 - Accessories
 - ordering 11-18, 13-28
 - AED Mode 3-1
 - configuring 3-5
 - CPR 3-15
 - defibrillation process 3-8
 - display 2-7, 2-8
 - ECG monitoring 4-2
 - enabling from Manual Mode 6-12
 - events recorded 9-4
 - Events Summary 9-3
 - indications for use 1-5
 - overview 1-2, 3-2, 3-3
 - pausing 3-15, 3-18
 - preparation 3-6
 - re-analysis 3-14
 - rhythm monitoring 3-17
 - training required 1-4
 - troubleshooting 3-21
 - Alarms
 - heart rate 4-10, 8-3
 - interruption of power 9-6
 - SpO2 monitoring 5-9
 - symbols 13-16
 - Analysis 3-10
 - AED Mode 3-10
 - re-analysis 3-14
 - settings 3-5
 - Artifact Detected message 3-21
 - Asynchronous defibrillation 1-6
 - Asystole 1-6
 - pacing 1-7
 - Attach Leads 12-5
 - Attach Paddles 12-5
 - Attach Pads Cable message 12-2
 - Attach Pads message 12-5
 - Audiovisual controls 2-4
 - Automatic Re-analysis 3-14
 - setting 3-5, 10-11
- B**
- Batteries 1-3
 - charging 11-9
 - checking 11-6
 - inserting and removing 2-10
 - maintenance 11-8
 - ordering 11-22
 - specifications 11-12
 - storing and discarding 11-12
 - symbols 13-16
 - troubleshooting 12-2
 - See also Power supply
 - Battery Capacity Test 11-10
 - Bradycardia 1-7
- C**
- Cables
 - checking 11-6
 - cleaning 11-16, 11-17
 - ECG 4-3, 10-6
 - Paddles Adapter 11-20
 - SpO2 5-7, 5-12, 10-5
 - Cal Pulse 2-4
 - Check Patient Timer
 - setting 10-11
 - Check Printer message 12-6
-

- Cleaning
 - HeartStart XL 11-15
 - pads, electrodes & cables 11-16, 11-17
 - printer printhead 11-15
- Clinical Performance 13-21, 13-23
- Configuration 10-7
 - accessing menu 10-7
 - AED Mode 3-5
 - Automatic Re-analysis 3-5
 - default 10-15
 - Device Initiated Analysis 3-5
 - ECG filters 10-13
 - heart rate alarm 4-10
 - list of configurable items 10-8
 - modifying 10-15
 - printing settings 10-16
 - Rhythm Monitoring 3-5, 3-17
 - saving and loading from Data Card 10-16
- Configuration Lost message 12-2
- Continued Use feature 9-6
- CPR 3-15
- D**
 - Data Card 2-14
 - downloading and erasing information 9-2
 - inserting and removing 2-15
 - ordering 11-21
 - saving and loading settings 10-16
 - troubleshooting 12-2, 12-6
 - Date 10-8, 12-8
 - DC Power Module. See Power modules
 - Default settings. See Configuration
 - Defib Disarmed message 12-5
 - Defib electrode pads. See Pads
 - Defibrillation 1-2
 - AED Mode 3-4, 3-8
 - defined 1-4
 - Manual Mode 6-9
 - pacing 8-8
 - Defibrillation controls 2-4
- Defibrillator. See HeartStart XL
- Device Initiated Analysis settings 3-5, 10-11
- Display
 - AED Mode 2-7
 - layout 2-6
 - troubleshooting 12-8
- E**
 - ECG analysis. See Analysis
 - ECG cables
 - cleaning 11-17
 - connecting 10-6
 - ordering 11-21
 - See also Cables
 - ECG electrodes. See Electrodes
 - ECG Fault message 12-2
 - ECG Filter Settings 10-13
 - ECG monitoring 4-2
 - electrodes 4-4, 10-9
 - events recorded 9-4
 - heart rate alarm 4-10
 - leads 4-8
 - settings 10-9, 10-13
 - signal quality 4-12
 - size 4-11
 - synchronized
 - cardioversion 7-2
 - troubleshooting 4-12

Index

Electrode pads. See Pads

Electrodes

- applying 4-4
- checking 11-3
- cleaning 11-16, 11-17
- ordering 11-21
- placing 3-6, 4-5
- settings 10-9

Electromagnetic

- compatibility (EMC)
13-32, 13-35

Environmental

- specifications
- safety precautions 13-30

Erratic spiking 1-5

Event Review 2-14, 9-2

Event Summary 9-2

- events recorded 9-4
- information included 9-7
- interruption of power 9-6
- marking events 9-3
- printing 9-7, 9-9

External paddles

- using in Manual Mode 6-3

F

Failure message 8-9

H

Heart rate alarm

- disabling 4-11
- events recorded 9-4
- interruption of power 9-6
- pacing 8-3
- settings 4-10
- See also ECG
- monitoring

heart rhythms

- non-shockable 13-8
- shockable 13-8

HeartStart XL 1-2

- assessment of 1-4
- cleaning 11-15
- configuring 10-7
- operational checks 11-3, 11-4, 11-5
- safety precautions 13-29

specifications 13-2

symbols 13-16

training required 1-4

troubleshooting 12-7

HR alarm. See Heart rate alarm

Hypothermia

- pacing 1-7
- SpO2 monitoring 5-2

I

Incident number. See

Event Summary

Incident Timer 2-7

Incompatible Data Card message 12-6

Indications for use

AED mode 1-5

Manual Mode 1-6

pacing 1-7

SpO2 monitoring 1-8

Internal paddles

(switched)

using in Manual Mode 6-6

Internal paddles

(switchless)

using in Manual Mode 6-8

K

Key Inactive message 3-22, 8-9, 12-6

L

Leads

formation 4-5

Lead Select setting 10-13

selecting 4-8, 7-2, 8-4

troubleshooting 4-12, 8-9, 12-3

Leads Off message 4-12,
8-9, 12-3

Loading
printer paper 11-13
settings from Data
Card 10-16

Low Battery message 12-
2

M

Maintenance
batteries 11-8
cleaning 11-15
operational checks 11-
2
supplies and
accessories 11-18

Manual Mode 6-1
controls 2-5
current charge 6-10
defibrillation process
6-9
delivering shock 6-11
display 2-7
ECG monitoring 4-2
enabling 2-6
energy setting 6-9
Events Summary 9-3
indications for use 1-6
overview 1-2
preparation 6-3, 6-5
returning to AED
Mode 6-12
SpO2 monitoring 5-2
training required 1-4
Marking events 9-3
See also Event
Summary
Messages
defined 2-8
list of 12-2
Momentary messages 2-8
list of 12-5
Monitoring. See ECG
monitoring
Monitoring electrodes.
See Electrodes

Monitoring Rhythm. See
Rhythm Monitoring
Multifunction defib
electrode pads. See
Pads

N

Nellcor sensors 5-4
No Data Card Present
message 12-6
No Paddles Connected
message 12-3
No Pads message 12-3
No Shock Advised Timer
3-20, 10-12
No Shock Delivered
message 3-22, 12-6
Non Pulsatile message 5-
11
Noninvasive
transcutaneous
pacing. See Pacing
non-shockable rhythms
13-8

Index

- O**
- Operational checks
 - every month 11-3
 - every shift 11-3
 - using external paddles 11-4
 - using internal paddles 11-7
 - using pads 11-5
 - Output Low message 8-9
 - Oxygen saturation. See SpO2 monitoring
- P**
- Pace Pulse Markers 10-9
 - Pacemakers
 - AED therapy 1-5
 - heart rate alarm 4-10
 - Pacing 8-1
 - defibrillation 8-8
 - defined 1-7, 8-1
 - demand v. fixed mode 8-2, 8-6, 8-8
 - ECG monitoring 8-3
 - events recorded 9-5
 - function buttons 2-6
 - indications for use 1-7
 - messages 12-3
 - preparation 8-3
 - procedure 8-5
 - selecting leads 8-3, 8-9
 - system messages 8-9
 - troubleshooting 8-7, 8-9, 12-6
 - Paddles
 - Attach Paddles 12-5
 - using external paddles in Manual Mode 6-3
 - using switched
 - internal paddles in Manual Mode 6-6
 - using switchless
 - internal paddles in Manual Mode 6-8
 - Pads
 - applying 3-9, 13-28, 13-29
 - cleaning 11-16, 11-17
 - ECG monitoring 4-2, 4-12
 - events recorded 9-4
 - safety precautions 13-28
 - troubleshooting 3-21, 12-3, 12-5
 - using in Manual Mode 6-5
 - Pads Cable Off message 3-21, 12-3
 - Pads cables
 - See Cables
 - Pads Off message 3-21, 4-12, 12-3
 - Paper. See Printer paper
 - Patient information. See Data Card
 - Pausing
 - AED Mode 3-15, 3-18
 - settings 10-12
 - Post 10-12
 - Post Shock CPR Timer 3-20, 10-12

- Power modules
 - electromagnetic compatibility 13-32, 13-35
- Power supply
 - events recorded 9-4
 - interruption of power 9-6
 - overview 2-9
 - troubleshooting 12-7
 - See also Batteries
- Precautions 13-28
 - asystole 1-6
 - batteries 11-12
 - defibrillation current (shock) 3-14
 - ECG analysis 3-11
 - electrodes 4-4
 - electromagnetic compatibility 13-32, 13-35
 - heart rate alarms 4-10, 8-3
 - pacemakers 1-5, 4-10
 - rhythm monitoring 3-17
 - safety symbols 13-16
 - sensors 5-6, 5-10
 - SpO2 alarm 5-9
 - SpO2 monitoring 5-2
- Print strip
 - events recorded 9-5
 - settings 10-9
 - See also Event Summary
- Printer
 - checking 11-6
 - cleaning printhead 11-15
- Printer paper
 - loading 11-13
 - ordering 11-19
 - troubleshooting 12-6
- Printing
 - controls 2-5
 - Event Summary 9-7
 - events automatically 9-9
 - settings 10-16
- Pulse, checking 3-15, 5-11
- Pulse oximetry
 - defined 1-7, 5-2
 - described 5-3
 - See also SpO2 monitoring
- Q**
 - QRS beeper 4-10
 - settings 10-10
 - troubleshooting 4-13
- R**
 - Radio frequency (RF) interference 13-32, 13-35
 - Re-analysis 3-5, 3-14
 - Recording events. See Event Summary
 - RF interference 13-32, 13-35
 - Rhythm Monitoring 3-5, 3-17
 - AED Mode 3-10
 - configuring 3-17, 10-11
 - events recorded 9-4
- S**
 - Safety precautions. See Precautions
 - Saving settings to Data Card 10-16
 - Select Leads 12-5
 - Semi-Automatic External Defibrillation. See AED Mode

Index

- Sensors 5-4
 - applying 5-6
 - caring for 5-10
 - cleaning 11-17
 - ordering 11-21
 - selecting 5-4
 - troubleshooting 5-12,
12-4
- Service 12-10
- Settings. See Configuration
- Shock
 - AED Mode 3-13
 - events recorded 9-4
 - settings 10-11
 - troubleshooting 3-22,
12-6
- Shock Series Timer 10-11
- shockable rhythms 13-8
- Softkeys
 - See also Controls
- SP02 Non Pulsatile message 12-4
- Specifications
 - defibrillator 13-2
 - specifications
 - ECG analysis
 - performance 13-8
 - non-shockable rhythm
 - specificity 13-8
 - shockable rhythm
 - sensitivity 13-8
- SpO2 alarm 5-9
- SpO2 cable
 - cleaning 11-17
 - connecting 10-5
 - ordering 11-21
- SpO2 Cable Off message 5-12
- SpO2 Light Interf message 5-12
- SpO2 Low Signal message 5-11
- SpO2 monitoring 5-2
 - cable connection 5-7
 - defined 1-7, 5-2
 - discontinuing 5-10
 - events recorded 9-5
 - inaccuracies 1-7
 - noisy signal 5-11
 - procedure 5-8
 - process 5-3
 - sensors, applying 5-6
 - sensors, caring for 5-10, 11-17
 - settings 10-13
 - troubleshooting 5-11,
12-4
- SpO2 Noisy Signal message 5-11
- SpO2 Sensor Fail message 5-12
- Stop message 8-9
- Stop Pacer message 12-6
- Strip. See Print strip
- Supplies
 - ordering 11-18
- Symbols, list of 13-16
- Sync After Shock setting 10-13
- Sync control 2-6

Synchronized
 cardioversion 7-1
 disabling Sync Mode
 7-8
 enabling 2-6
 selecting leads 7-1
System messages 2-8
 list of 12-2
System tests. See
 Maintenance

T

Telephone assistance 12-
 10
Thermal Array Printer.
 See Printer
Time 10-8, 12-8
Training required 1-4, 13-
 28
Troubleshooting 12-1
 AED Mode 3-21
 Data Card 12-6
 ECG monitoring 4-12
 pacing 8-7, 8-9, 12-3,
 12-6
 SpO2 monitoring 5-
 11, 12-4
 time and date 12-8

U

User messages 2-8

V

Ventricular fibrillation
 manual defibrillation
 1-6
 pacing 1-7
Ventricular tachycardia 1-
 6

W

Warnings. See
 Precautions
Web site 12-10

AMR Superstore®
an ALLIED 100™ company

AED Superstore[®]
an **ALLIED 100**[™] company

PHILIPS

HEARTSTART XL

M4735-91900
Edition 7
Copyright © 2006
Koninklijke Philips Electronics N.V.
Printed in the U.S.A. April, 2006

