

Contents

Introduction 3

Type overview 4

Programme 5

Indication of programme sequence 5

Options and settings 6

Variant settings 8

Test programme 9

Troubleshooting 11

Components and measurement values 13

Technical data 15

Circuit diagram 16

Timer diagram TD25 17

This service manual describes tumble dryer type TD25 and is a supplement to the general service manual for the 700 series.



Revision history

Revision	Date	Description	Initials
02	2008-04-28	TD25.1 can be specified with display.	MW
		Delayed Start 1-24h implemented W723	MW

Introduction

You are holding the service manual for the TD25 generation of tumble dryer.

There are two types of tumble dryer in the TD25 series: TD25.1 and TD25.3. The following page presents the different versions, to help you identify the machine types. The variants are named differently from market to market. The type designation is the most important factor for identifying the machine type. The type designation can be found on the machine plate, which is located inside the machine's door.

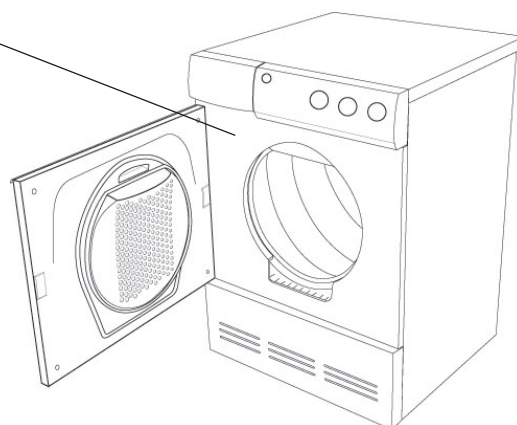
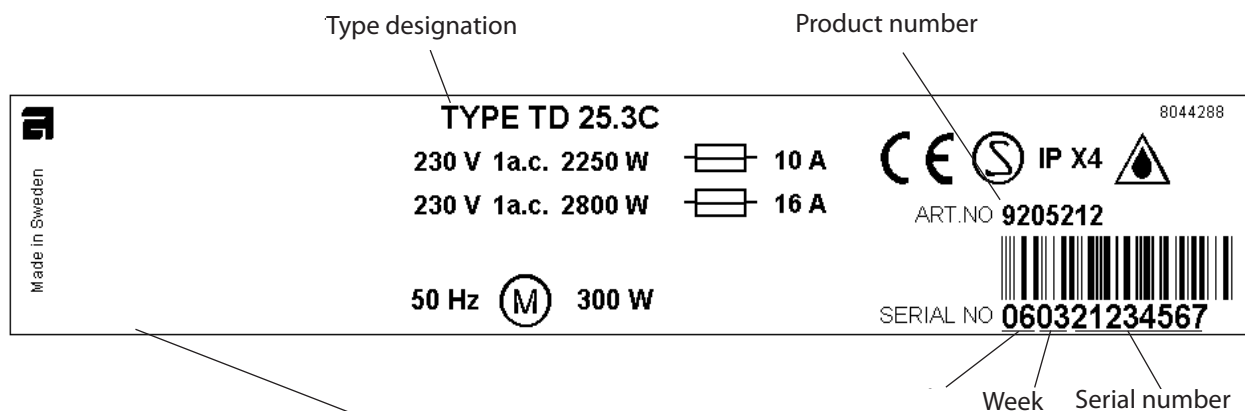

It should be easy to service a tumble dryer. It is important that you, as a service technician, are given the conditions to be able to carry out work in an efficient and satisfactory way. Our hope is that this service manual is a useful tool for your daily work.

Type overview

TD25.1 This type can be specified with display



- Programme: 4 automatic programmes (For further information, see timer diagram at the foot of the document.)
- Options: None.
- Settings: Temperature.

TD25.3

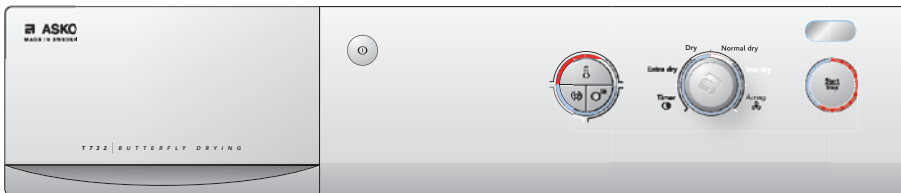

- Programme: 4 automatic programmes, 1 timer programme and 1 airing programme (For further information, see the timer diagram at the foot of the document.)
- Options: 2 (designations differ depending on the market, see directions for use.)
- Settings: Temperature.
Delayed Start 1-24h as of week 723

TD25.3

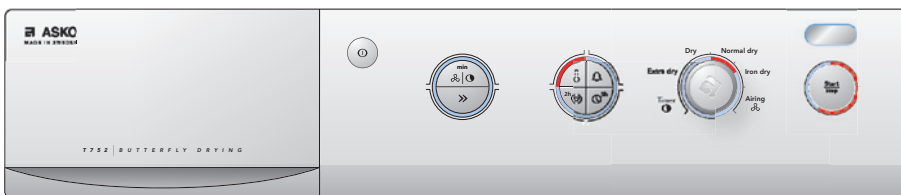

- Programme: 4 automatic programmes, 1 timer programme and 1 airing programme (For further information, see the timer diagram at the foot of the document.)
- Options: 4 (designations differ depending on the market, see directions for use.)
- Settings: Temperature.
Delayed Start 1-24h as of week 723

Programme

When using tumble dryer TD25 it is possible to choose between four different programmes that automatically sense how damp the washing is. The machine dries to different levels depending on which of the four programmes has been selected on the front panel. The machine only has one automatic programme that runs for different lengths of time (and therefore dries to different levels) depending on which of the four programmes has been selected on the front panel. The automatic programme runs for a maximum of 3 hours.

The machine has a Timer programme that runs for the time that is set (20 minutes – 2 hours), regardless of whether the washing is dry or not.

The machine has an Airing programme that blows cold air for the time that is set (5 minutes – 2 hours).

Indication of programme sequence

During the programme, the current programme sequence is indicated by a fixed light in the LEDs around the start/stop button (see the image).

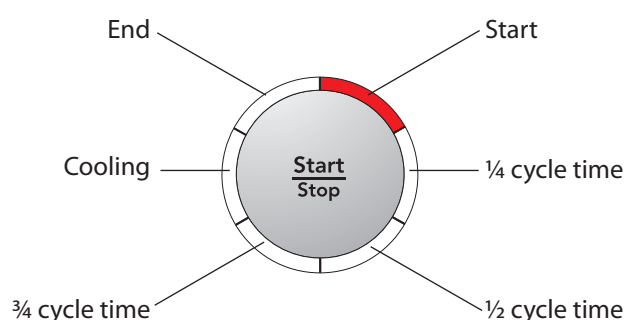

The cycle time is calculated during the start sequence.

Note!

If the door is opened whilst a programme is in operation, the programme will be interrupted and return to the start position.

Options and settings

Options



Means that the drum will rotate 3 seconds per minute for 2 hours once the drying programme has finished. The option prevents the fabrics from remaining in the same position and becoming creased, which is good if you are unable to remove them immediately after tumble-drying has finished.

If the Buzzer is also activated

a signal will sound each time the drum rotates, as a reminder that the drying programme has finished.



Machines without display

Delays the start of the machine by 5 hours.

Activated by pressing the Time-delayed start button and then the start/stop button.



The number 5 in the display indicates that Time-delayed start has been activated. The number of hours to start is displayed with a countdown from 5 to 1.

Deactivated by pressing the start/stop button for 3 seconds until the red field next to Time-delayed start goes out.



Machines with display

Start machine with 5 hour delay

Activated by pressing the "Delayed Start" button and then the Start/Stop button

The number 5 is shown on the display to indicate that Delayed Start is activated.

The number of hours to start is shown in a countdown from 5 to 1.



1 - 24h delayed start successively from week 723

Start machine with 1-24 hour delay. Activated by pressing the Delayed Start option button as many times as the number of hours' delay desired before starting (1-24 h) and then pressing the Start/Stop button. The number of hours to delayed start is shown on the display. The number of hours to start is shown in a countdown that decreases 1 hour at a time.



This means that a buzzer will sound for 3 seconds when the drying programme finishes.



Reduces cooling to 3 minutes.

Cannot be used in the Airing programme.

(In "normal cases" when Short cooling is deselected, the machine cools for 15 minutes.)

Settings

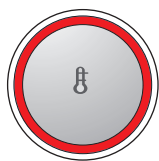

Possible to set to a high or low temperature.

	Normal temperature	Low temperature
Airing dryer:	57°C	43°C
Condenser dryer:	73°C	50°C

Temperature setting cannot be carried out in the airing programme.

Variant settings

The following version settings can be made after replacing the control unit.

S = Push button
L = LED

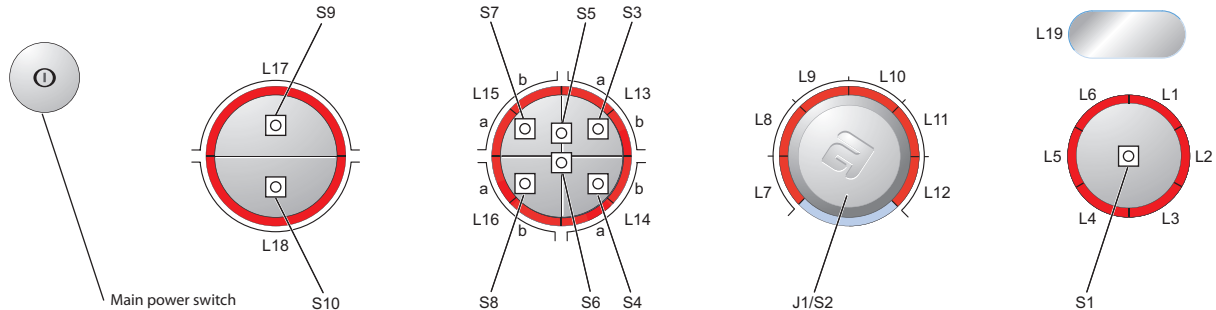

Total reset

1. Hold the start/stop button (S1) in, start the machine by pressing the main power switch and keep the start/stop button depressed until one of the LEDs on the panel lights.

Buzzer

1. Hold S5 or S6 pressed in, start the machine by pressing the main power switch and keep S5/S6 pressed in until L1, L13 and L15 start to flash.
2. Change the setting by pressing J1/S2. L8 lights when the buzzer is activated.
3. Confirm your selection by pressing the start/stop button (S1).

10 A or 16 A

1. Hold the start/stop button (S1) in, start the machine by pressing the main power switch and keep the start/stop button depressed until one of the LEDs on the panel lights.
2. Press the start/stop button (S1) 5 times. L1 starts to flash.
3. Change the setting by pressing S2 or J1. L8 lights when 16 A is activated.
4. Confirm your selection by pressing the start/stop button (S1).

Adjusting drying time

1. Hold the start/stop button (S1) in, start the machine by pressing the main power switch and keep the start/stop button depressed until one of the LEDs on the panel lights.
2. Press the start/stop button (S1) for a further 5 seconds until L1 starts to flash.
3. Change the setting by pressing S2 or J1. The selected setting is indicated as follows:

No adjustment:	no LED:
+ 5 minutes:	L8
+10 minutes:	L9
+15 minutes:	L10
+20 minutes:	L11

4. Confirm your selection by pressing the start/stop button (S1).

The control unit detects and adjusts automatically to the panel layout and machine model when the option buttons are pressed several times.

Test programme

The entire test programme is run in a sequence as follows. You can cancel the test programme at any time during the programme by opening the door or pressing the main power switch.

S = Push button
L = LED

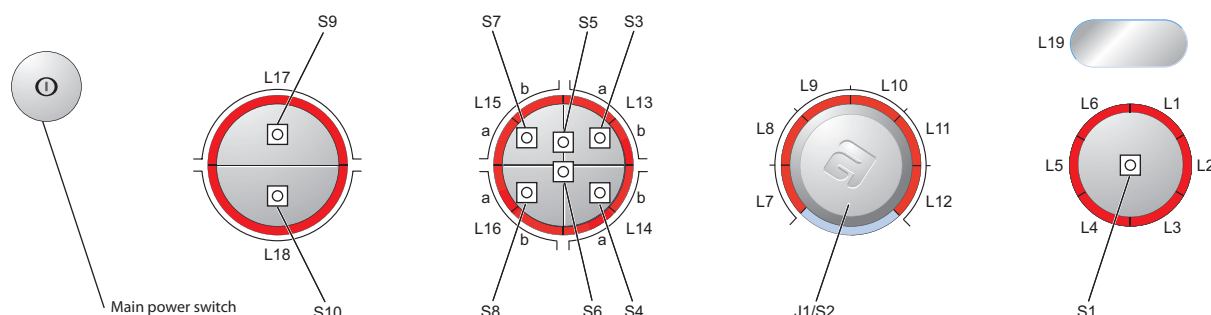

Total reset of programmes

To access the test programme, total reset of the programme must be carried out as follows:

1. Cancel the current programme and switch off the machine by pressing the main power switch.
2. Hold the start/stop button (S1) in and start the machine by pressing the main power switch.
3. Check that any of the LEDs around the programme knob (L7 – L12) lights. This indicates that total reset has been carried out.

Starting the test programme

4. Press button S7 (left-hand button on divided options button) and keep it pressed for approximately 20 seconds.

Note! This must be done within 3 seconds after carrying out total reset.

- All LEDs light up continuously. This indicates that the test programme has been activated.

Testing the motor and condensing waterpump

5. Press the start/stop button (S1).
 - LED L6 lights up and is lit for the entire test programme.
 - Condenser dryer: LED L8 lights up.
 - Airing dryer: LED L7 lights up.
 - The motor and condensing waterpump starts.
 - Water fills the housing for the water tank until the machine stops (check that the switch for condensation water works).
6. Press the start/stop button (S1) to start the motor and pump out the condensation water.
 - LED L 2 lights up and is lit for the remainder of the test programme.

Indication of faults:

Fault indication/symptom	Cause
The condensing waterpump pumps until S1 is reactivated and L7 lights up (applies to airing dryers).	The rear thermistor does not have any contact or is damaged.
The motor will not start.	Motor or cable fault
The condensing water-pump does not start.	Switch or cable fault

Testing the element, thermistor and temperature regulation

7. Press the start/stop button (S1).
 - LED L3 starts to flash and the large element loop activates.
8. Press the start/stop button (S1).
 - LED L3 lights continuously and the machine runs heat regulation for 15 minutes.
 - LED L4 starts flashing, which means that temperature regulation is finished.
 - Cooling runs for 5 minutes.
 - The machine stops.

Indication of faults:	
Fault indication/symptom	Cause
The element does not start.	Element or cable fault
The programme stops. F9 is shown in the display (applies to machines with a display).	The front thermistor is not connected.

Testing the interval time and buzzer tone

9. Press the start/stop button (S1).
 - LED L4 lights up.
 - The motor starts and runs at intervals at the same time as a buzzer sounds.

Indication of faults:	
Fault indication/symptom	Cause
No buzzer tone	Fault in control







Cancel the test programme.

10. Press the start/stop button (S1).
 - The test programme stops and "End" is shown in the display (applies to machines with a display).

Troubleshooting

Fault indications

The following faults are indicated by a flashing red light in the start/stop button LEDs and as a trouble code on the display (display not available on all machine versions).

Fault indication			Cause	Action
Display	LEDs (flashing)	Meaning		
		Overfilling The machine stops. (applies to condenser dryers)	The condensation water tank is full.	Check if the customer has: <ul style="list-style-type: none"> Emptied the tank and restarted the machine
			Condensing waterpump or hoses blocked.	<ul style="list-style-type: none"> Clean hoses and check voltage and resistance in the drain pump.
			Float/float switch is defective.	<ul style="list-style-type: none"> Check that the float has not got "stuck" and check the function of the micro-switch.
			The control unit is faulty (the pump does not start).	<ul style="list-style-type: none"> Replace control unit.
		Maximum permitted programme time The machine stops after 3 hours.	The washing has been spun at too low a speed, i.e. less than 800 rpm.	Check if the customer has: <ul style="list-style-type: none"> Tried spinning at a higher speed
			The control unit did not have chance to reset, but added the time to the next drying cycle.	Check if the customer has: <ul style="list-style-type: none"> Has the machine switched off for 30 minutes before restarting
			High ambient temperature combined with low element output and low drying temperature leads to condensation formation.	Check if the customer has: <ul style="list-style-type: none"> Attempted to select another programme Good ventilation in the room
			Poor condensation due to blocked external air	<ul style="list-style-type: none"> Ensure that the external air has free passage.
			Defective thermistor.	<ul style="list-style-type: none"> Replace the thermistor.
			Defective control unit	<ul style="list-style-type: none"> Replace control unit.
	 (no indication in LEDs)	Thermistor fault The machine stops.	The front thermistor is defective or the control is not in contact with it.	<ul style="list-style-type: none"> Replace the thermistor.

After carrying out corrective actions as above, reset the fault indications by switching off the machine using the main power switch.

Other faults

Fault symptom	Cause	Action
The machine will not start.	The outer door is not properly closed.	<ul style="list-style-type: none"> Check that the door pin is activating the door switch.
	The machine is not supplied with power.	<ul style="list-style-type: none"> Check the fuses and connections.
The machine stops.	The automatic overheating protection has tripped.	<p>Check if the customer has:</p> <ul style="list-style-type: none"> Opened the door and cleaned the filter and condenser unit Left the door open long enough for the overheating protection to be reset and the display and LEDs to light up Attempted to restart the programme <p>Service action:</p> <ul style="list-style-type: none"> Clean internal fan wheel, condenser, air ducts and element. Check the seals.
	The overheat protection in the motor has been tripped.	<ul style="list-style-type: none"> Clean and check the motor. If necessary, replace the motor.
	Defective control unit	<ul style="list-style-type: none"> Replace control unit.
The washing does not get dry.	Air leakage at the door seals is affecting the drying results.	<ul style="list-style-type: none"> Check the sealing strips.
	Air leakage around the motor shaft affects the drying result.	<ul style="list-style-type: none"> Check the seal around the motor shaft.
	Defective rear thermistor	<ul style="list-style-type: none"> Replace the thermistor.
	Defective control unit	<ul style="list-style-type: none"> Replace control unit.
Drying is uneven.	Mixing of various types of items can lead to uneven drying results.	<p>Customer information:</p> <ul style="list-style-type: none"> Check that different types of items are not mixed in the same machine. Remove the dry items.
	How full the machine is affects the drying results.	<p>Customer information:</p> <ul style="list-style-type: none"> Check that the machine is not overfilled. Remove some of the washing if necessary.
Tumble-drying takes too long.	The lint filter is blocked.	<p>Customer information:</p> <ul style="list-style-type: none"> Cleaning the lint filter.
	The condenser unit is blocked.	<p>Customer information:</p> <ul style="list-style-type: none"> Clean the condenser.
	The washing machine's spinning affects drying.	<p>Customer information:</p> <ul style="list-style-type: none"> Spin at a minimum of 800 rpm.
	The machine is in a room with poor ventilation.	<p>Customer information:</p> <ul style="list-style-type: none"> Open doors to adjacent rooms.
	The evacuation hose is too long, blocked or bent.	<p>Customer information:</p> <ul style="list-style-type: none"> Try to make the hose length as short as possible with as gentle bends as possible.

Components and measurement values

Item number	Component	Measurement value	Comments
80 790 43	Motor 50 Hz, 220/240 V	Main winding: 23.8 Ω Auxiliary winding: 28.1 Ω Current: 1.1 A; 270 W; 2850 rpm	
80 814 04	Motor 50 Hz, 220/240 V	Main winding: 22,9 Ω Auxiliary winding: 31 Ω Current: 0,7 A; 150 W; 2850 rpm	ACC motor serial prod W646
80 766 90	Motor 60 Hz, 220/240 V	Main winding: 16,0 Ω Auxiliary winding: 25,5 Ω Current: 0,9 A; 200 W; 3300 rpm A; 200 W; 3300 rpm	The motor is a 2-pin motor and is directly connected to the fan for internal air and gearing for driving the cylinder. The fan for external air is also driven on condenser dryers. All resistance values have tolerances of $\pm 7\%$.
80 814 05	Motor 60 Hz, 220/240 V	Main winding: 22,9 Ω Auxiliary winding: 31,0 Ω Current: 0,8 A; 200 W; 3300 rpm	ACC motor serial prod W648
80 801 19	Capacitor 8 μ F, 400V		The capacitor is mounted on the motor.
80 638 09	Condensing waterpump 25W	111 Ω	
80 762 02	EMC filter with inductor		The filter eliminates interference to and from the machine.
80 762 24	Thermistor	40 – 60 k Ω (at room temperature 20 – 30°C)	The thermistor controls temperature regulation. If the thermistor is short-circuited or detaches from the control unit, the programme is cancelled.
80 792 00	Thermostat (135°C)		The thermostat automatically disconnects the heating loop at too high temperatures.
80 773 85	Thermostat/Overheating protection (150°C automatic)		The thermostat /overheating protection interrupts the programme at too high temperatures.
80 797 37	Thermostat/Overheating protection , 150°C (USA)		The thermostat/overheating protection interrupts the programme at too high temperatures.
80 761 04	Door switch		The front door affects a door switch, which interrupts the programme when the door is opened. If the door has been opened and closed during the programme the machine must be restarted using the start/stop button.
80 761 03	Microswitch float		If both containers are overfilled the programme is interrupted by a float switch located on the lower holder. Overfilling is indicated in the display.

Item number	Component	Measurement value	Comments
	Electrical connection		The machine is delivered as single phase and can be switched between 1950 W, 10 A and 2500 W, 16 A. Adjustment between 1950 W / 10 A and 2500 W / 16 A is carried out using software via buttons.
80 771 30	Control Unit (TD25.1)		The control unit contains microprocessors for controlling programmes, motor, element etc.
80 805 15	Control unit (TD25) with display		The control unit contains microprocessors for controlling programmes, motor, element etc.
80 771 32	Control Unit (TD25..3)		The control unit contains microprocessors for controlling programmes, motor, element etc.
80 762 26	Heating Element 2500W		
80 762 27	Heating Element 3000W		

Technical data

Height:	850 mm
Width:	595 mm
Depth:	585 mm
Weight:	47 kg
Cylinder volume:	111 l
Max. load:	6.0 kg
RPM:	52 rpm
Rated power:	1950 W = 10 A 2500 W = 16 A Adjustment between 10 and 16 A is carried out using software via buttons.
Drying drum material:	Stainless steel
Outer casing material:	Powder-coated and hot-galvanized sheet steel or stainless steel
Set-up:	Stacking or freestanding
Protection class:	IP X4
Minimum drying time normal temperature minutes	
Normal dry	28
Extra dry	53
Minimum drying time low temperature minutes	
Normal dry	43
Extra dry	68

Circuit diagram

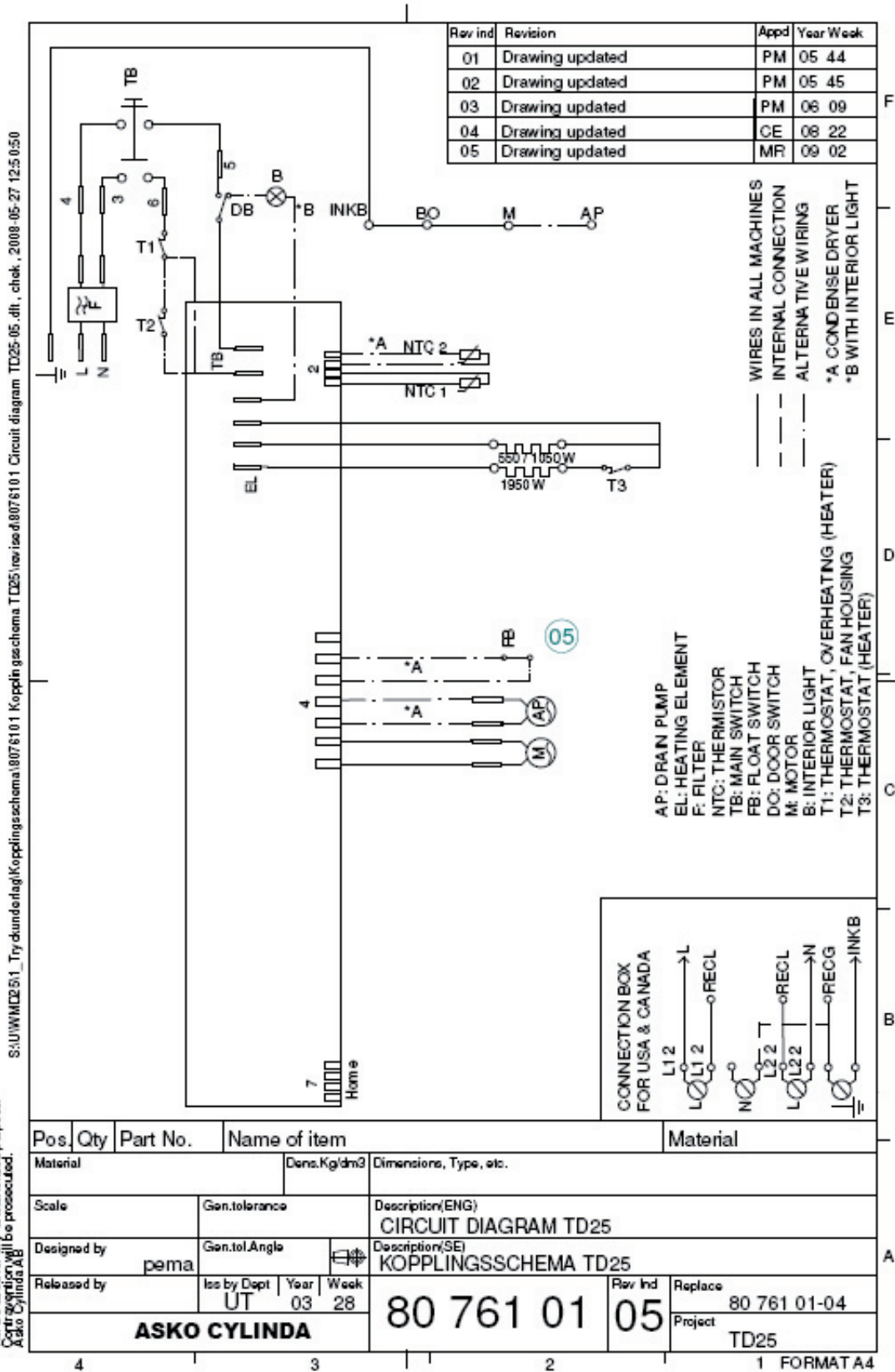

This document must not be copied without our written permission, and the contents may not be used for any unauthorized purposes. Copyright will be prosecuted. Askö, Cyllinda AB

