



Internal Use Only

<http://biz.lgservice.com>

Room Air Conditioner SVC MANUAL(General)

MODEL : General Wall Mounted-Inverter Type

CAUTION

Before Servicing the unit, read the safety precautions in General SVC manual.
Only for authorized service personnel.

CONTENTS

| | | |
|---------------|---|----|
| Part 1 | General Information | |
| 1. | Safety Precautions..... | 4 |
| 2. | Nomenclature | 7 |
| Part 2 | Functions & Controls | |
| 1. | List of Functions & Controls..... | 9 |
| 2. | Basic Mode Controls | 10 |
| 3. | Special Mode Controls | 12 |
| 4. | Utility Functions | 13 |
| 5. | Protection Functions & Controls..... | 16 |
| Part 3 | Test Run | |
| 1. | Check before Test Run | 32 |
| 2. | Test Run Flow chart..... | 33 |
| 3. | Test Run Detail | 34 |
| Part 4 | Trouble Shooting Guide | |
| 1. | 2-Way, 3-Way Valve | 36 |
| 2. | Pumping Down | 37 |
| 3. | Evacuation (All amount of refrigerant leaked) | 38 |
| 4. | Gas Charging (After Evacuation) | 39 |
| 5. | Cycle Troubleshooting Guide | 40 |
| 6. | Electric Parts Troubleshooting Guide..... | 41 |
| 7. | Self-diagnosis Function | 46 |



Part 1 General Information

| | |
|-----------------------------|---|
| 1. Safety Precautions | 4 |
| 2. Nomenclature..... | 7 |



1. Safety Precautions

To prevent injury to the user or other people and property damage, the following instructions must be followed.







- Incorrect operation due to ignoring instruction will cause harm or damage. The seriousness is classified by the following indications.





| | |
|--|---|
|  WARNING | This symbol indicates the possibility of death or serious injury. |
|  CAUTION | This symbol indicates the possibility of injury or damage to properties only. |

- Meanings of symbols used in this manual are as shown below.







| | |
|---|---|
|  | Be sure not to do. |
|  | Be sure to follow the instruction. |
|  | Dangerous Voltage |

1.1 Cautions in Repair





|  WARNING | |
|--|--|
|  | Be sure to disconnect the power cable plug from the plug socket before disassembling the equipment for a repair. Internal components and circuit boards are at main potential when the equipment is connected to the power cables. This high voltage is extremely dangerous and may cause death or severe injury if come in contact with it. |
|  | Do not touch the discharging refrigerant gas during the repair work. The discharging refrigerant gas. The refrigerant gas can cause frostbite. |
|  | Release the refrigerant gas completely at a well-ventilated place first. Otherwise, when the pipe is disconnected, refrigerant gas or refrigerating machine oil discharges and it Can cause injury. |
|  | When the refrigerant gas leaks during work, perform ventilation. If the refrigerant gas comes in contact with a fire, poisonous gas generates. A case of leakage of the refrigerant and the closed room full with gas is dangerous because a shortage of oxygen occurs. Be sure to perform ventilation. |
|  | When removing the front panel or cabinet, execute short-circuit and discharge between high voltage capacitor terminals. If discharge is not executed, an electric shock is caused by high voltage resulting in a death or injury. |
|  | Do not turn the air-conditioner ON or OFF by plugging or unplugging the power plug. There is risk of fire or electrical shock. |





| | |
|---|--|
|  | <p>Do not use a defective or underrated circuit breaker. Use the correctly rated breaker and fuse. Otherwise there is a risk of fire or electric shock.</p> |
|  | <p>Install the panel and the cover of control box securely. Otherwise there is risk of fire or electric shock due to dust, water etc.</p> |
|  | <p>Indoor/outdoor wiring connections must be secured tightly and the cable should be routed properly so that there is no force pulling the cable from the connection terminals. Improper or loose connections can cause heat generation or fire.</p> |
|  | <p>Do not touch, operate, or repair the product with wet hands. Holding the plug by hand when taking out. Otherwise there is risk of electric shock or fire.</p> |

⚠ CAUTION

| | |
|---|--|
|  | <p>Do not turn on the breaker when the front panel and cabinet are removed.</p> |
|  | <p>Be sure to ground the air conditioner with an earthing conductor connected to the earthing terminal.</p> |
|  | <p>Conduct repair works after checking that the refrigerating cycle section has cooled down sufficiently. Otherwise, working on the unit, the hot refrigerating cycle section can cause burns.</p> |
|  | <p>Do not tilt the unit while removing panels. Otherwise, the water inside the unit can spill and wet floor.</p> |
|  | <p>Do not use the welder in a well-ventilated place. Using the welder in an enclosed room can cause oxygen deficiency.</p> |
|  | <p>Be sure to turn off power switch before connecting or disconnecting connector, or parts damage may be occur.</p> |

1.2 Inspections after Repair

| ⚠ WARNING | |
|---|--|
|  | Check to see if the power cable plug is not dirty or loose. If the plug is dusty or loose it can cause an electrical shock or fire. |
|  | Do not use a joined power cable or extension cable, or share the same power outlet with other electrical appliances. otherwise, it can cause an electrical shock, excessive heat generation or fire. |
|  | Do not insert hands or other objects through the air inlet or outlet while the product is operating. There are sharp and moving parts that could cause personal injury. |
|  | Do not block the inlet or outlet of air flow. It may cause product failure |

| ⚠ CAUTION | |
|---|--|
|  | Check to see if the parts are mounted correctly and wires are connected. Improper installation and connections can cause an electric shock or an injury. |
|  | Check whether the installation platform or frame has corroded. Corroded installation platform or frame can cause the unit to fall, resulting in injury. |
|  | Be sure to check whether the earth wire is correctly connected. |
|  | After the work has finished, be sure to do an insulation test to check whether the resistance is 2[Mohm] or more between the charge section and the non-charge metal section (Earth position). If the resistance value is low, a disaster such as a leak or electric shock is caused at user's side. |
|  | Check the drainage of the indoor unit after the repair. If drainage is faulty the water may enter the room and wet floor. |

2. Nomenclature

2.1 Global Model Name

| | | | | | | | | | | |
|----------|----------|---|----------|----------|----------|----------|----------|----------|----------|-----------|
| A | S | - | W | 1 | 2 | 6 | 4 | G | G | 1 |
| 1 | 2 | | 3 | 4 | 5 | 6 | 7 | 8 | 9 | 10 |

| Code | Type | Code of Model | Meaning | | | | | | | | | | | | | | | | | | | | | | | | | | | | | | | | | | | | | | | | | | | | | | |
|-------|---|---------------|---|---|-------|---|------------|---|---------------|---|---------------------|---|----------|---|---------------------------|---|-----------------------------------|---|--|---|---------------|---|----------|---|--------------------------------|---|-----------------------------|---|----------------------------------|---|---------------------------------|---|--|---|--|---|----------------------|---|-----------------------------------|---|--|---|---|---|---|---|-------------|---|---------------|
| 1 | Production Center, Refrigerant | A~Z | L: Chang-won R22 A: Chang-won R410A | | | | | | | | | | | | | | | | | | | | | | | | | | | | | | | | | | | | | | | | | | | | | | |
| 2 | Product Type | A~Z | S: Split Type Air Conditioner | | | | | | | | | | | | | | | | | | | | | | | | | | | | | | | | | | | | | | | | | | | | | | |
| 3 | Cooling/Heating/Inverter | A~Z | C: Cooling Only H: Heat Pump X: C/O + E/Heater Z: H/P + E/Heater V: AC Inverter C/O N: AC Inverter H/P Q: DC Inverter C/O W: DC Inverter H/P | | | | | | | | | | | | | | | | | | | | | | | | | | | | | | | | | | | | | | | | | | | | | | |
| 4, 5 | Capacity | 0~9 | Cooling/Heating Capacity Ex. "09" → 9,000 Btu/h | | | | | | | | | | | | | | | | | | | | | | | | | | | | | | | | | | | | | | | | | | | | | | |
| 6 | Electric Range | 1~9 A~Z | 1: 115V/60Hz 2: 220V/60Hz 3: 208-230V/60Hz 5: 200-220V/50Hz 6: 220-240V/50Hz 7: 110V, 50/60Hz | | | | | | | | | | | | | | | | | | | | | | | | | | | | | | | | | | | | | | | | | | | | | | |
| 7 | Chassis | A~Z | Name of Chassis | | | | | | | | | | | | | | | | | | | | | | | | | | | | | | | | | | | | | | | | | | | | | | |
| 8 | Look | A~Z | Look, Color (Artcool Model) | | | | | | | | | | | | | | | | | | | | | | | | | | | | | | | | | | | | | | | | | | | | | | |
| 9, 10 | Function | A~Z | <table border="1"> <tr><td>A</td><td>Basic</td></tr> <tr><td>B</td><td>Basic+4Way</td></tr> <tr><td>C</td><td>Plasma Filter</td></tr> <tr><td>D</td><td>Plasma Filter+4 Way</td></tr> <tr><td>E</td><td>Tele+LCD</td></tr> <tr><td>F</td><td>Tele+LCD+Nano plasma+4Way</td></tr> <tr><td>G</td><td>NBF F+(A/changeove)+A/clean+Low A</td></tr> <tr><td>H</td><td>NBF F+(A/changeove)+A/clean+4way+Low A</td></tr> <tr><td>I</td><td>Tele+LED+4way</td></tr> <tr><td>J</td><td>Internet</td></tr> <tr><td>K</td><td>Plasma F+4Way+Oxygen generator</td></tr> <tr><td>L</td><td>NBF F+(A/changeove)+A/clean</td></tr> <tr><td>M</td><td>NBF F+(A/changeove)+A/clean+4way</td></tr> <tr><td>N</td><td>NBF F+(A/changeove)+A/clean+PTC</td></tr> <tr><td>P</td><td>NBF F+(A/changeove)+Autoclean+4way+PTC</td></tr> <tr><td>Q</td><td>NBF F+(A/changeove)+A/clean+4way+Low A+PTC</td></tr> <tr><td>R</td><td>Negative ion+A/Clean</td></tr> <tr><td>S</td><td>(Nano)Plasma+Negative ion+A/Clean</td></tr> <tr><td>T</td><td>4way+(Nano)Plasma F+Negative ion+A/Clean</td></tr> <tr><td>U</td><td>Nano Plasma F+4Way+(A/changeove)+A/clean+Oxygen generator</td></tr> <tr><td>V</td><td>4way+(Nano)Plasma F+Negative ion+A/Clean+Oxygen generator</td></tr> <tr><td>W</td><td>Dry contact</td></tr> <tr><td>Y</td><td>Basic + Low A</td></tr> </table> | A | Basic | B | Basic+4Way | C | Plasma Filter | D | Plasma Filter+4 Way | E | Tele+LCD | F | Tele+LCD+Nano plasma+4Way | G | NBF F+(A/changeove)+A/clean+Low A | H | NBF F+(A/changeove)+A/clean+4way+Low A | I | Tele+LED+4way | J | Internet | K | Plasma F+4Way+Oxygen generator | L | NBF F+(A/changeove)+A/clean | M | NBF F+(A/changeove)+A/clean+4way | N | NBF F+(A/changeove)+A/clean+PTC | P | NBF F+(A/changeove)+Autoclean+4way+PTC | Q | NBF F+(A/changeove)+A/clean+4way+Low A+PTC | R | Negative ion+A/Clean | S | (Nano)Plasma+Negative ion+A/Clean | T | 4way+(Nano)Plasma F+Negative ion+A/Clean | U | Nano Plasma F+4Way+(A/changeove)+A/clean+Oxygen generator | V | 4way+(Nano)Plasma F+Negative ion+A/Clean+Oxygen generator | W | Dry contact | Y | Basic + Low A |
| A | Basic | | | | | | | | | | | | | | | | | | | | | | | | | | | | | | | | | | | | | | | | | | | | | | | | |
| B | Basic+4Way | | | | | | | | | | | | | | | | | | | | | | | | | | | | | | | | | | | | | | | | | | | | | | | | |
| C | Plasma Filter | | | | | | | | | | | | | | | | | | | | | | | | | | | | | | | | | | | | | | | | | | | | | | | | |
| D | Plasma Filter+4 Way | | | | | | | | | | | | | | | | | | | | | | | | | | | | | | | | | | | | | | | | | | | | | | | | |
| E | Tele+LCD | | | | | | | | | | | | | | | | | | | | | | | | | | | | | | | | | | | | | | | | | | | | | | | | |
| F | Tele+LCD+Nano plasma+4Way | | | | | | | | | | | | | | | | | | | | | | | | | | | | | | | | | | | | | | | | | | | | | | | | |
| G | NBF F+(A/changeove)+A/clean+Low A | | | | | | | | | | | | | | | | | | | | | | | | | | | | | | | | | | | | | | | | | | | | | | | | |
| H | NBF F+(A/changeove)+A/clean+4way+Low A | | | | | | | | | | | | | | | | | | | | | | | | | | | | | | | | | | | | | | | | | | | | | | | | |
| I | Tele+LED+4way | | | | | | | | | | | | | | | | | | | | | | | | | | | | | | | | | | | | | | | | | | | | | | | | |
| J | Internet | | | | | | | | | | | | | | | | | | | | | | | | | | | | | | | | | | | | | | | | | | | | | | | | |
| K | Plasma F+4Way+Oxygen generator | | | | | | | | | | | | | | | | | | | | | | | | | | | | | | | | | | | | | | | | | | | | | | | | |
| L | NBF F+(A/changeove)+A/clean | | | | | | | | | | | | | | | | | | | | | | | | | | | | | | | | | | | | | | | | | | | | | | | | |
| M | NBF F+(A/changeove)+A/clean+4way | | | | | | | | | | | | | | | | | | | | | | | | | | | | | | | | | | | | | | | | | | | | | | | | |
| N | NBF F+(A/changeove)+A/clean+PTC | | | | | | | | | | | | | | | | | | | | | | | | | | | | | | | | | | | | | | | | | | | | | | | | |
| P | NBF F+(A/changeove)+Autoclean+4way+PTC | | | | | | | | | | | | | | | | | | | | | | | | | | | | | | | | | | | | | | | | | | | | | | | | |
| Q | NBF F+(A/changeove)+A/clean+4way+Low A+PTC | | | | | | | | | | | | | | | | | | | | | | | | | | | | | | | | | | | | | | | | | | | | | | | | |
| R | Negative ion+A/Clean | | | | | | | | | | | | | | | | | | | | | | | | | | | | | | | | | | | | | | | | | | | | | | | | |
| S | (Nano)Plasma+Negative ion+A/Clean | | | | | | | | | | | | | | | | | | | | | | | | | | | | | | | | | | | | | | | | | | | | | | | | |
| T | 4way+(Nano)Plasma F+Negative ion+A/Clean | | | | | | | | | | | | | | | | | | | | | | | | | | | | | | | | | | | | | | | | | | | | | | | | |
| U | Nano Plasma F+4Way+(A/changeove)+A/clean+Oxygen generator | | | | | | | | | | | | | | | | | | | | | | | | | | | | | | | | | | | | | | | | | | | | | | | | |
| V | 4way+(Nano)Plasma F+Negative ion+A/Clean+Oxygen generator | | | | | | | | | | | | | | | | | | | | | | | | | | | | | | | | | | | | | | | | | | | | | | | | |
| W | Dry contact | | | | | | | | | | | | | | | | | | | | | | | | | | | | | | | | | | | | | | | | | | | | | | | | |
| Y | Basic + Low A | | | | | | | | | | | | | | | | | | | | | | | | | | | | | | | | | | | | | | | | | | | | | | | | |
| 11 | Serial No. | 1~9 | LG Model Development Serial No. | | | | | | | | | | | | | | | | | | | | | | | | | | | | | | | | | | | | | | | | | | | | | | |

Part 2 Functions & Controls

| | |
|--|----|
| 1. List of Controls & Functions | 9 |
| 2. Basic Mode Controls..... | 10 |
| 3. Special Mode Controls..... | 12 |
| 4. Utility Functions | 13 |
| 5. Protection Functions & Controls | 16 |

1. List of Functions & Controls

| Category | Function | Description | Remark |
|---------------------------------|---|--|-------------------|
| Basic mode controls | Cooling Mode | Cooling operation | |
| | Heating Mode | Heating operation | |
| | Healthy Dehumidification | Dry operation | |
| | Auto Changeover | Cooling mode is automatically changed to heating mode and vice verse | |
| Special Mode controls | Jet Cool | Powerful cooling mode | |
| | Jet Heat | Powerful heating mode | |
| | Energy saving | Air volume & set temp. are automatically selected for saving energy in cooling mode | Cooling Mode Only |
| Utility Functions | Forced operation | Operation without remote controller | |
| | Auto Clean | After cooling operation, this function makes the evaporator dry | |
| | Air volume control | Indoor Fan speed Control | |
| | Natural Air control | Air volume control Program | |
| | Chaos Swing | Vertical Airflow Direction control | |
| | Sleep mode Auto control | Air volume & set temp. are automatically changed for comfortable sleep | |
| | Auto Restart Function | When power returns after a power failure, Unit restarts in the previous operating mode | |
| Protection Controls & Functions | Five Second Delay (Fan) | For noise prevention | |
| | Two Minutes Stand-by (Comp.) | For overload prevention | |
| | Hot Start | To prevent cold wind blow on heating mode start | |
| | Freeze prevention | Evaporator frost prevention | |
| | Compressor Pre Heating | To protect compressor | |
| | Sump Heater Control | To protect fan from accumulated ice at base panel | 9,12k Model Only |
| | Automatic Defrost | Condenser frost prevention | |
| | Power Relay Control | Over current prevention | |
| | Inverter (with inverter power control) | Modulation of voltage & frequency | |
| | Overheating Protection (Power Module) | To protect power module | |
| | Total Current Control (Over Current Protection) | To protect power device | |
| | DC Peak Control | To protect power module | |
| | Discharge Pipe Temp Control | For overheating protection | |
| | Low Ambient Function | For operation at low temp. | |
| | Oil Return Control | To protect compressor | |
| | Oil Equalizing Control | To protect compressor | |

NOTE: The Exploded View SVC Manual has the particular Function table for each model.

2. Basic Mode Controls

2.1 Cooling Mode

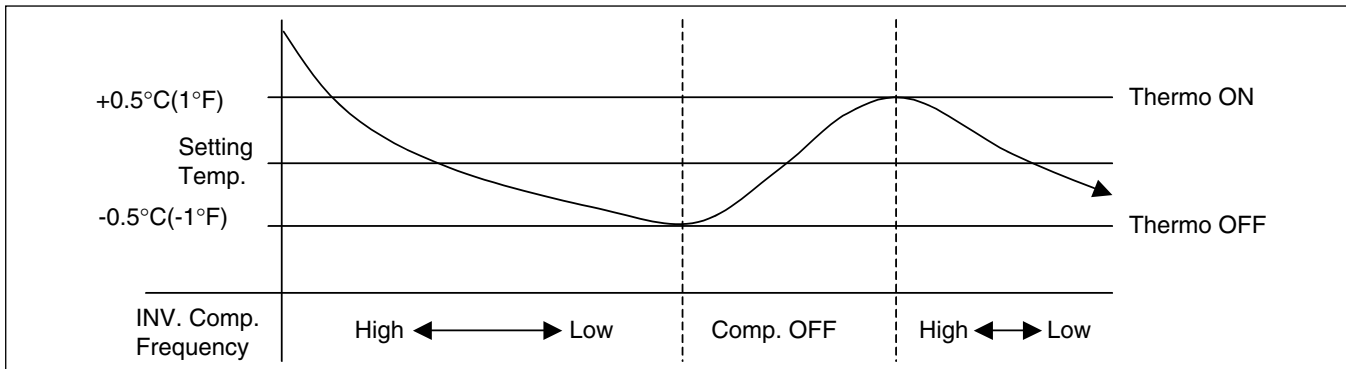

- Operating frequency of compressor depends on the load condition, like the difference between the room temp. and the set temp., frequency restrictions.
- If the compressor operates at some frequency, the operating frequency of compressor cannot be changed within 30 seconds. (not emergency conditions)
- Compressor turned off when
 - intake air temperature is in between $\pm 0.5^{\circ}\text{C}$ ($\pm 1^{\circ}\text{F}$) of the setting temp. limit for three minutes continuously.
 - intake air temperature reaches below 1.0°C (2°F) of the temperature of setting temp..
- Compressors two minutes time delay.
 - After compressor off, the compressor can restart minimum 2 minutes later.

2.2 Heating Mode

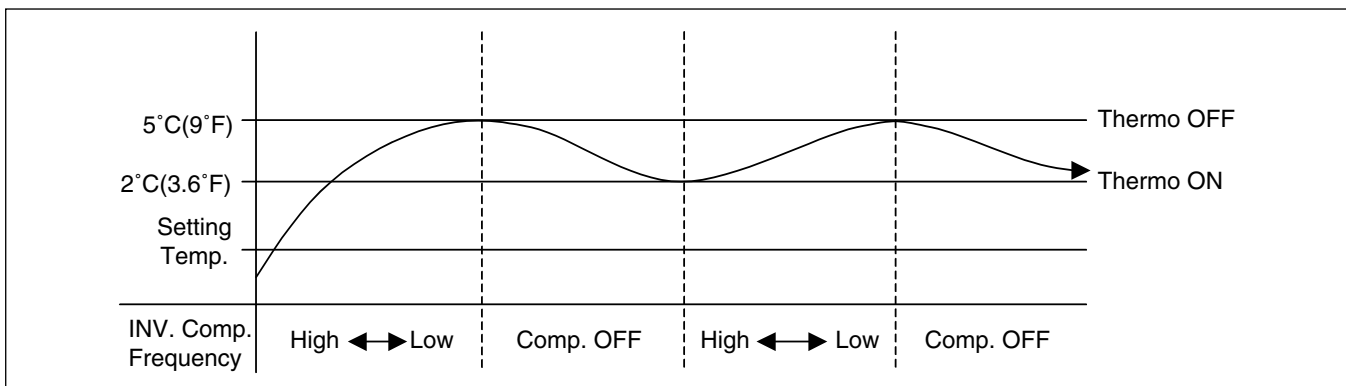

- Operating frequency of compressor depend on the load condition, The difference between the room temp. and set temp., frequency restrictions.
- If compressor operates at some frequency, the operating frequency of compressor cannot be changed within 30 seconds.
- Condition of compressor turned off
 - When intake air temperature reaches $+5^{\circ}\text{C}$ (9°F) above the setting temperature.
- Condition of compressor turned on
 - When intake air temperature reaches $+2^{\circ}\text{C}$ (3.6°F) above the setting temperature.
- * Condition of indoor fan turned off
 - While in compressor on : indoor pipe temp. $< 20^{\circ}\text{C}$ (68°F)
 - While in compressor off : indoor pipe temp. $< 30^{\circ}\text{C}$ (86°F)
- While in defrost control, the indoor and outdoor fans are turned off.
- Compressor 2minutes delay
 - After compressor off, the compressor can restart minimum 2 minutes later.

2.3 Healthy Dehumidification operation

- When the dehumidification operation is set by the remote controller, the intake air temperature is detected and the setting temp. is automatically set according to the intake air temperature.

| Intake air Temp. | Setting Temp. |
|--|---|
| $26^{\circ}\text{C}(78.8^{\circ}\text{F}) \leq \text{intake air temp.}$ | $25^{\circ}\text{C}(77^{\circ}\text{F})$ |
| $24^{\circ}\text{C}(75.2^{\circ}\text{F}) \leq \text{intake air temp.} < 26^{\circ}\text{C}(78.8^{\circ}\text{F})$ | intake air temp. $-1^{\circ}\text{C}(-2^{\circ}\text{F})$ |
| $22^{\circ}\text{C}(71.6^{\circ}\text{F}) \leq \text{intake air temp.} < 24^{\circ}\text{C}(75.2^{\circ}\text{F})$ | intake air temp. $-0.5^{\circ}\text{C}(-1^{\circ}\text{F})$ |
| $18^{\circ}\text{C}(64.4^{\circ}\text{F}) \leq \text{intake air temp.} < 22^{\circ}\text{C}(71.6^{\circ}\text{F})$ | intake air temp. |
| intake air temp. $< 18^{\circ}\text{C}(64.4^{\circ}\text{F})$ | $18^{\circ}\text{C}(64.4^{\circ}\text{F})$ |

- When intake air temp. is $1^{\circ}\text{C}(2^{\circ}\text{F})$ above the setting temp., condition of compressor is same as in cooling mode operation.
- When intake air temperature reaches $1^{\circ}\text{C}(2^{\circ}\text{F})$ below the setting temp., compressor operates in step1~step3 and the indoor fan speed again operates at low speed or comes to a stop.

2.4 Auto changeover operation

- The air conditioner changes the operation mode automatically to keep indoor temperature steady.
- When room temperature vary over $\pm 2^{\circ}\text{C}(\pm 4^{\circ}\text{F})$ with respect to setting temperature, air conditioner keeps the room temperature in $\pm 2^{\circ}\text{C}(\pm 4^{\circ}\text{F})$ with respect to setting temperature by changing the mode from cooling to heating and vice versa.

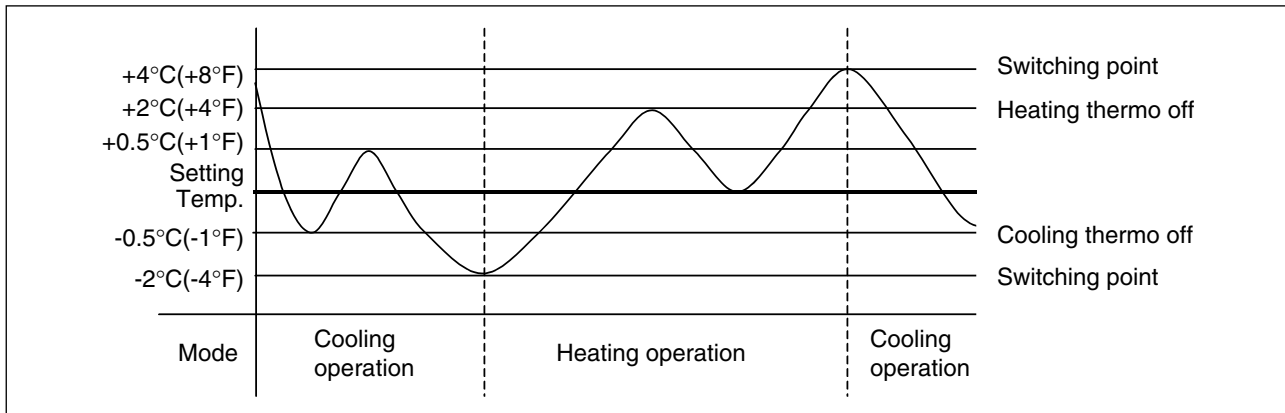

3. Special Mode Controls

3.1 Jet Cool operation

- In the heating mode or Fuzzy operation, the Jet cool function does not work.
When it is input while in other mode of operation (cooling, dehumidification, ventilation), the Jet cool operation takes place.
- In the Jet cool mode, the indoor fan is operated at super-high speed for 30 min. at cooling mode operation.
- In the Jet cool mode, the room temperature is maintained at a setting temperature of 18°C(64.4°F).
- When the sleep timer mode is input during the Jet cool operation, the Jet cool mode has the priority.
- When the Jet cool button is pressed, the horizontal vane of the unit is reset to those of the initial cooling mode and then operate so that the air outflow could reach further.

3.2 Jet Heat operation

- While in cooling mode or Fuzzy operation, the Jet Heat function does not work.
When it is input while in the Heating mode operation (dehumidification), the Jet Heat mode operation takes place
- In the Jet Heat mode, the indoor fan operated at super-high speed for 60 min. at Heating mode operation.
- In the Jet Heat mode, the room temperature is maintained at a temperature of 30°C(86°F).
- When the sleep timer mode is input during the Jet Heat mode operation, the Jet Heat mode has the priority.
- When the Jet Heat button is pressed, the horizontal vane of the unit is the unit reset to those of the initial Jet heating mode and then operates so that the air outflow could reach under flow.

3.3 Energy saving operation in cooling mode

- During cooling and dehumidification mode of operation, the Energy saving button can be input.
- In this operation, before we feel cold the set temperature and air volume is set automatically to save energy.

4. Utility Functions

4.1 Forced operation

- To operate the appliance manually in case when the remote control is lost, the forced operation selection switch is on the main unit of the appliance, and operate the appliance in the standard conditions.
- The operating condition is set according to the outdoor temp. and intake air temperature as follows.

| Indoor temp. | Operating Mode | Setting temp. | Setting speed of indoor fan |
|----------------------|--------------------------|---------------|-----------------------------|
| over 24°C(75.2°F) | Cooling | 22°C(71.6°F) | High speed |
| 21~24°C(69.8~75.2°F) | Healthy Dehumidification | 23°C(73.4°F) | |
| below 21°C(69.8°F) | Heating | 24°C(75.2°F) | |

- The unit select the last operation mode in 3 hours.
- Operating procedures when the remote control can't be used is as follows :
 - The operation will be started if the ON/OFF button is pressed.
 - If you want to stop operation, re-press the button.
 - The ON/OFF switch is on the display PCB or side of indoor unit

4.2 Auto cleaning operation

- Function used to perform Self Cleaning to prevent the Unit from Fungus and bad odor.
- Used after the Cooling Operation before turning the unit off, clean the Evaporator and keep it dry for the next operation.
- The function is easy to operate as it is accessed through the Remote controller.

1) Heat/pump Model

| | ON | OFF | | |
|------------|---------------|---------------|--------------|----------------|
| | Cooling CYCLE | Fan | Heating | Fan |
| Comp. | ON | 13 Min OFF | 60 Sec ON | 120 Sec OFF |
| Indoor Fan | Setting Step | LL | LL | LL |

2) Cooling/only Model

| | ON | OFF |
|------------|---------------|---------------|
| | Cooling CYCLE | Fan |
| Comp. | ON | 30 Min OFF |
| Indoor Fan | Setting Step | Low |

4.3 Air volume control

- Indoor fan motor control have 6 steps.
- Air volume is controlled "SH", "H", "Med", "Low" by the remote controller.
- "LL" step is selected automatically in Hot start operation.

| Step | Description |
|------|---------------------------|
| LL | Very low, In heating mode |
| L | Low |
| M | Med |
| H | High |
| SH | Super high |
| Auto | Natural wind |

4.4 Natural Air Control(Auto Wind)

- When the Auto Step is selected and then operated, the high, medium, or low speed of the airflow mode is operated for 2~15 sec. randomly by the Chaos Simulation.

4.5 Chaos Swing

- By the Chaos swing key input, the horizontal vane automatically operates with the Chaos swing or it is fixed to the desired direction.

4.6 Sleep mode Auto control

- When the set sleep time is reached set time of [1,2,3,4,5,6,7hour] input by the remote control during the operation, the operation of the appliance stops.
- When the appliance is on pause, the sleep timer mode cannot be input.

4.6.1 Sleep timer operation for cooling cycle

- While in cooling mode , 30 min. after the start of the sleep timer, the setting temperature increases by 1°C(2°F). After another 30minutes lapse, it increases again by 1°C(2°F).

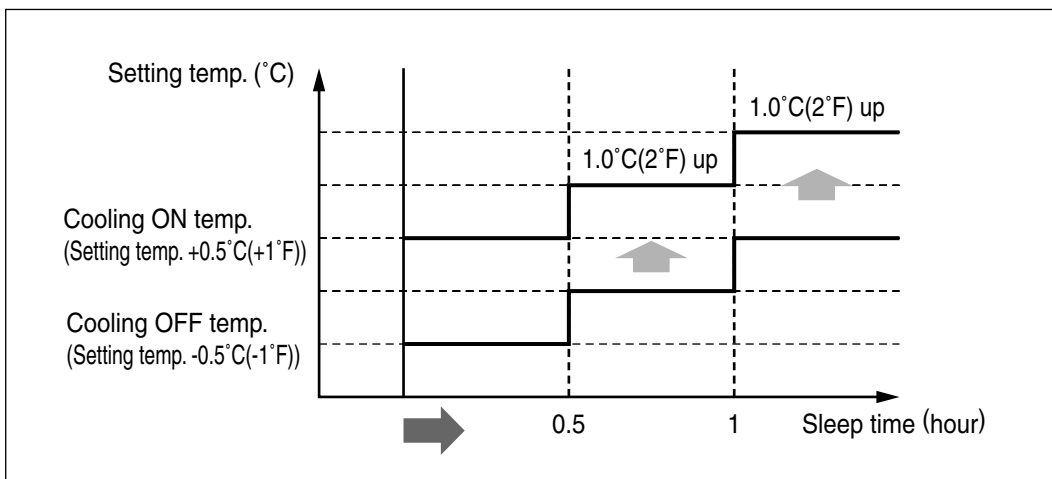

NOTE: Some Models are different by swing width and swing pattern.

4.6.2 Sleep timer operation for heating cycle

- While in heating mode, 60 min. after the start of the sleep timer, the setting temperature decreases by $1^{\circ}\text{C}(2^{\circ}\text{F})$. After another 60 minutes lapse, it decreases again by $1^{\circ}\text{C}(2^{\circ}\text{F})$.

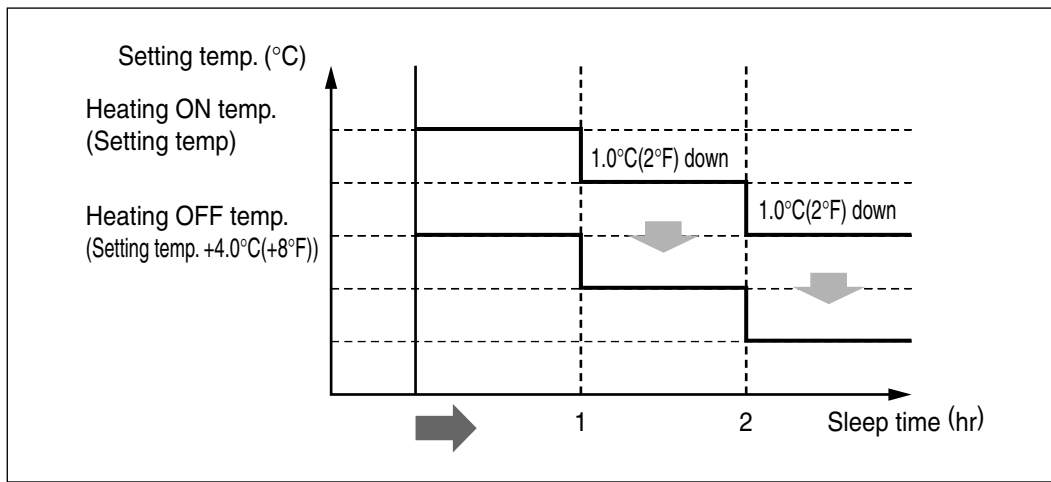

4.7 Auto restart

- When the power comes back after a sudden power failure during operation, the mode before the power failure is kept on the memory of the appliance and it automatically operates in the saved mode on the memory.
- Operation mode that is kept on the memory
 - State of operation ON/OFF
 - Operation mode/setting temp./selected airflow speed
 - Sleep timer mode/remaining time of sleep timer
 - Chaos Swing

5. Protection Functions & Controls

5.1 Five Seconds Stand-by (fan)

- The indoor unit fan rotates after 5 seconds when unit is turned on.

5.2 Two Minutes Stand-by (comp.)

- Compressor starts two minutes later, after it is turned off

5.3 Hot start

- When unit starts in the heating mode to prevent cold wind blowing, the indoor fan does not rotate until the temp. of heat exchanger reaches 30°C(86°F)(model by model)

5.4 Freeze prevention (Protection of the evaporator pipe from frosting)

- If the indoor pipe temperature is below 0°C(32°F) in 7 min. after the compressor operates without pause while in cooling cycle operation mode, → compressor, outdoor fan are turned off.
- When indoor pipe temp. is 7°C(44.6°F) or higher after 2 min pause of compressor → compressor, outdoor fan is turned on according to the condition of the room temperature.

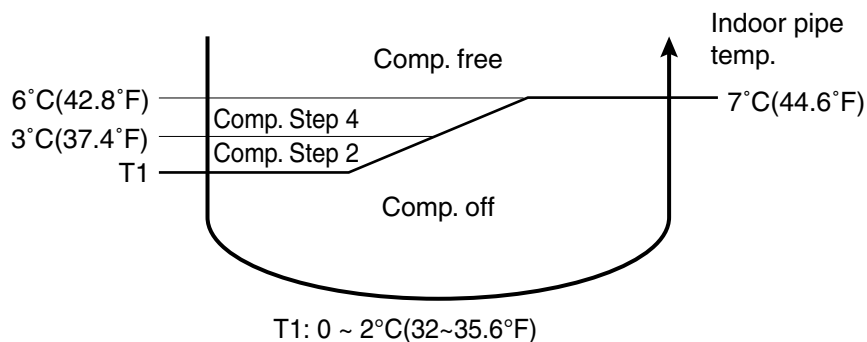

NOTE: Some Models are different by T1.

5.5 Compressor Preheating

5.5.1 9,12kBtu/h Model

With low outdoor temperature, It preheats the compressor to maintain the oil viscosity before the unit starts. Preheating Mode preheats the compressor motor coil by electric current without compressor running.

Mode-in conditions : Outdoor temp. $< 0^{\circ}\text{C}$ (32°F) and D-pipe temp. $< 15^{\circ}\text{C}$ (59°F)

Mode-out conditions : Outdoor temp. $> 5^{\circ}\text{C}$ (41°F) or D-pipe temp. $< 25^{\circ}\text{C}$ (77°F) or Compressor on

5.5.2 18, 24, 30kBtu/h Model

When the unit starts with low outdoor temperature, It preheats the compressor to maintain the oil viscosity. If it is under the following conditions, the compressor runs with 15Hz for a specific time

Conditions : heat sink temperature $< 0^{\circ}\text{C}$ (32°F) and D-pipe temperature $< 0^{\circ}\text{C}$ (32°F)

| Outdoor Temperature | Running Time [sec] |
|--|--------------------|
| -5°C (23°F) ~ -0°C (32°F) | 90 |
| -10°C (14°F) ~ -5°C (23°F) | 180 |
| Under -10°C (14°F) | 300 |

5.6 Sump Heater Control (9, 12kBtu/h Model Only)

With low outdoor temperature, the sump heater located on base panel prevents icing that may cause drain blockage and fan damage.

Heater-on conditions : Outdoor temp. $\leq 0^{\circ}\text{C}$ (32°F) and heating mode

Heater-out conditions : Outdoor temp. $> 1^{\circ}\text{C}$ (34°F)

5.5 Automatic defrost

5.5.1 9,12kBTu/h Model

- While in heating mode operation in order to protect the evaporator pipe of the outdoor unit from freezing, reversed to cooling cycle to defrost the evaporator pipe of the outdoor unit.
- Defrosting control is available 40 minutes later since heating cycle started and the difference of the pipe temperature of outdoor unit reaches above option 1.
- The defrosting control is available without reference to heating operation time only if the pipe temperature of outdoor unit reaches below option 2.

| | | | | |
|----------------------------------|--|---------------------------|-------------------------|---------------------|
| The mean outdoor temperature | -10°C(14°F) less than | -10~-5°C(14~23°F) between | -5~0°C(23~32°F) between | 0°C(32°F) more than |
| Option 1 | >4 | >5 | >5 | >5 |
| The minimum Time of Heating(sec) | Expected heating operating time And Heating operating time 40 minutes | | | |
| Option 2 | -30 | -30 | -25 | -25 |

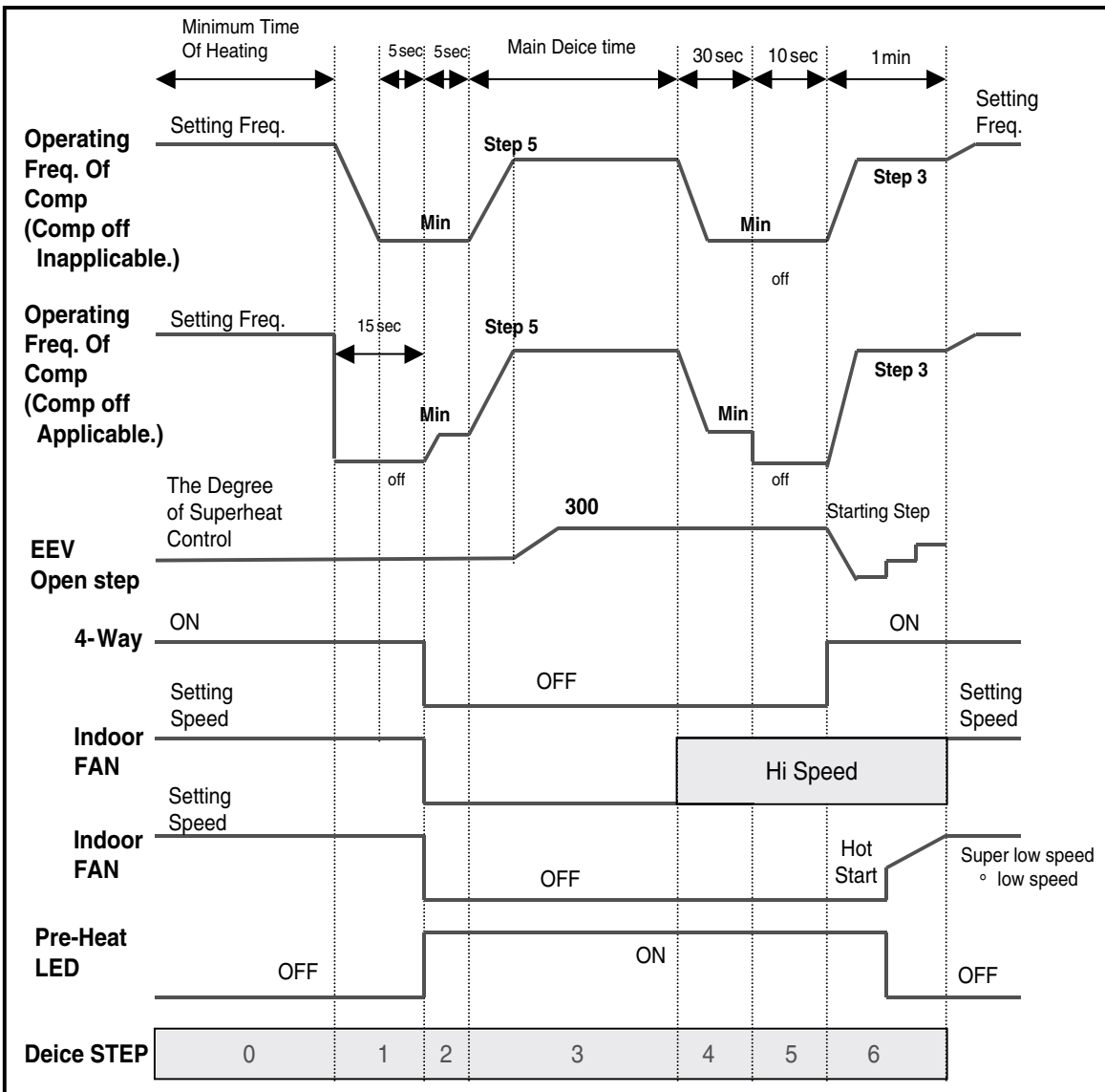

| Model (kBTu/h) | Compressor Frequency | EEV |
|----------------|----------------------|-----|
| 9 | 65Hz(Step 5) | 300 |
| 12 | 80Hz(Step 5) | 300 |

5.5.2 18,24,30kBTu/h Model

• Starting to the defrosting operation

1) Defrost operation will be start when the conditions below are matched

- a) Accumulation time of operation and the period after completion of defrost = 35 min.
- b) After 10 minutes from re-starting the compressor .In case of being over 35 minutes of accumulated operating time, defrosting operation starts after 10 minutes.
- c) Piping temperature of the outdoor heat exchanger maintain below defrost starting temperature for 4 minutes after 35 minutes continuous operation.
- d) In case of passing 10 minutes after oil recovery operation

2) Outdoor piping temperature is below than -6°C (21.2°F, Option) for starting defrosting operation.

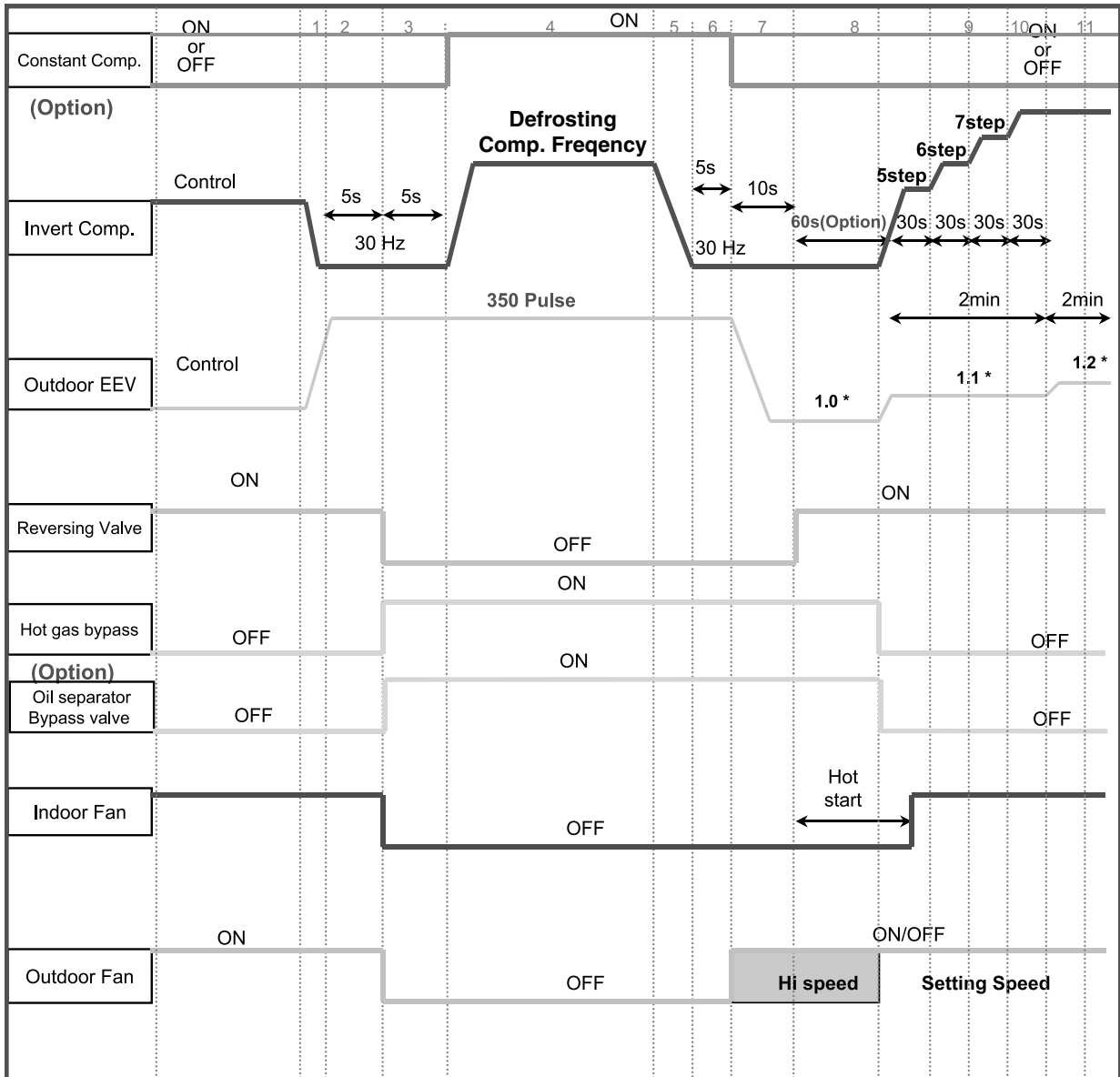

| Model (kBTu/h) | Defrosting Comp. Frequency | EEV |
|----------------|----------------------------|-----|
| 18 | 90Hz | 350 |
| 24 | 77Hz | 350 |
| 30 | 90Hz | 350 |

• **Defrosting Control Algorithm**

1) Lowering the compressor frequency when starts the defrosting operation.

Constant speed compressor is ON after 10 seconds from the arrival time of 30 Hz (Option) frequency and is speed up its revolution till 100 Hz (Option)

2) Every EEV have 350 pulse (Option) of opening when starts defrosting operation.

3) Reversing valve is OFF after 5 seconds from arriving the compressor operating frequency of 30 Hz and then fans of indoor units turn OFF.(including the indoor unit with being OFF except the remote controller is being OFF)

4) After 5 seconds from the time arriving 30 Hz, fans of outdoor unit turn OFF and Hot Gas bypass/Oil separator valve turn ON.

NOTE: Comp.frequency and EEV pulse is different each models.

• **Control algorithm of defrost completion**

1) Frequency of compressor lowering to 30 Hz and maintain constant speed operation with 30 Hz for 75 seconds and then staling operation. If the constant speed compressor is OFF, it will be receive OFF signal after 5 seconds from the arrival time of 30 Hz.

2) The EEV will open with the standard previous pulse after 5 seconds from the time of 30 Hz.

3) Reversing valve is ON after 15 seconds from the time of 30 Hz of compressor frequency.

4) Fan of outdoor unit is ON with high speed and maintain it after 5 seconds from the time of 30Hz.

5) Hot Gas bypass valve/Oil separator bypass valve make OFF after 75 seconds from the time of 30Hz.

NOTE: Comp.frequency and EEV pulse is different each models.

5.6 Power Relay Control

- Power relay turns on 1 second later after the power is supplied to the outdoor unit.
- Control sequence : power on → PTC operating → power relay on

5.7 Inverter

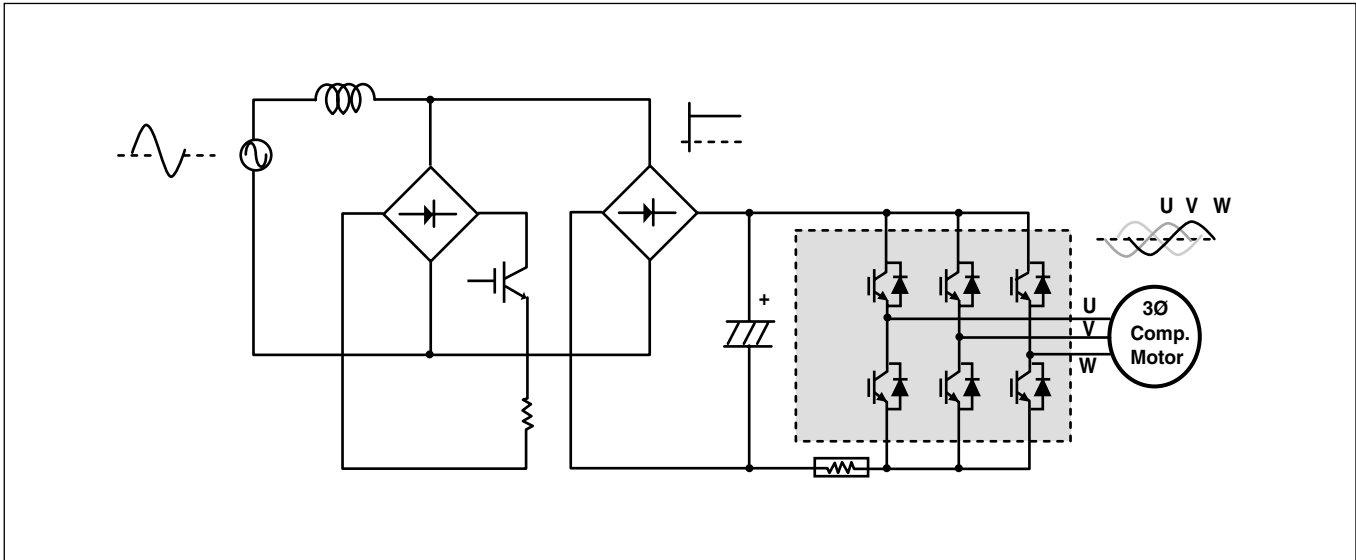

1. The single phase power AC is converted into DC.
2. The single phase power DC is converted into a three phase chopped DC voltage with a variable frequency.
3. When the frequency changes, the rotation speed of the compressor changes resulting in an changed refrigerant circulation. This leads to changeable amount of the heat exchange per unit.

5.8 Overheating Protection (Power Module)

5.8.1 9,12kBTu/h Model

- If the temperature of the heat sink thermistor. reaches over Toff, the Compressor stop instantly.
- The compressor operating frequency is limited according to the heat sink thermistor. (refer to below FIG.)
- It will blink 4 times, when the thermistor is open or short, also when the temperature is over T off.

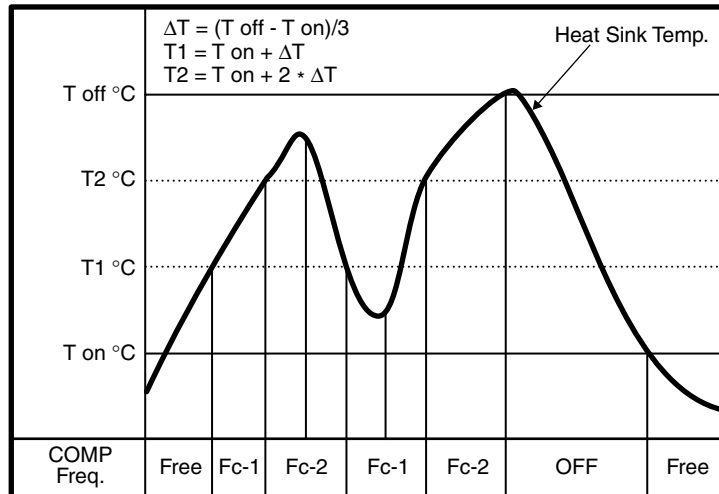

T on : 85°C(185°F) (Model by Model)
 T off : 95°C(203°F) (Model by Model)

5.8.2 18,24,30kBtu/h Model

• Function

: Power module failure protection by checking the temperature of heat sink.
 There is a temperature sensor for checking the heat sink temperature.

• Heat sink sensor failure error

Short Check : if temperature $\geq 130^{\circ}\text{C}(266^{\circ}\text{F})$

Open Check : if temperature $< -30^{\circ}\text{C}(-22^{\circ}\text{F})$

System will go in self diagnosis (Error code 65) is displayed and product stops.

• Heat sink temperature control

a) Heat sink temperature $< T_2$: No limitation on compressor frequency

b) $T_2 \leq$ heat sink temperature $< T_{off}$: Compressor frequency down by 5 Hz

c) Heat sink temperature $\geq T_{off}$: Compressor will be off.

System will stop if this situation occurs 5 times in 1 hour and error code will be generated also self diagnosis will start.

If high temperature situation occurs 5 times in 1 hr system counts 1 error and after that 4 times if this situation occurs system stops and give error code.

If the temperature reached T_{off} condition system will count 5 times after that and system will stop with error code.

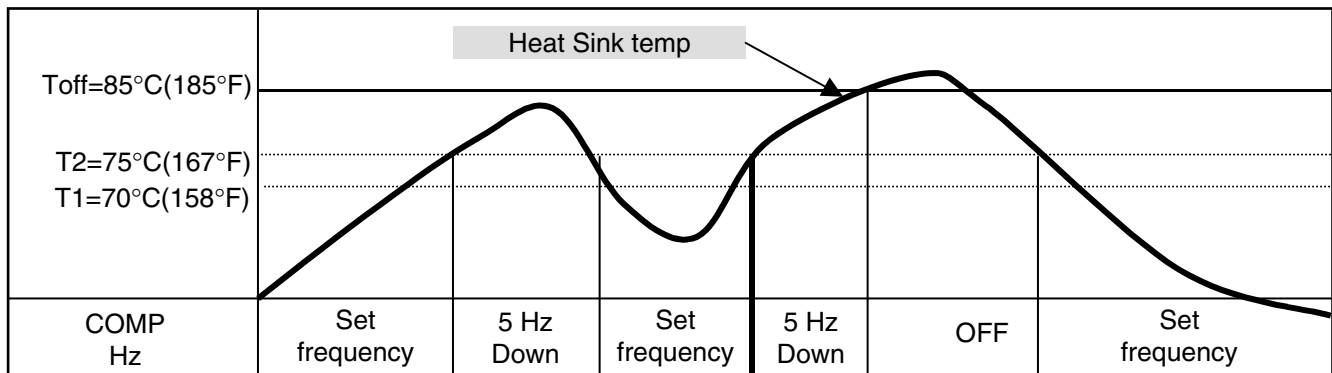

5.9 Total Current Control (Over Current Protection)

5.9.1 9,12kBtu/h Model

1) CT1 control

- If the operating current reaches I1, the operating frequency of the compressor decreases.
- After decreasing the operating frequency by 1step, if operating current is below I1 for 60 seconds continuously, the operating frequency of compressor increases by 1step.

2) CT2 control

- If the operating current of the appliance reaches I2, the compressor stop instantly and two minutes later the compressor restarts again.
- If CT2 occurs 5 times within one hour, the appliance turn off and displays ERROR CODE 7.

| Model (kBtu/h) | CT 1 (Cooling) | CT 1 (Heating) | CT 2 |
|-------------------|-------------------|-------------------|------|
| 9 | 7.5A | 9A | 10A |
| 12 | 7.5A | 9A | 10A |

5.9.2 18,24,30kBTu/h Model

- 1) Detection : check the output DC voltage of Current Transformer(CT).
- 2) Current Transformer Sensing Error
 - a) In initial power input, if the CT output is over 4.0V (25A) it shows.
Error Code 40 (defect in CT sensing)
- 3) CT 1 detection :
 - a) If total current exceeds CT1 value.reduce 1 step of operating Hz.
 - Step down 10Hz from current step.
 - If new Hz is below the minimum frequency 15Hz, then turn off the compressor.
 - b) After step down,if the total current exceed „1 for more than 5 sec. then step down 1 more step.
 - c) If the current continue below „1 for more than 1 min.,return the Hz to setting Hz.
- 4) CT 2 detection :
 - a) If total current exceeds CT2 turn off compressor.
And after 3 min turn on the compressor and check the current again.
 - b) If CT2 occurs 5 times in 1 hour,stop the operation and shows Error Code 22

| Model (kBTu/h) | CT 1 (Cooling) | CT 1 (Heating) | CT 2 |
|---------------------------|---------------------------|---------------------------|-------------|
| 18 | 11A | 12A | 14A |
| 24 | 14A | 12A | 15.5A |
| 30 | 11A | 12A | 14A |

5.10 DC Peak control

5.10.1 DC Peak Current Error by a fault signal of IPM

- If the operating current of IPM reaches 35A \pm 3A, the compressor stops instantly.
- If DC PEAK occurs 5 times within 1 hour, the appliance turns off and displays Error Code 6(9,12kBtu/h Model) / Error Code 21(18,24,30kBtu/h Model).

5.10.2 DC Peak Current Error by the compressor lock

- If the DC LINK voltage below DC 140V occurs 5 times within 1 hour while the compressor is operating, the appliance turns off and display Error Code 6(9k,12k Model) / Error Code 23(18k,24k,30k Model).

5.10.3 DC Peak Current Error by the Outdoor Fan Lock

- If this problem occurs 5 times within 1 hour in case of the temperature of outdoor pipe TH is over 65°C(149°F) while the compressor is operating, the appliance turns off and displays Error Code 6(9,12kBtu/h Model) / Error Code 61(18,24,30kBtu/h Model).

5.11 Discharge Pipe Temp Control

5.11.1 9,12kBtu/h Model

- If the temperature of the discharge pipe of compressor reaches over 130°C(266°F) or below -30°C(-22°F) the compressor stops instantly.
- The compressor operating frequency is limited according to the compressor dome TH. (Refer to below Fig.)
- Temperature range of COMP SPEC varies by 10°C(50°F).

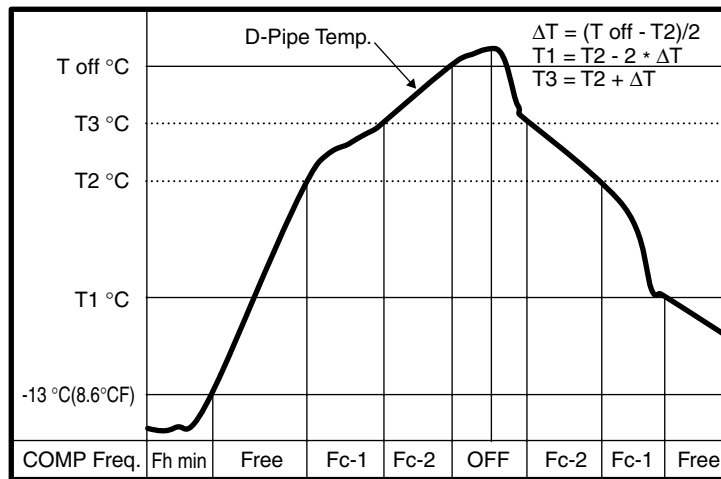

T off : 110°C(230°F)
T2 : 100°C(212°F)

5.11.2 Inverter Compressor (18,24,30kBtu/h Model)

1) There can be two situations

- (a) Sensor is failed (Error Code 41)
- (b) Abnormal high temperature discharge temperature (error code for high discharge will be generated)
Both cases unit will stop.

2) Compressor working

- (a) If discharge pipe temperature T1 No limitation on compressor frequency
- (b) $T2 \leq$ discharge pipe temperature T off (Hysteresis control) Compressor frequency down by 5Hz and expansion valve up by 10 pulse in every 1 min.
- (c) Discharge pipe temperature \geq Toff Compressor will be off
System will stop if this situation occurs 5 times in 1 hour and error code will be generated.

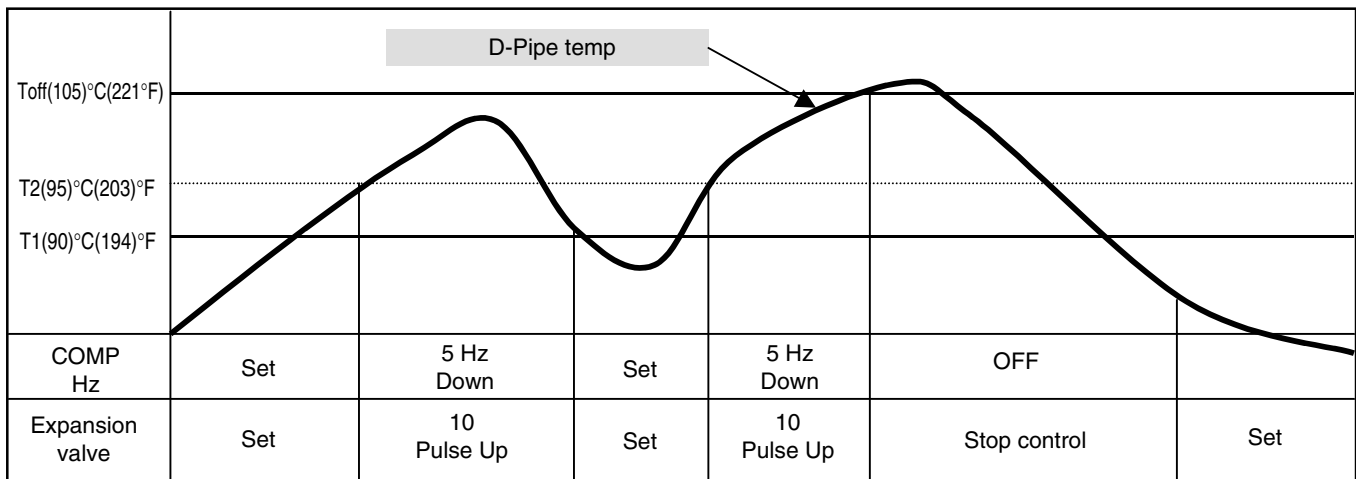

5.11.3 Constant Compressor (only 30kBtu/h Model)

1) There can be two situations

- (a) Sensor is failed (Error Code 41)
- (b) Abnormal high temperature discharge temperature (error code for high discharge will be generated)
Both cases unit will stop.

2) Compressor working

- (a) If discharge pipe temperature < T1 Compressor ON, EEV on-time control
- (b) $T2 \leq$ discharge pipe temperature < Toff (Hysteresis control) Expansion valve up by β pulse every 1 min.
If EEV is in the starting control it will follow it as it is.
- (c) Discharge pipe temperature \geq Toff Compressor will be OFF
System will stop if this situation occurs 5 times in 1 hour and error code will be generated (Error Code 33).

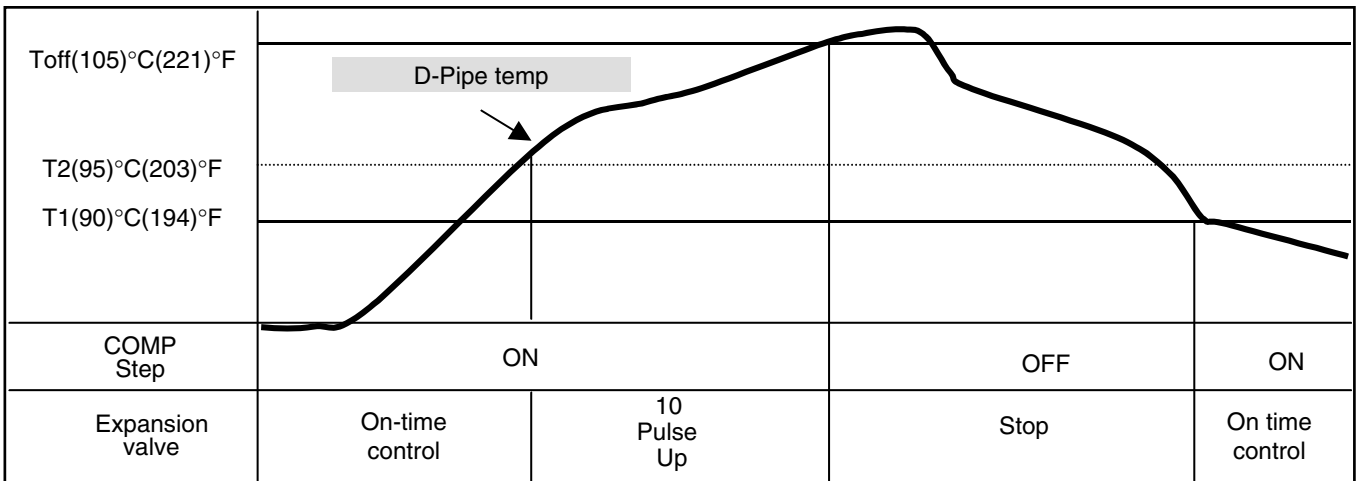

5.12 Low Ambient control

5.12.1 9,12kBtu/h Model

- If outdoor temperature drops below certain temperature, liquid back is prevented by On/Off control of outdoor fan.
- It can prevent frosting of evaporator and keep cooling operation

| Model | Mode-in Condition | Mode-out Condition |
|-------------------------------|--|--|
| Mode-in by outdoor pipe temp. | Outdoor fan-on time ≥ 3 min. (And) Outdoor pipe temp. $\leq 4^{\circ}\text{C}$ (39°F) (And) Outdoor temp. $< 10^{\circ}\text{C}$ (50°F) | Outdoor fan-off time ≥ 5 min. (Or) Outdoor pipe temp. $\leq 20^{\circ}\text{C}$ (68°F) (And) Outdoor temp. $\geq 10^{\circ}\text{C}$ (50°F) |
| Mode-in by indoor pipe temp. | Comp-on time ≥ 5 min. (And) Indoor pipe temp. $\leq 4^{\circ}\text{C}$ (39°F) (And) Outdoor temp. $< 10^{\circ}\text{C}$ (50°F) | Outdoor fan-off time ≥ 5 min. (Or) Indoor pipe temp. $\leq 4^{\circ}\text{C}$ (39°F) (And) Outdoor temp. $\geq 10^{\circ}\text{C}$ (50°F) |

5.12.2 18, 24, 30kBtu/h Model

Low ambient cooling case : In this situation outdoor fan works in ON/OFF control.

: If the pipe temperature 0°C (32°F) and it is falling rapidly in that case compressor will run for 5 min & then it will go in low ambient control. (* Temp. value can be different for each model.)

* After the system is stopped by CT cut or heat sink cut-off then the cycle returns to the normal conditond control.

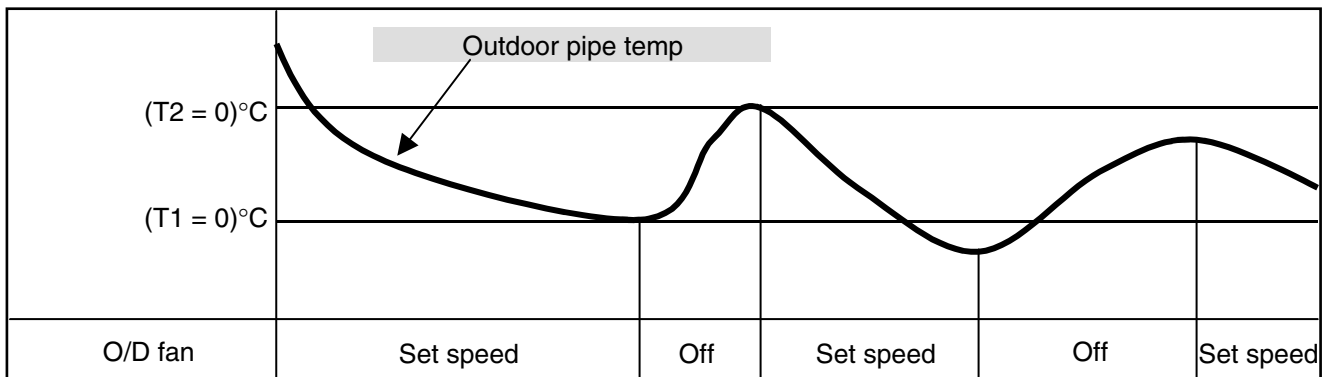

| Model | T1 [$^{\circ}\text{C}$ ($^{\circ}\text{F}$)] | T2 [$^{\circ}\text{C}$ ($^{\circ}\text{F}$)] |
|----------|---|---|
| 18kBtu/h | 18(64) | 18 |
| 24kBtu/h | 16(61) | 16 |
| 30kBtu/h | 0(32) | 0 |

5.13 Oil return control(30kBtu/h Model)

5.13.1 Operating Contion

- 1) When the continuous running time is over 3hr.(option), oil returning operation is made for 3min.
In case of the initial operation, oil returning operation is made, after completing initial operation.
- 2) After defrost and oil returning operation, the continuous running time is resetted.

5.13.2 Operation Process

- 1) EEV-Full open, Hot gas bypass valve-On
- 2) Compressor Step-70Hz + Constant Comp. On(Option)
- 3) Reversing valve-Off(Process of Off/On, follows defrost operating.)
- 4) Outdoor Fan-Low step

5.14 Oil equalizing control(30kBtu/h Model)

Operating condition :

- 1) When the continuous inverter compressor running time at under 40 Hz(option) is over 2 hours(option) in 2 compressor system, oil restoring operation is made.
- 2) If compressor operating Hz is below 40 Hz by the safety control, the accumulated time will be cleared and oil restoration is not made.
- 3) During this operation,if operating Hz couldn't be changed by safety control ,stop this operation.

Operating process : Raise the operating HZ up to 70,and after 20 sec.(option) recover to the last value.

Part 3 Test Run

| | |
|-------------------------------|----|
| 1. Check before Test Run..... | 32 |
| 2. Test Run Flow chart | 33 |
| 3. Test Run Detail..... | 34 |

1. Check before Test Run

| | |
|----------|---|
| 1 | Check to see whether there is any refrigerant leakage, and check whether the power or transmission cable is connected properly. |
| 2 | Check whether the liquid pipe and gas pipe valves are fully opened. NOTE: Be sure to tighten caps. |
| 3 | Confirm that 500 V megger shows 2.0 MΩ or more between power supply terminal block and ground. Do not operate in the case of 2.0 MΩ or less. NOTE: Never carry out mega ohm check over terminal control board. Otherwise the control board may break. Immediately after mounting the unit or after leaving it turned off for an extended length of time, the resistance of the insulation between the power supply terminal board and the ground may decrease to approx. 2.0 MΩ as a result of refrigerant accumulation in the internal compressor. If the insulation resistance is less than 2.0 MΩ, turn on the main power supply. |

2. Test Run Flow chart

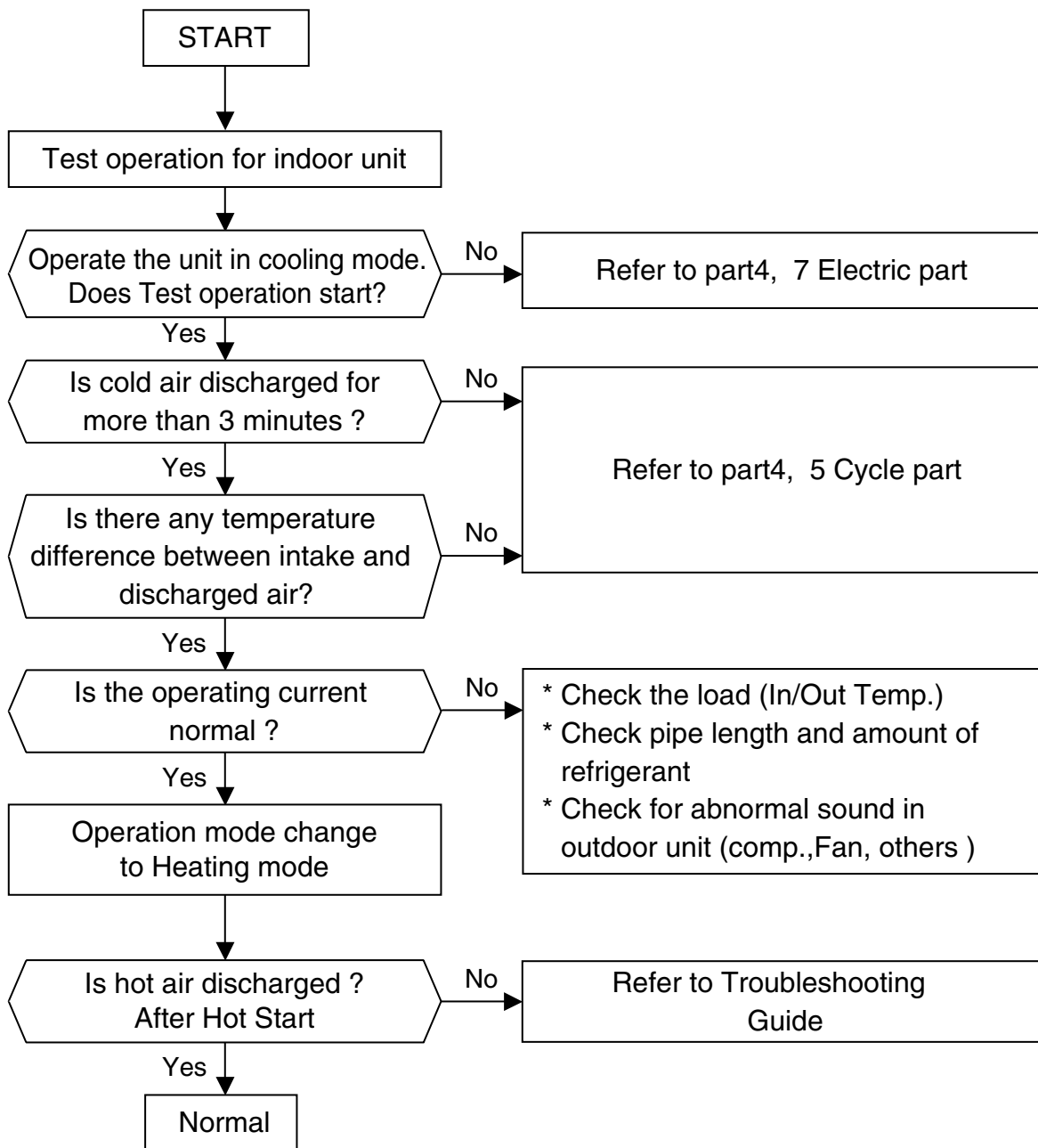

NOTE: When outdoor temperature is low, the unit is operated to Heating mode

3. Test Run Detail

1. Check that all tubing and wiring have been properly connected.
2. Check that the gas and liquid side service valves are fully open.

Settlement of outdoor unit

- Anchor the outdoor unit with a bolt and nut(ø10mm) tightly and horizontally on a concrete or rigid mount.
- When installing on the wall, roof or rooftop, anchor the mounting base securely with a nail or wire assuming the influence of wind and earthquake.
- In the case when the vibration of the unit is conveyed to the hose, secure the unit with an anti-vibration bushing.

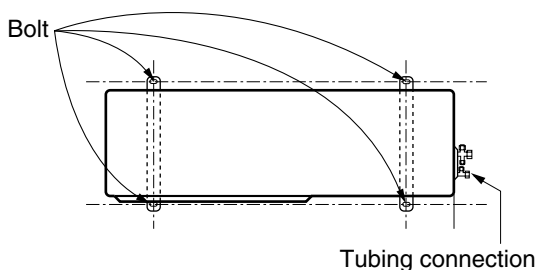

Evaluation of the performance

Operate unit for 15~20 minutes, then check the system refrigerant charge:

1. Measure the pressure of the gas side service valve.
2. Measure the temperature of the intake and discharge air.
3. Ensure the difference between the intake temperature and the discharge is more than 8°C(46°F) (Cooling) or (Heating).

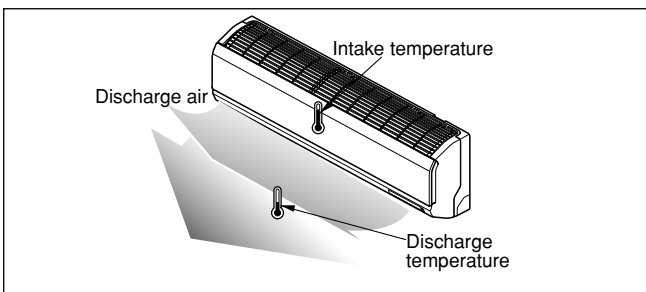

4. For reference; the gas side pressure of optimum condition is as below.(Cooling)

| Refrigerant | Outside ambient TEMP. | The pressure of the gas side service valve. |
|-------------|-----------------------|---|
| R22 | 35°C (95°F) | 4~5kg/cm ² G(56.8~71.0 P.S.I.G.) |
| R410A | 35°C (95°F) | 8.5~9.5kg/cm ² G(120~135 P.S.I.G.) |

NOTE: If the actual pressure is higher than shown, the system is most likely over-charged, and charge should be removed.
If the actual pressure are lower than shown, the system is most likely undercharged, and charge should be added.

The air conditioner is now ready for use.

PUMP DOWN

This is performed when the unit is to be relocated or the refrigerant circuit is serviced.

Pump Down means collecting all refrigerant in the outdoor unit without loss in refrigerant gas.

CAUTION:

Be sure to perform Pump Down procedure with the unit in cooling mode.

Pump Down Procedure

1. Connect a low-pressure gauge manifold hose to the charge port on the gas side service valve.
2. Open the gas side service valve halfway and purge the air from the manifold hose using the refrigerant gas.
3. Close the liquid side service valve(all the way in).
4. Turn on the unit's operating switch and start the cooling operation.
5. When the low-pressure gauge reading becomes 1 to 0.5kg/cm² G(14.2 to 7.1 P.S.I.G.), fully close the gas side valve stem and then quickly turn off the unit. At that time, Pump Down has been completed and all refrigerant gas will have been collected in the outdoor unit.
5. Check operating current.
6. Change operation mode and check.

Part 4 Trouble Shooting

| | |
|--|----|
| 1. 2-Way, 3-Way Valve | 36 |
| 2. Pumping Down | 37 |
| 3. Evacuation (All amount of refrigerant leaked) | 38 |
| 4. Gas Charging (After Evacuation) | 39 |
| 5. Cycle Troubleshooting Guide..... | 40 |
| 6. Electronic Parts Troubleshooting Guide | 41 |
| 7. Self-diagnosis Function..... | 46 |

1. 2-Way, 3-Way Valve

| | | 2-way Valve (Liquid Side) | 3-way Valve (Gas Side) | |
|-----------|-----------------------------|---------------------------|--------------------------|-------------------------------------|
| | | | | |
| Works | | Shaft position | Shaft position | Service port |
| Shipping | | Closed (with valve cap) | Closed (with valve cap) | Closed (with cap) |
| 1. | Air purging (Installation) | Open (counter-clockwise) | Closed (clockwise) | Open (push-pin or with vacuum pump) |
| Operation | | Open (with valve cap) | Open (with valve cap) | Closed (with cap) |
| 2. | Pumping down (Transferring) | Closed (clockwise) | Open (counter-clockwise) | Open (connected manifold gauge) |
| 3. | Evacuation (Servicing) | Open | Open | Open (with charging cylinder) |
| 4. | Gas charging (Servicing) | Open | Open | Open (with charging cylinder) |
| 5. | Pressure check (Servicing) | Open | Open | Open (with charging cylinder) |
| 6. | Gas releasing (Servicing) | Open | Open | Open (with charging cylinder) |

2. Pumping Down

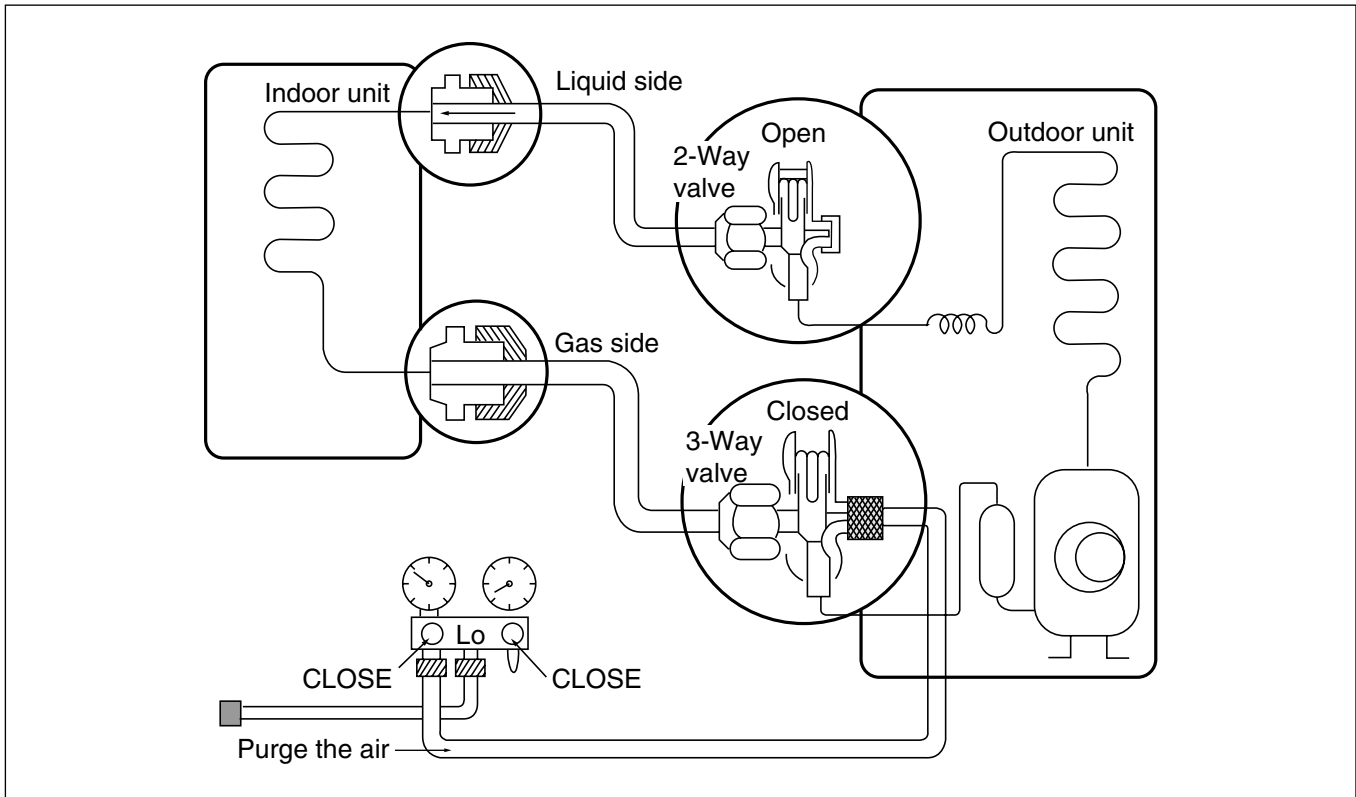

• Procedure

- (1) **Confirm that both the 2-way and 3-way valves are set to the open position.**
 - Remove the valve stem caps and confirm that the valve stems are in the raised position.
 - Be sure to use a hexagonal wrench to operate the valve stems.
- (2) **Operate the unit for 10 to 15 minutes.**
- (3) **Stop operation and wait for 3 minutes, then connect the charge set to the service port of the 3-way valve.**
 - Connect the charge hose with the push pin to the service port.
- (4) **Air purging of the charge hose.**
 - Open the low-pressure valve on the charge set slightly to air purge from the charge hose.
- (5) **Set the 2-way valve to the closed position.**
- (6) **Operate the air conditioner at the cooling cycle and stop it when the gauge indicates $1\text{kg}/\text{cm}^2\text{-g}$.**
- (7) **Immediately set the 3-way valve to the closed position.**
 - Do this quickly so that the gauge ends up indicating 3 to $5\text{kg}/\text{cm}^2\text{-g}$.
- (8) **Disconnect the charge set, and mount the 2-way and 3-way valve's stem nuts and the service port nut.**
 - Use torque wrench to tighten the service port nut to a torque of $1.8\text{ kg}\cdot\text{m}$.
 - Be sure to check for gas leakage.

3. Evacuation (All amount of refrigerant leaked)

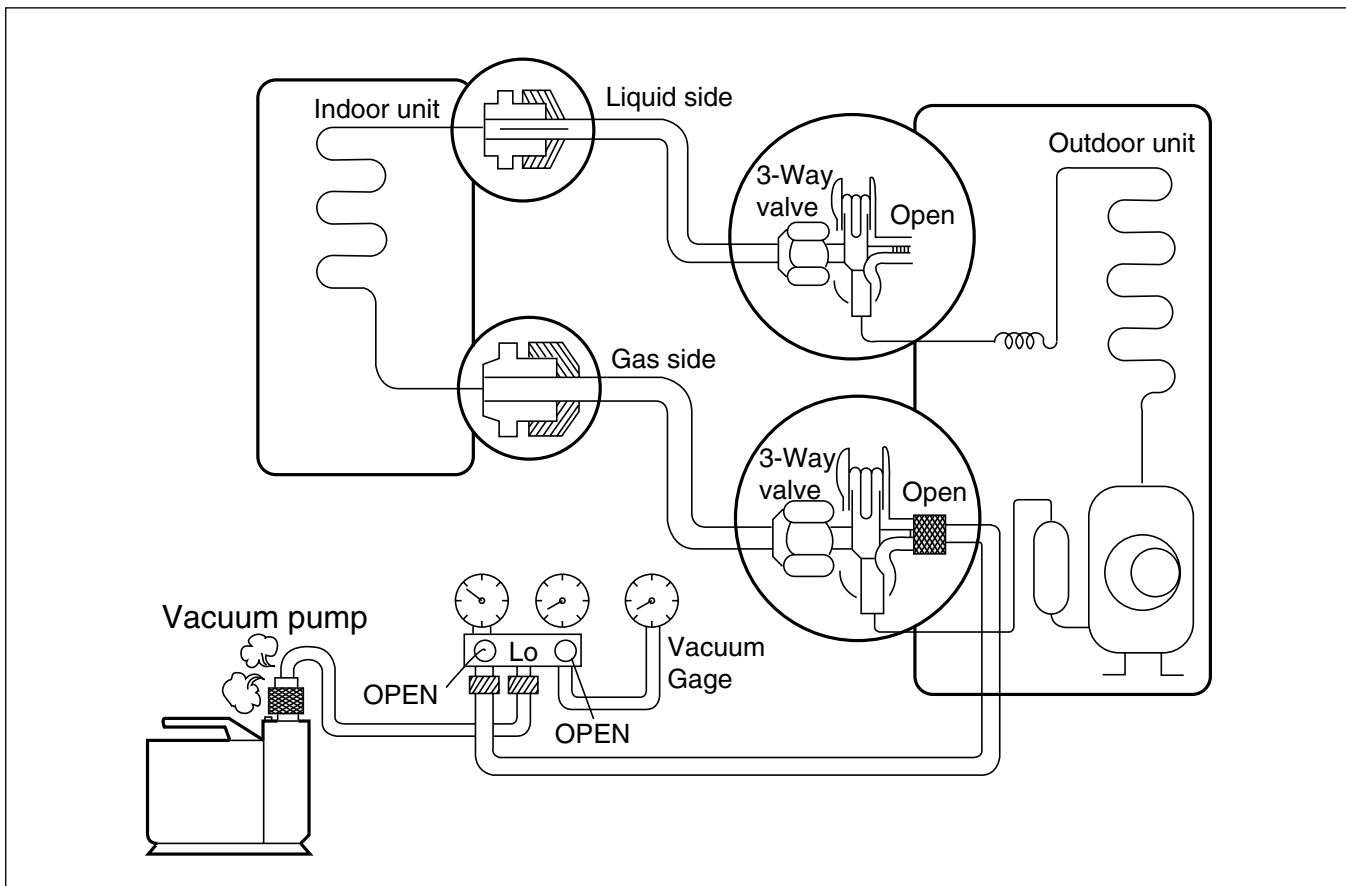

• Procedure

- (1) Connect the vacuum pump to the center hose of charge set center hose
- (2) Evacuation for approximately one hour.
 - Confirm that the gauge needle has moved toward 0.8 Torr.
- (3) Close the valve (Lo side) on the charge set, turn off the vacuum pump, and confirm that the gauge needle does not move (approximately 5 minutes after turning off the vacuum pump).
- (4) Disconnect the charge hose from the vacuum pump.
 - Vacuum pump oil.
 - If the vacuum pump oil becomes dirty or depleted, replenish as needed.

4. Gas Charging (After Evacuation)

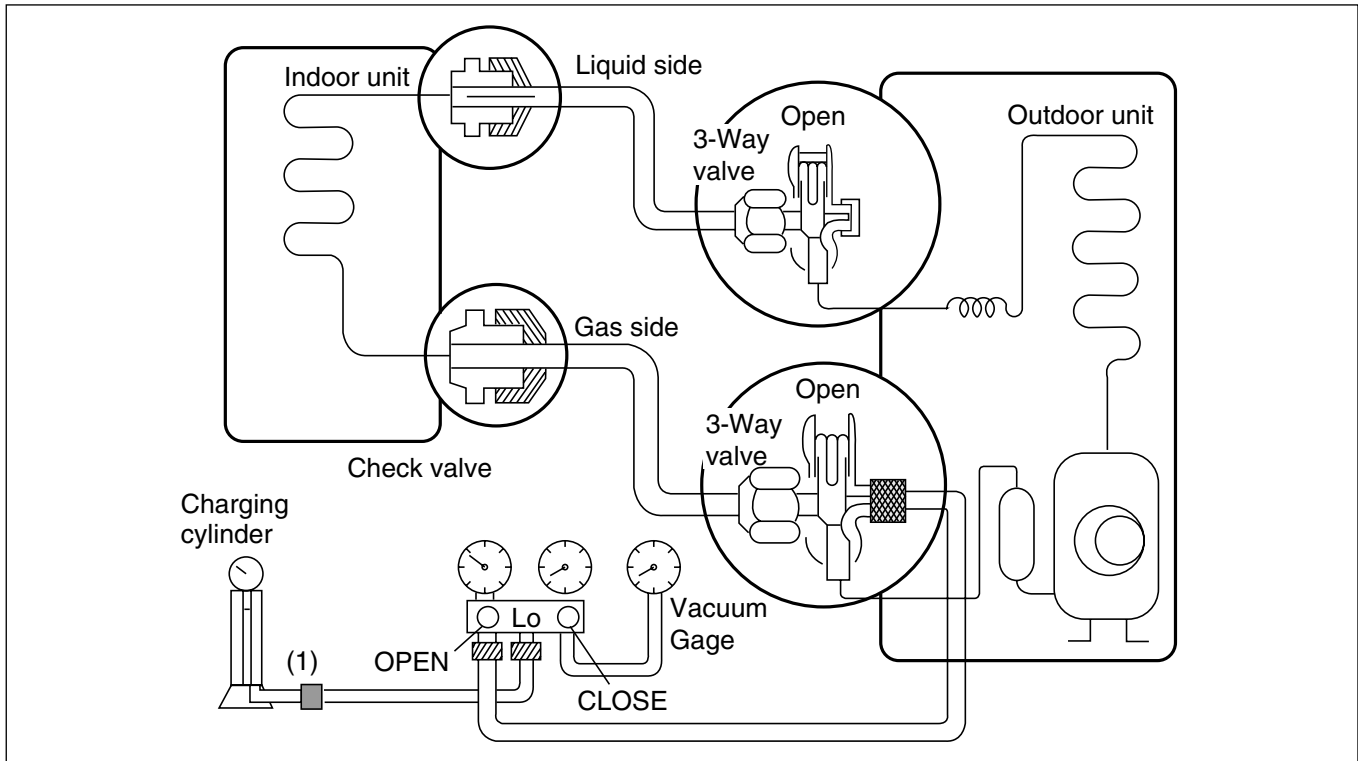

• Procedure

(1) Connect the charge hose to the charging cylinder.

- Connect the charge hose which you disconnected from the vacuum pump to the valve at the bottom of the cylinder.
- If you are using a gas cylinder, also use a scale and reverse the cylinder so that the system can be charged with liquid.

(2) Purge the air from the charge hose.

- Open the valve at the bottom of the cylinder and press the check valve on the charge set to purge the air. (Be careful of the liquid refrigerant). The procedure is the same if using a gas cylinder.

(3) Open the valve (Lo side on the charge set and charge the system with liquid refrigerant.

- If the system can not be charged with the specified amount of refrigerant, it can be charged with a little at a time (approximately 150g each time) while operating the air conditioner in the cooling cycle; however, one time is not sufficient, wait approximately 1 minute and then repeat the procedure (pumping down-pin).

This is different from previous procedures. Because you are charging with liquid refrigerant from the gas side, absolutely do not attempt to charge with larger amounts of liquid refrigerant while operating the air conditioner.

(4) Immediately disconnect the charge hose from the 3-way valve's service port.

- Stopping partway will allow the gas to be discharged.
- If the system has been charged with liquid refrigerant while operating the air conditioner turn off the air conditioner before disconnecting the hose.

(5) Mount the valve stem nuts and the service port nut.

- Use torque wrench to tighten the service port nut to a torque of 1.8 kg.m.
- Be sure to check for gas leakage.

5. Cycle Troubleshooting Guide

Trouble analysis

1. Check temperature difference between intake and discharge air, and operating current.

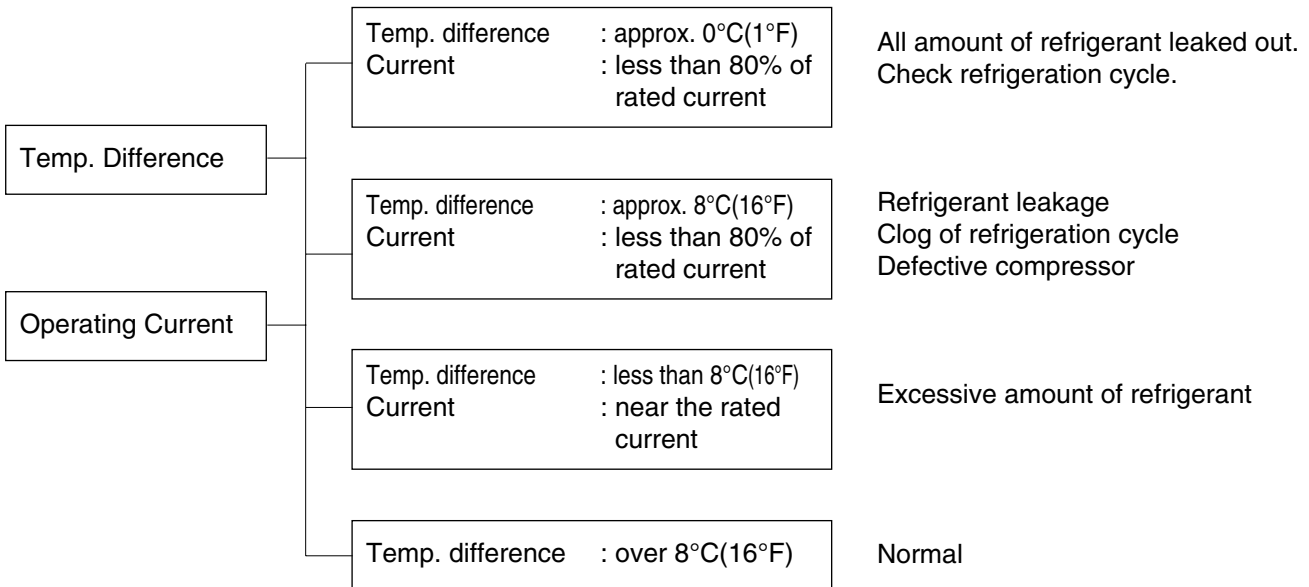

NOTICE

Temperature difference between intake and discharge air depends on room air humidity. When the room air humidity is relatively higher, temperature difference is smaller. When the room air humidity is relatively lower temperature difference is larger.

6. Electronic Parts Troubleshooting Guide

Trouble 1

The Product doesn't operate at all. (9~30kBTu/h Model)

Turn off the main power and wait until LED on outdoor PCB is off.



Turn on the main power again.



Does "Beeping" sound is made from the indoor unit?
Does "Lighting" LED is mounted on the outdoor PCB?

NO

Check the voltage of power(AC 208~230V, 60Hz).

- The voltage of main power.
- The voltage applied to the unit.
- The connecting method of Indoor/Outdoor connecting cable (each color)
- The P.W.B. Ass'y
(Fuse, Noise Filter, Power Module(SMPS), IC01D, IC04D)

YES

- Primarily, the operating condition of Micom is O.K.



- Check CN-DISP1

The operation check of the P.C.B. Ass'y

| Procedure | Specification | Remedy |
|--|----------------|--------------------|
| 1) The input voltage of Power Module(SMPS) | : DC 220V~390V | Replace the P.C.B. |
| 2) The output voltage of Power Module (SMPS) | : 15V ±10% | |
| 3) IC01D(LD1085), IC04D(7805) | : DC 5V | |

Trouble 2

Product doesn't operate with the remote controller. (9~30kBTu/h Model)

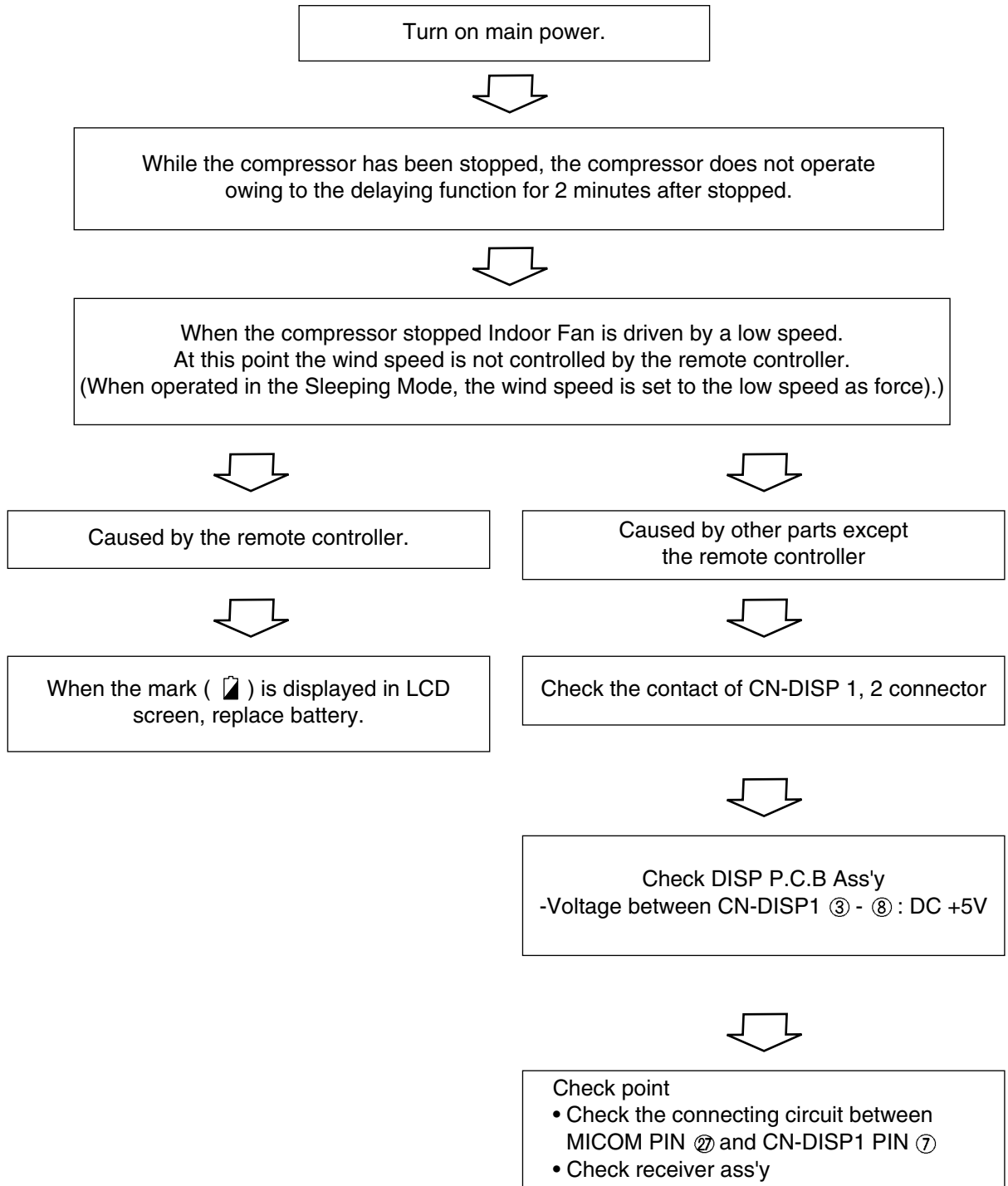

Trouble 3**The Compressor/Outdoor Fan don't operate (9, 12kBtu/h Model)**

Turn on the main power.



Operate Cooling Mode by setting the disired temperature of the remote controller is less than one of the Indoor temperature by 1°C at least.



When in air circulation mode, compressor/outdoor fan is stopped.



Check the sensor for Indoor temperature is attached as close as to be effected by the themperature of Heat Exchange (EVA.)



When displaying Error code, refer to the trouble shooting guide.



Check the main power source.(AC 208V~230V)
Check the trouble shooting guide error code 6,9



Turn off main power.



Check the electrical wiring diagram of Outdoor side.
Check the open or short of connecting wires between Indoor and Outdoor.

Trouble 4

The Compressor/Outdoor Fan don't operate (18, 24, 30kBTu/h Model)

Turn on the main power.



Operate Cooling Mode by setting the disired temperature of the remote controller is less than one of the Indoor temperature by 1°C at least.



When in air circulation mode, compressor/outdoor fan is stopped.



Check the sensor for Indoor temperature is attached as close as to be effected by the temperature of Heat Exchange (EVA.)



When displaying Error code, refer to the trouble shooting guide.



Check the main power source.(AC 208V~230V)
Check the trouble shooting guide error code 21,26.
Check that CN_FAN(A,B) supplied voltage to outdoor PCB is about AC 208V~230V.



Turn off main power.



Check the electrical wiring diagram of Outdoor side.
Check the open or short of connecting wires between Indoor and Outdoor.

Trouble 5

When indoor Fan does not operate.(9~30kBTu/h Model)

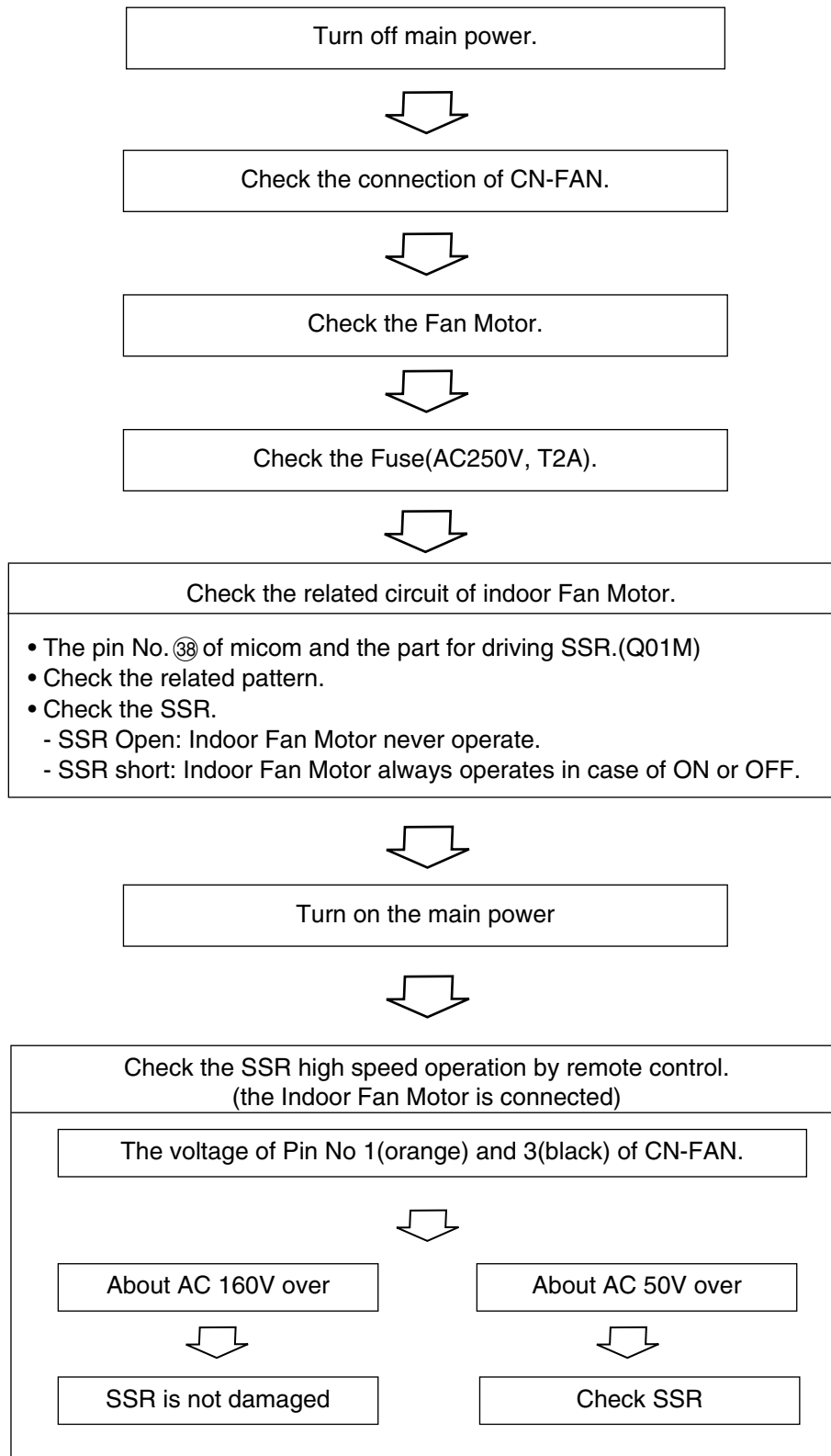



7. Self-diagnosis Function

■ Error Indicator

- The function is to self-diagnosis airconditioner and express the troubles identifiably if there is any trouble.
- Error mark is ON/OFF for the operation LED of evaporator body in the same manner as the following table.
- If more than two troubles occur simultaneously, primarily the highest trouble fo error code is expressed.
- After error occurrence, if error is released, error LED is also released simultaneously.
- To operate again on the occurrence of error code, be sure to turn off the power and then turn on.
- Having or not of error code is different from Model.

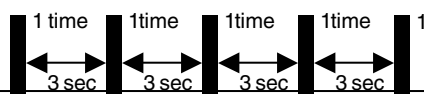
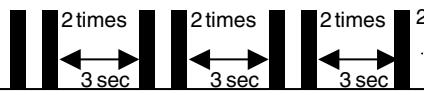
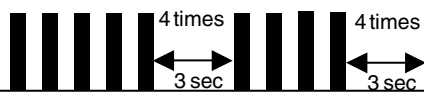
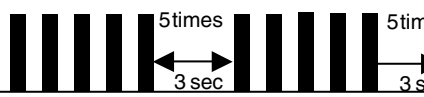
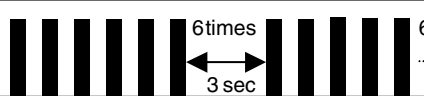
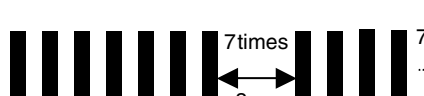
■ 9, 12kBTu/h Model

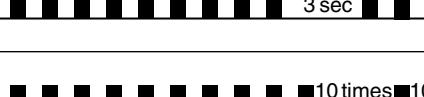
| Error Code | Error Indicator | Cause of Error | Display | | Indoor Operation |
|------------|---|--|---------|---------|------------------|
| | | | Indoor | Outdoor | |
| 1 |  | <ul style="list-style-type: none"> • Indoor Temp. sensor error - Sensor open or short | O | | ON |
| 2 |  | <ul style="list-style-type: none"> • Outdoor Temp. sensor error - Sensor open or short | O | O | ON |
| 4 |  | <ul style="list-style-type: none"> • Heat Sink sensor error - Sensor open or short - Heat Sink temp is over 95. | O | O | ON |
| 5 |  | <ul style="list-style-type: none"> • Communication error | O | O | OFF |
| 6 |  | <ul style="list-style-type: none"> • DC Peak error | O | O | SHUT DOWN |
| 7 |  | <ul style="list-style-type: none"> • Over current error (CT2) | O | O | SHUT DOWN |
| 8 |  | <ul style="list-style-type: none"> • Indoor fan lock error (BLDC fan model only) | O | | OFF |
| 9 |  | <ul style="list-style-type: none"> • Outdoor fan lock error (BLDC fan model only) | O | O | OFF |
| 10 |  | <ul style="list-style-type: none"> • D-Pipe TH. is short or open. | O | O | ON |

(4 LED Model)

■ 18,24,30kBtu/h Model

Indoor Error

| Error code | Description | INV TPS | LED1 (Red) | LED2 (Green) | Indoor Status |
|------------|---------------------------------------|---------|------------|--------------|---------------|
| 00 | No Error | ● | | | ON |
| 01 | Indoor Room themistor error | ● | | 1time ● | OFF |
| 02 | Indoor in-piping sensor error | ● | | 2times ● | OFF |
| 05 | Communcation error between in and out | ● | | 5times ● | OFF |
| 06 | Indoor Out-Piping sensor error | ● | | 6times ● | OFF |

Outdoor Error

Ex) Error Code 21 (IPM Fault)

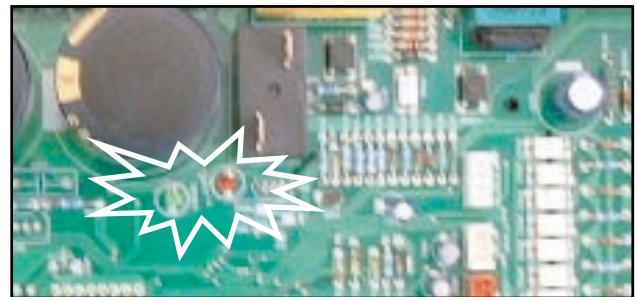
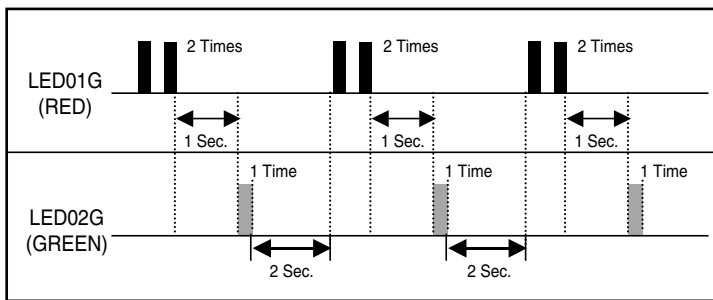

| Error code | Contents | LED01G (Red) | LED02G (Green) | Case of error | Outdoor Status |
|------------|-------------------------------------|--------------|----------------|-----------------------------------|----------------|
| 21 | IPM Fault (Compressor Over current) | 2 times ● | 1 time ● | Compressor malfunction, IPM Fault | Off |
| 22 | CT 2(Max. Current) | 2 times ● | 2 times ● | Current is 14A ↑ | Off |
| 23 | DC Link Low Volt. | 2 times ● | 3 times ● | DC Link volt. Is 140V ↓ | Off |
| 24 | Low / High press | 2 times ● | 4 times ● | Low / High press switch OPEN | Off |
| 25 | AC Low / AC High Volt. | 2 times ● | 5 times ● | Abnormal AC volt. Input. | Off |
| 26 | DC Compressor Position | 2 times ● | 6 times ● | | Off |
| 27 | PSC Fault | 2 times ● | 7 times ● | | Off |
| 28 | DC Link High Volt | 2 times ● | 8 times ● | Off | Off |
| 32 | Discharge Pipe Temp. High (INV) | 3 times ● | 2 times ● | Off | Off |
| 33 | Discharge Pipe Temp. High (Cons.) | 3 times ● | 3 times ● | Off | Off |

Part 4 Trouble Shooting

| Error code | Contents | LED01G (Red) | LED02G (Green) | Case of error | Outdoor Status |
|------------|-----------------------------------|--------------|----------------|------------------------|----------------|
| 40 | CT Circuit (open/ short) | 4 times ● | ○ | CT Circuit malfunction | Off |
| 41 | D-pipe sensor INV. (open/ short) | 4 times ● | 1 time ● | Open / Short | Off |
| 44 | Air sensor (open/ short) | 4 times ● | 4 times ● | Open / Short | Off |
| 45 | Cond. Pipe sensor (open/ short) | 4 times ● | 5 times ● | Open / Short | Off |
| 46 | Suction pipe sensor (open/ short) | 4 times ● | 6 times ● | Open / Short | Off |
| 47 | D-pipe sensor Cons. (open/ short) | 4 times ● | 7 times ● | Open / Short | Off |
| 53 | Communication (Indoor Outdoor) | 5 times ● | 3 times ● | Communication Poorly | Off |
| 60 | EEPROM check sum ↔ | 6 times ● | ○ | Check sum mismatching | Off |
| 61 | Cond. Pipe sensor temp. high | 6 times ● | 1 time ● | Cond. Temp. high | Off |
| 62 | Heat sink sensor temp. high | 6 times ● | 2 times ● | Heat sink temp. high | Off |
| 65 | Heat sink sensor (open/ short) | 6 times ● | 5 times ● | Open / Short | Off |

■ Troubleshooting Guide(9,12kBtu/h Model)

| Error code | Description | Cause of error |
|------------|-----------------------------|---|
| 1 | Indoor TH. is short or open | <ul style="list-style-type: none"> Indoor TH. (sensor) is short or open Indoor TH. (sensor) is not connected to the indoor pcb assembly Damage or defect on the sensing circuit of indoor pcb assembly. (R01H, R02H, R03H, R04H, C01H, C02H) |

Check flow

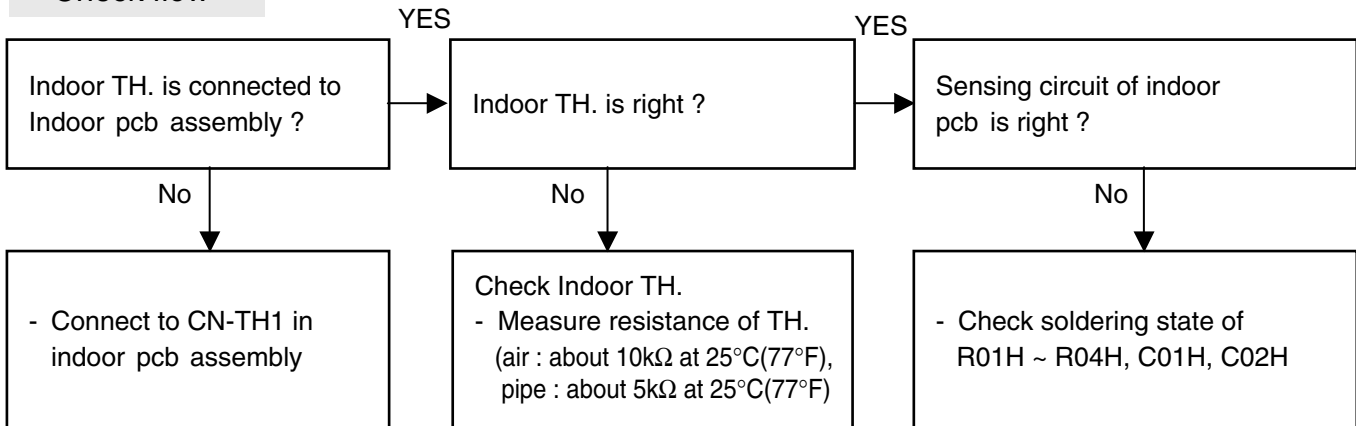

| Error code | Description | Cause of error |
|------------|------------------------------|--|
| 2 | Outdoor TH. is short or open | <ul style="list-style-type: none"> Outdoor TH. (sensor) is short or open Outdoor TH. (sensor) is not connected to the outdoor pcb assembly Damage or defect on the sensing circuit of outdoor pcb assembly. (R03H~R06H, C02H, C03H) |

Check flow

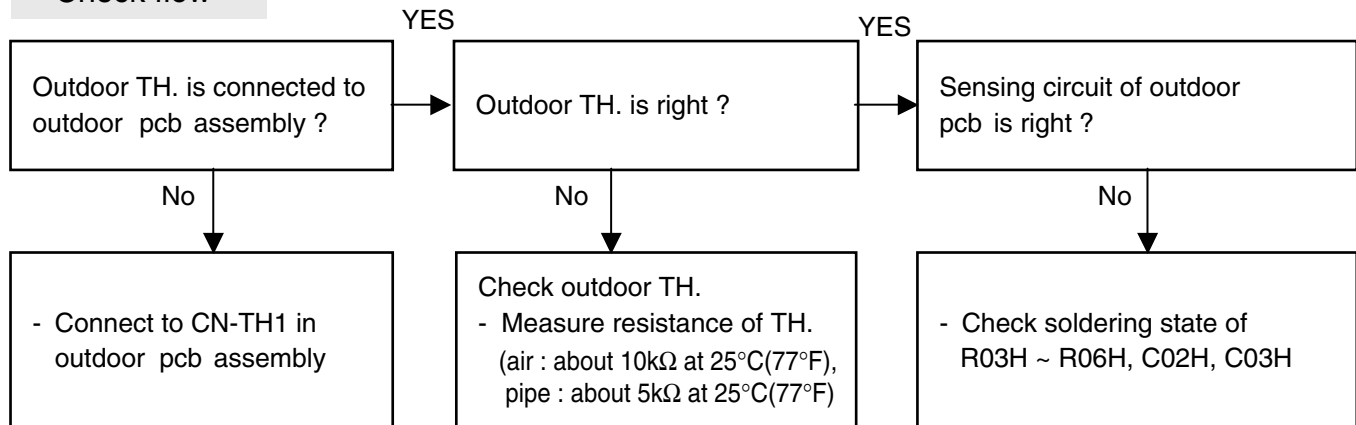

| Error code | Description | Cause of error |
|------------|---|--|
| 4 | Heat-sink Temp. is over 95°C(203°F) Heat-sink TH. is open or short | <ul style="list-style-type: none"> Heat-sink TH. is damaged(short or open). Heat-sink Temp. is over 95°C(203°F) Damage or defect on the sensing circuit of outdoor pcb assembly. (R01H, R02H, C01H) |

Check flow

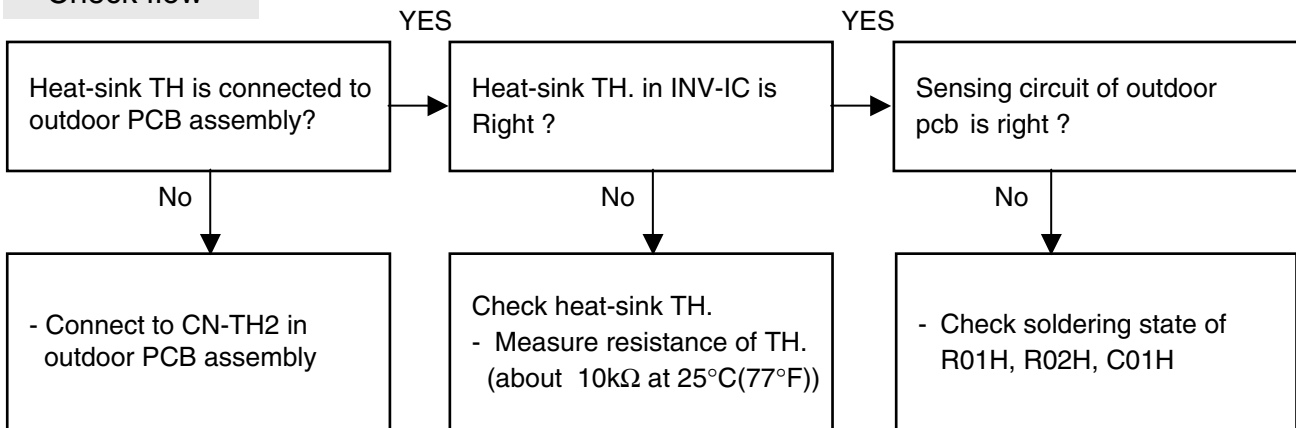

9k,12kBtu/h Model Heat-sink Thermistor resistans check

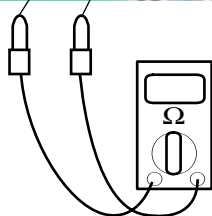

R-T Graph

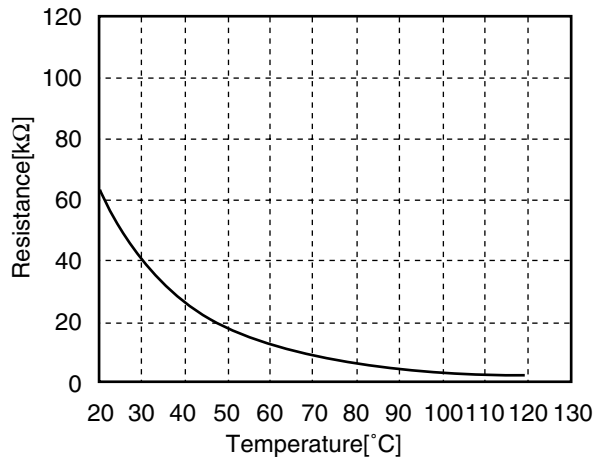

| Error code | Description | Cause of error |
|------------|---------------------|---|
| 5 | Communication Error | <ul style="list-style-type: none"> • Wrong or missing wiring between indoor and outdoor unit cable • Defect of communication components in indoor pcb assembly • Defect of communication components in outdoor pcb assembly • Defect of power supply components in outdoor pcb assembly • No ground connection in air conditioner unit (affected by noise in power source) |

Check flow

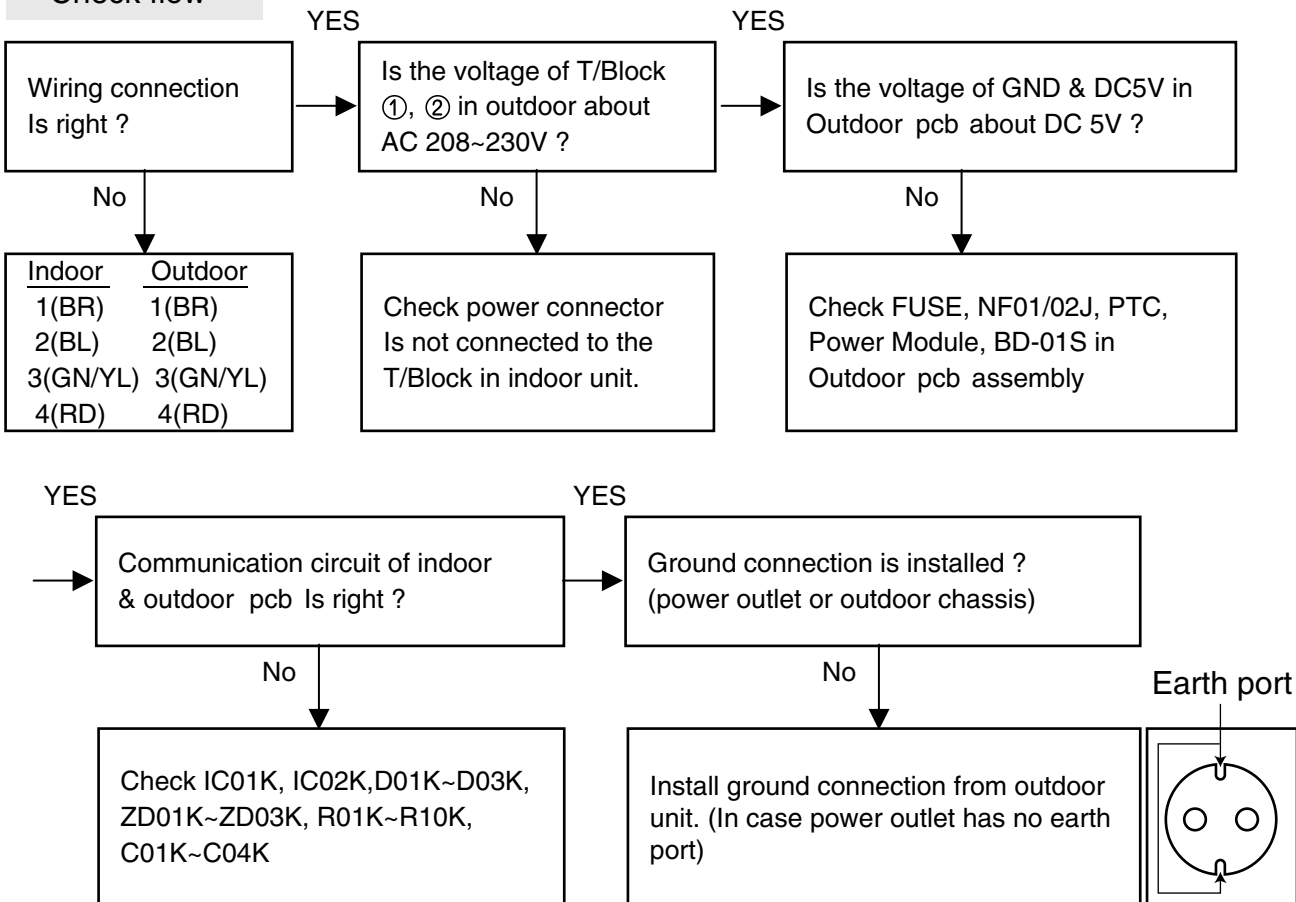

Part 4 Trouble Shooting

| Error code | Description | Cause of error |
|------------|---------------|---|
| 6 | DC Peak Error | <ul style="list-style-type: none"> • Supplied power is not normal • Comp Connector (CN-U,V,W) is disconnected or inserted to wrong position • Compressor is damaged (coil short) → replace compressor • Too much Refrigerant • Defect in outdoor pcb assembly → replace pcb assembly |

Check flow

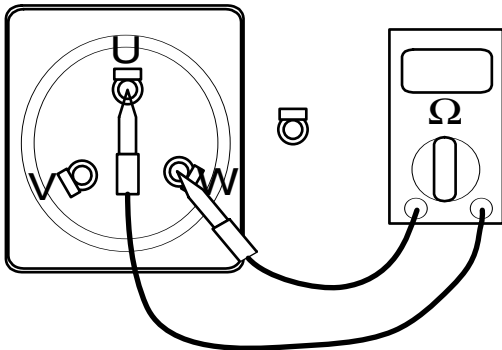
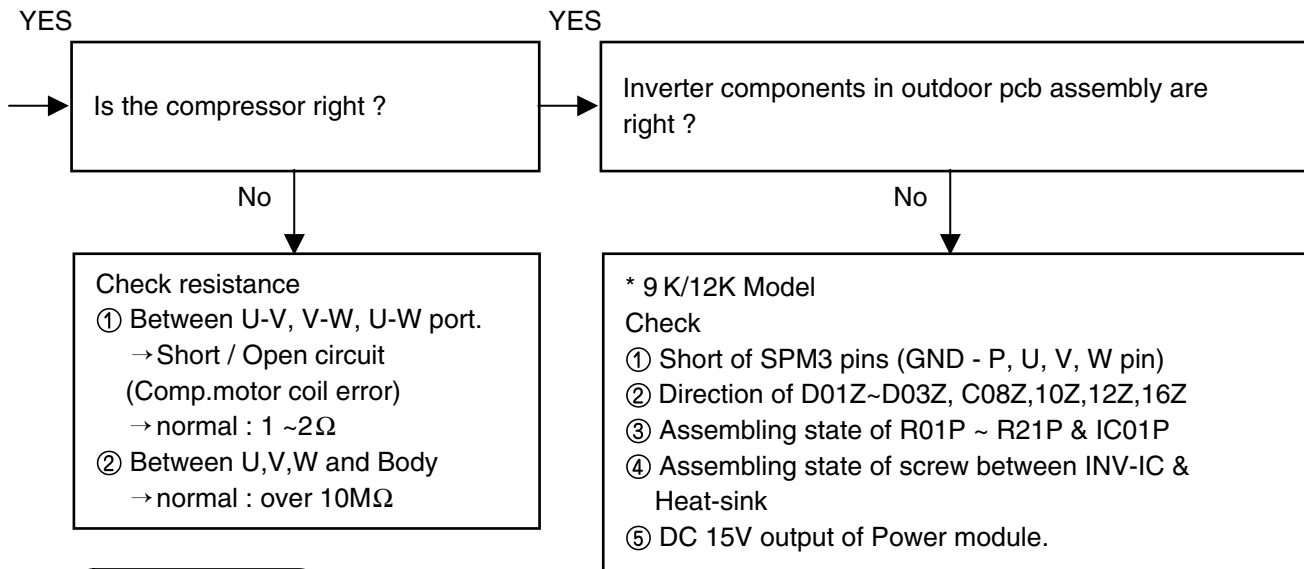
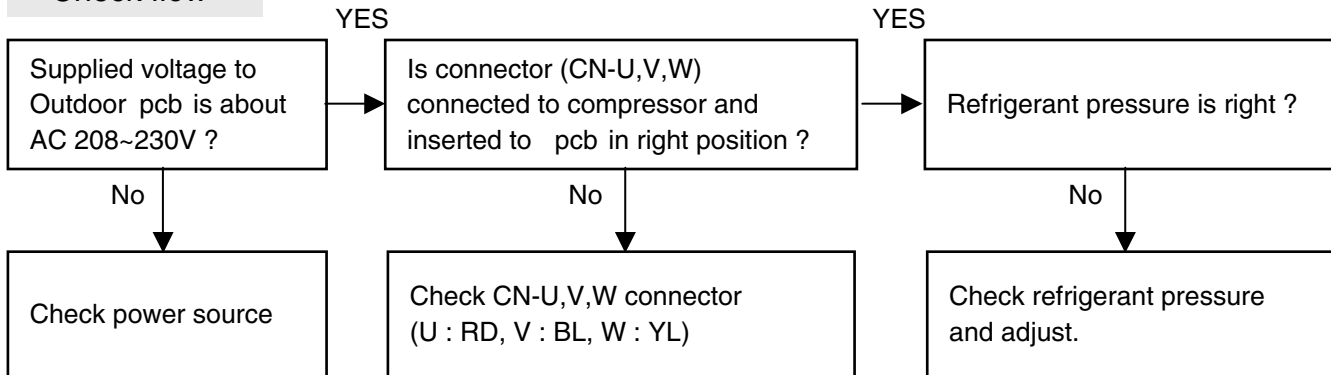

| Error code | Description | Cause of error |
|------------|--------------------------|---|
| 7 | Over current Error (CT2) | <ul style="list-style-type: none"> • Supplied power is not normal • Indoor/outdoor fan is locked • Too much refrigerant • Defect in current sensing circuit in outdoor pcb assembly |

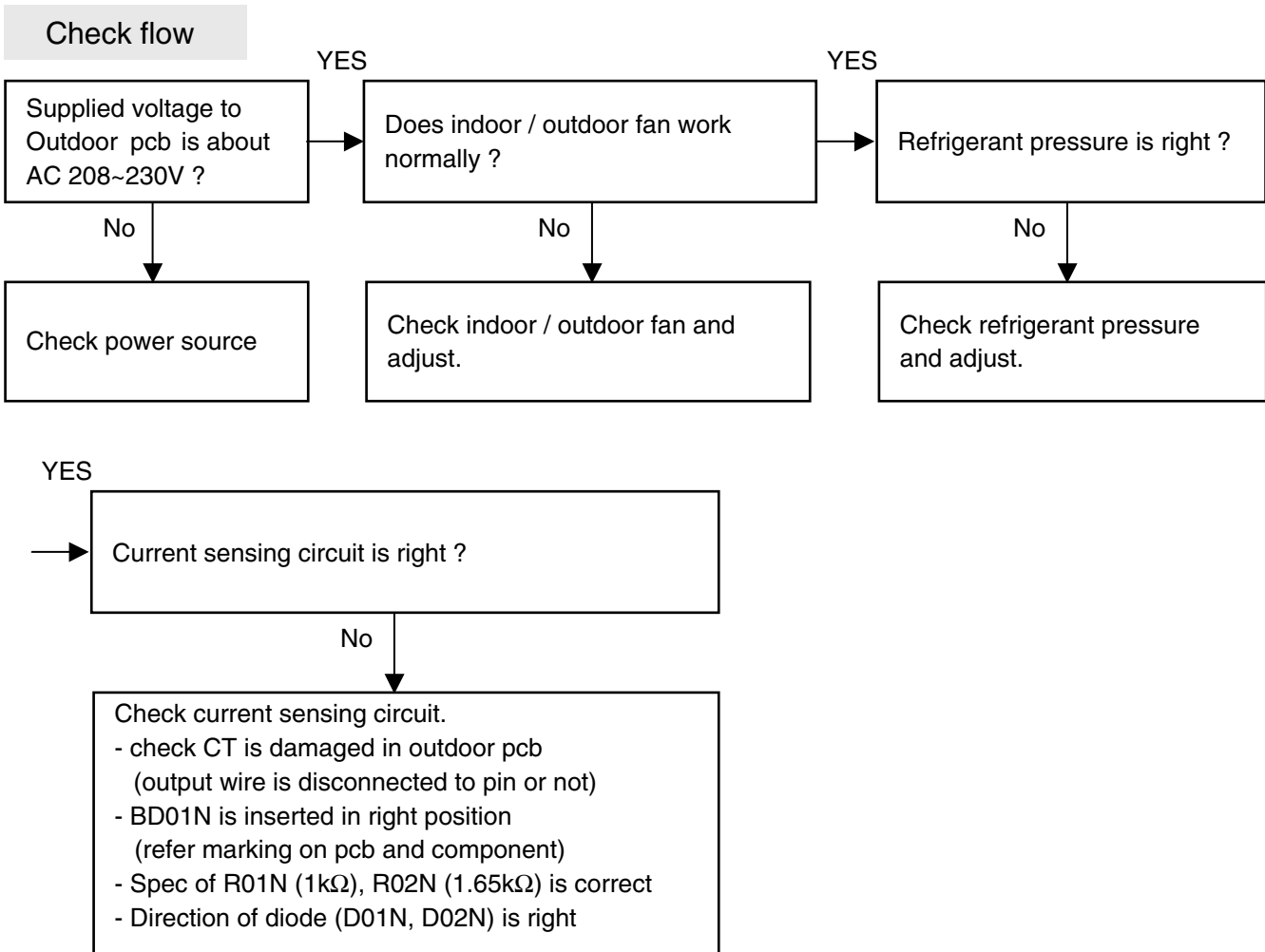

Part 4 Trouble Shooting

| Error code | Description | Cause of error |
|------------|---|---|
| 8 | Indoor fan is locked (BLDC fan model only) | <ul style="list-style-type: none"> Indoor fan is locked or separated Fan connector is not connected to indoor pcb assembly Defective in DC-fan driving circuit |

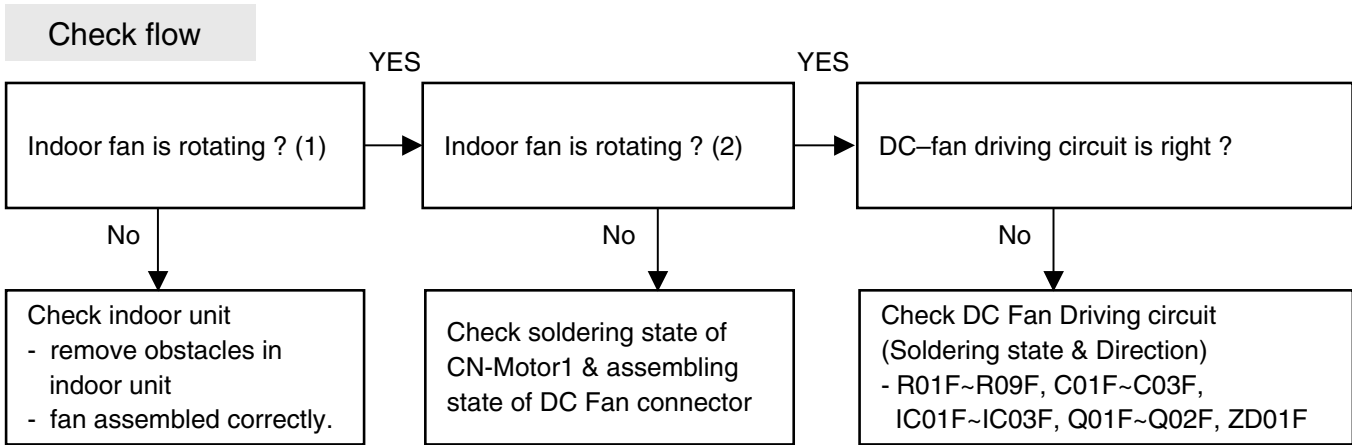

| Error code | Description | Cause of error |
|------------|--|--|
| 9 | Outdoor fan is locked (BLDC fan model only) | <ul style="list-style-type: none"> Outdoor fan is locked by an obstacle (ex : branch of tree, bar...etc) Fan connector is not connected to outdoor pcb assembly Defective in DC-fan driving circuit |

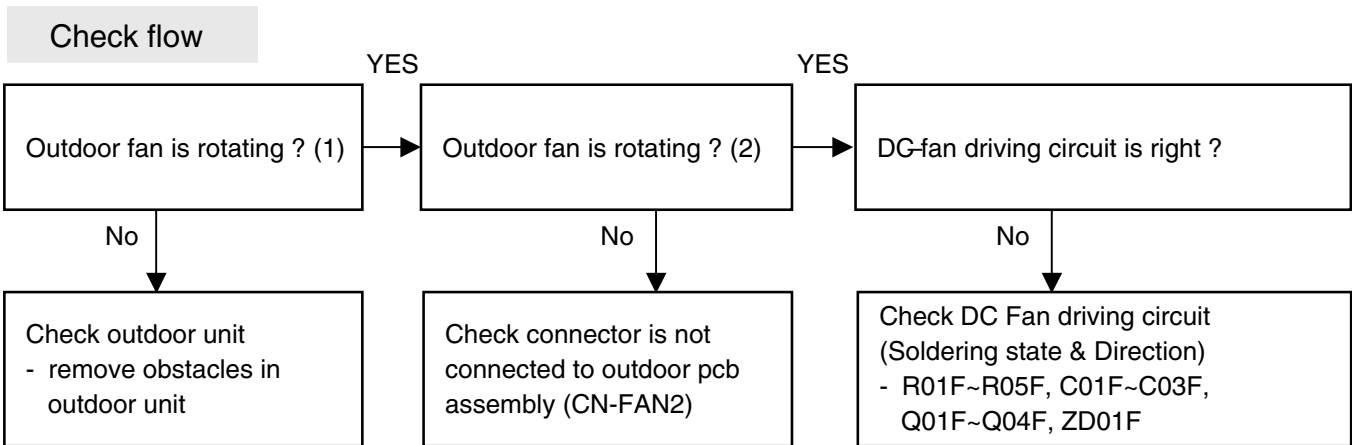

| Error code | Description | Cause of error |
|------------|-----------------------------|---|
| 10 | D-Pipe TH. is short or open | <ul style="list-style-type: none"> • D_pipe TH. is short or open • D_pipe TH. is not connected to the outdoor pcb assembly • Damage or defect on the sensing circuit of outdoor pcb assembly |

Check flow

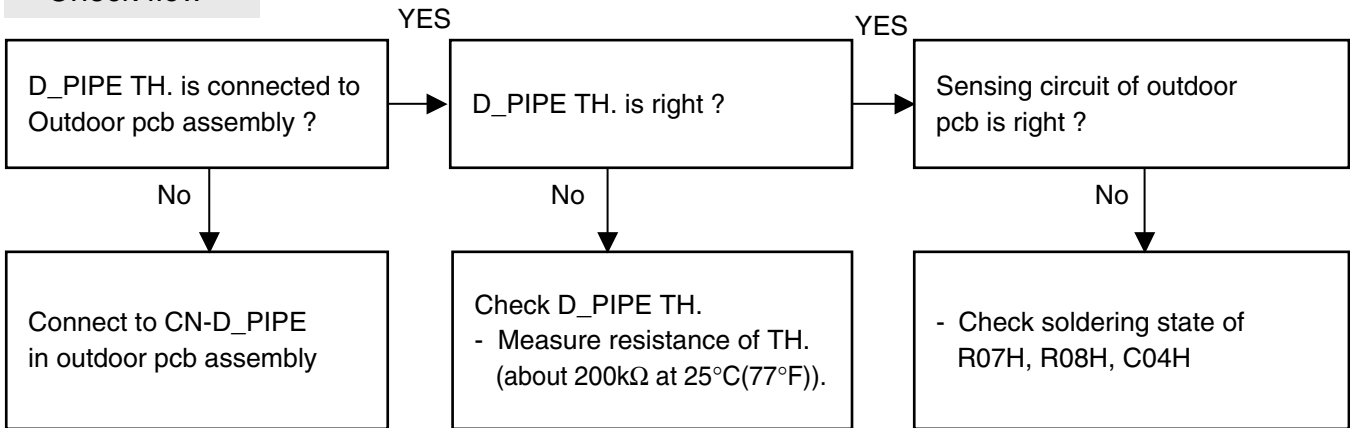

■ Troubleshooting Guide(18,24,30kbtu/h Model)

1) Troubleshooting CH01, CH02, CH06

| Error code | Title | Cause of error | Check point & Normal condition |
|------------|---------------------------|---|--|
| 01 | Indoor air sensor | <ul style="list-style-type: none"> • Open / Short • Soldered poorly • Internal circuit error | Normal resistor : 10kΩ/ at 25°C(77°F) (Unplugged) Normal voltage : 2.5VDC / at 25°C(77°F) (plugged) |
| 02 | Indoor inlet pipe sensor | <ul style="list-style-type: none"> • Open / Short • Soldered poorly • Internal circuit error | Normal resistor : 5kΩ/ at 25°C(77°F) (Unplugged) Normal voltage : 2.5VDC / at 25°C(77°F) (plugged) |
| 06 | Indoor outlet pipe sensor | <ul style="list-style-type: none"> • Open / Short • Soldered poorly • Internal circuit error | Normal resistor : 5kΩ/ at 25°C(77°F) (Unplugged) Normal voltage : 2.5VDC / at 25°C(77°F) (plugged) |

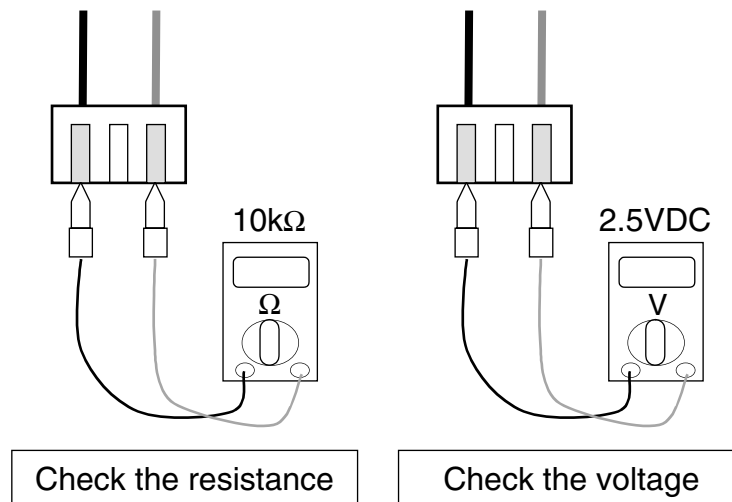

Check Point

1. Unplug the sensor on Indoor unit PCB.
2. Estimate the resistance of each sensor.
3. If the resistance of the sensor is 10kΩ/ 5kΩ at 25°C(77°F), then sensor is normal.
4. If the resistance of the sensor is 0 kΩ or ∞, then sensor is abnormal. → Change the sensor.
5. Plug the sensor on Indoor unit PCB and Power ON.
6. Estimate the voltage of each sensor.
7. If the voltage of the sensor is 2.5VDC at 25°C(77°F), then sensor is normal.
8. If the resistance of the sensor is 0 or 5VDC, then sensor is abnormal. → Repair or Change the PCB.

2) Troubleshooting CH05, CH53

| Error code | Title | Cause of error | Check point & Normal condition |
|---------------|-------------------------------------|------------------------|---|
| 05 / 53 | Communication (Indoor → Outdoor) | • Communication poorly | <ul style="list-style-type: none"> • Power input AC 208~230V. (Outdoor, Indoor) • The connector for transmission is disconnected. • The connecting wires are misconnected. • The GND1,2 is not connected at main GND. • The communication line is shorted at GND. • Transmission circuit of outdoor PCB is abnormal. • Transmission circuit of indoor PCB is abnormal. |

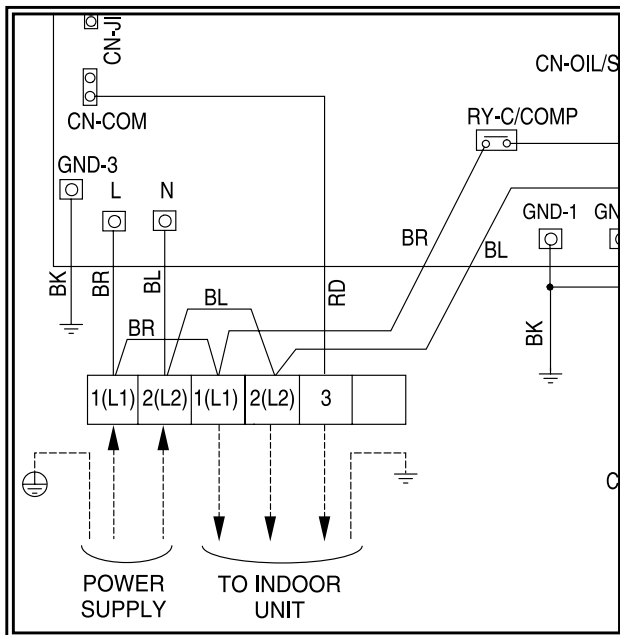

Check Point

1. Check the input power AC 208~230V. (Outdoor, Indoor unit)
 2. Check the communication wires are correctly connected.
 - Adjust the connection of wire
 - Confirm the wire of "Live", "Neutral"
 3. Check the resistance between communication line and GND. (Normal : Over 2MΩ)
 4. Check the connector for communication is correctly connected.
 5. Check the connection of GND1, GND2, and main GND.
 6. If one indoor unit is operated normally, outdoor PCB is no problem.
 - Check the another indoor unit.
- * CH05 is displayed at indoor unit, CH53 is displayed at outdoor unit.

3) Troubleshooting CH21

| Error code | Title | Cause of error | Check point & Normal condition |
|------------|---------|--|--|
| 21 | DC Peak | <ul style="list-style-type: none"> • Instant over current • Over Rated current • Poor insulation of IPM | <ul style="list-style-type: none"> • An instant over current in the U,V,W phase <ul style="list-style-type: none"> - Comp lock - The abnormal connection of U,V,W • Over load condition <ul style="list-style-type: none"> - Overcharging of refrigerant - Pipe length. • Poor insulation of compressor |

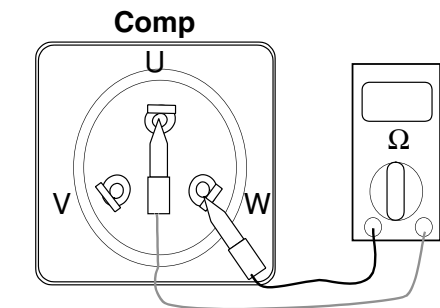

| Resistance(Ω) at 20°C(68°F) | | |
|--------------------------------------|----------------|----------------|
| Terminal | Inverter comp. | Constant comp. |
| U-V | 0.64 | 0.8 |
| V-W | 0.64 | 0.8 |
| W-U | 0.64 | 0.8 |

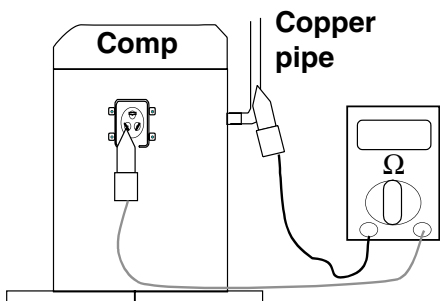

| Resistance(Ω) at 20°C(68°F) | | |
|--------------------------------------|----------------|----------------|
| Terminal | Inverter comp. | Constant comp. |
| U-GND | 2M Ω | 2M Ω |
| V-GND | 2M Ω | 2M Ω |
| W-GND | 2M Ω | 2M Ω |

Check Point

1. Check the wire connection. (U,V,W)
2. Check the load condition. (Refrigerant, Pipe length, ...) → Adjust the load condition
3. Check the electricity leakage of the compressor. → Normal : Over 2M Ω .
4. Check the resistance of compressor. → Normal : 0.65 Ω (INV), 0.8 Ω (Cons.) → No difference at each terminal.
5. Check the insulation from water at IPM part. → Check the trace of water.
6. Check the IPM circuit.

4) Troubleshooting CH21, CH22

| Error code | Title | Cause of error | Check point & Normal condition |
|------------|-------------------------|--|--|
| 21 | DC_Peak | Compressor output current over.(30A ↑) | Check the compressor locking. Check the compressor insulation and motor wire resistance. Check outdoor fan locking,operating. Check the IPM short. |
| 22 | C/T Internal circuit | Initial current error | Check AC input voltage. Check outdoor fan locking,operating. Check input current. Check the C01N DC voltage. (From the condition where the electricity is entering and Before the product operates, Normality Vdc value is $2.5V \pm 0.2V$) |

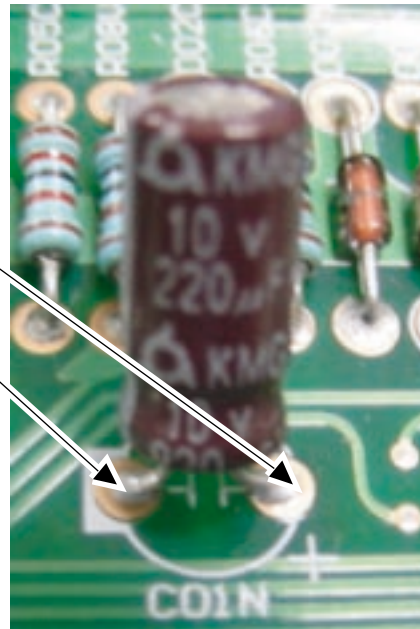
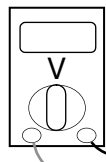
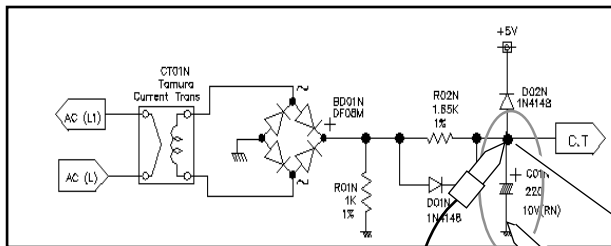

Check Point

1. Check the power source.
2. Check the fan operation is right.
3. Check the current.
4. Check the install condition.
5. Check the internal circuit.

5) Troubleshooting CH23, CH28

| Error code | Title | Cause of error | Check point & Normal condition |
|------------|----------------------|-------------------------------|---|
| 23 | DC Link Low voltage. | • DC link volt. is 140VDC ↓ . | • Check the power source. • Check the DC Link Voltage. |
| 28 | DC Link High voltage | • DC link volt. is 420VDC ↑ . | • Check the power source. • Check the DC Link Voltage. |

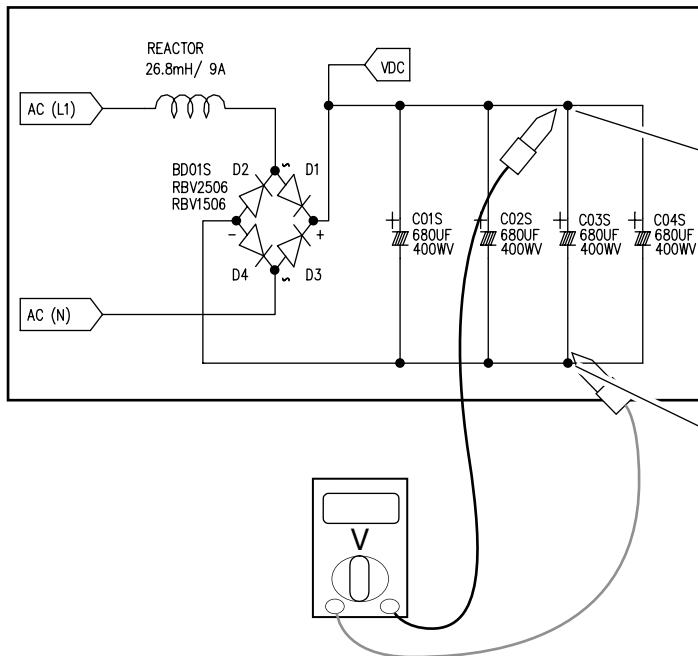

Check Point

1. Check the power source.
2. Check the DC Link Voltage.

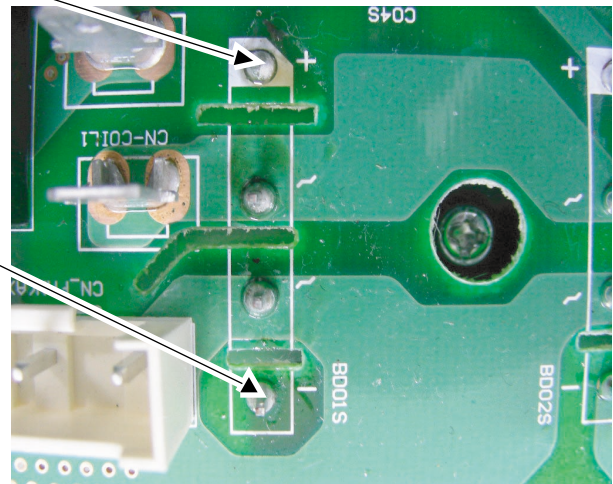

6) Troubleshooting CH24, CH25

| Error code | Title | Cause of error | Check point & Normal condition |
|------------|----------------|---|--|
| 24 | Press S/W Open | <ul style="list-style-type: none"> Low / High press S/W open. | <ul style="list-style-type: none"> Check the connection of "CN_Press". Check the components. |
| 25 | Input voltage | <ul style="list-style-type: none"> Abnormal Input voltage (140VAC ↓ , 300VAC ↑). | <ul style="list-style-type: none"> Check the power source. Check the components. |

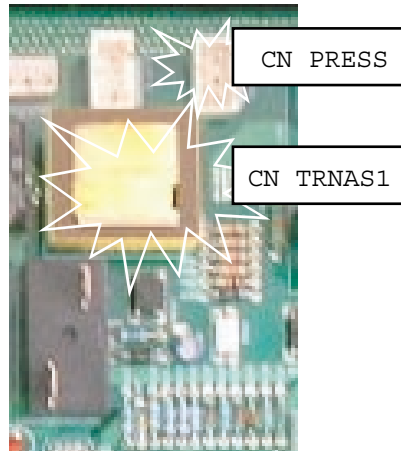
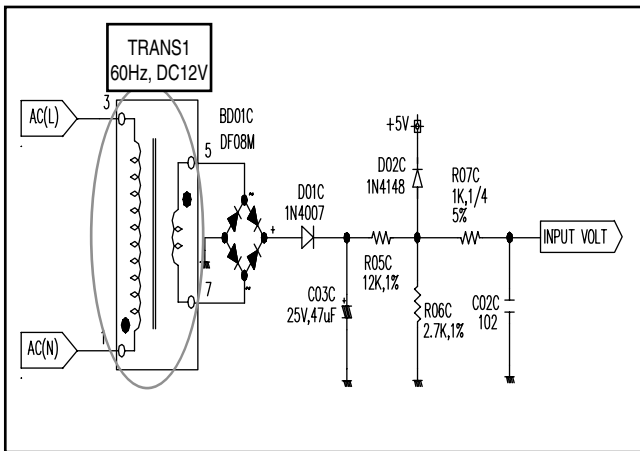

Check Point

• CH 24

1. Check the connection of "CN_PRESS"
2. Check the install condition for over load.
3. Check the SVC V/V open.
4. Check the leakage of refrigerant.

• CH 25

1. Check the power source.
2. Check the components (Trans1, B/Diode, Diode, Resistance)

7) Troubleshooting CH26, CH27

| Error code | Title | Cause of error | Check point & Normal condition |
|------------|------------------------|--|--|
| 26 | DC Compressor Position | <ul style="list-style-type: none"> Compressor position detect error | <ul style="list-style-type: none"> Check the connection of comp wire "U,V,W" Malfunction of compressor Check the component of "IPM", detection parts. |
| 27 | PSC Fault | <ul style="list-style-type: none"> Over current at "IGBT" | Check the Reactor spec. (18k,30k:10A/26.8mH, 24k:13A/13mH * 2) Check AC input voltage. Check outdoor fan locking,operating. Check input current. |

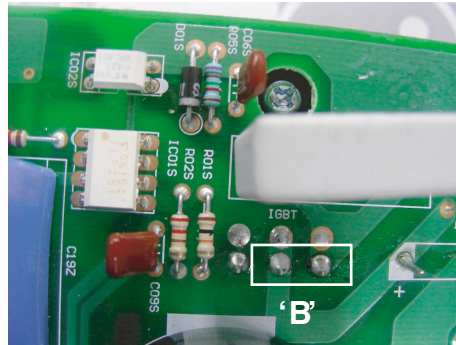
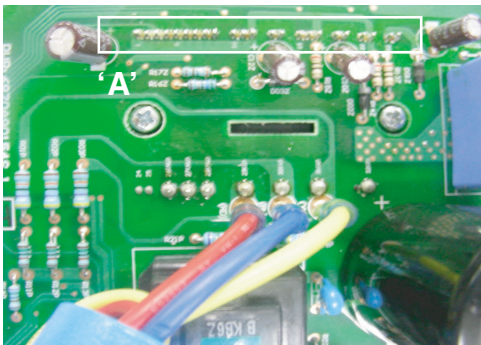

Check Point

• CH 26

- Check the connection of "U, V, W"
- Check the short check point "A"
- Check with the error code "21"

• CH 27

- Check the "IGBT" short point "B"

8) Troubleshooting CH32, CH33, CH40

| Error code | Title | Cause of error | Check point & Normal condition |
|------------|---|---|---|
| 32 | D-pipe (Inverter) temp. high (105°C(221°F) ↑) | <ul style="list-style-type: none"> Discharge sensor (Inverter) temp. high | <ul style="list-style-type: none"> Check the discharge pipe sensor for INV. Check the install condition for over load. Check the leakage of refrigerant. Check the SVC V/V open. |
| 33 | D-pipe (Constant) temp. high (105°C(221°F) ↑) | <ul style="list-style-type: none"> Discharge sensor (Cons.) temp. high | <ul style="list-style-type: none"> Check the discharge pipe sensor for Cons. Check the install condition for over load. Check the leakage of refrigerant. Check the SVC V/V open. |
| 40 | CT Sensor | <ul style="list-style-type: none"> Open/Short Soldered poorly Internal circuit error | <ul style="list-style-type: none"> Normal resistor : about 0Ω |

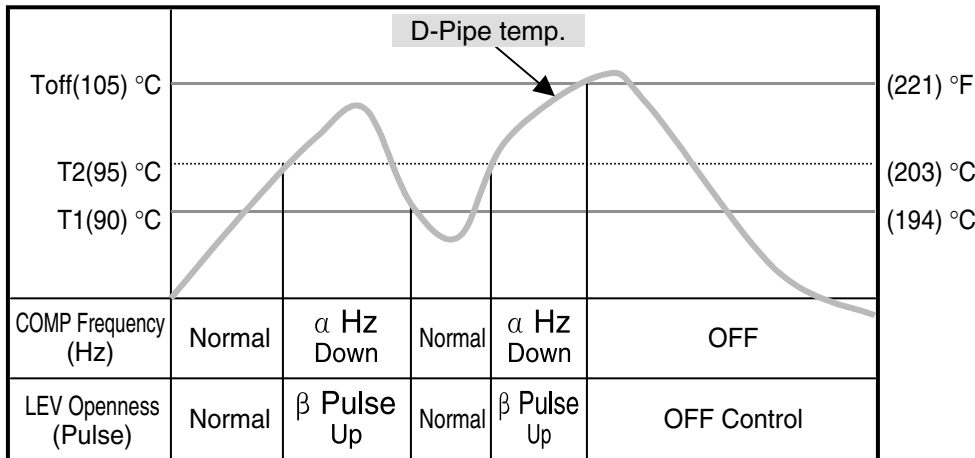

Check Point

• CH 32

1. Check the install condition for over load.
2. Check the SVC V/V open.
3. Check the leakage of refrigerant.

• CH 40

1. If the resistance of the sensor is only ∞ , the check is possible.
2. If the error occurs again after the reset , change the PCB.

• CH 33

1. Check the install condition for over load.
2. Check the SVC V/V open.
3. Check the leakage of refrigerant.
4. Check the constant compressor. (same with CH21)

9) Troubleshooting CH41, CH44, CH45, CH46, CH47, CH65

| Display code | Title | Cause of error | Check point & Normal condition |
|--------------|--------------------------|---|--|
| 41 | D-pipe sensor (Inverter) | <ul style="list-style-type: none"> • Open / Short • Soldered poorly • Internal circuit error | <ul style="list-style-type: none"> • Normal resistor : 200kΩ / at 25°C(77°F) (Unplugged) • Normal voltage : 4.5VDC / at 25°C(77°F) (plugged) |
| 44 | Air sensor | <ul style="list-style-type: none"> • Open / Short • Soldered poorly • Internal circuit error | <ul style="list-style-type: none"> • Normal resistor : 10kΩ / at 25°C(77°F) (Unplugged) • Normal voltage : 2.5VDC / at 25°C(77°F) (plugged) |
| 45 | Condenser Pipe sensor | <ul style="list-style-type: none"> • Open / Short • Soldered poorly • Internal circuit error | <ul style="list-style-type: none"> • Normal resistor : 5kΩ / at 25°C(77°F) (Unplugged) • Normal voltage : 2.5VDC / at 25°C(77°F) (plugged) |
| 46 | Suction Pipe sensor | <ul style="list-style-type: none"> • Open / Short • Soldered poorly • Internal circuit error | <ul style="list-style-type: none"> • Normal resistor : 5kΩ / at 25°C(77°F) (Unplugged) • Normal voltage : 2.5VDC / at 25°C(77°F) (plugged) |
| 47 | D-pipe sensor (Constant) | <ul style="list-style-type: none"> • Open / Short • Soldered poorly • Internal circuit error | <ul style="list-style-type: none"> • Normal resistor : 200kΩ / at 25°C(77°F) (Unplugged) • Normal voltage : 4.5VDC / at 25°C(77°F) (plugged) |
| 65 | Heat sink sensor | <ul style="list-style-type: none"> • Open / Short • Soldered poorly • Internal circuit error | <ul style="list-style-type: none"> • Normal resistor : 10kΩ / at 25°C(77°F) (Unplugged) • Normal voltage : 2.5VDC / at 25°C(77°F) (plugged) |

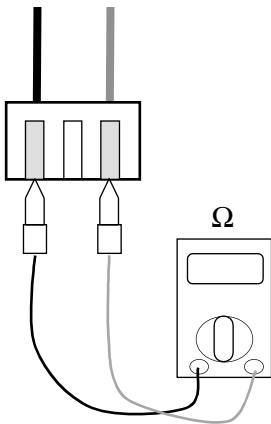

Check Point

1. Estimate the resistance of each sensor.(Unplugged)
2. Estimate the voltage of each sensor.(Plugged)
3. If the resistance of the sensor is 0 k Ω or ∞ , then sensor is abnormal.
If the voltage of the sensor is 0 V or 5VDC, then sensor is abnormal.

Inverter/Constant

| D-Pipe R-T Table | |
|--------------------|----------------|
| Temperature(°C/°F) | Resistance(kΩ) |
| 20/68 | 244 |
| 30/86 | 164.8 |
| 40/104 | 114 |
| 50/122 | 80.6 |
| 60/140 | 58.3 |
| 70/158 | 42.9 |
| 80/176 | 32.1 |
| 90/194 | 24.4 |
| 100/212 | 18.9 |
| 110/230 | 14.8 |
| 120/248 | 11.7 |

| Air R-T Table | |
|--------------------|----------------|
| Temperature(°C/°F) | Resistance(kΩ) |
| 20/68 | 12.5 |
| 30/86 | 8 |
| 40/104 | 5.3 |
| 50/122 | 3.6 |
| 60/140 | 2.5 |
| 70/158 | 1.7 |
| 80/176 | 1.2 |
| 90/194 | 0.9 |
| 100/212 | 0.7 |

Condenser/Suction Pipe

| Pipe R-T Table | |
|--------------------|----------------|
| Temperature(°C/°F) | Resistance(kΩ) |
| 20/68 | 6.3 |
| 30/86 | 4 |
| 40/104 | 2.6 |
| 50/122 | 1.8 |
| 60/140 | 1.2 |
| 70/158 | 0.9 |
| 80/176 | 0.6 |
| 90/194 | 0.4 |
| 100/212 | 0.3 |

| Heatsink R-T Table | |
|--------------------|----------------|
| Temperature(°C/°F) | Resistance(kΩ) |
| 20/68 | 12.5 |
| 30/86 | 8 |
| 40/104 | 5.3 |
| 50/122 | 3.5 |
| 60/140 | 2.5 |
| 70/158 | 1.7 |
| 80/176 | 1.2 |
| 90/194 | 0.9 |
| 100/212 | 0.7 |
| 110/230 | 0.5 |
| 120/248 | 0.4 |

10) Troubleshooting CH51, CH60

| Display code | Title | Cause of error | Check point & Normal condition |
|--------------|---------------------|---|--|
| 60 | EEPROM Check sum | <ul style="list-style-type: none"> • Check sum error | <ul style="list-style-type: none"> • Check the PCB ASM P/No. • Check the poor soldering. |

Check Point

• CH 60

1. Check the insertion condition of EEPROM.
2. Check the poor soldering

11) Troubleshooting CH61, CH62

| Display code | Title | Cause of error | Check point & Normal condition |
|--------------|----------------------------------|--|---|
| 61 | Condenser pipe sensor temp. high | <ul style="list-style-type: none"> Condenser pipe sensor detected high temp.(65°C(149°F)) | <ul style="list-style-type: none"> Check the load condition. Check the sensor of Condenser pipe sensor. |
| 62 | Heat sink sensor temp. high | <ul style="list-style-type: none"> Heat sink sensor detected high temp.(85°C(185°F)) | <ul style="list-style-type: none"> Check the fan is locked. Check the sensor of heat sink. |

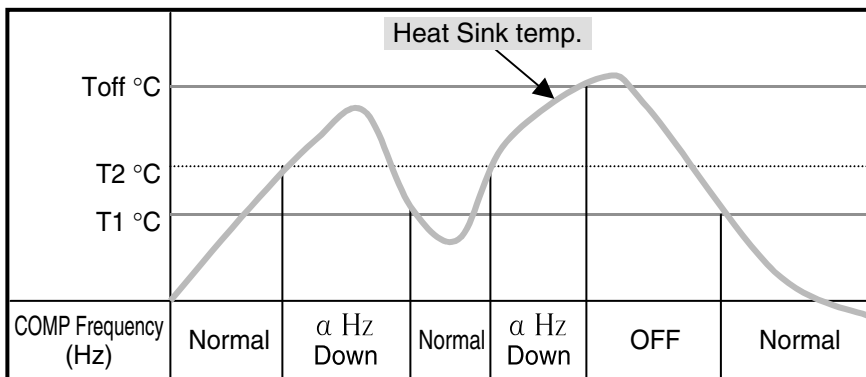

Check Point

• CH 61

1. Check the install condition for over load.
(Refrigerant, Pipe length, Blocked, ...)

• CH 62

1. Check the fan is locked.
2. Check the Outdoor temp. is very high.



P/NO : MFL41161601

JAN. 2008