



ARIVA

Checkout Scale

User's Guide

METTLER TOLEDO

WARNING!

This equipment generates, uses, and can radiate radio frequency energy and if not installed and used properly, i.e., in accordance with the instructions manual, may cause harmful interference to radio communications. It has been tested and found to comply with the limits for a Class A computing device pursuant to Subpart J of Part 15 of FCC Rules, which are designed to provide reasonable protection against such interference when operated in a commercial environment. Operation of this equipment in a residential area is likely to cause interference which case the user at his own expense will be required to take whatever measures may be required to correct the interference.

©Mettler-Toledo, LLC 2013

No part of this manual may be reproduced or transmitted in any form or by any means, electronic or mechanical, including photocopying and recording, for any purpose without the express written permission of Mettler-Toledo, LLC.

U.S. Government Restricted Rights: This documentation is furnished with Restricted Rights.

Publication Revision History

Part Number	Date	Revisions
30206008 R00	01/2013	Official release

Precautions

READ this manual BEFORE operating or servicing this equipment.

FOLLOW these instructions carefully.

SAVE this manual for future reference.

DO NOT allow untrained personnel to operate, clean, inspect, maintain, service, or tamper with this equipment.

ALWAYS DISCONNECT this equipment from the power source before cleaning or performing maintenance.

CALL METTLER TOLEDO® for parts, information, and service.

METTLER TOLEDO® reserves the right to make refinements or changes without notice.

	NOTICE
	<p>TO PREVENT EQUIPMENT DAMAGE Read and understand the operators manual before using the equipment. Failure to follow operating instructions could result in equipment damage.</p>

	WARNING
	<p>ELECTRICAL SHOCK HAZARD Only permit qualified personnel to service this equipment. Exercise care when making checks, tests and adjustments that must be made with power on.</p>

	WARNING
	<p>ELECTRICAL SHOCK HAZARD Connect to a properly grounded outlet only. Do not remove the ground prong. Power outlets must be easily accessible and located no further than the length of the power cord supplied with the product.</p>

	WARNING
	<p>ELECTRICAL SHOCK HAZARD Disconnect and lock out all power to this unit before removing or installing the fuse, cleaning, or servicing.</p>

	NOTICE
	<p>ELECTROSTATIC SENSITIVE DEVICES Observe precautions for handling electrostatic sensitive devices.</p>

	NOTICE
	<p>EQUIPMENT DAMAGE Disconnect power before connecting or disconnecting any internal electronic components or interconnecting wiring between electronic equipment.</p>

CONTENTS

1	Introduction	1-1
	Overview	1-1
	Specifications	1-1
	Geo Values	1-2
	Physical Dimensions	1-3
	Ariva-B.....	1-3
	Ariva-H	1-4
	Ariva-S.....	1-5
	Tower Displays	1-5
	Accessories	1-6
2	Operation	2-1
	Metrological Information	2-1
	Power Up Sequence	2-1
	Environment	2-2
	Leveling the Scale	2-2
	Display and Buttons	2-3
	Weighing	2-3
	Backlight	2-3
	Re-zero	2-4
	Tare Function	2-4
	VCODisp	2-5
	Setup	2-6
	Errors	2-8
	Maintenance	2-9

1

Introduction

Overview

The Ariva family of checkout products all share common technology designed for the point-of-sale checkout environment. The Ariva-B (Bioptic) scales closely integrate with various bioptic scanners. The Ariva-H (Horizontal) scale provides a weighing platform into which single-plane scanners can be placed. The Ariva-S (Stand-Alone) is a stand-alone scale made for the point-of-sale environment. Ariva scales are designed to work with a wide variety of point-of sale terminals.

Specifications

Capacity	Ariva-B & Ariva-H - 30 lb or 15 kg Ariva-S – 15 lb, 30 lbs, 6 kg or 15 kg
Divisions	Ariva-B & Ariva-H - 2 or 5 gram Ariva-S - 1, 2 or 5 gram
Weight display	5 digits
Unit price display	6 digits (price computing version only)
Total price display	6 digits (price computing version only)
Tare display	4 digits (price computing version only)
Operating temperature	-10°C to +40°C
Storage temperature	-25°C to +50°C
Plug in Power supply:	I/P: 230VAC 50Hz (Europe) or 120VAC 60Hz (US) O/P: 9VDC 500mA



Ariva-B (Bioptic)



Ariva-H (Horizontal)



Ariva-S (Stand-alone)
WO (Weight Only)
Tower Display



Geo Values

The GEO-Value of verified scales explains for which location of use the scale has been verified. This GEO-Value is shown on the weight display shortly after power is applied to the scale.

Country	Geo-Width	Geo-Value (default)
Austria	46°22' – 49°01'	18
Belgium	49°30' – 51°30'	20
Bulgaria	41°41' – 44°13'	16
Croatia	42°24' – 46°32'	18
Czechia	48°34' – 51°03'	20
Denmark	54°34' – 57°45'	23
France	41°20' – 51°00'	19
Finland	59°48' – 70°05'	25
Germany	47°00' – 55°00'	20
Greece	34°48' – 41°45'	15
Hungary	45°45' – 48°35'	19
Ireland	51°05' – 55°05'	22
Iceland	63°17' – 67°09'	26
Italy	35°47' – 47°05'	17
Latvia	55°30' – 58°04'	23
Luxembourg	49°27' – 50°11'	20
Liechtenstein	47°03' – 47°14'	18
Lithuania	53°54' – 56°24'	22
Netherlands	50°46' – 53°32'	20
Norway	57°57' – 71°11'	24
Poland	49°00' – 54°30'	21
Portugal	36°58' – 42°10'	15
Romania	43°37' – 48°15'	18
Sweden	55°20' – 69°04'	24
Switzerland	45°49' – 47°49'	18
Slovakia	47°44' – 49°46'	19
Slovenia	45°26' – 46°35'	18
Spain	36°00' – 43°47'	15
Turkey	35°51' – 42°06'	16
United Kingdom	49°00' – 62°00'	21

Physical Dimensions

Ariva-B

Image	Model	Version	Length (L)	Width (W)	Height (H) above counter	Depth (D) below counter
	Ariva-B-D5 for Datalogic Magellan 8300 / 8400	Medium Shelf	15.71" (39.9cm)	11.5" (29.2cm)	5.19" (13.2cm)	4.08" (10.4cm)
		Medium Shelf Flanged	17.84" (45.3cm)	11.5" (29.2cm)	5.19" (13.2cm)	4.08" (10.4cm)
		Long Shelf	17.75" (45.1cm)	11.5" (29.2cm)	5.19" (13.2cm)	4.08" (10.4cm)
		Long Shelf Flanged	19.88" (50.5cm)	11.5" (29.2cm)	5.19" (13.2cm)	4.08" (10.4cm)
	Ariva-B-D7 for Datalogic Magellan 9800i	Medium	15.7" (29.9cm)	11.5" (29.2cm)	2.7" (6.8cm)	4.0" (10.6cm)
	Ariva-B-N3 for NCR RealPOS 7874	N/A	15.7" (39.9cm)	11.5" (29.2cm)	5.1" (13.0cm)	4.0" (10.2cm)

METTLER TOLEDO Ariva User's Guide

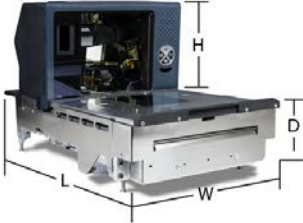
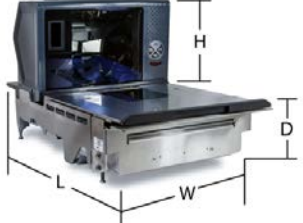
Image	Model	Version	Length (L)	Width (W)	Height (H) above counter	Depth (D) below counter
	Ariva-B-H4 for Honeywell	Unflanged	18.5" (47.0cm)	11.5" (29.2cm)	7" (17.8cm)	4.63" (11.8cm)
	Ariva-B-H5 for Honeywell	Flanged	20" (50.8cm)	11.5" (29.2cm)	7" (17.8cm)	4.63" (11.8cm)

Ariva-H

Image	Model	Version	Length (L)	Width (W)	Depth (D)
	Ariva-H	Without Fill Kit	13.7" (34.8cm)	10.9" (27.7cm)	5.9" (15cm)

Ariva-S

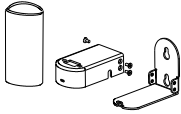
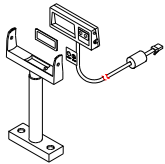
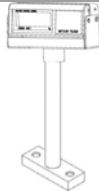

Image	Model	Version	Length (L)	Width (W)	Height (H)
	Ariva-S	N/A	11" (28cm)	12.45" (31.6cm)	2.17" (5.5cm)

Tower Displays

Image	Model	Width (W)	Height (H)
 <p>Price Computing Display Weight Only Display</p>	Price Computing Display	5" (12.7cm)	16.7" (42.4cm)
	Weight Only Display	5.4" (13.7cm)	10.6" (26.9cm)

For cutout dimensions, please see Service Manual.

Accessories

CIMF	Description	Illustration
71208240	Wall Mount Display Accessory	
72191416	WO Dual Display Kit, 30x0.01lb	
72191417	WO Dual Display Kit, 6/15kgX2/5g	
72206860	Dual WO Display, 13"	
72206861	Zero & Tare Keypad	

2

Operation

Metrological Information

The Ariva scale has already been calibrated (according to EN 45501-8.2) but should be checked again upon installation. Calibration must be performed by the certified METTLER TOLEDO service professional. Please contact the METTLER TOLEDO representative.

Retail scales, used in legal for trade applications, must be verified and sealed by an approved agency per the metrological directives. Please contact the local METTLER TOLEDO representative for any questions.

Power Up Sequence

Note: Before powering on the Ariva scale, always make sure there is nothing on the platter.

The Ariva scale is powered directly by the scanner, so it will power up when the scanner is turned on.

The power up sequence is as follows:

- The scale software ID's (version numbers) are displayed during scale start-up.
- To view the software ID's for a longer period of time, double-click the Zero button while in normal weighting mode. In this case the software ID's are shown for 6 seconds on a 4-line display and for 2 seconds each on a 1-line display.

Items displayed during power up sequence are as follows:

- Country and GEO codes
- Software part number
- Weighing Package ID
- Signal Processing ID
- Application software ID
- License indication (if applicable)

	WARNING
	ELECTRICAL SHOCK HAZARD Connect to a properly grounded outlet only. Do not remove the ground prong. Power outlets must be easily accessible and located no further than the length of the power cord supplied with the product.

	NOTICE
	TO PREVENT EQUIPMENT DAMAGE Before connecting the equipment to a power source, first verify the supply voltage matches the voltage requirements listed on the equipment data plate.

Power Consumption

The maximum power consumption when connected to a four line display with the backlight illuminated is 0.6W.

The minimum power consumption when no display is connected or when the backlight is not illuminated is 0.4W.

Environment

Proper environment enhances the operation and longevity of the scale. The following factors could have a negative influence on the scale's operation.

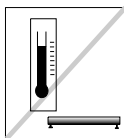

Maintain a temperature range of -10° C to 40° C (14° F to 104° F). Avoid areas where the temperature changes rapidly.

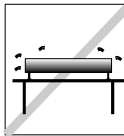

Select a firm, level, vibration-free surface on which to place the scale.

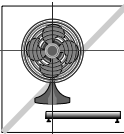

Avoid excessive drafts, such as from fans and open windows.

- Vibration diminishes the scale's ability to measure accurately. Excessive vibration from equipment such as conveyors can cause inaccurate and non-repeatable readings.
- Level the scale properly.
- Air currents can also diminish the scale's performance. Avoid placing the scale in front of or directly under air vents.
- Other than items being weighed, keep the scale free from objects rubbing or pressing against the platter.

Leveling the Scale

- Turn the leveling feet on the scale base until the scale is level. The center pad on the leveling feet should each touch the surface, and the scale should not rock or teeter.
- Check to make sure the level bubble (located underneath the platter) is centered as shown here.
- Level the scale after every location change.

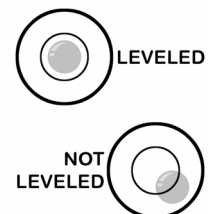

Display and Buttons

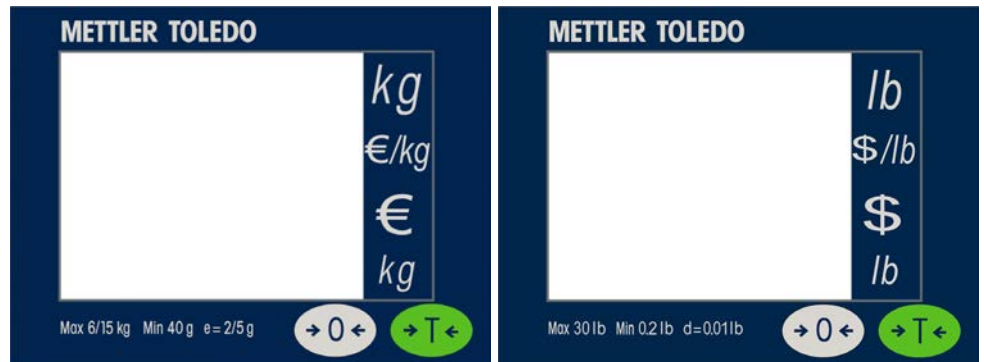

Price Computing Version

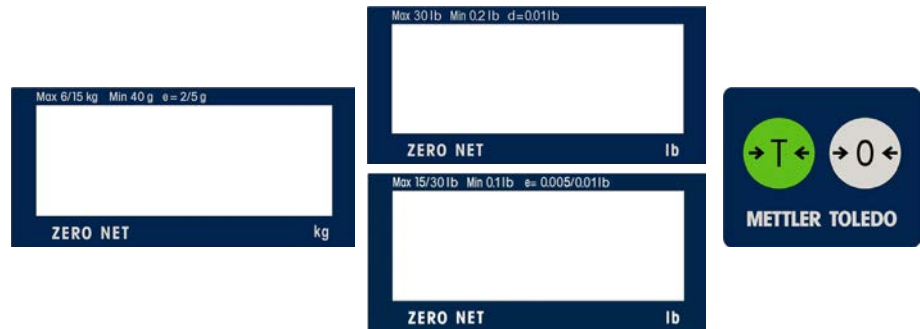

Weight Only Version



Used to return the scale to gross zero if drifting should occur.



Tare key.

The display will show a cursor over NET when tare is entered and over ZERO when gross weight is zero.

Weighing

Place the item to be weighed on the platter and the weight will be displayed. POS protocol commands remotely control most scale functions including data transfer, zero, and tare, depending on the protocol.

Backlight

The Ariva scale is equipped with a backlit display. To save energy, the scale will turn off the backlight when not in use for 60 seconds. The backlight will illuminate when the scale is back in use.

Re-zero

There are two ways to re-zero the scale:

Power-up Zero

The scale will automatically capture zero when it is turned on. The power-up zero capture range is between -2% and +18% of the scale capacity. When the scale is turned on with a weight on the platter of more than +18% of capacity, the scale will not capture zero (the weight display will show "-----"). After removing the excess weight the scale will capture "zero" and be ready for use.

Likewise, if the scale is turned on without its platter, for example, then the scale will be underweight and will not be able to capture zero.

Pushbutton Zero

The ZERO button re-zeros the scale over a range of +/-2% of the scale capacity. To use this function the scale must be in the gross weighing mode (NET cursor must be off) and in a non-motion condition. When the weight on the platter is more than +/-2% of the scale capacity, depressing the zero key will not be accepted.

Tare Function

The Tare button subtracts the weight of items like packaging or wrapping material.

1. Place an empty container or wrapping material on the platter.
2. Press the Tare key.
3. Place the item to be weighed in the container or on the wrapping material on the platter.

Note: A Tare command can also be sent from the POS through the serial connection. Whatever tare method is used to start a transaction must continue to be used until the transaction is completed. If the pushbutton tare is used first, for example, then a POS tare command cannot be used. Conversely, if a POS tare is used first, then the pushbutton tare cannot be used until the current transaction has been completed.

VCODisp

The VCODisp (Virtual Checkout Display) is a software package provided by Mettler-Toledo, used to display legal Weights and Measures data on the POS screens.

If the VCODisp is used it needs to be installed on the POS system and integrated in the POS application. The VCODisp must be licensed for use with the Ariva scale.

Zero, Tare

Normally the Ariva scale is zeroed with pushing the Zero-Button on the display. But usually an Ariva scale used with the VCODisp comes without a physical display. To comply with legal requirements regarding Zero there are three alternatives:

- External Keypad with Tare- and Zero-Buttons.
- Connection to the Zero-Button of the scanner (Tare-Button not available).
- Softbuttons on the VCODisp „weight window“ (if a Touch-Display is used).

When pushing the Tare or Zero Button, the function will be executed and at the same time the VCODisp “scale window” (shown below) will be opened on the POS screen. This window remains open for about 6 seconds.



Keypad



Zero-Button Scanner



Softbuttons on weight window

Indication of version numbers and weight display

The VCODisp can be set up to work with or without a continuously shown “weight window”.

Without the continuously shown “weight window” the real-time weight is not apparent at any time, but only during a weighing operation initiated by the POS system.

The following feature exists to enable service technicians and W&M inspectors to check version numbers of the VCODisp, the scale and to check weighing accuracy.

Pushing the Zero-Button twice in an interval of less than 0.6 seconds (double-click) will open the “information window”, where version information can be checked. Another push on the Zero-Button closes the information window and opens the “scale window”.

The scale window remains open until one of the following events occurs:

- Another double-click on the Zero-Button.
- After the next weighing operation initiated by the POS system.
- Automatically after about 15 minutes.

Scale Model: ARIVA
SW-ID: WP: 2.0.0
DSP: 1.70.28
Appl.: D 1.121

METTLER TOLEDO

VCODisp

Version: 1.02.11
CRC: 57D690E4
Mettler - Toledo (Albstadt) GmbH
TC7285

Version Dialog 06: d93-09-104 01

0.000 kg

0.00 €/kg

0.00 €

METTLER TOLEDO Max. 6/15 kg Min. 40 g e = 2/5 g

Information Window

Scale Window

Setup

The scale is configurable for specific needs by changing soft switches directly from the keyboard. While turning on the power, press and hold the >0< button until "grP 1" is displayed. To access the various prompts, utilize the following keys during the scale setup mode.

Note that only a limited number of parameters can be configured in User mode. See the Service Manual for a description of how to enter service mode.



Zero button is used to confirm a choice and then go to the next step.



Tare button is used to step through the set up groups. Once a group is selected, this key is used to select the specific soft switch settings.

Group.Step		Function	Possible Selections
Group 1			Press Zero to Enter Group 1 Press Tare to go to Group 2
1.10	Language (only use with new text display.)		TBD
Group 3			Press Zero to Enter Group 3 Press Tare to go to Group 4
3.1	Communication Type		0 – RS-232 1 – USB Virtual COM ports (USB Ser/CDC) 2 – USB MTSerial HID (USB Ser/HID) 3 – USB HID POS 4 – USB IBM OEM HID
RS-232 only	3.2	Baud rate	0 – 1200 1 – 2400 2 – 4800 3 – 9600 4 – 19,200 5 – 38,400 6 – 57,600 7 – 115,200
	3.3	Parity	0 – None 1 – Even 2 – Odd
	3.4	Data bits	0 – 7 data bit 1 – 8 data bit
	3.5	Stop bits	0 – None 1 – 1 stop bit 2 – 2 stop bit

Only if 3.1 = RS-232 or Virtual COM ports.	3.6	Protocol Selection	0 = Disabled 1 = (reserved) 2 = NCI Weightronix (WO/PC) 3 = 8217 Mettler-Toledo (WO) 4 = 8213 Mettler-Toledo (WO) 5 = EPOS 1 (WO) 6 = EPOS 2 (WO) 7 = SL4700/TEC MA 8 = Dialog 06 (PC) 9 = Dialog 04/02 (PC) 10 = Extended Dialog 06 (PC) 11 = ICL (WO) 12 = Shekel (WO) 13 = RIVA 5462/Nixdorf 2 (WO) 14 = IP3 (PC) 15 = (reserved) 16 = (reserved)
	3.7	Reserved Protocol Option	0 – 4 byte 1 – 2 byte <i>Note: Most users can ignore this option.</i>
Only if 3.6 = HSM Interface	3.8	Reserved	
	3.9	Reserved	
Group 4		Press Zero to Enter Press Tare to go to Group 5	
4.1	Button Tare Enable	ON – Enables tare button function. OFF – Disables tare button function. <i>Note: This function only applies to push button tares (it does <u>not</u> apply to preset tares.)</i>	
4.2	Chain Tare Enable	ON – Enables multiple tares. OFF – Only one tare per transaction is allowed.	
4.3	Auto-clear of Button Tare	ON – Tare is automatically cleared when weight is removed. OFF – Tare is not cleared when weight is removed. <i>Note: This function only applies to push button tares (it does <u>not</u> apply to preset tares.)</i>	
Group 5		Press Zero to Enter Press Tare to go to Group 6	
Group.Step	Function	Possible Selections	
5.1	Beeper	0 – No beeper.* 1 – Scale beeps only when Keypad is pressed. 2 – Scale beeps only when data is sent to POS. 3 – Scale beeps with both POS data and keypad press. <i>*Note: The calibration button always beeps.</i>	
5.2	Blank Weight Enable	ON – Only display stable weight. - Display will be blank during weight settling time. OFF – Display weight all the time (even if unstable.) <i>Note: When disabled (OFF) the weight settling time will appear to be faster because the final weight will be displayed before it has been determined to be stable.</i>	
5.3	Zero cursor	ON – Enable (display) zero cursor. OFF – Disable zero cursor. <i>Note: when the scale is at zero the ZERO cursor will be illuminated, depending upon this option.</i>	

5.4	Display Type	0 – None 1 – 1 Line 2 – 4 Line 3 – new display <i>Note: If an auto-detected display is used then the detected display type will over-ride the menu setting.</i>
5.5	Reserved	Reserved
EXIT		Press Zero to Enter Press Tare to go to Group 1
SAVE	Save or abort setting	SAVE – save all settings and reboot. ABORT – abort all settings and return to weighing mode.

* Used only on the 4 Line display

PC – Price Computing; WO – Weight Only

Errors

The following table lists error messages, descriptions, and corrective actions.

Error Codes and Actions

E 10 nn	System error	Cycle power to the scale. For continued problems call METTLER TOLEDO for replacement
E 12 nn	Data error	
E 18 nn	EEPROM error	
E 22 nn	Legal for trade error	
E 20 nn	Calibration error	Cycle power to the scale and restart calibration.
E 28 nn	Communication Error	Check scale communications parameters (via the menu) to insure they are the same as the POS system.
nnnnnn in weight display	Over capacity	Remove weight from Platter, if that does not work try cycling the power to the scale. For continued problems call METTLER TOLEDO for replacement.
nnnnnnn in total price display	Over 99999.99	Price too large for display.
uuuuuu in weight display	Under zero	Place the platter on the scale. Either press the Zero Key or cycle power to the scale. For continued problems call METTLER TOLEDO for replacement.

- The “nn” after each error code are two numbers used to uniquely identify an error. Please record this number and report this specific error to METTLER TOLEDO along with the general error.

Maintenance

- Remove power by unplugging the scale from the scanner or by removing the wall outlet.
- Use a clean, damp cloth to wipe the exterior surfaces.
- DO NOT use solvents and chemicals to clean the unit.
- DO NOT attempt to remove the cover or perform service or maintenance on the internal parts of the scale.

METTLER TOLEDO

For your notes



METTLER TOLEDO Service



Quality Management System certification.

Development, production, and auditing in accordance with ISO9001. Environmental management system in accordance with ISO14001.

Worldwide service.

Our dense service network, among the best in the world, ensures the maximum availability and lifespan of your product.

Conformité Européene.

This label is your guarantee that our products conform to the latest guidelines.

On the Internet.

You can find important information about our products and services, as well as our company, quickly and easily at <http://www.mt.com/support>

METTLER TOLEDO

1900 Polaris Parkway
Columbus, Ohio 43240
www.mt.com

METTLER TOLEDO® is a registered
trademark of Mettler-Toledo, LLC
©2012 Mettler-Toledo, LLC



30206008