BUNN®

trifecta®



INSTALLATION & OPERATING GUIDE

BUNN-O-MATIC CORPORATION

POST OFFICE BOX 3227

SPRINGFIELD, ILLINOIS 62708-3227

PHONE: (217) 529-6601 FAX: (217) 529-6644

To ensure you have the latest revision of the Operating Manual, or to view the Illustrated Parts Catalog, Programming Manual, or Service Manual, please visit the Bunn-O-Matic website, at www.bunn.com. This is absolutely FREE, and the quickest way to obtain the latest catalog and manual updates. For Technical Service, contact Bunn-O-Matic Corporation at 1-800-286-6070.



BUNN-O-MATIC COMMERCIAL PRODUCT WARRANTY

Bunn-O-Matic Corp. ("BUNN") warrants equipment manufactured by it as follows:

- 1) Airpots, thermal carafes, decanters, GPR servers, iced tea/coffee dispensers, MCP/MCA pod brewers thermal servers and ThermoFresh servers (mechanical and digital)- 1 year parts and 1 year labor.
- 2) All other equipment - 2 years parts and 1 year labor plus added warranties as specified below:
 - a) Electronic circuit and/or control boards - parts and labor for 3 years.
 - b) Compressors on refrigeration equipment - 5 years parts and 1 year labor.
 - c) Grinding burrs on coffee grinding equipment to grind coffee to meet original factory screen sieve analysis - parts and labor for 4 years or 40,000 pounds of coffee, whichever comes first.

These warranty periods run from the date of installation BUNN warrants that the equipment manufactured by it will be commercially free of defects in material and workmanship existing at the time of manufacture and appearing within the applicable warranty period. This warranty does not apply to any equipment, component or part that was not manufactured by BUNN or that, in BUNN's judgment, has been affected by misuse, neglect, alteration, improper installation or operation, improper maintenance or repair, non periodic cleaning and descaling, equipment failures related to poor water quality, damage or casualty. In addition, the warranty does not apply to replacement of items subject to normal use including but not limited to user replaceable parts such as seals and gaskets. This warranty is conditioned on the Buyer 1) giving BUNN prompt notice of any claim to be made under this warranty by telephone at (217) 529-6601 or by writing to Post Office Box 3227, Springfield, Illinois 62708-3227; 2) if requested by BUNN, shipping the defective equipment prepaid to an authorized BUNN service location; and 3) receiving prior authorization from BUNN that the defective equipment is under warranty.

THE FOREGOING WARRANTY IS EXCLUSIVE AND IS IN LIEU OF ANY OTHER WARRANTY, WRITTEN OR ORAL, EXPRESS OR IMPLIED, INCLUDING, BUT NOT LIMITED TO, ANY IMPLIED WARRANTY OF EITHER MERCHANTABILITY OR FITNESS FOR A PARTICULAR PURPOSE. The agents, dealers or employees of BUNN are not authorized to make modifications to this warranty or to make additional warranties that are binding on BUNN. Accordingly, statements by such individuals, whether oral or written, do not constitute warranties and should not be relied upon.

If BUNN determines in its sole discretion that the equipment does not conform to the warranty, BUNN, at its exclusive option while the equipment is under warranty, shall either 1) provide at no charge replacement parts and/or labor (during the applicable parts and labor warranty periods specified above) to repair the defective components, provided that this repair is done by a BUNN Authorized Service Representative; or 2) shall replace the equipment or refund the purchase price for the equipment.

THE BUYER'S REMEDY AGAINST BUNN FOR THE BREACH OF ANY OBLIGATION ARISING OUT OF THE SALE OF THIS EQUIPMENT, WHETHER DERIVED FROM WARRANTY OR OTHERWISE, SHALL BE LIMITED, AT BUNN'S SOLE OPTION AS SPECIFIED HEREIN, TO REPAIR, REPLACEMENT OR REFUND.

In no event shall BUNN be liable for any other damage or loss, including, but not limited to, lost profits, lost sales, loss of use of equipment, claims of Buyer's customers, cost of capital, cost of down time, cost of substitute equipment, facilities or services, or any other special, incidental or consequential damages.

392, AutoPOD, AXIOM, BrewLOGIC, BrewMETER, Brew Better Not Bitter, BrewWISE, BrewWIZARD, BUNN Espresso, BUNN Family Gourmet, BUNN Gourmet, BUNN Pour-O-Matic, BUNN, BUNN with the stylized red line, BUNNlink, Bunn-OMatic, Bunn-O-Matic, BUNNserve, BUNNSERVE with the stylized wrench design, Cool Froth, DBC, Dr. Brew stylized Dr. design, Dual, Easy Pour, EasyClear, EasyGard, FlavorGard, Gourmet Ice, Gourmet Juice, High Intensity, iMIX, Infusion Series, Intellisteam, My Café, Phase Brew, PowerLogic, Quality Beverage Equipment Worldwide, Respect Earth, Respect Earth with the stylized leaf and coffee cherry design, Safety-Fresh, savemycoffee.com, Scale-Pro, Silver Series, Single, Smart Funnel, Smart Hopper, SmartWAVE, Soft Heat, SplashGard, The Mark of Quality in Beverage Equipment Worldwide, ThermoFresh, Titan, trifecta, Velocity Brew, A Partner You Can Count On, Air Brew, Air Infusion, Beverage Bar Creator, Beverage Profit Calculator, Brew better, not bitter., BUNNSource, Coffee At Its Best, Cyclonic Heating System, Daypart, Digital Brewer Control, Nothing Brews Like a BUNN, Pouring Profits, Signature Series, Tea At Its Best, The Horizontal Red Line, Ultra are either trademarks or registered trademarks of Bunn-O-Matic Corporation.

CONTENTS

| | |
|---|----|
| Warranty | 2 |
| Introduction | 3 |
| User Notices | 3 |
| Electrical Requirements | 4 |
| Plumbing Requirements | 5 |
| Initial Setup..... | 6 |
| Coffee Brewing..... | 7 |
| Adjusting Brewing Parameters..... | 8 |
| Cleaning..... | 10 |
| Front Panel Removal & Tank Draining..... | 12 |
| Advanced Adjustments & Optional Settings..... | 13 |

INTRODUCTION

This equipment is factory set to brew approximately 2-16 ounces of coffee into a cup. It is only for indoor use on a sturdy counter or shelf. Replace any unreadable or damaged labels.

!!!FOR USE BY TRAINED PERSONNEL ONLY!!!

IMPORTANT SAFE GUARDS

- DO NOT:** Pick up brewer by handles;
 - DO NOT:** Allow untrained personnel to operate this equipment;
 - DO NOT:** Use parts that show any signs of wear or damage;
 - DO NOT:** Put plastic parts in dishwasher, or use corrosive or abrasive cleaners;
 - DO NOT:** Fail to inspect brew chamber, brew cup, seals and related parts daily for damage/wear and tear;
 - DO NOT:** Fail to do recommended preventive maintenance;
 - DO NOT:** Operate brewer with missing or damaged parts;
 - DO NOT:** Open brew chamber during brew cycle;
 - DO NOT:** Open brew chamber when hot water is present;
- USE CAUTION WHEN REMOVING BREW/GROUNDS CUP, HOT LIQUID MAY BE PRESENT.**

RECOMMENDED PREVENTIVE MAINTENANCE

- **SEALS/O-rings:** Brew chamber top seal, brew cup upper & lower seals. Clean & inspect daily. Replace if loose, cracked or damaged.
- **Brew cup assembly & chamber:** Clean & inspect daily. Replace if cracked or damaged.
- **Check valve:** Clean & inspect daily. Replace if cracked or damaged.
- **Top clamp mechanism:** Inspect daily for smooth operation. Clean & lube guides as needed to ensure smooth operation.

USER NOTICES



#00824.0002



#37280.0001

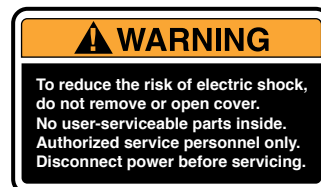

#37881.0000



#00986.0002

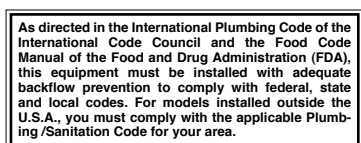

#00656.0001

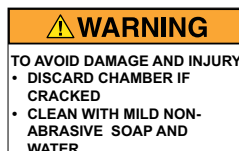

#43022.0000



#41177.0001

ELECTRICAL REQUIREMENTS

CAUTION - The brewer must be disconnected from the power source until specified in *Initial Set-Up*.

Refer to Data Plate on the Brewer, and local/national electrical codes to determine circuit requirements.



**100V & 120V
Models**



230 VOLT CE Model

Note: This electrical service consists of 2 current carrying conductors (L1 and Neutral) and a separate conductor for chassis ground.

Electrical Hook-Up

CAUTION – Improper electrical installation will damage electronic components.

1. An electrician must provide electrical service as specified.
2. Using a voltmeter, check the voltage and color coding of each conductor at the electrical source.
3. If plumbing is to be hooked up later be sure the brewer is disconnected from the power source. If plumbing has been hooked up, the brewer is ready for Initial Set-Up.

CE REQUIREMENTS

- This appliance must be installed in locations where it can be overseen by trained personnel.
- For proper operation, this appliance must be installed where the temperature is between 5°C to 35°C.
- Appliance shall not be tilted more than 10° for safe operation.
- An electrician must provide electrical service as specified in conformance with all local and national codes.
- This appliance must not be cleaned by water jet.
- This appliance is not intended for use by persons (including children) with reduced physical, sensory or mental capabilities, or lack of experience and knowledge, unless they have been given instructions concerning use of this appliance by a person responsible for its safety.
- Children should be supervised to ensure they do not play with the appliance.
- If the power cord is ever damaged, it must be replaced by the manufacturer or authorized service personnel with a special cord available from the manufacturer or its authorized service personnel in order to avoid a hazard.
- Machine must not be immersed for cleaning.

PLUMBING REQUIREMENTS

These brewers must be connected to a cold water system with operating pressure between 20 and 90 psi (138 and 620 kPa) from a ½" or larger supply line. A shut-off valve should be installed in the line before the brewer. Install a regulator in the line, when pressure is greater than 90 psi (620 kPa) to reduce it to 50 psi (345 kPa). The water inlet fitting is ¼" flare fitting. Bunn-O-Matic does not recommend the use of a reverse-osmosis or deionized water supply to this equipment.

NOTE - Bunn-O-Matic recommends ¼" copper tubing for installations of less than 25 feet and ⅜" for more than 25 feet from the ½" water supply line. A tight coil of tubing in the water line will facilitate moving the brewer to clean the counter top. Bunn-O-Matic does not recommend the use of a saddle valve to install the brewer. The size and shape of the hole made in the supply line by this type of device may restrict water flow.

A water filtration system must be installed for brewers used in hard water areas.

As directed in the International Plumbing Code of the International Code Council and the Food Code Manual of the Food and Drug Administration (FDA), this equipment must be installed with adequate backflow prevention to comply with federal, state and local codes. For models installed outside the U.S.A., you must comply with the applicable Plumbing /Sanitation Code for your area.

NOTE - If a back flow preventer is required by code, a shock arrestor should be installed between back flow preventer and dispenser. Installing the shock arrestor as close to the dispenser as possible will provide the best results.

Plumbing Hook-Up

1. Flush the water line.
2. Securely attach ¼" water supply line to the elbow.
3. Secure cord and water supply line under the retainer strap in any of the three locations as needed. (Only 1 strap included)
4. Turn on the water supply.



Optional Drain Hook-Up

1. Remove drip tray and the chrome plug from the base.
2. Drill out the auxiliary outlet of the drip tray with a ½" drill bit.
3. Secure ⅝" hose to drip tray, routing it through the opening in the base assembly.
4. Connect hose to drain line as needed.
5. Install drip tray.

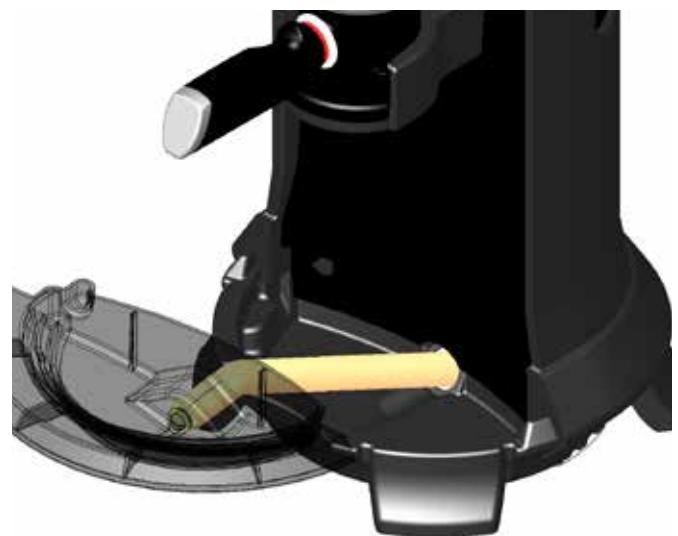

INITIAL SET-UP

1. Install check valve. Refer to pictures on page 10.
2. Install clear brew chamber and empty brew cup. Lock chamber in place.
3. Place an empty container that holds at least 20 ounces under the brew chamber.
4. Connect the brewer to the power source.
5. Press the brew start switch. Water will flow into the brew tank. Some excess water will flow into the container below and the brew cup.
6. Wait approximately five minutes for the water in the tank to heat to the proper temperature. Display will show **"HEATING"** until tank reaches it's operating temperature. Some water will drip from the brew chamber during this time; this is due to expansion and should not occur thereafter. Any excess water in the brew chamber will be automatically purged at the end of the initial setup.
7. Water volumes and flow settings have been preset at the factory. Refer to "Adjusting Brewing Parameters" section of this manual should the volume need to be increased or decreased.
8. The brewer is now ready for use in accordance with the instructions for Coffee Brewing.

Brew water temperature is factory set at 200° F (93.3° C). Areas of high altitude will require lowering this temperature to prevent boiling. This chart should be used as a guide when readjusting the brew water temperature.

| Altitude (Feet) | Boiling point of water | | Recommended water temperature | |
|--------------------|---------------------------|-------|----------------------------------|------|
| | ° F | ° C | ° F | ° C |
| -1000 | 213.8 | 101.0 | 200 | 93.3 |
| -500 | 212.9 | 100.5 | 200 | 93.3 |
| 0 | 212.0 | 100.0 | 200 | 93.3 |
| 500 | 211.1 | 99.5 | 200 | 93.3 |
| 1000 | 210.2 | 99.0 | 200 | 93.3 |
| 1500 | 209.3 | 98.5 | 200 | 93.3 |
| 2000 | 208.4 | 98.0 | 200 | 93.3 |
| 2500 | 207.4 | 97.4 | 200 | 93.3 |
| 3000 | 206.5 | 96.9 | 199 | 92.8 |
| 3500 | 205.6 | 96.4 | 198 | 92.2 |
| 4000 | 204.7 | 95.9 | 197 | 91.7 |
| 4500 | 203.8 | 95.4 | 196 | 91.1 |
| 5000 | 202.9 | 94.9 | 195 | 90.6 |
| 5500 | 201.9 | 94.4 | 195 | 90.6 |
| 6000 | 201.0 | 93.9 | 194 | 90.0 |
| 6500 | 200.1 | 93.4 | 193 | 89.4 |
| 7000 | 199.2 | 92.9 | 192 | 88.9 |
| 7500 | 198.3 | 92.4 | 191 | 88.3 |
| 8000 | 197.4 | 91.9 | 190 | 87.8 |
| 8500 | 196.5 | 91.4 | 189 | 87.2 |
| 9000 | 195.5 | 90.8 | 188 | 86.7 |
| 9500 | 194.6 | 90.3 | 187 | 86.1 |
| 10000 | 193.7 | 89.8 | 186 | 85.6 |

NOTE: If brewer has been drained/moved, perform "Reset to first time" procedure on page 11.

OPERATING CONTROLS

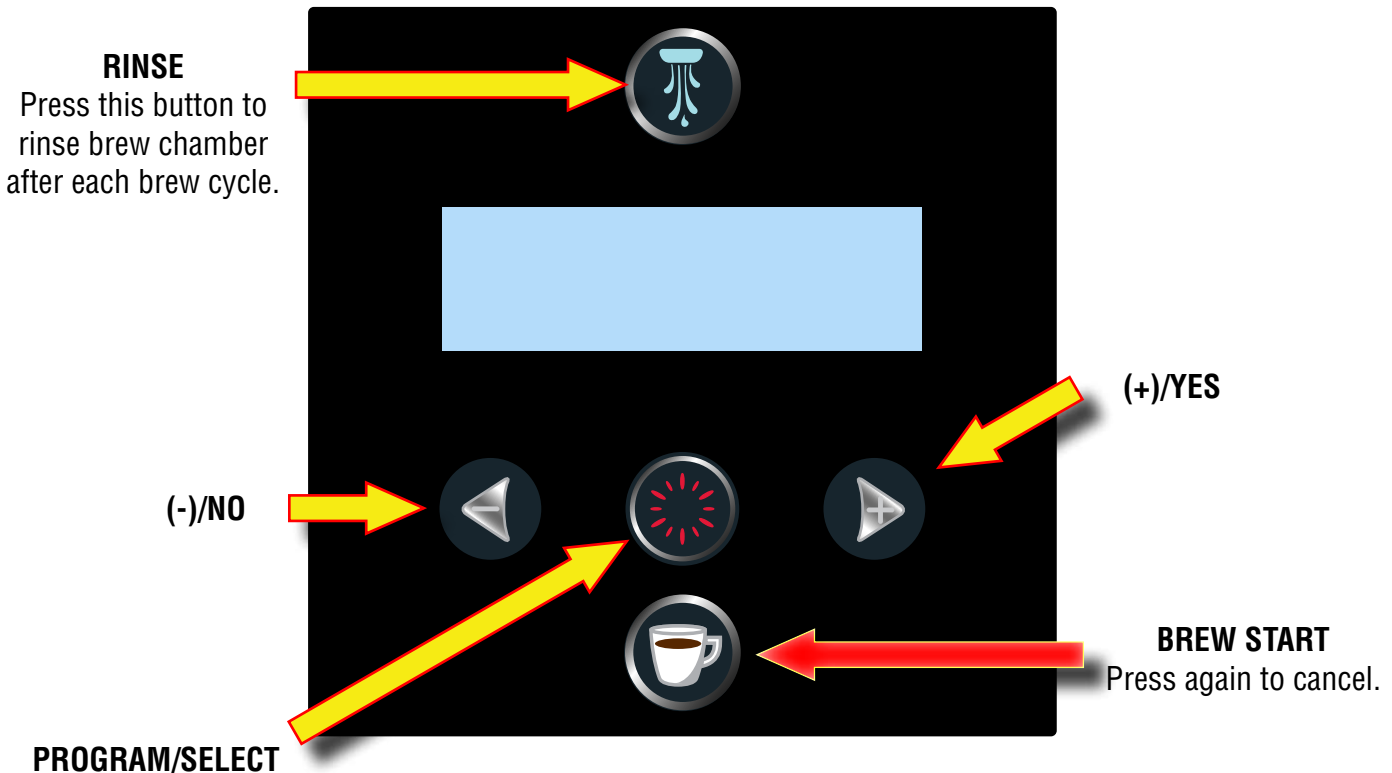



COFFEE BREWING

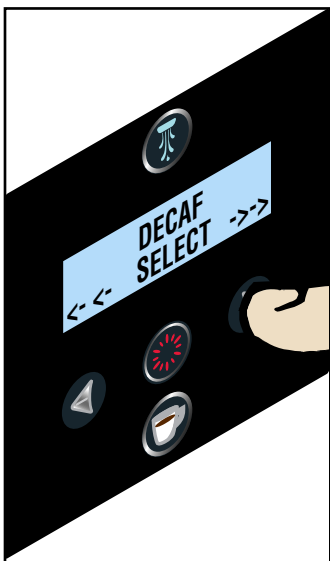

1. Lift handle all the way up.
2. Remove cup assembly. Verify screen is locked into grounds cup. Fig 1.
3. Fill with desired amount of ground coffee.

4. Place brew cup under brew chamber.
5. Place cup on drip tray .
6. Push handle all the way down to lock brew chamber.



7. Scroll through recipes using arrow  buttons.





8. Press "SELECT"  button for your recipe.



FIG 1

9. A. If your brewing parameters are already set, you may simply press the "BREW"  button to start a brew cycle.
- B. To set up specific parameters for a particular recipe, verify the recipe name is currently displayed. Press "SELECT" , display will read "VOLUME".

CONTINUED ON NEXT PAGE

ADJUSTING BREWING PARAMETERS

HOUSE SPECIAL
- **VOLUME 8 oz** +

Press ◀ to reduce or ▶ to increase.
DEFAULT: 8 oz, RANGE: 2 - 16
Adjust the desired brew volume.



PRE-WET
- **.0 Secs** +

Press ◀ to reduce or ▶ to increase.
DEFAULT: .0, Range: .0-1.0 seconds
Pre-wet of ambient water on top of the coffee grounds.



PRE-INFUSION
- **10%** +

Press ◀ to reduce or ▶ to increase.
DEFAULT: 10, Range: OFF/ 1-100
Percent of overall brew volume during pre-infusion stage.



FILL PAUSE
- **5.0 Secs** +

Press ◀ to reduce or ▶ to increase.
DEFAULT: 5, Range: 1-25 seconds
Time delay after pre-infusion before remaining water is introduced and brew continues.



EXTRACTION TIME
- **45** +

Press ◀ to reduce or ▶ to increase.
DEFAULT: 45, Range: 20-180 seconds
Extraction time to start after the total brew water is added to brew chamber.



TURBULENCE ON
- **5** +

Press ◀ to reduce or ▶ to increase.
DEFAULT: 5, Range: OFF/ 1-45
Turbulence air ON time.



TURBULENCE OFF
- **10** +

Press ◀ to reduce or ▶ to increase.
DEFAULT: 10, Range: OFF/ 1-40
Turbulence air OFF time.



TURBULENCE POWER
- ■ ■ ■ ■ □ □ □ 4 +

Press ◀ to reduce or ▶ to increase.
DEFAULT: 4, Range: 1-7
Force of the air pump during turbulence.



PRESS OUT POWER
- ■ ■ ■ ■ ■ ■ ■ 7 +

Press ◀ to reduce or ▶ to increase.
DEFAULT: 7, Range: 1-7
Force of the press-out air pump during finish.

ADJUSTING BREWING PARAMETERS (Continued)

PRESS OUT TIME
- 60 +

Press ◀ to reduce or ▶ to increase.
DEFAULT: 60, Range: 20-70
LENGTH of the press-out time during finish.

SET TEMP
- 200°F +

Press ◀ to reduce or ▶ to increase tank target temp.
DEFAULT: 200°F (93°C)
Range: 165°F-208°F (74°C-98°C)

COFFEE BREWING (Continued)



- DO NOT OPEN DURING BREWING OR PRESSING CYCLES.
- IF FOR ANY REASON, WATER REMAINS IN BREW CHAMBER, DO NOT OPEN UNTIL IT COOLS DOWN.



12. EMPTY BREW CUP

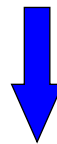

13. Thoroughly rinse brew cup.

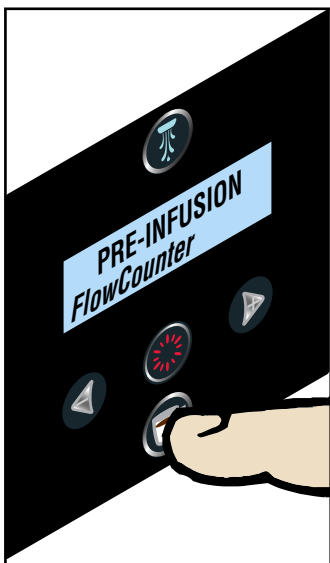

10. Press brew ☕ button.
NOTE: Pressing brew button again will cancel a brew cycle.

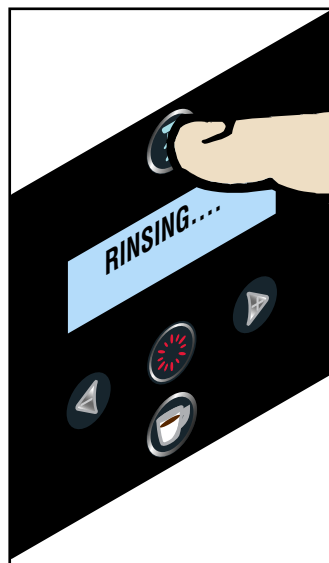

11. When brewing has finished, place an empty cup on drip tray, press rinse. 🚰

DAILY CLEANING

SPRAYHEAD REMOVAL

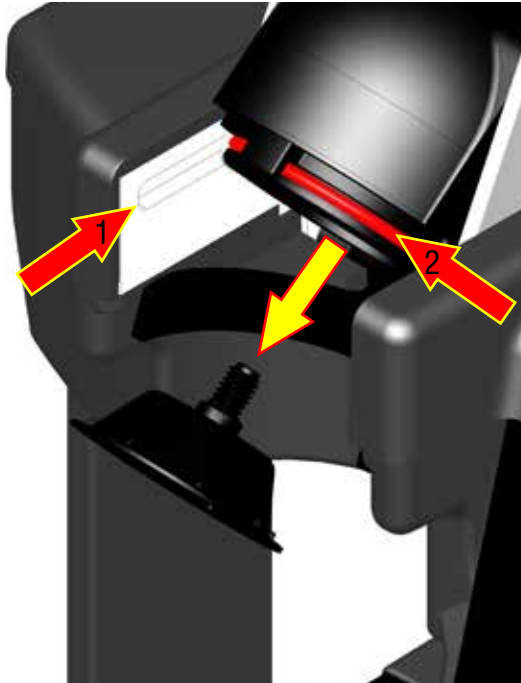

Lift handle. Remove brew chamber and cup. Wipe down sprayhead with a soft cloth to remove any residue. Once a month, or as use necessitates, rotate sprayhead counterclockwise and remove as illustrated. Clean & lube guides as needed.

**Clean & inspect parts daily.
Replace if loose, cracked or damaged.**



Thoroughly wash sprayhead, cup and check valve (with mild soap and water) and rinse with fresh water. Wipe out the cap area above sprayhead and around O-rings. Replace sprayhead by rotating clockwise, take care not to over tighten or cross thread the sprayhead when reinstalling.

CHECK VALVE REMOVAL



Push the check valve up from underneath the cup support.

After cleaning, apply very light film of silicon lube (included) to O-rings & check valve (1-4)



**STOP!
DO NOT LUBE
THIS O-RING**

Thoroughly flush the check valve while pushing the center poppet open with a probe.

CLEANING TABLETS

CLEANING CYCLE

1. Place tablet in brew cup.
2. Replace brew cup, close chamber.
3. Scroll through recipes using arrow ◀▶ buttons.
4. Press "SELECT" 🌟 button when "CLEAN CYCLE" is displayed.
5. Repeat 1-4 as deemed necessary.

DEEP CLEAN CYCLE

1. Press and hold both arrow ◀▶ buttons until display reads "PERFORM DEEP CLEAN?"
2. Press right arrow ▶ button to select "YES".
3. Empty the drip tray if it's not plumbed to a drain line.
4. Place paper towels on left side of drip tray, follow the on screen instructions. **NOTE: You will need cleaning tablets and a container that can hold at least 36 ounces of hot water.**
5. Press "BREW" ☕ to start. Cycle will take 7½ min.



FRONT PANEL REMOVAL AND TANK DRAINING

WARNING: DISCONNECT BREWER FROM POWER SOURCE BEFORE PANEL REMOVAL.



Remove drip tray. Remove two screws. Lower the panel as far as it will go.



Push the top down to clear the brew chamber support arm, then pull the top out first.

TANK DRAINING



Pull drain hose out as shown. Slide clamp back and remove plug. Refer to programming section and enter "Factory Blowout" mode. Allow tank to drain into sink or suitable container.

RESET TO FIRST TIME SETUP

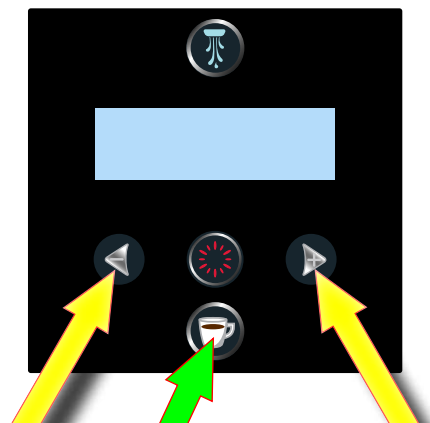

NOTE: If tank was drained, follow this procedure before connecting brewer to power source.

Disconnect brewer from power source. Connect to water supply. Install brew cup & chamber. Push and hold both arrow buttons while plugging in the brewer. When display reads "SET TO FIRST TIME UP", release arrow buttons. Place a minimum 40 oz. container under brew chamber. Press brew start button to begin cycle. If tank was empty, it will expel only 20 oz. If tank was still full, it will expel 40 oz.

ADVANCED ADJUSTMENTS & OPTIONAL SETTINGS

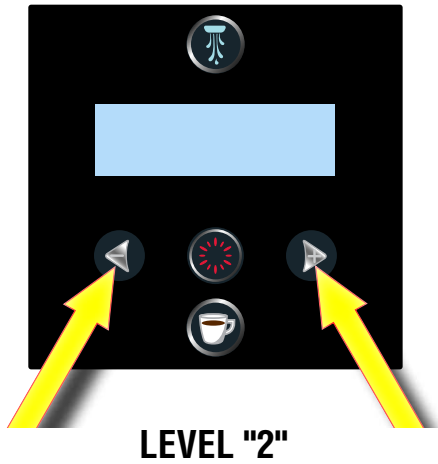

Press and hold both arrows until display reads "RECIPE CHANGES" "ENABLED - LOCKED".

| PROGRAM MODE | DEFAULT | RANGE |
|------------------------|------------------------|------------------------|
| 1. Perform Deep Clean? | - | - |
| 2. Recipe Changes | Enabled | Enabled/Locked |
| 3. Change Recipe Name | | |
| 4. Add Recipe Name | | |
| 5. Delete Recipe Name | | |
| 6. Set Language | Eng | English/Spanish/French |
| 7. Units | English | English/Metric |
| 8. Base Temperature | Disabled | Enabled/ Disabled |
| 9. Brew Lockout | Yes | YES/NO |
| 10. Ready Degrees | 5°F below "SET" temp | |
| 11. 1st Rinse Air On | OFF | OFF/1-60 |
| 12. 2nd Rinse Air On | 60 | OFF/1-60 |
| 13. 2nd Rinse Time | 2.0 | OFF/1-4.0 |
| 14. Rinse Air Power | 7 | OFF/1-7 |
| 15. Brew Count | Total (Non reset-able) | |
| 16. Brew Count | Total (Reset-able) | |
| 17. Enter Service # | | |
| 18. Service Tools | | |
| 19. Factory Defaults | | |

1. RECIPE CHANGES ENABLED LOCKED

Press ◀ to "ENABLE" adjustment, or ▶ to "LOCK".
Press "SELECT"  to advance to next screen.



By default "ENABLED" will be flashing to indicate that the brewing parameters may be accessed/changed. Selecting "LOCKED" will prevent changes to the brewing parameters, but can still be accessed for viewing.

2. ChangeRecipeName NO YES

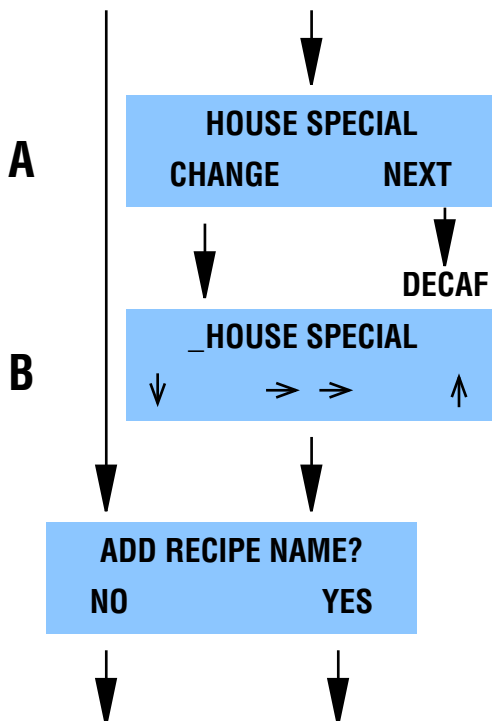
Select "YES" to change/modify a recipe's name. Select "NO" to advance to "ADD RECIPE NAME".



"CHANGE" will advance to next screen to modify the name that is displayed. "NEXT" advances to the next recipe name that has been programmed into memory. Default is "HOUSE SPECIAL" & "DECAF" only.

Use the UP/DOWN buttons to scroll through alpha/numeric digit for that position. Use the  button to move cursor to the next digit to the right. Press the  to move cursor to the left. Once you are finished changing the name, scroll all the way to the right to advance to next screen.

3. ADD RECIPE NAME? NO YES

Allows you to add additional names to the default list. Select "YES"

ADVANCED ADJUSTMENTS & OPTIONAL SETTINGS

A

ADD COFFEE NAME?
CUSTOM FromList

Selecting "CUSTOM" will allow you to custom type your own name by scrolling through digits as described above. Or you can scroll through a pre programmed list.

| | | |
|---------------|------------|------------------|
| House Special | Guatemala | El Salvador |
| Decaf | Brazil | Papua New Guinea |
| Colombia | Mocha Java | Rwanda |
| Costa Rica | Mexico | Burundi |
| Ethiopia | Peru | Honduras |
| Kona | Tanzania | Ecuador |
| Kenya | Yemen | Panama |
| Sumatra | Nicaragua | |

B

_ CUSTOM NAME
 ↓ ⇒ ⇒ ↑

Use the UP/DOWN buttons to scroll through alpha/numeric digit for that position. Use the ☀ button to move curser to the next digit to the right. Press the ☕ to move curser to the left. Once you are finished writing the name, scroll all the way to the right to advance to next screen.

C

CUSTOM NAME
PREV Select NEXT

Scroll through the list. When you find the name you are looking for, press "SELECT" ☀

D

CUSTOM NAME
NO SAVE ? YES

To save the selected name, press "YES"

4.

DeleteRecipeName
NO DONE YES

Allows you to delete a recipe name from the default list.

5.

SET LANGUAGE ?
NO DONE YES

Press "YES" to access language selections..

ADVANCED ADJUSTMENTS & OPTIONAL SETTINGS

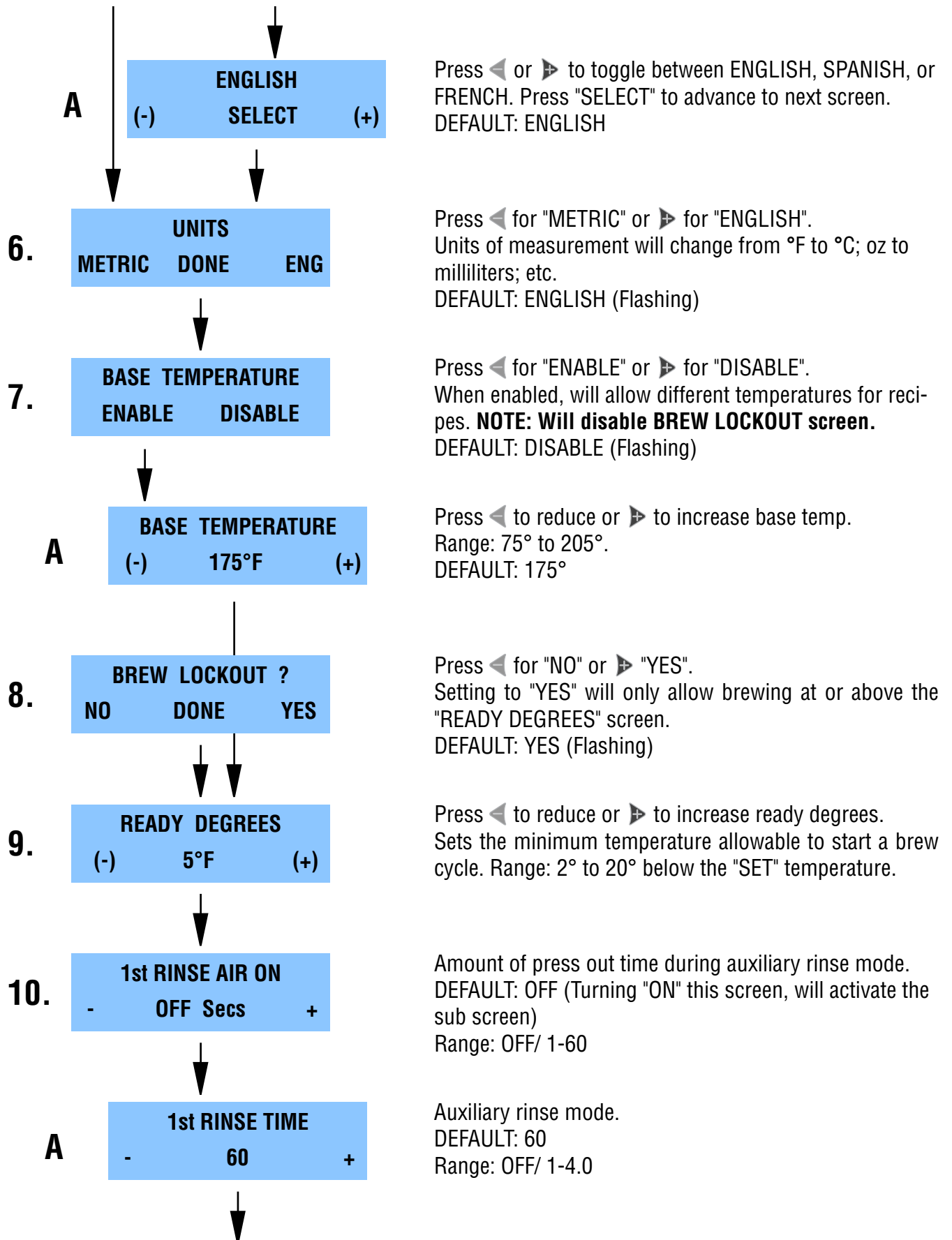

ADVANCED ADJUSTMENTS & OPTIONAL SETTINGS

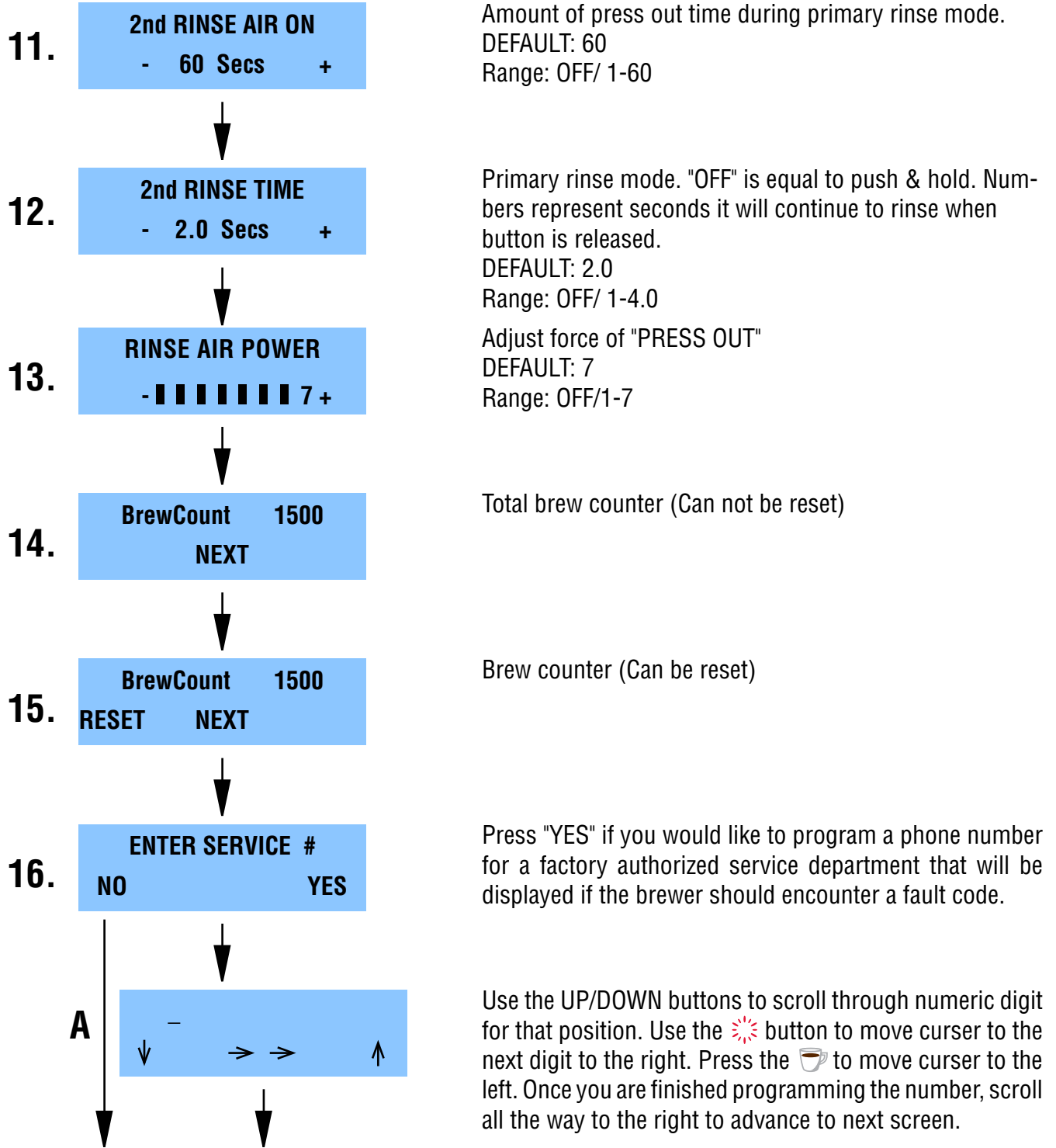

ADVANCED ADJUSTMENTS & OPTIONAL SETTINGS

17. **SERVICE TOOLS**
 NO YES

Skip to
 "FACTORY DEFAULTS"

A **TEST OUTPUTS ?**
 NO YES

Skip to
 "TEST SWITCHES"

(1) **VENT VALVE**
 ON NEXT OFF

(2) **TURBULENCE PUMP**
 ON NEXT OFF

(3) **PRESS OUT PUMP**
 ON NEXT OFF

(4) **RINSE WATER**
 ON NEXT OFF

(5) **BrewChamberFILL**
 ON NEXT OFF

(6) **LEDs**
 ON NEXT OFF

SERVICE TOOLS allows testing of load components and switches.
 It should only be used by trained technicians.

Allows testing of load components by manually turning them ON/OFF. **PLACE A CONTAINER UNDER DISPENSE AREA---** **WARNING: HOT WATER COULD DISPENSE DURING SOME TEST MODES!**

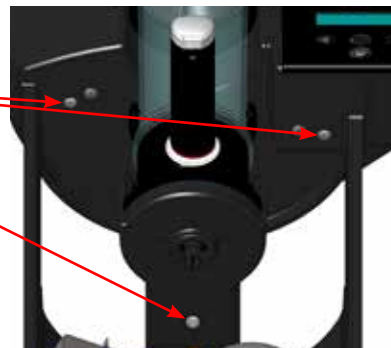
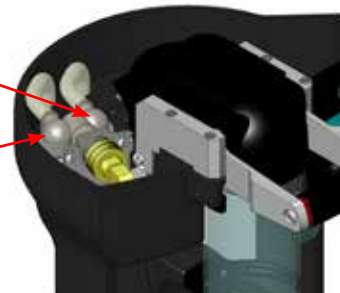
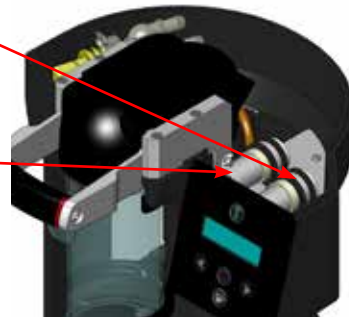
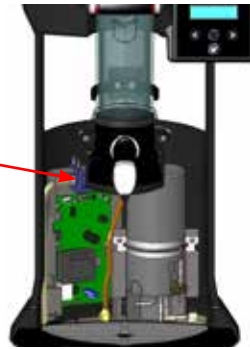

ADVANCED ADJUSTMENTS & OPTIONAL SETTINGS

(7) **TankHeater RELAY**
ON NEXT OFF



(8) **TankHeater TRIAC**
ON NEXT OFF



B **TEST SWITCHES**
NO YES



(1) **NOTHING PRESSED**



(2) **BREW CHAMBER IN**



C **CALIBRATE FLOW ?**
NO YES

Skip to "CAL TEMPERATURE
SENSOR"



(1) **!!! CAUTION !!!!**

(2) **CONTAINER MUST
HOLD 10 OUNCES**

(3) **PRESS
BREW TO START**

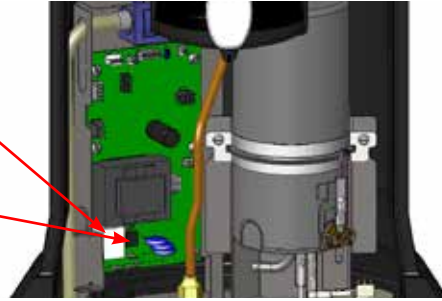

Allows testing of the membrane switches & brew chamber safety switch. Press "YES" to enter test mode. Display will read "PRESS PROGRAM TO EXIT" then change to "NOTHING PRESSED".

Display will show when a button is pressed.

Opening/closing the brew chamber during the "TEST SWITCHES" mode will display the status of the safety switch.

OUT = open
IN = closed

Press the "PROGRAM" ☀️ button to exit.

Use of this test allows user to "tell" the brew exactly how many ounces are collected during a 10 second "test" brew mode.

Use a measuring container that will hold at least 10 ounces. Place container in position on drip tray.

Press "BREW" ☕ button to start.

ADVANCED ADJUSTMENTS & OPTIONAL SETTINGS

(4) **BREWING
HOT LIQUIDS!!!!**

There will be several warning & informational screens during this test mode.

DO NOT OPEN BREW CHAMBER OR REMOVE CONTAINER UNTIL FINISHED.

(5) **DO NOT OPEN!!!!
HOT LIQUIDS!!!!**

Entire process (including press out) takes approximately 2 - 2½ minutes.

(6) **ENTER OZ 10.0
(-) DONE (+)**

When the test finishes, use the +/- buttons to enter the amount of water captured in the measuring container. Press "DONE" when finished.

(7) **FlowCounts/ 10oz
352**

This screen shows the calculation of flow meter pulses based on approximately 10 ounces.

C **CALIBRATE FLOW ?
NO YES**

Use of this test allows user to "tell" the brew exactly how many ounces are collected during a 10 second test mode.

D **CAL TEMPERATURE
NO SENSOR? YES**

Temperature probe calibration should only be used by authorized service technicians when replacing the CBA or temperature probe. Refer to service manual.

E **FACTORY BLOWOUT
NO YES**

WARNING: ALLOW TANK TO COOL FIRST. USE THIS MODE FOR TANK DRAINING ONLY. HAVE DRAIN HOSE IN SINK OR CONTAINER BEFORE PRESSING "YES".

**DISCONNECT BREWER
FROM WATER SUPPLY
BEFORE DRAINING**

ADVANCED ADJUSTMENTS & OPTIONAL SETTINGS

18.

FACTORY DEFAULTS
NO YES

Exit back to
main screen



A

**WILL REPLACE ALL
BREW SETTINGS**



B

ARE YOU SURE ?
NO YES

Exit back to
main screen



C

PLEASE WAIT
RESTORE DEFAULTS _ _



D

TRIFECTA
VERSION xx.xx

Exit back to
main screen

Reset all brew settings, calibrations, temperature adjustments and coffee names/recipes back to factory presets.

EXIT PROGRAM MODE TO MAIN SCREEN
Displays Model and Software version: