

# **SENSALERT<sup>®</sup>**

## **FOUR CHANNEL CONTROLLER**

**Document No. 7013227M**

**(Revision H)**

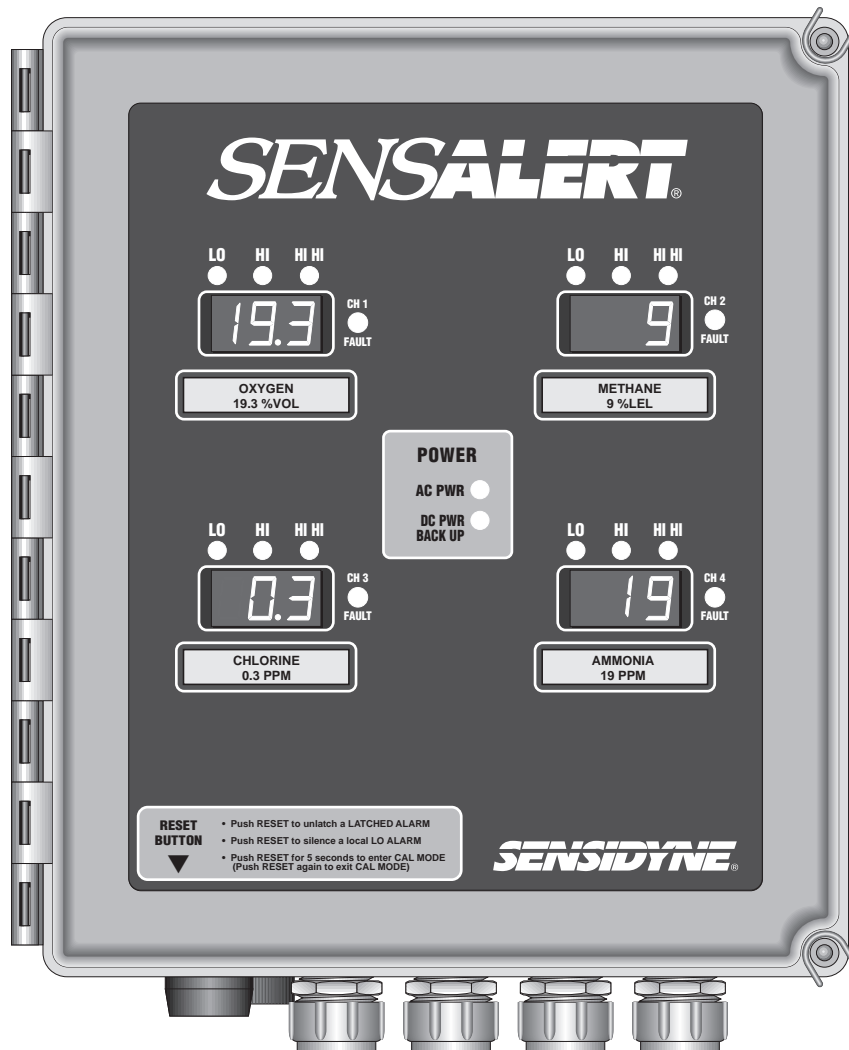

**SENSIDYNE<sup>®</sup>**

Sensidyne, LP

1000 112th Circle N, Suite 100

St. Petersburg, Florida 33716 USA

(800) 451-9444 • (727) 530-3602 • Fax: (727) 539-0550

web: [www.sensidyne.com](http://www.sensidyne.com) • e-mail: [info@sensidyne.com](mailto:info@sensidyne.com)



# PACKING LIST & NOTICES

The items listed below are shipped with the **SensAlert Four Channel Controller**:

- 4–20 mA controller with built-in readout displays, housed in a NEMA 4X fiberglass enclosure.
- *Operation and Service Manual*

***Always check to make certain you have received all of the items listed above. If you have any questions or need assistance, contact your Sensidyne Representative, or call (800) 451-9444 or (727) 530-3602***

## **PROPRIETARY NOTICE**

This manual was prepared by Sensidyne, LP exclusively for the owner of the SensAlert Four Channel Controller. The material within this manual is the proprietary information of Sensidyne, LP and is to be used only to understand, operate, and service the instrument. By receiving this document, the recipient agrees that neither this document nor the information disclosed within nor any part shall be reproduced or transferred, physically, electronically or in any form or used or disclosed to others for manufacturing or for any other purpose except as specifically authorized in writing by Sensidyne, LP.

## **COPYRIGHT NOTICE**

© 2002, © 2008 Sensidyne, LP. All rights reserved. Information contained in this document is protected by copyright. No part of this document may be photocopied, reproduced, or translated to another program or system without prior written authorization from Sensidyne, LP.

## **TRADEMARK NOTICE**

Sensidyne, the Sensidyne logo, SensAlert, and the SensAlert logo are registered trademarks of Sensidyne, LP. SensAlarm is a trademark of Sensidyne, LP. The trademarks and service marks of Sensidyne, LP are protected through use and registration in the United States.

## **SOFTWARE LICENSE**

The software included with the SensAlert is the property of Sensidyne, LP and shall remain the property of Sensidyne, LP in perpetuity. The software is protected by U.S. and international copyright laws and is licensed for specific use with the SensAlert Four Channel Controller. The user may NOT reverse-engineer, disassemble, decompile, or make any attempt to discover the source code of the software. The software may NOT be translated, copied, merged or modified in any way. The user may NOT sublicense, rent, or lease any portion of the software. The right to use the software terminates automatically if any part of this license is violated.

## **DISCLAIMER**

**SENSIDYNE, LP ASSUMES NO RESPONSIBILITY WHATSOEVER, TO ANY PARTY WHOSOEVER, FOR ANY PROPERTY DAMAGE, PERSONAL INJURY, OR DEATH RECEIVED BY OR RESULTING FROM, IN WHOLE, OR IN PART, THE IMPROPER USE, INSTALLATION, OR STORAGE OF THIS PRODUCT BY THE USER, PERSON, FIRM, ENTITY, CORPORATION OR PARTY NOT ADHERING TO THE INSTRUCTIONS AND WARNINGS OR NOT ADHERING TO ALL FEDERAL, STATE, AND LOCAL ENVIRONMENTAL AND OCCUPATIONAL HEALTH AND SAFETY LAWS AND REGULATIONS.**

**THE SELLER SHALL NOT BE LIABLE FOR DIRECT, INDIRECT, CONSEQUENTIAL, INCIDENTAL OR OTHER DAMAGES RESULTING FROM THE SALE AND USE OF ANY GOODS AND SELLER'S LIABILITY HEREUNDER SHALL BE LIMITED TO REPAIR OR REPLACEMENT OF ANY GOODS FOUND DEFECTIVE. THIS WARRANTY IS IN LIEU OF ALL OTHER WARRANTIES, EXPRESSED OR IMPLIED, INCLUDING BUT NOT LIMITED TO THE IMPLIED WARRANTIES OF MERCHANTABILITY AND FITNESS FOR USE OR FOR A PARTICULAR PURPOSE WHICH ARE EXPRESSLY DISCLAIMED.**

# TABLE OF CONTENTS

---

## • PREFACE

---

• Packing List & Notices .....	3
• WARNINGS .....	7

---

## SECTION ONE: INTRODUCTION

---

1.1	Overview .....	8
1.2	Components .....	9
1.2.1	Controller Housing .....	9
1.2.2	Display PCB .....	9
1.2.3	Bottom PCB .....	9
1.3	Operator Buttons .....	11
1.4	Controller Screens .....	12
1.4.1	System Screens .....	12
1.4.2	Channel Screens .....	12

---

## SECTION TWO: INSTALLATION

---

2.1	Mounting & Wiring .....	15
2.1.1	Terminal Designations .....	15
2.1.2	Jumpers .....	16
2.1.3	Fuses .....	16
2.1.4	Potentiometers .....	16
2.2	Wiring Procedure .....	18
2.3	Initial Start-Up .....	21

---

## **SECTION THREE: OPERATION**

---

3.1	Main Screen .....	25
3.2	View Alarm Settings (Menu #1) .....	25
3.3	Entering a Password .....	25
3.4	Entering Calibration Mode .....	26

---

## **SECTION FOUR: CHANGING ALARM SETTINGS**

---

•	Changing Alarm Settings .....	28
---	-------------------------------	----

---

## **SECTION FIVE: USING SET-UP & DIAGNOSTICS**

---

5.1	Set-Up (Menu #3) .....	29
5.1.1	Enable/Disable a Channel .....	29
5.1.2	Set Calibration Delay .....	29
5.1.3	Changing the Password .....	30
5.1.4	Changing the RS-485 Address .....	30
5.1.5	Setting Alarm Latching .....	32
5.1.6	Energize Relay .....	32
5.1.7	Adjusting the Zero Point .....	32
5.2	Diagnostics (Menu #4) .....	33
5.2.1	Self-Test .....	33
5.2.2	Relay Check .....	33

---

## **SECTION SIX: MAINTENANCE & SERVICE**

---

6.1	Adjusting the Output .....	34
6.2	Replacing the Power Supply .....	34
6.3	Replacing the Display PCB .....	35
6.4	Replacing the Bottom PCB .....	35

---

## **SECTION SIX: PARTS LIST**

---

•	Controller Parts .....	36
---	------------------------	----

# LIST OF FIGURES & TABLES

---

## APPENDICES

---

- Appendix A: Specifications
  - General Specifications ..... 37
- Appendix D: Troubleshooting Guide
  - Troubleshooting Guide ..... 38
- Appendix E: Returned Material Authorization
  - Returned Material Authorization ..... 39
  - Service Options ..... 39

---

## LIST OF FIGURES

---

### Section One: Introduction

- 1.1 Display PCB ..... 10
- 1.2 Controller Menu System: Main Screens ..... 13
- 1.3 Controller Menu System: Individual Channel Screens ..... 14

### Section Two: Installation

- 2.1 Controller Wiring: Bottom PCB ..... 17
- 2.2 Attaching the Mounting Feet ..... 18
- 2.3 Controller Mounting ..... 19
- 2.4 Terminal Wiring Guide ..... 20
- 2.5 Wiring to a SensAlert Transmitter (with Intrinsic Safety Barrier) ..... 22
- 2.6 Wiring to a SensAlert Transmitter (without Intrinsic Safety Barrier) ..... 23
- 2.7 Wiring to a non-SensAlert Transmitter (without Intrinsic Safety Barrier) ..... 24

### Section Three: Operation

- 3.1 Entering a Password ..... 27

### Section Five: Using Set-Up & Diagnostics

- 5.1 Changing a Password ..... 31



# WARNINGS



## READ AND UNDERSTAND ALL WARNINGS BEFORE USE

Read and understand **ALL** warnings before using this product. Failure to read, understand, and comply with **ALL** warnings could result in property damage, severe personal injury, or death.

Read and understand **ALL** applicable Federal, State, and Local environmental health and safety laws and regulations, including OSHA. Ensure complete compliance with **ALL** applicable laws and regulations before and during use of this product.

**UNDER NO CIRCUMSTANCES** should this product be used except by qualified, trained, technically competent personnel and not until the warnings, *Operation and Service Manual*, labels, and other literature accompanying this product have been read and understood.

This product should **NOT** be used in any way other than specified in this manual.

**DO NOT** remove, cover, or alter any label or tag on this product, its accessories, or related products.

**DO NOT** operate this product should it malfunction or require repair. Operation of a malfunctioning product, or a product requiring repair may result in serious personal injury or death.

**DO NOT** attempt to repair or modify the instrument, except as specified in the *Operation and Service Manual*. Contact the Sensidyne Service Department to arrange for a Returned Material Authorization (RMA).

**ONLY** use genuine SENSIDYNE® replacement parts when performing any maintenance procedures provided in this manual. *Failure to do so may seriously impair instrument performance.* Repair or alteration of the product beyond the scope of these maintenance instructions, or by anyone other than a certified SENSIDYNE® serviceman, could cause the product to fail to perform as designed and persons who rely on this product for their safety could sustain severe personal injury or death.

AC (Earth) ground **MUST** terminate on each controller's ground terminal to prevent an electric shock-hazard. A PCB board mounted ground lug is supplied with each unit.

Operation of the alarm relays above their contact ratings may result in false alarms or relay failure.

### CAUTIONARY NOTE

The output signal to the recorder, or other data gathering device, is always "live." That is, the display reading is transmitted directly through the recorder output to whatever peripheral device is attached to the controller. Any recorder or other data gathering device should be turned off during calibration.

# SECTION ONE

# **INTRODUCTION**

---

## 1.1 OVERVIEW

---

### **IMPORTANT**

*You must read this manual in its entirety to ensure proper operation of the controller.*

---

This manual provides specific information concerning the installation, operation, and maintenance of the Sensidyne SensAlert Controller.

The SensAlert Controller, when used with a Sensidyne external I.S. barrier (PN<sup>o</sup> 7013263), is designed to operate an intrinsically safe SensAlert transmitter in areas classified Class I, Division 1, Groups A, B, C, D; Class II, Division 1, Groups E, F, G.

The Sensidyne SensAlert Controller is an integral part of the SensAlert Gas Monitoring System. The SensAlert Controller, housed in a NEMA 4X enclosure, provides separate single pole double throw (SPDT) relays for each alarm condition, plus one common relay for a fault condition. It also serves as an interface when an event needs to be relayed to a peripheral device, such as a building fire alarm system. The SensAlert Controller displays can display gas levels in either ppm, %vol, or %LEL, depending on the installed sensor.

The power supply for the controller has been designed to operate at 90-265 VAC, with the capability of adding a 24 Vdc backup power supply.

Some of the features of SensAlert Four Channel Controller include:

- Auto-recognition of sensors
- Lo, Hi, HiHi, & Fault alarms
- User-selectable alarm levels
- Three relay contacts per sensor
- Lockout/tagout designed case
- RS-485 serial output
- 4-20 mA / 1-5 volt output
- Password protection



## 1.2 COMPONENTS

### 1.2.1 Controller Housing

The NEMA 4X enclosure is made of high-grade, fiber-glass reinforced polyester resin matting. The enclosure provides a weather-resistant and water-resistant barrier between the internal electronics and the ambient environment. The controller cover is secured to the housing with 2 quick release latches. Each latch has a small circular knockout that allows the case to be locked or tagged to prevent unauthorized entry.

The Reset switch is located on the bottom of the controller housing (refer to Figure 2.1). The switch can be used to (1) unlatch a latched alarm, (2) silence a local Lo Alarm, or (3) enter Calibration Mode (when pressed for 5 seconds).

The Alarm Buzzer is located on the bottom of the controller housing, next to the cable glands. The alarm buzzer is used for the Local Alarm.

### 1.2.2 Display PCB

The Display PCB contains the large, 3-digit LED displays, the LCD displays, and the operator buttons that control the menu system. The Display PCB connects to the Bottom PCB via a 20-pin flex cable. The components on the Display PCB are described as follows.

- **Liquid Crystal Display**

The Liquid Crystal Display (LCD) is a 16 character, 2-line display located behind the front cover of the controller enclosure (see Figure 1.1). During normal operation, the display shows the gas name and gas concentration (in ppm, %LEL, or %vol) for the sensor installed at the transmitter. The display is also used for viewing and changing various features of the controller (e.g., alarm settings, passwords, etc.).

During alarm and fault conditions, the display shows status messages on Line 2 describing the nature of the condition (e.g., Lo Alarm, Missing Sensor, etc).

- **Operator Buttons**

The 5 Operator Buttons control the menu system. The menu system allows you to view and change alarm settings, change system features, and perform diagnostics. A detailed description of the menu system and operator buttons can be found in Sections 1.3 & 1.4.

### 1.2.3 Bottom PCB

The Bottom PCB (see Figure 2.1) is attached to the inside bottom of the controller housing. The components located on the Bottom PCB are described below.

The Bottom PCB is populated with 11 terminal blocks. Each terminal block consists of a base block and a keyed, removable terminal plug that facilitates wiring. Terminal wiring designations are described in Section Two.

The Bottom PCB also contains jumpers, AC & DC fuses, and a current limiting 4 channel power supply.

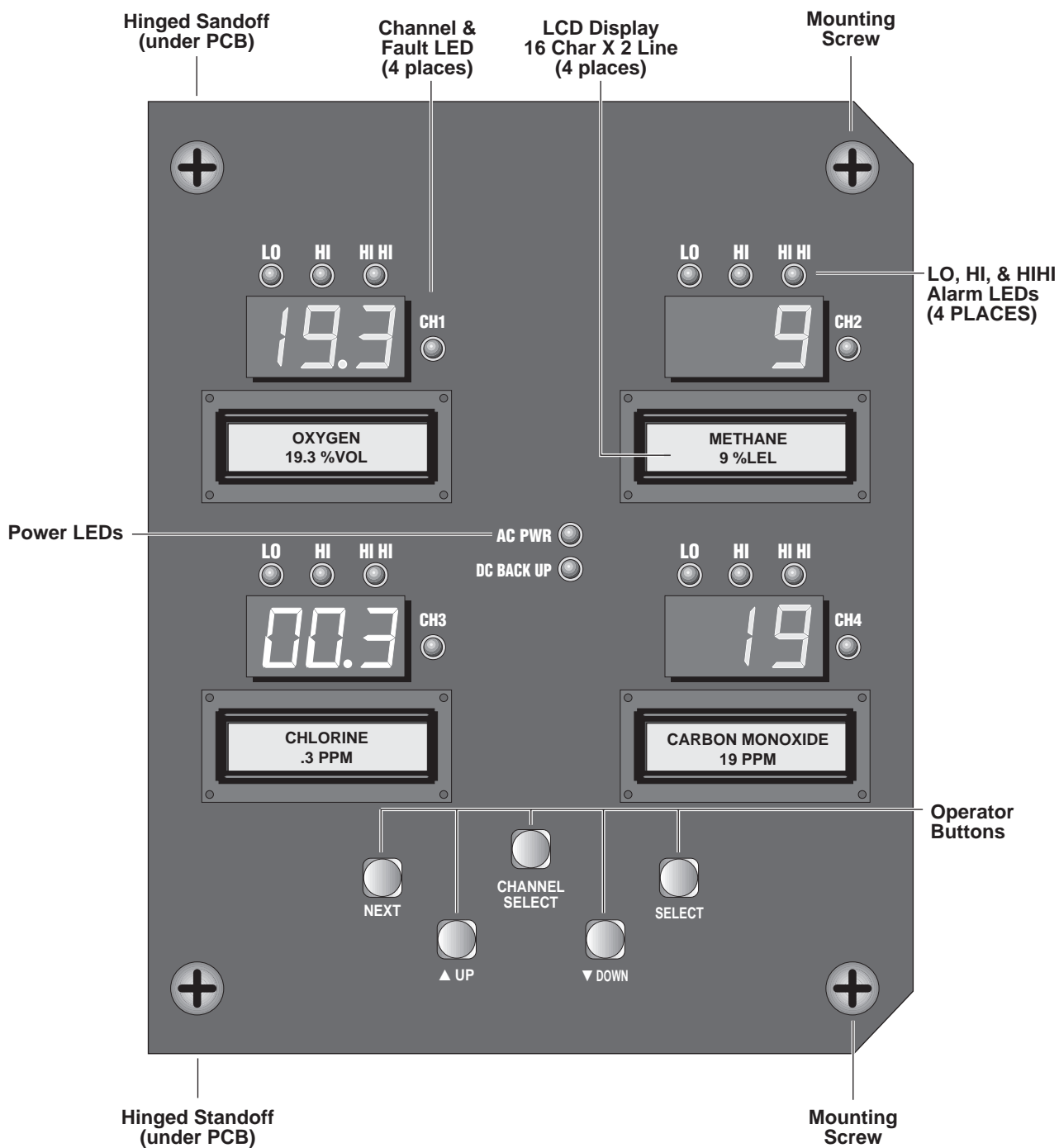

**Figure 1.1**  
**Display PCB**

---

### 1.3 OPERATOR BUTTONS

---

Figures 1.2 and 1.3 show the operator buttons that control the menu system.

The buttons are described below.

#### **CHANNEL SELECT**

The **CHANNEL SELECT** button is used to access a channel for system programming.

#### **NEXT**

The **NEXT** button has two functions:

- Pushing the **NEXT** button, during normal operation displays the current alarm settings for all 4 channels (see Figure 1.2).
- Pressing the **NEXT** button after selecting a channel moves you through the Set Alarm, Set-up, and Diagnostics screens for that channel (see figure 1.3).

#### **▲ UP & ▼ DOWN**

The **▲UP** and **▼DOWN** buttons have two purposes.

- To scroll “up” or “down” different menu lists. Each screen indicates which type of scrolling is available by displaying either an **▲** or **▼** arrow. When both arrows appear on the display, up and down scrolling is available.
- To increase or decrease a value shown on the screen (such as an alarm setting or a password code).

#### **SELECT**

The **SELECT** button is used to select an item from a menu list after you have scrolled to that item using the **▲UP** or **▼DOWN** buttons.

The **SELECT** button also is used to accept a value after it has been changed (e.g., a new alarm setting). It is similar to the RETURN/ENTER key on a keyboard.

## 1.4 CONTROLLER MENUS

Figures 1.2 and 1.3 show the primary controller screens: Main Screen, View Alarms (#1), Set Alarms (#2), Set-Up (#3), and Diagnostics (#4). There is also an Enter Password screen that appears if a password has been set. The **CHANNEL SELECT** and **NEXT** buttons are used to navigate through the menu screens.

### 1.4.1 System Screens

#### • **Main**

The Main Screen is the primary screen during normal operation. It displays the gas name and gas concentration (in ppm, %LEL, or %VOL). During alarm or fault conditions, the Main Screen displays warning messages on Line 2. These messages are shown in Figure 1.3.

#### • **View Alarms (#1)**

The View Alarms Screen shows the current settings for the Lo, Hi, and HiHi alarms. This screen is always available whether or not a password has been set. The alarm settings can be viewed by pressing the **NEXT** button during normal operation.

#### • **Enter Password**

This screen appears after you press the **CHANNEL SELECT** button and a password has been set. You must enter a valid 4-digit password to access the Set Alarms, Set-Up, and Diagnostics screens in any of the 4 channels. The unit is shipped from the factory without a password.

### 1.4.2 Channel Screens

The following screens are available for each of the four controller channels.

#### • **Set Alarms (Menu #2)**

This screen allows you to change the Lo, Hi, and Hi Hi alarm settings. It also lets you set the alarms to their default (factory-set) values.

#### • **Set-Up (Menu #3)**

The Set-Up Screen allows you to change the following SensAlert features:

- Enable/Disable a Channel
- Set Calibration Delay
- Change the Password
- Change the RS-485 Address (custom order)
- Set Alarm Latching (latched vs. unlatched)
- Energize Relay
- Adjust the Zero Point

#### • **Diagnostics (Menu #4)**

The Diagnostics screen contains routines that check the state of the controller. These include a Self-Test (similar to the self-test conducted during initial start-up) and an Alarm Relay Check.

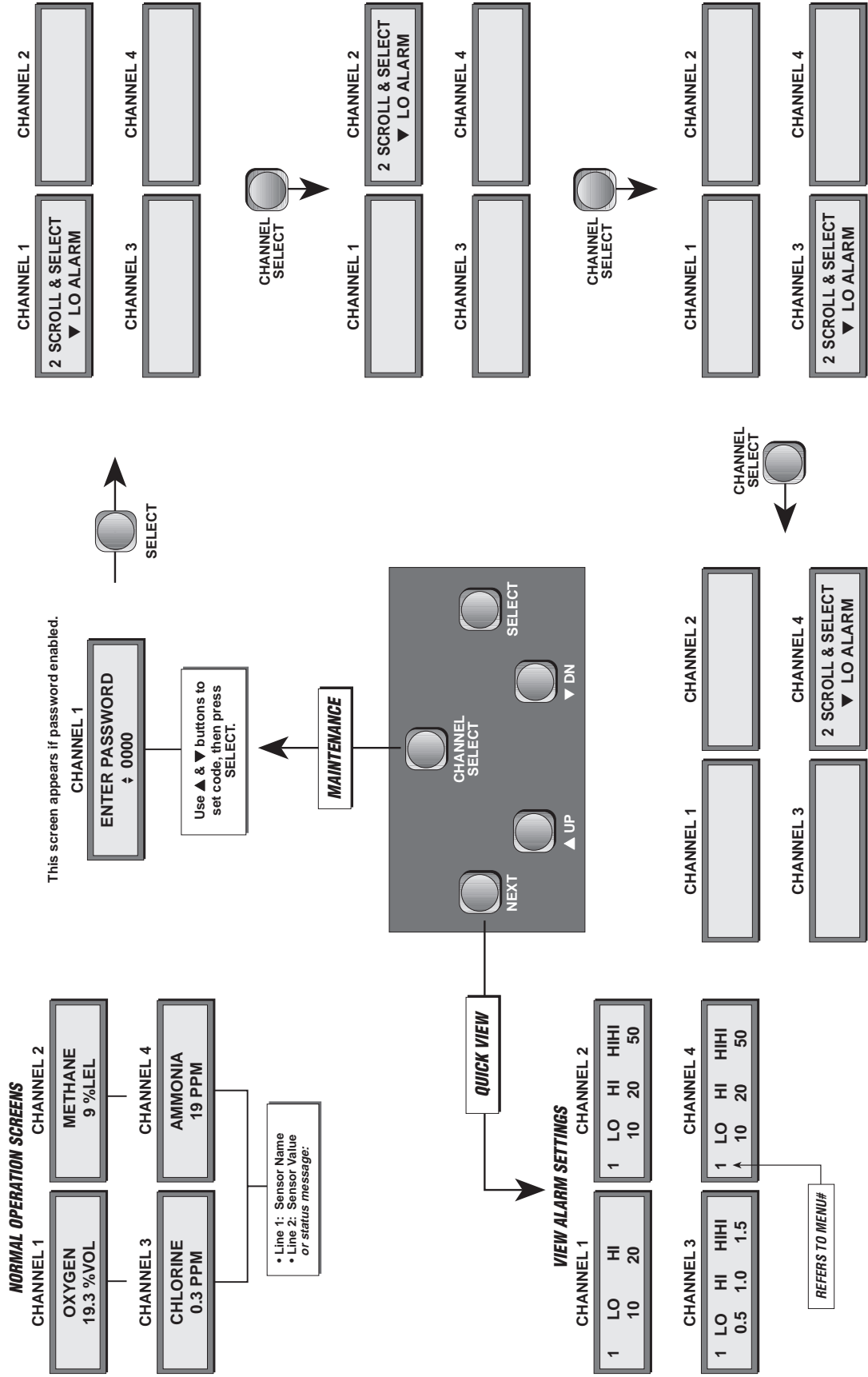





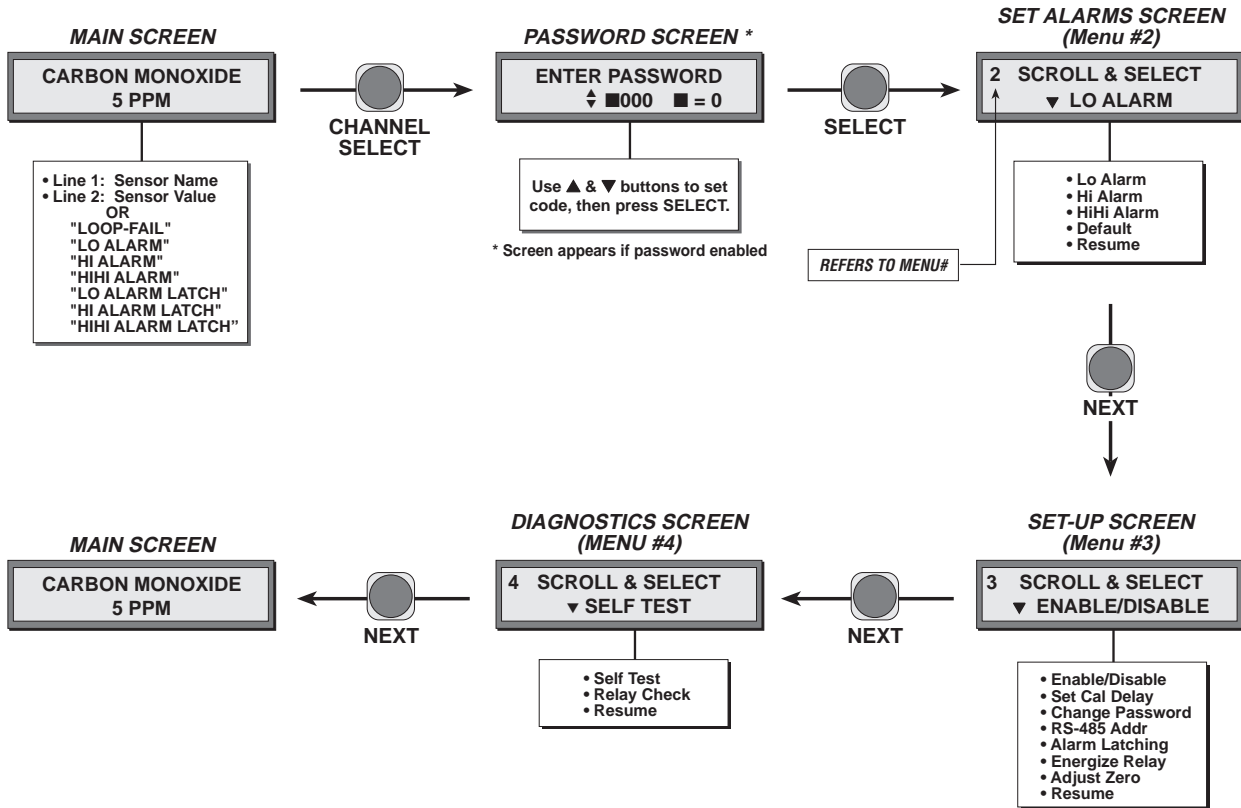

Figure 1.2 Controller Menu System: Main Screens

### OPERATOR BUTTONS

- CHANNEL SELECT**  • Selects active channel for programming
- NEXT**  • Advances to next Menu
- SELECT**  • Selects item from menu  
• Accepts changed value
- ▲ UP**  • Scrolls "up" a menu list  
• Increases a value
- ▼ DOWN**  • Scrolls "down" a menu list  
• Decreases a value



**Figure 1.3**  
**Controller Menu System: Individual Channel Screens**

## 2.1 MOUNTING & WIRING

The SensAlert Controller is designed to be wall mounted. Four mounting feet are supplied. The feet mount to the back of the enclosure and are secured to the unit by 10-32 screws (3/8" in length). The feet must be positioned vertically (refer to Figures 2.2 & 2.3).

The controller is wired to transmitters through EMT connectors positioned at the bottom of the enclosure. The EMT connectors prevent moisture from entering the enclosure. The controller must be wired using shielded twisted pair cable (with the shield tied to earth ground) to achieve maximum RFI/EMI immunity.

### NOTE

*Use only U.L. listed or recognized conduit hubs that have the same or better environmental rating as the enclosure. Conduit hubs must be connected to the conduit before being connected to the enclosure.*

### 2.1.1 Terminal Designations

Wiring terminals are located on the Main (bottom) PCB. They are designated as follows (see Figure 2.1):

#### Audible Alarm (J5)

The local alarm buzzer is factory wired. The local alarm buzzer is located at the bottom of the controller housing, on the outside of the case.

#### Reset Switch (J4)

The Reset Switch is factory-wired. The switch is located on the bottom of the controller housing, on the outside of the case.

#### AC Power To Controller (J2)

The controller is wired to an AC power source through these terminals. The terminal marked **LO** is used for the neutral AC wire. The terminal marked **HI** is used for the hot AC wire. The middle terminal is not used.

### NOTE

*When wiring the controller to a permanent A.C. source, the A.C. source circuit breaker and/or switch must be IEC approved. The circuit breaker and/or switch must be near the unit and marked as the disconnect device for the unit.*

#### • Transmitter Power To Sensors (J8-J11)

This terminal is used to wire the controller to the transmitter. A simplified wiring diagram showing how the controller is wired to the transmitter is shown in Figure 2.6). The terminals are wired as follows:

**24V** wire connects to the **Positive Power** on the transmitter.

**4–20 mA IN** signal wire connects to the **4–20 mA Signal Output** terminal on the transmitter.

**Power Return (PWR RTN)** wire connects to the **Power Return** terminal on the transmitter (3-wire transmitters only).

#### • 4–20 mA Output (J6)

4-20 mA output is available for external devices for each of the 4 channels. Each output can be independently changed from 4-20 mA to 1-5 Volts using the jumpers at JP1–JP4.

In addition, each channel output can be adjusted by potentiometers VR1-VR4 for increased accuracy.

#### • 24 Vdc Battery Backup (J3)

A DC battery backup can be wired to controller. The battery backup is wired as follows:

**POS** wire connects to the positive (+) terminal on a 20-26 Vdc battery backup.

**RTN** (Power Return) connects to the negative (–) terminal on a 20-26 Vdc battery backup.

There is fuse diode protection incorporated within the unit such that reversing the wiring of the backup supply will not do any damage, but will merely burn out the fuse. The backup supply must have an output of 20–26 Vdc @ 2 1/2 amp.

• **Fault Relay (J12)**

The **Fault Alarm Relay** (J12) acts in common to all four channels and the system. It is factory-set (default) to be energized during normal operation. The markings at J12 reflect this intention. Therefore, unless the operation is changed by the user, the fault relay's SPDT Form C contact acts as follows:

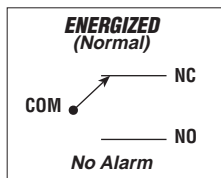

• **Alarm Relays (J8-J11)**

Each channel has a set of 3 alarm relays which act in accordance with the settings for their channel. These relays each have one SPDT Form C contact. Unless the factory setting (default) of de-energized during normal operation is changed by the user, the alarm relays act as follows:

The **Lo Alarm Relays** are factory-set to be normally de-energized in normal operation:

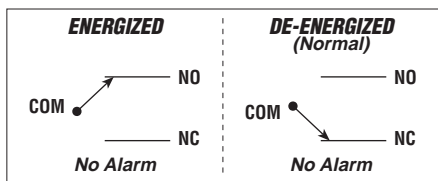

The **Hi Alarm Relays** are factory-set to be normally de-energized in normal operation:

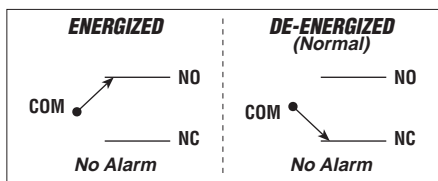

The **Hi Hi Alarm Relays** are factory-set to be normally de-energized:

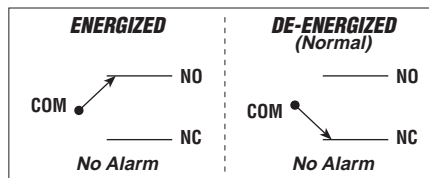

• **RS-485 Output (J7)**

The RS-485 Output terminals are designated as follows:

- VCC
- A
- B
- GND

*Exact RS-485 functions to be determined for specific applications.*

**2.1.2 Jumpers**

**1-5 Volt Output Select (JP1-JP4)**

The analog output signal from the controller to an external device is factory set for 1–5 volts. This allows output to a chart recorder or computer-based recorder device. The jumpers are designated as follows:

- JP1 = Channel 1
- JP2 = Channel 2
- JP3 = Channel 3
- JP4 = Channel 4

Removing the jumper changes the output to 4–20 mA for any channel using external termination.

**2.1.3 Fuses**

- AC Fuse: 4 amp, fast blow (Location: FS1).
- DC Fuse: 3 amp, fast blow (Location: F1).

**2.1.4 Potentiometers**

The accuracy of the analog output signal from the controller can be adjusted by VR1-VR4. Clockwise adjustments increase the output level for that specific channel. Counterclockwise adjustments decrease it. The potentiometers are designated as follows:

- VR1 = Channel 1
- VR2 = Channel 2
- VR3 = Channel 3
- VR4 = Channel 4



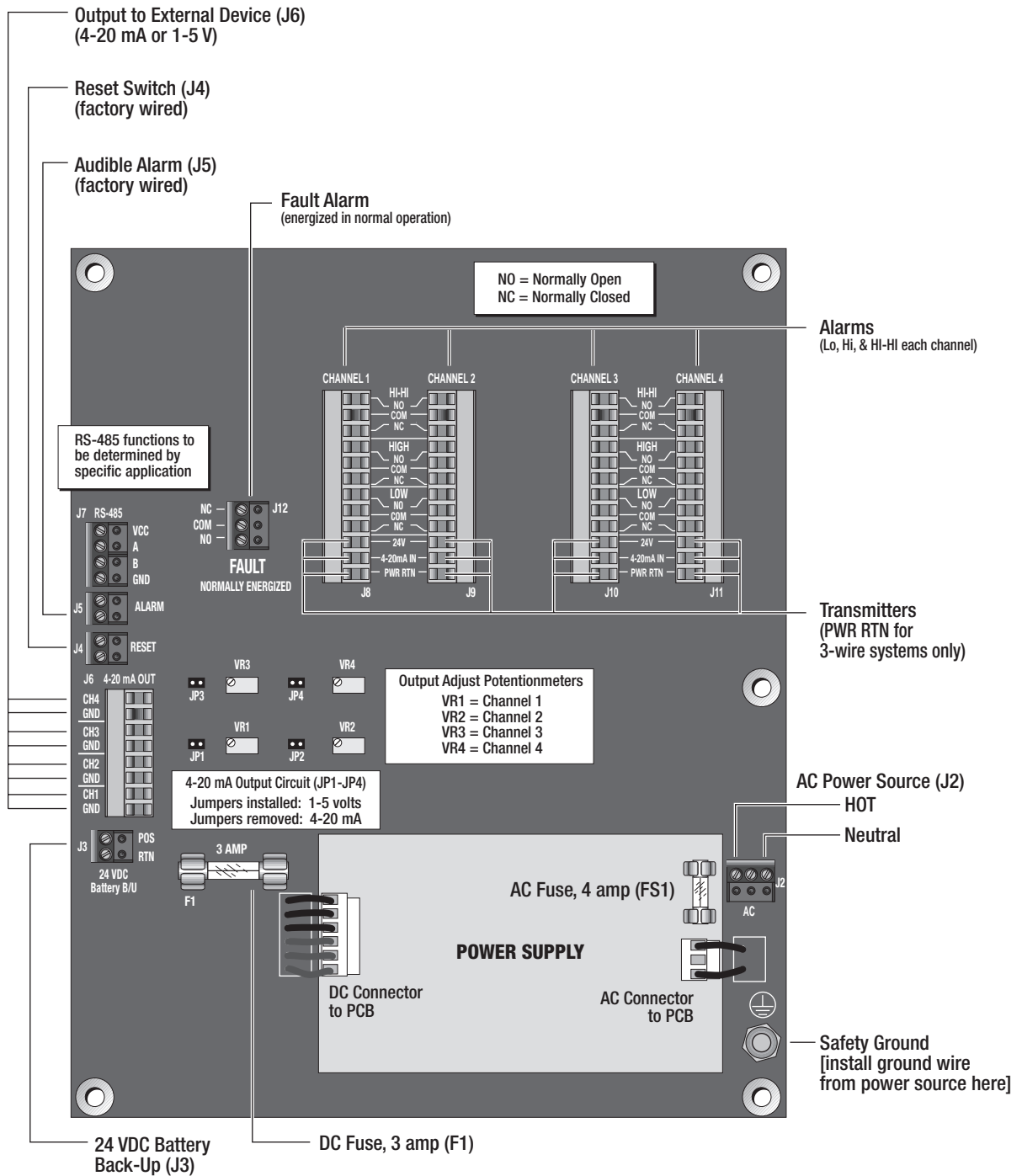

**Figure 2.1**  
**Controller Wiring: Bottom PCB**

## 2.2 WIRING PROCEDURE

Mount the controller to the wall using the four mounting feet provided. The feet are positioned vertically and then mounted to the back of the controller housing with four 10-32 screws (see Figure 2.2).

Secure the controller housing to the wall with the appropriate anchoring hardware. The mounting dimensions are shown in Figure 2.3.

Wire the controller according to the terminal designations described in Section 2.1.1 and shown in Figure 2.1.

Wire the controller as follows (refer to Figures 2.1, 2.4, 2.5, 2.6, & 2.7):

- 1) Open the quick-release latches on the controller housing and open the cover.
  - 2) Unscrew the two right-hand mounting screws on the Display PCB and swing it to the left (the board is attached to 2 hinged standoffs).
  - 3) Locate a terminal block you wish to wire.
  - 4) Remove the terminal plug from the terminal block [Figure 2.4-A]
  - 5) Insert a terminal wire into the plug [Figure 2.4-B]. **Note: Wires are inserted in the side of 2-, 3-, and 4-position terminal plugs, and in the top of 8- and 12-position terminal plugs.**
  - 6) Secure the wire by tightening the terminal screw with a small flat blade screwdriver [Figure 2.4-C].
  - 7) Complete Steps 5 & 6 for the remaining wires for that terminal plug.
  - 8) Replace the terminal plug on the terminal block [Figure 2.4-D].
  - 9) Complete Steps 3–8 for the remaining terminal blocks.
- Make certain you install the ground (earth) wire under the lower level washer on the safety ground terminal. Terminate the shields of the transmitter cable under the upper level washers on the ground terminal.*
- 10) Install the ground wire (earth) to safety ground (see Figure 2.1).
  - 11) Close the Display PCB and secure it with the mounting screws.
  - 12) Close the controller cover and secure the quick release latches.

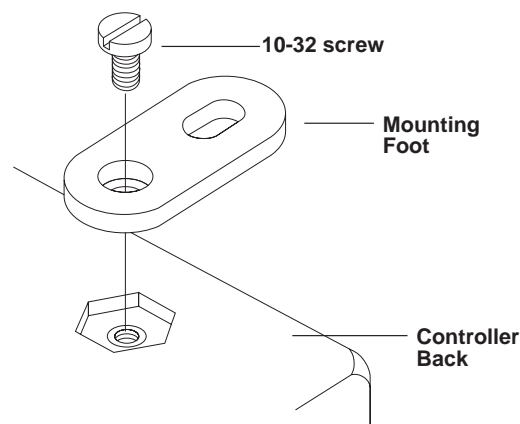

**Figure 2.2**  
**Attaching the Mounting Feet**

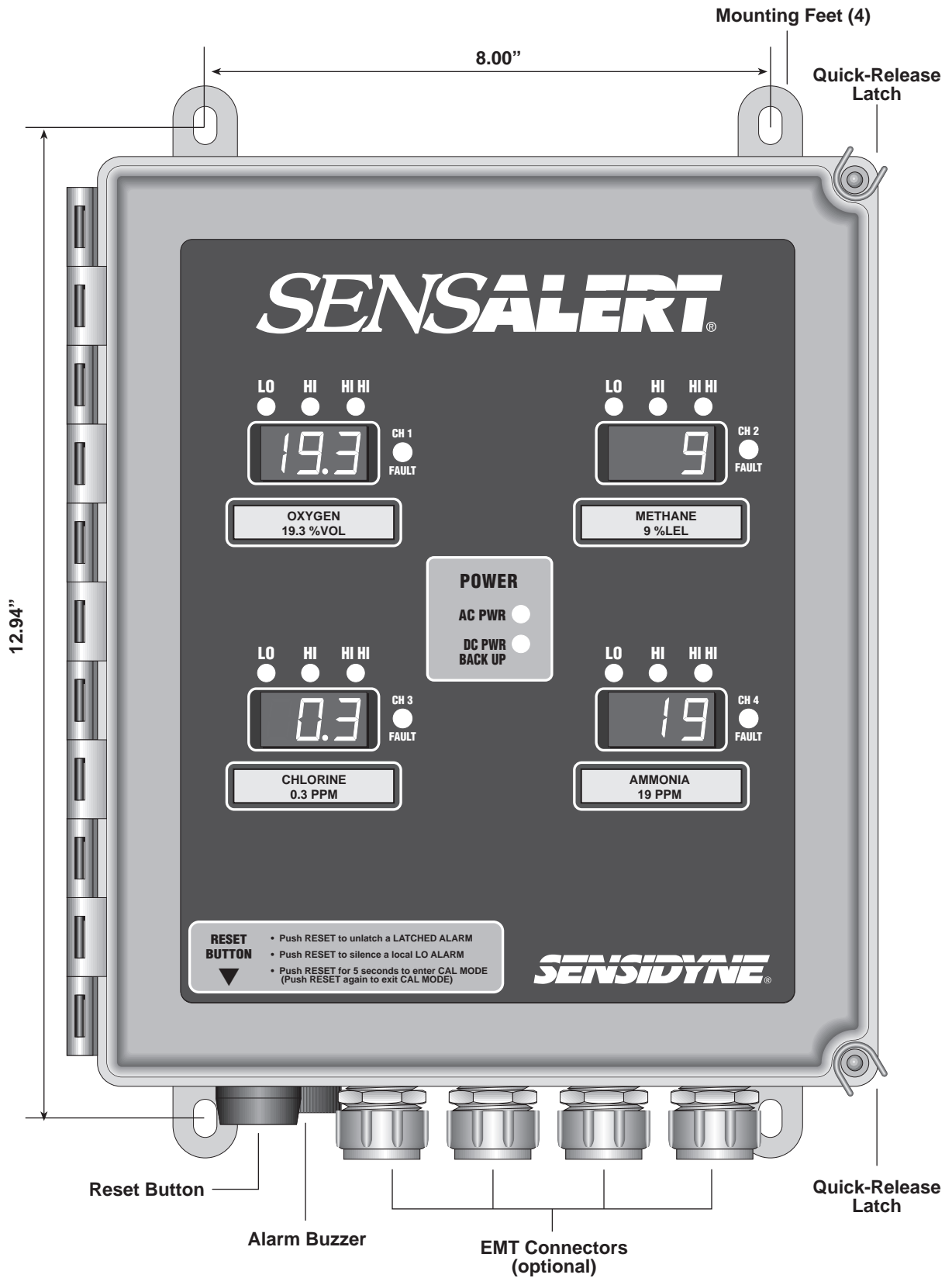

**Figure 2.3**  
**Controller Mounting**

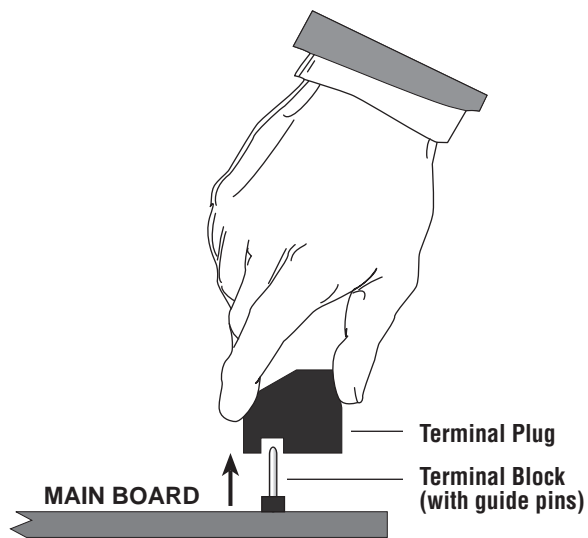

**A** Pull on terminal plug to remove it from board

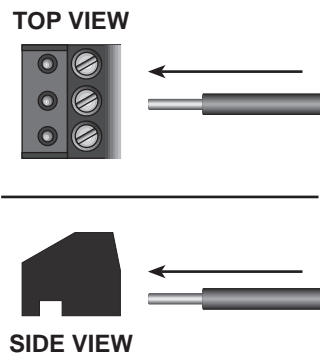

**B** Insert wire into terminal plug

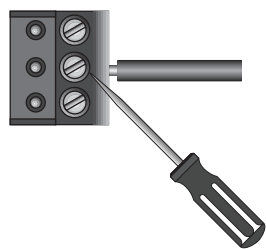

**C** Tighten terminal screw with flat blade screwdriver

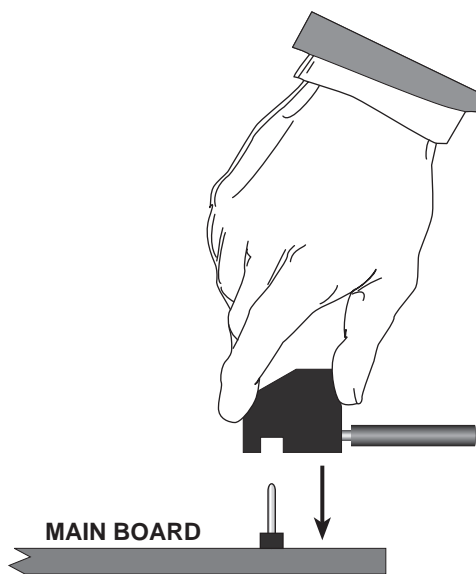

**D** Install terminal plug on appropriate terminal block

**Figure 2.4**  
Terminal Wiring Guide

## 2.3 INITIAL START-UP

After controller wiring has been completed, make certain the transmitter has been properly wired to the controller and that no sensor is installed in the transmitter. Sensor should be installed in the transmitter AFTER the transmitter has been powered up.

- 1) Check Figure 2.5. If an optional intrinsic safety barrier is used, make certain it is properly wired.
- 2) Apply power to the controller. During start-up, a series of warning and self-test screens appear, followed by "Channel Disabled" displayed in each of the 4 channel displays.

***This is expected. All units are shipped from the factory with their channels disabled. This is to avoid a "Missing Sensor" fault (with audible alarm) during initial start-up.***

- 3) Once the controller and transmitters have been powered up, install sensors in the transmitters.
- 4) Press **CHANNEL SELECT** to bring up the Set Alarms screen ("2 Scroll & Select.....Lo Alarm") for Channel 1.

- 5) Enable each channel as follows:
  - a) Press the **NEXT** button to move to the Set-Up screen (Menu #3).
  - b) Press **SELECT** to choose Enable/Disable (this item is always shown first when going to the Set-Up screen). The screen will show "Disabled".
  - c) Press the **VDOWN** button to change the status to "Enabled". Press **SELECT** to enable the channel.
  - d) Press **CHANNEL SELECT** to bring up the Set Alarms screen for Channel 2.
  - e) Repeat Steps 5a–5d for each of Channels 2, 3, & 4 that are to be used.
  - f) When all channels which are to be used have been enabled, press **CHANNEL SELECT** until the unit returns to the Main Screen.
- 6) The unit will perform channel initialization for each of the 4 channels. After initialization, the unit will begin Normal Operation.
- 7) If you want to adjust the output at this point, go to Section 6.1.

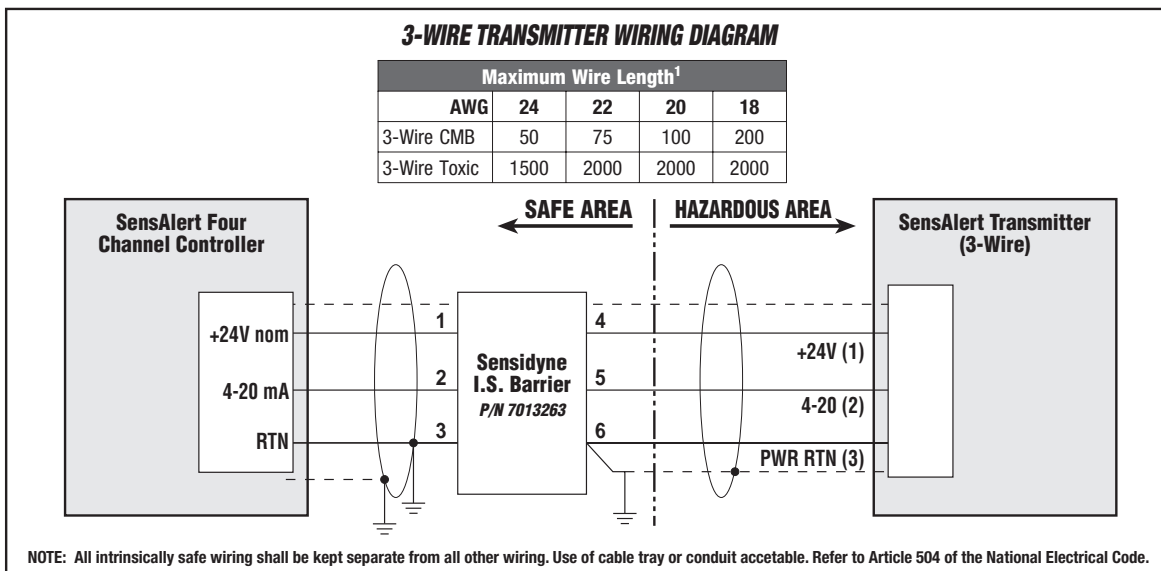
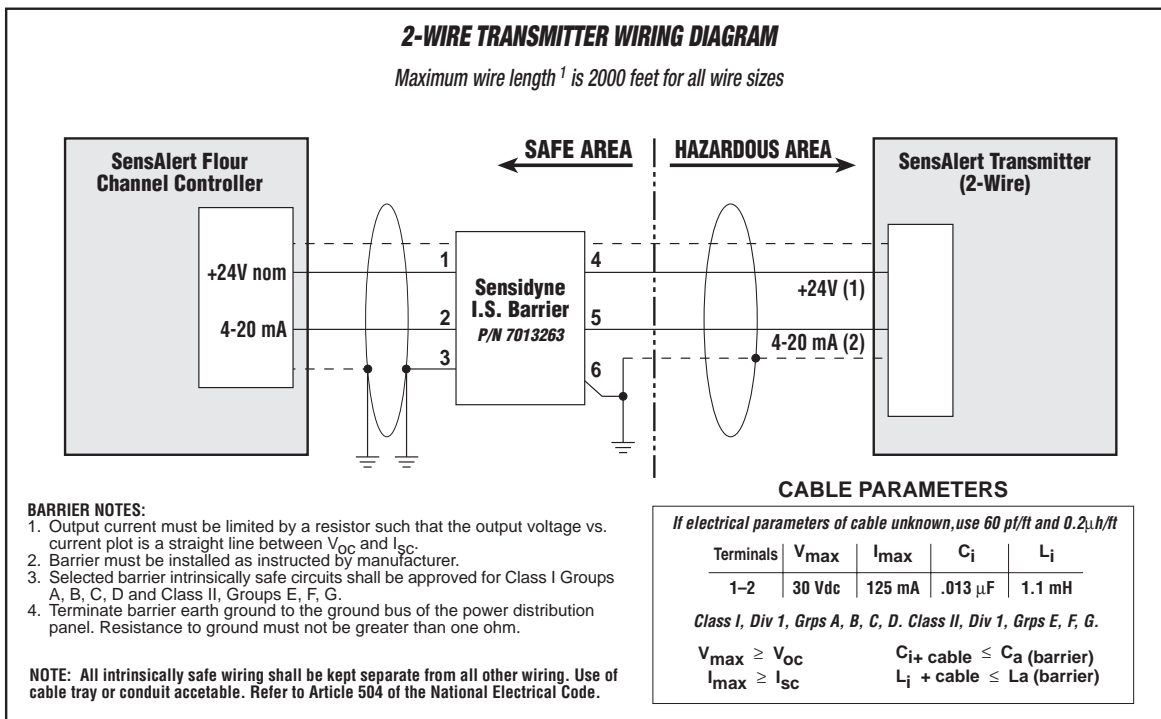

**NOTE 1:** Twisted, stranded wire with shield (grounded on one end only) is recommended. Distance is in feet. To obtain distance in meters multiply by 0.3.

**Figure 2.5**  
**Wiring to a SensAlert Transmitter (with Intrinsic Safety Barrier)**

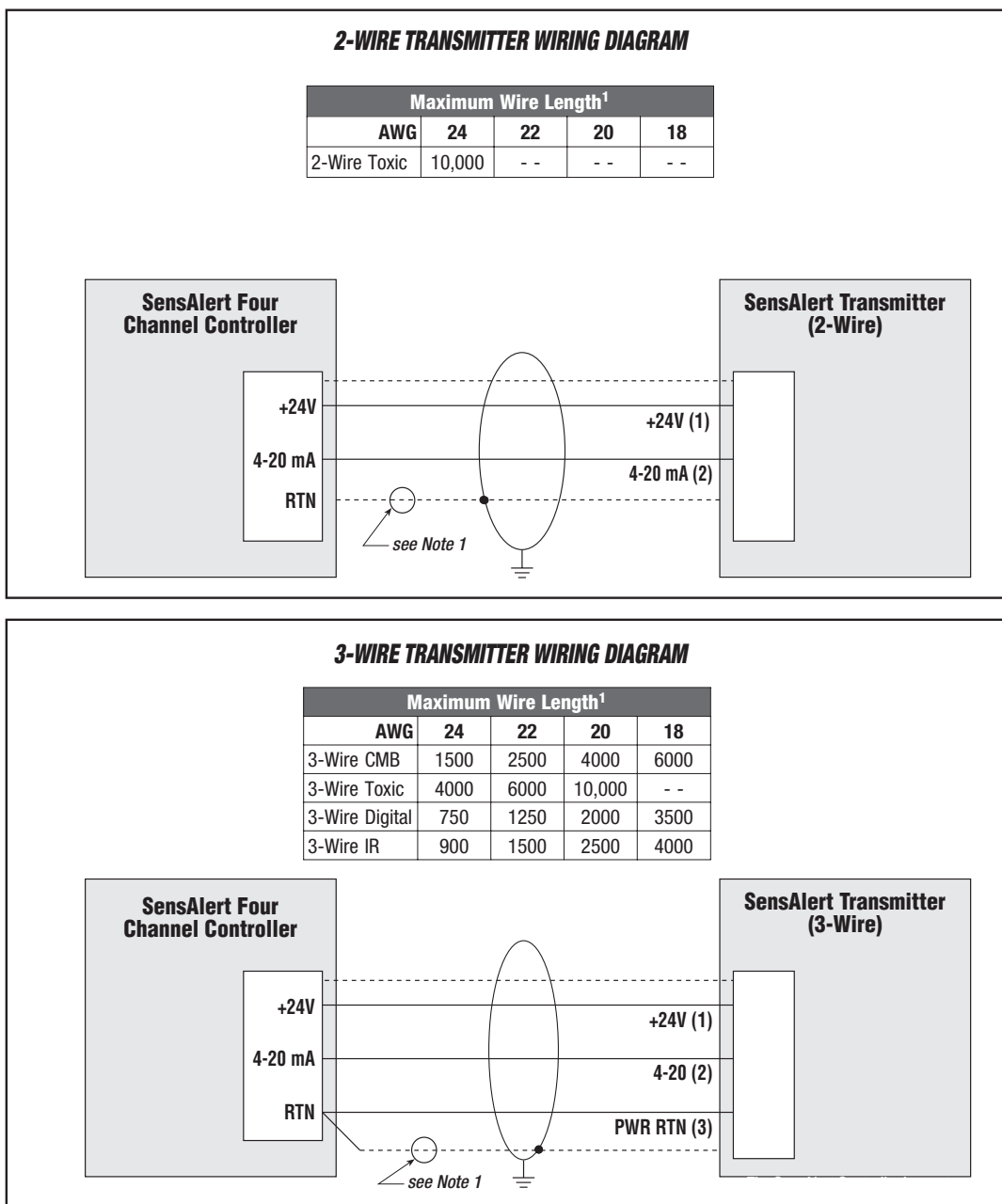

**NOTE 1:** Twisted, stranded wire with shield (grounded on one end only) is recommended. Distance is in feet. To obtain distance in meters multiply by 0.3.

**Figure 2.6**  
**Wiring to a SensAlert Transmitter (without Intrinsic Safety Barrier)**

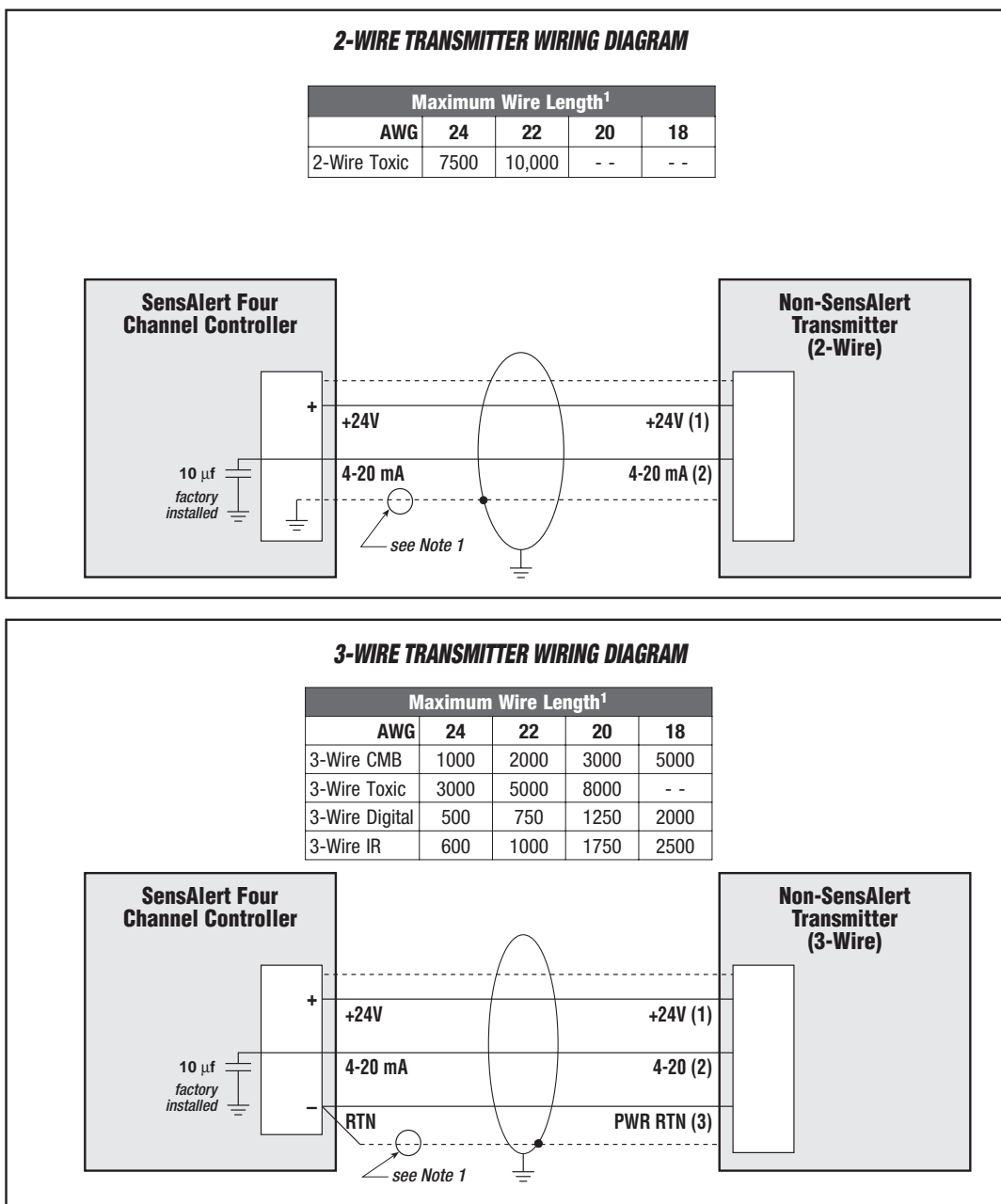

**NOTE 1:** Twisted, stranded wire with shield (grounded on one end only) is recommended. Distance is in feet. To obtain distance in meters multiply by 0.3.

**Figure 2.7**  
**Wiring to a non-SensAlert Transmitter (without Intrinsic Safety Barrier)**



## 3.1 MAIN SCREEN

The Main Screen is the default display for the controller during normal operation. The Main Screen displays the gas name and gas concentration (in ppm, %LEL, or %VOL). An example screen is shown below.

<b>CARBON MONOXIDE</b> <b>10 PPM</b>
---

During alarm conditions, Line 2 on the Main Screen also displays warning messages. The following screen shows a low alarm condition.

<b>CARBON MONOXIDE</b> <b>LO ALARM</b>
---

Additional messages include:

Loop-Fail *[loop power failure]*  
Lo Alarm *[is occurring]*  
Hi Alarm *[is occurring]*  
HiHi alarm *[is occurring]*  
Lo Alarm Latch *[has occurred]*  
Hi Alarm Latch *[has occurred]*  
HiHi Alarm Latch *[has occurred]*

## 3.2 VIEWING ALARM SETTINGS (Menu #1)

Pushing the **NEXT** button displays the Lo, Hi, and HIHI alarm settings for all 4 channels simultaneously. The menu number appears in the upper left-hand portion of each display.

<b>1</b>	<b>LO</b>	<b>HI</b>	<b>HIHI</b>
	<b>25</b>	<b>50</b>	<b>75</b>

## 3.3 ENTERING A PASSWORD

If a password has been set, the screen shown in Figure 3.1 appears when the channel select button is pressed. The “Enter Password” screen always appears in the Channel 1 LCD display.

The 1st digit on Line 2 is blocked out and ready to be entered. To enter the 4-digit password follow the steps below:

- 1) Use the **▲UP** and **▼DOWN** buttons to change the 1st digit to a number from 0-9. Press **SELECT** to enter the number.
- 2) Repeat the procedure for the 2nd digit.
- 3) Repeat the procedure for the 3rd digit.
- 4) Repeat the procedure for the 4th digit. When you press **SELECT** the entire 4-digit password is entered.

If the number entered matches the password, you gain access to the Set Alarms, Set-Up, and Diagnostics screens.

If the number does not match, you are given two more chances to enter the correct password. If the correct password is not entered on the third try access is denied (refer to Figure 3.1).

### 3.4 ENTERING CALIBRATION MODE

To enter calibration mode, press the Reset button (located on the outside bottom of the unit) for 5 seconds.

**NOTE**

*You cannot enter calibration mode when alarms are active.*

The following screen appears

**2 MIN CAL MODE  
RESET TO EXIT**

The screen indicates the number of minutes the alarms will be suppressed while calibration is being performed.

After time has elapsed, all readings will be “live.”

**NOTE**

*Recorder outputs are always “live.”*

When calibration has been completed, press the RESET button again to exit Calibration Mode..

**NOTE**

*The cal delay can be adjusted from the “Set Cal Delay” screen in the Set-Up Menu. See Section 5.1.2. Calibration delay can range from 1–30 minutes.*

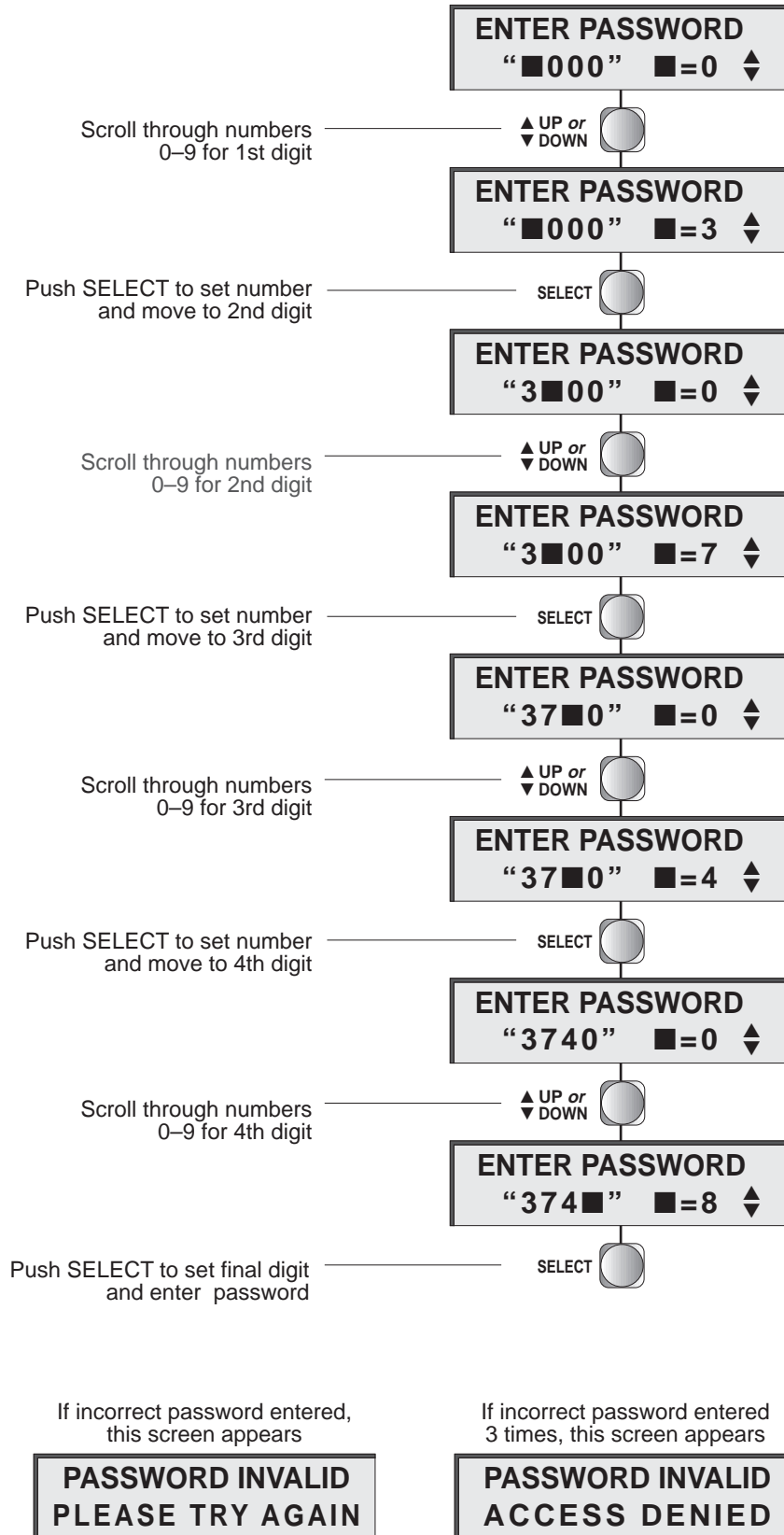

**Figure 3.1**  
**Entering A Password**

## SECTION FOUR

# CHANGING ALARM SETTINGS

The Set Alarms screen (#2) allows you to change the Lo, Hi, and Hi Hi alarm settings, as well as set the alarms to their default (factory-set) values.

To change the alarm settings, first push the channel select button. (You may encounter an Enter Password screen if a password has been set.) A Set Alarms Screen appears in the Channel 1 display (a “2” appears in the upper left-hand portion of the display – see below).

To access the Set Alarms screen for Channel 2, push the channel select button again. Push it a third time to access the Set Alarm screen for Channel 3 and again to reach Channel 4.

2 SCROLL & SELECT  
▼ LO ALARM

Use the ▼DOWN button to scroll down to the Lo, Hi, or HiHi alarm setting you want to change. (*Note: There is no HiHi alarm for oxygen sensors*). Press **SELECT**. The screen displays the current alarm setting.

LO ALARM  
◆ 25 PPM

Use the ▲UP and ▼DOWN buttons to change the setting.

LO ALARM  
◆ 30 PPM

Press **SELECT** to enter the new setting. A screen appears showing the new alarm setting.

LO	HI	HIHI
30	50	75

Repeat this procedure for each alarm you wish to change.

To change all alarms to their default settings, scroll to “Default Alarms” and press **SELECT**. A screen appears to confirm your action.

SET TO DEFAULTS  
UP=YES DOWN=NO

Pressing the ▼DOWN button cancels your action. Pressing the ▲UP button resets the Lo, Hi, and HiHi alarms to their default settings. A confirmation screen appears showing the default settings (see below).

LO	HI	HIHI
25	50	75

To return to the main screen, scroll down to “Resume” and press **SELECT**.

# SECTION FIVE USING SET-UP & DIAGNOSTICS

## 5.1 SET-UP (Menu #3)

The Set-Up Screen (“3” appears in the upper left-hand portion of the display) allows you to change the following SensAlert features:

- Enable or Disable a channel
- Change the calibration delay time
- Enable or change the password code
- Set the RS-485 address.
- Set alarm relays to “latching” or “non-latching”
- Adjust the zero point

Push the **NEXT** button several times until you reach the Set-Up screen (you may have to enter a password to get to this screen).

### 5.1.1 Enable/Disable a Channel

3 SCROLL & SELECT  
◆ ENABLE/DISABLE

Press **SELECT** to choose Enable/Disable (this item is always shown first when going to the Set-Up screen). The current status for that channel is shown on the screen.

Use the **▲UP** or **▼DOWN** buttons to toggle between “Enabled” and “Disabled”. Press **SELECT** to set the new channel status. If the channel status is changed from “disabled” to “enabled” the channel will show a normal operation screen. If the channel is changed from “enabled” to “disabled” the channel will show the following screen.

CHANNEL  
DISABLED

To return to the main screen, scroll down to “Resume” and press **SELECT**.

### 5.1.2 Set Calibration Delay

3 SCROLL & SELECT  
▼ SET CAL DELAY

Press **SELECT** to choose Set Cal Delay. The current delay (in minutes) is shown on the screen.

SET CAL DELAY  
◆ 2 MINUTES

Use the **▲UP** or **▼DOWN** buttons to change the calibration delay time. The delay time can range from 1 minutes to 30 minutes.

SET CAL DELAY  
◆ 5 MINUTES

When the desired delay time is displayed on the screen, press **SELECT**. To return to the main screen, scroll down to “Resume” and press **SELECT**.

### 5.1.3 Changing the Password

The unit is shipped from the factory with the password disabled. You can enable password protection anytime by changing the password code from its default setting (“0000”) to any number from 0001 to 9999. To disable the password, simply reset the password code back to 0000.

To change the password refer to Figure 5.1 and follow the steps below.

- 1) Using the **▼DOWN** button, scroll to “Change Password” and press **SELECT**.

**3 SCROLL & SELECT**  
**◆ CHANGE PASSWORD**

- 2) The screen shows the current password. The 1st digit is blocked out and ready to be changed. Use the **▲UP** or **▼DOWN** buttons to change the 1st digit to a number from 0-9. Press **SELECT** to set the number.
- 3) Repeat the procedure for the 2nd digit.
- 4) Repeat the procedure for the 3rd digit.
- 5) Repeat the procedure for the 4th digit. When you press **SELECT** the entire 4-digit password is now set. A confirmation appears showing you the new password.

### 5.1.4 Setting the RS-485 Address

**3 SCROLL & SELECT**  
**◆ RS-485 ADDR**

Use the **▼DOWN** button to scroll down to RS-485 Address, and then press **SELECT**. The current RS-485 address is displayed on the screen.

**RS-485 ADDR IS**  
**◆ “2”**

Use the **▲UP** or **▼DOWN** buttons to change the RS-485 address. The RS-485 address can range from 0 to 15. Press **SELECT** to enter the new address.

**NEW RS-485 ADDR**  
**13**

To return to the main screen, scroll down to “Resume” and press **SELECT**.

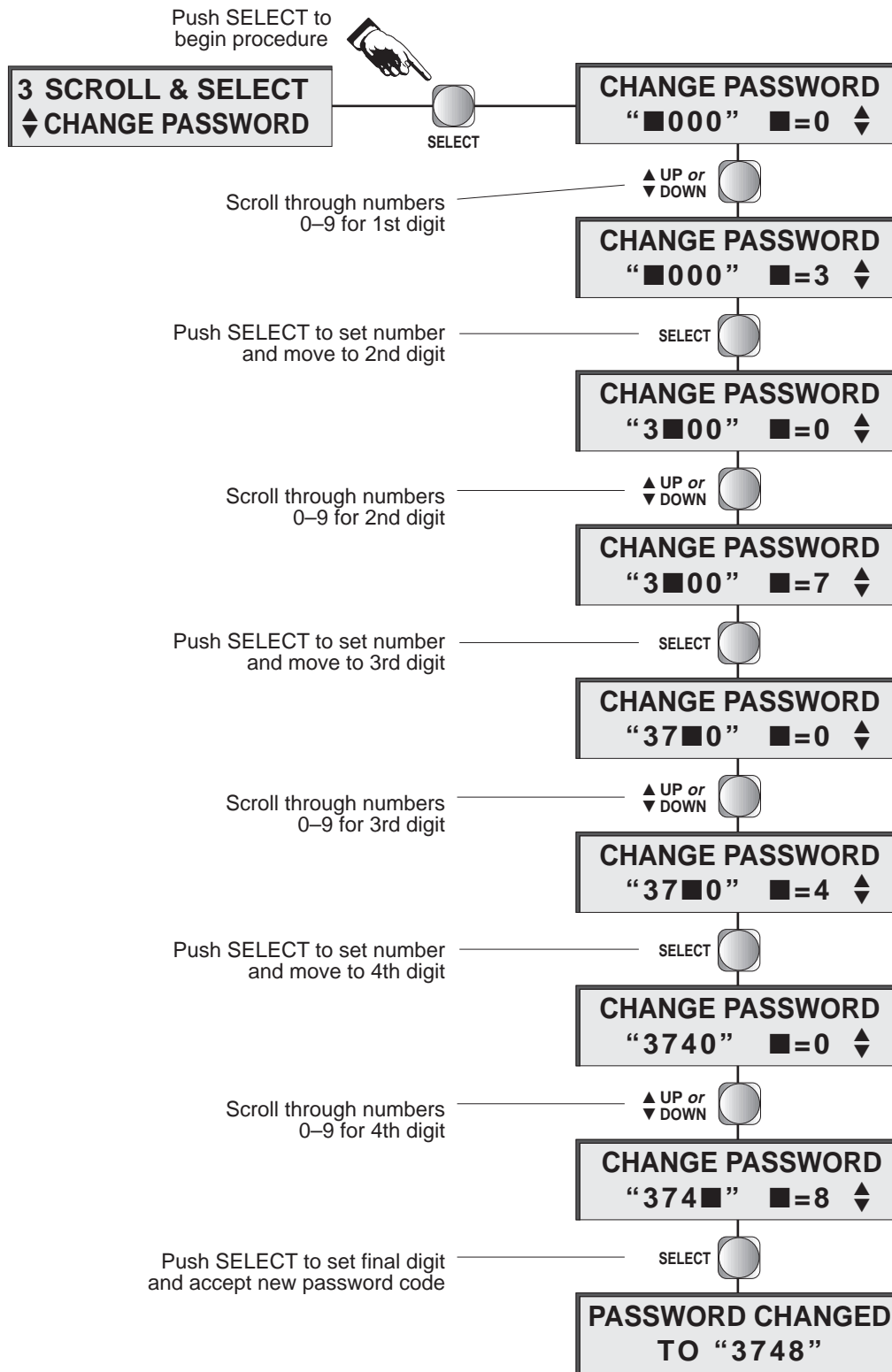

**Figure 5.1**  
**Changing a Password**

### 5.1.5 Setting Alarm Latching



Use the **▼DOWN** button to scroll down to Alarm Latching, then press **SELECT**. The currently set status (Latched or Not Latched) appears on the screen.



Press either the **▲UP** or **▼DOWN** button to toggle between Latched or Not Latched. Press **SELECT** to enter the new latching status. To return to the main screen, scroll down to “Resume” and press **SELECT**.

**NOTE**

*For oxygen sensors, alarm latching differs from other sensors: Latched Lo alarms supercede latched Hi alarms.*

### 5.1.6 Energize Relay



Use the **▼DOWN** button to scroll down to Energize Relay, then press **SELECT**. The currently set status (Energize or De-Energize) appears on the screen.



Press either the **▲UP** or **▼DOWN** button to toggle between Energize or De-Energize, then press **SELECT** to enter the new relay status.

To return to the main screen, scroll down to “Resume” and press **SELECT**.

### 5.1.7 Adjusting the Zero Point

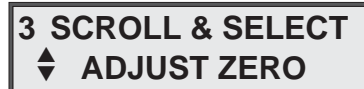

Use the **▼DOWN** button to scroll down to Adjust Zero, then press **SELECT**.

**NOTE**

*Adjusting zero for oxygen sensors sets the display to 20.9% vol*

To return to the main screen, scroll down to “Resume” and press **SELECT**.



## 5.2 DIAGNOSTICS (Menu #4)

Several diagnostic tests are performed from this screen. These include a Self-Test (similar to the self-test conducted during initial start-up) and the Relay Check.

To perform diagnostics, push the NEXT button several times until you reach the Diagnostics Screen (Screen #4) You may have to enter a password to get to this screen.

### 5.2.1 Self-Test

4 SCROLL & SELECT  
▼ SELF TEST

The unit performs tests on the hardware and software from this screen.

Press **SELECT** to choose Self Test (this item is always shown first when going to the Diagnostics Screen).

If the test is successful, the unit shows the next diagnostics screen (“Relay Check”). If the self-test is unsuccessful, the screen displays one or both of the following screens:

HARDWARE FAULT  
RETURN UNIT

SOFTWARE FAULT  
RETURN UNIT

If the unit fails the self test, contact Sensidyne Service. See Appendix E for information on returning products for repair.

To return to the main screen, scroll down to “Resume” and press **SELECT**.

### 5.2.2 Relay Check

4 SCROLL & SELECT  
⬆ RELAY CHECK

The alarm and fault relays are mechanically checked from this screen.

#### WARNING

*Any external alarms wired to these relays will sound during the relay check. It may be advisable to disconnect all alarms prior to running this test.*

Use the **▼DOWN** button to scroll down to “Relay Check” and press **SELECT**. The unit checks each of the alarm and fault relays while showing the following series of screens.

#### IMPORTANT

*This test will change the state of each relay for 1 second (depending on whether the relay is set for “energized” or “de-energized” operation). It is up to you to monitor the relay outputs to determine if the test is successful.*

RELAY CHANNEL 1  
LO ON

RELAY CHANNEL 1  
HI ON

RELAY CHANNEL 1  
HIHI ON

FAIL RELAY  
ON

To return to the main screen, scroll down to “Resume” and press **SELECT**.

# SECTION SIX

## MAINTENANCE & SERVICE

### 6.1 ADJUSTING THE OUTPUT

The output can be adjusted at any time using the potentiometers located on the Bottom PCB.

The potentiometers and associated jumpers are listed below:

VR1 & JP1 = Channel 1

VR2 & JP2 = Channel 2

VR3 & JP3 = Channel 3

VR4 & JP4 = Channel 4

When a jumper is installed the output ranges from 1 to 5 volts. When a jumper is removed the output ranges from 4 to 20 mA.

Turning the potentiometer clockwise increases the output level, while turning the potentiometer counter-clockwise decreases the output level.

The output level is read at the user's DCS device.

### 6.2 REPLACING THE POWER SUPPLY

The Power Supply Board is attached to the Bottom PCB. It should be replaced if it is damaged or defective. *Make certain all power is removed from the controller when performing this procedure.*

Refer to Figure 2.1 and replace the Power Supply Board as follows:

- 1) Unlatch and open the controller enclosure cover.
- 2) Remove the two (2) right-side mounting screws.
- 3) Swing open the Display PCB.
- 4) Disconnect the DC connector on the left side of the Power Supply Board.
- 5) Disconnect the AC connector on the right side of the Power Supply Board.
- 6) Remove the four (4) mounting screws on the Power Supply Board.
- 7) Remove the defective board.
- 8) Install the new Power Supply Board.
- 9) Install the four (4) mounting screws.
- 10) Reconnect the DC and AC connectors.
- 11) Swing close the Display PCB.
- 12) Install the two (2) mounting screws.
- 13) Close and latch the controller cover.

### 6.3 REPLACING THE DISPLAY PCB

The Display PCB is attached to four (4) metal stand-offs in the controller enclosure. It should be replaced when it is damaged or is defective. *Make certain all power is removed from the controller when performing this procedure.*

Refer to Figure 1.1 and replace the Display PCB as follows:

- 1) Unlatch and open the controller enclosure cover.
- 2) Unscrew the four (4) mounting screws on the Display PCB.
- 3) Partially remove the Display PCB.
- 4) Disconnect the ribbon cable from the bottom of the Display PCB.
- 5) Remove the defective Display PCB.
- 6) Connect the ribbon cable to the bottom of the new Display PCB.
- 7) Align the left hand mounting holes of the Display PCB over the hinged standoffs.
- 8) Install two (2) of the mounting screws. Make certain the screws are properly inserted into the hinged standoffs.
- 9) Swing the Display PCB closed and install the remaining two (2) mounting screws.
- 10) Close and latch the controller cover.

### 6.4 REPLACING THE BOTTOM PCB

The Bottom PCB is attached to four (4) metal stand-offs in the controller enclosure. It should be replaced when it is damaged or is defective. *Make certain all power is removed from the controller when performing this procedure.*

Refer to Figure 1.1 and replace the Bottom PCB as follows:

- 1) Unlatch and open the controller enclosure cover.
- 2) Unscrew the four (4) mounting screws on the Display PCB.
- 3) Partially remove the Display PCB.
- 4) Disconnect the ribbon cable from the Bottom PCB.
- 5) Remove the terminal plugs from terminals J2 through J12 (as appropriate). Remove the grounding wire and washers.
- 6) Unscrew all four (4) standoffs. Remove the lockwasher and flat washer from each post.
- 7) Remove the defective Bottom PCB.
- 8) Install the new Bottom PCB.
- 9) Place a flat washer and lock washer over each mounting post. Install the grounding wire and washers.
- 0) Install the four (4) standoffs. Make certain the hinged standoffs are installed on the left side.
- 11) Replace the terminal plugs removed earlier.
- 12) Align the left hand mounting holes of the Display PCB over the hinged standoffs.
- 13) Install two (2) of the mounting screws. Make certain the screws are properly inserted into the hinged standoffs.
- 14) Swing open the Display PCB and connect the ribbon cable to the new Bottom PCB.
- 15) Swing the Display PCB closed and install the remaining two (2) mounting screws.
- 16) Close and latch the controller cover.

# SECTION SEVEN

## PARTS LIST

### • CONTROLLER PARTS

Part No.	Item/Description
7013227-1	SensAlert Four Channel Controller Base Unit
7010650-4	Ribbon Cable Assembly (8")
7013230-1	Display PCB (Top Board)
7013226-1	Bottom PCB
7017350	AC Power Supply Board
7013243	Controller Housing
7017160	Standoff (10-32 x 4 1/2)
7017161	Standoff, Hinged
7017129-2	Terminal Plug (2 position)
7017129-3	Terminal Plug (3 position)
7017129-4	Terminal Plug (4 position)
7017196-8	Terminal Block & Plug (8 position)
7017196-12	Terminal Block & Plug (12 position)
7017134	Alarm Beeper
209-0001-01	AC Fuse, 4 Amp, fast-blow
3619906-06	DC Fuse, 2 1/2 Amp, fast-blow
7017163	3/4" EMT Connector
3615099-2	Reset Switch
7013227M	Operation & Service Manual
7013263	Intrinsic Safety Barrier [3-wire]
7013282	I.S. Barrier Mounting Rail [holds 4 barriers]
7013283	I.S. Barrier Enclosure, assembled with DIN rails (hold 8 barriers)

## • SPECIFICATIONS

### General Specifications

Operator Buttons .....	CHANNEL SELECT NEXT SELECT ▲ UP ▼ DOWN
Housing .....	NEMA 4X fiberglass
Mounting Requirement .....	Mount to wall and attach conduit
Overall Dimensions .....	11.2" (W) x 12.8" (H) x 6.3" (D) 284 mm (W) x 325 mm (H) x 160 mm (D)
Weight .....	10.0 lbs (4.5 kg)

### Classification

Intrinsic Safety Rating .....	Designed to operate intrinsically safe SensAlert transmitters when installed with a Sensidyne I.S. barrier per wiring diagram.
-------------------------------	--

### Environmental Specifications

Operating Temperature Range .....	0°C to 45°C (32°F to 113°F)
Storage Temperature Range .....	-20°C to 45°C (-4°F to 113°F)
Operating Humidity Range .....	0–95 %RH, noncondensing
Storage Humidity Range .....	0–95 %RH, noncondensing
Altitude .....	up to 2000 meters

### Electrical/Electronic Specifications

Power Input Requirements .....	90-265 VAC, 24 Vdc Battery Backup (20-26 Vdc)
Fuses .....	AC: 4 Amp (5 x 20 mm) DC: 3 Amp (3 AG), fast blow
Alarm Contact Rating .....	120 VAC, 6A 240 VAC, 3A 24 VDC, 6A
Maximum Power Consumption .....	60 watts
Grounding .....	Shielded twisted pair cable is recommended (with shield connected to earth ground), or unshielded cable inside grounded conduit.
Transmission Link .....	4–20 mA current, non-isolated 2 wires, or 1–5 volts.
Wire Gauge .....	14–18 AWG, recommended (14 AWG maximum)
Maximum Allowable Line Length .....	2000' (610 m) for 100 $\Omega$ termination resistance and for wire sizes larger than 18 AWG.

# APPENDIX D

## TROUBLESHOOTING GUIDE

<i>Cause</i>	<i>Remedy</i>
<b>• Unit does not function when attached to power.</b>	
<b>Fuses(s) blown.</b>	Replace blown fuse with 3/8 Amp (3 AG) fuse at F1 & F2 for AC, or 1 Amp (3 AG) at F3 for DC.
<b>AC/DC not connected to PCB.</b>	Ensure proper connection to PCB at TB9 for AC, or TB8 for DC.
<b>AC not properly attached to TB9.</b>	Ensure that the HI AC line is connected to Pos 3 and the Low AC line is connected to Pos 1.
<b>DC polarity reversed.</b>	Ensure polarity at TB8 and replace fuse at F3 (1 Amp 3 AG).
<b>• Transmitter does not function.</b>	
<b>Transmitter improperly wired.</b>	Ensure proper connection at TB5.
<b>3-wire transmitter requires more than 100 mA of current to operate.</b>	Replace with compatible transmitter.
<b>• Front panel lights and display do not function.</b>	
<b>Loose connection on ribbon cable.</b>	Ensure proper connection at J1 on front panel and J2 on back panel.
<b>Power Supply not functioning.</b>	See "Unit does not function when attached to power."
<b>Microprocessor corrupted.</b>	Replace microprocessor.
<b>• Alarm not sounding.</b>	
<b>Alarm beeper not connected to PCB.</b>	Ensure connection at TB11 and secure screw terminals on beeper.
<b>• RS-485 Test returns a "Port Not Functioning" message.</b>	
<b>Normal message unless custom software was factory-installed.</b>	No action needed.
<b>• Continuous Buzzer Sounding and "Fail Relay" activated.</b>	
<b>Circuit failure.</b>	Replace controller.
<b>• Unit does not recognize sensor.</b>	
<b>Not SensAlert or SensAlert Plus transmitters.</b>	Features only available with SensAlert, SensAlert Plus and SensAlert ASI transmitters.
<b>4-20mA communications mode not enabled on transmitters.</b>	Ensure jumper in place on SensAlert. SensAlert Plus and SensAlert ASI, verify menu setting.

# APPENDIX E RETURNED MATERIAL AUTHORIZATION

Sensidyne maintains an instrument service facility at the factory to provide its customers with both warranty and non-warranty repair. Sensidyne assumes no liability for service performed by personnel other than Sensidyne personnel. To facilitate the repair process, please contact the Sensidyne Service Department in advance for assistance with a problem which cannot be remedied and/or requires the return of the product to the factory. All returned products require a Returned Material Authorization (RMA) number. Sensidyne Service Department personnel may be reached at:

**Sensidyne**  
**1000 112th CIRCLE N, SUITE 100**  
**ST. PETERSBURG, FL 33716 USA**  
**727-530-3602**  
**727-539-0550 [FAX]**

All non-warranty repair orders will have a minimum fee whether the repair is authorized or not. This fee includes handling, administration and technical expenses for inspecting the instrument and providing an estimate. However, the estimate fee is waived if the repair is authorized.

If you wish to set a limit to the authorized repair cost, state a "not to exceed" figure on your purchase order. Please indicate if a price quotation is required before authorization of the repair cost, understanding that this invokes extra cost and handling delay.

Sensidyne's repair policy is to perform all needed repairs to restore the instrument to its full operating condition.

Repairs are handled on a "first in - first out" basis. Your order may be expedited if you authorize an expediting fee. This will place your order next in line behind orders currently in process.

Pack the instrument and its accessories (preferably in their original packing) and enclose your return address, purchase order, shipping and billing information, RMA number, a description of the problem encountered with your instrument and any special instructions. All prices are subject to change without notice.

If this is the first time you are dealing directly with the factory, you will be asked to prepay or to authorize a COD shipment.

Send the instrument, prepaid, to:

**SENSIDYNE**  
**1000 112th CIRCLE N, SUITE 100**  
**ST. PETERSBURG, FL 33716 USA**

**ATTENTION: Service Department**

**RMA #:** \_\_\_\_\_

## SERVICE OPTIONS

The Sensidyne Service Department offers a variety of service options which will minimize costly interruptions and maintenance costs. These options include initial training, on-site technical assistance, and full factory repairs. Sensidyne has developed several programs which offer options best suited to your applications and needs. For further information, contact the Sensidyne Service Department at the following numbers: 800-451-9444 • 727-530-3602 • 727-538-0671 [fax].

## MODBUS CODES & SPECIFICATIONS

(Modbus connection on bottom board at J7)

### Modbus Specifications

Type ..... RS-485 Serial  
 Mode ..... RTU  
 Speed ..... 9600 baud  
 Wiring ..... 2 wire

### RS-485 Communication Specifications

Speed ..... 9600 baud  
 Bits ..... 8 bits  
 Parity ..... No Parity  
 Stop Bits ..... 1 Stop Bit  
 Duplex Modes ..... Half Duplex

### Modbus Addresses

CH 1	CH 2	CH 3	CH 4	Read/Write	Description
40033	40034	40035	40036	Read only	Gas Type (Integer)
40001	40003	40005	40007	Read only	Gas Value (Floating-Point)
40009	40011	40013	40015	Read/Write	Low Alarm Set Point (Floating-Point)
40017	40019	40021	40023	Read/Write	High Alarm Set Point (Floating-Point)
40025	40027	40029	40031	Read/Write	Hi Hi Alarm Set Point (Floating-Point)
000002	000003	000004	000005	Read/Write	Alarm Latching (Bit)
000006	000007	000008	000009	Read/Write	Channel Disable (Bit)
000001	000001	000001	000001	Write only	Reset (Bit)

### Modbus Function Codes (decimal)

Code	Description
01	Read Coil Status
03	Read Hold Registers
05	Force Single Coil
06	Preset Single Register
15	Force Multiple Coils
16	Preset Multiple Registers





***SENSIDYNE***<sup>®</sup>

Sensidyne, LP

1000 112th Circle N, Suite 100

St. Petersburg, Florida 33716 USA

(800) 451-9444 • (727) 530-3602 • Fax: (727) 539-0550

web: [www.sensidyne.com](http://www.sensidyne.com) • e-mail: [info@sensidyne.com](mailto:info@sensidyne.com)

