



BY JOHNSON CONTROLS



***YIA Single-Effect Absorption Chillers Steam And Hot Water Chillers  
Style A***

120-1377 TONS  
(420 - 4840 kW)



# Table of Contents

---

<i>FORM 155.16-EG1 (1008)</i> .....	1
<i>Nomenclature</i> .....	3
<i>Introduction</i> .....	4
<i>Reliability Features</i> .....	5
<i>How It Works</i> .....	8
<i>MicroComputer Control Center</i> .....	10
<i>Mechanical Specifications</i> .....	12
<i>Optional Features</i> .....	15
<i>Application Data</i> .....	16
<i>Ratings</i> .....	30
<i>Nozzle Arrangements</i> .....	34
<i>Physical Data</i> .....	36
<i>Electrical Data</i> .....	39
<i>Guide Specifications</i> .....	41

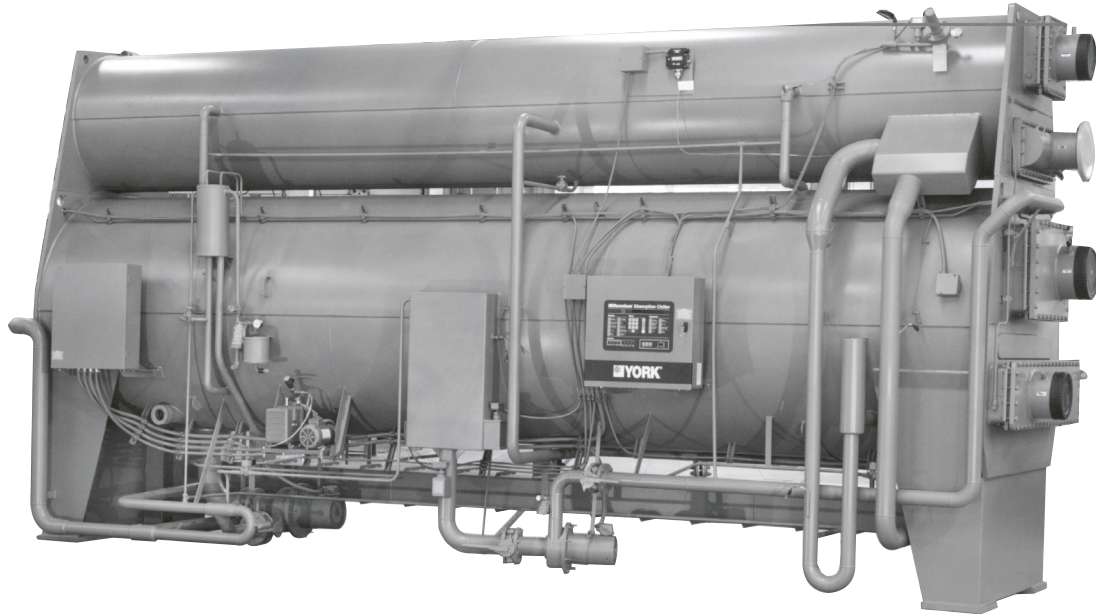

## NOMENCLATURE

The model number denotes the following characteristics of the unit:

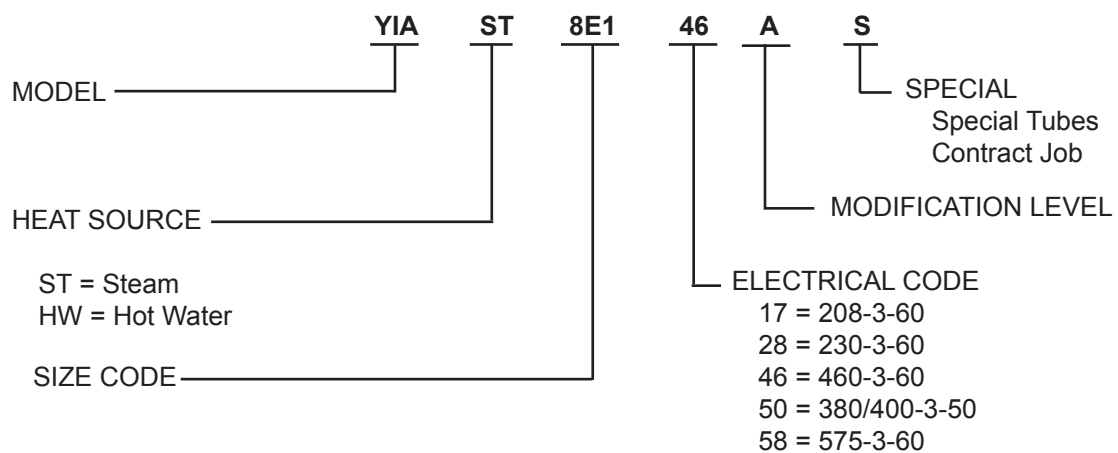

# Introduction

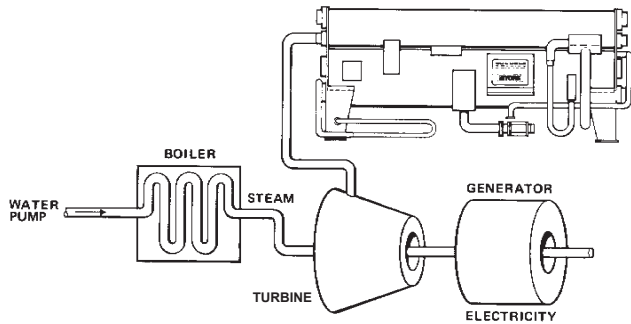

**COGENERATION**

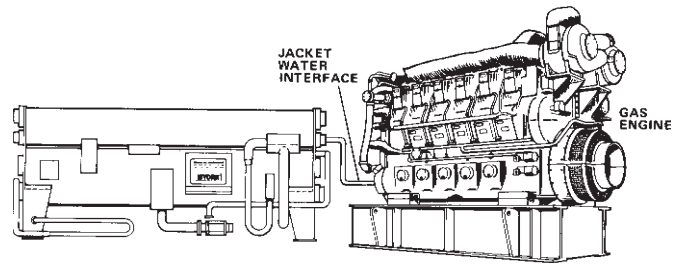

**WASTE HEAT RECOVERY**

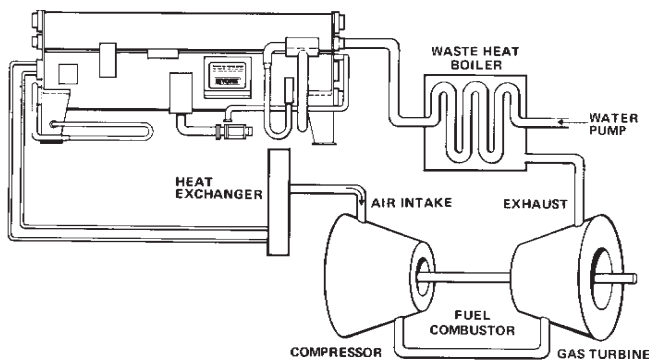

**INLET AIR COOLING**

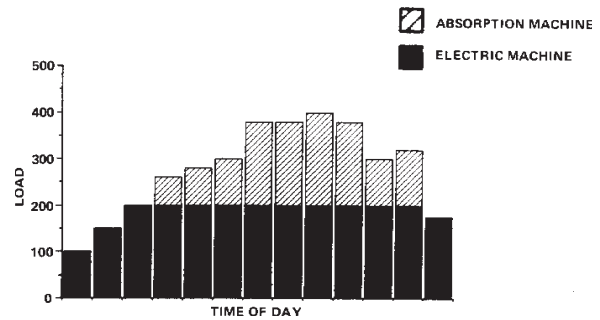

**PEAK SHAVING/COMMERCIAL COOLING**

Today's environmental and energy considerations demand innovative chiller plant designs which save expensive peak load kW-hours and eliminate CFC's. In a growing number of applications with waste heat or abundant low pressure steam, single effect absorption chillers offer an ideal means of saving on cooling costs without a significant installation cost penalty.

That's why Johnson Controls is proud to introduce the YIA Single Effect Absorption Chiller. The YIA Absorption Chiller offers the rugged, industrial-grade design of our previous single effect model, with a whole new package of user-friendly microprocessor controls, designed to increase reliability and enhance performance.

Applications particularly well-suited for the YORK YIA Absorption Chiller include the following:

**Cogeneration** – For cogeneration systems, high pressure steam has many valuable uses, while low pressure steam is considerably less useful, yet more plentiful. In these plants, the YIA absorber can provide cooling with low pressure steam or hot water, freeing high pressure steam for power generation or other valuable uses.

**Inlet Air Cooling** – Use a YIA chiller to cool inlet air to a gas turbine or a compressor. The lower specific volume associated with cooler air provides more combustion capacity by increasing the overall efficiency of the system.

**Waste Heat Recovery** – Recover waste heat from printing plants, incinerators or gas engine jacket water to provide required comfort or process cooling at little operational cost.

**Commercial Cooling/Peak Shaving** – For particularly pronounced peak loads with few operating hours, the YIA absorber's lower first cost may provide an acceptable payback when more efficient, yet more expensive double effect chillers cannot.

For these and similar money-saving designs, consider the field-proven YIA design. In over thirty-five years of operation, the YORK single-effect design has proven itself in applications ranging from schools to refineries. Now, with state-of-the-art controls and continual product improvement, the YORK YIA machine is truly without peer. When it comes to absorption technology, there's only one leader - Johnson Controls

# Reliability Features

The YORK YIA Absorption Chiller introduces a revolutionary system of unit controls and mechanical devices designed to keep the chiller running in even the most extreme circumstances. Old concerns about crystallization are approached with a hybrid of new technology and older, proven methods. Additionally, the YIA chiller contains a host of other features designed to give the machine a long, trouble-free life. The result: the smartest, safest, and most reliable single effect absorption chiller on the market today. See Fig. 1 for the location of the reliability features.

**1. Concentration Limit** – The MicroComputerControl Center actually detects high lithium bromide concentrations which can damage the unit. When high concentrations are present, the panel limits heat input until the solution reaches equilibrium at a lower concentration. In this manner, the machine operates only within the safe and practical limits of the lithium bromide absorption cycle.

**2. “J” Tube** – If crystallization were to occur, it would begin in the strong solution side of the solution heat exchanger. This would force the strong solution to back up into the generator. At a certain generator solution level, the hot strong solution would overflow into the “J” tube. This tube sends hot solution directly to the absorber, immediately warming the weak solution. The heated weak solution would then warm the crystallized solution on the opposite side of the heat exchanger. This transfer of heat will cause the crystallized lithium bromide to move back into solution, allowing the unit to continue operation.

**3. Stabilizer Valve** – If minor crystallization occurs and causes overflow in the “J” tube, the temperature of the “J” tube will increase because of the hot solution. A specially placed sensor detects this change in temperature, and the panel sends a signal to open a solenoid on the unit’s patented Stabilizer Valve. When the Stabilizer Valve is open, refrigerant water is injected into the strong solution immediately before the heat exchanger. The water serves to dilute the strong solution, allowing the crystallized lithium bromide to become soluble at a lower concentration.

**4. Steam Supply Pressure/Temperature Limit** – The Control Center actually monitors the inlet steam (or hot water) temperature and steam pressure. The panel will close the control valve to the machine if temperatures or pressures become excessive, thus protecting the machine from potentially harmful conditions.

**5. Load Inhibition** – Before the YIA unit shuts down due to a given safety condition (see Controls section for a complete list), it first crosses a warning threshold which will cause the panel to limit heat input to the machine. In this manner, the YIA unit continues its vital task of making chilled water, while allowing operators the opportunity to find system deficiencies before they lead to an actual shutdown.

**6. Stainless Steel Pans** – Both the pan in the evaporator (which holds refrigerant) and the pan in the condenser (which holds refrigerant) are fabricated from stainless steel, giving the machine added protection against corrosion.

**7. Hermetic Pumps** – The YIA’s industrial pump provides a life of trouble-free operation with a recommended 55,000 hours between service inspections. These pumps feature self-adjusting spring loaded conical bearings that ensure concentric rotation and reduce interference. These bearings, made of carbon graphite, maintain correct bearing/journal fit at all times and ensure extended trouble free operation.



**8. Double Walled Evaporator** – The Evaporator on each YIA model is lined with a second wall, reducing the amount of sweating that occurs on the evaporator shell. To eliminate sweating on the evaporator shell and refrigerant piping, the refrigerant insulation option must be applied.

**9. Purge System** – YORK’s efficient purge system expels non-condensable gases from the unit’s external purge chamber without the risk of spilling lithium bromide.

**10. Evaporator Spray Nozzles** – Evaporator spray nozzles are made of corrosion resistant brass to ensure long life.

**11. Absorber Spray Nozzles** – Absorber spray nozzles are fabricated from stainless steel or brass, providing trouble-free operation in a particularly demanding environment.

**12. Single Power Connection** – A single point power connection is all that is required for the YIA Absorption Chiller, providing further reliability and ease of installation.

**13. 45°F (7.2°C) Condenser Water** – The YIA chiller is capable of operating with entering condenser water temperatures as low as 45°F (7.2°C). Without proper compensation, lower tower water temperatures cause: low refrigerant level, potential for crystallization, and low refrigerant temperature. The combination of three control systems described below allow the YIA to maintain a

# Reliability Features - continued

stable balance of solution and refrigerant parameters as entering tower water temperature varies:

- At low refrigerant levels, the **Unloader Control Valve** opens to inject lithium bromide into the refrigerant line. This maintains refrigerant level preventing pump cavitation and keeps flow available to dilute the concentrated solution.
- **The Steam Valve Override Control System** adjusts the steam input regulating the concentration of the

lithium bromide leaving the generator to a safe level for the operating temperature of the machine.

- **The Stabilizer Valve** will open to dilute the absorber concentration if the refrigerant temperature drops below a preset level.

The result is a system that maintains proper balance of machine loading, and solution and refrigerant characteristics to allow continuous operation with tower water

Available Capacity at Varying Tower Water Temperature

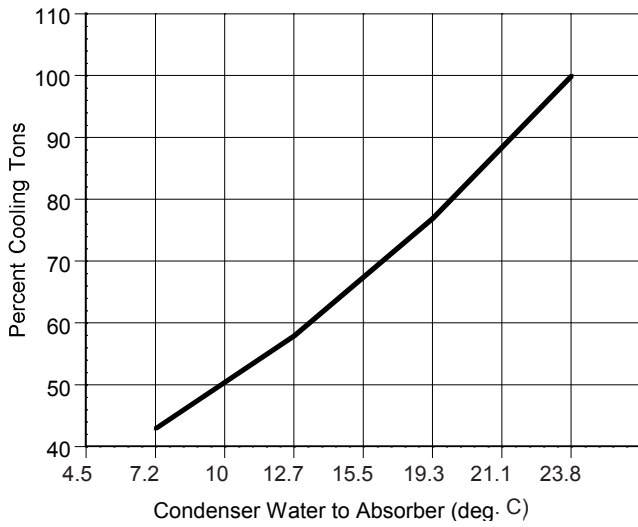

Available Capacity at Varying Tower Water Temperature

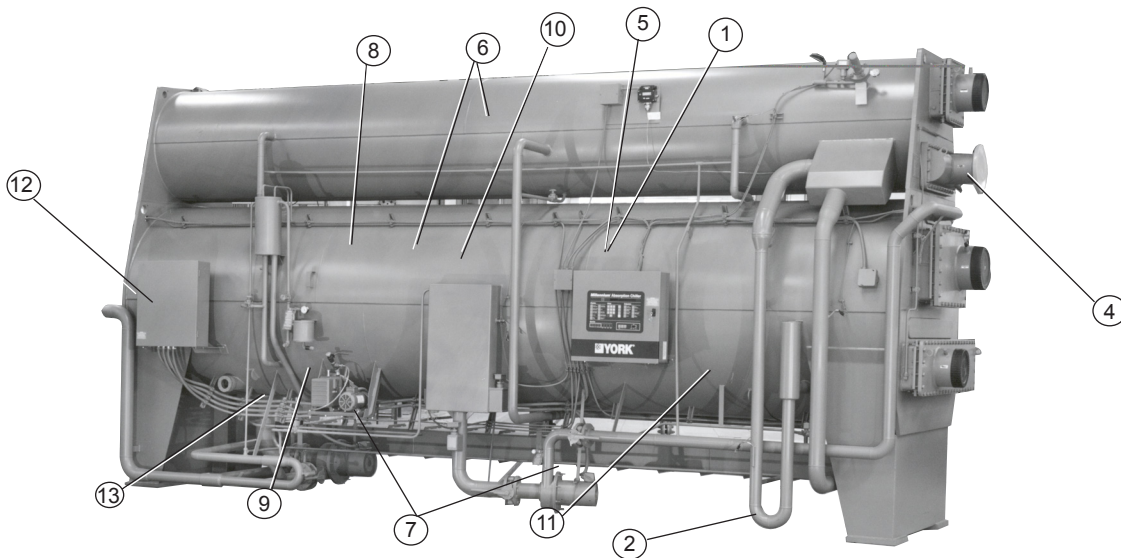
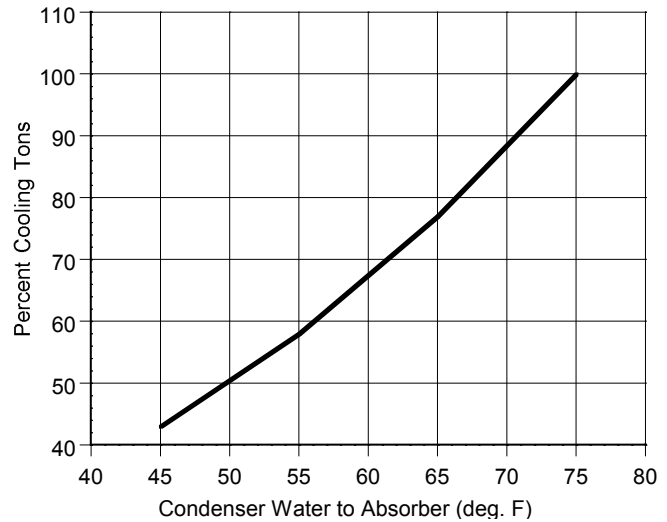

FIG. 1 – SINGLE-STAGE ABSORPTION CHILLER RELIABILITY FEATURES



---

**14. ADVAGuard™ 750 Corrosion Inhibitor** – is an environmentally friendly inorganic corrosion inhibitor that provides superior corrosion protection. Corrosion inhibitors promote the formation of an oxide film on the surfaces of the chiller that are in contact with LiBr solution. ADVAGuard™ 750 Corrosion Inhibitor creates a highly stable magnetite layer resulting in lower hydrogen generation

and only an eighth of the corrosion as compared with other traditional inhibitors.

**15. Pump Isolation Valve** – Refrigerant and Solution Pump suction and discharge connections equipped with factory installed isolation valves permit quick and easy servicing of pumps.

# How It Works

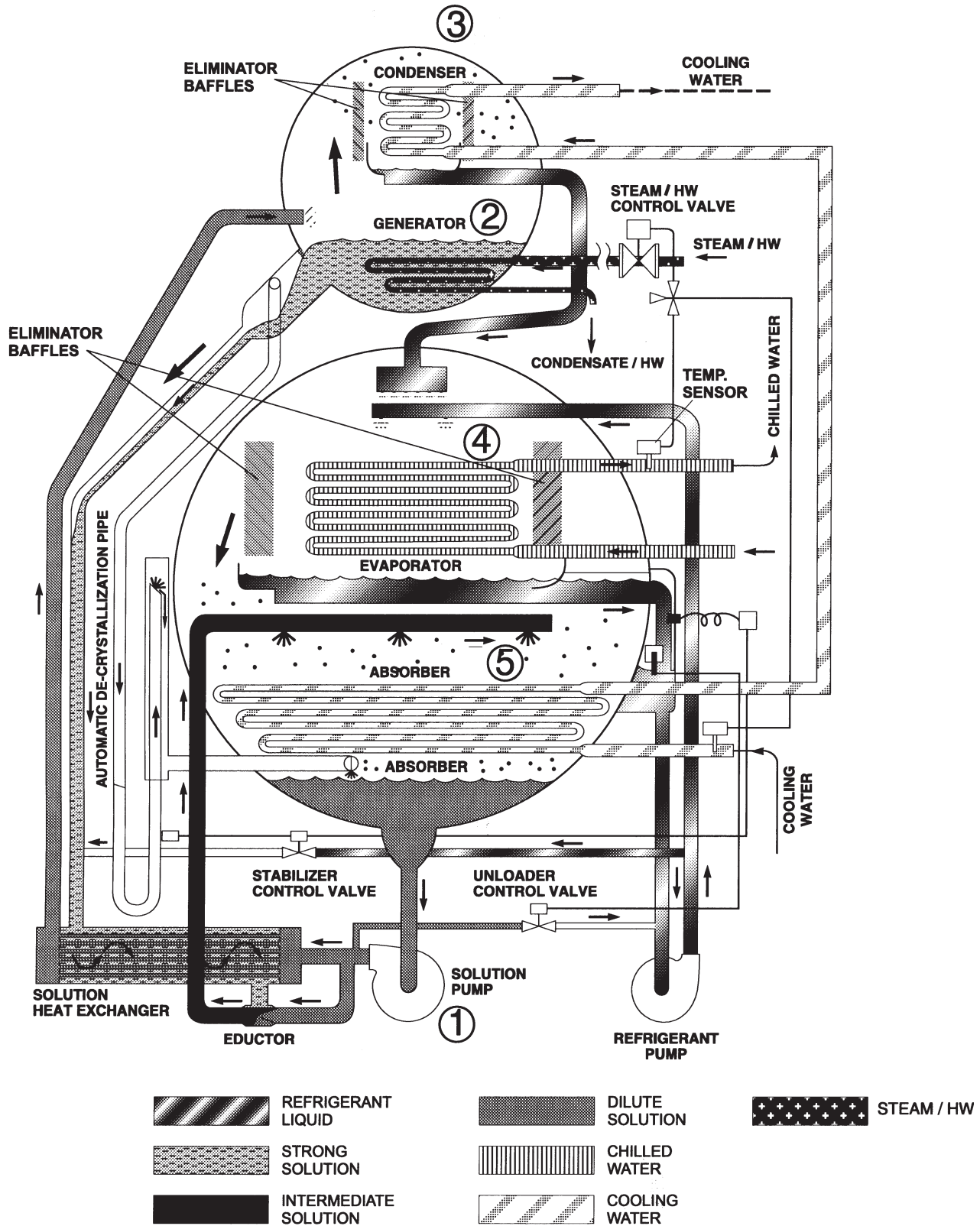
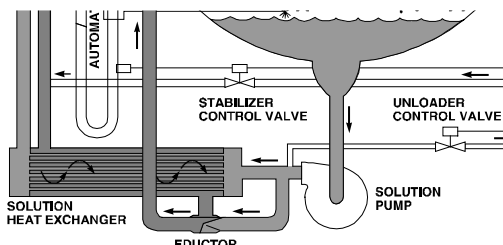

FIG. 2 – STANDARD STEAM/HOT WATER CYCLE DIAGRAM



The single effect absorption cycle uses water as the refrigerant and lithium bromide as the absorbent. It is the strong affinity that these two substances have for one another that makes the cycle work. The entire process occurs in almost a complete vacuum.

- 1. Solution Pump** – A dilute lithium bromide solution is collected in the bottom of the absorber shell. From here, a hermetic solution pump moves the solution through a shell and tube heat exchanger for preheating.
- 2. Generator** – After exiting the heat exchanger, the dilute solution moves into the upper shell. The



solution surrounds a bundle of tubes which carries either steam or hot water. The steam or hot water transfers heat into the pool of dilute lithium bromide solution. The solution boils, sending refrigerant vapor upward into the condenser and leaving behind concentrated lithium bromide. The concentrated lithium bromide solution moves down to the heat exchanger, where it is cooled by the weak solution being pumped up to the generator.

- 3. Condenser** – The refrigerant vapor migrates through

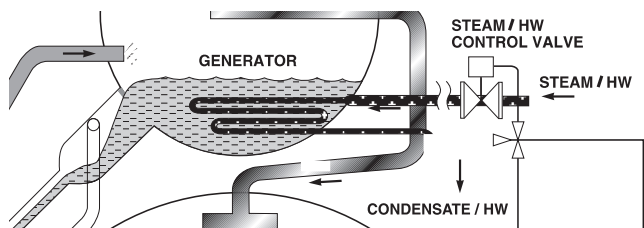

mist eliminators to the condenser tube bundle. The refrigerant vapor condenses on the tubes. The heat is removed by the cooling water which moves through the inside of the tubes. As the refrigerant condenses, it collects in a trough at the bottom of the condenser.

- 4. Evaporator** – The refrigerant liquid moves from the condenser in the upper shell down to the evaporator

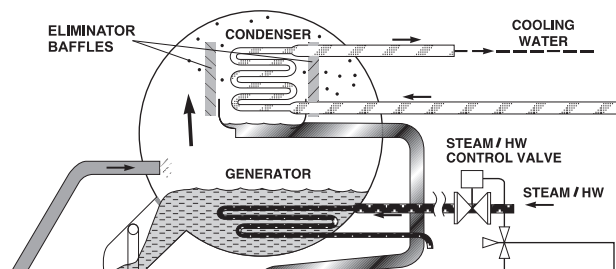

in the lower shell and is sprayed over the evaporator tube bundle. Due to the extreme vacuum of the lower shell [6 mm Hg (0.8 kPa) absolute pressure], the refrigerant liquid boils at approximately 39°F (3.9°C), creating the refrigerant effect. (This vacuum is created by hygroscopic action - the strong affinity lithium bromide has for water - in the Absorber directly below.)

- 5. Absorber** – As the refrigerant vapor migrates to the absorber from the evaporator, the strong lithium

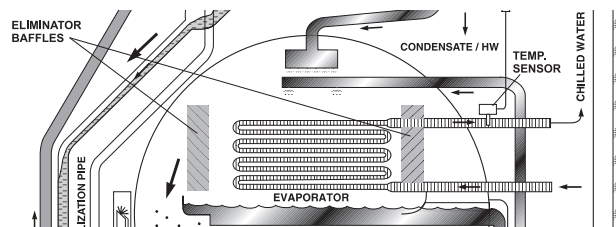

bromide solution from the generator is sprayed over the top of the absorber tube bundle. The strong lithium bromide solution actually pulls the refrigerant vapor into solution, creating the extreme vacuum in the evaporator. The absorption of the refrigerant vapor into the lithium bromide solution also generates heat which is removed by the cooling water. The now dilute lithium bromide solution collects in the bottom of the lower shell, where it flows down to the solution pump. The chilling cycle is now completed and the process begins once again.

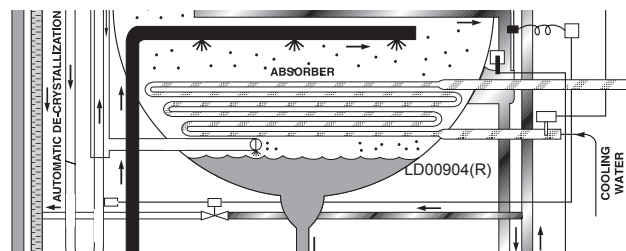

# MicroComputer Control Center

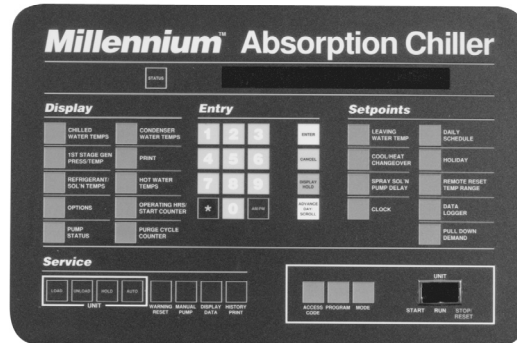

FIG. 3 – CONTROL CENTER

The YORK MicroComputer Control Center is designed for the very best in chiller protection and overall system efficiency. As standard equipment on all YIA chillers, the Control Center is a major development in absorption chiller technology, providing the most precise and reliable control available in the industry.

## INFORMATION DISPLAY

Vital chiller operating information can be shown on the 40 character alphanumeric display. All information is in the English language with numeric data provided in English or metric units. A German language control panel is also available. Information provided standard on all units includes:

- Chilled water temperatures, entering and leaving
- Tower water temperatures, entering and leaving
- Generator pressure and temperature
- Refrigerant temperature
- Solution temperature
- Operating hours
- Number of starts
- Number of purge cycles (last 7 days and lifetime total)
- Control valve position (in %)
- Indication of each pump's operation
- Inlet steam pressure and temperature
- Hot water temperature
- Solution concentration

In addition, all operating and setpoint information can be transmitted to an optional remote printer through the RS232 port to obtain data logs:

- At any time by pressing the PRINT button
- At set time intervals by programming the panel
- After a safety shutdown to list the cause of the shutdown and the operational parameters just prior to shutdown
- For a complete history print-out of the last four shutdowns and operational parameters just prior to shutdown.

## CAPACITY CONTROL

When automatic capacity control is desired, the Control Center automatically varies the steam/hot water flow rate with a fuzzy logic control algorithm in order to maintain the programmed leaving chilled water setpoint for cooling loads ranging from 10% to 100% of design.

- Digital keypad entry of setpoint to 0.1°F (0.1°C)
- Verify actual vs. setpoint temperature via alphanumeric display
- Remote reset of setpoint (up to 20°F (11.1°C) range) with a 1 to 11 second PWM signal (optional 4-20mA, 0-10 VDC or contact closure)

When automatic control is not desired, the input steam/hot water flow rate is also manually adjustable from the Control Center panel to any setting between minimum and maximum, provided steam/water input is not inhibited by a specific operating condition (e.g. safety).

## STEAM/HOT WATER LIMITING CONTROLS

- Manual limiting available from 10% to 100% of capacity
- Programmable pull down demand limiting to automatically limit steam/hot water source loading at start-up
- Remote limiting of steam/hot water input from 10% to 100% with a 1 to 11 second PWM signal

## SYSTEM CYCLING CONTROLS

- Programmable seven day time clock for automatic start/stop of chiller and chilled and condenser water pumps
- Separate schedule input strictly for holidays
- Remote cycling contacts available for other field supplied signals
- Multi-unit cycling contact input terminals for field supplied signals

## WARNING CONDITIONS / INHIBITED UNIT LOADING

The Control Center provides a warning annunciation and,  
JOHNSON CONTROLS

when beneficial to the machine, will limit heat input to 30% or 60% when operating conditions indicate the unit is moving towards a safety shutdown. This gives the operator the opportunity to fix a problem before it leads to a complete safety shutdown. Warnings include the following:

- Low refrigerant temperature
- High generator pressure
- High entering condenser water temperature
- Purge pump current overload
- Faulty solution dilution temperature sensor
- High inlet steam pressure
- High inlet hot water temperature
- High solution concentration

### SHUTDOWN CONTROLS

The following conditions will lead to unit shutdown. After a shutdown, the reason for the shutdown is displayed in English on the alphanumeric display. Each annunciation details the day, time, reason for shutdown and the type of restart required.

**Cycling** – Those controls which automatically reset and permit auto restart of the system.

- Loss of condenser water flow
- Low leaving chilled water temperature [2°F (1.1°C) below setpoint]
- Power failure (when automatic restart is selected)

**Safety** – Those controls which (when employed) require a manual operation to restart the system.

- Solution pump thermal or current overload
- Refrigerant pump thermal or current overload
- Low refrigerant temperature
- Generator high temperature or pressure
- Loss of chilled water flow
- Power failure (when automatic restart not used)
- High inlet steam temperature or pressure
- High inlet hot water temperature
- High solution concentration
- Incomplete dilution cycle due to any of the following:
  - Power failure
  - Solution/refrigerant pump overloads

- Low refrigerant temperature
- Loss of chilled water flow
- Auxiliary safety shutdown terminals for field supplied signals

### CONTROL MODE SELECTION

The Control Center includes secure program and servicing capabilities. There are three keys for the selection of the control center modes:

- ACCESS CODE permits access to the control center PROGRAM button when the proper password is given
- Program permits operator to program the setpoints and select desired MODE:
  - LOCAL allows manual unit start and purging.
  - REMOTE allows remote start and stop of the unit, remote reset of the chilled water temperature and steam limit, while still allowing manual purging at the chiller
  - SERVICE allows manual operation of the control valve, including LOAD, UNLOAD, HOLD, and AUTO keys. Manual operation of all pumps is also included

### ENERGY MANAGEMENT INTERFACE

By connecting with the YORK Integrated Systems Network, the Control Center can communicate all data accessible from the keypad (including all temperatures, pressures, alarms and operating data) to a remote DDC processor through a single shielded cable. In remote mode, the DDC processor may issue all operating commands available at the keypad to the control center through the same shielded cable. With a YORK MicroGateway, other BAS systems can receive this same information.

The Control Center also provides direct hard wire interface capability with other building automation systems. Remote chilled water temperature reset and/or remote steam/hot water input limit interface via a 1-11 second PWM standard signal (4-20mA, 0-10 VDC or contact closure optional). Remote unit start/stop and/or remote status including “unit ready to start,” “unit operating,” “unit safety shutdown,” and “unit cycling shutdown” interface via relay contacts.

# Mechanical Specifications

The mechanical features listed here apply to chillers sold in North America. Some of the features may differ on chillers delivered to other regions. Among those differences are the method of chiller shipment preparation and the types of piping interface.

The YORK YIA Absorption Liquid Chiller is completely factory-packaged, including upper and lower shell assemblies, solution heat exchanger, hermetic solution and refrigerant pumps, microprocessor controls and all interconnecting piping and wiring.

Models YIA-1A1 through YIA-10E3 are shipped as a one piece assembly, charged with nitrogen. Models YIA-12F1 through YIA-14F3 are shipped as two pieces (upper and lower shells), each charged with nitrogen, for field reassembly. The purge pump, chilled water flow switch, modulating control valve, and the lithium bromide charge are shipped loose for field installation or charging.

## SHELL ASSEMBLIES

The shell assemblies consist of a generator, condenser, evaporator and absorber housed in upper and lower shells. The shells are constructed of rolled carbon steel plate with fusion welded seams. Carbon steel tube sheets, drilled and reamed to accommodate the tubes, are welded to the end of the shells. Intermediate tube supports are fabricated of carbon steel plates. Each tube is roller expanded into the tube sheet to provide a leak tight seal and each tube is individually replaceable from either end of the unit.

The lower shell houses the low pressure section of the machine which includes the evaporator and the absorber. Both the evaporator and the absorber use 3/4" O.D. (19.1 mm), 0.028" (0.71 mm) wall, copper tubing. The evaporator tubes are externally enhanced, while the absorber tubes are prime surface. The evaporator shell is double-walled, enhancing unit reliability and eliminating the need for insulation. Spray nozzles in the absorber are either stainless steel (models 1A1 through GC4) or brass (models 7D1 through 14F3), while those in the evaporator are made of brass. The evaporator and absorber are separated by finned eliminator baffles designed to allow only water in the vapor state to pass to the absorber.

The upper shell contains the high pressure section of the machine, which includes the generator and the condenser. The generator uses 3/4" O.D. (19.1 mm), 0.035" (0.89 mm) wall, 90/10 cupro-nickel tubes with external enhancements. The condenser tubes are 3/4" (19.1 mm) or 1" (25.4 mm) O.D., .028" (0.71 mm) wall prime surface copper tubing. The condenser and generator are separated by a finned eliminator which prevents liquid carryover into the condenser.

Water boxes are fabricated of carbon steel. The design working pressure is 150 PSIG (1.0 MPa)[tested at 225 psig (1.5 MPa)]. Integral steel water baffles are located and welded within the water box to provide the required pass arrangements. Stub-out water nozzle connections with Victaulic grooves are welded to the water boxes; these nozzles are suitable for Victaulic coupling, welding or flanges, and are capped for shipment. Lifting lugs are provided on each water box, and plugged vent and drain connections are provided for each water box.

The Generator Water boxes for steam applications are designed for 150 PSIG (1.0 MPa) working pressure and are tested at 225 PSIG (1.5 MPa). The steam working pressure is limited to the specified design pressure, which, under no circumstances, is to exceed 14 PSIG (198 kPa) at the generator. The steam connections are 150 PSIG ANSI flanges. The Generator water boxes for hot water applications are designed for 300 PSIG (2.17 MPa) and tested at 450 PSIG (3.20 MPa). The hot water connections are stub-out water connections with Victaulic grooves.

## SOLUTION HEAT EXCHANGER

The solution heat exchanger is a shell and tube design with carbon steel tubing. The shell is formed from carbon steel plate with fusion welded seams. Tubes are roller-expanded into carbon steel tube sheets.

## PUMPS

Solution and refrigerant pumps are hermetically sealed, self-lubricating, totally enclosed, factory-mounted, wired and tested. Motor windings are not exposed to LiBr or water. The suction and discharge connections for each pump are fully welded to the unit piping to minimize the opportunity for leaks. Pumps are designed to operate for a total of 55,000 hours between service inspections.

These pumps feature self-adjusting spring loaded conical bearings that ensure concentric rotation and reduce interference. These bearings, made of carbon graphite, maintain correct bearing fit at all times and ensure extended trouble free operation. They provide greater resistance to wear than ordinary journal bearings.

## STABILIZER VALVE

A solenoid actuated valve sends refrigerant water into the solution heat exchanger circuit in order to combat any minor crystallization.

## UNLOADER VALVE

A solenoid actuated valve sends lithium bromide solution into the refrigerant circuit, allowing the unit to operate at condenser water temperatures as low as 45°F (7.2°C).



## SOLUTION AND REFRIGERANT

Each YIA unit is charged with lithium bromide solution with lithium chromate used as a corrosion inhibitor. The refrigerant is water. A small amount of 2-ethyl, hexanol is included as a heat and mass transfer enhancer. Lithium bromide charge ships to the job site directly from Johnson Controls' vendor.

## PURGE SYSTEM

The purge system continuously removes non-condensable gases from the unit and collects them in the absorber water cooled purge chamber. Gases are removed from the chamber through periodic operation of the electric-motor-driven vacuum pump.

## SIGHT GLASSES

YIA units have a total of three sight glasses. One glass is located on the left front of the unit and is used for monitoring the solution level in the absorber section. Two glasses are located on the evaporator tube sheet and are used to monitor and trim the refrigerant level.

## CAPACITY CONTROL

An electronically actuated control valve modulates chiller capacity from 100% to 10% of design. Valve selection is based upon pressure drop and steam/hot water flow requirements.

**Steam** – The valve is a cage type (for low steam mass flow) with a cast iron body or butterfly-type (high steam mass flow) with a carbon steel body. Cage valves are supplied with 125 psig ANSI raised face flanges. Butterfly valves are wafer-type valves and are supplied with 150 psig ANSI raised face flanges.

**Hot Water** – The valve is a 3-way diverting type. Valves are available in 125 psig, 250 psig, and 300 psig ratings. All valves are supplied with ANSI raised face flanges.

## POWER PANEL

The power panel enclosure includes the following: single point wiring connection for the incoming power supply; non-fused disconnect switch; motor starters, complete with current and thermal overload protection for the solution pump, refrigerant pump, and purge pump (current overloads only); 115VAC 50/60 Hz control power transformer.

## CONTROL CENTER

The microprocessor control center is factory mounted, wired and tested. The electronic panel automatically

controls the operation of the unit in meeting system cooling requirements while minimizing energy usage. Chiller operating parameters are sensed by either thermistors or transducers and displayed on the keypad display.

The operating program is stored in non-volatile memory (EPROM) to eliminate chiller failure due to AC power failure/battery discharge. In addition, programmed setpoints are retained in lithium battery-backed RTC memory for a minimum of 5 years.

All pressures are taken as absolute to alleviate typical gauge pressure inaccuracies. Temperatures and pressures can be displayed in English (F, PSIA) or metric (C, kPa) units depending on the application. Display of all information shown in the English language on a 40-character alphanumeric display.

Available operating information includes return/leaving chilled water temperatures, return/leaving tower water temperatures, entering steam or hot water temperature, entering steam pressure, generator pressure and temperature, refrigerant temperature, solution temperature and concentration, operating hours, valve position and number of starts and purges.

**Warning Conditions** – The Control Center limits heat input and provides a warning annunciation under the following conditions: low refrigerant temperature, high generator pressure, high entering condenser water temperature, purge pump current overload, faulty solution dilution temperature sensor, and high steam temperature or pressure or high hot water temperature. Special instrumentation measures the solution concentration and limits heat input as necessary to keep the unit from the crystallization region.

**Safety Controls** – The Control Center includes unique safety logic designed to protect the YIA chiller from damaging malfunctions. Complete safety annunciation is displayed for each shut-down by pressing the status key. This information includes day, time, reason for shutdown and type of restart required. These include: solution or refrigerant pump thermal or current overload, low refrigerant temperature, generator high pressure or temperature, loss of chilled water flow, power failure, high steam supply pressure or temperature, high hot water supply temperature, auxiliary safety shutdown, high solution concentration, incomplete dilution cycle, and power failure (if manual restart after power failure is selected).

**Operating Controls** – Background messages are displayed while the unit is running to signal operator of controlling conditions such as: steam limit in effect, leaving chilled water temperature control, and non-critical sensor

# Mechanical Specifications - continued

---

error. System cycling messages are displayed in regard to day, time, cause of cycling shutdown, and auto-start indication. These include loss of condenser water flow, low leaving chilled water temperature, and power failure (when auto-start is selected).

Digital programming of operating setpoints from the keypad include leaving chilled water temperature, pull down demand steam/hot water limiting, remote reset temperature range, daily start/stop scheduling of chiller and water pumps with separate holiday schedule.

Security access code is provided for operator to program setpoints or to choose local, remote, or service modes of operation. Manual operation of the steam valve and all pumps is provided through separate buttons in the service mode of operation.

**Data Logging** – All operating and setpoint information can be transmitted to a remote printer (by others) through the RS-232 port in the control center to obtain data logs. This can be accomplished at any time by pressing the “Print” button on the control center, or automatically at predetermined intervals by programming the panel’s data logger. The printer will automatically record time and cause of any safety or cycling shutdown along with all chiller operating data monitored by the panel just prior to shutdown. A “History Print” button also allows the printout of the last four causes of cycling or safety shutdowns plus operating data for each shutdown.

**BAS Interface** – The Control Center is compatible with remote Building Automation Systems (BAS). The standard design allows remote start and stop; leaving chilled water temperature reset and steam demand limit through PWM signal; and “ready to start”, “unit running”, “safety” and “cycling” shutdown status contacts. For designed-in features and reliability, Johnson Controls provides a full line of BAS controls.

## FACTORY TESTING

Each YIA unit is subjected to a series of rigorous leak tests, culminating in a vacuum leak test measured by a mass spectrometer and conducted while the unit is immersed in an atmosphere of low density helium. Water circuits are hydrostatically tested to 1-1/2 times the design working pressure.

## RUPTURE DISKS

In order to ensure compliance with ASHRAE Standard 15-2001, every chiller is furnished with a Stainless Steel Rupture Disk, installed and leak tested at the factory. Rupture disks are rated at  $7 \pm 2$  PIG and are installed on the Generator / Condenser shell.

## CODES AND STANDARDS

- ARI 560-2000
- ANSI/ASHRAE 15-2001
- ANSI/ASHRAE 90.1-2001
- NEC - National Electrical Code
- CE - (Only when specified)
- OSHA - Occupational Safety and Health
- PRESSURE VESSEL CODES (Only when specified)
  - applies to the generator tube circuit only
  - ASME Boiler and Pressure Vessel Code
  - TUV Pressure Vessel Code
  - ISPEL Pressure Vessel Code
  - PED (European Pressure Equipment Directive)

## PAINT

Exterior surfaces are protected by a single finish coat of Caribbean blue, air drying, high solids, enamel machinery paint.

## SHIPMENT

Protective covering is furnished on the microprocessor controls and other electric devices. Water nozzles are capped prior to shipment.



# Optional Features

## SPECIAL TUBE MATERIALS AND WALL THICKNESSES

YIA units are designed for long life with the standard tube materials and wall thicknesses in each heat exchanger. For special applications where different tube specifications are required, Johnson Controls offers copper tubing with .035" (0.89 mm) thicknesses. Also, 90/10 and 95/5 copper-nickel tubes are available for the absorber, evaporator, and condenser in both the standard and the above-listed optional tube wall thickness.

## WATER FLANGES

150 lb. (1.0 MPa) ANSI raised-faced flanges for the evaporator and/or absorber/condenser water connection as well as the generator connection are factory welded to water nozzles. Companion flanges, bolts, nuts and gaskets are not included.

## TOWER WATER FLOW SWITCH

This is a paddle-type, vapor-proof water flow switch suitable for 150 psig DWP (1.0 MPa) (300 DWP (2.1 MPa) available) for the absorber/condenser water circuit (chilled water flow switch is standard).

## REMOTE RESET CONTROLS

Two optional boards allow for continuous reset of either leaving chilled water temperature or remote steam/hot water limit using a 4 to 20mA, 0 to 10 VDC, or contact closure as opposed to the standard 1 to 11 second PWM signal. These signals may be wired directly to the panel terminal block on the card file without any external interfacing.

## KNOCK-DOWN SHIPMENT

The chiller can be shipped knocked down into two major sub-assemblies (generator and main shell) as required to rig into tight spaces. This is particularly convenient for existing buildings where equipment room access does not allow rigging a factory packaged chiller. Shipment in the knock-down configuration is standard on units YIA-12F1 through YIA-14F3.

## REFRIGERANT-SIDE INSULATION

Factory applied anti-sweat insulation of flexible closed cell plastic type can be applied with vapor proof cement to

the refrigerant outlet box as well as the refrigerant pump suction and discharge lines and portions of the evaporator shell that are subject to sweating.

## ISOLATION PADS

Four (4) pads of 3/8" (9 mm) thick Neoprene isolation material cemented between a 3/8" (9 mm) thick steel base plate and a 16 gauge steel cover sheet. The size is the same as the unit mounting feet (with the same mounting holes), and an approximate compressed height of 3/4" (19 mm).

## HIGH PRESSURE WATER CIRCUITS

For applications with working pressures which exceed 150 psig (1.0 MPa), high pressure water boxes with flanges are available. These compact water boxes are rated for 300 psig DWP (2.1 MPa) and tested at 450 psig (3.1 MPa).

## MARINE WATER BOXES

Marine water boxes allow service access for cleaning of the heat exchanger tubes without the need to break the water piping. Bolted-on covers are arranged for convenient access. Victaulic nozzle connections are standard; flanges are optional. Marine water boxes are available for the evaporator or absorber/condenser circuits. Marine water boxes are only available for circuits with 150 psig (1.0 MPa) working pressures.

## INDUSTRIAL GRADE PAINT

A factory-applied coating of industrial-strength Amerlock 400 epoxy primer and Amershield finish is applied to exterior chiller surfaces for harsh environments.

## WATERTIGHT ENCLOSURES AND WIRING

Chiller micropanel and power panel are enclosed in NEMA 4 rated enclosures for industrial applications. This option includes waterproofing of control and power connection wiring.

# Application Data

---

The following discussion is a guide for the application and installation of YIA Single-Effect Absorption Chillers to ensure reliable, trouble free life for which this equipment was designed.

## LOCATION

YIA units make very little noise or vibration and may generally be located at any level in a building where the construction will support the total system operating weight.

The system location should provide sufficient space at either end of the unit to permit tube or spray header removal, if required. If a door or other large opening is conveniently located opposite one end of the system, the tubes or spray headers may be extracted and replaced through these openings. Allow sufficient clearance on the remaining sides of the unit for necessary access and maintenance.

Absorption chillers are not suitable for outdoor installation. The machine room must be enclosed, well lighted and properly ventilated to keep its temperature no higher than 104°F (40°C) and no lower than 35°F (1.7°C).

## WATER CIRCUITS

**Flow Rate** – For normal water chilling duty, chilled and tower water flows are limited by velocity considerations. Under variable chilled water and tower water flow conditions, special attention needs to be paid to the rate of change of flow rate with time and the minimum/maximum velocities through the tubes. Applications involving chilled and condenser water flow rates which vary by more than  $\pm 10\%$  from design will require special consideration. Contact your Johnson Controls representative.

**Temperature Ranges** – For normal chilling duty, leaving chilled water temperatures may be selected as low as 40°F (4.4°C).

**Water Quality** – The practical and economical application of liquid chillers requires that the quality of the water supply for the evaporator and the absorber/condenser be analyzed by a water treatment specialist. Water quality may effect the performance of any chiller through corrosion, deposits of heat-resistant scale, sedimentation or organic growth. These will hurt chiller performance and increase operation and maintenance costs. Normally, performance may be maintained by corrective water treatment and periodic cleaning of tubes. If water conditions exist which cannot be corrected by proper water treatment, it may be necessary to provide a larger allowance for fouling, and/or specify special materials of construction.

**General Water Piping** – All chilled water and tower water piping should be designed and installed in accordance with accepted piping practice. Chilled water and tower water pumps should be located to discharge through the YIA unit to assure positive pressure and flow through the unit. Piping should include offsets to provide flexibility and should be arranged to prevent drainage of water from the cooler and condenser when the pumps are shut down. Piping should be adequately supported and braced independent of the chiller to avoid imposition of strain on chiller nozzles and components. Hangers must allow for alignment of the pipe. Isolators in the piping and in the hangers are highly desirable in achieving sound and vibration control.

**Convenience Considerations** – With a view to facilitating the performance of routine maintenance work, some or all of the following steps may be taken by the purchaser. Evaporator, absorber and condenser water boxes are equipped with plugged vent and drain connections. If desired, vent and drain valves may be installed with or without piping to an open drain. Pressure gauges with stop cocks, and stop valves, may be installed in the inlets and outlets of the tower and chilled water lines as close as possible to the chiller. An overhead monorail or beam hoist may be used to facilitate servicing.

**Connections** – The standard IsoFlow unit is designed for 150 psig (1.0 MPa) design working pressure in both the chilled and tower water circuits. The connections (water nozzles) to these circuits are furnished with grooves for Victaulic couplings (ANSI flanges are optional). Piping should be arranged for ease of disassembly at the unit for performance of routine maintenance such as tube cleaning. A contractor provided crossover pipe is necessary to route the tower water from the absorber up into the condenser. All water piping should be thoroughly cleaned of all dirt and debris before final connections are made to the YIA unit.

**Chilled Water** – The chilled water circuit should be designed for constant flow. A flow switch, provided standard with the unit, must be installed in the chilled water line of every unit. The switch must be located in the horizontal piping close to the unit, where the straight horizontal runs on each side of the flow switch are at least five pipe diameters in length. The field installed switch must be electrically connected to the chilled water interlock position in the unit control center. A water strainer, of maximum 1/8" (3.18 mm) mesh should be field-installed in the chilled water inlet line as close as possible to the chiller. If located close enough to the chiller, the chilled water pump may be protected by the same strainer. The

flow switch and strainer assure chilled water flow during unit operation. The loss or severe reduction of water flow could seriously impair the YIA unit performance or even result in tube freeze-up.

**Condenser Water** – Like the chilled water circuit, the tower water circuit requires a means of proving flow. The recommended method of proving flow is a tower water flow switch (not in standard supply scope, but available from Johnson Controls) installed in the tower water piping in the same manner as the chilled water flow switch

The YIA chiller is engineered for maximum efficiency at both design and part load operation by taking advantage of the colder cooling tower water temperatures which naturally occur in the winter months. For standard air conditioning applications, YIA absorbers can tolerate entering tower water temperatures as low as 45°F (7°C) without a cooling tower bypass. The YIA unit, by a system of internal controls which regulate the solution concentration, can operate continuously and automatically with entering cooling water temperature as low as 45°F (7°C). In order to safely accept such low cooling water temperatures, the YIA machine actually measures solution concentration leaving the generator. If the solution concentration is too high, the Control Center will begin to close the steam valve until the concentration reaches an acceptable level. Thus, the full load capacity of the machine may decrease as the temperature of the cooling water falls. In normal air conditioning applications, this is not significant because chilling load generally decreases with lower wet bulb temperature.

For process applications which have strict requirements for leaving chilled water temperatures, a three-way cooling tower bypass valve is recommended. The bypass valve should maintain entering cooling water temperature at  $\pm 2.5^\circ\text{F}$  (1.4°C) of the design temperature.

At the initial start-up, entering tower water temperature may be as low as 45°F (7°C).

## CONTROL VALVES

An automatic control valve is furnished with the unit by Johnson Controls for field mounting and wiring. The valve will be electrically actuated and will automatically close on unit shutdown. Cage steam valves are of a fail-close design and will close on a loss of power. Butterfly steam valves are not of a fail-close design and will not close on a loss of power. The valve should be located a distance of 4 to 10 feet (1.2 m to 3.0 m) from the absorption unit generator inlet flange.

Automatic control valves are sized according to job specific full load steam or hot water parameters. For applications with low steam mass flows, the cage valve provides the best control. However, at higher mass flow, the cage valve pressure drops are prohibitively high. Thus, a butterfly valve is used. Hot water valves are three-way diverting valves which bypass hot water that is not needed to maintain capacity.

## SOUND AND VIBRATION CONSIDERATIONS

Since the YIA unit generates very little vibration, vibration eliminating mounts are not required. However, when the machine is installed where even mild noise is a problem, pads can be used. The use of anchoring bolts on the machine legs is not normally necessary.

## STEAM AND CONDENSATE THEORY

### Saturation Temperature

The temperature at which a fluid changes from the liquid phase to the vapor phase, or conversely, from the vapor phase to the liquid phase is called the saturation temperature. A liquid at the saturation temperature is called a saturated liquid and a vapor at the saturation temperature is called a saturated vapor. It is important to recognize that the saturation temperature of the liquid (the temperature at which the liquid will vaporize) and the saturation temperature of the vapor (the temperature at which the vapor will condense) are the same for any given pressure.

For any given pressure, the saturation temperature is the maximum temperature the liquid can achieve and stay a liquid and the minimum temperature the vapor can achieve and stay a vapor. Any attempt to raise the temperature of a liquid above the saturation temperature will only result in vaporizing some part of the liquid. Similarly, any attempt to reduce the temperature of a vapor below the saturation temperature will only result in condensing some part of the vapor.

### Superheated Vapor

Vapor at any temperature above the saturation temperature corresponding to its pressure is referred to as superheated vapor. Once a liquid has been completely vaporized, the temperature of the resulting vapor can be further increased by adding energy. When the temperature of a vapor has been increased above the saturation temperature, the vapor is said to be superheated and the energy supplied to superheat the vapor is commonly referred to as superheat.

# Application Data - continued

Before a vapor can be superheated, the vapor must be removed from contact with the vaporizing liquid. Also, before a superheated vapor can be condensed it must first be cooled to the saturation temperature corresponding to its pressure.

## Subcooled Liquid

If, after condensation, the resulting liquid is cooled (constant pressure) so that its temperature is reduced below the saturation temperature, the liquid is said to be subcooled.

## The Effect of Pressure on Saturation Temperature

The saturation temperature of a fluid depends on the pressure of the fluid. Increasing the pressure raises the saturation temperature, while reducing the pressure lowers the saturation temperature.

## Condensation

Condensation of a vapor may be accomplished in several ways:

1. By extracting heat from the vapor
2. By increasing the pressure of the vapor.
3. By some combination of these two methods.

A good example of extracting heat from a vapor is in the generator section of the absorption chiller. Steam is fed to the generator through a steam modulating valve (Refer to steam valve operation for further details). As the steam flows through the generator tube bundle, heat is given up to the colder lithium bromide/water solution located on the outside of the tubes. This causes the solution to heat up and the steam to condense.

## Steam Supply

Dry steam (no water droplets) or slightly superheated steam should be supplied to the unit to maximize the heat content in the steam. The steam temperature and pressure must not exceed the maximum allowable as this may cause damage to system components.

The maximum steam temperature includes any superheat. Minimal superheat can be desirable to prevent condensation in supply lines, but excess superheat must be avoided. Superheated steam must be cooled to saturation temperature before useful heat transfer can occur in the absorption chiller generator. Steam supplied to an absorber should be kept close to dry saturated steam so valuable generator heat transfer area is not used for desuperheating steam.

## Steam Purity

Boiler water treatment is an essential part of any maintenance program. If the water is not properly treated, certain chemicals may exceed tolerable limits and damage the generator, control devices and adjoining piping. It is the customer's responsibility to test the condensate to make sure it is within certain limits. These limits are listed in the service manual.

If the steam carries entrained air or other gases, this will have a tendency to reduce the steam temperature. Air will also reduce the heat transfer properties of a unit because it migrates to heat transfer surfaces causing an insulating effect.

Carbon dioxide in steam is probably the most destructive form of contaminant.  $\text{CO}_2$  ( $\text{H}_2\text{CO}_3$ ) will dissolve in the condensate forming carbonic acid, which is extremely corrosive to pipes and system components.

## Enthalpy

For purposes of this engineering guide, the term enthalpy (h) is the energy content contained in a certain quantity of steam or other substance. The term specific enthalpy (h) refers to the heat contained in 1 lb. (kg) of steam at certain thermodynamic conditions.

To determine the total heat content contained in a quantity of steam multiply the specific enthalpy by the mass of the steam.

To determine the approximate heat input to the YIA unit the following equation should be used.

$$\text{Input (Btu/hr or W/hr)} = (h_1 - h_2) \times m$$

Where:

- $h_1$  = enthalpy of steam entering the unit (saturated vapor)
- $h_2$  = enthalpy of condensate leaving the unit (subcooled liquid)
- $m$  = mass flow rate of steam (lb./hr or kg/hr)

$h_1$  can be determined by reading the pressure at the Steam Inlet Pressure Indicator. Then refer to steam tables to find the enthalpy of the saturated vapor at this pressure. This value assumes that dry steam is entering the unit.

Refer to subcooled liquid tables to determine enthalpy of the condensate leaving the unit. Both temperature and pressure must be measured to determine this value.



## Steam Information

Latent heat is the quantity of energy that must be removed to condense steam from a saturated vapor to a saturated liquid (at a constant pressure). Any additional heat removed will subcool the liquid. The same energy is needed to vaporize steam from a saturated liquid to saturated vapor. Any additional heat added will only superheat the steam.

## Steam Quality

Steam quality is simply a mass percentage of saturated vapor to the total mass that is contained in a saturated steam sample. This percentage of vapor is referred to as the steam quality (X). A quality of 0.80 means that 80% of the saturated steam is in the vapor phase while 20% is in the liquid phase. The term dry steam that is often seen is equivalent to saturated steam with a quality of 1.0 (100% vapor). It is important to note that as the quality decreases, the heat content of the steam also decreases.

Table 1 below lists two enthalpy values; saturated liquid enthalpy and the saturated vapor enthalpy. As discussed above, steam with a quality less than one (1) will have a certain percentage of liquid and vapor present in the steam. The saturated vapor enthalpy assumes dry steam, quality:  $X = 1$ . The saturated liquid enthalpy assumes pure water, quality:  $X = 0$ . The enthalpy of saturated water is much less than saturated steam. It follows that as the quality decreases, the enthalpy decreases from the saturated vapor value to the saturated liquid value. Since enthalpy is an indication of the heat in the steam, available heat is reduced if liquid water is contained in the steam.

## System Design

The use of low pressure steam as a heat source for single effect absorption chillers is the most common application. Steam is utilized by the absorption unit at 14 psig (97 kPa) or lower. It can be used from a low pressure boiler, a waste steam source, or reduced from a high pressure boiler or district steam supply (approximately 18.3 lb. (8.3 kg) of steam per hour per ton of refrigeration).

The YIA Single-Effect Absorption Chiller is designed for a maximum pressure into the steam valve of 16 psig (110 kPa G), with a maximum steam temperature of 337°F (169°C).

The Control Center incorporates a steam demand limiting control which allows the user to slowly increase steam demand in a linear fashion for a time period up to 255 minutes (see "Controls" section). When steam demand limiting is not employed, start-up steam demand is appreciably higher than the normal full load steam rate. Unrestricted start-up demand is dependent upon the full load pressure drop through the valve. If full load design is based upon a relatively high pressure drop through the valve, the increases in steam demand on start-up will not be nearly as much as if the design steam valve pressure drop is low. For a 3 psi (21 kPa) design steam valve pressure drop, one can expect about a 50% increase in steam demand on start-up. If the design were based on a 4 psi (28 kPa) steam valve pressure drop, the increase in start-up demand would be around 35% above normal. Likewise, a 2 psi (14 kPa) design pressure drop would give a start-up steam demand about 75% above normal.

TABLE 1 – ENTHALPY VALUES

Temp °F	Pressure mm Hg. Abs.	Specific Vol. (ft <sup>3</sup> / lbm)		Enthalpy (Btu/lbm)			
		PSIA	Liquid	Vapor	Liquid	Vapor	Latent heat
340	6098.76	117.93	0.0179	3.79	311.30	1190.80	879.50
345	6528.23	126.23	0.0179	3.57	316.55	1191.95	875.40
350	6957.23	134.53	0.0180	3.35	321.80	1193.10	871.30
360	7908.27	152.92	0.0181	2.96	332.35	1195.20	862.85

# Application Data - continued

## Piping Installation

All steam field piping should be installed in accordance with local, state and federal codes. Piping should be adequately supported and braced independent of the chiller. The support system must account for the expansion and contraction of the steam piping, avoiding the imposition of strain on chiller components.

A general steam piping diagram is laid out in Fig. 4 below. The steam supply may be either low pressure steam or high pressure steam reduced to low pressure steam. Steam piping should be designed in accordance with good engineering practice.

Both steam supply and condensate pipes must be properly sized and pitched to prevent liquid hammering. Steam supply mains should be sized in accordance with the required steam flow and acceptable pressure drop. Wherever possible, the steam supply line to the absorption unit should be taken off the main steam supply line from the top or side to minimize the possibility of condensate carry-over. Additional consideration should be given to steam flow velocity, especially in those applications where noise is a factor. Generally speaking, steam velocities up to 6,000 fpm (30 m/s) will not produce an objectionable noise level.

The factory supplied steam control valve must be installed 4 to 10 feet (1.2 m to 3.0 m) from the generator steam inlet flange in order to minimize the pressure drop from the valve exit to the generator inlet.

## Component Details

Component details described in the following section are shown in Fig. 4, "Typical Steam Piping."

**Manual Block Valve** – This valve is installed to allow manual shut off of the steam supply to the unit.

**Desuperheater** – A desuperheater must be used when the steam supply has a temperature in excess of 337°F (169°C). When encountered, this condition is generally associated with the high pressure steam supply or steam that has been reduced to 16 psig (110 kPaG) for use in the absorber. The steam supply to the control valve must be cooled to or below 337°F (169°C) total temperature by means of some type of desuperheater. The flow of coolant to the desuperheater should be automatically controlled to maintain a constant steam supply temperature to the absorption unit within the limits specified. Suitable automatic means should be provided to remove any condensate which may accumulate. A stop valve should be provided ahead of the desuperheater to facilitate maintenance. Test thermometer wells should be provided in the steam inlet and outlet from the desuperheater to check its operation.

**Steam Strainer** – The steam strainer is used to capture any impurities in the steam supply. These impurities may manifest themselves in the form of dirt, rust or precipitates. This strainer will prevent chiller system components from getting plugged. Plugged components will reduce system capacity and increase maintenance costs. A pressure gauge must be installed before and after the steam

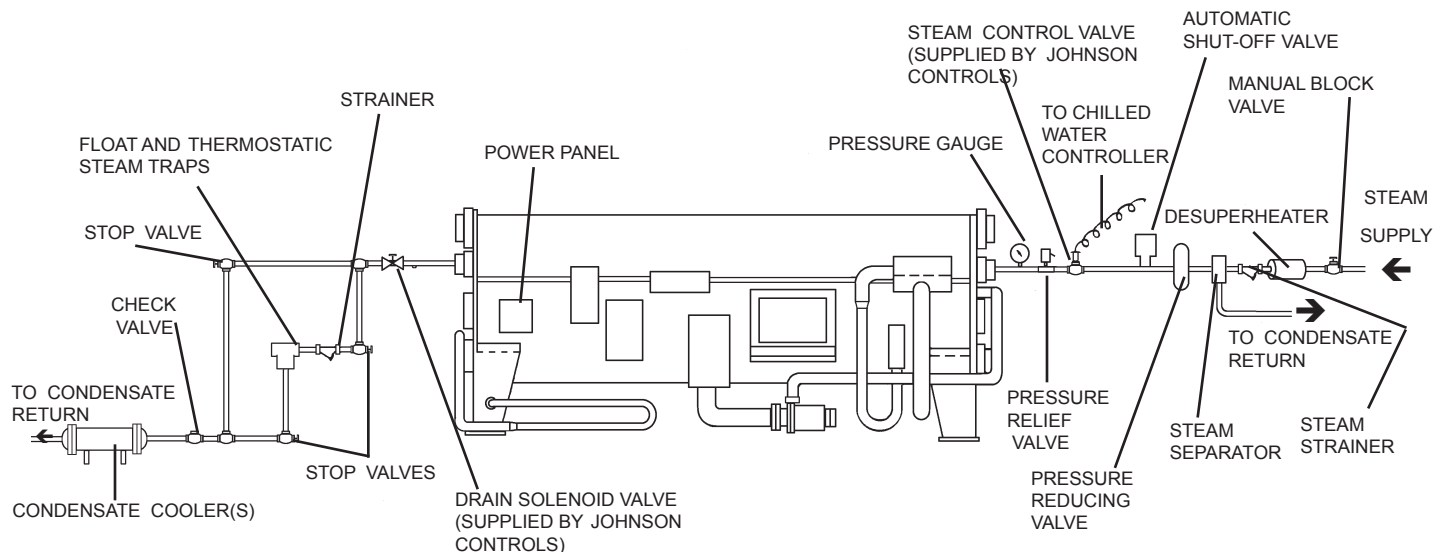

FIG. 4 – TYPICAL STEAM PIPING



strainer. If the pressure drop as read from these two gauges increases to an unacceptable level, the strainer should be removed and cleaned.

**Steam Separator** – The steam separator is installed in the steam supply line and is used to separate any liquid present in the steam. This condensate liquid would normally be piped through a steam trap back to the condensate tank. The steam trap will prevent any steam from blowing through the separator into the condensate return system. The use of a steam separator and trap will allow dry steam to enter the unit at all times.

The system requirement is to have dry steam into the generator of the absorption chiller. If dry steam can be supplied without the use of a steam separator then it is not necessary to install one.

In cases where the chiller is located close to the boiler or is supplied with superheat, the steam reaching the chiller may already be dry. However, since any liquid present in the steam entering the chiller will reduce the heat input, it is important to include a steam separator unless it is truly not necessary.

**Pressure Reducing Valve** – A pressure reducing valve must be used if the steam pressure to the chiller is greater than 16 psig (110 kPaG). For applications where the steam supply pressure is known to fluctuate, it is recommended that a steam pressure regulating valve be used.

When needed, a steam pressure reducing valve suitable for dead-end service must be provided in the steam supply piping ahead of the steam control valve. This pressure reducing valve should be sized on the basis of the pressure drop and absorption unit full load steam flow requirements, not on the basis of steam supply pipe size (which can result in an oversized valve). The pressure reducing valve should be provided with stop valves on both inlet and outlet and a full size bypass with a globe valve to permit manual operation during maintenance.

Two pressure reducing valves, one large and one small, piped in parallel may be desirable for those applications with continued operation at low loads or where highly variable upstream pressures exist. The smaller valve would be set at a slightly higher pressure than the large valve so it will stay open at low flow rates while the large valve closes, thus protecting the seat of the larger valve.

The use of two steps of steam pressure reduction may be desirable on applications with pressure differentials in excess of 100 psi (690 kPa). The noise generated in a single step of reduction may be objectionable.

**Automatic Shut-Off Valve** – This valve should shut-off 100% of the steam flow during a cycling/safety shutdown or a power failure. The Johnson Controls supplied steam control valve will remain in whatever position it happened to be in at the time of a power failure. A valve that will completely shut-off steam flow to the unit during such a failure is required. This steam valve should be bubble tight.

**Pressure Relief Valve** – A 15 psig (103 kPaG) pressure relief valve should be installed to protect the steam generator vessel. The vessel must be protected from pressures above 15 psig (103 kPaG).

To prevent nuisance blowing of the relief valve, it should be set 2 or 3 psi (14 to 21 kPa) above the generator operating pressure and within code requirements. The relief valve should be sized for maximum steam flow and vented in accordance with local codes. A relief valve is not required if there is a properly sized relief valve elsewhere in the system, which will keep the system below 15 psig (103 kPaG).

**Steam Control Valve (Johnson Controls Supplied)** – The steam control valve as found in the ship-loose-items, should be installed as shown in Fig. 4. This valve should be connected to the appropriate wiring harness and is used to control the amount of steam that enters the unit. It will modulate from 10% to 100% depending on the leaving chilled water temperature. The minimum value of 10% is set in the field. This is explained in detail in the installation manual.

**Steam Inlet Pressure Indicator (If Desired)** – A pressure gauge can be installed to allow the operator to determine the inlet steam pressure to the unit. The inlet steam pressure is indicated by the micropanel, but an additional pressure gauge may be desired.

**Drain Solenoid Valve (Johnson Controls Supplied)** – Factory supplied device used to insure zero steam flow through the unit during shut down. This valve should be installed in a horizontal run of pipe within 2 feet (0.6 m) of the chiller condensate outlet. This valve is not supplied when a fail-close steam control valve is used. This valve is needed in addition to the Automatic Shut-Off Valve.

**Vacuum Breaker (If Desired)** – A vacuum breaker will often not be necessary, but they can prevent condensate build up in the generator section of the chiller at part load. A discussion of the chillers operation and the function of the vacuum breaker follows:

# Application Data - continued

If an atmospheric return system is used, the generator will not operate in the vacuum region, but will operate at atmospheric pressure at the low load conditions. Throttling of the steam valve at low load results in steam condensate back-up into the generator tubes. As the load increases, the steam valve will open and the rising steam pressure will force the condensate out of the generator. The accumulation of condensate in the generator at reduced loads and subsequent drainage will have no adverse effect on absorption unit efficiency. However, the cyclical drainage of condensate from the unit will require that the main system condensate receiver be sized with sufficient additional capacity to accommodate this fluctuation (assumed to be equal to the absorption unit generator volume as a maximum -see Table 2 on page 22).

To avoid fluctuation in condensate return or water hammer in the generator tubes, a vacuum breaker swing check valve can be added as shown in Fig. 5 on page 24. A 3/8-inch size is sufficient to prevent condensate build-up. For safety, a pipe should be installed from the check valve to a location close to the floor or other safe place. The use of the check valve to permit air entrance into the generator tubes has the disadvantage that this air must later be purged through the thermostatic element of the float trap and tends to entrain air in the condensate return.

**Strainer(s)** – A fine mesh strainer with blow-off valve should be provided ahead of the steam trap(s) to protect it from damage.

**Float and Thermostatic Steam Trap(s)** – Fig. 4 shows a typical condensate steam trap piping arrangement as used on an absorption unit. The trap serves the purpose of passing condensate, but preventing the loss of steam. A float and thermostatic steam trap is recommended for this application. It should be applied in accordance with the manufacturer's recommendations. The trap should be located as close to the generator condensate outlet as possible in the horizontal plane. In the vertical plane, the trap should be located below the generator condensate outlet, a minimum of 12 inches (0.3 m). Preferably, the maximum possible elevation between the generator outlet and the trap should be used.

The condensate outlet line should be sized in accordance with good engineering practice for condensate at the flash point and should be kept as short and simple as possible. Stop valves should be provided ahead of the strainer and after the trap for necessary maintenance; and a full size bypass provided with globe valve for manual operation during maintenance. A full trap outlet line size connection and valve should be provided for blow-off and test purposes.

The steam trap should be selected for about 1.5 times the design full steam flow rate, at the design operating pressure differential. The operating full load pressure differential:  $PD = SP - P_1 - P_2 - P_3$   
where:

PD = Trap pressure drop, psi.

SP = Steam pressure, psig, at generator flange normally 3 psi less than the design pressure to the control valve.

$P_1$  = Condensate line pressure drop losses, psi.

$P_2$  = Check valve pressure drop loss, psi.

$P_3$  = Condensate cooler pressure drop loss, psi.

Select float capacity from manufacturer's ratings per above recommendations.

The line from the steam trap to the condensate receiver will contain some flash vapor flowing with the condensate. This line should be as short as possible, preferably not more than 30 feet (9 m) in equivalent length. As a general rule, it should be sized according to the number of traps used and one or more sizes larger in the case of longer piping runs.

**Check Valve** – A check valve should be provided in the trap outlet line to prevent any possible air or condensate leakage back to the generator under reduced load operating conditions.

**Condensate Cooler** – The use of a condensate cooler between the trap and the condensate receiver to cool the condensate below its flash is required for vacuum return systems and may be desirable, though not required, for atmospheric return systems.

The variations in condensate flow must be recognized and the cooler selected to cool the maximum flow of condensate 5-10°F (3-6°C) below the saturation temperature of the lowest pressure in the system (atmospheric pressure for an atmospheric return or the lowest pressure in a vacuum return system). Sufficient coolant must be provided to cool the maximum condensate flow to the desired temperature. Coolers may be air or evaporatively cooled, providing they can produce the desired leaving condensate temperature. The flow of coolant should be automatically controlled to provide the desired leaving condensate temperature. Coolant flow could be manually set for maximum load and allowed to operate continuously at that level with no operating difficulties, but the poor economics of such an arrangement make automatic control preferable.

TABLE 2 – YIA CHILLER SHELL AND TUBE VOLUMES

YIA MODEL	SHELL SIDE				TUBE SIDE							
	GEN/COND		ABS/EVAP		ABSORBER		EVAPORATOR		GENERATOR		CONDENSER	
	US Gallons	Liters	US Gallons	Liters	US Gallons	Liters	US Gallons	Liters	US Gallons	Liters	US Gallons	Liters
1A1	175	662	543	2055	45	170	32	121	14	53	16	61
1A2	211	799	653	2472	52	197	36	136	16	61	18	68
2A3	249	943	764	2892	58	220	40	151	17	64	25	95
2A4	277	1049	875	3312	64	242	45	170	19	72	28	106
2B1	361	1366	1006	3808	81	307	55	208	23	87	28	106
3B2	405	1533	1152	4361	90	341	61	231	25	95	40	151
3B3	456	1726	1298	4913	99	375	67	254	28	106	44	167
4B4	508	1923	1444	5466	108	409	73	276	30	114	48	182
4C1	587	2222	1516	5739	130	492	88	333	37	140	49	185
5C2	646	2445	1701	6439	143	541	96	363	41	155	68	257
5C3	719	2722	1899	7188	156	591	105	397	44	167	75	284
6C4	810	3066	2136	8085	171	647	115	435	49	185	82	310
7D1	904	3422	2690	10182	193	731	134	507	56	212	91	344
7D2	1004	3800	2992	11326	210	795	146	553	61	231	100	379
8D3	1130	4277	3371	12760	232	878	160	606	66	250	110	416
8E1	1264	4785	3756	14218	278	1052	192	727	82	310	141	534
9E2	1423	5386	4230	16012	306	1158	211	799	90	341	156	591
10E3	1582	5988	4705	17810	334	1264	230	871	97	367	171	647
12F1	1911	7234	5137	19445	395	1495	269	1018	124	469	204	772
13F2	2125	8044	5730	21690	431	1631	293	1109	135	511	223	844
14F3	2340	8858	6311	23889	467	1768	315	1192	145	549	242	916

# Application Data - continued

**Auxiliary Condensate Receiver** – An auxiliary condensate receiver must be used if the main condensate receiver is located a great distance from the chiller or above the chiller. An auxiliary condensate pump is used to send condensate from the auxiliary receiver to the main condensate receiver.

The auxiliary condensate receiver should be located at floor level as close to the absorption unit as possible. A check valve in the auxiliary condensate pump discharge line is recommended where condensate backflow may occur.

Auxiliary condensate receivers with condensate pumps are available as a package. They include a float or other control to cycle the pump to suit the condensate flow. Manufacturers' recommendations concerning selection and application of these packages should be followed.

## Condensate Return Systems

Steam condensate return systems should be designed in accordance with good engineering practice for the general purpose of removing condensate from the absorption unit's generator and returning it to the boiler. Either an atmospheric or a vacuum condensate return system may be used with absorption units, as discussed earlier in this section.

A general understanding of the YORK single-effect absorption unit operating requirements and characteristics is necessary before discussing the condensate return systems. The absorption chiller will operate at full load steam pressures in the 9-12 psig (62 to 88 kPa) range, down to pressures well into the vacuum region at part load. As the cooling load decreases, the chilled water controller will start closing the steam control valve, reducing both steam flow and steam pressure to the generator. At some part load point, say 75% for illustration, the steam pressure will be 0 psig, or atmospheric. With further reduction in load, the steam valve will continue to close, resulting in generator steam pressures below atmospheric pressure (providing a vacuum condensate return system is used). If an atmospheric return system is used or if a vacuum breaker is installed at the outlet of the chiller then the generator pressure will not drop below atmospheric. The use of a vacuum breaker is discussed on page 21.

Three basic types of return systems are possible: (1) a completely atmospheric system; (2) a system that allows the chiller and steam traps to function at atmospheric pressure, but the remainder of the condensate system/boiler feed to operate in a vacuum; (3) and a system that

operates entirely in a vacuum. Reference Figs. 5, 6, and 7 for typical diagrams.

**System (1)** – For an entirely atmospheric system, a vacuum breaker may be installed at the outlet of the chiller (see page 21). Also in this system both the auxiliary condensate receiver (if needed) and the main condensate receiver must be vented to atmospheric pressure. The auxiliary condensate receiver should be used on completely atmospheric systems when the main condensate receiver is located at some distance from the condensate outlet or above the condensate outlet. This system requires a float controlled pump to move condensate from the auxiliary receiver to the main condensate receiver in addition to the main condensate pump/boiler feed pump.

**System (2)** – Since the condensate will be at atmospheric pressure until it leaves the auxiliary condensate receiver, a vacuum breaker can still be used if desired (see previous paragraph). The auxiliary condensate receiver must be used in this system. The main condensate tank will no longer be vented to atmospheric pressure. A float control is still used in the auxiliary condensate receiver, however, it controls a valve instead of a pump. The low pressure, in the main tank, will draw the condensate through when the valve is opened.

For system (2), a condensate cooler must be provided in the line between the steam trap and the auxiliary receiver, as detailed under **condensate cooler** in the component details section. It must be sized to cool the maximum flow to a temperature 5-10°F (3-6°C) below the saturation point of the vacuum return system.

**System (3)** – When the low pressure steam for a YIA unit comes at or below atmospheric pressure (i.e. steam turbine exhaust), the entire system can run at a higher efficiency by using a vacuum pump on the condensate return system. At low load, when the absorption system is operating in the vacuum region, this vacuum can only be obtained if the condensate return system similarly operates in a vacuum. With a vacuum condensate return system, the steam supply can be at vacuum steam pressure, rather than at a minimum steam pressure of 0 pounds gauge (as it is limited by systems (1) and (2)). Discharging at a steam pressure in the vacuum region can improve a steam turbine's economy and efficiency.

In this system a vacuum breaker can not be used.

A condensate cooler must be provided in the line between the steam trap and the auxiliary receiver, as detailed under **condensate cooler** in the component details section. It

must be sized to cool the maximum flow to temperature 5-10°F (3-6°C) below the saturation point of the vacuum return system.

**HOT WATER SUPPLY**

A hot water supply of 266°F (130°C) will provide sufficient heat to achieve nominal ratings. Lower hot water

temperatures may not achieve the nominal capacity for a given size. Your local Johnson Controls office can provide ratings for specific hot water temperatures. A sample hot water piping arrangement is shown in Fig. 8 below. Johnson Controls recommends that shut-off valves be installed in the hot water supply and return piping for serviceability. On hot water unit shutdown, the water in the generator

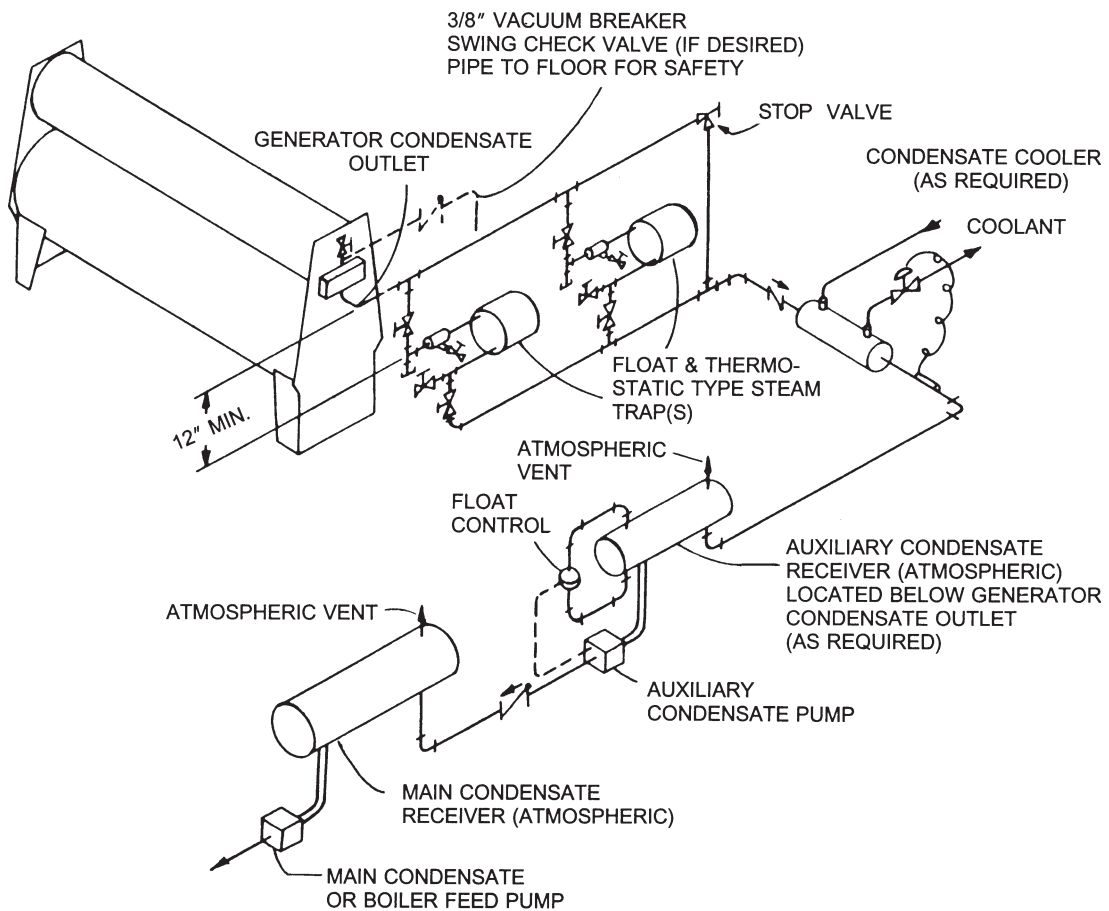

**FIG. 5 – SYSTEM 1: ATMOSPHERIC CONDENSATE RETURN SYSTEM**

# Application Data - continued

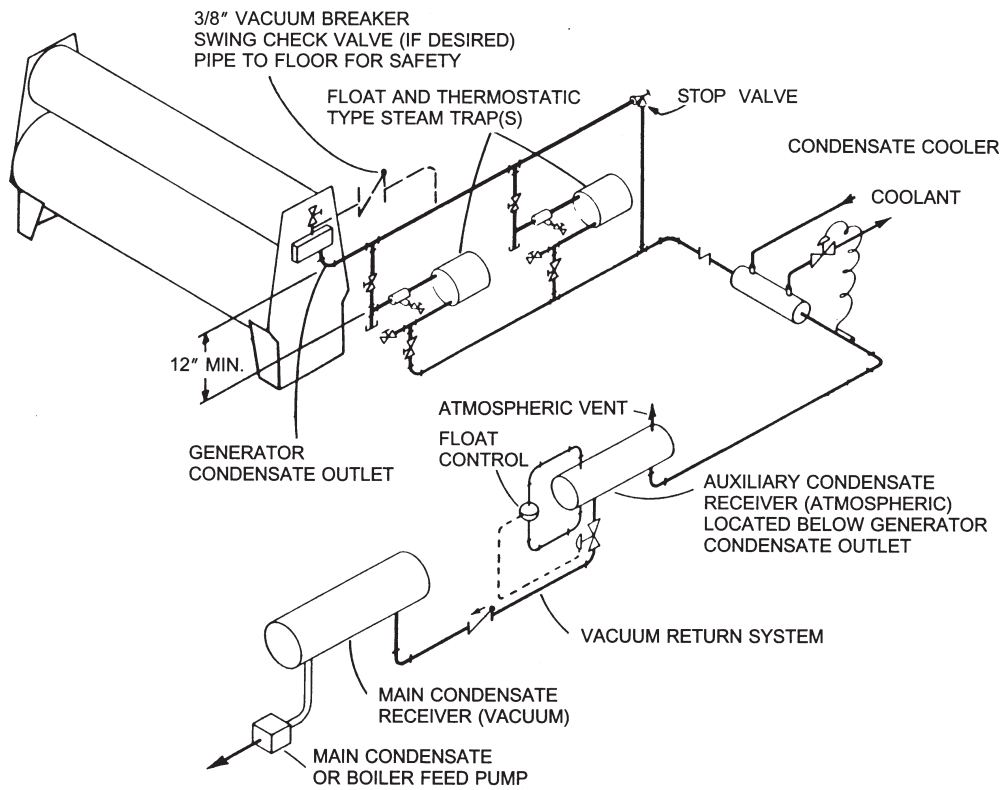

FIG. 6 – SYSTEM 2: VACUUM CONDENSATE RETURN SYSTEM

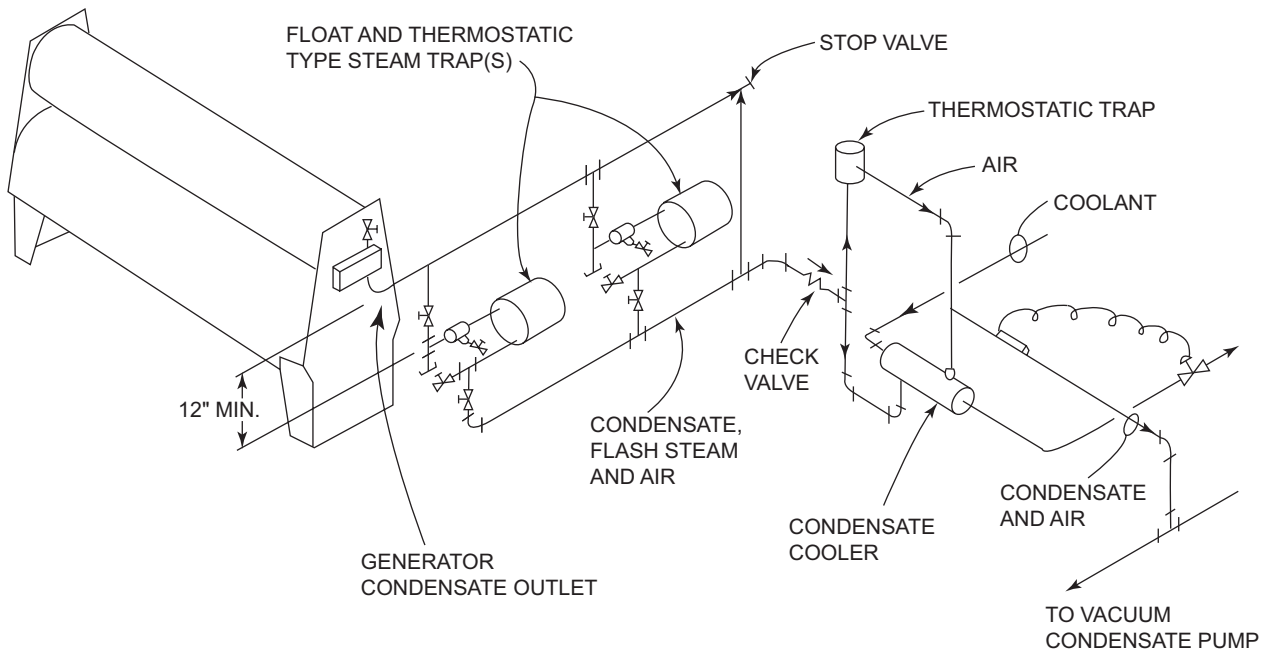

FIG. 7 – SYSTEM 3: VACUUM CONDENSATE RETURN SYSTEM.



contracts as it cools. This may form a vacuum. This can be prevented by installing a check valve in the return hot water piping with a 3/4" (19.1 mm) bypass around the check valve. It would be piped between the generator outlet and the hot water bypass. Refer to the Figure 8, below.

**INSULATION**

No appreciable operation economy can be gained from the insulation of YORK YIA chillers. However, insulation

may be desirable to prevent sweating of cold surfaces or to prevent overheating of the mechanical equipment room due to heat gains from the high temperature surfaces of the unit. Tables 3 and 4 below give the heat loss and ventilation requirements for a 10°F ambient temperature rise for the various YIA units and further reduces the risk of crystallization. Tables 4 and 5 on page 28 provide approximate insulation areas.

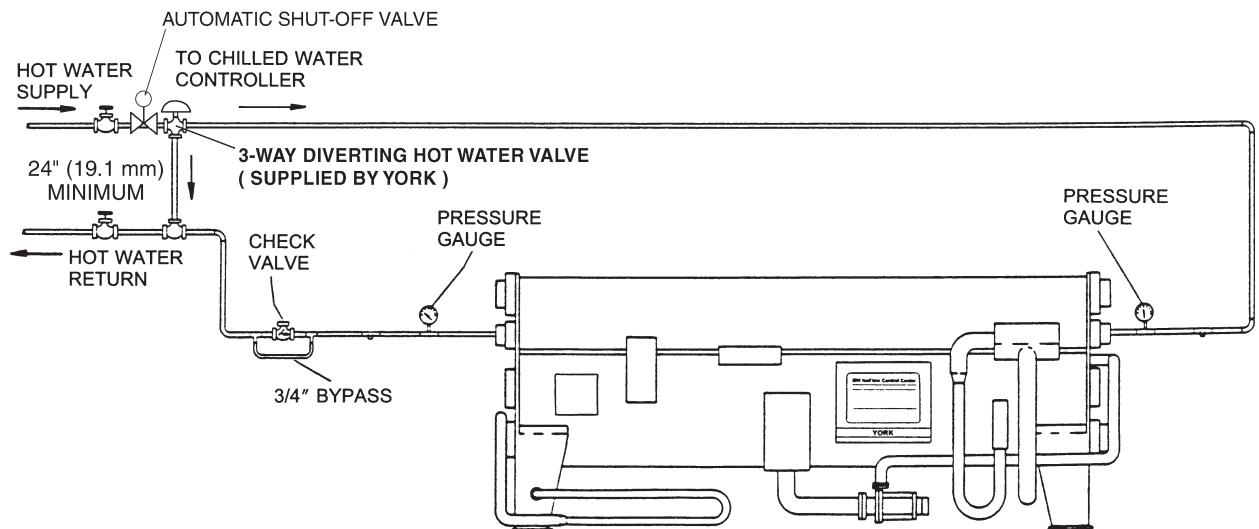

**FIG. 8 – TYPICAL HOT WATER PIPING**

# Application Data - continued

**TABLE 3 – GENERATOR HEAT LOSS (ENGLISH)**

MODEL YIA	HEAT LOSS - BTUH	VENTILATION - CFM
1A1	7,500	750
1A2	7,500	750
2A3	8,800	880
2A4	10,000	1,000
2B1	11,000	1,100
3B2	12,500	1,250
3B3	14,000	1,400
4B4	16,000	1,600
4C1	18,000	1,800
5C2	20,000	2,000
5C3	22,000	2,200
6C4	25,000	2,500
7D1	28,000	2,800
7D2	32,000	3,200
8D3	36,000	3,600
8E1	42,000	4,200
9E2	46,000	4,600
10E3	51,000	5,100
12F1	58,000	5,800
13F2	66,000	6,600
14F3	72,000	7,200

**TABLE 4 – GENERATOR HEAT LOSS (METRIC)**

MODEL YIA	HEAT LOSS - KW	VENTILATION - L/S
1A1	2.2	354
1A2	2.2	415
2A3	2.6	472
2A4	2.9	519
2B1	3.2	590
3B2	3.7	661
3B3	4.1	850
4B4	4.7	661
4C1	5.3	850
5C2	5.9	944
5C3	6.4	1038
6C4	7.3	1180
7D1	8.2	1321
7D2	9.4	1510
8D3	10.6	1699
8E1	12.3	1982
9E2	13.5	2171
10E3	14.9	2407
12F1	17.0	2737
13F2	19.3	3115
14F3	21.1	3398

**TABLE 5 – APPROXIMATE INSULATION FOR HOT AND COLD SURFACES – ENGLISH MEASURE**

MODEL YIA	COLD SURFACES			HOT SURFACES		MODEL YIA	COLD SURFACES			HOT SURFACES	
	EVAP. HEADS & END SHEETS SQ. FT.	REFRIG OUTLET BOX & PUMP SQ. FT.	SUCTION & DISCHARGE LINES – TUBULAR INSUL DIA. INCH/LIN FT.	UPPER SHELL SQ. FT.	GEN. HEADS SQ. FT.		EVAP. HEADS & END SHEETS SQ. FT.	REFRIG. OUTLET BOX & PUMP SQ. FT.	SUCTION & DISCHARGE LINES – TUBULAR DIA. INCH/LIN FT.	UPPER SHELL SQ. FT.	GEN. HEADS SQ. FT.
1A1	16	16	2/11, 4/4	70	2	6C4	26	18	2-1/2 / 14, 3/4, 4/6	185	4
1A2	16	16	2/12, 4/3	70	2	7D1	39	31	3/17, 4/6	180	7
2A3	16	16	2/12, 4/3	81	2	7D2	39	31	3/18, 4/6	200	7
2A4	16	16	2/13, 4/3	93	2	8D3	39	31	3/19, 4/6	225	7
2B1	19	17	2/9, 2-1/2 / 4, 4/4	95	3	8E1	55	43	3/22, 4/8	225	8
3B2	19	17	2/10, 2-1/2 / 4, 4/4	110	3	9E2	55	43	3/24, 4/8	255	8
3B3	19	17	2/11, 2-1/2 / 4, 4/4	125	3	10E3	55	43	3/24	285	8
4B4	19	18	2/12, 2-1/2 / 4, 4/4	136	3	12F1	67	44	3/21	290	10
4C1	26	18	2-1/2 / 11, 3/4, 4/6	132	4	13F2	67	44	3/23	320	10
5C2	26	18	2/12, 3/4, 4/6	148	4	14F3	67	44	3/24	355	10
5C3	26	18	2-1/2 / 13, 3/4, 4/6	165	4						

**TABLE 6 – APPROXIMATE INSULATION FOR HOT AND COLD SURFACES – METRIC MEASURE**

MODEL YIA	COLD SURFACES			HOT SURFACES		MODEL YIA	COLD SURFACES			HOT SURFACES	
	EVAP. HEADS & END SHEETS m <sup>2</sup>	REFRIG OUTLET BOX & PUMP m <sup>2</sup>	SUCTION & DISCHARGE LINES – TUBULAR INSUL DIA. CM/LIN. m	UPPER SHELL m <sup>2</sup>	GEN. HEADS m <sup>2</sup>		EVAP. HEADS & END SHEETS m <sup>2</sup>	REFRIG. OUTLET BOX & PUMP m <sup>2</sup>	SUCTION & DISCHARGE LINES – TUBULAR DIA. CM/LIN. m	UPPER SHELL m <sup>2</sup>	GEN. HEADS m <sup>2</sup>
1A1	1.5	1.5	5/3.4, 10/1.2	6.5	0.2	6C4	2.4	1.7	6.5/4.3, 7.5/1.2, 10/1.8	17.1	0.4
1A2	1.5	1.5	5/3.7, 10/0.9	6.5	0.2	7D1	3.6	2.9	7.5/5.2, 10/1.8	16.7	0.7
2A3	1.5	1.5	5/3.7, 10/0.9	7.5	0.2	7D2	3.6	2.9	7.5/5.5, 10/1.8	18.6	0.7
2A4	1.5	1.5	5/4.0, 10/0.9	8.6	0.2	8D3	3.6	2.9	7.5/5.8, 10/1.8	21.0	0.7
2B1	1.8	1.6	5/2.7, 6.5/1.2, 10/1.2	8.8	0.3	8E1	5.1	4.0	7.5/6.7, 10/2.4	21.0	0.7
3B2	1.8	1.6	5/3.0, 6.5/1.2, 10/1.2	10.2	0.3	9E2	5.1	4.0	7.5/7.3, 10/2.4	21.0	0.7
3B3	1.8	1.6	5/3.4, 6.5/1.2, 10/1.2	11.6	0.3	10E3	5.1	4.0	7.5/7.3	26.5	0.7
4B4	1.8	1.7	5/3.7, 6.5/1.2, 10/1.2	12.6	0.3	12F1	6.2	4.1	7.5/6.4	27.0	0.9
4C1	2.4	1.7	6.5/3.4, 7.5/1.2, 10/1.8	12.2	0.4	13F2	6.2	4.1	7.5/7.0	29.8	0.9
5C2	2.4	1.7	5/3.7, 7.5/1.2, 10/1.8	13.7	0.4	14F3	6.2	4.1	7.5/7.3	33.0	0.9
5C3	2.4	1.7	6.5/4.0, 7.5/1.2, 10/1.8	15.3	0.4						

# Ratings

TABLE 7 – NOMINAL RATINGS, STEAM MACHINES – ENGLISH

MODEL	CAPA- CITY (TONS)	CON- SUMP- TION (LBS/HR)	EVAPORATOR					ABSORBER/CONDENSER				
			INLET (°F)	OUTLET (°F)	FLOW (GPM)	# OF PASS	PRESS. DROP (FT)	INLET (°F)	OUTLET (°F)	FLOW (GPM)	# OF PASS	PRESS. DROP (FT)
1A1	120	2200	54	44	288	3	13	85	101.4	432	3	16
1A2	155	2840	54	44	372	3	24	85	101.4	558	3	28
2A3	172	3140	54	44	413	2	12	85	101.4	620	2	13
2A4	205	3760	54	44	492	2	17	85	101.4	740	2	20
2B1	235	4300	54	44	564	2	12	85	101.4	846	2	19
3B2	273	4960	54	44	656	2	17	85	101.4	980	2	19
3B3	311	5650	54	44	747	2	23	85	101.4	1120	2	27
4B4	334	6120	54	44	802	2	29	85	101.4	1200	1	14
4C1	363	6650	54	44	872	2	14	85	101.4	1308	2	21
5C2	410	7500	54	44	984	2	18	85	101.4	1475	2	20
5C3	446	8200	54	44	1071	2	25	85	101.4	1600	1	12
6C4	518	9500	54	44	1244	2	35	85	101.4	1870	1	17
7D1	565	10,300	54	44	1356	2	21	85	101.4	2030	2	22
7D2	617	11,300	54	44	1481	2	24	85	101.4	2220	1	11
8D3	704	12,800	54	44	1690	2	36	85	101.4	2530	1	15
8E1	794	14,600	54	44	1906	2	26	85	101.4	2860	1	9
9E2	908	16,600	54	44	2180	2	36	85	101.4	3270	1	12
10E3	960	17,600	54	44	2304	1	8	85	101.4	3450	1	16
12F1	1148	21,000	54	44	2756	2	35	85	101.4	4140	1	12
13F2	1235	22,600	54	44	2964	1	7	85	101.4	4450	1	16
14F3	1377	25,200	54	44	3305	1	10	85	101.4	4960	1	22

**NOTES:**

1. All IsoFlow Chillers are rated according to ARI 560-2000. Ratings in Tables above represent unit performance at nominal conditions. For full and part load conditions at specific conditions, contact your local Johnson Controls office.

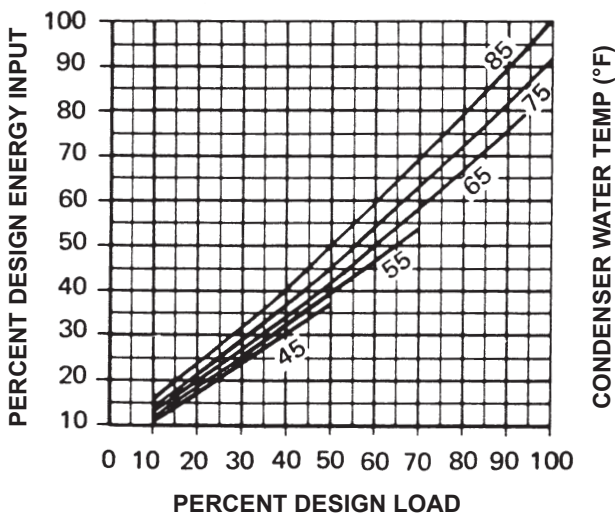

FIG. 9 – TYPICAL PART LOAD ENERGY CONSUMPTION – STANDARD UNIT

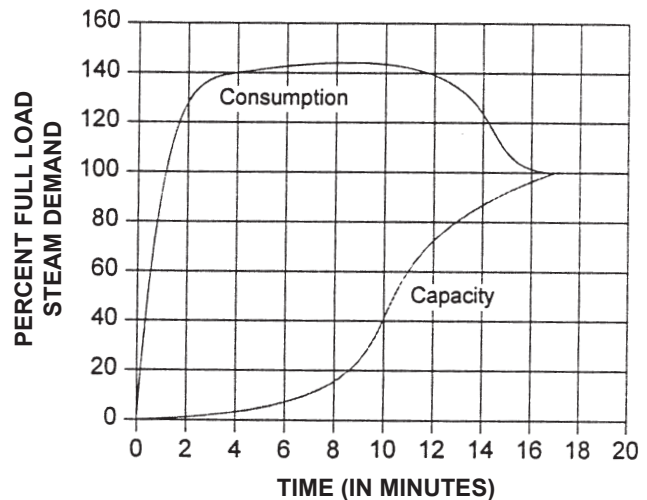

FIG. 10 — TYPICAL CHILLER START-UP PERFORMANCE (Based on NO LOAD LIMITING at startup)

TABLE 8 – NOMINAL RATINGS, STEAM MACHINES – METRIC

MODEL YIA-ST	CAPA- CITY (KW)	CON- SUMP- TION (KG/H)	EVAPORATOR					ABSORBER/CONDENSER				
			INLET (°C)	OUTLET (°C)	FLOW (GPM)	# OF PASS	PRESS. DROP (K/PA)	INLET (°C)	OUTLET (°C)	FLOW (L/S)	# OF PASS	PRESS. DROP (K/PA)
1A1	420	999	12.2	6.7	18.2	3	39	29.4	38.6	27.2	3	48
1A2	545	1290	12.2	6.7	23.5	3	72	29.4	38.6	35.2	3	84
2A3	605	1425	12.2	6.7	26.0	2	36	29.4	38.6	39.1	2	39
2A4	721	1705	12.2	6.7	31.0	2	51	29.4	38.6	46.7	2	60
2B1	826	1950	12.2	6.7	35.6	2	36	29.4	38.6	53.3	2	57
3B2	960	2250	12.2	6.7	41.4	2	51	29.4	38.6	61.8	2	57
3B3	1094	2560	12.2	6.7	47.1	2	69	29.4	38.6	70.6	2	81
4B4	1174	2780	12.2	6.7	50.6	2	87	29.4	38.6	75.7	1	42
4C1	1276	3020	12.2	6.7	55.0	2	42	29.4	38.6	82.5	2	63
5C2	1442	3400	12.2	6.7	62.0	2	54	29.4	38.6	93.0	2	60
5C3	1568	3725	12.2	6.7	67.5	2	75	29.4	38.6	100.9	1	36
6C4	1821	4310	12.2	6.7	78.4	2	105	29.4	38.6	117.9	1	51
7D1	1987	4680	12.2	6.7	85.5	2	63	29.4	38.6	128.0	2	66
7D2	2170	5130	12.2	6.7	93.4	2	72	29.4	38.6	140.0	1	33
8D3	2475	5810	12.2	6.7	106.6	2	108	29.4	38.6	159.5	1	45
8E1	2792	6630	12.2	6.7	120.2	2	78	29.4	38.6	180.3	1	27
9E2	3193	7530	12.2	6.7	137.5	2	108	29.4	38.6	206.2	1	36
10E3	3376	7990	12.2	6.7	145.3	1	24	29.4	38.6	217.5	1	48
12F1	4037	9530	12.2	6.7	173.8	2	105	29.4	38.6	261.1	1	36
13F2	4343	10260	12.2	6.7	186.9	1	21	29.4	38.6	280.6	1	48
14F3	4842	11440	12.2	6.7	208.4	1	30	29.4	38.6	312.8	1	66

## NOTES:

1. All IsoFlow Chillers are rated according to ARI 560-2000. Ratings in Tables above represent unit performance at nominal conditions. For full and part load conditions at specific conditions, contact your local Johnson Controls office.

# Ratings - continued

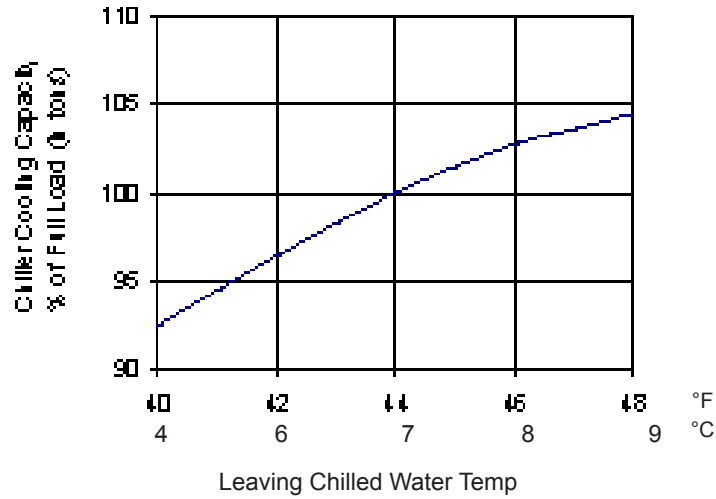

FIG. 11 – TYPICAL CHILLER COOLING CAPACITY FOR REQUIRED LCHWT

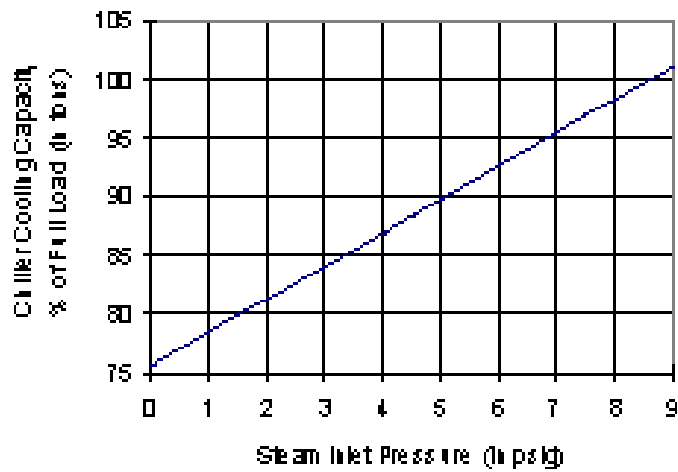

FIG. 12 – TYPICAL CHILLER COOLING CAPACITY FOR AVAILABLE STEAM INLET PRESSURE

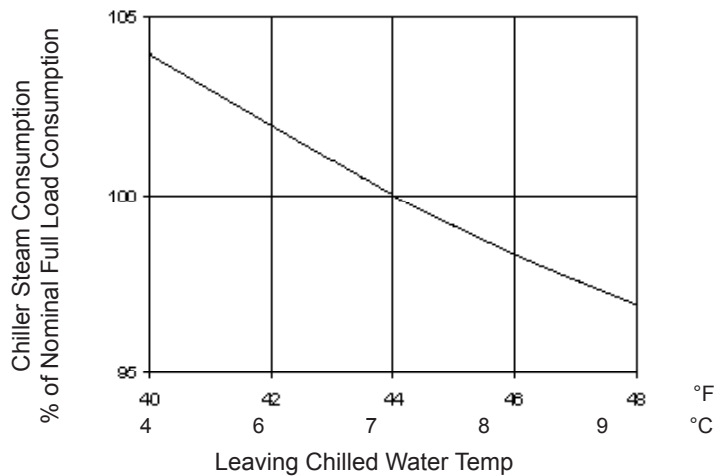

FIG. 13 – TYPICAL CHILLER STEAM CONSUMPTION FOR LCHWT



**Example COP Calculation**

COP for an absorption chiller is calculated with the following equation:

$$\text{COP} = \frac{Q_{\text{output}}}{Q_{\text{input}}} = \frac{\text{Capacity (tons)} \cdot 12,000 \text{ (Btuh / ton)}}{\text{Mass Flow} \cdot \text{Enthalpy}}$$

The example chiller has the following operating conditions:

- Capacity 1025 tons
- ECHWT/LCHWT 50°F / 40°F
- ECWT/LCWT 85°F / 97.4°F
- Steam Pressure 2.5 psig (dry saturated)
- Steam Flow Rate 18806.8 lbs./hr.
- Standard fouling in all circuits

From the steam tables, 2.5 psig (17.2 PSIA) is:

- Steam Temperature 219.5°F
- Enthalpy of Condensate 180.5 Btu/lb.
- Enthalpy of Steam 1150.6 Btu/lb.
- Difference 970.1 Btu/lb.

$$\text{COP} = \frac{1025 \text{ tons} \cdot 12,000 \text{ (Btuh / ton)}}{18806.8 \text{ lbs./hr.} \cdot 970.1 \text{ Btu/lb.}} = 0.67$$

**INTEGRATED PART LOAD VALUE (IPLV)**

In the English I-P system, IPLV is calculated by the following formula:

$$\text{IPLV or APLV} = \frac{1}{\frac{0.01}{A} + \frac{0.42}{B} + \frac{0.45}{C} + \frac{0.12}{D}}$$

- Where: A = Kw / ton at 100% Load
- B = Kw / ton at 75% Load
- C = Kw / ton at 50% Load
- D = Kw / ton at 25% Load

In SI Metric, the formula is:

$$\text{IPLV or APLV} = 0.01A + 0.42B + 0.45C + 0.12D$$

- Where: A = COP at 100% Load
- B = COP at 75% Load
- C = COP at 50% Load
- D = COP at 25% Load

**TABLE 9 – IPLV ANALYSIS**

LOAD %	ENTERING CONDENSER WATER TEMP (°F)	COP	WEIGHTING FACTOR (FROM ARI 560-92)	WEIGHTED AVERAGE COP
100	85.00	0.69	0.01	0.007
75	78.75	0.74	0.42	0.311
50	72.50	0.86	0.45	0.387
25	68.00	0.77	0.12	0.093

IPLV (expressed as a COP) = 0.798

**TABLE 10 – FOULING FACTOR**

ENGLISH I-P (ft <sup>2</sup> °F hr/Btu)	EQUIVALENT SI METRIC (m <sup>2</sup> °C/W)
0.00025	0.000044
0.0005	0.000088
0.00075	0.000132

# Nozzle Arrangements

---

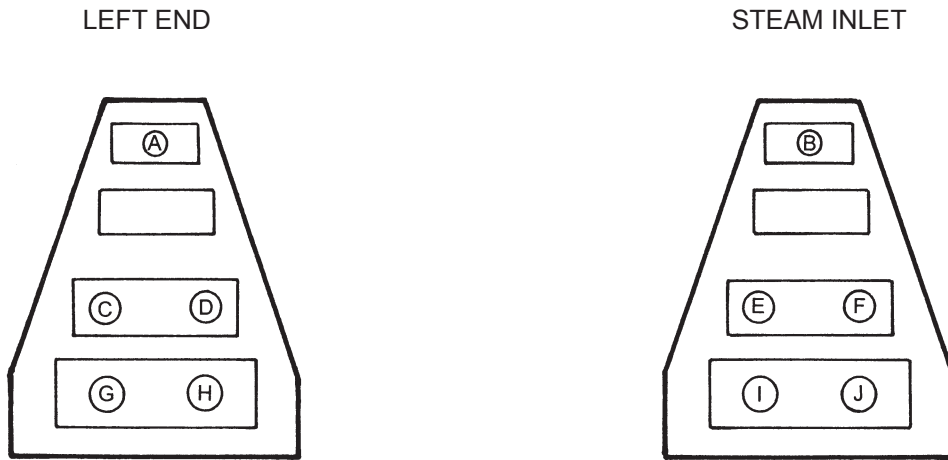

FIG. 14 – STEAM CHILLER NOZZLE ARRANGEMENTS

---

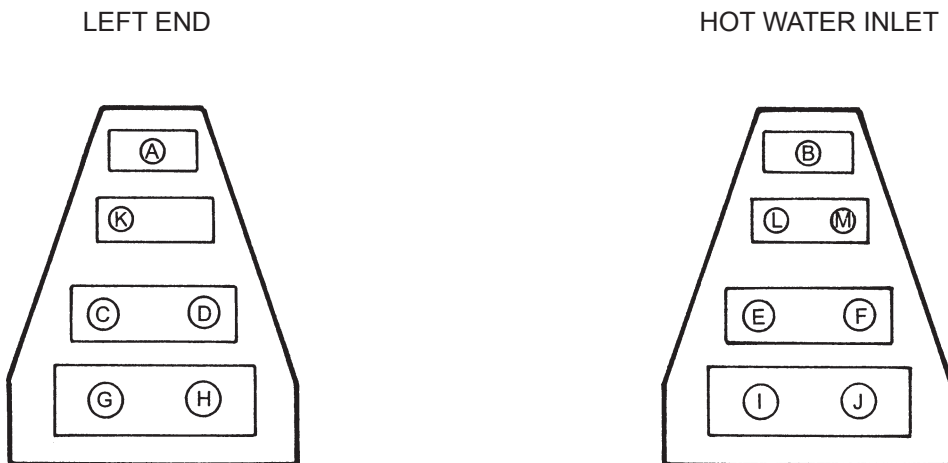

FIG. 15 – HOT WATER CHILLER NOZZLE ARRANGEMENTS

**TABLE 11 – EVAPORATOR PASS ARRANGEMENTS**

NUMBER PASSES	NOZZLE ARRANGEMENT	IN	OUT
1,3	E1	C	E
	E2	D	F
	E3	E	C
	E4	F	D
2,4	E5	C	D
	E6	D	C
	E7	E	F
	E8	F	E

**NOTES:**

1. Marine Waterboxes are available on E2, E4, E7, & E8 only.
2. 4 Pass Evaporators are not available on "F" family of chillers.

**TABLE 12 – ABSORBER/CONDENSER ARRANGEMENTS**

NUMBER OF ABSORBER PASSES	NOZZLE ARRANGEMENT	ABSORBER		CONDENSER	
		IN	OUT	IN	OUT
1,3	AC1	G	I	B	A
	AC2	I	G	A	B
	AC3	H	J	B	A
	AC4	J	H	A	B
2	AC5	G	H	A	B
	AC6	H	G	A	B
	AC7	I	J	B	A
	AC8	J	I	B	A

**NOTES:**

1. Three pass Absorber not available on "E" & "F" family chillers.
2. Marine Waterboxes not available for 1 Pass Absorber in "A" family chillers.

**TABLE 13 – HOT WATER GENERATOR NOZZLE ARRANGEMENTS**

NUMBER PASSES	NOZZLE ARRANGEMENT	IN	OUT
1	HW1	L	K
2	HW2	L	M
3	HW3	L	K

# Physical Data

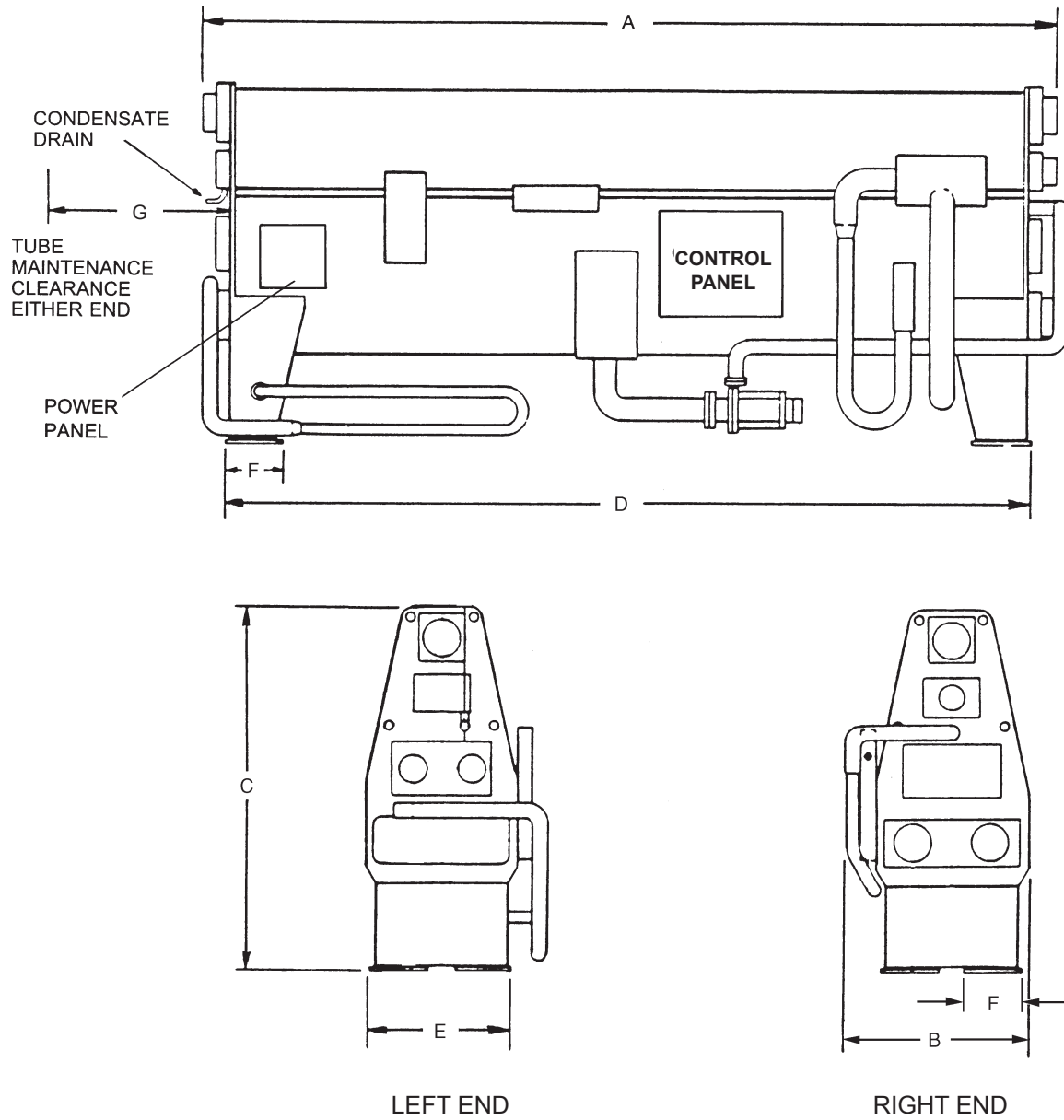

LD00688(R)

FIG. 16 – UNIT DIMENSIONS

## DIMENSIONS (ENGLISH MEASURE)

UNIT MODEL "YIA"	MAXIMUM OVERALL DIM.			BASE			TUBE PULL
	A	B	C	D	E	F	G
1A1	12'-2-1/2"	5'-6-1/4"	7'-7-1/4"	10'-0"	3'-2"	0'-8"	10'-8"
1A2	14'-2-1/2"	4'-5"	7'-7-1/4"	12'-0"	3'-2"	0'-8"	12'-8"
2A3	16'-2-1/2"	4'-5"	7'-7-1/4"	14'-0"	3'-2"	0'-8"	14'-8"
2A4	18'-2-1/2"	4'-5"	7'-7-1/4"	16'-0"	3'-2"	0'-8"	16'-8"
2B1	16'-2-1/2"	4'-11"	8'-7-3/4"	14'-0"	3'-7"	0'-10"	14'-8"
3B2	18'-2-1/2"	4'-11"	8'-7-3/4"	16'-0"	3'-7"	0'-10"	16'-8"
3B3	20'-2-1/2"	4'-11"	8'-7-3/4"	18'-0"	3'-7"	0'-10"	18'-8"
4B4	22'-2-1/2"	4'-11"	8'-7-3/4"	20'-0"	3'-7"	0'-10"	20'-8"
4C1	18'-2-1/2"	5'-5"	9'-10-3/4"	16'-0"	4'-2"	1'-0"	16'-8"
5C2	20'-2-1/2"	5'-5"	9'-10-3/4"	18'-0"	4'-2"	1'-0"	18'-8"
5C3	22'-2-1/2"	5'-5"	9'-10-3/4"	20'-0"	4'-2"	1'-0"	20'-8"
6C4	24'-8-1/2"	5'-5"	9'-10-3/4"	22'-6"	4'-2"	1'-0"	23'-2"
7D1	20'-2-1/2"	6'-6-1/4"	11'-7-1/4"	18'-0"	5'-2"	1'-2"	18'-8"
7D2	22'-2-1/2"	6'-6-1/4"	11'-7-1/4"	20'-0"	5'-2"	1'-2"	20'-8"
8D3	24'-8-1/2"	6'-6-1/4"	11'-7-1/4"	22'-6"	5'-2"	1'-2"	23'-2"
8E1	22'-6-1/4"	7'-2-1/4"	12'-7"	20'-0"	5'-10-1/2"	1'-4"	20'-8"
9E2	25'-0-1/4"	7'-2-1/4"	12'-7"	22'-6"	5'-10-1/2"	1'-4"	23'-2"
10E3	27'-6-1/4"	7'-2-1/4"	12'-7"	25'-0"	5'-10-1/2"	1'-4"	25'-8"
12F1	25'-0-1/4"	7'-10-1/4"	13'-10-1/2"	22'-6"	6'-4"	1'-6"	23'-2"
13F2	27'-6-1/4"	7'-10-1/4"	13'-10-1/2"	25'-0"	6'-4"	1'-6"	25'-8"
14F3	30'-6-1/4"	7'-10-1/4"	13'-10-1/2"	27'-6"	6'-4"	1'-6"	28'-2"

UNIT MODEL "YIA"	OPERATING WEIGHT LBS.	SHIPPING WEIGHT LBS.	RIGGING WEIGHT LBS.	SOLUTION WEIGHT LBS.	REFRIG. WEIGHT LBS.	WATER WEIGHT LBS.
1A1	11,424	8900	8700	1501	167	856
1A2	12,808	9800	9700	1782	250	976
2A3	14,120	10,800	10,600	1916	284	1,120
2A4	15,583	11,700	11,500	2318	317	1,248
2B1	17,896	13,400	13,300	2600	400	1,496
3B2	19,963	14,800	14,600	3002	434	1,728
3B3	21,857	16,200	16,000	3270	484	1,904
4B4	23,891	17,600	17,400	3685	534	2,072
4C1	25,185	18,500	18,200	3819	434	2,432
5C2	27,962	20,200	19,900	4502	475	2,784
5C3	30,300	21,800	21,500	4918	542	3,040
6C4	33,080	23,500	23,200	5601	642	3,336
7D1	38,827	28,700	28,400	5601	734	3,792
7D2	43,446	32,200	31,900	6285	826	4,136
8D3	48,138	35,700	35,400	6968	926	4,544
8E1	54,223	39,000	38,600	8603	1,076	5,544
9E2	60,976	43,400	43,000	10,238	1,235	6,104
10E3	67,210	48,500	48,100	10,653	1,401	6,656
12F1	76,675	55,100	44,400	12,288	1,351	7,936
13F2	83,646	59,700	48,100	13,789	1,502	8,656
14F3	90,030	63,700	50,600	15,276	1,702	9,352

**NOTES:**

- Units in "F" family are rigged in two pieces, as a standard.
- Operating weight = shipping weight + Weight of refrigerant and solution + weight of chilled, tower and hot water in the tubes.

# Physical Data - continued

## DIMENSIONS (METRIC MEASURE)

UNIT MODEL "YIA"	MAXIMUM OVERALL DIM.			BASE			TUBE PULL
	A	B	C	D	E	F	G
1A1	3740	1680	2340	3050	970	205	3250
1A2	4350	1350	2340	3660	970	205	3860
2A3	4,960	1350	2340	4,270	970	205	4470
2A4	5,570	1350	2340	4,880	970	205	5080
2B1	4,960	1500	2650	4,270	1100	255	4470
3B2	5,570	1500	2650	4,880	1100	255	5080
3B3	6,180	1500	2650	5,490	1100	255	5690
4B4	6,790	1500	2650	6,100	1100	255	6300
4C1	5,570	1660	3030	4,880	1270	305	5080
5C2	6,180	1660	3030	5,490	1270	305	5690
5C3	6,790	1660	3030	6,100	1270	305	6300
6C4	7,550	1660	3030	6,860	1270	305	7060
7D1	6,180	1990	3560	5,490	1580	360	5690
7D2	6,790	1990	3560	6,100	1580	360	6300
8D3	7,550	1990	3560	6,860	1580	360	7060
8E1	6,890	2190	3,840	6,100	1800	410	6300
9E2	7,650	2,190	3,840	6,860	1800	410	7060
10E3	8,410	2,190	3,840	7,620	1800	410	7830
12F1	7,650	2,400	4,250	6,860	1930	460	7060
13F2	8,410	2,400	4,250	7,620	1930	460	7830
14F3	9,310	2,400	4,250	8,390	1930	460	8590

UNIT MODEL "YIA"	OPERATING WEIGHT KGS.	SHIPPING WEIGHT KGS.	RIGGING WEIGHT KGS.	SOLUTION WEIGHT KGS.	REFRIG. WEIGHT KGS.	WATER WEIGHT KGS.
1A1	5182	4037	3946	681	76	388
1A2	5810	4445	4400	808	113	443
2A3	6,405	4899	4808	869	129	508
2A4	7,068	5307	5216	1,051	144	566
2B1	8,117	6078	6033	1,179	181	679
3B2	9,055	6713	6622	1,362	197	784
3B3	9,914	7348	7257	1,483	220	864
4B4	10,837	7983	7893	1,671	242	940
4C1	11,424	8391	8255	1,732	197	1103
5C2	12,683	9163	9026	2,042	215	1263
5C3	13,744	9888	9752	2,231	246	1379
6C4	15,005	10659	10523	2,541	291	1513
7D1	17,612	13018	12882	2,541	333	1720
7D2	19,707	14606	14470	2,851	375	1876
8D3	21,835	16193	16057	3,161	420	2061
8E1	24,595	17690	17,509	3,902	488	2515
9E2	27,658	19,686	19,504	4,644	560	2769
10E3	30,486	21,999	21,818	4,832	635	3019
12F1	34,779	24,993	20,140	5,574	613	3600
13F2	37,941	27,079	21,818	6,255	681	3926
14F3	40,837	28,894	22,952	6,929	772	4242

### NOTES:

- Units in "F" family are rigged in two pieces, as a standard.
- Operating weight = shipping weight + Weight of refrigerant and solution + weight of chilled, tower and hot water in the tubes.



**TABLE 14 – ELECTRICAL RATINGS**

Chiller Model	Voltage (Volts-Ph-Hz)	Solution Pump		Refrigerant Pump		Purge Pump		Minimum Circuit Ampacity	Disconnect Switch (Customer supplied)	Max-Dual Elem. Fuse (Customer supplied)	Total KW
		FLA	LRA	FLA	LRA	FLA	LRA				
1A1	200/208-3-60	12.5	51	12.5	51	2.1	14.2	35.2	60	45	5.9
	230-3-60	12	55	12	55	2.2	12.8	33.5	60	45	5.9
	380-3-50	6.5	23	6.5	23	1.1	5.4	18.3	30	20	5.9
	400-3-50	6.3	25	6.3	24.5	1.1	5.1	17.7	30	20	5.9
	460-3-60	6	28	6	27.5	1.1	6.2	16.8	30	20	5.9
	575-3-60	4.9	24	4.9	24	1	4.9	13.7	30	15	5.9
1A2	200/208-3-60	12.5	51	12.5	51	2.1	14.2	35.2	60	45	5.9
	230-3-60	12	55	12	55	2.2	12.8	33.5	60	45	5.9
	380-3-50	6.5	23	6.5	23	1.1	5.4	18.3	30	20	5.9
	400-3-50	6.3	25	6.3	24.5	1.1	5.1	17.7	30	20	5.9
	460-3-60	6	28	6	27.5	1.1	6.2	16.8	30	20	5.9
	575-3-60	4.9	24	4.9	24	1	4.9	13.7	30	15	5.9
2A3	200/208-3-60	12.5	51	12.5	51	2.1	14.2	35.2	60	45	5.9
	230-3-60	12	55	12	55	2.2	12.8	33.5	60	45	5.9
	380-3-50	6.5	23	6.5	23	1.1	5.4	18.3	30	20	5.9
	400-3-50	6	25	6.3	24.5	1.1	5.1	17.7	30	20	5.9
	460-3-60	6	28	6	27.5	1.1	6.2	16.8	30	20	5.9
	575-3-60	5	24	4.9	24	1	4.9	13.7	30	15	5.9
2A4	200/208-3-60	13	51	12.5	51	2.1	14.2	35.2	60	45	5.9
	230-3-60	12	55	12	55	2.2	11.2	33.5	60	45	5.9
	380-3-50	7	23	6.5	23	1.1	5.4	18.3	30	20	5.9
	400-3-50	6.3	24.5	6.3	24.5	1.1	5.1	17.7	30	20	5.9
	460-3-60	6	27.5	6	27.5	1.1	6.2	16.8	30	20	5.9
	575-3-60	4.9	24	4.9	24	1	4.9	13.7	30	15	5.9
2B1	200/208-3-60	12.5	51	12.5	51	2.1	14.2	35.2	60	45	5.9
	230-3-60	12	55	12	55	2.2	12.8	33.5	60	45	5.9
	380-3-50	6.5	23	6.5	23	1.1	5.4	18.3	30	20	5.9
	400-3-50	6.3	24.5	6.3	24.5	1.1	5.1	17.7	30	20	5.9
	460-3-60	6	27.5	6	27.5	1.1	6.2	16.8	30	20	5.9
	575-3-60	4.9	24	4.9	24	1	4.9	13.7	30	15	5.9
3B2	200/208-3-60	20	78	12.5	51	2.1	14.2	44.6	60	60	7.3
	230-3-60	19	80	12	55	2.2	12.8	42.3	60	60	7.3
	380-3-50	6.5	23	6.5	23	1.1	5.4	18.3	30	20	7.3
	400-3-50	6.3	24.5	6.3	24.5	1.1	5.1	17.7	30	20	7.3
	460-3-60	9.5	40	6	27.5	1.1	6.2	21.2	30	30	7.3
	575-3-60	7.8	33	4.9	24	1	4.9	17.4	30	25	7.3
3B3	200/208-3-60	20	78	12.5	51	2.1	14.2	44.6	60	60	7.3
	230-3-60	19	80	12	55	2.2	12.8	42.3	60	60	7.3
	380-3-50	9.5	38	6.5	23	1.1	5.4	22.1	30	30	7.3
	400-3-50	10.4	39	6.3	24.5	1.1	5.1	22.9	30	30	7.3
	460-3-60	9.5	40	6	27.5	1.1	6.2	21.2	30	30	7.3
	575-3-60	7.8	33	4.9	24	1	4.9	17.4	30	25	7.3
4B4	200/208-3-60	20	78	12.5	51	2.1	14.2	44.6	60	60	7.3
	230-3-60	19	80	12	55	2.2	12.8	42.3	60	60	7.3
	380-3-50	9.5	38	6.5	23	1.1	5.4	22.1	30	30	7.3
	400-3-50	10.4	39	6.3	24.5	1.1	5.1	22.9	30	30	7.3
	460-3-60	9.5	40	6	27.5	1.1	6.2	21.2	30	30	7.3
	575-3-60	7.8	33	4.9	24	1	4.9	17.4	30	25	7.3
4C1	200/208-3-60	20	78	12.5	51	2.1	14.2	44.6	60	60	7.3
	230-3-60	19	80	12	55	2.2	12.8	42.3	60	60	7.3
	380-3-50	9.5	38	6.5	23	1.1	5.4	22.1	30	30	7.3
	400-3-50	10.4	39	6.3	24.5	1.1	5.1	22.9	30	30	7.3
	460-3-60	9.5	40	6	27.5	1.1	6.2	21.2	30	30	7.3
	575-3-60	7.8	33	4.9	24	1	4.9	17.4	30	25	7.3
5C2	200/208-3-60	20	78	12.5	51	2.1	14.2	44.6	60	60	7.3
	230-3-60	19	80	12	55	2.2	12.8	42.3	60	60	7.3
	380-3-50	11	40	6.5	23	1.1	5.4	24	30	30	7.3
	400-3-50	10.7	42	6.3	24.5	1.1	5.1	23.2	30	30	7.3
	460-3-60	9.5	40	6	27.5	1.1	6.2	21.2	30	30	7.3
	575-3-60	7.8	33	4.9	24	1	4.9	17.4	30	25	7.3

**NOTES:**

1. Table 14 is appropriate for both Steam and Hot Water Units.
2. Purge pump ratings are for the Welch model 1402.
3. Disconnect size in accordance with NEC. A Johnson Controls supplied 100 amp, non-fused, unit disconnect switch is in the power panel.

# Electrical Data - continued

TABLE 14 – ELECTRICAL RATINGS (Cont'd)

Chiller Model	Voltage (Volts-Ph-Hz)	Solution Pump		Refrigerant Pump		Purge Pump		Minimum Circuit Ampacity	Disconnect Switch (Customer supplied)	Max-Dual Elem. Fuse (Customer supplied)	Total KW
		FLA	LRA	FLA	LRA	FLA	LRA				
6C4	200/208-3-60	20.0	78.0	12.5	51.0	2.1	14.2	44.6	60.0	60.0	7.3
	230-3-60	19.0	80.0	12.0	55.0	2.2	12.8	42.3	60.0	60.0	7.3
	380-3-50	14.0	65.0	6.5	23.0	1.1	5.4	27.7	30.0	40.0	9.7
	400-3-50	14.3	64.0	6.3	24.5	1.1	5.1	27.7	30.0	40.0	9.7
	460-3-60	9.5	40.0	6.0	27.5	1.1	6.2	21.2	30.0	30.0	7.3
	575-3-60	7.8	33.0	4.9	24.0	1.0	4.9	17.4	30.0	25.0	7.3
7D1	200/208-3-60	20.0	78.0	12.5	51.0	2.1	14.2	44.6	60.0	60.0	7.3
	230-3-60	19.0	80.0	12.0	55.0	2.2	12.8	42.3	60.0	60.0	7.3
	380-3-50	14.0	65.0	6.5	23.0	1.1	5.4	27.7	30.0	40.0	9.7
	400-3-50	14.3	64.0	6.3	24.5	1.1	5.1	27.7	30.0	40.0	9.7
	460-3-60	9.5	40.0	6.0	27.5	1.1	6.2	21.2	30.0	30.0	7.3
	575-3-60	7.8	33.0	4.9	24.0	1.0	4.9	17.4	30.0	25.0	7.3
7D2	200/208-3-60	33.0	107.0	12.5	51.0	2.1	14.2	60.9	100.0	90.0	9.7
	230-3-60	30.0	118.0	12.0	55.0	2.2	12.8	56.0	60.0	80.0	9.7
	380-3-50	14.0	65.0	6.5	23.0	1.1	5.4	27.7	30.0	40.0	9.7
	400-3-50	14.3	64.0	6.3	24.5	1.1	5.1	27.7	30.0	40.0	9.7
	460-3-60	15.0	59.0	6.0	27.5	1.1	6.2	28.1	30.0	40.0	9.7
	575-3-60	12.0	47.0	4.9	24.0	1.0	4.9	22.6	30.0	30.0	9.7
8D3	200/208-3-60	33.0	107.0	12.5	51.0	2.1	14.2	60.9	100.0	90.0	9.7
	230-3-60	30.0	118.0	12.0	55.0	2.2	12.8	56.0	60.0	80.0	9.7
	380-3-50	14.0	65.0	6.5	23.0	1.1	5.4	27.7	30.0	40.0	9.7
	400-3-50	14.3	64.0	6.3	24.5	1.1	5.1	27.7	30.0	40.0	9.7
	460-3-60	15.0	59.0	6.0	27.5	1.1	6.2	28.1	30.0	40.0	9.7
	575-3-60	12.0	47.0	4.9	24.0	1.0	4.9	22.6	30.0	30.0	9.7
8E1	200/208-3-60	33.0	107.0	12.5	51.0	2.1	14.2	60.9	100.0	90.0	9.7
	230-3-60	30.0	118.0	12.0	55.0	2.2	12.8	56.0	60.0	80.0	9.7
	380-3-50	14.0	65.0	9.5	38.0	1.1	5.4	30.7	60.0	40.0	11.2
	400-3-50	14.3	64.0	10.4	39.0	1.1	5.1	31.8	60.0	45.0	11.2
	460-3-60	15.0	59.0	6.0	27.5	1.1	6.2	28.1	30.0	40.0	9.7
	575-3-60	12.0	47.0	4.9	24.0	1.0	4.9	22.6	30.0	30.0	9.7
9E2	200/208-3-60	40.7	118.0	21.0	78.0	2.1	14.2	79.0	100.0	110.0	11.2
	230-3-60	36.8	130.0	19.0	80.0	2.2	12.8	71.5	100.0	100.0	11.2
	380-3-50	14.0	65.0	14.0	65.0	1.1	5.4	35.2	60.0	45.0	13.5
	400-3-50	14.3	64.0	14.3	64.0	1.1	5.1	35.7	60.0	50.0	13.5
	460-3-60	18.4	65.0	9.5	40.0	1.1	6.2	35.8	60.0	50.0	11.2
	575-3-60	15.0	52.0	7.8	33.0	1.0	4.9	29.3	30.0	40.0	12.6
10E3	200/208-3-60	40.7	118.0	33.0	107.0	2.1	14.2	91.0	100.0	125.0	13.5
	230-3-60	36.8	130.0	30.0	118.0	2.2	12.8	82.5	100.0	110.0	13.5
	380-3-50	14.0	65.0	14.0	65.0	1.1	5.4	35.2	60.0	45.0	13.5
	400-3-50	14.3	64.0	14.3	64.0	1.1	5.1	35.7	60.0	50.0	13.5
	460-3-60	18.4	65.0	15.0	59.0	1.1	6.2	41.3	60.0	50.0	13.5
	575-3-60	15.0	52.0	12.0	47.0	1.0	4.9	33.5	60.0	45.0	14.9
12F1	200/208-3-60	33.0	107.0	33.0	107.0	2.1	14.2	81.4	100.0	110.0	13.5
	230-3-60	30.0	118.0	30.0	118.0	2.2	12.8	74.0	100.0	100.0	13.5
	380-3-50	14.0	65.0	14.0	65.0	1.1	5.4	35.2	60.0	45.0	13.5
	400-3-50	14.3	64.0	14.3	64.0	1.1	5.1	35.7	60.0	50.0	13.5
	460-3-60	15.0	59.0	15.0	59.0	1.1	6.2	37.1	60.0	50.0	13.5
	575-3-60	12.0	47.0	12.0	47.0	1.0	4.9	29.7	60.0	40.0	13.5

**NOTES:**

1. Table 14 is appropriate for both Steam and Hot Water Units.
2. Purge pump ratings are for the Welch model 1402.
3. Disconnect size in accordance with NEC. A Johnson Controls supplied 100 amp, non-fused, unit disconnect switch is in the power panel.

# Guide Specifications

## GENERAL

Provide Single-Stage Steam (or Hot Water) Absorption Chiller(s) capable of producing chilled water per the capacities shown on drawings and schedules. Chiller shall be capable of starting and operating at entering condenser water temperatures as low as 45°F (7.2°C).

Each chiller shall be of hermetic design and factory helium leak tested.

(For YIA-1A1 to YIA-10E3) Chiller shall ship as a one-piece assembly in a vacuum. (For YIA-12F1 to YIA-14F3) Chiller shall ship as two pieces (upper and lower shells) for field assembly. Each shell shall be shipped charged with nitrogen. Purge pump, chilled water flow switch, and modulating control valve shall be shipped loose for field installation.

All unit mounted controls and control panels shall be factory mounted, wired, tested, and shipped pre-installed as integral components of the chiller.

Unless supplied with a double walled evaporator, chiller shall include 3/4" (19.1 mm) neoprene insulation of the entire shell.

Purchase price shall include start-up service and parts and labor warranty for a period of one year from start-up or eighteen months from delivery, whichever occurs first.

## CONSTRUCTION

The chiller shall consist of a generator, solution heat exchanger, absorber, condenser and an evaporator. The unit construction shall minimize the opportunity for internal leaks between the generator and evaporator sections through the use of a two-shell design, with the upper shell housing the higher pressure generator and condenser, and the lower shell housing the low pressure absorber and evaporator. To minimize the risk of corrosion, the evaporator and condenser pans shall be stainless steel.

The evaporator-absorber and the generator-condenser shall be of shell and tube construction. The steam generator section shall have a tube-side DWP of 150 psig (1.0 mPa) (limited by the ASME code to 15 psig (103 kPa) maximum working pressure): hot water generator shall be designed for 300 psig (2.0 mPa) DWP tube-side and tested to 450 psig (3.0 mPa). A shell-side bursting disk set to burst at 7 psig  $\pm$  2 psig (48 kPaG  $\pm$  14 kPaG) shall be furnished with all units.

## TUBE MATERIALS

Generator tubes shall be 3/4" (19.1 mm), 0.035" (0.89 mm) wall 90/10 copper-nickel and allow for the removal of the tubes from either end of the machine. Evaporator and absorber tubes shall be 3/4" (19.1 mm), 0.028" (0.71 mm) wall copper. Condenser tubes shall be copper and be sized to eliminate the need for contractor provided bypass piping [3/4" or 1" (19.1 mm or 25.4 mm)] with a wall thickness of 0.028" (0.71 mm). Tubes for the solution heat exchanger shall be 0.043" (1.9 mm) wall carbon steel.

## WATER BOXES

Water boxes shall be removable to permit tube cleaning and replacement. Water circuit tubing to be replaceable from either end of the absorption unit. Stub-out water connections having Victaulic grooves shall be provided as standard (ANSI flanged connections are optional). All water boxes and associated water circuit nozzles and tube bundles shall be designed for 150 psig (1.0 mPa) working pressure and shall be hydrostatically tested to 225 psig (1.5 mPa). Vent and drain connections shall be provided on each water box. Manufacturers shall provide lifting lugs on each of the water boxes or install lifting lugs in the field.

The Generator Water boxes for steam applications are designed for 150 PSIG (1.0 MPa) working pressure and are tested at 225 PSIG (1.5 MPa). The steam working pressure is limited to the specified design pressure, which, under no circumstances, is to exceed 14 PSIG (198 kPa) at the generator. The steam connections are 150 PSIG ANSI flanges. The Generator water boxes for hot water applications are designed for 300 PSIG (2.17 MPa) and tested at 450 PSIG (3.20 MPa). The hot water connections are stub-out water connections with Victaulic grooves.

## AUTOMATIC DECRYSTALLIZATION SYSTEM

Chiller shall include an automatic decrystallization system designed to remove any minor crystallization which may occur. System shall immediately detect a blockage in the heat exchanger through the use of thermal sensors and respond with the introduction of refrigerant water to dilute the strong solution entering the solution heat exchanger.

## PUMPS

Solution and refrigerant pumps shall be hermetically sealed, self-lubricating, totally enclosed, factory-mounted, wired and tested. Motor windings shall not be exposed to lithium bromide or water. The suction and discharge

# Guide Specifications - continued

connections for each pump shall be fully welded to the unit piping to minimize the opportunity for leaks. Suction and discharge connections shall be equipped with factory installed isolation valves to permit quick and easy servicing of pumps. Pumps shall be designed to operate for a total of 55,000 hours between service inspections.

## PURGING SYSTEM

Absorber shall be equipped with a purging system to remove non-condensable vapors from the unit during operation. Non-condensibles shall be drawn from a purge header located in the absorber and removed through the operation of an electric vacuum pump.

The purge pump shall be of an oil rotary single-stage design, and shall be furnished complete with a ½ hp (0.68 kW), 3-Phase TEFC motor, and all required accessories. The purge pump shall be shipped mounted on the chiller and connecting hose shall be field installed by installing contractor at the job site.

## PURGING SYSTEM

Absorber shall be equipped with a purging system to remove non-condensable vapors from the unit during operation. Non-condensibles shall be drawn from a purge header located in the absorber and removed through the operation of an electric vacuum pump.

The purge pump shall be of an oil rotary single-stage design, and shall be furnished complete with a ½ hp (0.68 kW), 3-Phase ODP motor, and all required accessories. The purge pump shall be shipped mounted on the chiller and connecting hose shall be field installed by installing contractor at the job site.

## LITHIUM BROMIDE AND REFRIGERANT CHARGE

Lithium bromide shall contain ADVAGuard™750 corrosion inhibitor additive to minimize the rate of copper and ferrous metal corrosion on both the solution and refrigerant sides of the unit. Deionized water shall be supplied for the refrigerant charge. Solution and refrigerant to ship separate from the chiller for charging at the job site.

## STEAM/HOT WATER VALVE

Steam Fired chillers shall be furnished with a steam control valve, linkage and the actuator motor. This assembly shall be shipped loose for field installation. The steam valve shall be cage or butterfly style

1. The cage valve should have a cast iron or carbon steel body.

2. The butterfly valve should have a stainless steel body. The steam control valve assembly shall be capable of modulating steam flow continuously from 10% to 100% of the maximum design chiller capacity. The valve shall be equipped with ANSI flange connections.

Hot Water chillers shall be furnished with a 3-way diverting type valve, linkage and the actuator motor. This assembly shall be shipped loose for field installation. The valve shall feature a cast iron or carbon steel body. The 3-way valve assembly shall be capable of modulating hot water flow continuously from 10% to 100% of the maximum design chiller capacity into the chiller. The valve shall be equipped with ANSI flange connections.

The actuator motor shall be 120V/1-Ph/60Hz, and shall be powered from the chiller's MicroComputer Control Panel. Actuator motor position to be controlled via the MicroComputer Control Panel through a 4-20 mA control signal.

## UNIT CONTROLS

Each unit shall be furnished complete with a factory mounted and pre-wired control system. Unit controls to be furnished shall include a total of two (2) enclosures; a power panel and a microcomputer control panel.

**Power Panel** – The power panel enclosure shall be NEMA 1 and shall house the following components: single point wiring connection for incoming power supply; non-fused disconnect switch; motor starters, complete with current and thermal overload protection, for solution pump(s), refrigerant pump, and purge pump (current overloads only); and a 115 VAC 50/60 Hz control power transformer.

**MicroComputer Control Center** – The control panel enclosure shall be NEMA 1 and be equipped with hinged access door with lock and key. All temperature sensors, pressure transducers, and other control devices necessary to sense unit operating parameters to be factory mounted and wired to panel. The control center panel shall include a 40 character alphanumeric display showing all system parameters in the English language with numeric data in English (or Metric) units (°F, PSIA, or °C, kPa, respectively).

The operating program shall be stored in non-volatile memory (EPROM) to eliminate chiller failure due to AC power failure/battery discharge. In addition, programmed setpoints shall be retained in lithium battery-backed RTC

memory for a minimum of 5 years.

115V control voltage will be supplied through a 1 KVA power transformer located in the power panel and will be factory wired to the microcomputer control panel. Terminal blocks will be provided for all external safety and control interlocks.

**System Operating Information** – During normal operation the following operating parameters shall be accessible via the microcomputer control panel:

- Return and leaving chilled water temperatures
- Return and leaving condenser water temperatures
- Inlet steam pressure
- Refrigerant temperature
- Solution temperature
- Solution concentration
- Indication of refrigerant/solution/purge pump operation
- Operating hours Number of starts
- Number of Purge Cycles (last 7 days and total cumulative)
- Inlet steam or hot water temperature
- Steam or hot water valve actuator potentiometer position (in %)
- Generator shell pressure
- Automatic decrystallization or hot water temperature

**Capacity Control** – The control panel shall automatically control the input steam or hot water flow rate to maintain the programmed leaving chilled water setpoint for cooling loads ranging from 10% to 100% of design. The input steam or hot water flow rate shall also be manually adjustable from the microcomputer control panel to any setting between minimum and maximum when automatic operation is not desired and when steam or hot water input is not being inhibited by a specific operating condition.

**Safety Shutdowns** – Panel shall be pre-programmed to shut the unit down and close “safety shutdown” contacts under any of the following conditions:

- Refrigerant or solution pump thermal or current overload
- Low refrigerant temperature
- Generator high pressure
- Loss of chilled water flow
- Power failure (when “Automatic Restart after Power Failure” option is not utilized)
- High inlet steam or hot water temperature
- High inlet steam pressure

- Incomplete dilution cycle operation due to one of the following conditions:
- Power failure
- Solution/refrigerant pump overloads
- Low refrigerant temperature
- Loss of chilled water flow
- External auxiliary safety shutdown
- High solution concentration

All safety shutdowns will require the unit to be manually restarted.

Whenever a safety shutdown occurs, the microcomputer control panel shall record the following information and store it in memory (or communicate it to a remote printer):

- Day and time of shutdown
- Reason for shutdown
- Type of restart required (automatic restart is displayed, manual restart is implied)
- All system operating information displayed just prior to shutdown

**Warning Conditions** – microcomputer control panel shall close warning contacts and generate a unique warning message whenever one of the following operating conditions is detected:

- Low refrigerant temperature
- High generator pressure
- High inlet hot water temperature
- High inlet steam pressure
- High entering condenser water temperature
- Purge pump current overload
- Faulty strong solution dilution temperature sensor

**Cycling Shutdowns** – Control panel shall be pre-programmed to shut unit down whenever one of the following conditions is detected:

- Loss of condenser water flow
- Low leaving chilled water temperature (2°F below setpoint)
- Power failure (when “Automatic Restart after Power Failure” option is selected)

**Data Logging** – The microcomputer control panel shall contain an RS-232 port to enable the transmission of all operating, setpoint, and shutdown information to a remote printer (printer supplied by others). This transmission can occur as needed or automatically at predetermined intervals (0.1 to 25.5 hr). In the case of a safety or cycling

# Guide Specifications - continued

---

shutdown, the RS-232 port shall transmit all operating data detected prior to the shutdown as well as the time and cause of the shutdown to a remote printer (printer supplied by others). In addition, a history of the last four safety or cycling shutdowns and operating data, with the exception of power failures, shall be retained in memory and can be printed as well.

**Energy Management Interface** – When connected to a BAS interface provided by the chiller manufacturer, the microcomputer control panel shall be able to communicate all data accessible from the keypad to a remote integrated DDC processor through a single shielded cable. This information will include all unit temperatures, pressures, safety alarms, and status readouts for complete integrated plant control, data logging, and local/remote display of operator information. The single shielded cable shall also allow the remote integrated DDC processor to issue operating commands to the control center including but not limited to the following:

- Remote unit start/stop
- Remote chilled water temperature reset
- Remote steam limit input

The Microcomputer Control Panel shall also be capable of providing a limited interface to other building automation systems which are not provided by the chiller manufacturer in order to permit the following operations:

- Remote unit start/stop
- Remote chilled water temperature reset
- Remote steam limit input
- Remote readout of status including:
  - Unit ready to start
  - Unit operating
  - Unit safety shutdown
  - Unit cycling shutdown