

DVD Mini-HiFi System

FWD570

User manual

Manuel d'utilisation

Manual del usuario

使用説明



PHILIPS

México



Es necesario que lea cuidadosamente su instructivo de manejo.

	PRECAUCIÓN - ADVERTENCIA	
	No abrir, riesgo de choque eléctrico	
	ATENCIÓN	
	Verifique que el voltaje de alimentación sea el requerido para su aparato	
Para evitar el riesgo de choque eléctrico, no quite la tapa. En caso de requerir servicio, dirijase al personal calificado.		

Descripción: **Minisistema de Audio**
Modelo : **FWD570/ 21**
Alimentación: **110-127 / 220-240V; ~50-60 Hz**
Consumo: **110 W**
Importador: **Philips Mexicana, S.A. de C.V.**
Domicilio: **Av. La Palma No.6**
Col. San Fernando La Herradura
Huixquilucan
Localidad y Tel: **Edo. de México C.P. 52784**
Tel.52 69 90 00
Exportador: **Philips Electronics HK, Ltd.**
País de Origen: **China**
N° de Serie: _____

**LEA CUIDADOSAMENTE ESTE INSTRUCTIVO
ANTES DE USAR SU APARATO.**

AVISO IMPORTANTE

Philips Mexicana, S.A. de C.V. no se hace responsable por daños o desperfectos causados por:

- *Maltrato, descuido o mal uso, presencia de insectos o roedores (cucarachas, ratones etc.).*
- *Cuando el aparato no haya sido operado de acuerdo con el instructivo del uso, fuera de los valores nominales y tolerancias de las tensiones (voltaje), frecuencia (ciclaje) de alimentación eléctrica y las características que deben reunir las instalaciones auxiliares.*
- *Por fenómenos naturales tales como: temblores, inundaciones, incendios, descargas eléctricas, rayos etc. o delitos causados por terceros (choques asaltos, riñas, etc.).*

CAUTION

Use of controls or adjustments or performance of procedures other than herein may result in hazardous radiation exposure or other unsafe operation.

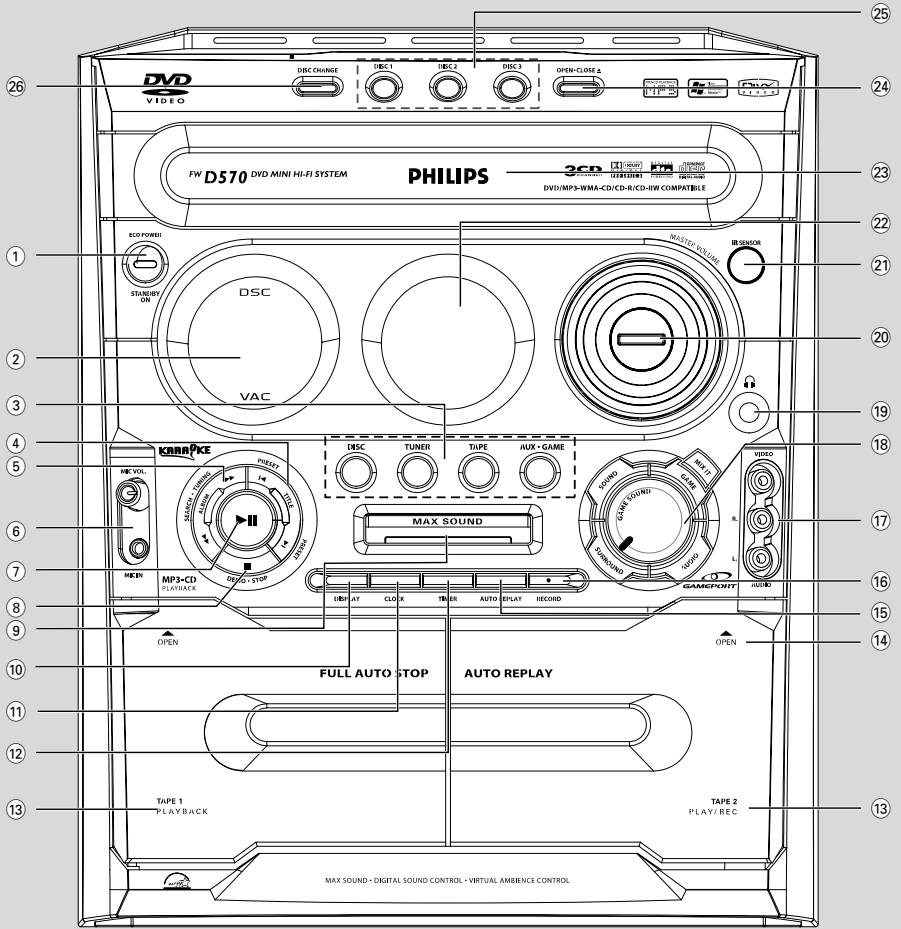

DEMO MODE

To turn ON

Press & HOLD



button

for 5 seconds

To turn OFF

Press & HOLD



button

for 5 seconds

PLUG & PLAY -for tuner installation

1



Plug in the unit

2



Follow instructions
in the display

3



Press "PLAY"

English	6
Español	50
Español	94
中文	138

Manufactured under license from Dolby Laboratories. "Dolby", "Pro-logic" and the double-D symbol are trademarks of Dolby Laboratories.

MANUFACTURED UNDER LICENSE FROM DIGITAL THEATER SYSTEMS, INC. US PAT. NO 5,451,94; 5,956,674; 5,974,380; 5,978,762; 6,226,616; 6,487,535 AND OTHER U.S. AND WORLDWIDE PATENTS ISSUED AND PENDING. "DTS" AND "DTS DIGITAL SURROUND" ARE REGISTERED TRADEMARKS OF DIGITAL THEATER SYSTEMS, INC. COPYRIGHT 1996, 2003 DIGITAL THEATER SYSTEMS, INC. ALL RIGHTS RESERVED.

This product incorporates copyright protection technology that is protected by method claims of certain U.S. patents and other intellectual property rights owned by Macrovision Corporation and other rights owners. Use of this copyright protection technology must be authorized by Macrovision Corporation, and is intended for home and other limited viewing uses only unless otherwise authorized by Macrovision Corporation. Reverse engineering or disassembly is prohibited.

General Information/ Maintenance

Features	8
Discs for playback	8
Region codes	
Supplied accessories	8
Environmental information	9
Care and safety information	9

Connections

Step 1: Placing speakers	10
Step 2: Connecting speakers	10
Step 3: Connecting TV set	11~12
Using Video In jack (CVBS)	
Using Component Video In jack (Pr Pb Y)	
Using S-Video In jack	
Using an accessory RF modulator	
Step 4: Connecting FM/MW antennas	13
Step 5: Connecting the power cord	13
Step 6: Connecting a VCR or cable/satellite box	14
Step 7: Connecting digital audio equipment .	14
Step 8: Connecting to game console	14

Functional Overview

Controls on the system	15~16
Remote control	16~17

Basic Functions

Plug and Play (for tuner installation)	18
Demonstration mode	18

Preparations

Step 1: Inserting batteries into the remote control	19
Step 2: Setting the clock	19~20
Step 3: Setting the TV set	20
Step 4: Setting speakers	21
Step 5: Setting language preference	21

Game Operations

Preparation before use	22
Starting Operation	22

Disc Operations

Playing discs	23
Using the disc menu	23
Basic playback controls	24
Skipping to another title (track)/chapter	
Fast search	
Continuing playback from the last stop point	
Selecting various mode functions	24~25
Repeat play mode	
Shuffle play mode	
Repeating a section within a chapter/track	
Programming favorite tracks	25
Changing discs during playback	26
Special DVD/VCD features	26~28
Changing subtitle language	
Changing sound track language	
Searching for a particular passage	
Displaying the disc information during playback	
Moving to another title (track) / chapter	
Playing from a selected point	
Playing in slow motion mode	
Zooming in	
Viewing from another angle	
Advancing by frames	
Setting Speaker	
Checking the contents of DVD	
Special VCD/SVCD features	28
Playback control (PBC)	

MP3/WMA/DivX/ Picture Disc Operations

Playing MP3/WMA/ Picture disc (Kodak, JPEG)	29
Playing DivX disc	30

DVD Menu Operations

Using the menu bar	31
Using the setup menu	32~36
Setting the TV shape	
Setting the screen saver	
Setting the digital output	
Setting the PCM output	
Night mode - turning on/off	
Test Tone	
DivX(R) VOD	
Changing the password	
Restricting playback by setting parental level	

Tuner Operations

Tuning to radio stations	37
Presetting radio stations	37~38
Automatic preset programming	
Manual preset programming	
Selecting a preset radio station	38
Deleting a preset radio station	
Changing tuning grid	38

Tape Operation/Recording

Tape playback	39
General information on recording	39
Preparation for recording	40
Disc synchro recording	40

Clock/Timer Operations

Viewing clock	41
Setting the timer	41~42
Viewing timer	42
Setting the sleep timer	42

Sound and Volume Controls

Sound control	43
Selecting surround sound	
MAX sound	
Selecting sound effect	
Volume control	43
Changing the volume level	
Switching off the volume temporarily	
Listening through headphones	

Other Functions

Switching on/off	44
Switching the system on	
Switching the system to standby mode	
Switching to eco power standby mode	
Power saving automatic standby	
Dimming the display	44
Vocal	44
Key control	45
Echo	45
Karaoke	45
Listening to external sources	45

Specifications	46
----------------------	----

Troubleshooting	47~48
-----------------------	-------

Glossary	49
----------------	----

General Information/Maintenance

Features

Your DVD Mini Hi-Fi System with 2-channel full digital amplifier creates the same dynamic sound qualities that you find in full-fledged cinemas and incorporates some of the best features in home theater technology.

Other features include:

Built-in DTS and Dolby Digital decoder, supporting virtual surround and stereo.

Additional Component Connections

Lets you connect other audio and audio/visual components to the system so you can use the system's surround sound speakers.

Night mode

Lets you compress the dynamic range, reducing the difference in loudness between different sounds in Dolby Digital mode.

Parental control (rating level)

Lets you set a rating level so that your children cannot watch a DVD that has a rating higher than you set.

Sleep timer

Enables the system to switch to standby mode automatically at a preset time.

Discs for playback

Your DVD Mini Hi-Fi System will play:

- Digital Video Discs (DVDs)
- Video CDs (VCDs)
- SuperVideo CDs (SVCDs)
- Digital Video Discs + Rewritable (DVD+RW)
- Compact Discs (CDs)
- Picture (Kodak, JPEG) files on CDR(W)
- DivX(R) disc on CD-R(W):
- DivX 3.11, 4.x and 5.x
- WMA
- Supported MP3-CD format.
- ISO 9660 / UDF format
- Max. title/album name –12 characters
Max. title number plus album is 255.
- Max. nested directory is 8 levels.
- The max. album number is 32.
- The max. MP3 track number is 999.
- Supported sampling frequencies for MP3 disc: 32 kHz, 44.1 kHz, 48 kHz.
- Supported Bit-rates of MP3 disc are: 32, 64, 96, 128, 192, 256 (kbps).

- Following formats can't be supported
- The files like *.VMA, *.AAC, *.DLF, *.M3U, *.PLS, *.WAV
- Non-English Album/Title name
- The discs recorded under Joliet format
- MP3 Pro and MP3 with ID3 tag



Region codes

DVDs must be labeled for **ALL regions** or for **Region 3** in order to play on this system. You cannot play discs that are labeled for other regions.



Notes:

- For mixed mode discs, only one mode will be selected for playback according to the recording format.
- If you are having trouble playing a certain disc, remove the disc and try a different one. Improperly formatted discs will not play on this system.

Supplied accessories

- Composite video cable (yellow)
- Component video cables (red/blue/green)
- Audio cables (white, red)
- FM wire antenna
- MW loop antenna
- Remote Control and two AA batteries
- AC power cable
- This instruction booklet and a Quick Use Guide



Environmental information

Any unnecessary packaging has been omitted. We have tried to make the packaging easy to separate into three materials: cardboard (box), polystyrene foam (buffer) and polyethylene (bags, protective foam sheet).

Your system consists of materials which can be recycled and reused if disassembled by a specialised company. Please observe the local regulations regarding the disposal of packaging materials, exhausted batteries and old equipment.

Care and safety information

Avoid high temperatures, moisture, water and dust

- Do not expose the system, batteries or discs to humidity, rain, sand or excessive heat (caused by heating equipment or direct sunlight). Always keep disc trays closed to avoid dust buildup on the lens.
- No objects filled with liquids, such as vases, shall be placed on the apparatus.
- No naked flame sources, such as lighted candles, should be placed on the apparatus.

Avoid condensation problem

- The lens may cloud over when the player is suddenly moved from cold to warm surroundings, making it impossible to play a disc. Leave the player in the warm environment until the moisture evaporates.

Do not block the vents

- Do not operate the system in an enclosed cabinet and allow about 10 cm (4 inches) of free space all around the player for adequate ventilation.

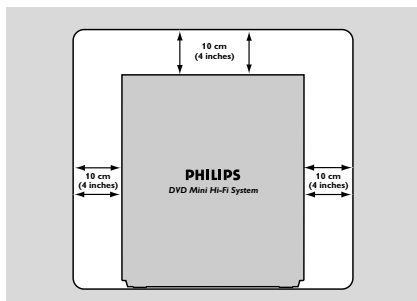

- The ventilation should not be impeded by covering the ventilation openings with items, such as newspapers table-cloths, curtains, etc.

Cleaning the cabinet

- Use soft cloth slightly moistened with a mild detergent solution. Do not use a solution containing alcohol, spirits, ammonia or abrasives.



Cleaning discs

- To clean a CD, wipe it in a straight line from the center towards the edge using soft and lint-free cloth. A cleaning agent may damage the disc.
- Write only on the printed side of a CDR(W) and only with a soft felt-tipped pen.
- Handle the disc by its edge. Do not touch the surface.

Cleaning the disc lens

- After prolonged use, dirt or dust may accumulate at the disc lens. To ensure good playback quality, clean the disc lens with Philips CD Lens Cleaner or any commercially available cleaner. Follow the instructions supplied with cleaner.

Finding a suitable location

- Place the player on a flat, hard, stable surface.

Cleaning the head and the tape paths

- To ensure good recording and playback quality, clean the head (A), the capstan(s) (B), and pressure roller(s) (C) after every 50 hours of tape operation.
- Use a cotton swab slightly moistened with cleaning fluid or alcohol.
- You also can clean the head by playing a cleaning tape once.

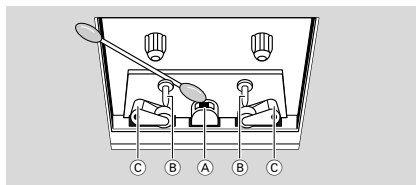

Demagnetising the head

- Use a demagnetising tape available at your dealer.

Connections

Step 1: Placing speakers

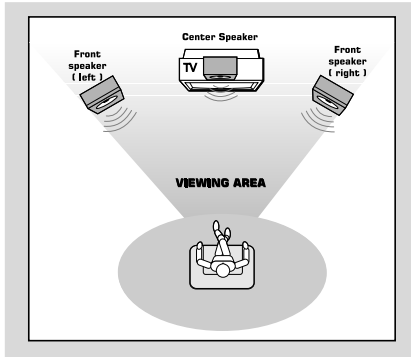

Place the front left and right speakers at equal distances from the TV set and at an angle of approximately 45 degrees from the listening position.

Notes:

- To avoid magnetic interference, do not position the front speakers too close to your TV set.
- Allow adequate ventilation around the DVD Mini Hi-Fi System.

Step 2: Connecting speakers

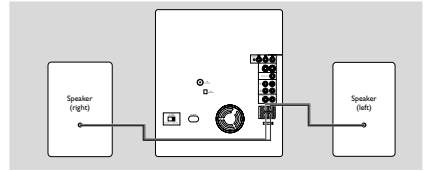

Connect the speaker wires to the SPEAKERS (FRONT) terminals, right speaker to "R" and left speaker to "L", coloured (marked) wire to "+" and black (unmarked) wire to "-". Fully insert the stripped portion of the speaker wire into the terminal as shown.

Speakers	⊖	⊕
Front Left (L)	Black	White
Front Right (R)	Black	Red

Notes:

- For optimal sound performance, use the supplied speakers.
- Do not connect more than one speaker to any one pair of +/- speaker terminals.
- Do not connect speakers with an impedance lower than the speakers supplied. Please refer to the SPECIFICATIONS section of this manual.

IMPORTANT!

The type plate is located on the rear of the system.

To avoid overheating of the system, a safety circuit has been built in. Therefore, your system may switch to Standby mode automatically under extreme conditions. If this happens, let the system cool down before reusing it.

Step 3: Connecting TV set

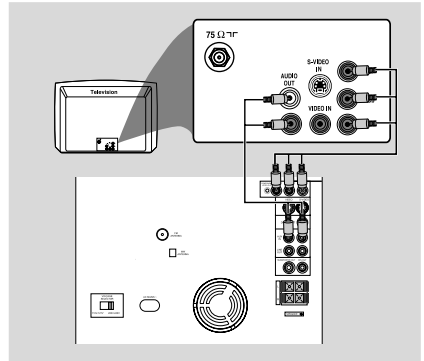
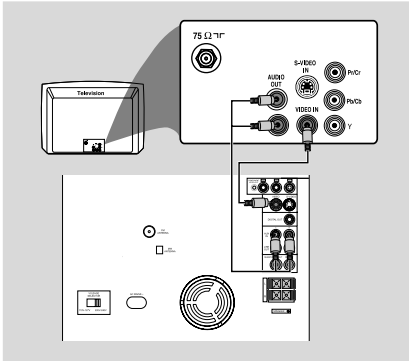

IMPORTANT!

- You only need to make **one** video connection from the following options, according to the capabilities of your TV system.
- **S-Video or Component Video** connection provides higher picture quality. These options must be available on your TV set.
- **Connect the system directly to the TV set.**

Using Video In jack (CVBS)

- Use the composite video cable (yellow) to connect the system's **VIDEO** jack to the video input jack (or labeled as A/V In, Video In, Composite or Baseband) on the TV set.
- To listen to TV channels through this system, use the audio cables (white/red) to connect **AUX IN (L/R)** jacks to the corresponding AUDIO IN jacks on the TV set.

Using component Video In jack (Pr PbY)

- Use the component video cables (red/blue/green) to connect the system's **Pr PbY** jacks to the corresponding Component video input jacks (or labeled as Pr/Cr Pb/Cb Y or YUV) on the TV set.
- To listen to TV channels through this system, use the audio cables (white/red) to connect **AUX IN** jacks to the corresponding AUDIO IN jacks on the TV set.

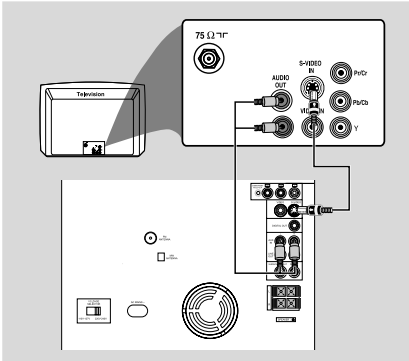

Using S-Video In jack

- Use the S-Video cable (not supplied) to connect the system's **S-VIDEO OUT** jack to the S-Video input jack (or labeled as Y/C or S-VHS) on the TV set.
- To listen to TV channels through this system, use the audio cables (white/red) to connect **AUX IN** jacks to the corresponding AUDIO OUT jacks on the TV set.

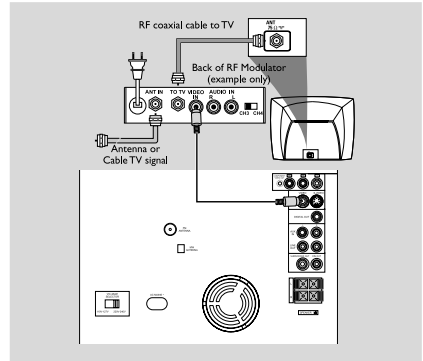

IMPORTANT!

– If your TV set only has a single **Antenna In** jack (or labeled as 75 ohm or RF In), you will need a **RF modulator** in order to view the **DVD playback via TV**. See your electronics retailer or contact **Philips** for details on RF modulator availability and operations.

Using an accessory RF modulator

- Use the composite cable (yellow) to connect the system's **VIDEO** jack to the video input jack on the RF modulator.
- Use the RF coaxial cable (not supplied) to connect the RF modulator to your TV's RF jack.

Step 4: Connecting FM/MW antennas

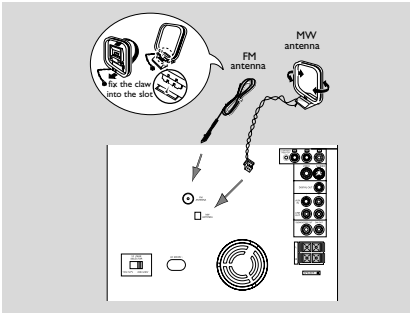

- Connect the supplied MW loop antenna to the **MW** jack. Place the MW loop antenna on a shelf or attach it to a stand or wall.
- Connect the supplied FM antenna to the **FM** jack. Extend the FM antenna and fix its end to the wall.

For better FM stereo reception, connect an outdoor FM antenna to the FM ANTENNA terminal.

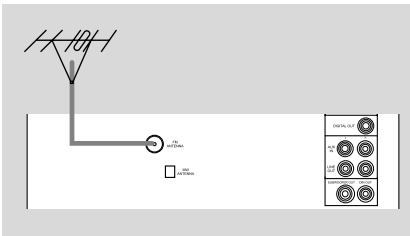

Notes:

- Adjust the position of the antennas for optimal reception.
- Position the antennas as far as possible from your TV set, VCR or other radiation sources to prevent unwanted interference.

Step 5: Connecting the power cord

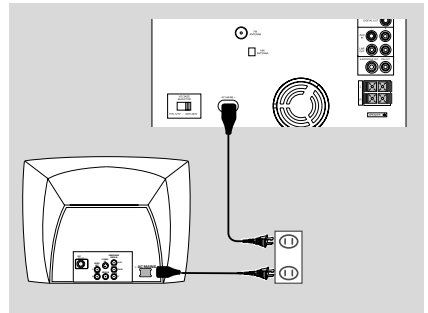

After everything is connected properly, plug in the AC power cord to the power outlet.

Never make or change any connection with the power switched on.

On the DVD Mini Hi-Fi System

“AUTO INSTALL -PRESS PLAY” may appear on the display panel. Press **▶▶** on the front panel to search and store all available radio stations or press **■** to exit (See page 37, Tuner Operations- Presetting radio stations).

If your system is equipped with a Voltage Selector; set the VOLTAGE SELECTOR to the local power line voltage.

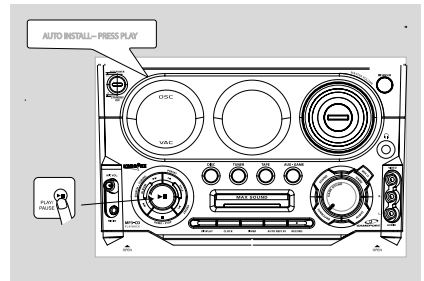
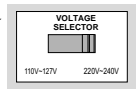

Connections

Step 6: Connecting a VCR or cable/satellite box

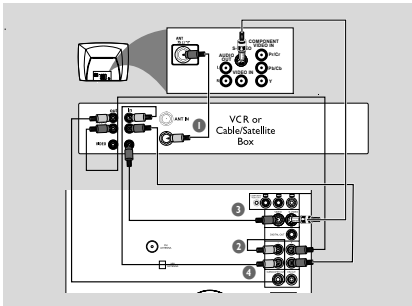

Viewing and listening to playback

- 1 Connect the VCR or Cable/Satellite Box to the TV system as shown.
- 2 Connect the system's AUX IN jacks to the AUDIO OUT jacks on the VCR or Cable/Satellite box.

Before starting operation, press **AUX/GAME** on the remote control to select "AUX" in order to activate the input source.

Using the VCR for recording DVDs

Some DVDs are copy-protected. You cannot record or dub protected discs using a VCR.

- 3 Connect the system's **VIDEO** jack to the VIDEO IN jack on the VCR.
- 4 Connect the system's **LINE OUT (R/L)** jacks to the AUDIO IN jacks on the VCR. This will allow you to make analog stereo (two channel, right and left) recording.

To view DVD playback while recording

You must connect the system to your TV system using the S-VIDEO (as shown above) or the Component (Pr Pb Y) video connection.

Step 7: Connecting digital audio equipment

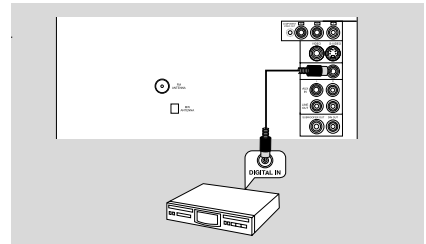

Recording (digital)

Connect the system's DIGITAL OUT jack to the DIGITAL IN jack on a digital recording device (DTS-Digital Theater System compatible, with a Dolby Digital decoder, for example).

Before operation, set the DIGITAL OUTPUT according to the audio connection. (See Using the Setup Menu – Setting the digital output).

Step 8: Connecting to game console

IMPORTANT!

– **Gameport inputs are for the game console only.**

- Use the game console's video cable (not supplied) to connect its video output to the GAMEPORT-VIDEO terminal.
- Use the game console's audio cable (not supplied) to connect its audio output to the GAMEPORT-AUDIO L/ AUDIO R. terminals.
- Use the video cable (yellow) to connect the VIDEO OUT terminal to the video input on the TV for viewing.

Notes:

- On the TV, the Video Input jack is usually yellow and might be labeled A/V In, CVBS, composite or Baseband.
- To avoid magnetic interference, do not position the front speakers too close to your TV.

Controls on the system

① ECO POWER/ STANDBY ON

- to switch the system on, to Eco Power or Standby mode.

② DISPLAY SCREEN

- to view the current status of the system.

③ SOURCE

- to select the following:

DISC (DISC 1•2•3)

- to select disc tray 1, 2 or 3

TUNER (BAND)

- to select waveband: FM or MW.

TAPE (TAPE 1-2)

- to select tape deck 1 or 2.

AUX•GAME

- to select a connected external source: TV/CDR, AUX (auxiliary) or Gameport mode.

④ PREV / PRESET / NEXT ◀▶ (TITLE - / +)

for DISC to select previous/next title, chapter or track during playback.

for TUNER to select a preset radio station.

for CLOCK to set the hour.

⑤ SEARCH•TUNING ◀◀ / ▶▶ (ALBUM - / +)

for DISC to search backward/forward. to select previous/next album in MP3/WMA stop mode (with MENU ON).

for TAPE to rewind or fast forward.

for TUNER to tune to a lower or higher radio frequency.

for CLOCK to set the minute.

⑥ MICVOL./ MIC IN

- to adjust the mixing level for karaoke or microphone recording.
- to connect microphone jack.

⑦ ▶II (PLAY/PAUSE)

for DISC to start or interrupt playback.

for TAPE to start playback.

for PLUG&PLAY ... (on the system only) to initiate plug & play mode.

⑧ DEMO•STOP ■

for DISC to stop playback or to clear a programme.

for DEMO (in Standby or ECO power mode) to activate/deactivate demonstration.

for PLUG&PLAY ... (on the system only) to exit plug&play mode.

⑨ MAX SOUND

- to activate or deactivate MAX sound.

⑩ DISPLAY

- to display disc information during disc playback.

⑪ CLOCK

- to view or to set clock.

⑫ TIMER

- to view or to set timer.

⑬ TAPE DECK 1 / 2

⑭ ▲ OPEN

- to open the tape deck door.

⑮ AUTO REPLAY

- to select continuous playback in either AUTO PLAY or ONCE mode only.

⑯ RECORD

- to start recording on tape deck 2.

⑰ VIDEO

- use a video cable to connect to your game console's video output

AUDIO L./ AUDIO R.

- use an audio cable to connect to your game console's left/right audio output.

⑱ SOUND

- to select various sound effect.

SURROUND

- to select various surround sound effect.

AUDIO

- to select the preferred language for audio
- to select AUDIO channel in karaoke mode.

MIX IT

- to mix the game sound with your favorite music from one of the music sources (DISC, TUNER, TAPE1/2 or AUX)

GAME

- to select different type of equaliser setting for Gameport (SPEED, PUNCH or BLAST).

GAME SOUND

- to adjust the game's output volume level.

Functional Overview

- 19 
 - to connect headphones.
- 20 **VOLUME**
 - to increase or decrease the volume.
- 21 **SENSOR**
 - point the remote control towards this sensor.
- 22 **INTERACTIVE VU METER**
 - to show the VU (volume unit) meter in music or volume mode depending on the display mode selected.
- 23 **DISCTRAYS**
- 24 **OPEN•CLOSE**
 - to open or close the disc tray.
- 25 **DISC1/ DISC2/ DISC3**
 - to select a disc tray for playback.
- 26 **DISC CHANGE**
 - to change disc(s).

Remote control

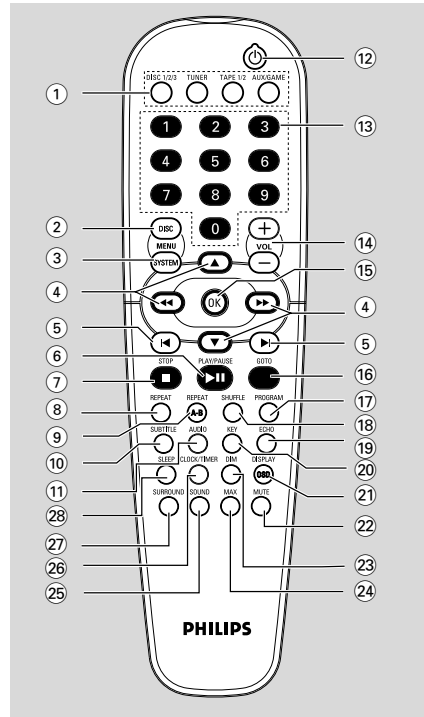

Notes:

- First, select the source you wish to control by pressing one of the source select keys on the remote control (DISC or TUNER, for example).
- Then select the desired function (▶▶, ◀◀ or ▶| for example).

- 1 **SOURCE**
 - to select the relevant active mode: DISC1/2/3, TUNER, TAPE1/2 or AUX/GAME.
 - TUNER: toggles between FM and MW band.
 - AUX/GAME: toggles between AUX and GAMEPORT mode.
- 2 **DISC MENU (disc mode only)**
 - to enter or exit the disc contents menu.
- 3 **SYSTEM MENU (disc mode only)**
 - to enter or exit the system menu bar.
- 4 **◀◀ / ▶▶ / ▲ / ▼**
 - to select movement direction in disc contents menu/system menu bar.
 - to tuner mode, to tune to lower or higher radio frequency. (◀◀ / ▶▶)

- in Disc mode, press to fast reverse/forward the disc.
- ⑤ **◀/▶**
 - in Disc mode, press to skip to the previous/next chapter/track.
 - in Tuner mode, to select a preset radio station number
- ⑥ **PLAY/PAUSE ▶||**
 - to start or interrupt disc playback.
 - to resume playback from last stop point.
- ⑦ **STOP ■**
 - to stop playing the disc.
- ⑧ **REPEAT**
 - to select variations of continuous playback.
- ⑨ **REPEAT A-B**
 - to repeat a specific section on a disc.
- ⑩ **SUBTITLE**
 - to select desired subtitle.
- ⑪ **AUDIO**
 - to select the audio channel.
- ⑫ **POWER ⏻**
 - to switch to eco power or standby mode.
- ⑬ **Numeric Keypad (0-9)**
 - to enter a track/title number of the disc.
 - to enter a number of preset radio stations.
- ⑭ **VOL +/-**
 - adjust the volume level.
 - adjust key control/ ECHO level in karaoke mode.
 - adjust speakers level in speaker setting mode.
- ⑮ **OK**
 - to exit or confirm the selection.
- ⑯ **GOTO**
 - to go direct to desired title, chapter or time.
- ⑰ **PROGRAM**
 - in disc mode, to program favorite tracks.
 - in tuner mode, to program favorite stations.
- ⑱ **SHUFFLE**
 - to playback in random mode.
- ⑲ **ECHO**
 - to adjust the echo level in karaoke mode.
- ⑳ **KEY**
 - to change the tone level to suit your vocal range.
- ㉑ **DISPLAY (OSD)**
 - to view the time, title or chapter information.
- ㉒ **MUTE**
 - to interrupt or resume sound reproduction.
- ㉓ **DIM**
 - to select different brightness for VFD.
- ㉔ **MAX**
 - to activate or deactivate MAX sound.
- ㉕ **SOUND**
 - to select various sound effect.
- ㉖ **CLOCK/TIMER**
 - to view clock/ timer.
 - to enter timer setting mode.
- ㉗ **SURROUND**
 - to select various surround sound effect.
- ㉘ **SLEEP**
 - to set the sleep (auto-off) timer function.

Plug and Play (for tuner installation)

Plug and play allows you to store all available radio stations automatically.

If plug and play has not been installed

- 1 When you turn on the system, "AUTO INSTALL - PRESS PLAY" will be displayed.
- 2 Press **▶||** on the system to start installation.
 - "INSTALL" will be displayed and followed by "TUNER" and then "AUTO".
 - **PROG** will start to flash.
 - The system will search all radio stations on the FM band, and then the MW band.
 - All available radio stations with strong signal strength will be stored automatically.
 - The system will stop searching when all available radio stations are stored or when the memory for 40 preset radio stations is full.
 - The first preset radio station will play when Plug and Play is completed.

Reinstalling plug and play

- 1 In Standby or Demonstration mode, press and hold **▶||** on the system until "AUTO INSTALL - PRESS PLAY" is displayed.
- 2 Press **▶||** again to start installation.
 - All previously stored radio stations will be replaced.

To exit without storing the plug and play

- Press **■** on the system.

Notes:

- When the power is turned on, the disc tray may open and close to initialise the system.
- If Plug and Play installation is not completed, it will be reinitiated the next time you power on the system.
- If there is no antenna connected, "CHECK ANTENNA" will scroll on the display.
- If auto-install is not preset, the system will store the radio station automatically.

Demonstration mode

The system has a demonstration mode that shows various features offered by the system.

Activating demonstration

- In Standby or ECO power mode, press and hold **DEMO•STOP ■** for more than 5 seconds to activate demo mode.
 - "DEMO ON" is displayed.
 - Demonstration will begin.

Deactivating demonstration

- Press and hold **DEMO•STOP ■** on the system until "DEMO OFF" is displayed.
 - The system will switch to Standby mode.

Note:

- Even if you remove the AC power cord and reconnect it to the wall socket, the demonstration will remain off until you activate it again.

IMPORTANT!

– Make sure to complete the preparation procedures before operating the system.

Step 1: Inserting batteries into the remote control

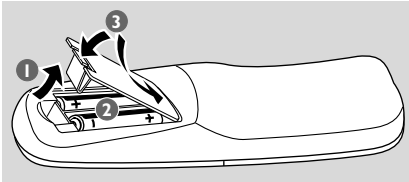

- 1 Open the battery compartment.
- 2 Place two batteries (Type R06 or AA) in the compartment with the correct polarity as indicated by "+" and "-" symbols.
- 3 Close the cover.

Using the remote control to operate the system

- 1 Point the remote control directly at the remote sensor (IR) on the front panel.
- 2 Select the source you wish to control by pressing one of the source select buttons on the remote control (for example TAPE1/2, TUNER).
- 3 Then select the desired function (for example **▶|||◀** or **▶|**).

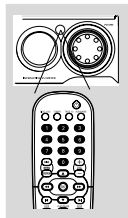

CAUTION!

- Remove batteries if they are exhausted or will not be used for a long time.
- Do not use old and new or different types of batteries in combination.
- Batteries contain chemical substances, so they should be disposed of properly.

Step 2: Setting the clock

The clock can be set in either 12-hour or 24-hour mode ("PM 00:00" or "00:00" for example).

- 1 The clock can be set in any source mode.
→ If you have not set the clock, "--:--" will be shown on the display.

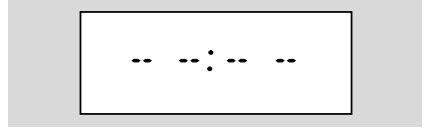

- 2 Press and hold **CLOCK** and "00:00" blinks on the display.
→ The current time is flashing on the display.
→ If you have not set the clock, "--:--" will appear on the display.
- 3 Press **◀** or **▶** on the system to set the hours.
- 4 Press **◀◀** or **▶▶** on the system to set the minutes.
- 5 Press **CLOCK** to confirm your setting. Clock will be shown on the display for 5 seconds and then go back to its previous status. The system will store the setting automatically.
→ The time setting becomes effective.

To exit the setting without storing (in standby mode)

- Press **■** on the system to exit.
→ "CANCEL" will appear on the display.
- Press **ECO POWER/STANDBY ON** to exit setting mode and go into **ECO POWER** mode.
- You can also press **DISC, DISC1~3, DISC CHANGE, OPEN/CLOSE** to exit setting mode and go into disc mode.
- The system will also exit setting mode and go to TUNER, TAPE or AUX/GAME mode when you press the corresponding source button.

Viewing the clock in any source mode

- When you have set the clock, press **CLOCK** on the system to view clock (or press **CLOCK/TIMER** on the remote control). Press **DISPLAY** on the system to toggle between 12-hour and 24-hour modes.
→ The time will be displayed for 5 seconds and then go back to its previous status.

Preparations

Notes:

- The clock will be cancelled when the power cord is disconnected or if a power failure occurs.
- During clock setting, if no button is pressed within 10 seconds, the system will exit the setting mode and go back to its previous status.

Step 3: Setting the TV set

IMPORTANT!

- Make sure you have completed all the necessary connections. (See **Connections – Connecting TV set**)

- 1 Press **DISC (DISC 1•2•3)** on the front panel (or press **DISC 1/2/3** on the remote control).
- 2 Turn on the TV set and set to the correct Video-In channel. You should see the blue Philips DVD background screen on the TV set.
 - You may go to channel 1 on your TV set, then press the channel down button repeatedly until you see the Video In channel.
 - Or, you can use the TV remote control to select different video modes.
 - Or, set TV to channel 3 or 4 if you are using an RF modulator.

Selecting the color system that matches your TV set

This DVD Mini Hi-Fi System is compatible with both NTSC and PAL. For the playback of a DVD disc on this DVD Mini Hi-Fi System, the color systems of the DVD, TV set and DVD Mini Hi-Fi System should match.

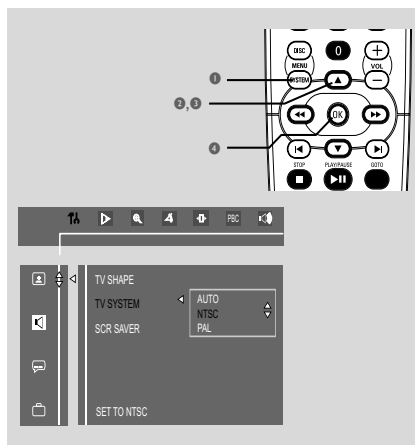

- 1 In disc mode, stop playback and press **SYSTEM MENU**.
- 2 Select **TV** icon and press **▼**.
- 3 Press **◀▶ / ▲ / ▼** keys on the remote control to toggle through the functions and select your preferred option.
 - Move to **TV** and press **▶▶**.
 - Move to "TV System" and press **▶▶**.

AUTO

- Select this if the connected TV set is compatible with both NTSC and PAL (multi system). The output format will be consistent with the video signal of the disc.

NTSC

- Select this if the connected TV set is NTSC system. It will change the video signal of a PAL video disc and output to NTSC system.

PAL

- Select this if the connected TV set is PAL system. It will change the video signal of an NTSC disc and output to PAL format.

- 4 Select an item and press **OK**.

To remove the menu

Press **SYSTEM MENU**.

Step 4: Setting speakers

IMPORTANT!

– This function is only available when you have connected other 3.1-channel speakers.

You can adjust the delay time (center and rear only) for individual speakers to optimize the sound effect according to your surroundings and setup. Speaker settings are only active on effective in the case of Multi-channel audio output.

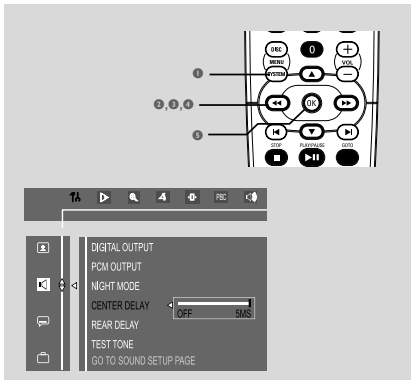

- 1 In disc mode, press **SYSTEM MENU**.
- 2 Select **FA** icon and press **▼**.
- 3 Press **◀ / ▶ / ▲ / ▼** keys on the remote control to select your preferred option.
 - Move to **KL** and press **▶▶**.
 - Move to "CENTER DELAY" or "REAR DELAY" and press **▶▶**.
- 4 Press **▶▶** to set CENTER DELAY or REAR DELAY values you want.
 - Use longer delay time if the surround speakers are closer to the listener than the front speakers.
- 5 Press **OK** to confirm.

To remove the menu

Press **SYSTEM MENU**.

Step 5: Setting language preference

You can select your preferred language settings so that this DVD Mini Hi-Fi System will automatically switch to the language for you whenever you load a disc. If the language selected is not available on the disc, the language set by default will be used instead. But the menu language of the DVD Mini Hi-Fi System cannot be changed once selected.

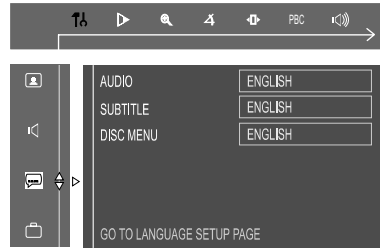

- 1 In disc mode, stop playback and press **SYSTEM MENU**.
- 2 Select **FA** icon and press **▼**.
- 3 Press **◀ / ▶ / ▲ / ▼** keys on the remote control to select your preferred option.
 - Move to **KL** and press **▶▶**.
 - Move to one of the following and press **▶▶**.
 - Audio (disc's soundtrack)
 - Subtitle (disc's subtitles)
 - Disc Menu (on screen menu)
- 4 Press **▲ / ▼** to select a language and press **OK**.
- 5 Repeat **steps 3~4** for other settings.

To remove the menu

Press **SYSTEM MENU**.

About Gameport

Gameport allows you to connect your game console to this mini system which enables you to enjoy a total game immersion experience through powerful sound output.

Preparation before use

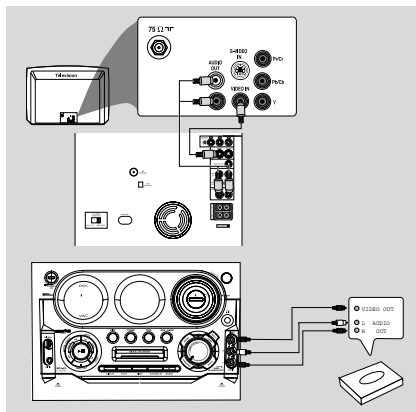

- 1 Connect your game console's video and audio output to the GAMEPORT video and audio inputs respectively (See Connecting to game console).
- 2 Connect your TV's video input to the VIDEO OUT on the rear panel of the system.
- 3 Connect all the AC power cord to the power outlet.

Starting Operation

- 1 Turn on the TV and set to the correct video-in channel.
The TV's video input channel may be called AUX (iliary) IN, AUDIO/VIDEO (A/V) IN, EXT 1 etc. These channels are often near channel 00 on your TV. Or, your TV remote control may have a button or switch that chooses different video modes. See your TV manual for details.
- 2 Press AUX/GAME until "GAMEPORT" is displayed.
- 3 Press GAME on the system to select the type of sound setting that best suit the game: SPEED, PUNCH, BLAST or OFF.
- 4 If you like to mix your game sound to your favorite music, press MIX IT to select the desired music source: DISC, TUNER, TAPE, AUX or OFF.
DISC : "MIX-DISC"
TUNER : "MIX-TU"
TAPE : "MIX-TAPE"
AUX : "MIX-AUX"
OFF : "MIX-OFF"

Notes:

- To change the disc tray, you have to press DISC, then press DISC1/2/3 to select the desired disc tray.
- If "MIX-TU" is selected, press TUNER button to select FM or MW band.
- If "MIX-TAPE" is selected, press TAPE button to select TAPE 1 or TAPE 2.

- 5 If necessary, start playback of your chosen mixer source.
- 6 Start playing your favourite game.

To adjust the game console's volume level

- Adjust GAME SOUND.

Notes:

- You can only activate GAME SOUND and MIX IT while in the game source mode.
- If your game console is switched on, the video image will always appear on the TV even though you are not in the gameport mode.

IMPORTANT!

- This system is designed for regular discs. Therefore, do not use any accessories such as disc stabiliser rings or disc treatment sheets, etc., as offered on the market, because they may jam the disc mechanism.
- Do not move the system during playback. Doing so may damage the system.
- Do not push on the disc tray or put any object other than disc on the disc tray. Doing so may cause the system to malfunction.
- DVD discs and players are designed with regional restrictions. Before playing a disc, make sure the disc matches the regional code of your player.
- According to the format requirement of DVD or VCD, some operations may be different or restricted.

Playing discs

- 1 Press **ECO POWER/ STANDBY ON**  to switch on the system, and then press **DISC** to select disc mode.
- 2 Power on the TV system and set to the correct Video In channel (See Setting the TV set).
→ You should see the blue Philips DVD background screen on the TV set.
- 3 Press **OPEN/CLOSE** to open the disc tray and load a disc respectively in the first two disc trays.. To load the third disc, press **DISC CHANGE**.
→ The disc tray will rotate until the empty tray is ready for loading.
→ Make sure the disc label is facing up. For double-sided discs, load the side you want to play facing down.

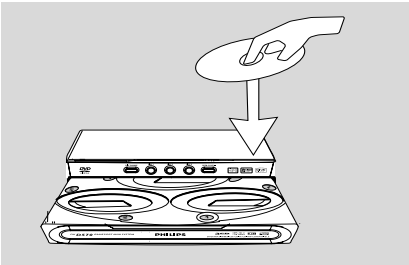

- 4 Press **OPEN•CLOSE** to close the disc tray.
→ "READING DISC" will be displayed.
→ In the stop mode, press **DISC 1/2/3** on the remote control repeatedly to select **DISC 1**, **DISC 2** or **DISC 3** cyclically.
- Some discs can play automatically. For discs with Table Of Contents, a menu may appear on the TV screen. When the menu is displayed, press **◀◀ / ▶▶ / ▲ / ▼** keys to highlight your selection and press **OK** to confirm. To select a play option, press **numeric keys (0-9)**.
→ If a disc menu shows on the TV screen, see "Using the Disc Menu".
→ If the disc is locked by parental control, you must enter your four-digital password (See Changing the password).
- 5 Press **▶II** to start playback.

For MP3/ DivX/WMA

- Load an MP3/ DivX/ WMA disc in the disc tray.
→ "MENU ON" will be shown on the display.
→ Press **DISC MENU** to select menu on/off.
→ In menu off mode, playback will start from the first track.

Notes:

- Load discs with the label side facing up.
- To ensure good system performance, wait until disc reading is completed before proceeding.

Using the disc menu

For disc with Table Of Contents, a menu may appear on the TV screen once you load the disc.

To select a playback feature or item

- Press **◀◀ / ▶▶ / ▲ / ▼** or **numeric keys (0-9)** on the remote control, then press **▶II** or **OK** to start playback.

To access or remove the menu

- Press **DISC MENU** on the remote control.

Basic playback controls

To play discs in all the disc trays

- Press **▶II**.
 - All the available discs will play once, then stop.
 - During playback, the selected disc tray, elapsed playing time of the current track will appear on the display.

To start playback from a selected disc tray

- Press **DISC 1**, **DISC 2** or **DISC 3**.

To interrupt playback

- Press **▶II**.
- To resume playback, press **▶II** again.

To stop playback

- Press **■**.

Skipping to another title (track) / chapter

- Press **◀** or **▶** on the front panel or on the remote control repeatedly during playback to skip backward or forward. Each press will take the disc to the beginning of the previous or next title (track) / chapter.

Note:

– If the player has been set to repeat chapter (track), pressing this button will replay the same chapter (track) from its beginning.

To go directly to any title (track) / chapter

- Use the **numeric keys (0-9)** to enter the number of the desired title (track) / chapter.

Fast search

- 1 Press **◀◀** or **▶▶** on the front panel (or on the remote control) to fast reverse or forward the disc.
- 2 To resume normal play, press **▶II**.

Continuing playback from the last stop point

- In stop mode and before the disc is removed, press **▶II** to resume playback from where you have stopped.

To cancel the resume mode

- Press **■** again, or go into **STANDBY**, **ECO POWER**, **POWER OFF** or press **OPEN/CLOSE** key.

Notes:

- Resume information will be erased if you have changed the disc, opened the disc tray, changed source or disconnected the system from the power supply.
- Resume function is not available in **PBC ON** mode.
- This function is not available for **MP3/WMA** disc.

Selecting various mode functions

Repeat play mode

You can only select the Repeat play mode during playback.

For DVD - repeat chapter/title

- Press **REPEAT** repeatedly to select the following:
REPEAT CHAPTER → **REPEAT TITLE** → **REPEAT OFF**

For CVD/SVCD/VCD/CD - repeat track/disc

- Press **REPEAT** repeatedly to select the following:
REPEAT TRACK → **REPEAT DISC** → **REPEAT ALL** → **REPEAT OFF**

During program playback

- Press **REPEAT** repeatedly to select the following:
REPEAT ONE-PROGRAMMED TRACK → **REPEAT ALL PROGRAMMED TRACKS** → **REPEAT OFF**

For MP3 repeat - track/album/disc MENU ON:

- Press **REPEAT** repeatedly to select the following:
REPEAT TRACK → **REPEAT ALBUM** → **REPEAT DISC** → **REPEAT ALL** → **REPEAT OFF**

MENU OFF:

- Press **REPEAT** repeatedly to select the following:
REPEAT TRACK → REPEAT DISC → REPEAT ALL → REPEAT OFF

Notes:

- When you open the disc tray, the Repeat function will be cancelled automatically.
- For CVD, SVCD and VCD 2.0 discs, the Repeat function is not available unless the PBC function is set to OFF.
- If discs of different formats are loaded, the Repeat function is only available for the current disc.

Shuffle play mode

In this mode, all tracks in the current directory will be played once in a random order:

- 1 In stop mode, press **SHUFFLE** to play in a shuffle order:
→ Playback will start from the first disc to the last disc.
- 2 Press **SHUFFLE** repeatedly to select the following:
SHUFFLE DISC → REPEAT SHUFFLE DISC → SHUFFLE ALL → REPEAT SHUFFLE ALL → SHUFFLE OFF
- 3 Press **▶II** to start shuffle play.

In shuffle playback mode:

- Press **▶I** button to select another track in a shuffle order:
- 4 Press **■** to stop shuffle playback.

To cancel Shuffle mode:

- In stop mode, press **SHUFFLE** repeatedly to select SHUFFLE OFF.

Notes:

- In Tuner, Tape or AUX/GAME mode, this button does not function.
- When the disc tray is opened, the Shuffle function will be cancelled automatically.
- In the Shuffle playback mode, the system only supports the same disc format.
- This function is only available for CD or VCD (PBC OFF).

Repeating a section within a chapter/track

You can play a specific section in a chapter/track repeatedly.

- 1 Press **REPEAT A-B** at your chosen start point.
- 2 Press **REPEAT A-B** again at your chosen end point.
→ The passage will now repeat continuously.
- 3 To resume normal play, press **REPEAT A-B** again.

Note:

- The REPEAT A-B function can only be set within the same chapter or track.

Programming favorite tracks

You can play the contents of the disc in the order you want. At most 99 tracks can be stored.

- 1 Load the desired discs on the disc trays.
- 2 Press the **DISC** button to select the disc tray.
→ Programming can only be done on the selected disc.
- 3 While playback is stopped, press **PROGRAM** to enter program mode.
→ "P 00 :00" is displayed.
- 4 Use the **numeric keys (0-9)** to input the track number in the order you want.
→ If you attempt to program more than 99 tracks, "FULL" is displayed.
- 5 Press **OK** to store the track.
- Repeat **steps 3-5** to store other tracks.
- 6 Press **▶II** to play the program.
- 7 To stop playback, press **■** once.
- 8 To exit the program mode, press **■** again.

Note:

- This function is not available for DVD or MP3/WMA discs.

Disc Operations

Changing discs during playback

- 1 Press **DISC CHANGE**.
→ The disc tray will open without interrupting playback.
- 2 To change the inner disc, press **DISC CHANGE** again.
→ The active disc will stop playing and the disc tray will close to retrieve the inner disc, then reopen with the inner disc accessible.

Special DVD/VCD features

Changing subtitle language

This operation only works on DVDs with multiple subtitle languages.

- Press **SUBTITLE** to select the desired language.

Changing sound track language

This operation only works on DVDs with multiple audio languages.

- Press **AUDIO** to select the desired language.

For CVD/SVCD/VCD:

- Press **AUDIO** to select the desired audio channels for sound. This function is only available for discs recorded with different channels: LEFT VOCAL → RIGHT VOCAL → MONO LEFT → MONO RIGHT → STEREO

Note:

– If your desired language is not set in the disc, you cannot select the language via this function.

Searching for a particular passage

- 1 Press **◀** or **▶** on the system (or on the remote control) to select fast reverse search or fast forward search respectively.
- 2 Press **◀** or **▶** on the system (or on the remote control) repeatedly to select the required search speed:

For DVD or MP3/WMA

(reverse): FR X2 → FR X4 → FR X6 → FR X8
→ PLAY
(forward): FF X2 → FF X4 → FF X6 → FF X8
→ PLAY

For CVD, SVCD, VCD or CD

(reverse): FR X1 → FR X2 → FR X3 → FR X4
→ PLAY
(forward): FF X1 → FF X2 → FF X3 → FF X4
→ PLAY

- 3 To resume normal play, press **▶||**.

Displaying the disc information during playback

- In disc mode, press **DISPLAY** repeatedly to select the following display information:



Moving to another title (track) / chapter

Some discs may contain more than one title or chapter. If the disc has a title or chapter menu recorded on it, you can start playback from the selected item.

- 1 Press **GOTO** on the remote control to display the message of title and chapter; use **◀** or **▶** to highlight an item.
- 2 Use **numeric keys (0-9)** to select a desired title/chapter number.
- 3 Press **OK** to start playback.

Note:

– Selecting a title or chapter might not be possible on certain discs.

Playing from a selected point

This function allows you to start playback at any chosen time on the disc.

For DVD

- 1 Press **GOTO** twice to activate time menu.
- 2 Enter hours, minutes and seconds from left to right in the time edit box using the **numeric keys (0-9)**.
→ Each time an item has been entered, the next item will be highlighted.
- 3 Press **OK** to start playback.

For CVD, SVCD, VCD or CD

- 4 Press **GOTO** to activate time menu, "GOTO -- : --" will be displayed on the TV screen.
- 5 Enter minutes and seconds from left to right in the time edit box using the **numeric keys (0-9)**.
→ Each time an item has been entered, the next item will be highlighted.
- 6 Press **OK** to start playback.

Notes:

- In repeat disc or repeat all mode, you can search a desired time point.
- This function is not available for MP3/WMA disc.

Some operations can be carried out directly via the menu bar on the TV screen without interrupting disc playback.

- 1 Press **SYSTEM MENU**.
→ The menu bar will be displayed across the top of the TV screen.
- 2 Press **◀** or **▶** to select:
SETUP MENU → SLOW → ZOOM →
ANGLE → STEP → PBC → SPEAKER
SETTING
- 3 Press **▼** to select the highlighted icon and press **▲** / **▼** to select your preferred option.
- 4 Press **OK** to confirm a highlighted selection.
- 5 To exit, press **SYSTEM MENU**.

IMPORTANT!

Some operations may be different or restricted according to the disc format. Refer to the jacket or case of the disc you are playing.

Note:

- When you press a button and  appears on the TV screen, this means the function is not available on the current disc or at the current time.

Playing in slow motion mode



For DVD

- 1 Select  from the menu bar and press **▼** repeatedly to select the required slow motion speed:
SF X 1/2 → SF X 1/4 → SF X 1/8 → SR X 1/2
→ SR X 1/4 → SR X 1/8 → PLAY
SF = slow forward
SR = slow reverse

For CVD, SVCD or VCD

- 1 Press **▼** to select the required slow motion speed:
(forward): SF X 1/1 → SF X 1/2 → SF X 1/3
→ PLAY
- 2 Press **▶||** to cancel the slow function.

Note:

- This function is not available for CD or MP3/WMA disc.

Zooming in

This function allows you to enlarge the picture on the TV screen and pan through the enlarged image.



Disc Operations

- 1 Select from the menu bar and press repeatedly to change the following zooming scale:
ZOOM X1.5 → ZOOM X2 → ZOOM X4
→ ZOOM OFF
- 2 To pan through the enlarged image, press **SYSTEM MENU** to exit and press / / / buttons to move the zoomed picture left, right, up or down.
- 3 To exit **ZOOM** mode, select "ZOOM OFF" from the menu bar.

Viewing from another angle

If the playing DVD disc is recorded with multiple camera angles, the ANGLE mark on the setup page will be set to ON automatically. This allows you to view the picture from different angles. Angle selection is determined by the disc format.



- Select from the menu bar and press / buttons to select the desired angle: 1/4, 2/4, 3/4 or 4/4.
→ Playback changes to the selected angle.

Advancing by frames



- 1 Select from the menu bar and press to play the disc step by step (one frame each step).
- 2 To resume normal play, press .

Note:

– This function is not available for CD or MP3/ WMA disc.

Setting Speaker

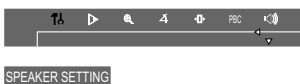

- 1 Select from the menu bar and press to select subwoofer level, rear level, center level or OFF.
- 2 Press **VOL +/-** keys to adjust the speakers' levels from -7dB to +8dB.

Checking the contents of DVD

- 1 Press **DISC MENU** on the remote control.
→ If the current title has a menu, the menu will appear on the screen. Otherwise, the disc menu will be displayed.
- 2 Press / / / to select the desired title or chapter; and then press or **OK**.
→ Playback start from the selected title or chapter.
- 3 Press and hold **DISC MENU** on the remote control to go to root menu of the disc.

Note:

– If no title menu or root menu is recorded in the DVD disc, pressing this button will restart playback from the first track.

Special VCD/SVCD features

Playback control (PBC)

PBC playback allows you to play Video CD interactively, following the menu on the display.

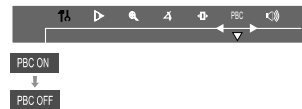

- Select from the menu bar and press to toggle between PBC ON and PBC OFF.

Playing a disc with PBC function

- If PBC OFF, the system will start playback automatically.
- If PBC ON, the PBC menu (if available) will appear on the TV screen for selection. Use the **numeric keys (0-9)** to enter your choice.

Note:

– This function is not available for CD or MP3/ WMA disc.

Playing MP3/WMA/ Picture disc (Kodak, JPEG)

IMPORTANT!

– You have to turn on your TV set and set to the correct Video In channel. (See Setting the TV set.)

MP3/WMA/ JPEG Picture disc

- 1 Load an MP3/WMA/ Picture (JPEG) disc.
→ The disc reading time may exceed 30 seconds due to complexity of the directory/file configuration.
- 2 Playback will start automatically.
→ The album/picture menu will appear on the TV screen. If not, press **DISC MENU** on the remote control.

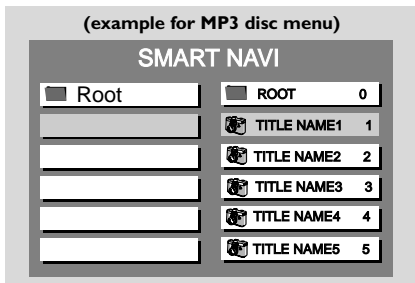

- 3 Press **◀◀ / ▶▶ / ▲ / ▼** on remote control to select a desired album, then press **OK** or **▶▶** to confirm (for MP3/WMA disc only).
- 4 Press **◀◀ / ▶▶ / ▲ / ▼** to select a desired title, then press **OK** or **▶▶** to start playback.
- You can also use the **numeric keys (0-9)** to enter your choice.
- 5 To stop playback, press **■**.
- 6 Press **◀◀** or **▶▶** on the system to select previous/next album.

If the MP3/WMA menu is switched off

- You can only play the current title by pressing **▶▶**. While in playback mode, press **◀◀** or **▶▶** to select the previous/next title.
→ The title number will appear.

Note:

– No album search function in menu off mode.

- 7 During JPEG or Kodak Picture disc playback, press **KEY** repeatedly to select different slideshow view options. There are 12 options for selection. The selected option will be displayed on the TV screen.

Kodak Picture disc

- 1 Load a Kodak Picture disc.
→ The disc reading time may exceed 30 seconds due to complexity of the directory/file configuration.
- 2 Playback will start automatically.
- 3 Press **■**.
→ 9 thumbnail pictures will appear on the TV screen.

(example for picture disc menu)

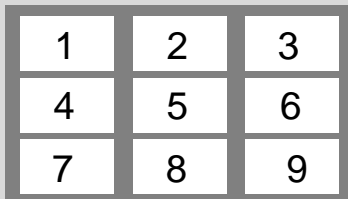

- 4 Press **◀◀** or **▶▶** to view the previous/next page (if available).
- 5 Press **◀◀ / ▶▶ / ▲ / ▼** to move within the menu and press **OK** to select the desired picture to play.
- 6 Press **▶▶** to start the slide-show playback.

During playback, you can:

- Press **◀◀** or **▶▶** to select another title/picture in the current folder.
- Press **◀◀ / ▶▶ / ▲ / ▼** on the remote control to rotate or flip the picture files.
- Select "ZOOM ON" and press **◀◀ / ▶▶** on the system (or press and hold **◀◀ / ▶▶** on the remote control) to zoom the picture in and out.
- Press **▶▶** to pause/resume playback.

MP3/WMA/ DivX/ Picture Disc Operations

Notes:

- Due to the recording nature of Digital Audio MP3 (DAM), only digital audio music will play.
- It is normal to experience an occasional "skip" while you are listening to your MP3 discs.
- For multi-session discs with different formats, only the first session can be read and played.
- DISC MENU does not function during Kodak Picture disc playback.

Playing DivX disc

There are two types of subtitle available on DivX disc: embedded subtitle and external subtitle.

- 1 Load a DivX disc.
→ The DATA CD MENU appears on the TV screen.

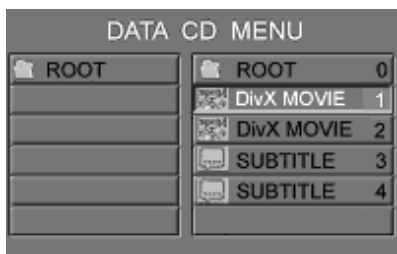



When playing DivX disc with embedded subtitle

- 2 Press ▲ / ▼ to select DivX Movie, and then press **OK** to start playback.
- 3 When playing disc, press **SUBTITLE** button on the remote control to select: SUBTILTE 1/8 → SUBTILTE 2/8 → SUBTILTE 3/8 → SUBTILTE 4/8 → SUBTILTE 5/8 → SUBTILTE 6/8 → SUBTILTE 7/8 → SUBTILTE 8/8 → SUBTILTE OFF.

Note:

- The maximum number of subtitle languages stipulated by the manufacturer is 8/8.

When playing DivX disc with external subtitle

- 4 Press ▲ / ▼ on the remote control to select an external subtitle option .
- 5 Press **SUBTITLE** to select subtitle file .
- "DivX SUBTITLE SELECTED" appears on the TV screen.

- 6 Press ▲ / ▼ to highlight the movie file, and press **OK** to confirm.
→ The playback will start accordingly.
- 7 During playback, you can zoom the picture by selecting zoom icon from the menu bar and press ▼ to select ZOOMX2 or ZOOM OFF.

Notes:

- During playback, press **SUBTITLE** button on remote control to select available font: **SUBTITLE 1/1, ENCODING LATIN 1, ENCODING LATIN 2, ENCODING CYRILLIC, SUBTITLE OFF**.
- If an external subtitle has been selected, the DivX embedded subtitle will be deactivated.
- This model supports **LATIN 1, LATIN 2, and LATIN CYRILLIC** fonts.
- **LATIN 1** font supports the following languages: Albanian, Basque, Catalan, Danish, Dutch, English, Faeroese, Finnish, German, Icelandic, Irish, Italian, Norwegian, Portuguese, Rhaeto-Romanic, Scottish, Spanish, Swedish, Afrikaans and Swahili.
- **LATIN 2** supports the following languages: Bosnian, Croatian, Czech, Hungarian, Polish, Romanian, Serbian, Serbo-Croatian, Slovak, Slovenian, Upper Sorbian and Lower Sorbian.
- **LATIN CYRILLIC** font supports the following languages: Russian, Ukrainian and Belarusian.
- Subtitle files with the following filename extension are supported: **.sub, .srt and .smi**.

Using the menu bar

You can continue some operations directly via the menu bar on the TV screen without interrupting the disc playback. But when you enter **TM** (SETUP MENU), the playback will pause.

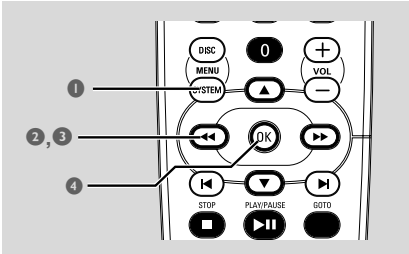

- In disc mode, press **SYSTEM MENU**.
→ The menu bar will appear across the top of the TV set screen.



- Press the **◀▶ / ▲ / ▼** on the remote control to navigate in the menu.
→ Press **◀▶** to move through the menu bar.
→ Press **▼** to enter the selection.
- Press **OK** to confirm the selection.
→ Playback will resume or begin automatically.

To remove the menu

Press **SYSTEM MENU** or **OK**.

IMPORTANT!

– Some operations may be different or restricted according to the disc format. Refer to the jacket or care of the disc you are playing.

	Slow Motion The slow motion speed will display. Press ▼ repeatedly to select a reverse or forward slow motion speed. To cancel the slow function, press ▶▶ .
	ZOOM Press ▼ repeatedly to select an enlarged picture ratio: 1.5, 2 or 4. You can press ◀▶ / ▶▶ / ▲ / ▼ to move within the enlarged picture on the TV set. To resume normal playback, repeat the above step to select ZOOM OFF.
	ANGLE Press ▼ to view the same scene from different angles if the DVD is recorded with multi-angles.
	STEP Press ▼ repeatedly to play forward the disc step by step (one frame every step). To cancel the step function, press ▶▶ .
PBC	PBC Press ▼ to select PBC ON or OFF, and then playback will stop automatically. (This function is not available for CD or MP3 discs.)
	SPEAKER SETTING Press ▼ to select subwoofer level, rear level, center level or OFF cyclically. Press VOL -/+ keys to adjust its' levels from -7dB to +8dB.

DVD Menu Operations

Using the setup menu (user preference settings)

This DVD setup is carried out via your TV set, enabling you to customize the DVD Mini Hi-Fi System to suit your particular requirements.

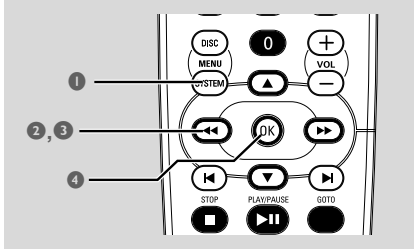

- 1 In disc mode, press **SYSTEM MENU**.
→ The menu bar will appear across the top of the TV screen.
- 2 Select **TV** icon and press **▼** to enter the setup menu. Then press **▲ / ▼** to select one of the setup menu options and press **▶▶** to enter the menu.
→ Playback will pause.

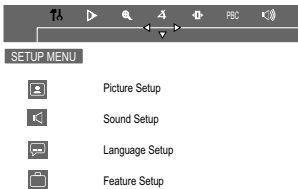

- 3 Press **◀◀ / ▶▶ / ▲ / ▼** on the remote control to navigate in the menu.
- 4 Press **OK** to confirm your selection.
→ Playback will resume or begin automatically.

Removing the menu

Press **SYSTEM MENU** or **OK**.

Note:

– Some features of the Setup Menu are described in “Preparations”.

Setting the TV shape

Make sure the format you need is available on the disc. If not, your setting will be invalid.

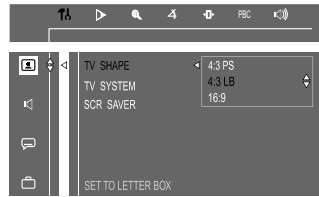

4:3 PS (Pan and Scan mode)

Select this if you have a conventional TV set and your DVD is not formatted for wide screen viewing. A wide picture will display on the whole TV screen with a portion automatically cut off.

4:3 LB (Letterbox mode)

Select this if you have a conventional TV set and your DVD is formatted for wide screen viewing. Black bars appear on the upper and lower portions of the TV screen.

16:9 (Wide-screen TV)

Select this if you have a wide-screen TV set (you must also set your wide screen TV to “full size”).

16:9 (Wide screen)



4:3 LB (Letter Box)



4:3 PS (Pan Scan)



Note:

– Setting the TV shape is only available when the disc is in the stop position.

Setting the screen saver

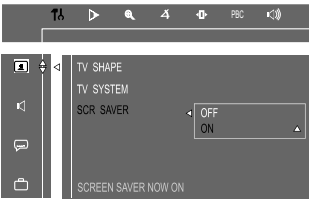

If set to ON, the screen saver will be activated when you leave the system in stop or pause mode for 3 minutes. The default setting is ON.

Setting the digital output

Set Digital Output according to your optional audio equipment connections.

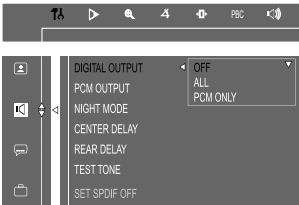

Off

Select this to deactivate the digital output.

All

Select this if you have connected the digital output to a piece of optional audio equipment that has a multichannel decoder.

PCM only

Select this if the external component is capable of processing digital signal input. After that, proceed to "Setting the PCM output".

Setting the PCM output

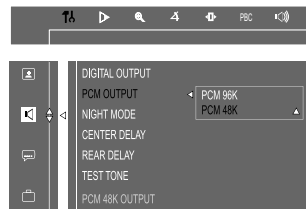

PCM 96K

Select this if the optional audio equipment is capable of processing digital signal input with sampling rate of 96 kHz. However, if the sound output is distorted or there is no sound, select '48 kHz'.

PCM 48K

Select this if the optional audio equipment is incapable of processing 96 kHz digital signal input, then convert to standard signal with sampling rate of 48 kHz.

Note:

– The **PCM OUTPUT** can be selected only when **PCM ONLY** is selected.

Night mode - turning on/off

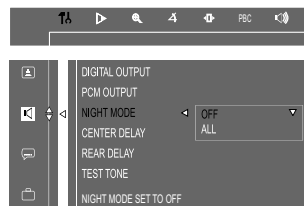

Off

Select this when you want to enjoy the surround sound with its full dynamic range.

On

Select this to level out the volume. High volume output will be softened and low volume output will be brought upward to an audible level. This feature is only available for movies with Dolby Digital mode.

DVD Menu Operations

Test Tone

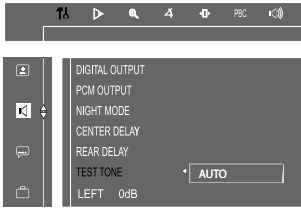

The system will start testing the speaker from left, center, right, right surround, left surround, subwoofer, cyclically until you exit tone test. The availability of the various channels test depend on the number of speakers connected.

Notes:

- You can press **◀◀** to exit test tone mode at any time.
- Main volume can be adjusted during tone test

DivX(R) VOD

Philips provide you the DivX(R) VOD (Video On Demand) registration code that allows you to rent and purchase videos using the DivX(R) VOD service.

For more information, visit:
www.divx.com/vod.



- 1 In disc mode, press **SYSTEM MENU**.
- 2 Select **🔊** icon and press **▼**.
- 3 Press **◀◀** / **▶▶** / **▲** / **▼** on the remote control to navigate in the menu.

→ Move to **📁** icon and press **▶▶**.

→ Move to "DivX (R) VOD"

→ Press OK on the remote control, the registration code will appear:

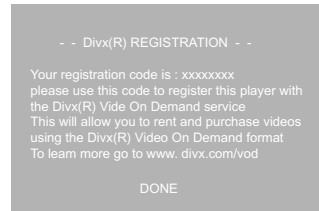

- 4 Use the registration code to purchase or rent the videos from DivX(R) VOD service www.divx.com/vod.

Follow the instruction and download the video onto a CD-R for playback on this system.

Helpful Hint:

-All the download videos DivX(R) VOD can only be played back on this system.

Changing the password

You can change the four-digit code used as Password.

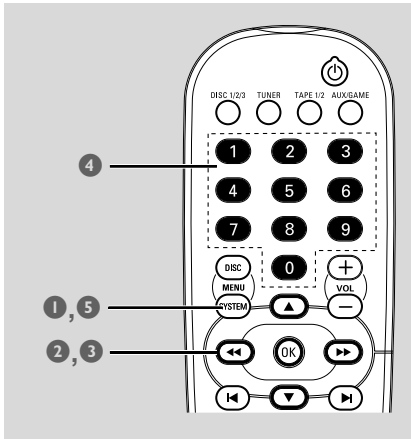

- 1 In disc mode, press **SYSTEM MENU**.
- 2 Select **PA** icon and press **▼**.
- 3 Press **◀ / ▶ / ▲ / ▼** on the remote control to navigate in the menu.
 - Move to **PA** icon and press **▶▶**.
 - Move to "PASSWORD" and press **▶▶**.

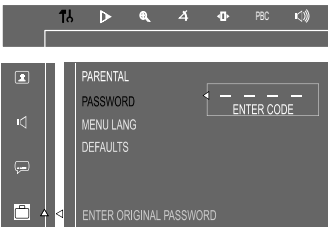

- 4 Use the **numeric keys (0-9)** to enter your four-digit code.
 - The password supplied by default is 1234.
 - If you forget the four-digit code, press **■** four times, the system will change back to the default password.
- Go to "Password" and enter your new code. Then, enter the same code again to confirm.

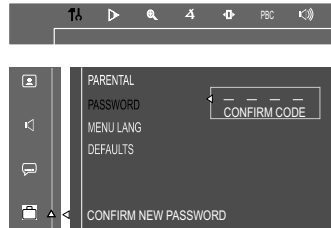

- 5 Press **SYSTEM MENU** again to remove the menu.

DVD Menu Operations

Restricting playback by setting parental level

Some DVDs may have a parental level assigned to the complete disc or to certain scenes on the disc. This feature lets you set a playback limitation level. The rating levels are from 1 to 8 and are country specific. You can prohibit the playing of certain discs that are not suitable for your children or have certain discs played with alternative scenes.

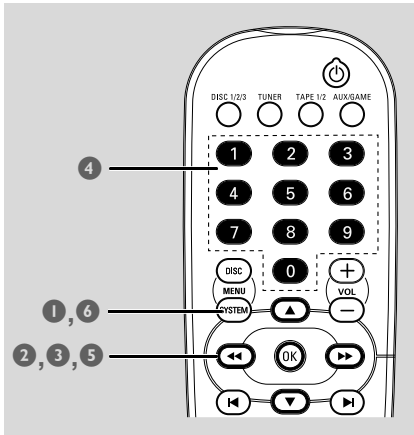

- 1 In disc mode, press **SYSTEM MENU**.
- 2 Select and press **▼**.
- 3 Use **◀ / ▶ / ▲ / ▼** on the remote control to navigate in the menu.
→ Move to and press **▶▶**.
→ Move to "PARENTAL" and press **▶▶**.

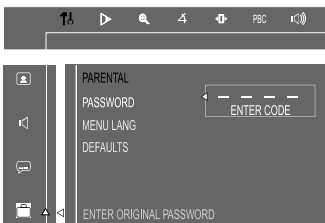

- 4 Use the **numeric keys (0-9)** to enter the four-digit code. You may have to enter the same code twice.
→ If not successful, see Using the Setup Menu - Changing the password.
- 5 Press **▲ / ▼** to select a rating level between 1-8 and press **OK**.
→ DVDs rated above the level you select will not play unless you enter your four-digit password or choose a higher level rating. Select 'No Parental' to deactivate Parental level and have all discs play.

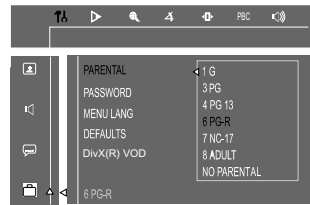

- 6 Press **SYSTEM MENU** again to remove the menu.

Rating explanations

NO PARENTAL – It will play all discs.

8 ADULT – material for adults only; viewed only by adults due to graphic sexual scenes, violence, or language.

7 NC-17 – No children under age 17; not recommended for children under age 17.

6 PG-R – Parental Guidance – Restricted; recommended that parents restrict children under 17 from viewing or allow them to view only when supervised by a parent or adult guardian.

4 PG 13 – Material is unsuitable for children under age 13.

3 PG – Parental Guidance suggested.

1 G – General Audience; recommended as acceptable for viewers of all ages.

– Menu language

To set the screen display language. The default setting is English.

– Default

If RESET is selected, all the items in the setup menu will be reset to default setting, except Parental Setting and Password.

IMPORTANT!

- Make sure **FM** and **MW** antennas are connected.

Tuning to radio stations

- 1 Press **TUNER** to select "FM XX" or "MW XX".
- 2 Press and hold ◀ / ▶ on the system or on the remote control until the frequency indication starts to change, then release.
 - The next radio station will be tuned automatically.
 -  lights up for FM stereo reception.
- 3 To tune a weak station, press ◀ / ▶ on the system or on the remote control to search until a radio station with sufficient signal strength is found.

Presetting radio stations

You can store up to 40 preset radio stations in the memory, starting from FM and followed by MW bands.

Automatic preset programming

You can start automatic presetting from a selected preset number:

- 1 Press **TUNER** (BAND) to select TUNER mode.
 - The current radio frequency will appear on the display.

To begin automatic preset from a desired preset number

- Press ◀ / ▶ or **numeric keys (0-9)** to select the desired preset number.

- 2 Press and hold **PROGRAM** until "AUTO" appears on the display.
 - **PROG** will start to flash.
 - The system will start to search all radio stations on the FM band, then MW band.
 - All radio stations with strong signal strength will be stored automatically.
 - The system will stop searching when all available radio stations are stored or when the memory of 40 preset radio stations is full.
 - The first preset radio station will then be played when completed.

To stop storing the automatic preset

- Press **PROGRAM** on the remote control or  on the system.

Note:

- If no preset number is selected, automatic preset will begin from "0 1" and all your former presets will be overridden.

Tuner Operations

Manual preset programming

- 1 Press **TUNER** (BAND) repeatedly to select the desired tuner band: FM or MW.
- 2 Press and hold ◀◀ / ▶▶ on the system or on the remote control to search a radio frequency.
- 3 Press **PROGRAM**.
→ "PROG" and "0 !" will display.
- 4 Press ◀ / ▶ or **numeric keys (0-9)** to select the desired preset number.
- 5 After selecting an address number, press **PROGRAM** again to store the radio station.
- Repeat **steps 3-5** to store other preset radio stations.

To stop storing the manual preset

- Press ■ on the system.

Note:

– If you attempt to store more than 40 preset radio stations, "FULL" will be displayed.

Selecting a preset radio station

- In tuner mode, press ◀ / ▶ or use the **numeric keys (0-9)** to select the desired preset number.
→ The preset number, radio frequency, and waveband are displayed.

Deleting a preset radio station

- 1 Press ◀ or ▶ to select the preset radio station to be erased.
- 2 Press ■ on the system, "PRESET DELETED" appears on the display.
→ The preset numbers of all other preset radio stations in the band with higher numbers are also decreased by one.
- Repeat **steps 1-2** to erase other preset radio stations.

Changing tuning grid

In some countries, the frequency step between adjacent channels in the MW band is 9 kHz (10 kHz in some areas). The preset frequency step in the factory is 9 kHz.

- 1 Plug the AC power cord.
- 2 Press **TUNER** to select MW mode.
- 3 Press and hold ■ for more than 3 seconds.
→ "STEP xx k" appears.

Note:

– All preset stations will be lost and need to be reprogrammed.

IMPORTANT!

- Before playing a tape, check and tighten slack tape with a pencil. Slack tape may get jammed or may burst in the mechanism.
- Store tapes at room temperature and do not put them too close to a magnetic field (for example, a transformer, TV set or speaker).

Tape playback

- 1 Press ▲ to open the tape deck door.
- 2 Insert a recorded tape and close the tape door.
- 3 Load the tape with the open side down and the full spool to the left.

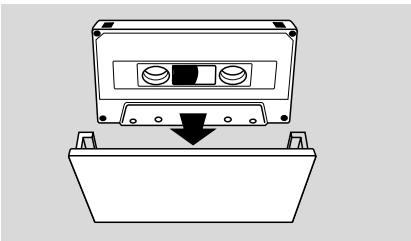

- 3 Press **TAPE** (TAPE 1•2) or **TAPE1/2** on the remote control repeatedly to select tape deck 1 or tape deck 2.
→ The selected tape deck number is displayed.
- 4 Press ►|| to start playback.

Stopping playback

- Press ■.

Changing the playback mode

- Press **AUTO REPLAY** repeatedly to select: ONCE, AUTO REPLAY. The default setting is ONCE.

AUTO REPLAY ... the tape will rewind automatically at the end of playback and replay. It will replay up to max. 10 times or until you press ■.

ONCE the selected side will be played once.

Rewinding or forwarding fast when playback is stopped

- 1 Press ◀◀ or ▶▶ on the front panel or on the remote control.
- 2 Press ■ when you reach the desired passage.

Resetting tape counter number

- In stop mode, press ■.

General information on recording

- If you don't intend to record via the microphone, unplug it to avoid unwanted recording source.
- For recording, only use tape of IEC type I (normal tape).
- The recording level is set automatically, regardless of the position of the Volume, Vocal, Key control and so forth.
- The type is secured at both ends with leader tape. At the beginning and end of the tape, nothing will be recorded for seven seconds.
- To prevent accidental recording, break out the tab on the left shoulder of the tape side you want to protect.

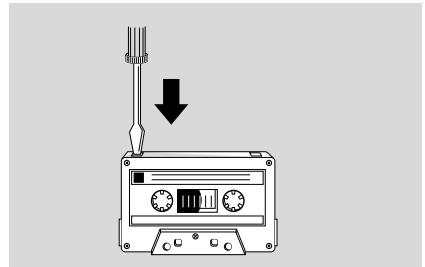

- Press REC in Disc, Tape, Tuner or AUX/Game mode, "CHECK TAPE" will scroll on the display if there is no recordable tape in tape deck 2.

Tape Operation/Recording

IMPORTANT!

- Recording is permissible if copyright or other rights of third parties are not infringed upon.
- Recording is possible only in tape deck 2.

Preparation for recording

- 1 Load a recordable tape into tape deck 2 with the full spool to the left.
- 2 Prepare the source to be recorded.
DISC – load the disc(s)
TUNER – tune to the desired radio station.
TAPE – load the prerecorded tape into tape deck 1 with the full spool to the left.
AUX/GAME – connect external equipment.

When recording is in progress

- 1 Press **DISC, TAPE, TUNER** or **AUX/GAME** to select the source.
- 2 Start to play the selected source.
- 3 Press **REC** to start recording.

To stop recording

- Press **■** on the system.

Disc synchro recording

- 1 Press **DISC** to select the disc.
- You can record programmed tracks in the order you want.
- 2 Press **REC** to start recording.
→ "REC" will flash, but the first 7 seconds of the start passage will not be recorded.

Selecting another track during recording

- 1 Press **▶II**.
- 2 Press **I◀** or **▶I** to select another track.

To stop recording

- Press **■**.
→ Recording and disc playback will stop simultaneously.

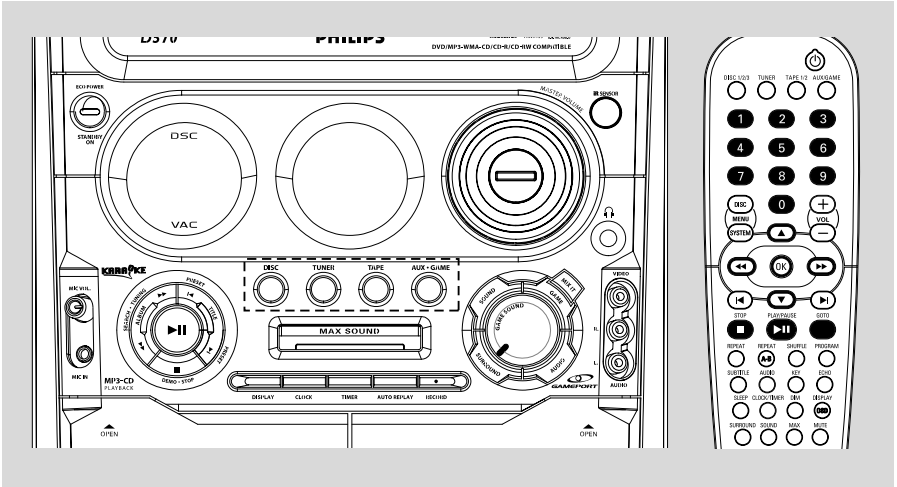

Viewing the clock

The clock (if it is set) will be shown in Standby mode. Press **CLOCK** on the system to view clock in any source mode (or press **CLOCK/TIMER** on the remote control).

- Press **DISPLAY** on the system to select 12-hour or 24-hour mode.
 - If the clock has not been set, "--:--" will blink until you set the clock.
- Setting the clock - see page 19.

Setting the timer

The system can switch to DISC, TUNER, TAPE mode automatically at a preset time, serving as an alarm to wake you up.

IMPORTANT !

- Before setting the timer, ensure that the clock is set correctly.
- The timer will always be switched on once set.
- The timer will not start if a recording is in progress.
- The volume of the timer will increase gradually from the minimum level to the last tuned volume level.
- The time can be set in 24-hour mode.

- 1 Press and hold **TIMER** or **CLOCK/TIMER** for more than 3 seconds,
 - **TIMER**  will start to flash.

→ The selected source will be displayed.

- 2 Press **DISC, TUNER or TAPE (1/2)** to select timer mode. The corresponding source will appear on the display.

DISC - load the disc.

TUNER - Tune to the desired radio station.

TAPE 1 - Load the prerecorded tape into tape deck 1.

- 3 Press **◀** or **▶** on the system or remote control to set hours .
- 4 Press **◀◀** or **▶▶** on the system or remote control to set the minutes.

- 5 Press **TIMER** or **CLOCK/TIMER** to store the setting.

→ "TIMER ON" will be displayed for 3 seconds.

→ The timer will start to work.

→ The timer will always be switched on once it has been set.

Timer Operations

To exit without storing the setting

- Press **■** on the system.

To deactivate the timer

- Press and hold **TIMER** or **CLOCK/TIMER** for more than 3 seconds.
- "TIMER OFF" will be displayed.

Notes:

- If the source is disc mode, playback will begin with the first track of the last selected disc or other trays if the disc is empty. If all disc trays are empty, the system will automatically switch to Tuner mode.
- During timer setting, if no button is pressed within 10 seconds, the system will exit timer setting mode automatically.
- When the system is powered on, if the memorized volume level is less than 8, the system will automatically adjust to 8 increasing. If the memorized volume level is more than 20, the system will adjust to 20.
- The timer will be cancelled when the power cord is disconnected or if a power failure occurs.

Viewing the timer

- 1 Press **TIMER** on the system (or press **CLOCK/TIMER** on the remote control twice) to view timer in any source mode. Timer will be shown on the display for 5 seconds and then go back to its previous status.
- 2 If timer have not been set, "NO TIMER" will be displayed for 5 seconds.

Setting the sleep timer

The sleep timer enables the system to switch to Standby mode automatically at a preset time.

- Press **SLEEP** on the remote control repeatedly and stop at the desired preset turn-off time.
→ Following options are available (time in minutes):
15 → 30 → 45 → 60 → 90 → 120 → OFF
→
- "SLEEP" will show on the display panel unless "OFF" is selected.

To check or change the setting

- Press **SLEEP** once to show the remaining time before switching off. If you continue pressing the SLEEP button, the next Sleep Timer option will appear on the display.

To cancel the sleep timer

- Press **SLEEP** repeatedly until "OFF" is displayed, or press the **ECO POWER/ STANDBY ON** button.

Sound control

Selecting surround sound

IMPORTANT!

– This DVD Mini HiFi system can only produce 2.1 channel surround sound.

- Press **SURROUND** on the system or on remote control to select surround or stereo mode.
→ The availability of the various surround sound modes (Dolby Digital Surround and DTS Surround) depend on the number of speakers used and the incoming sound information available on the disc.

Notes:

- The default is Stereo.
- You cannot select the **SURROUND SOUND** mode if the **SYSTEM MENU** is turned on.

MAX sound

MAX sound provides the best mixture of various sound features.

- Press **MAX SOUND** to achieve the optimal sound.
→ When **MAX SOUND** is activated, **MAX SOUND** will blink and "MAX ON" will appear on the display for 3 seconds.

Note:

- When **MAX SOUND** is selected, other sound modes will be switched off automatically.

Selecting sound effect

The digital sound effect allows you to select from various preset modes that control the frequency bands of sound to optimize certain musical styles. It greatly enhances the excitement and enjoyment of your favorite music.

- Press **SOUND** repeatedly to select the available sound effect.

Playing a DVD/VCD

- You can select Virtual Ambience Control as follows:
 - CONCERT, ACTION, SCI-FI, DRAMA.

Playing a CD/MP3/WMA/Divx or in TUNER, TAPE or AUX mode

- You can select Digital Sound Control:
 - DIGITAL, CLASSIC, ROCK, JAZZ.

Volume control

Changing the volume level

- Rotate **VOLUME** clockwise / anti-clockwise (or press **VOL +/-**) to increase or decrease the volume level.
→ "VOL XXX" is displayed.
→ "VOL MAX" is displayed at maximum level.
- Press **VOL +/-** to adjust the level of the subwoofer; rear or center speaker during speaker setting carried out via system menu.
→ The range is from -7dB to +8dB.

Notes:

- The above operations are valid only if you have 5.1 speaker connection.
- You can press these buttons to adjust the speakers' levels during speaker setting.

Switching off the volume temporarily

- Press **MUTE**.
→ "MUTE ON" is displayed.
Press **MUTE** again or increase the volume level to cancel the MUTE mode.

Listening through headphones

Connecting headphones to  will switch off the speakers. The system will switch STEREO and the surround sound will be reduced to a stereo signal which is reproducible by standard headphones.

Disconnecting the headphones will switch on the speakers again. If you wish to enjoy surround sound again, switch the system back to surround sound.

Other Functions

Switching on/off

Switching the system ON

In ECO Power/ Standby/ Demonstration mode

- Press **ECO POWER/ STANDBY ON**
→ The system will go back to its previous status.
- Press **DISC, TUNER, TAPE, AUX/GAME**
→ The system will switch to the selected source.

Switching the system to STANDBY mode

In demonstration mode

- Press and hold **DEMO•STOP** ■ on the system.

In any other source mode

- Press and hold **ECO POWER/ STANDBY ON** (or  on the remote control).
→ The time will appear on the display when the system is in Standby mode.

Switching to ECO POWER mode

- Press **ECO POWER/ STANDBY ON** to ECO POWER mode.
→ "ECO POWER" will be shown for 3 seconds and scroll from left to right on the display.
→ The system will go to standby mode, and then to ECO Power mode in 5 seconds.

Power saving automatic standby

As a power-saving feature, the system will automatically switch to Standby mode if you don't press any button within 30 minutes in the stop mode.

Dimming the display

- Press **DIM** repeatedly to select different levels of brightness for the display: HIGH, MID or LOW.

Vocal

This function allows you to fade out the original vocal from a karaoke. Press AUDIO key to select different audio modes.

For DVD karaoke discs:

AUDIO 1, AUDIO 2, AUDIO 1 VOCAL, AUDIO 2 VOCAL.

For VCD karaoke discs:

LEFT VOCAL, RIGHT VOCAL, MONO LEFT, MONO RIGHT or STEREO.

Key control

This feature allows you to change the key tone when you play a DVD or VCD disc.

- Press **KEY**.
→ "KEY CONTROL ON" will be display on the TV screen for 5 seconds.
→ The Key Control indicator will flash when you press **VOL +/-** to change the key tone level.
→ If you don't adjust the key control level within 5 seconds, the indicator will turn off.
- Press **KEY** again to exit key control mode.
→ "KEY CONTROL OFF" will be displayed on the TV screen for 5 seconds.

Echo

This feature allows you to add echo while singing or talking through a microphone.

- Press **ECHO**.
→ "ECHO CONTROL ON" will be display on the TV screen for 5 seconds.
→ Press **VOL +/-** to change the echo level between 1 and 8.
- Select OFF to switch off Echo.
- Press **ECHO** again to exit ECHO CONTROL mode.
→ "ECHO CONTROL OFF" will be displayed on the TV screen for 5 seconds.
- You can also press OK to exit ECHO CONTROL mode.

Notes:

- Echo will be disabled automatically when the microphone is unplugged.
- "PLEASE INSERT MIC" is displayed on your TV screen if you have not connected the microphone to the system in ECHO CONTROL ON mode.

Karaoke

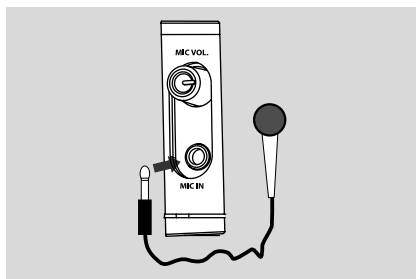

Connect a microphone (not supplied) to the system to sing along with the music source.

- 1 Connect a microphone to the MIC jack.
→ "MIC" will appear on the display.
→ "MICROPHONE PLUG IN" will display on your TV screen.
- Before connecting the microphone, set the microphone **LEVEL** to the minimum level to prevent howling.
- 2 Press **DISC (1/2/3)**, **TUNER, TAPE(1/2)** or **AUX/GAME** to select the source to be mixed and start playback.
- 3 Adjust the volume of the source through VOLUME control.
- 4 Adjust the microphone volume through microphone **LEVEL** control.

Notes:

- Keep the microphone away from the speakers to prevent howling.
- "MICROPHONE PLUG OUT" will display on your TV screen when you plug out the microphone.

Listening to external sources

- 1 Connect the audio out terminals of the external equipment (TV, VCR, Laser Disc player, DVD player or CD Recorder) to the AUX IN terminals of your system.
- 2 Press **AUX/GAME** repeatedly to select AUX mode directly.
→ "AUX" or "GAMEPORT" will be displayed.

Notes:

- You are advised not to listen to and record from the same source simultaneously.
- All navigation sound control features are available.

Specifications

AMPLIFIER SECTION

Output power	3300 W PMPO
Stereo mode (DIN)	100 W + 100 W RMS
Surround mode (1 kHz)	DIN OUT
Frequency Response .	180 Hz - 14 kHz / \pm 3 dB
Signal-to-Noise Ratio	> 62dB (A-weighted)
Input Sensitivity	
AUX/TV In	500 mV
Output Sensitivity	
Headphone	800 mV – 1100 mV
Line Out	400 mV – 600 mV

TUNER SECTION

Tuning Range	
..... FM	87.5 – 108 MHz (50 kHz steps)
..... MW	531 – 1602 kHz (9 kHz steps)
..... MW	530 – 1710 kHz (10 kHz steps)
26 dB Quieting Sensitivity	FM 20 dB
26 dB Quieting Sensitivity	MW 3162 mV/m
Image Rejection Ratio	FM 25dB
.....	MW 28 dB
IF Rejection Ratio	FM 60 dB
.....	MW 24 dB
Signal-to-Noise Ratio	FM \geq 55 dB
.....	MW \geq 35 dB
MW Suppression Ratio	FM 30 dB
Harmonic Distortion	FM Mono 3 %
.....	FM Stereo 3 %
.....	MW 5 %
Frequency Response	
.....	FM 180 Hz – 10 kHz / \pm 6 dB
Stereo Separation	FM 26 dB (1 kHz)
Stereo Threshold	FM 23.5 dB

TAPE SECTION

Frequency Response	
Normal tape (type 1) ..	80 – 12500 Hz (8 dB)
Signal-to-Noise Ratio	
Normal tape (type 1) ..	\geq 46 dBA
Wow and flutter	\leq 0.4% DIN

DVD SECTION

Laser Type	Semiconductor
Disc Diameter	12cm / 8cm
Video Decoding	MPEG-2 / MPEG-1
Video DAC	10 Bits
Signal System	PAL / NTSC
Video Format	4:3 / 16:9
Video S/N	56 dB (minimum)
Composite Video Output	1.0 Vp-p, 75 Ω
S-Video Output	Y - 1.0 Vp-p, 75 Ω
.....	C - 0.286 Vp-p, 75 Ω
Audio DAC	24 Bits / 96 kHz
Frequency Response	4 Hz - 20 kHz (44.1kHz)
.....	4 Hz - 22 kHz (48kHz)
.....	4 Hz - 44 kHz (96kHz)
Digital Output	
.....	SPDIF (Sony Philips digital interface) Coaxial
PCM	IEC 60958
Dolby Digital/DTS	IEC 60958, IEC 61937

MAIN UNIT

Power Supply Rating	110 - 127 / 220 - 240 V
.....	50/60HZ Switchable
Power Consumption	
Active	110 W
ECO Power Standby	<1 W
Dimensions (w x h x d) .	265x 322 x 354 (mm)
Weight	5.7 kg

SPEAKERS

Front speakers	
System	3-way, Bass reflex
Impedance	3 Ω
Speaker drivers	6.5" woofer;
.....	2" tweeter
Frequency response	50 Hz – 20 kHz
Dimensions (w x h x d)	
.....	242 x 310 x 240 (mm)
Weight	3.72 kg/each

Specifications and external appearance are subject to change without notice.

WARNING

Under no circumstances should you try to repair the system yourself, as this will invalidate the warranty. Do not open the system as there is a risk of electric shock.

If a fault occurs, first check the points listed below before taking the system for repair. If you are unable to remedy a problem by following these hints, consult your dealer or Philips for help.

Problem	Solution
No power.	<ul style="list-style-type: none"> ✓ Check if the AC power cord is properly connected.
"NO DISC" is displayed.	<ul style="list-style-type: none"> ✓ Check if the disc is inserted upside down. ✓ Wait until the moisture condensed at the lens has cleared. ✓ Replace or clean the disc, see "Maintenance". ✓ Use a readable disc or correctly recorded format MP3-CD.
No picture.	<ul style="list-style-type: none"> ✓ Select the appropriate video input mode on the TV set. ✓ Check if the TV set is switched on. ✓ Check the video connection. ✓ Check if the system is securely connected.
Distorted or poor picture.	<ul style="list-style-type: none"> ✓ Sometimes a slight picture distortion may appear. This is not a malfunction. ✓ Clean the disc. ✓ Connect the system to the S-video input of your TV set.
The aspect ratio of the screen cannot be changed even though you have set the TV shape.	<ul style="list-style-type: none"> ✓ The aspect ratio is fixed on the DVD disc. ✓ The aspect ratio may not be changed for some TV systems.
The DVD player does not start playback.	<ul style="list-style-type: none"> ✓ Insert a readable disc. ✓ Check the disc type, color system and region code. ✓ Clean the disc. ✓ Place the disc with the playback side down. ✓ Press SYSTEM MENU to turn off the setup menu. ✓ Cancel the parental control rating function or change the rating level. ✓ Moisture has condensed inside the system. Remove the disc and leave the system turned on for about an hour.
The system does not respond when the buttons are pressed.	<ul style="list-style-type: none"> ✓ Disconnect the power plug from the jack, and insert again.

Troubleshooting

Problem	Solution
The language for the sound or subtitle cannot be changed when playing a DVD.	<ul style="list-style-type: none">✓ Multi-language sound or subtitle is not recorded on the DVD.✓ Changing the language for the sound or subtitle is prohibited on the DVD.
No image is output when a function is selected.	<ul style="list-style-type: none">✓ Make sure the component is connected correctly.✓ Press the correct function button for the input source.
Sound cannot be heard or is of poor quality	<ul style="list-style-type: none">✓ Adjust the volume.✓ Disconnect the headphones.✓ Check that the speakers are connected correctly.✓ Check if the stripped speaker wire is clamped.✓ If the system is in pause, slow motion or fast forward/reverse mode, press ► to resume the normal play mode.✓ Make sure the MP3-CD was recorded within 32-256 kbps bit rate with sampling frequencies at 48 kHz, 44.1 kHz or 32 kHz.
Poor radio reception.	<ul style="list-style-type: none">✓ If the signal is too weak, adjust the antenna or connect an external antenna for better reception.✓ Increase the distance between the System and your-TV set or VCR.
Recording or playback cannot be made	<ul style="list-style-type: none">✓ Clean deck parts, see "Maintenance".✓ Use only NORMAL tape.✓ Apply a piece of adhesive tape over the missing tab space.
The tape deck door cannot open	<ul style="list-style-type: none">✓ Remove and reconnect the AC power plug and switch on the system again.
Left and right sound outputs are reversed.	<ul style="list-style-type: none">✓ Check the speaker connections and location.
The remote control does not function.	<ul style="list-style-type: none">✓ Point the remote control at the remote control sensor of the unit.✓ Reduce the distance to the player.✓ Remove any possible obstacles.✓ Replace the batteries with new ones.✓ Check that the batteries are loaded correctly.
The display is dark	<ul style="list-style-type: none">✓ Press DIM again.
The timer is not working	<ul style="list-style-type: none">✓ Set the clock correctly.✓ If recording is in progress, stop it
The Clock/Timer setting is erased	<ul style="list-style-type: none">✓ Power has been interrupted or the power cord has been disconnected. Reset the clock/timer:

Analog: Sound that has not been turned into numbers. Analog sound varies, while digital sound has specific numerical values. These jacks send audio through two channels, the left and right.

Aspect ratio: The ratio of vertical and horizontal sizes of a displayed image. The horizontal vs. vertical ratio of conventional TVs is 4:3, and that of wide-screens is 16:9.

AUDIO OUT Jacks: Jacks on the back of the DVD System that send audio to another system (TV set, Stereo, etc.).

Bit Rate: The amount of data used to hold a given length of music; measured in kilobits per second, or kbps. Or, the speed at which you record. Generally, the higher the bit rate better the sound quality. However, higher bit rates use more space on a Disc.

Chapter: Sections of a picture or a music piece on a DVD that are smaller than titles. A title is composed of several chapters. Each chapter is assigned a chapter number enabling you to locate the chapter you want.

Component Video Out Jacks: Jacks on the back of the DVD System that sends high-quality video to a TV set that has Component Video In jacks (R/G/B, Y/Pb/Pr, etc.).

Disc menu: A screen display prepared for the selection of images, sound, subtitles, multi-angles, etc recorded on a DVD.

Digital: Sound that has been converted into numerical values. Digital sound is available when you use the DIGITAL AUDIO OUT COAXIAL or OPTICAL jacks. These jacks send audio through multiple channels, instead of just two channels as analog does.

Dolby Digital: A surround sound system developed by Dolby Laboratories containing up to six channels of digital audio (front left and right, surround left and right and center).

DTS: Digital Theater Systems. This is a surround sound system, but different from Dolby Digital. The formats were developed by different companies.

JPEG: A still-picture data compression system proposed by the Joint Photographic Expert Group, which features small decrease in image quality in spite of its high compression ratio.

MP3: A file format with a sound data compression system, "MPE" is the abbreviation of Motion Picture Experts Group 1 (or MPEG-1) Audio Layer 3. Through the MP3 format, one CD-R or CD-RW can contain about 10 times as much data volume as a regular CD can.

Multichannel: DVD is specified to have all sound tracks constitute one sound field. Multichannel refers to a structure of sound tracks having three or more channels.

Parental control: A function of the DVD to limit playback of the disc by the age of the users according to the limitation level in each country. The limitation varies from disc to disc; when it is activated, playback will be prohibited if the software's level is higher than the user-set level.

PCM (Pulse Code Modulation): A system for converting analog sound signal to digital signal for later processing without data compression.

Playback control (PBC): Refers to the signal recorded on video CDs or SVCDs for reproduction control. By using screen menu recorded on a Video CD or SVCD that supports PBC, you can enjoy interactive-type software as well as software having a search function.

Region code: A system allowing discs to be played only in preset regions. This unit will only play discs that have compatible region codes. You can find the region code of your unit from the product label. Some discs are compatible with more than one region (or ALL regions).

S-Video: Produces a clear picture by sending separate signals for luminance and the color. You can use S-Video only if your TV set has S-Video In jack.

Sampling Frequency: Frequency of data sampling when analog data is converted to digital data. Sampling frequency numerically represents how many times the original analog signal is sampled per second.

Surround: A system for users to create realistic three-dimensional sound fields full of realism by arranging multiple speakers around the listener.

Title: The longest section of a picture or music feature on DVD, music, etc., in video software, or the entire album in audio software. Each title is assigned a title number enabling you to locate the title you want.

VIDEO OUT jack: Jack on the back of the DVD System that sends video to TV.