

OPTIMUS®

16-3898

Digital Camera

Thank you for purchasing your
Optimus Digital Camera from
RadioShack.



WHAT'S IN THIS PACKAGE

Digital Camera, Camera Strap, User's Guide (in the Software CD), Quick Start Guide, Software CD-ROM, USB Cable, Camera Pouch, Lithium ion rechargeable battery (650mA), AC adapter

Please read this user's guide before installing, setting up and using your new product.

FCC STATEMENT

This equipment has been tested and found to comply with the limits for Class B digital devices, pursuant to Part 15 of the FCC rules. These limits are designed to provide reasonable protection against harmful interference in a residential installation. This equipment generates uses and can radiate radio frequency energy and, if not installed and used in accordance with the instructions, may cause harmful interference to radio communications. However, there is no guarantee that interference will not occur in a particular installation. If this equipment does cause harmful interference to radio or television reception, which can be determined by turning the equipment off and on, the user is encouraged to try to correct the interference by one or more of the following measures:

- Reorient or relocate the receiving antenna.
- Increase the separation between the equipment and receiver.
- Connect the equipment into an outlet on a circuit different from that to which the receiver is connected.
- Consult the dealer or an experienced radio/TV technician for help.

FCC Declaration of Conformity

This device complies with Part 15 of the FCC Rules. Operation is subject to the following two conditions:

- (1) This device may not cause harmful interference, and
- (2) This device must accept any interference received, including interference that may cause undesired operation.



Product	Digital Camera
Model	16-3898
Responsible Party	RadioShack Corporation 300 RadioShack Circle Fort Worth, TX 76102
Phone	817-415-3200

Use of shielded cable is required to comply with Class B limits in Subpart B of Part 15 of the FCC rules.

Do not make any changes or modifications to the equipment unless otherwise specified in the user's guide. If such changes or modifications should be made, you could be required to stop operation of the equipment.

READ THIS FIRST

Trademark Information

- Microsoft® and Windows® are U.S. registered trademarks of Microsoft Corporation.
- Pentium® is a registered trademark of Intel Corporation.
- Macintosh is a trademark of Apple Computer, Inc.
- SD™ is a trademark.
- Photo Explorer and Photo Express are trademarks.
- Other names and products may be trademarks or registered trademarks of their respective owners.

Product Information

- Product design and specifications are subject to change without notice. This includes primary product specifications, software, software drivers, and user's guide. This User's Guide is a general reference guide for the product.
- The product and accessories that come with your digital camera may be different from those described in this guide. This is due to the fact that different retailers often specify slightly different product inclusions and accessories to suit their market requirements, customer demographics, and geographical preferences. Products vary often vary between retailers especially with accessories such as batteries, chargers, AC adapters, memory cards, cables, carrying cases/pouches, and language support. Occasionally a retailer will specify a unique product color, appearance, and internal memory capacity. Contact your dealer for precise product definition and included accessories.
- The illustrations in this guide are for the purpose of explanation and may differ from the actual design of your digital camera.
- The manufacturer assumes no liability for any errors or discrepancies in this user's guide.
- For user's guide and driver updates, refer to our website or contact your dealer.

SAFETY INSTRUCTIONS

Read and understand all **Warnings** and **Cautions** before using this product.

Warnings

If foreign objects or water have entered the camera, turn power OFF and remove the batteries.

Continued use in this state might cause fire or electric shock. Consult the store of purchase.



If the camera has fallen or its case has been damaged, turn power OFF and remove the batteries.

Continued use in this state might cause fire or electric shock. Consult with the store of purchase.



Do not disassemble, change or repair the camera.

This might cause fire or electric shock. For repair or internal inspection, ask the store of purchase.



Do not use the camera in areas near water.

This might cause fire or electric shock. Take special care during rain, snow, on the beach, or near the shore.



Do not place the camera on inclined or unstable surfaces.

This might cause the camera to fall or tilt over, causing injury.



Keep the batteries out of the reach of children.

Swallowing batteries might cause poisoning. If the battery is accidentally swallowed, immediately consult with a physician.



Do not use the camera while you are walking, driving or riding a motorcycle.

This might cause you to fall over or result in traffic accident.



Cautions

Insert the batteries paying attention to the polarity (+ or –) of the terminals.

Inserting the batteries with incorrect polarities might cause fire and injury, or damage to the surrounding areas due to the battery rupturing or leaking.



Do not fire the flash close to anyone's eyes.

This might cause damage to the person's eyesight.



Do not subject the LCD monitor to impact.

This might damage the glass on the screen or cause the internal fluid to leak. If the internal fluid enters your eyes or comes into contact with your body or clothes, rinse with fresh water. If the internal fluid has entered your eyes, consult a physician.



A camera is a precision instrument. Do not drop it, strike it or use excessive force when handling the camera.

This might cause damage to the camera.



Do not use the camera in humid, steamy, smoky, or dusty places.

This might cause fire or electric shock.



Do not remove the battery immediately after long period of continuous use.

The battery becomes hot during use. Touching a hot battery might cause burns.



Do not wrap the camera or place it in cloth or blankets.

This might cause heat to build up and deform the case, resulting in fire. Use the camera in a well-ventilated place.



Do not leave the camera in places where temperature may rise significantly, such as inside a car.

This might adversely affect the case or the parts inside.



Before you move the camera, disconnect cords and cables.

Failure to do this might damage cords and cables, resulting in fire and electric shock.



Notes on Battery Usage

When you use the battery, carefully read and strictly observe the ***Safety Instructions*** and the notes below:

- Different battery types and surrounding temperatures may affect the battery performance.
- Avoid using batteries in extremely cold environments. Low temperatures can shorten the battery life and impair camera performance.
- Using a new rechargeable battery or rechargeable battery that has not been used for an extended period of time (the battery that passed the expiry date is an exception) might affect the number of pictures that can be taken. Therefore, to maximize its performance and lifetime, we recommend that you fully charge the battery and discharge it for at least one complete cycle before use.
- The battery may become warm after long period of continuous use of the camera or the flash. This is normal and not a malfunction.
- The camera may become warm after a long period of continuous use. This is normal and not a malfunction.
- If the battery is not to be used for a long period of time, remove it from the camera to prevent leakage or corrosion.
- If the battery is not to be used for a long period of time, store it after no battery power left. If the battery is stored for a long time in a fully charged state, its performance may be impaired.
- Always keep the battery terminals clean.
- Risk of explosion if battery is replaced by an incorrect type.
- Dispose of used batteries according to the recycle instructions.

CONTENTS

INTRODUCTION.....	9	SELECTING PHOTOGRAPHY MODE.....	35
Overview.....	9	Auto Mode.....	35
Package Contents.....	10	Sports Mode.....	36
Optional Accessories.....	10	Night Scene Mode.....	37
COMPONENTS GUIDE.....	11	Portrait Mode.....	38
Front View.....	11	Landscape Mode.....	39
Rear view.....	12	Backlight Mode.....	40
LED Indicators.....	13	MOVIE MODE.....	41
Scene Modes.....	14	IMAGE PLAYBACK.....	42
LCD Monitor Information.....	15	Single Image Playback.....	42
PREPARING YOUR CAMERA.....	20	Magnifying Images.....	43
Installing the Battery.....	20	Viewing Nine Thumbnail Images at a Time....	44
Charging the Battery.....	21	Viewing Video Clips.....	45
Loading an SD Memory Card (Optional Accessory).....	22	Automated Playback (Slide Show).....	45
Setting Date and Time.....	23	Protecting Images.....	46
Choosing Language.....	23	DELETING IMAGES.....	47
Attaching the Camera Strap.....	24	Deleting Single Image/Video Clip	47
BASIC FUNCTIONS.....	25	Deleting All Images/Video Clips.....	48
Turning Power On/Off.....	25	Formatting an SD Memory Card or Internal Memory.....	49
Using the LCD Monitor.....	26	SETTING DPOF.....	50
Using Normal Mode.....	27	TRANSFERRING RECORDED IMAGES/VIDEO CLIPS TO YOUR COMPUTER.....	51
Using Zoom.....	28	Step 1: Install the USB Driver.....	52
Using the Flash.....	29	Step 2: Connect the Camera to Your Computer.....	53
Using Self-Timer.....	31		
Using Macro Mode.....	32		
Setting Image Resolution and Quality.....	33		

Step 3: Download the Recorded Images/Video Clips.....	54
---	----

SOFTWARE INSTALLATION.....	55
Installing the Photo Explorer.....	55
Installing the Photo Express.....	56

USING THE DIGITAL CAMERA AS A PC

CAMERA.....	57
Step 1: Install the PC camera driver.....	57
Step 2: Connect the digital camera to your computer.....	58
Step 3: Run your videoconferencing application software (i.e. Windows NetMeeting).....	58

LIST OF MENU OPTIONS.....	59
Capture Menu.....	59
Playback Menu.....	65
Video Menu.....	66
Setup Menu (in Capture/Video/Playback Menu)....	67

CAMERA SPECIFICATIONS.....	69
-----------------------------------	-----------

TROUBLESHOOTING.....	70
-----------------------------	-----------

INTRODUCTION

Overview

Your stylish new digital camera delivers high quality, 2560 x 1920 resolution images using a 5.0 Megapixels CCD sensor. Using the 2.0" TFT color image LCD monitor, you can compose images and then examine them in detail. The auto-flash sensor automatically detects the shooting (lighting) conditions and determines whether the flash should be used. This feature ensures your images turn out right.

16 MB internal memory (14 MB available for image storage) lets you capture and store images without memory card. However, you may wish to expand the memory capacity using an external memory card.

In addition to still images, you can record short videos using the movie function.

Images you have taken can be downloaded to your computer using the USB cable. You can enhance and retouch your images on your computer by using the provided editing software, or image editing software you already have. You may share your images with your friends via e-mail, in a report, or on a website.

DPOF (Digital Print Order Format) functionality allows you to print your images on a DPOF compatible printer by simply inserting the memory card.

Package Contents

Your digital camera includes following:

- Digital Camera
- User's Guide (in the software CD)
- Quick Start Guide
- USB Cable
- Lithium ion rechargeable battery (650mA)
- Camera Strap
- Software CD-ROM
- Camera Pouch
- AC adapter

Optional Accessories

- SD Memory Card

COMPONENTS GUIDE

Front View

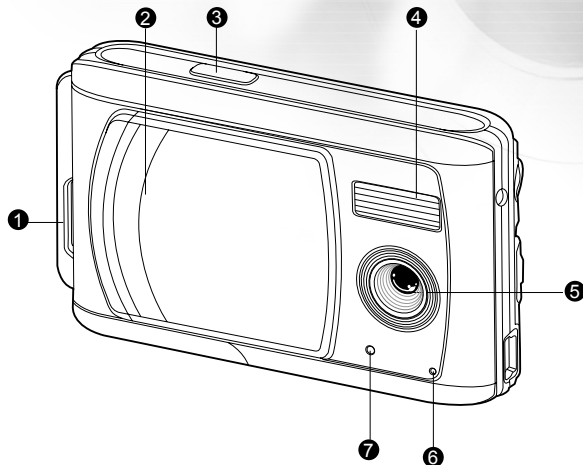

1. Strap eyelet

2. Lens cover (and On/Off
Switch)

3. Shutter button

4. Flash

5. Lens

6. Microphone

7. Self-timer LED

Rear view

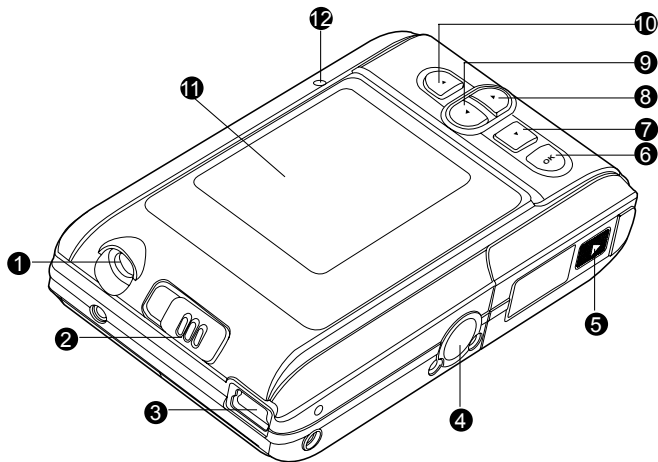

- 1. DC IN 5V socket
- 2. Focus switch
 - ▼ Macro mode
 - ▲ Normal mode
- 3. USB socket
- 4. Tripod socket
- 5. Battery/SD card compartment
- 6. **OK** button
 - Q Zoom button

- 7. ▼ (Down)
MODE button
- 8. ► (Right)
⚡ Flash button
- 9. ◀ (Left)
⌚ Self-timer button
- 10. ▲ (Up)
MENU button
- 11. LCD monitor
- 12. Status LED







LED Indicators

Indicator	Status	Description/Activity	Sound
Status LED	None	The camera is powering up	Yes*(1)
Status LED	Solid green	The camera is powered and ready	No
Status LED	Blinking green	Charging the flash	No
Status LED	Blinking green	Image is being recorded to the memory card	No
Status LED	Solid green	USB communication/data transfer in progress	No
Status LED	Solid green	The camera is ready to record images (or movies)	Yes*(1)
Self-timer LED	Blinking red	The self-timer function is activated	Yes*(Sec)
----	----	Button event	Yes*(1)

- (1) The camera sounds one beep.
- (Sec) The self-timer sounds 10 beeps for 10 seconds, 5 beeps for 5 seconds.

Scene Modes





Select the scene mode suitable for the occasion or situation.

Mode	Description
1. [] Auto mode	Select this option to leave all the adjustments to the camera and take images casually.
2. [] Sports mode	Select this option to capture fast-moving subjects.
3. [] Night Scene mode	Select this option to take photos of people against dark or nighttime background.
4. [] Portrait mode	Select this option to make people stand out with the background out-of-focus.
5. [] Landscape mode	Select this option to take photos of distant scenery or landscapes.
6. [] Backlight mode	Select this option to brighten subjects that are backlit and would come out dark if no flash was used.



LCD Monitor Information

These indicators are displayed when recording still images:





1. Scene mode

- [**A**] Auto mode
- [] Sports mode
- [] Night Scene mode
- [] Portrait mode
- [] Landscape mode
- [] Backlight mode

2. Image quality

- [] Fine
- [] Normal
- [] Economy

3. Image size (pixels)





- [] 3072x2304
- [] 2560x1920
- [] 2048x1536
- [] 1280x960
- [] 640x480





4. Shots remaining

5. [] Card indicator



6. Battery level

- [] Full battery
- [] Fairly consumed
- [] Nearly exhausted
- [] Virtually no battery power

7. ISO speed

- [No icon] Auto
- [] 100
- [] 200



8. Sharpness

- [] High
- [] Medium
- [] Low

9. Color

- [] Full Color
- [] Black & White
- [] Sepia



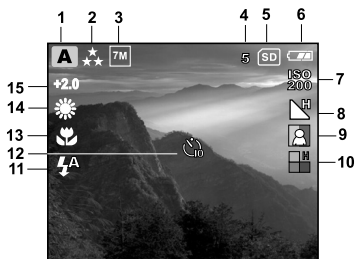

10. Saturation

- [] High
- [] Medium
- [] Low

These indicators are displayed when recording still images:







11. Flash mode

- [] Fill flash (on)
- [] Flash off
- [] Automatic flash
- [] Red-eye reduction

12. [] Self-timer mode

13. [] Macro mode





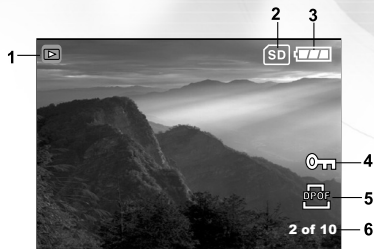

14. White balance

- [No icon] Auto
- [] Daylight
- [] Cloudy
- [] Tungsten
- [] Fluorescent

15. EV compensation





These indicators are displayed when playing images back:

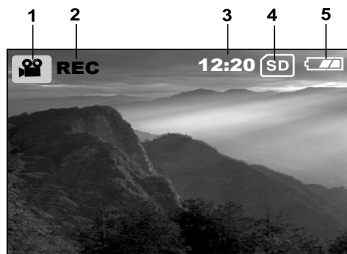

1. Playback mode
2. [] Card indicator
3. Battery level
[] Full battery
[] Fairly consumed
[] Nearly exhausted
[] Virtually no battery power
4. [] Protected indicator
5. [] DPOF icon
6. Index number of total number





These indicators are displayed when recording video clips:



1. Movie mode
2. Recording indicator
3. Video counter
4. [] Card indicator
5. Battery level
[] Full battery
[] Fairly consumed
[] Nearly exhausted
[] Virtually no battery power

These indicators are displayed when playing back video clips:



1. Playback mode
2. Battery level
[] Full battery
[] Fairly consumed
[] Nearly exhausted
[] Virtually no battery power
3. [] Card indicator
4. Index number of total number
5. Movie mode
6. Elapsed time
7. Elapsed playback indicator

PREPARING YOUR CAMERA

Installing the Battery

We highly recommend you use the specified rechargeable lithium-ion battery to maximize performance of your digital camera. Make sure that camera's power is off before inserting or removing the battery.

1. Turn your camera off.
2. Slide the battery/SD card cover away in arrow direction and lift it up.
3. Insert the battery with correct orientation. so its label is facing to the front side of the camera, and then insert the battery all the way down.
4. Close the battery/SD card cover securely.

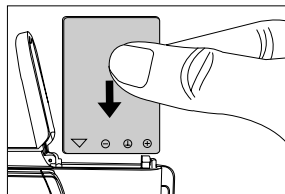

Removing the Battery

Open the battery/SD card cover and then release the battery lock lever. When the battery has come out a little, slowly pull it out.

Charging the Battery

The supplied AC adapter can charge the battery or activate the camera. Make sure that power of the camera is off and then insert the battery before starting.

1. Insert the barrel plug of the AC adapter into the **DC IN** socket of the camera.
2. Insert the other end of the AC adapter into a wall outlet.
 - The status LED flashes green when charging starts and lights green when charging completes.
 - It is recommended to fully discharge or deplete the battery before charging.
 - Charging time varies according to the ambient temperature and the remaining power of battery.

Caution: You must use a class II, 5V/3A AC adapter. Its center tip must be set to positive and its plug must correctly fit the camera's **DC IN 5V** jack. The supplied adapter meets these requirements. Using an adapter that does not meet these requirements could damage the camera or the adapter.

Notes:

- Before charging, turn power on at any mode. After LCD monitor turns on, turn power off.
- The battery may become warm after charging or used for a long time. This is normal and not a malfunction. When using the camera in cold areas, keep the camera and battery in your overcoat to keep them warm.
- If you open the battery cover without removing the battery, the power will not be terminated. If you remove the battery, and do not re-insert it within 2 hours, the date and time will reset.
- We recommend you charge the battery eight hours before first use.

Loading an SD Memory Card (Optional Accessory)

Your camera comes with 16 MB of internal memory (14 MB available for image storage), allowing you to store images and video clips in the camera. However, you can also expand the memory capacity by using an optional SD memory card which provides removable, reusable storage for images and video clips.

1. Make sure your camera is off.
2. Slide the SD card/battery cover in arrow direction and lift it up.
3. Insert the SD memory card all the way in.
 - If the card cannot be inserted, check the orientation.
4. Close the SD card/battery cover securely.

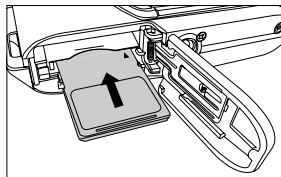

Notes:

- To prevent valuable data from being accidentally deleted from an SD memory card you can slide the write protect tab (on the side of the SD memory card) to "LOCK".
- To save, edit, or delete data on an SD memory card, you must unlock the card.
- Be sure to format the memory card with this camera before its initial usage.

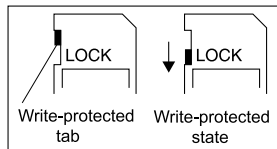

To remove an SD memory card

1. Turn your camera off.
2. Release the SD card/battery cover lock.
3. Push the memory card in so it pops out.

Note:

- The memory card may become hot during use, observe due caution when removing the memory card.

Setting Date and Time

The Date/Time screen will appear when:

- The camera is turned on for the first time.
- The camera is turned on after removing the batteries for a long period of time.

1. Select the item field using the ◀ / ▶ buttons.
2. Select the setting using the ▲ / ▼ buttons.
3. Press **OK** after all fields are set.

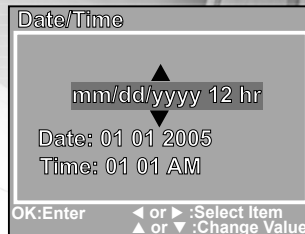

Choosing Language

Follow the steps below to set the OSD (On-Screen Display) language.

1. Press the **MENU** button.
2. Press the ▶ button to select [Setup] menu.
3. Press the ▲/▼ buttons to select [Language], and press **OK**.
4. Select the desired language using the ▲/▼ buttons.
5. Press **OK** after all fields are set.

Note:

- The language setting will be retained even if the camera is turned off.

Attaching the Camera Strap

To prevent accidental slippage during use, always hang the camera strap on your hand.

Attach the camera strap as follows:

1. Thread the small loop of the strap through the strap eyelet on the camera.
2. Pull the large loop through the small loop until the strap is firmly secured.

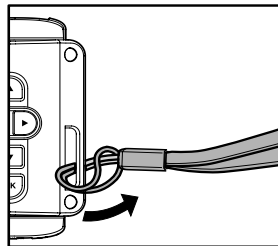

BASIC FUNCTIONS

Turning Power On/Off

1. Slide the lens cover to turn the camera on.
2. The camera sounds one beep when turned on.
3. Slide the lens cover back to turn off the camera.

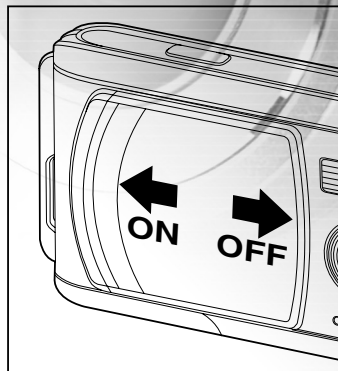

Using the LCD Monitor

The LCD monitor lets you monitor an image while taking pictures, to replay recorded images/video clips or to adjust menu settings. The mode icons, text and numbers that are displayed on the LCD monitor may vary according to the current settings.

1. Slide the lens cover to turn on the camera.
2. Set the scene mode in the Capture menu based on the desired scenery.
(Auto/Sports/Night Scene/Portrait/Landscape/Backlight).
3. Compose your image on the LCD monitor.
4. Press the shutter button.

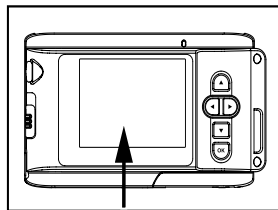

Note:

- The LCD monitor darkens in strong sunlight or bright light. This is not a malfunction.

Using Normal Mode

Normal mode is used to take images where the distance to the subject is 1.0m to infinity. Select this mode for general shooting, including portraits and scenery.

1. Set the focus to the [▲] position.
2. Compose your image.
3. Press the shutter button.

Note:

- LCD monitor will display [A] indicating Normal mode.

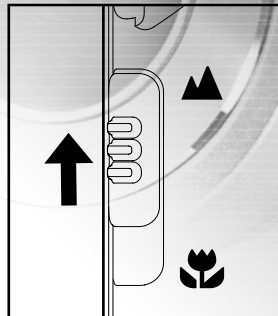



Using Zoom

Using digital zoom, images appear closer. However the more an image is enlarged (zoomed), the more pixelated (grainier) image appears.

You can only set the digital zoom at the resolution of 2560 x 1920 pixels; digital zoom is not available at the resolution of 3072 x 2304 pixels, 2048 x 1536 pixels, 1280 x 960 pixels or 640 x 480 pixels.

Digital zoom cannot be used in [] Movie mode.

1. Set the scene mode in the Capture menu based on the desired scenery.
(Auto/Sports/Night Scene/Portrait/Landscape/Backlight).
2. Each press of the  button changes the image size in the cycle from 1x, 2x, 4x, 1x.
 - To exit the digital zoom, press the  button again and return to the capture status.
3. Press the shutter button to capture a set “zoomed” image.

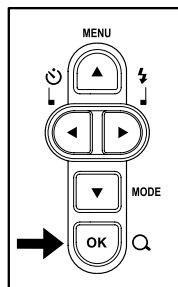



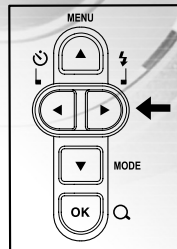

Using the Flash

The flash is designed to function automatically when lighting conditions warrant the use of flash. You can take an image using a suitable flash mode to suit lighting condition.







1. Set the scene mode in the Capture menu based on the desired scenery. (Auto/Sports/Night Scene/Portrait/Landscape/Backlight).
2. The camera has four flash modes: Fill flash (on), Flash off, Automatic flash and Red-eye reduction. Press the  button located on the rear side of the camera repeatedly until your desired flash mode appears on the LCD monitor.
3. Compose your image and press the shutter button.



The table below helps to choose the appropriate flash mode:

Flash Mode	Description
[] Fill flash (on)	The flash will always fire regardless of the surrounding brightness. Select this mode for recording images with high contrast (backlighting) and deep shadows.
[] Flash off	The flash will not fire. Select this mode when taking images in a place where flash photography is prohibited, or when the distance to the subject is beyond the effective range of the flash.
[] Automatic flash	The flash fires automatically according to the ambient lighting conditions. Select this mode for general photography.
[] Red-eye reduction	The flash emits a precursor-flash before the main flash fires. This causes the pupil in the human eye to constrict, reducing the red-eye phenomenon. Select this mode when taking images of people and animals in low-light conditions.



Notes:

- In [] Macro mode and [] Landscape mode, flash photography is not possible.
- In [] Night Scene mode, flash photography will automatically detect the ambient lighting. If the surrounding brightness is low, the flash will fire at [] Red-eye reduction mode.
- In [] Sports mode, Flash mode is automatically set to [] Flash off.

Using Self-Timer

According to your preferences you can take pictures with the self-timer in any scene mode (Auto/Sports/Night Scene/Portrait/Landscape/Backlight).

Self-timer duration can be set at 10 seconds or 5 seconds. Self-timer mode can be cycled from [10 s]→[5 s]→[Self-Timer Off]. After the self-timer is set, the shutter automatically releases after 10 seconds or 5 seconds. The self-timer lamp starts blinking slowly for the first 7 seconds or the first 2 seconds and then blinking rapidly for the last 3 seconds.

1. Mount the camera on a tripod or place it on a stable surface.
2. Slide the lens cover to turn the camera on.
3. Set the scene mode in the Capture menu based on the desired scenery.
(Auto/Sports/Night Scene/Portrait/Landscape/Backlight).
4. Press the  button to select the desired self-timer mode.
5. Compose your image.
6. Press the shutter button.
 - To cancel the self-timer at any time, press the  button.

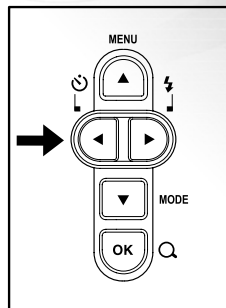



Note:

- After one shot is taken, the self-timer mode turns off.



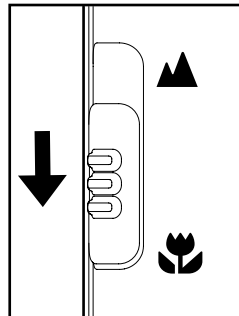

Using Macro Mode

Use [] Macro mode to capture a close-up of the subject, such as flowers or insects. The effective range is between 0.6m to 1.0m.

1. Set the focus switch to the [] position.
2. Compose your image.
3. Press the shutter button.
 - To disable macro photography, slide the focus switch back to the [] Normal mode.



Notes:

- In [] Macro mode, EV compensation, Scene mode and ISO speed cannot be set.
- In [] Macro mode, Flash mode is automatically set to [] Flash off.
- After a macro shot is taken, **DO NOT FORGET** to reset the lens to the [] Normal position.

Setting Image Resolution and Quality

Resolution and quality settings determine the pixel size (dimension), image file size, and compression ratio for the images. These settings affect the number of images stored in memory, or on an SD memory card. As you get to know the camera, it is recommended that you try each quality and resolution setting to get desired effects on the images.

Higher resolution and higher quality image offer the best photographic results but increase file size.

High resolution and quality settings are recommended for printed output and situations requiring the finest detail. Lower resolution/quality images take up less memory space and may be quite suitable for sharing images via e-mail, in a report, or on a web page.





To change image resolution or quality settings perform the steps below:

1. Press the **MENU** button to enter the [Capture] menu and select [Size] or [Quality] by using the ▼ / ▲ buttons. Press **OK** to enter the sub-menu.
2. After entering the sub-menu, select your option by using the ▼ / ▲ button. Press **OK** to confirm the setting.
3. To exit from the menu mode, use the ▼ / ▲ buttons to select [Exit] and press **OK**.



Number of Recordable Images

The following list indicates the approximate number of images that can be stored in the internal memory or the SD memory card at the camera's image quality and size settings. The number of recordable images may vary depending on the recorded subject and the capacity of the memory card, or if there are files other than images, or when the recording is made while switching the picture quality/resolution.

Resolution	Quality	16 MB Internal Memory (14 MB available for image storage)	SD Memory Card					
			32 MB	64 MB	128 MB	256 MB	512 MB	1 GB
3072x2304 	**	11	24	50	101	204	411	819
	*★	15	33	68	137	276	557	1111
	★	22	45	94	190	381	769	1534
2560x1920 	**	15	32	67	136	273	551	1100
	*★	20	43	88	179	359	724	1444
	★	28	59	123	249	499	1007	2008
2048x1536 	**	24	50	103	209	419	845	1685
	*★	31	66	136	276	553	1116	2225
	★	42	89	183	371	744	1500	2991
1280 x 960 	**	51	107	220	447	897	1807	3604
	*★	65	136	280	567	1137	2292	4570
	★	86	180	369	749	1502	3027	6037
640 x 480 	**	130	270	555	1124	2254	4543	9060
	*★	153	318	654	1325	2657	5353	9999
	★	195	406	835	1692	3394	6839	9999

* The above data shows the standard testing results. The actual capacity varies according to the shooting conditions and settings.

SELECTING PHOTOGRAPHY MODE

Auto Mode

Using [A] Auto mode the majority of settings are adjusted by the camera. Simply aim at the subject and then shoot.

1. Press the **MENU** button to enter [Capture] menu and select [Scene] using the ▲ / ▼ buttons. Press **OK** to enter the sub-menu.
2. After entering the sub-menu, select [Auto] using the ▲ / ▼ buttons. Auto mode icon [A] displays. Press **OK** to confirm setting.
3. To exit from the menu mode, use the ▲ / ▼ buttons to select [Exit] and press **OK**.

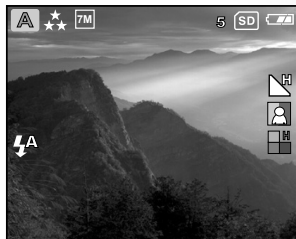
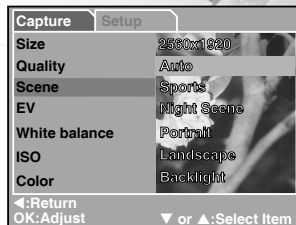

Notes:

- The camera's default setting is [A] Auto mode.
- For other settings like Language, Power Off time or others, choose [Setup] in Capture/Video/Playback menu.



Sports Mode

For dynamic action, choose [] Sports mode. This feature also lets you capture moving subjects continuously.

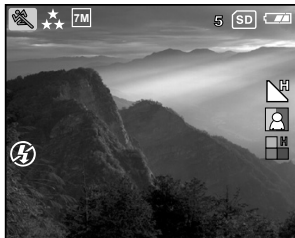
1. Press the **MENU** button to enter [Capture] menu and select [Scene] by using the **▲** / **▼** buttons. Press **OK** to enter sub-menu.
2. After entering sub-menu, select [Sports] using the **▲** / **▼** buttons. Press **OK** to confirm setting. Sports mode icon displays [].
3. To exit from menu mode, use the **▲** / **▼** buttons to select [Exit] and press **OK**.



Notes:

- In [] Sports mode, ISO speed cannot be set.
- In [] Sports mode, Flash mode is automatically set to [] Flash off.
- For other settings like Language, Power Off time or others, choose [Setup] in Capture/Video/Playback menu.



Night Scene Mode

Capturing human subjects using [] Night Scene mode provides you a natural balance between the main subject and the background. The people in an evening sky or night scene are illuminated with lights from the flash while the background is captured at a slow shutter speed to prevent blurring and let both (people and the background) appear according to exposure.

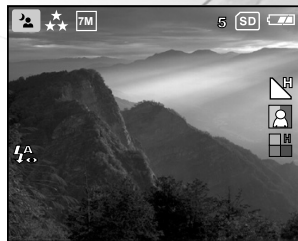
1. Press the **MENU** button to enter [Capture] menu and select [Scene] using the **▲** / **▼** buttons. Press **OK** to enter the sub-menu.
2. After entering the sub-menu, select [Night Scene] using the **▲** / **▼** buttons. Press **OK** to confirm setting. Night Scene icon [] displays.
3. To exit from menu mode, use the **▲** / **▼** buttons to select [Exit] and press **OK**.



Notes:

- In [] Night Scene mode, Flash mode will automatically detect the ambient lighting. If the surrounding brightness is low, the flash will fire at [] Red-eye reduction mode.
- In [] Night Scene mode, ISO speed cannot be set.
- For other settings like Language, Power Off time or others, choose [Setup] in Capture/Video/Playback menu.



Portrait Mode

[] Portrait mode helps you construct portraits in which the main subject stands out sharply and clearly while reduces background's details.

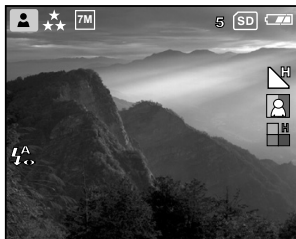
1. Press the **MENU** button to enter the [Capture] menu and select [Scene] using the **▲** / **▼** buttons. Press **OK** to enter the sub-menu.
2. After entering sub-menu, select [Portrait] using the **▲** / **▼** button. Press **OK** to confirm setting. Portrait mode icon [] displays.
3. To exit from the menu mode, use the **▲** / **▼** button to select [Exit] and press **OK**.



Notes:

- In [] Portrait mode, ISO speed cannot be set.
- In [] Portrait mode, in a dark or night-time background, Flash mode defaults at [] Red-eye reduction mode.
- For other settings like Language, Power Off time or others, choose [Setup] in Capture/Video/Playback menu.

Landscape Mode

[▲] Landscape mode helps you capturing vivid and expansive landscape pictures with the enhancement of image's color and saturation. [▲] Landscape mode is used when the distance to the subject is between 1.0m to infinity.

1. Press the **MENU** button to enter [Capture] menu and select [Scene] using the ▲ / ▼ buttons. Press **OK** to enter sub-menu.
2. After entering sub-menu, select [Landscape] using the ▲ / ▼ buttons. Press **OK** to confirm setting. Landscape mode icon [▲] displays.
3. To exit from menu mode, use the ▲ / ▼ buttons to select [Exit] and press **OK**.



Notes:

- In [▲] Landscape mode, ISO speed cannot be set.
- In [▲] Landscape mode, Flash mode is automatically set to [🔒] Flash off.
- For other settings like Language, Power Off time or others, choose [Setup] in Capture/Video/Playback menu.



Backlight Mode

Use [] Backlight mode when light is coming from behind your subject, throwing their features into shadow, or when your subject is in the shade but the background is bright.

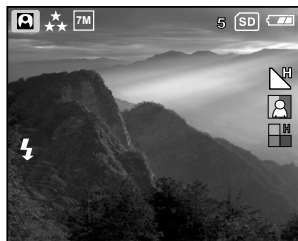
1. Press the **MENU** button to enter [Capture] menu and select [Scene] using the **▲** / **▼** buttons. Press **OK** to enter sub-menu.
2. After entering sub-menu, select [Backlight] by using **▲** / **▼** buttons. Press **OK** to confirm setting. Backlight mode icon [] displays.
3. To exit from menu mode, use the **▲** / **▼** buttons to select [Exit] and press **OK**.



Notes:

- In [] Backlight mode, Flash mode defaults at [] Fill flash (on) mode.
- In [] Backlight mode, ISO speed cannot be set.
- For other settings like Language, Power Off time or others, choose [Setup] in Capture/Video/Playback menu.

MOVIE MODE

[] Movie mode allows you to record video clips at a resolution of 320 x 240 pixels.

1. Press the **MODE** button to enter [] **Movie** mode.
2. You can start recording a video clip by pressing the shutter button.
3. To stop recording, press the shutter button again.



Notes:





- Under certain high light contrast situations, the image on the display will show “red artifacts”. This occurs only in the video clip mode due to over saturation of the sensor. It does not affect the camera performance.
- In [] Movie mode, resolution/quality, self-timer cannot be set or activated.
- In [] Movie mode, the flash mode is automatically set at [] Flash off mode.
- To set [EV] or [White Balance], use [Video] menu.

IMAGE PLAYBACK

[] Playback allows you to view, magnify your images or play back video clips. This mode even provides thumbnail images display and slide show, allowing you to quickly search for the image that you want or play back the images one by one automatically.



Single Image Playback

Play back still images one by one.

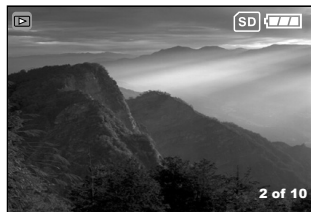
1. Press the **MODE** button twice to enter [] Playback mode.
 - The last recorded image appears on the LCD monitor.
2. View and select your recorded images using the ◀ / ▶ buttons.
 - To view the previous image, press the ◀ button.
 - To view the next image, press the ▶ button.



Notes:

- To exit [] Playback mode, press the **MODE** button.
- The [] print indicator only appears on the LCD monitor when the image is set to print out.
- If there is no image stored in the internal memory or on the memory card, [No Image] message will appear on the LCD monitor.
- During playback, the recorded image appears to be larger than the one on preview in capture mode.

Magnifying Images

While reviewing your images, you may enlarge a selected portion of an image. This magnification allows you to view fine details.

1. Press the **MODE** button twice to enter [] Playback mode.
 - The last image frame appears on the LCD monitor.
2. View and select your images using the ◀ / ▶ buttons.
3. Enlarge the image by pressing **OK**. Each press of **OK** magnifies the image from the cycle of 2x, 3x, 4x, normal size.
4. Use the ▲ / ▼ / ◀ / ▶ buttons to select the area to enlarge.
5. To return to the regular display from 4X-enlarged status, press **OK**.



Viewing Nine Thumbnail Images at a Time

This function allows you to view nine thumbnail images on the LCD monitor simultaneously so you can quickly scan for a particular image.

1. Press the **MODE** button twice to enter [▶] Playback mode.
2. Press the **MENU** button.
3. Use the ▲ / ▼ buttons to select [Thumbnails].
4. Press **OK** and nine thumbnail images appear on the LCD monitor (if there are nine or more recorded images in the memory).
5. Use the ▲ / ▼ / ◀ / ▶ buttons to move the cursor to select the image to be displayed at regular size.
6. Press **OK** to display the selected image in full screen.

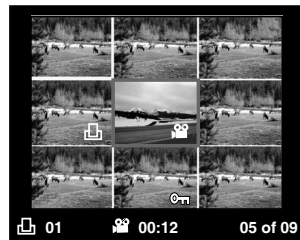
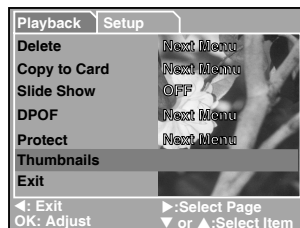

Viewing Video Clips

To view the recorded video clips, follow the steps below:

1. Press the **MODE** button twice to enter [] Playback mode.
2. Select the video clip you want to view using the **◀ / ▶** buttons.
3. Press **OK**.
 - Playback begins.
 - Press **OK** again to stop playback.



Automated Playback (Slide Show)

Slide show function enables you to play back your images automatically in sequential order. This is a very useful and entertaining feature for reviewing recorded images and presentations.

1. Press the **MODE** button twice to enter [] Playback mode. Then press the **MENU** button to enter the Playback menu.
2. Select [Slide Show] using the **▲ / ▼** buttons then press **OK** to enter sub-menu.
3. Set the playback interval using the **▲ / ▼** buttons and press **OK** to confirm.
 - The slide-show starts displaying your images on the LCD monitor, one by one, with the set interval.
 - To stop slide-show display, press **OK**.

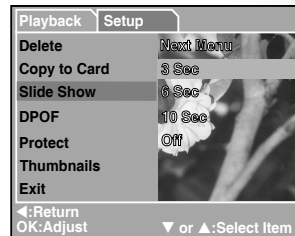

Note:

- To not set automated playback (slide show), press the **MENU** button to exit.

Protecting Images

This feature allows you to prevent the recorded images from being accidentally erased.

1. Press the **MODE** button twice to enter [▶] Playback mode. Then press the **MENU** button to enter Playback menu.
2. Select [Protect] using the ▲ / ▼ buttons, and press **OK**.
3. You can select to protect a single image or all images at once using the ▲ / ▼ buttons and then press **OK**.
 - [Single]: Protect one image at one time.
 - [All]: Protect all images at once.
4. Select [Unlock] or [Lock] using the ▲ / ▼ buttons.
 - [Unlock]: Unlock the protected image.
 - [Lock]: Protect the selected image or all images.
5. Press **OK** again to confirm setting.



DELETING IMAGES

Deleting Single Image/Video Clip

To delete single image or video clip at a time:

1. Press the **MODE** button twice to enter [] Playback mode.
 - The last image frame appears on the LCD monitor.
2. View and select unwanted images using the ◀ / ▶ buttons, then press the **MENU** button.
3. Select [Delete] using the ▲ / ▼ buttons, and press **OK**.
4. Use the ▲ / ▼ buttons to select [Single], and press **OK**.
5. Use the ▲ / ▼ buttons to select [Execute] and press **OK** to confirm the deletion. To cancel the action, select [Cancel].
6. Continue the deletion if necessary.
 - If all images are deleted, [No Image] pops up.
 - To exit the deletion, press the **MODE** button again.

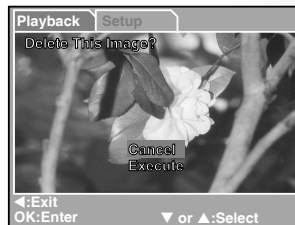
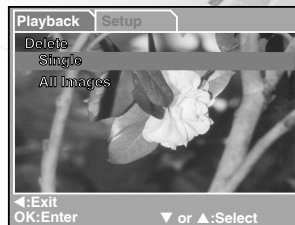

Notes:

- The deleted images cannot be recovered. Exercise adequate caution before deleting a file.
- Protected images cannot be deleted with the delete function.

Deleting All Images/Video Clips

1. Press the **MODE** button twice to enter [▶] Playback mode. Then press the **MENU** button to enter the Playback menu.
2. Select [Delete] using the ▲ / ▼ buttons, and press **OK**.
3. Use the ▲ / ▼ buttons to select [All Images], and press **OK**.
4. Use the ▲ / ▼ buttons, then select [Execute] and press **OK** to confirm the deletion. To cancel the action, select [Cancel].

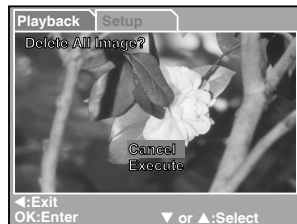

Notes:

- The deleted images cannot be recovered. Exercise adequate caution before deleting a file.
- Protected images cannot be deleted with the delete function.
- If SD memory card is inserted, images and video clips recorded on the memory card will be deleted first.

Formatting an SD Memory Card or Internal Memory

This utility formats the internal memory (or memory card) and deletes all stored images and data.

1. Press the **MENU** button to enter [Setup] in any mode.
2. Select [Format] using the **▲ / ▼** buttons. Press **OK** to enter sub-menu.
3. To format the SD memory card or the internal memory, choose [Execute] by pressing the **▲ / ▼** buttons, and then press **OK** to confirm.
 - To cancel the action, select [Cancel].
 - [No Image] pops up after the SD memory card or the internal memory has been formatted.

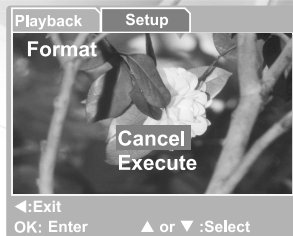

Notes:

- Be sure the SD memory card is completely inserted into the camera before formatting it.
- To format images or video clips recorded in the internal memory, be sure to remove your SD memory card first.
- For complete compatibility, be sure NOT to select FAT 32 as the file system when you format the SD card on your computer. Memory cards formatted in FAT 32 file system will not be recognized by this camera.

SETTING DPOF

DPOF (Digital Print Order Format) allows you embed printing information on your SD memory card.

By using DPOF, you can select an image to be printed and then specify how many prints or which image you would like. Take your SD memory card to a DPOF enabled printer or through laboratory printing services that accept memory cards. The DPOF/card-compatible printer will read the embedded information on the memory card and print your images as specified.

To Set DPOF:

1. Press the **MODE** button twice to enter [] Playback mode. Then, press the **MENU** button to enter Playback menu.
2. Select [DPOF] using the **▲** / **▼** buttons, and press **OK**.
3. Select [Single] or [All] using the **▲** / **▼** buttons, and press **OK**.

The DPOF sub-menu options:

[Single]: Sets DPOF for each individual image.

[All]: Sets DPOF for all images at once.

4. Select [Print Num.] using the **▲** / **▼** buttons, and press **OK**.
5. Set the number of prints using the **▲** / **▼** buttons, and press **OK**.
You can set up to 9 prints for each image.
6. Select [Print Enable Execute] using the **▲** / **▼** buttons, and press **OK**.
This creates a file containing the DPOF information. When the operation is finished, the screen returns to the playback screen.

Notes:

- To print out images recorded in the internal memory, copy your images to an SD memory card first.
- [] Print-order icon will also display on the LCD monitor to indicate the selected images for printing.

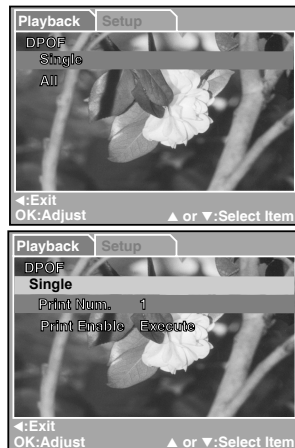

TRANSFERRING RECORDED IMAGES/VIDEO CLIPS TO YOUR COMPUTER

You can share the recorded images/video clips with your family or friends via e-mail or post them on the Web. Before doing so, you need to connect the camera to your computer using the USB cable and then transfer the images/video clips.

To transfer images/video clips from the camera to your computer, follow the steps below:

Step 1: Install the USB driver

Step 2: Connect the camera to your computer

Step 3: Download the images/video clips

	System Requirements (Windows)	System Requirements (Macintosh)
CPU	Pentium III 600 MHz processor or higher	PowerPC G3/G4
OS	Windows 98/98SE/ME/2000/XP	9.0 or higher
Memory	32MB (64MB RAM recommended)	32MB (64MB RAM recommended)
Free Space on Hard Disk	128MB hard disk space	128MB hard disk space
Required Devices	A CD-ROM Drive, An available USB port	A CD-ROM Drive, An available USB port
Color Monitor	Color Monitor (800x600, 24-bit or higher is recommended)	Color Monitor (800x600, 24-bit or higher is recommended)

Step 1: Install the USB Driver

■ Installation on Windows 98 & 98SE

The USB driver on the supplied CD-ROM is exclusively for Windows 98 and 98SE. Windows 2000/ME/XP have built-in USB driver and do not need to install the USB driver.

1. Insert the enclosed CD-ROM into your CD-ROM drive.
2. When the welcome screen appears, click "**Install USB Driver**". Follow the on-screen instructions to complete the installation.
3. After the USB driver has been installed, restart your computer.

■ Installation on MAC OS 9.0

For Mac OS 9.0 or higher, the computer will automatically recognize the digital camera and load its own USB drivers.

Step 2: Connect the Camera to Your Computer

1. Turn on the camera.
2. Connect the larger end of the USB cable to an available USB port on your computer.
3. Connect the small end of the USB cable to the USB socket on the camera.
4. The [USB] mode screen displays. Use the ▲ / ▼ buttons to select [Disk Drive], and then press **OK**.
5. Look for a new “Removable Disk” icon appearing in “My Computer” window. Your recorded images/video clips will be in a folder in this “removable disk”. (For Mac users, double-click the “untitled” disk on the desktop.)

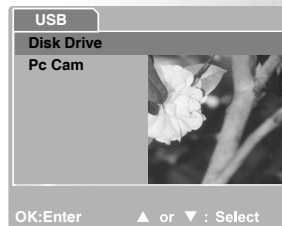
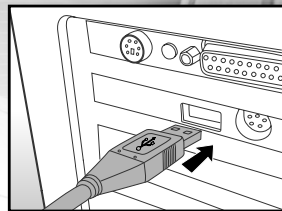

Step 3: Download the Recorded Images/Video Clips

When the camera is turned on and connected to your computer, it is regarded as a disk drive, just like a floppy disk or CD. You can download (transfer) images by copying them from the “removable disk” (“untitled” disk on a Macintosh) to your computer’s hard disk.

For Computers Running Windows

Open the “removable disk” by double clicking on it. Double click on the folder contains your recorded images/video clips. Select the images/video clips you prefer and then choose “Copy” from “Edit” menu. After that, open the destination location and choose “Paste” from “Edit” menu.

For Computers Running Mac OS

Open the “untitled” disk window and the hard disk or the destination location. Drag and drop from the camera disk to the desired destination.

Note:

- Memory card users may prefer to using a memory card reader (highly recommended).

SOFTWARE INSTALLATION

Installing the Photo Explorer

The Ulead® Photo Explorer provides a simple and efficient way to transfer, browse, modify and distribute digital media. It lets you acquire photos, video or sound clips from various digital device types and easily browse or add personal descriptions; make timely modifications; or distribute the media through the medium of your choice: E-mail, Print, Slideshow Presentations. It is an indispensable all-in-one tool for owners of digital cameras, WebCams, DV camcorders, scanners, or anyone who strives to effectively organize a large collection of digital media.

1. Insert the enclosed CD-ROM into your CD-ROM drive.
2. When the welcome screen appears, click **"Install Ulead® Photo Explorer"**. Follow the on-screen instructions to complete the installation.

Notes:

- For more information about the operation of Photo Explorer application software, refer to its respective help documentation.
- For Windows 2000/XP users, please make sure to install and use Photo Explorer in "Administrator" mode.
- Mac operating system does not support Photo Explorer. We recommend iPhoto or iPhoto2.

Installing the Photo Express

The Ulead® Photo Express is a complete photo project software for digital images. The step-by-step workflow, visual program interface, and in-program help you creating exciting photo projects. It lets you acquire digital photos easily from digital cameras or scanners and organize them conveniently with the Visual Browse mode. It uses hundreds of ready-to-use templates such as albums, cards, posters, slideshows, and more. It lets you edit and enhance images with photo editing tools, photographic filters, and special effects. It lets you embellish projects by adding creative design elements such as frames, callouts, and stamp objects. It also lets you share results with family and friends via e-mail and multiple print options.

1. Insert the enclosed CD-ROM into your CD-ROM drive.
2. When the welcome screen appears,click **“Install Ulead® Photo Express”**. Follow the on-screen instructions to complete the installation.

Notes:

- For information about how to use Photo Express to edit and retouch your recorded images, refer to its online help.
- For Windows 2000/XP users, make sure to install and use the Photo Express while logging in as a user with an Administrator account.

USING THE DIGITAL CAMERA AS A PC CAMERA

Your digital camera can act as a PC camera, which allows you to videoconference with business associates, or have a real-time conversation with friends or family in another place. To use the digital camera for videoconference, your computer system must include the following items:

- Microphone
- Sound card
- Speakers or headphones
- Network or Internet connection

Notes:

- Video conferencing (or video editing) software is not included with the digital camera.
- This mode is not supported by Mac.

Step 1: Install the PC camera driver

The PC-camera driver included in the CD-ROM is exclusively for Windows. The PC camera function is not supported by Mac platforms.

1. Insert the enclosed CD-ROM into your CD-ROM drive.
2. When the welcome screen appears, click **"Install USB Driver"**. Follow the on-screen instructions to complete the installation.
3. After the driver installation is completed, restart your computer.

Step 2: Connect the digital camera to your computer

1. Turn on the camera.
2. Connect the larger end of the USB cable to an available USB port on your computer.
3. Connect the small end of the USB cable to the USB socket on the camera.
4. The [USB] mode screen displays.
5. Use the ▲ / ▼ buttons to select [Pc Cam], and then press **OK**.
6. The message "Connected to computer" appears on the screen. Wait for the message to disappear before using application software.
 - * The LCD monitor will turn off automatically for the purpose of power-saving.
7. Mount the digital camera steadily on the top of your computer monitor or use a tripod.

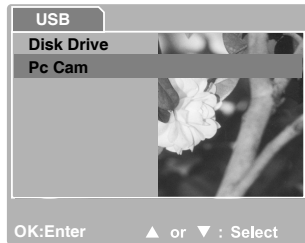

Note:

- When using this digital camera as a PC camera, it is necessary to install the battery into the digital camera.

Step 3: Run your videoconferencing application software (i.e. Windows NetMeeting)

To use Windows NetMeeting for videoconferencing:

1. Go to **Start → Programs → Accessories → Communications → NetMeeting** to launch the NetMeeting program.
2. Click the **Start Video** button to view live video.
3. Click the **Place Call** button.
4. Type the e-mail address or the network address of the computer that you are calling.
5. Click **Call**. The person that you are calling must also have Windows NetMeeting running and be willing to accept your call to start the videoconference.

Notes:

- The video resolution for videoconferencing applications is generally 320 x 240.
- For more information about the operation of videoconference application software, refer to its respective help documentation.

LIST OF MENU OPTIONS

Capture Menu

This menu includes the basic settings for taking still images.

1. Press the **MENU** button and then scroll through the options using the **▲/▼** buttons.
2. Press **OK** to enter sub-menu.
3. After entering sub-menu, select your option using the **▲ / ▼** buttons.
4. Press **OK** to confirm setting.
5. To exit from menu mode, use the **▲ / ▼** buttons to select [Exit] and press **OK**.

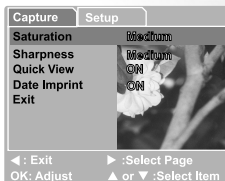

Size

This sets the size of image to be photographed.

[3072 x 2304]: 3072 x 2304 pixels

[2560 x 1920]: 2560 x 1920 pixels

[2048 x 1536]: 2048 x 1536 pixels

[1280 x 960]: 1280 x 960 pixels

[640 x 480]: 640 x 480 pixels

Quality

This sets the quality (compression rate) of image to be taken.

[Fine]: Low compression rate

[Normal]: Normal

[Economy]: High compression rate

Scene

This sets the scene mode for capturing images.

[Auto]: The camera automatically adjusts the focus and exposure settings for shooting.

[Sports]: Select this option to take photographs of fast-moving subjects.

[Night Scene]: Select this option to take photographs of people against a dusk or night-time background.

[Portrait]: Select this option to make people stand out with the background out-of-focus.

[Landscape]: Select this option to take photographs of distant scenery or landscapes.

[Backlight]: Select this option for capturing images with light comes behind the object.

EV

Your camera adjusts the exposure for each scene automatically. However, when the subject is too dark or too bright, the camera adjusts the brightness properly. This is called EV compensation.

The EV compensation of your camera can be adjusted from [-2.0 EV] to [+2.0 EV] (0.5 EV step).

To adjust EV, press the ▲ / ▼ buttons and press **OK** to confirm.

Effective Subjects and Set Values

Positive (+) Compensation

- Copy of printed text (black characters on white paper)
- Backlit portraits
- Very bright scenes (such as snowfields) and highly reflective subjects
- Shots made under predominant sky

Negative (-) Compensation

- Spot lighted subjects, particularly against dark backgrounds
- Image of printed text (white characters on black paper)
- Low reflective scenes, such as shots of green or dark foliage

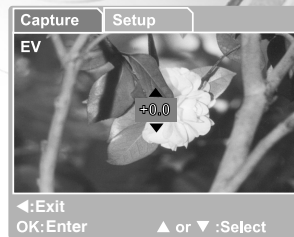

White Balance

When the brightness of a scene changes, our eyes adapt the difference so the white object remains white. For digital cameras, they can also see the white object as white by averaging the light around the subject.

The camera determines the white balance by averaging the various kinds of light that actually enters into the lens. You may set in advance the white balance when taking photographs under specific lighting conditions.

- [Auto]: Automatically adjusting the white balance.
- [Daylight]: For recording outdoors on a bright day.
- [Cloudy]: For recording overcast, shaded, twilight or evening skies.
- [Tungsten]: For recording under tungsten lighting condition.
- [Fluorescent]: For recording under fluorescent lighting condition.

ISO

The ISO figure is the numeric indication for sensitivity to light. Higher ISO figure setting has higher sensitivity to light and is suitable for shooting under low light, but also has higher noise (grains).

- [Auto]: Automatic adjustment
- [100]: Sensitivity equivalent to ISO100
- [200]: Sensitivity equivalent to ISO200

Color

To represent different feeling of an image, the camera offers three types of color setting (Full color/ Black & White/ Sepia) to match your preference.

- [Full color]: Bright colors
- [Sepia]: Sepia
- [Black & White]: Monochrome

Saturation

To represent different color saturation of an image, the camera offers you three different degrees of color (High/ Medium/Low) to match your preference.

Sharpness

High sharpness setting emphasizes the borders between light and dark areas of an image and makes the image's edges look sharper. Low sharpness setting softens the look of an image.

- [High]: Hard touch
- [Medium]: Normal touch
- [Low]: Soft touch

Quick View

Set to display a photographed image on LCD monitor immediately after you have taken a shot.

- [ON]: Displays quick view
- [OFF]: Does not display quick view

Date Imprint

To record the shooting date of an image, set date imprint to ON. To disable date imprint function, set to OFF.

- [ON]: Date will be showed on the captured image with day/month/year and hour/minute format.
- [OFF]: Date will not be showed on the captured image.

Exit

Select this option if you wish to exit from the menu mode.

Playback Menu

Use the Playback menu you can create an on-camera slide show or configure DPOF settings. You may also delete or protect one or all stored images.

1. Press the **MODE** button twice to enter [] Playback mode.
Then press the **MENU** button to enter Playback menu.
Scroll through the options using the **▲** / **▼** buttons.
2. To enter sub-menu, press **OK**. After settings are set, press **OK** to confirm.

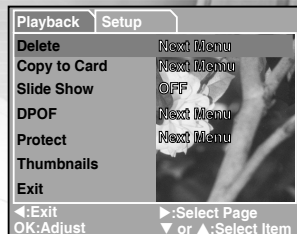

Delete

Delete still images and video clips that have not come out right.
Refer to “Deleting Images/Video Clips” in page 47 for further details.

Copy to Card

This feature allows you to copy your images/video clips from the camera's memory.
This functions is enabled when the SD memory card is loaded and the internal memory contains images/video clips.

Slide Show

Automatically plays back still images one by one.
Refer to “Automated Playback (Slide Show)” in page 45 for further details.

DPOF

Set the number of prints in the DPOF format images you want to print. (This function is available for still images only.)
You can print images easily by inserting the SD card to a DPOF-compatible printer or a print shop.
Refer to “SETTING DPOF” in page 50 for further details.

Protect

Set the data to read-only to prevent images from being erased accidentally.
Refer to “Protecting Images” in page 46 for further details.

Thumbnails

This feature allows you to view 9 thumbnail images on the LCD monitor at the same time.

Exit

Select this option if you wish to exit from the menu mode.

Video Menu

This menu is for the basic settings for recording video clips.

EV

Refer to “Capture Menu” in page 59 for further details.

White Balance

Refer to “Capture Menu” in page 59 for further details.

Exit

Select this option if you wish to exit from the menu mode.

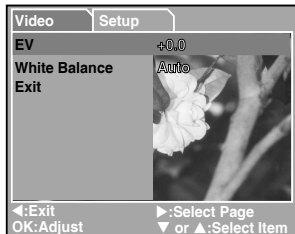

Setup Menu (in Capture/Video/Playback Menu)

You can select camera setting according to your preference in Setup of Capture/Video/Playback Menu. Navigate the options you wish to configure using the ▲ / ▼ buttons.

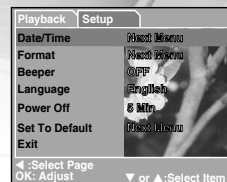
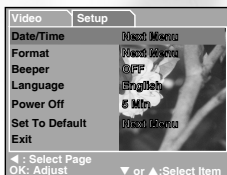
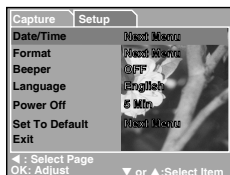

Date/Time

This sets the image recording date and time.
Refer to "Setting the Date and Time" in page 23 for further details.

Format

This utility formats the internal memory (or memory card) and erases all stored images and data.
Refer to "Formatting an SD Memory Card or Internal Memory" in page 49 for further details.

Beeper

Sets whether the camera will beep or not when you press a button.

[ON]: Beep is generated
[OFF]: No beep

Language

Your camera has six language menu for you to select — English, French, Italiano, Espanol, Traditional Chinese, Simplified Chinese.

To select language, enter Setup menu and scroll to Language, then select the desired language.

Automatic Power Off

To save battery power, your camera has three automatic power off settings — 3, 5, 10 minutes plus OFF which disables the automatic power off. Go to Setup menu, scroll to “Power Off” to select the desired setting as follows:

[3 Min], [5 Min], [10 Min], [OFF]

Set to Default

This function will restore all the parameters to the default settings. Go to Setup menu and select “Set to Default” to select following:

[Cancel]: Remain the current settings

[Execute]: Reset to default settings

Exit

Select this option if you wish to exit from the menu mode.

CAMERA SPECIFICATIONS

Item	Description
Sensor	Approx. 5.0 Mega pixels
Image resolution	Still image: 3072 x 2304 (7MP, by interpolation) 2560 x 1920 (5MP, native resolution) 2048 x 1536 1280 x 960 640 x 480 Video clip: 320 x 240
Image quality	Fine/Normal/Economy
Recording media	16 MB internal memory (14 MB available for image storage) SD memory card (optional, up to 1 GB)
Lens	Aperture: 3.0 Focal length: 6.22mm
Range of focus	Macro: 0.6m - 1.0m Normal: 1.0m - infinity
LCD monitor	2.0" TFT color LCD
Self-timer	5-second/10-second delay
Zoom	4X digital zoom
Exposure compensation	Automatic exposure with manual EV compensation +/-2.0EV in 0.5EV steps
White balance	Automatic with presets for Daylight, Cloudy, Tungsten, Fluorescent
File format	EXIF 2.2, DCF 1.0, DPOF 1.0, MPEG-1
Interface	DC IN 5V socket USB socket
Operating environment	Operation: 23°F~104°F (-5°C ~ 40°C), 15% ~ 90% humidity Storage: -4°F ~ 140°F (-20°C ~ 60°C), 10% ~ 95% humidity
Power supply	Lithium ion rechargeable battery (650mA) AC-DC Adapter
Dimensions	Approx. 89.5 x 56 x 24mm (without protruding parts)
Weight	Approx. 80g (without batteries and the SD memory card)

* Design and specifications are subject to change without notice.

TROUBLESHOOTING

Refer to the symptoms and measures listed below before sending the camera for repairs. If the problem persists, contact your local RadioShack.

Power Supply

Symptom	Cause	Solution
Power does not come on.	The battery is not loaded.	Load the battery.
	The battery is exhausted.	Recharge or use the AC adapter.
Power cuts out during use.	The camera was left unattended and unused, so the auto power off cuts it off.	Turn the power on.
	The battery is exhausted.	Recharge or use the AC adapter.
Power does not go off.	Power circuit malfunction temporarily.	Reload the battery. If using the AC adapter, reconnect it.
The battery runs out quickly.	It is being used in extreme low temperature.	Move the camera to a warm place.
	Many shots are being captured in dark places inside, requiring flash.	Recharge the battery.
	The battery is not fully charged. The battery is not used for an extended period of time after charged.	Fully charge the battery and discharge it for at least one complete cycle before use to maximize its performance and lifetime.
The battery or camera becomes warm.	Long period of continuous use of the camera or the flash.	This is normal. The camera will cool when unused for several minutes.

Shooting

Symptom	Cause	Solution
The camera does not shoot after pressing the shutter button.	The battery is running low.	Recharge or use the AC adapter.
	The power is not turned on.	Slide the lens cover off to turn on the camera.
	The camera is not in shooting mode.	Toggle the MODE button to shooting mode.
	The shutter button is not pressed firmly.	Press the shutter button firmly.
	The internal memory or memory card does not have any free space.	Load a new card, or delete unwanted files.
	End of memory card life.	Load a new memory card.
	The flash is recharging.	Wait until the flash completes recharging.
	The memory card is unrecognized by the camera.	Format the memory card in this camera before its first use or when it was used by other camera.
Images do not appear on the LCD monitor.	The auto power off function is activated.	Turn power on again.
	Power is not turned on.	Turn power on.
The camera does not focus.	The lens is dirty.	Wipe clean with a soft, dry cloth or lens paper.
	The distance to the subject is larger than the effective range.	Get your subject within the effective focus range.
The flash does not fire. The flash cannot recharge.	The camera is set to  mode.	Switch to another mode other than one of those.
	The flash is set to no flash.	Set the flash to auto flash.
Even the flash has fired, the image remains dark.	The distance to the subject is larger than flash effective range.	Get closer to your subject and shoot.
The image is too dark.	The image was captured in a dark place while the camera was set to no flash.	Set the flash to auto flash.
	It is under-exposed.	Set the exposure compensation to a larger value.
The image is too bright.	It is over-exposed.	Set the exposure compensation to a smaller value.
The image color appeared unnatural.	The image was captured in conditions hard for Auto White Balance to adjust.	Add a white object to the composition.

Playback

Symptom	Cause	Solution
Cannot playback.	The camera is not set to playback mode.	Toggle the MODE button to playback mode.
The contents of memory card cannot be replayed.	You played back a memory card that was not formatted by this camera.	Loaded a card that was formatted by this camera.
Files cannot be deleted.	You played back a memory card that was not formatted by this camera.	Loaded a card that was formatted by this camera.
Cannot format a memory card.	The memory card is write-protected.	Remove the write-protection.
	End of memory card life.	Load a new memory card.

Other Problems

Symptom	Cause	Solution
Cannot load the memory card.	The card is loaded in wrong orientation.	Load it correctly.
Even the camera's button is pressed, it does not operate.	The battery is running low.	Recharge or use the AC adapter.
	Camera malfunction.	Turn the power off and remove and reload the battery, and then try again.
The date and time are wrong.	The correct date and time are not set.	Set the correct date and time.

About connecting to your computer/software

Symptom	Cause	Solution
Cannot download images.	The free space in your computer's hard disk may be insufficient.	Check whether the hard disk has a space for running Windows, and if the drive for loading image files has enough capacity.
	The USB driver is not installed (for Windows 98/98SE).	Install the USB driver.

This product is warranted by RadioShack against manufacturing defects in material and workmanship under normal use for one (1) year from the date of purchase from RadioShack company-owned stores and authorized RadioShack franchisees and dealers. For complete warranty details and exclusions, check with your local RadioShack store.

RadioShack Customer Relations
300 RadioShack Circle, Fort Worth, TX 76102

04/04

RadioShack.

©2005. RadioShack Corporation.
All rights reserved. Optimus, RadioShack and
RadioShack.com are trademarks used
by RadioShack Corporation.

16-3898
01A06
China

Note: Actual product may vary from the images found in this document.