

JVC

LM-H191 LM-H171

LCD DISPLAY MONITOR

LCD-DISPLAYMONITOR

MONITEUR LCD

SCHERMO A CRISTALLI LIQUIDI

MONITOR PANTALLA LCD

МОНИТОР С ЖК-ДИСПЛЕЕМ

LCD 显示器

LCT2401-002A-H

INSTRUCTIONS
BEDIENUNGSANLEITUNG
MANUEL D'INSTRUCTIONS
ISTRUZIONI
MANUAL DE INSTRUCCIONES
ИНСТРУКЦИЯ ПО ЭКСПЛУАТАЦИИ
使用说明书



The illustration of the monitor is of LM-H191.

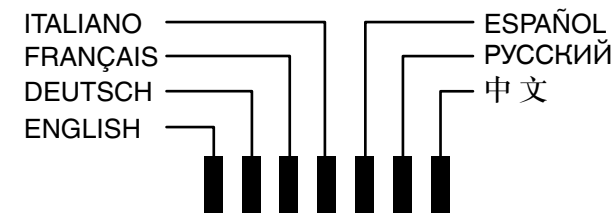

JVC

LM-H191 LM-H171

INSTRUCTIONS

LCD DISPLAY MONITOR

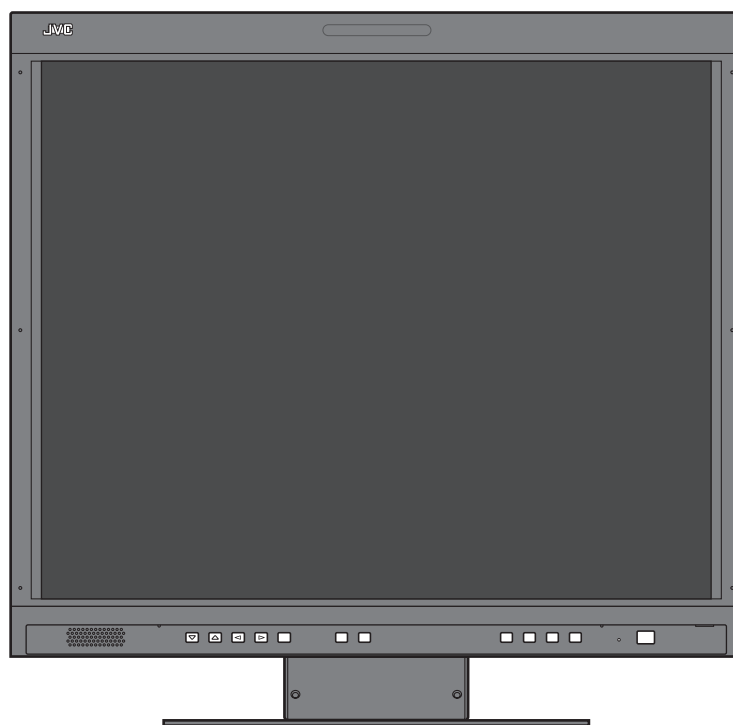

The illustration of the monitor is of LM-H191.

Table of Contents

Safety Precautions	2
IMPORTANT SAFEGUARDS	2
Maintenance	3
Installation	4
Daily Operations / Connections	6
Front panel	6
Rear panel	8
Available signals	9
Menu Configuration—MAIN MENU	10
Menu Configuration—SET UP MENU	11
External Control	13
About the external control	13
Using the MAKE/TRIGGER system	13
Troubleshooting	14
Specifications	15
General.....	15
Input/output terminals.....	16
Dimensions.....	16

Safety Precautions

WARNING: TO REDUCE RISK OF FIRE OR ELECTRIC SHOCK, DO NOT EXPOSE THIS APPARATUS TO RAIN OR MOISTURE. NO OBJECTS FILLED WITH LIQUIDS, SUCH AS VASES, SHALL BE PLACED ON THE APPARATUS.

IMPORTANT SAFEGUARDS

Electrical energy can perform many useful functions. This unit has been engineered and manufactured to assure your personal safety. But **IMPROPER USE CAN RESULT IN POTENTIAL ELECTRIC SHOCK OR FIRE**. In order not to defeat the safeguards incorporated into this product, observe the following basic rules for its installation, use, and service. Please read these "IMPORTANT SAFEGUARDS" carefully before use.

- All the safety and operating instructions should be read before the product is operated.
- The safety and operating instructions should be retained for future reference.
- All warnings on the product and in the operating instructions should be adhered to.
- All operating instructions should be followed.

POWER CONNECTION

The power supply voltage rating of this product is AC 120 V (For U.S.A. and Canada) and AC 220 – 240 V (For European countries, Asian countries, and United Kingdom).

The power cord attached conforms to the following power supply voltage and countries. Use only the power cord designated to ensure safety and EMC regulations of each country.

For U.S.A. and Canada: AC 120 V
(not supplied)



For European and Asian countries:
AC 220 – 240 V



For United Kingdom:
AC 220 – 240 V



This plug will fit only into a grounded power outlet. If you are unable to insert the plug into the outlet, contact your electrician to install the proper outlet. Do not defeat the safety purpose of the grounded plug.

- This product should be operated only with the type of power source indicated on the label. If you are not sure of the type of power supply of your home, consult your product dealer or local electric power company.

Warning:

- Do not use the same power cord for AC 120 V as for AC 220 – 240 V. Doing so may cause malfunction, electric shock or fire.

Note for United Kingdom power cord only

The plug of United Kingdom power cord has a built-in fuse. When replacing the fuse, be sure to use only a correctly rated approved type, re-fit the fuse cover. (Consult your dealer or qualified personnel.)

How to replace the fuse

Open the fuse compartment with the blade screwdriver, and replace the fuse.

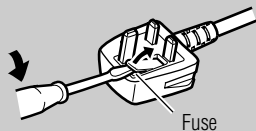

- Before connecting other products such as VCR's and personal computers, you should turn off the power of this product for protection against electric shock.
- Do not use attachments not recommended by the manufacturer as they may be hazardous.
- **When replacement parts are required**, be sure the service technician has used replacement parts specified by the manufacturer or equivalents. Unauthorized substitutions may result in fire, electric shock, or other hazards.
- **Upon completion of any service or repairs to this product**, ask the service technician to perform safety checks to determine that the product is in proper operating condition.

Under the following conditions,

1. Turn off the power.
2. Unplug this product from the wall outlet.
3. Refer service to qualified service personnel.
 - a) When the product emits smoke or unusual smell.
 - b) When the product exhibits a distinct change in performance—for example, no picture or no sound.
 - c) If liquid has been spilled, or objects have fallen on the product.
 - d) If the product has been exposed to rain or water.
 - e) If the product has been dropped or damaged in any way.
 - f) When the power supply cord or plug is damaged.

- Do not install this product in the following places:
 - in a damp or dusty room
 - where the product is exposed to soot or steam, such as near the cooking counter or a humidifier
 - near heat sources
 - where condensation easily occurs, such as near the window
 - Do not place this product on an unstable cart, stand, or table. The product may fall, causing serious injury to a child or adult, and serious damage to the product.
- The product should be mounted according to the manufacturer's instructions, and should use a mount recommended by the manufacturer.
- Do not use this product near water.
 - Be sure to install the product in the place where proper temperature and humidity are kept (see "Operating conditions" on page 15). This product becomes hot during its use. Take enough care when handling the product.

Do not attempt to service this product yourself, as opening or removing covers may expose you to dangerous voltages and other hazards. Refer all service to qualified service personnel.

Do not use the product for a long time if the sound is distorted.

- Make enough room for inserting or removing the power plug. Place the product as close to an AC outlet as possible. The main power supply for the product is controlled by inserting or removing the power plug.
- When you install the product in a place where you cannot easily insert or remove the power plug from an AC outlet, insert or remove the power cord from the AC inlet on the product.
- When the product is left unattended and unused for a long period of time, unplug it from the wall outlet and disconnect the cable system.
- Do not overload wall outlets, extension cords, or convenience receptacles on other equipment as this can result in a risk of fire or electric shock.
- Use only the accessory cord designed for this product to prevent shock.

- Slots and openings in the cabinet are provided for ventilation. These ensure reliable operation of the product and protect it from overheating. These openings must not be blocked or covered.
- Never push objects of any kind into this product through openings as they may touch dangerous voltage points or short-circuit the parts, which could result in a fire or electric shock.
- Never spill liquid of any kind on the product.
- Never place anything on the product. (Placing liquids, naked flames, cloths, paper, etc. on the product may cause a fire.)
- Do not apply any strong shock to the LCD panel. (Do not hit any object against it or push it with a sharp-pointed tool.)
- Do not put heavy objects on the product.
- Do not step on or hang on the product.

U.S.A. only

FCC NOTICE (U.S.A. only)

CAUTION: Changes or modifications not approved by JVC could void the user's authority to operate the equipment.

NOTE: This equipment has been tested and found to comply with the limits for a Class B digital device, pursuant to Part 15 of the FCC Rules. These limits are designed to provide reasonable protection against harmful interference in a residential installation. This equipment generates, uses and can radiate radio frequency energy and, if not installed and used in accordance with the instructions, may cause harmful interference to radio communications. However, there is no guarantee that interference will not occur in a particular installation. If this equipment does cause harmful interference to radio or television reception, which can be determined by turning the equipment off and on, the user is encouraged to try to correct the interference by one or more of the following measures:

- Reorient or relocate the receiving antenna.
- Increase the separation between the equipment and receiver.
- Connect the equipment into an outlet on a circuit different from that to which the receiver is connected.
- Consult the dealer or an experienced radio/TV technician for help.

IMPORTANT RECYCLING INFORMATION

This product has a fluorescent lamp that contains mercury. Disposal of these materials may be regulated in your community due to environmental considerations. For disposal or recycling information, please contact your local authorities or for USA, the Electronic Industries Alliance: <http://www.eiae.org>

European Union only

Dear Customer,

This apparatus is in conformance with the valid European directives and standards regarding electromagnetic compatibility and electrical safety.

European representative of Victor Company of Japan, Limited is:
JVC Technical Services Europe GmbH
Postfach 10 05 04
61145 Friedberg
Germany

Information for Users on Disposal of Old Equipment



[European Union]

This symbol indicates that the electrical and electronic equipment should not be disposed as general household waste at its end-of-life. Instead, the product should be handed over to the applicable collection point for the recycling of electrical and electronic equipment for proper treatment, recovery and recycling in accordance with your national legislation.

Attention:

This symbol is only valid in the European Union.

By disposing of this product correctly, you will help to conserve natural resources

and will help prevent potential negative effects on the environment and human health which could otherwise be caused by inappropriate waste handling of this product. For more information about collection point and recycling of this product, please contact your local municipal office, your household waste disposal service or the shop where you purchased the product.

Penalties may be applicable for incorrect disposal of this waste, in accordance with national legislation.

(Business users)

If you wish to dispose of this product, please visit our web page www.jvc-europe.com to obtain information about the take-back of the product.

[Other Countries outside the European Union]

If you wish to dispose of this product, please do so in accordance with applicable national legislation or other rules in your country for the treatment of old electrical and electronic equipment.

European Union only

EMC Supplement

This equipment is in conformity with the provisions and protection requirements of the corresponding European Directives. This equipment is designed for professional video appliances and can be used in the following environments:

- residential (including both of the location types class 1 and 2 found in IEC 1000-2-5)
- commercial and light industrial (including, for example, theatres)

In order to keep the best performance and ensure electromagnetic compatibility, we recommend to use cables not exceeding the following length:

Cable		Length
Power cord	(attached cable (H05VV-F 3 x 0.75 mm ²))	2.0 m
Video signal cable	(coaxial cable)	2.0 m
Audio signal cable	(shielded cable)	1.5 m
DVI cable	(shielded cable)	2.0 m
RGB cable	(shielded cable)	2.0 m
REMOTE cable	(twist pair cable)	10.0 m
(A straight LAN cable)		

The inrush current of this apparatus is 9.655 ampere.

CAUTION

In case where the strong electromagnetic waves or magnetism are near the audio cable or the signal cable, the sound or the picture will contain noise. In such cases, please keep the cable away from the sources of the disturbance.

Maintenance

Unplug this product from the wall outlet before cleaning.

Screen

To avoid irreparable change in appearance of the screen such as uneven color, discoloration, scratches, be careful about the following:

- Do not paste or stick anything using any glues or adhesive tapes.
- Do not write anything on the screen.
- Do not strike the screen with a hard object.
- Avoid condensation on the screen.
- Do not wipe the screen with solvent such as alcohol, thinner, or benzine.
- Do not wipe the screen forcefully.

If the screen gets stained, wipe it with a soft dry cloth, a soft damp cloth, or a soft cloth soaked in water-diluted neutral detergent and wrung well.

Cabinet

To avoid the deterioration or damages of the cabinet such as its paint's peeling away, be careful about the following:

- Do not wipe the cabinet using solvent such as alcohol, thinner, or benzine.
- Do not expose the cabinet to any volatile substance such as insecticides.
- Do not allow any rubber or plastic in contact for a long time.
- Do not wipe the cabinet forcefully.

Wipe stains off the cabinet with a soft cloth. If the cabinet gets heavily stained, wipe it with a soft cloth soaked in water-diluted neutral detergent and wrung well, then wipe with a soft dry cloth.

Ventilation openings

Use a vacuum cleaner to get rid of the dust around the intakes (all the openings). If a vacuum cleaner is not available, use a cloth and wipe it off. Leaving the dust around the intakes may prevent proper temperature control and cause damage to the product.

CAUTION

- Do not rest your arm on the monitor or lean against the monitor.
- Do not touch the LCD panel when installing the monitor.
- Make sure to install the monitor securely to prevent the monitor from falling over, which causes damage to the monitor or injury.

You can tilt the monitor as follows:

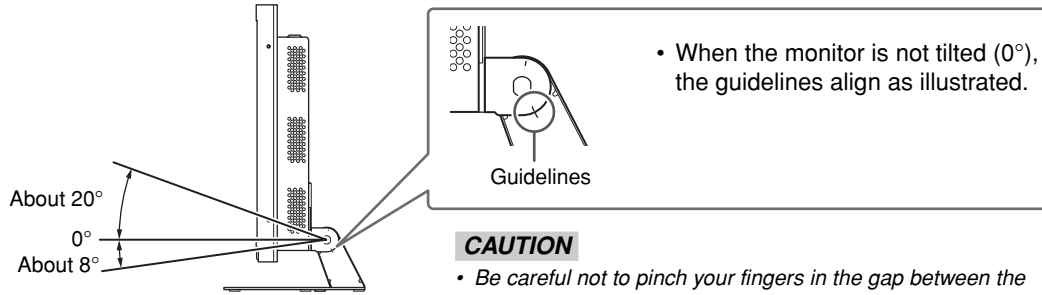

CAUTION

- Be careful not to pinch your fingers in the gap between the monitor and the stand.
- When the stand plate is attached to the lower position of the stand body (see "To adjust the stand height" on page 5), you cannot tilt the monitor downward.

The illustration of the monitor is of LM-H191.

You can lift the stand up and place the monitor as illustrated below.

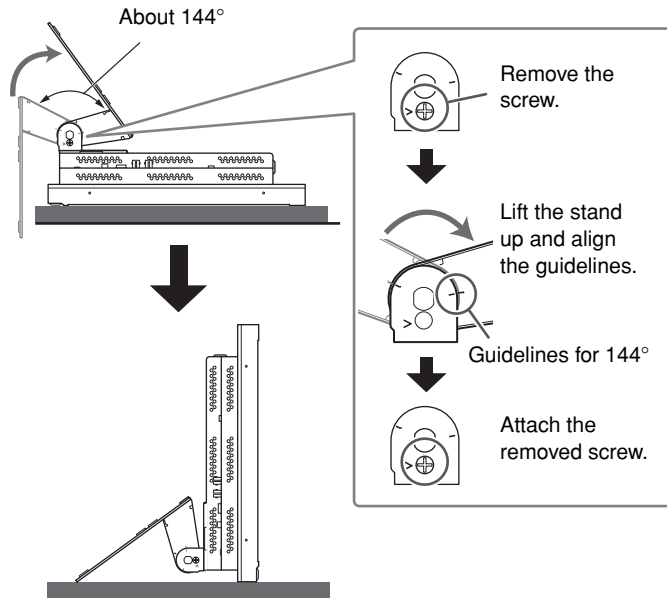

CAUTION

- When lifting up the stand, lay the monitor on a cloth with the LCD panel facing down to prevent the LCD panel from being damaged.
- Be careful not to pinch your fingers in the moving parts.
- When lifting up the stand, make sure to align the guidelines for 144° and fasten the screw; otherwise the monitor may fall over.
- Place the monitor on a mat to avoid scratching the table surface.
- Do not lift up the stand when the stand plate is attached to the lower position of the stand body (see "To adjust the stand height" on page 5).

The illustration of the monitor is of LM-H191.

To detach the stand

CAUTION

Lay the monitor on a cloth with the LCD panel facing down to prevent the LCD panel from being damaged.

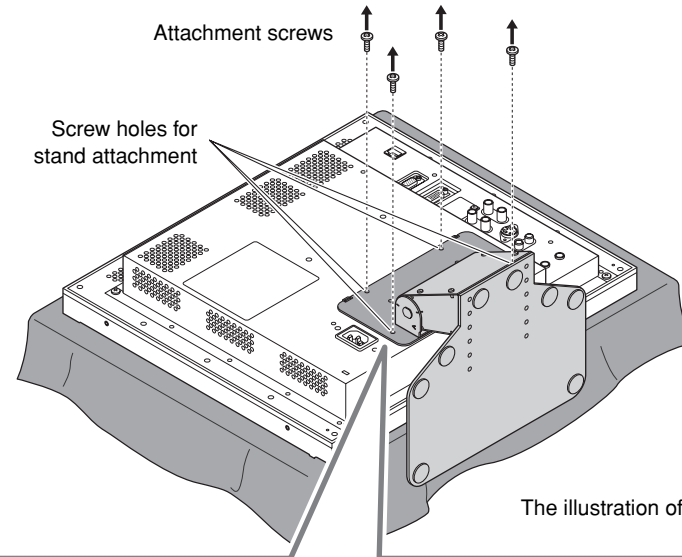

The illustration of the monitor is of LM-H191.

When installing the stand to the monitor, insert the guides of the stand plate into the guide holes on the monitor to place the stand on the correct position. Then fix the stand firmly with the attachment screws.

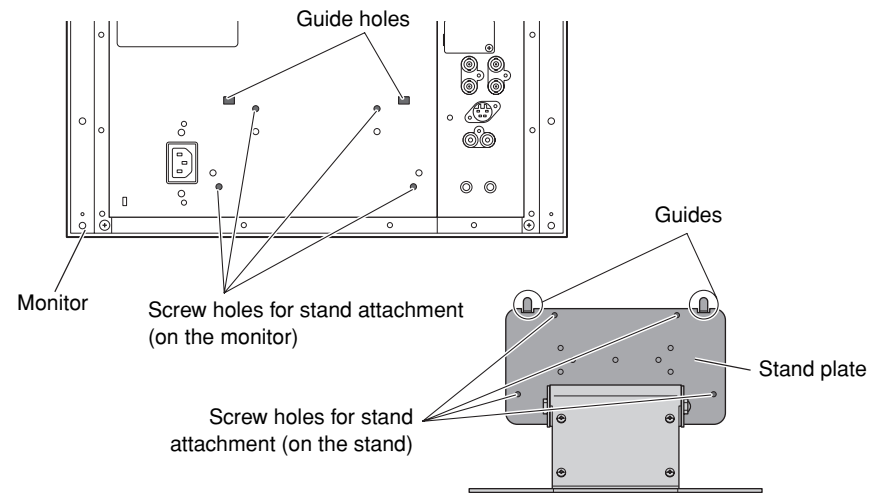

To adjust the stand height

To change the stand height, change the position of the stand plate as illustrated below after detaching the stand from the monitor.

- For detaching the stand, see “To detach the stand” on page 4.

<Higher position>

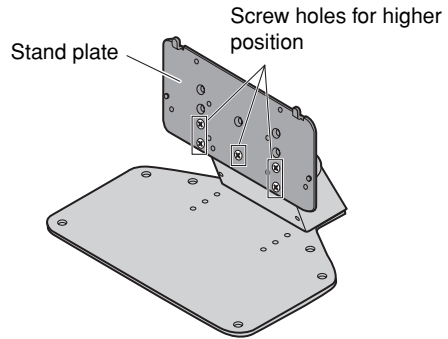

<Lower position>

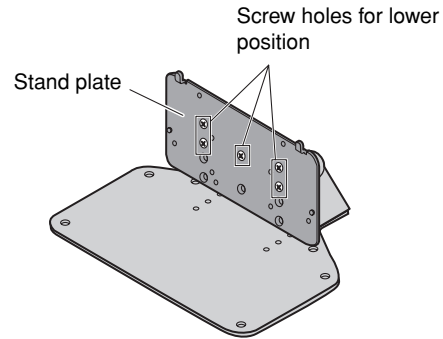

To prevent an accidental fall

Fix the monitor to a wall by using strings.

Fixing the monitor

Attach the hook (not provided) to the VESA mounting holes on the rear panel using M4 x 10 mm screws (not provided). Bind the hooks on the rear panel of the monitor to a wall or a pillar using durable string.

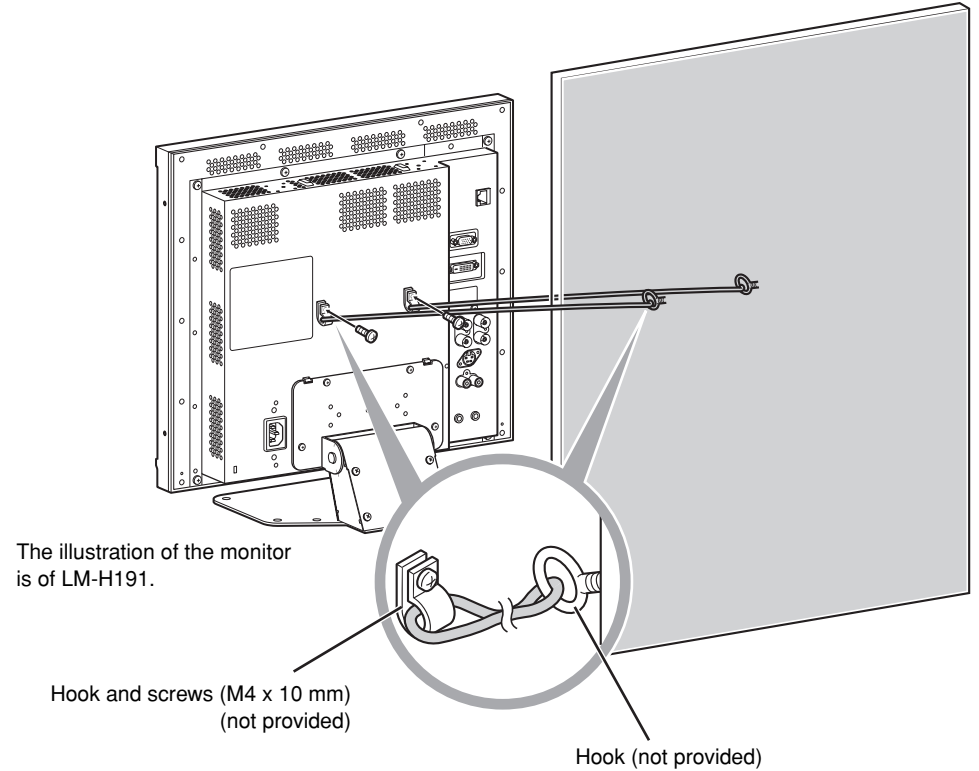

■ Front panel



The illustration of the monitor is of LM-H191.

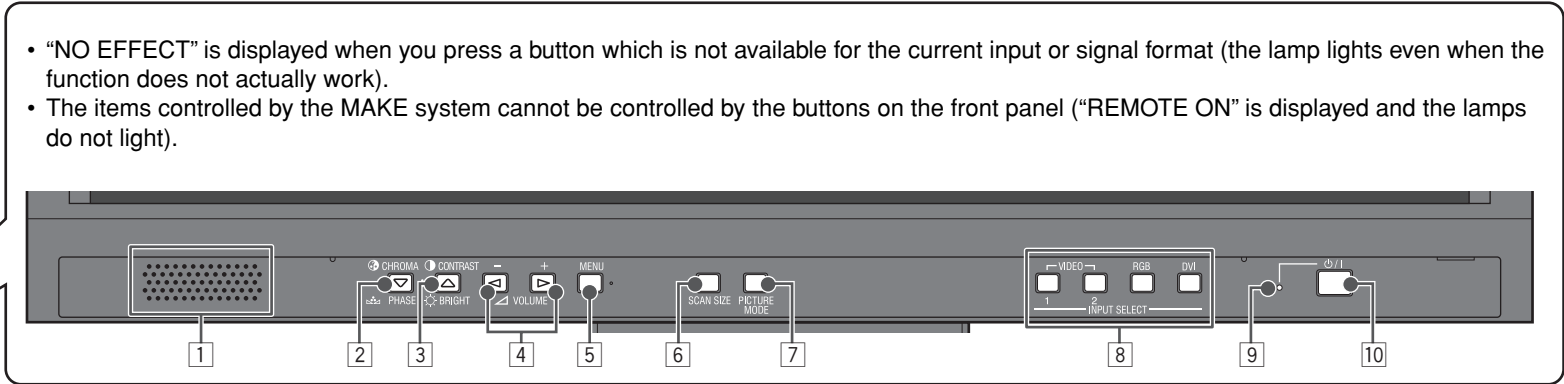

- “NO EFFECT” is displayed when you press a button which is not available for the current input or signal format (the lamp lights even when the function does not actually work).
- The items controlled by the MAKE system cannot be controlled by the buttons on the front panel (“REMOTE ON” is displayed and the lamps do not light).

1 Speaker (monaural)

The speaker emits the audio signal for the selected input.

2 CHROMA/PHASE (∇) button*1

Displays the adjustment bar for the picture color density or hue.

- Each time you press the button, the adjustment for chroma and phase changes.
- To adjust, press ◀ or ▶ (4) button.
- The adjustment is memorized for each Picture Mode (7).

3 CONTRAST/BRIGHT (Δ) button*1

Displays the adjustment bar for the picture contrast or brightness.

- Each time you press the button, the adjustment for contrast and brightness changes.
- To adjust, press ◀ or ▶ (4) button.
- The adjustment is memorized for each Picture Mode (7).

4 VOLUME -/+ (◀ / ▶) buttons*2

Adjusts the volume.

5 MENU button

Displays the MAIN MENU.

- To display the SET UP MENU, press ∇ button while pressing MENU button.
- For the menu operations, see page 7.

6 SCAN SIZE button/lamp

Selects the screen size when VIDEO 1 or VIDEO 2 is selected for the input.

- Each time you press the button, the screen size changes as follows:

OVER ↔ NARROW

- When “NARROW” is selected, the lamp lights.
- When “NARROW” is selected, black bars appear on the top and the bottom of the screen because the aspect ratio of the LCD panel is 5:4.
- This setting is not available for signals from a computer is selected for the input.

7 PICTURE MODE button/lamp

Selects the Picture Mode.*3

STD.: Normal picture

DARK ENHANCED: Makes the dark parts of the picture clear.

VIVID: Makes the picture vivid.

DYNAMIC: Makes the picture bright.

- When “DARK ENHANCED,” “VIVID,” or “DYNAMIC” is selected, the lamp lights.

- When RGB or DVI is selected for the input, the Picture Mode is fixed to “STD.”

- When “DYNAMIC” is selected, high luminance parts of pictures may not be displayed properly. In this case, select another Picture Mode.

8 INPUT SELECT buttons/lamps

Selects an input.

VIDEO 1: VIDEO 1 IN or Y/C terminal

VIDEO 2: VIDEO 2 IN terminal

RGB: RGB terminal*4

DVI: DVI-D terminal

- The lamp for the selected input lights.

9 Power lamp

Unlit: The monitor is completely off (the AC plug is not connected).

Lights in Green: The monitor is on or in the Gray Back mode (⏻ “NO SYNC ACTION” in “SYNC FUNCTION” on page 12).

Lights in orange: The monitor is off (on standby).

Flashes in orange: The monitor is in the Power Save mode (⏻ “NO SYNC ACTION” in “SYNC FUNCTION” on page 12).

10 ⏻ / I button

Turns on and off (on standby) the monitor.

*1 When a menu screen or adjustment bar is displayed, these buttons work as Δ / ∇ to select an item.

*2 When a menu screen or adjustment bar is displayed, these buttons work as ◀ / ▶ to adjust the item or select an option.

*3 To reset the adjustments for each Picture Mode, see “Resetting the Picture Mode” (⏻ page 7).

*4 Before using this input, perform “AUTO ADJUST” (⏻ “AUTO ADJUST” on page 10).

Resetting the Picture Mode

You can reset the following picture adjustments you have made for each Picture Mode.

- Adjustments by the buttons on the front panel
- "SHARPNESS," "CTI.," and "LTI." in the MAIN MENU (see page 10)

1 Press PICTURE MODE button repeatedly to select the mode you want to reset.

2 Press and hold PICTURE MODE button.

The confirmation message appears.

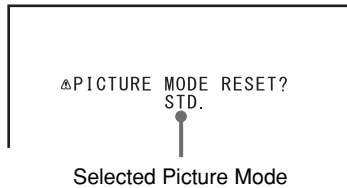

3 Press PICTURE MODE button.

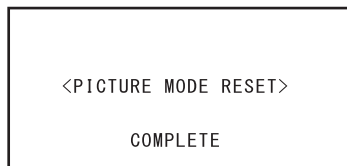

Main Menu Operations

1 Press MENU button.

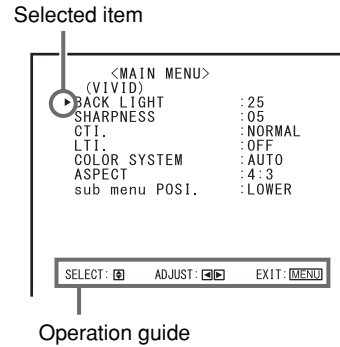

2 Press Δ ∇ buttons to select an item, then press ◀ ▶ buttons to make adjustments.

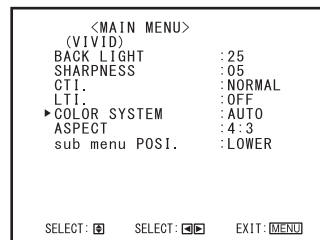

Ex.: When "COLOR SYSTEM" is selected

3 Press MENU button to finish the menu operation.

Setup Menu Operations

1 Press ∇ button while pressing MENU button.

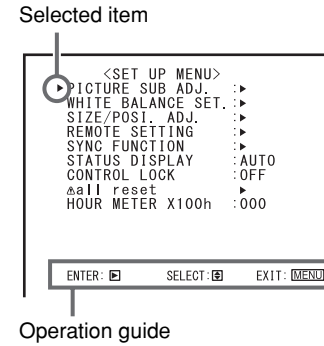

2 Press Δ ∇ buttons to select an item, then press ▶.

- For some items, adjustments will be made by pressing ◀ ▶.

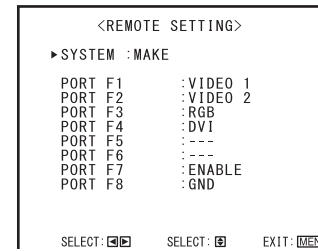

Ex.: When "REMOTE SETTING" is selected

3 Press Δ ∇ buttons to select an item, then press ◀ ▶ buttons to make adjustments.

4 Press MENU button to return to the previous menu.

- Pressing the button again finishes the menu operation.

■ Rear panel

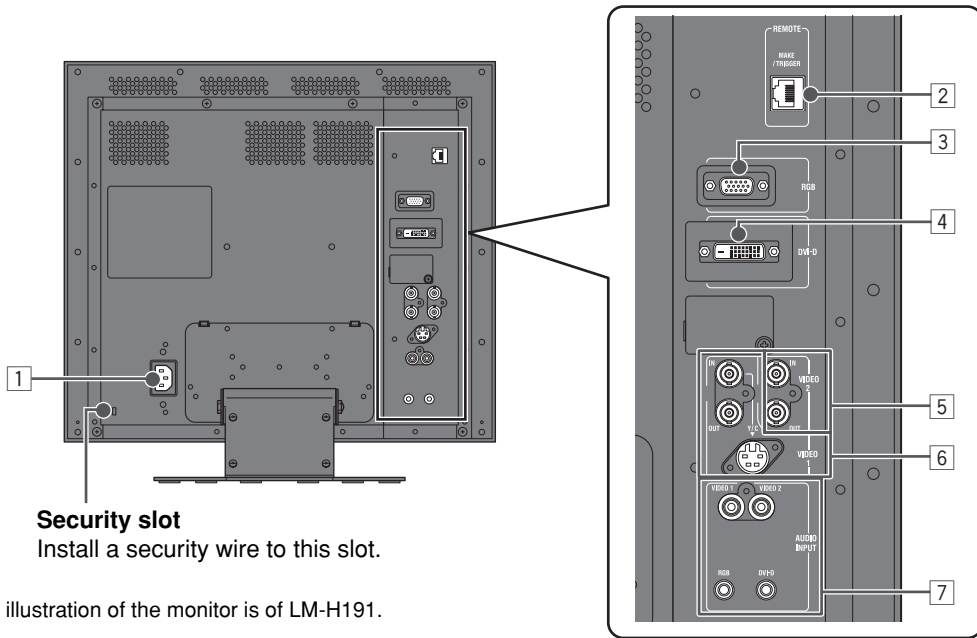

Security slot
Install a security wire to this slot.

The illustration of the monitor is of LM-H191.

Note for connections

- Before making any connections, turn off all the equipment.
- Use a cord whose plugs correctly match the terminals on this monitor and the equipment.
- Plugs should be firmly inserted; poor connections could cause noise.
- When unplugging a cord, be sure to grasp its plug and pull it out.
- DO NOT connect the power cord until all connections are completed.
- Refer also to the user manual of each piece of equipment.

1 AC IN terminal

- AC power input connector.
- Connect the provided AC power cord to an AC outlet.

2 REMOTE terminal (MAKE/TRIGGER)

- Terminal for controlling the monitor by an external control.
- ☞ “External Control” on page 13

3 RGB terminals

- Input terminal for the analog RGB signals.
- Use the AUDIO INPUT RGB terminal (7) for audio connection.

4 DVI-D terminal

- Input terminal for the DVI-D signal from a personal computer.
- Use the AUDIO INPUT DVI-D terminal (7) for audio connection.

5 VIDEO 2 IN/OUT terminals

- Input (IN) and output (OUT) terminals for the composite signals.
- Use the AUDIO INPUT VIDEO 2 terminal (7) for audio connection.

6 VIDEO 1 IN/OUT, Y/C terminals

- Input (IN) and output (OUT) terminals for the composite signals and input terminal for S-video signals (Y/C).
- When both the IN and Y/C terminals are used, signals to the Y/C terminal have priority.
- Use the AUDIO INPUT VIDEO 1 terminal (7) for audio connection.

7 AUDIO INPUT VIDEO 1/VIDEO 2/RGB/DVI-D terminals

- Input terminals for the analog audio signals.
- Use the video terminal with the same name for video connection.

Attaching the Ferrite Core

Attach the ferrite core to the power cord.

- Using the power cord without the ferrite core may lead to noise (interference).

- 1 Open the ferrite core, insert the power cord and close the ferrite core.
- 2 Attach the ferrite core to the AC IN end of the power cord.

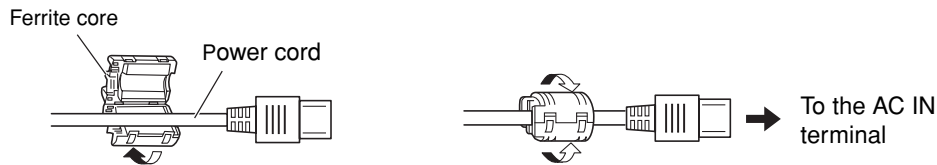

■ Available signals

Signal type	Frequency		Status display*	Input terminal			
	Horizontal (kHz)	Vertical (Hz)		VIDEO 1 IN / Y/C	VIDEO 2 IN	RGB	DVI-D
NTSC (3.58)	15.734	(60/)/59.94	NTSC NTSC (Y/C)	√	√	—	—
BW/60	15.734	(60/)/59.94	BW60	√	√	—	—
PAL	15.625	50	PAL PAL (Y/C)	√	√	—	—
BW/50	15.625	50	BW50	√	√	—	—
480/60p	31.5/31.469	60/50.94	640x480 60Hz	—	—	√	—
576/50p	31.25	50	640x576 50Hz	—	—	√	—
VGA	31.47	59.94	640x480 60Hz	—	—	√	√
VGA_TEXT	31.47	70.08	720x400 70Hz	—	—	√	—
SVGA	35.15	56.25	800x600 56Hz	—	—	√	—
	37.879	60.317	800x600 60Hz	—	—	√	√
XGA	48.363	60.004	1024x768 60Hz	—	—	√	√
	56.476	70.069	1024x768 70Hz	—	—	√	—
WXGA	47.396	59.99	1280x768 60Hz	—	—	√	√
SXGA	63.981	60.02	1280x1024 60Hz	—	—	√	√

√: Acceptable
—: Not acceptable

- Some signals may not be displayed normally even if its frequency is within the acceptable range (☞ “Horizontal/vertical frequency (computer signal)” on page 15).
- When WXGA is displayed, black bars appear on the top and the bottom of the screen.

* About the Status Display

When “STATUS DISPLAY” (☞ page 12) is set to “AUTO,” the status is displayed for about 3 seconds in the following cases:

- When you press the INPUT SELECT button of the current input
- When you change the input
- When the signal condition of the current input changes
- When you turn on the monitor
 - “NO SYNC” is displayed when no video signal comes in.
 - “Out of range” is displayed for a noncompliant video signal input.

Specification of the Y/C terminal

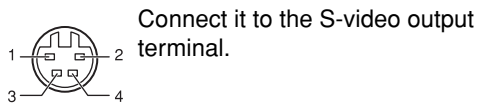

Pin No.	Input signal
1	GND (Y)
2	GND (C)
3	Y
4	C

Specification of the RGB terminal

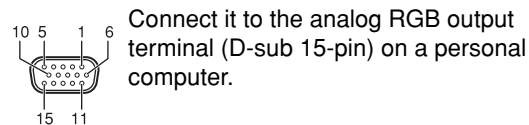

Pin No.	Input signal	Pin No.	Input signal
1	Red	9	+5 V
2	Green	10	GND
3	Blue	11	GND
4	—	12	DDC Data
5	GND	13	Horizontal/ composite sync
6	GND	14	Vertical sync
7	GND	15	DDC Clock
8	GND	External	GND

Specification of the DVI-D terminal

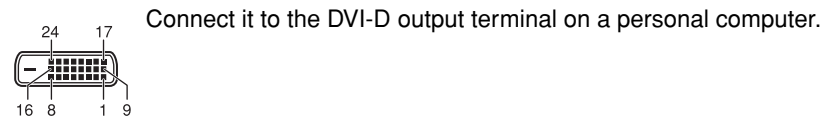

Pin No.	Input signal	Pin No.	Input signal	Pin No.	Input signal
1	T.M.D.S Data 2–	9	T.M.D.S Data 1–	17	T.M.D.S Data 0–
2	T.M.D.S Data 2+	10	T.M.D.S Data 1+	18	T.M.D.S Data 0+
3	T.M.D.S Data 2 shield	11	T.M.D.S Data 1 shield	19	T.M.D.S Data 0 shield
4	NC	12	NC	20	NC
5	NC	13	NC	21	NC
6	DDC Clock	14	+5 V Power	22	T.M.D.S Clock shield
7	DDC Data	15	GND	23	T.M.D.S Clock+
8	NC	16	Hot Plug Detect	24	T.M.D.S Clock–

For the operation procedure, see page 7.

When VIDEO 1 or VIDEO 2 is selected for the input:

```

<MAIN MENU>
(VIVID)
▶BACK LIGHT      :25
SHARPNESS       :05
CTI.            :NORMAL
LTI.            :OFF
COLOR SYSTEM    :AUTO
ASPECT          :4:3
sub menu POSI.  :LOWER
    
```

Selected Picture Mode
Select by pressing PICTURE MODE on the front panel (page 6). (Not displayed when "STD." is selected.)

Operation guide
Shows the buttons for each operation.

SELECT: [ENTER] ADJUST: [LEFT] [RIGHT] EXIT: [MENU]

BACK LIGHT Setting value: 00 – 25

Adjusts the brightness of the display.

SHARPNESS*1, 2 Setting value: 00 – 10

Adjusts the sharpness of the picture.

CTI.*1, 2 Setting value: OFF, NORMAL, HARD

Adjusts the clearness of the outlines of the chrominance signal.

- This setting does not affect BW signals.

LTI.*1, 2 Setting value: OFF, NORMAL, HARD

Adjusts the clearness of the outlines of the luminance signal.

COLOR SYSTEM*1 Setting value: AUTO, NTSC, PAL

Selects the color system.

- If the picture is unstable with "AUTO," select "NTSC" or "PAL."

ASPECT*1 Setting value: 4:3, 16:9

Selects the aspect ratio.

sub menu POSI. Setting value: LOWER, UPPER

Selects the position of the picture adjustment bar and volume adjustment bar.

AUTO ADJUST*3

Adjusts pictures of analog RGB signals automatically. Perform this adjustment when you input analog RGB signals for the first time.

- Pictures may not be adjusted properly when you perform "AUTO ADJUST" with a picture of texts or images on a black background. Perform "AUTO ADJUST" when an image is displayed fully on the screen.
- After performing "AUTO ADJUST," you can adjust each item manually.

When RGB is selected for the input:

```

<MAIN MENU>
▶BACK LIGHT      :25
sub menu POSI.   :LOWER
AUTO ADJUST     :▶
H. SIZE         :00
H. POSI.        :00
V. SIZE         :00
V. POSI.        :00
DOT CLOCK       :00
CLOCK PHASE     :00
    
```

Press > to perform "AUTO ADJUST."

Operation guide
Shows the buttons for each operation.

SELECT: [ENTER] ADJUST: [LEFT] [RIGHT] EXIT: [MENU]

When DVI is selected for the input:

```

<MAIN MENU>
▶BACK LIGHT      :25
sub menu POSI.   :LOWER
    
```

Operation guide
Shows the buttons for each operation.

SELECT: [ENTER] ADJUST: [LEFT] [RIGHT] EXIT: [MENU]

Item	To do	Setting value
H.SIZE*4	Adjust the horizontal picture size.	-10 – 00 – +10
H.POSI.*4	Adjust the horizontal picture position.	000 – 100
V.SIZE*4	Adjust the vertical picture size.	-10 – 00 – +10
V.POSI.*4	Adjust the vertical picture position.	000 – 082*5
DOT CLOCK*4	Eliminates stripes or flickering by adjusting the both settings.	000 – 100
CLOCK PHASE*4		000 – 063

- The menu automatically disappears in about 30 seconds after the previous operation.
- Some items may not appear on the menu depending on the input or the input signal.
- The items controlled by the MAKE system do not appear on the menu.

*1 Displayed only when VIDEO 1 or VIDEO 2 is selected for the input.

*2 Memorized for each Picture Mode (page 6). (" [7] PICTURE MODE button/lamp" on page 6).

*3 Displayed only when RGB is selected for the input.

*4 Memorized for each signal format. For some signals, the adjustment may not take effect.

*5 The maximum value is different depending on the incoming signal format ("082" is an example for SXGA signals).

Menu Configuration—SET UP MENU

For the operation procedure, see page 7.

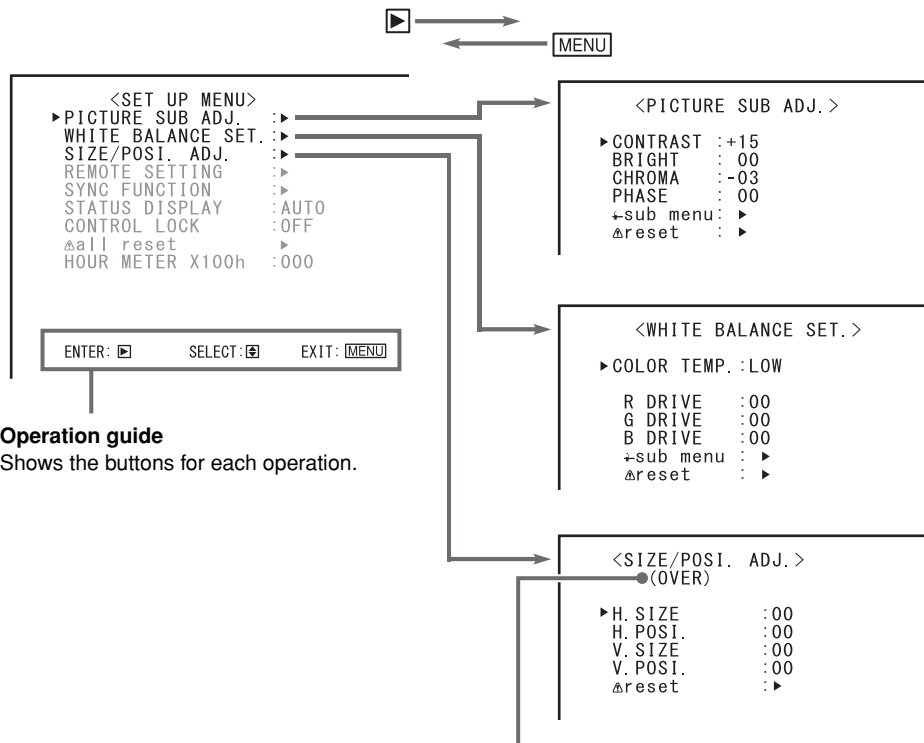

Operation guide

Shows the buttons for each operation.

Selected screen size

Select by pressing SCAN SIZE on the front panel (☞ [6] on page 6).

- The menu automatically disappears in about 30 seconds after the previous operation.
- Some items may not appear on the menu depending on the input or the input signal.
- The items controlled by the MAKE system do not appear on the menu.

PICTURE SUB ADJ.

Adjusts the standard level for the picture adjustment.

Item	To do	Setting value
CONTRAST*1	Adjust the standard level for the contrast adjusted with CONTRAST button on the front panel.	-40 – +40
BRIGHT*1	Adjust the standard level for the brightness adjusted with BRIGHT button on the front panel.	
CHROMA*1, 2	Adjust the standard level for the chroma adjusted with CHROMA button on the front panel.	
PHASE*1, 2	Adjust the standard level for the phase adjusted with PHASE button on the front panel.	
sub menu	Display the adjustment bar for each item of “PICTURE SUB ADJ.” Select an item by pressing Δ ∇, then adjust the picture while viewing the actual picture.	
reset	Restore the default settings for all the items in “PICTURE SUB ADJ.” regardless of the adjustments for the Picture Mode (☞ “[7] PICTURE MODE button/lamp” on page 6).	

WHITE BALANCE SET.

Selects the color temperature and adjusts the drive level of each color (R/G/B).

Item	To do	Setting value
COLOR TEMP.	Select the color temperature.	HIGH, LOW, USER
R DRIVE, G DRIVE, B DRIVE*3	Adjust the drive level of each color (red, green, and blue).	-20 – +20 (-255 – 255 when “USER” is selected for “COLOR TEMP.”)
sub menu	Display the adjustment bar for each item of “WHITE BALANCE SET.” Select an item by pressing Δ ∇, then adjust the picture while viewing the actual picture.	
reset	Restore the default settings for all the items in “WHITE BALANCE SET.”	

SIZE/POSI. ADJ.*2

Adjusts the size and position of the picture.

- When RGB is selected for the input, perform “AUTO ADJUST” (☞ page 10).

Item	To do	Setting value
H.SIZE*4	Adjust the horizontal picture size.	-5 – +10 – +20
H.POSI.*4	Adjust the horizontal picture position.	-20 – 00 – +20
V.SIZE*4	Adjust the vertical picture size.	-10 – +5 – +15
V.POSI.*4	Adjust the vertical picture position.	-20 – 00 – +20
reset	Restore the default settings for all the items in “SIZE/POSI. ADJ.”	

*1 Memorized for each input.

*2 Displayed only when VIDEO 1 or VIDEO 2 is selected for the input.

*3 Memorized for each input. Also, memorized for each color temperature setting.

*4 Memorized for each input. Also, memorized for each SCAN SIZE setting.

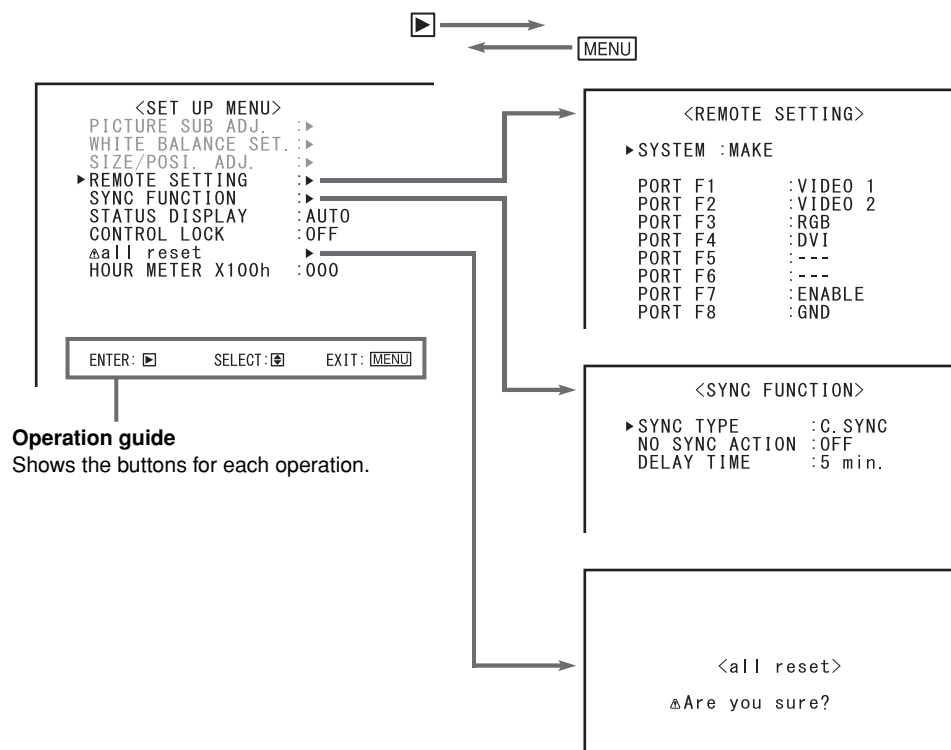

Operation guide
Shows the buttons for each operation.

- The menu automatically disappears in about 30 seconds after the previous operation.
- Some items may not appear on the menu depending on the input or the input signal.
- The items controlled by the MAKE system do not appear on the menu.

REMOTE SETTING

Setting for the external control (☞ “External Control” on page 13)

Item	To do	Setting value
SYSTEM	Select the external control method for the MAKE/TRIGGER terminal.	MAKE, TRIGGER
PORT F1 – PORT F6	Assign the control functions to the pins of the MAKE/TRIGGER terminal. • You cannot change the functions assigned for “PORT F7” and “PORT F8.”	VIDEO 1, VIDEO 2, RGB, DVI, STD., DARK ENHANCED, VIVID, DYNAMIC, AUTO ADJ., SCAN SIZE, ASPECT, STAND BY/ON, --- (no function)

- “STAND BY/ON” is not available when “SYSTEM” is “MAKE.”

SYNC FUNCTION

Setting for the synchronization with signals

Item	To do	Setting value
SYNC TYPE	Select the sync signal for RGB input.	H/V. SYNC, C.SYNC, G.ON SYNC
NO SYNC ACTION	Select the screen status when no signal is coming in.	OFF, POWER SAVE (Power Save mode), GRAY BACK (Gray Back mode)
DELAY TIME	Select the period until the screen status changes as selected in “NO SYNC ACTION” after signals stop coming in.	30 sec., 5 min., 15 min.

- The C.SYNC input level is TTL (☞ page 16).

STATUS DISPLAY

Setting value: AUTO, OFF

☞ “About the Status Display” on page 9

CONTROL LOCK

Setting value: OFF, ON

Turns on (or off) the control lock function to disable the buttons on the front panel.

- The following operations are available even when this function is activated.
 - Turning on/off (on standby) the monitor
 - Displaying the SET UP MENU (by pressing ▽ button while pressing MENU button) and turning “CONTROL LOCK” to “OFF”
 - Operating the monitor by an external control
- If you try other operations, “Control lock on!” appears on the screen.

all reset

Restores all the settings and adjustments of the monitor to the default.

- “HOUR METER X100h” will not be reset.

HOUR METER X100h

Displays the total hours of use. This item is used for maintenance of the monitor.

- The hour is shown in 100-hour unit.
- The hour will not be reset.
- The hour is reset to “000” after the total hours of use have reached to “999.”
- Use time less than 1 minute is not accumulated.

External Control

■ About the external control

This monitor has the MAKE/TRIGGER terminal, which allows you to control the monitor by the make contact or the trigger system.

- **MAKE (make contact) system:** Controls the monitor by short-circuiting the corresponding pin terminal to the GND pin terminal, or disconnecting (opening) it.
- **TRIGGER (trigger) system:** Controls the monitor by sending the pulse signal instantaneously to the corresponding pin terminal.

Control priority is as follows.

MAKE > TRIGGER/buttons and menu on the monitor

- You can use the external control even when "CONTROL LOCK" is set to "ON" (page 12).

■ Using the MAKE/TRIGGER system

The MAKE/TRIGGER terminal is configured as follows. You can assign a function to each pin terminal in "REMOTE SETTING" ("PORT F1" – "PORT F6" on page 12).

- You cannot change the functions assigned to the pin terminals from 7th and 8th.

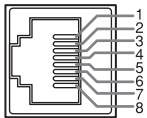

This is a female terminal.

Pin No.	Pin name	Pin No.	Pin name
1	PORT F1	5	PORT F5
2	PORT F2	6	PORT F6
3	PORT F3	7	ENABLE ^{*1}
4	PORT F4	8	GND

^{*1}The 7th pin terminal makes the external control valid/invalid. Make sure to control the terminal by the MAKE system.

To assign the functions to the pin terminals

For the operation procedure, see page 7.

- 1 Select "REMOTE SETTING" on the SET UP MENU.
- 2 Select a pin name ("PORT F1" – "PORT F6") for which you want to assign a function, then select the function you want to assign.
 - For selectable functions, see the tables below.

Display	Functions to be controlled	Opening	Short-circuiting
VIDEO 1	Changes the input to "VIDEO 1."	Invalid	Valid
VIDEO 2	Changes the input to "VIDEO 2."	Invalid	Valid
RGB	Changes the input to "RGB."	Invalid	Valid
DVI	Changes the input to "DVI."	Invalid	Valid
STD.	Changes the Picture Mode to "STD."	Invalid	Valid
DARK ENHANCED	Changes the Picture Mode to "DARK ENHANCED."	Invalid	Valid
VIVID	Changes the Picture Mode to "VIVID."	Invalid	Valid
DYNAMIC	Changes the Picture Mode to "DYNAMIC."	Invalid	Valid
AUTO ADJ.	Adjusts the size/position of the picture.	Invalid	Valid
SCAN SIZE	Selects the screen size.	OVER	NARROW
ASPECT	Changes the aspect ratio.	4:3	16:9
STAND BY/ON ^{*2}	Turns on/off (on standby) the power.	page 6 "10" / button"	
---	No function	-	-

- You cannot assign the same function to different pin terminals.
- The TRIGGER system switches each function by short-circuiting the pin terminal for about 1 second and opening it.

^{*2}Must be controlled with the TRIGGER system.

Operation

- 1 Select the control method ("SYSTEM") in "REMOTE SETTING."
- 2 Short-circuit the 7th pin terminal (ENABLE) to the 8th pin terminal (GND) so that the monitor can be controlled by the external control.
- 3 **When selecting "MAKE":** Operate each function by short-circuiting the corresponding pin terminal to the 8th pin terminal (GND) or opening it.
When selecting "TRIGGER": Operate each function by pulse control, that is short-circuiting the corresponding pin terminal to the 8th pin terminal (GND) for about 1 second and opening it.
 - When changing the input or Picture Mode with the MAKE system, only one pin terminal must be short-circuited. (Other pin terminals must be opened.)
 - When selecting the TRIGGER system, you can operate only one function at a time. Operate the functions one by one.

Solutions to common problems related to the monitor are described here. If none of the solutions presented here solves the problem, unplug the monitor and consult an authorized dealer or service center.

Symptom	Probable cause and corrective action	Page
No power supply	<ul style="list-style-type: none"> Firmly insert the AC power plug. 	8
No picture with the power on	<ul style="list-style-type: none"> Select the correct input with INPUT SELECT buttons. Connect the signal cable firmly. 	6
	<ul style="list-style-type: none"> Turn on the power of the connected component and set the output correctly. 	8
	<ul style="list-style-type: none"> Check if the input signal format is acceptable on the monitor. 	—
No sound	<ul style="list-style-type: none"> Adjust the volume level. Connect the signal cable firmly. 	6
	<ul style="list-style-type: none"> Turn on the power of the connected component and set the output correctly. 	8
	<ul style="list-style-type: none"> Check if the input signal format is acceptable on the monitor. 	—
“OTHERS” or “Out of range” appears.	<ul style="list-style-type: none"> Check if the input signal format is acceptable on the monitor. 	8, 9
“NO SYNC” appears.	<ul style="list-style-type: none"> Select the correct input with INPUT SELECT buttons. Connect the signal cable firmly. 	6
	<ul style="list-style-type: none"> Select the correct sync signal (“SYNC TYPE”) of “SYNC FUNCTION” in the SET UP MENU. 	8
	<ul style="list-style-type: none"> Turn on the power of the connected component and output video signals. Or, check if the video output of the component (video output setting of the VCR or graphic board of the computer) is set correctly. 	12
Wrong color, no color	<ul style="list-style-type: none"> Adjust the picture using the adjustment buttons on the front panel or adjust the items of “PICTURE SUB ADJ.” in the SET UP MENU. Or, perform “reset” in “PICTURE SUB ADJ.” 	—
	<ul style="list-style-type: none"> Select the proper color system (“COLOR SYSTEM”) in the MAIN MENU. 	6, 11
	<ul style="list-style-type: none"> Adjust the items of “WHITE BALANCE SET.” in the SET UP MENU. Or, perform “reset” in “WHITE BALANCE SET.” 	10
High luminance parts of pictures are not displayed properly.	<ul style="list-style-type: none"> Adjust the contrast using the adjustment buttons on the front panel or adjust the “CONTRAST” of “PICTURE SUB ADJ.” in the SET UP MENU. 	11
	<ul style="list-style-type: none"> If the Picture Mode is “DYNAMIC,” select another one. 	6

Symptom	Probable cause and corrective action	Page
The picture becomes blurred.	<ul style="list-style-type: none"> Adjust the picture contrast or brightness by using the adjustment buttons on the front panel. Or, adjust “CONTRAST” or “BRIGHT” of “PICTURE SUB ADJ.” in the SET UP MENU. 	6, 11
Wrong picture position, wrong picture size.	<ul style="list-style-type: none"> Check if the setting of SCAN SIZE is appropriate. Check if the input signal format is acceptable on the monitor. Check if the setting of aspect ratio is appropriate. 	6
	<ul style="list-style-type: none"> Adjust the picture size (H.SIZE/V.SIZE) or position (H.POSI./V.POSI.) of “SIZE/POSI. ADJ.” in the SET UP MENU. When you input analog RGB signals, perform “AUTO ADJUST” first. 	9
	<ul style="list-style-type: none"> For some signals, the picture cannot be displayed fully in the effective screen area. There is no sure method to solve this problem. 	10, 11
Some items do not appear on the menu.	<ul style="list-style-type: none"> The items which are not available for the current input or the current input signal are not displayed on the menu. Change the input or the input signal. The items controlled by the MAKE system are not displayed on the menu. 	—
	<ul style="list-style-type: none"> Set “CONTROL LOCK” in the SET UP MENU to “OFF” You cannot use the buttons for the items controlled by the MAKE system. Disable the external control. 	13
Buttons on the monitor do not work.	<ul style="list-style-type: none"> Set “CONTROL LOCK” in the SET UP MENU to “OFF” You cannot use the buttons for the items controlled by the MAKE system. Disable the external control. 	12
	<ul style="list-style-type: none"> You cannot use the buttons for the items controlled by the MAKE system. Disable the external control. 	13

The following are not malfunctions.

- When a still image is displayed for a long time, it may remain indistinctly on the screen after the picture has changed. Though the remaining picture will disappear after a while, there may be a case that it remains for a long period depending on the length of time the still image was displayed for. This is due to the characteristics of the LCD display and is not a malfunction.
- The red spots, blue spots and green spots on the panel surface are a normal characteristic of LCD displays, and not a problem. The LCD display is built with very high precision technology; however, be aware that a few pixels may be missing or constantly lit.
- The following symptoms are problems only when pictures or sounds are not played back normally.
 - A slight electric shock occurs when you touch the monitor.
 - The top and/or rear panel of the monitor becomes hot.
 - The monitor emits a cracking noise.
 - The monitor emits a mechanical noise.

When the screen goes blank, and the power lamp on the front panel starts flashing in red...

The monitor is malfunctioning.

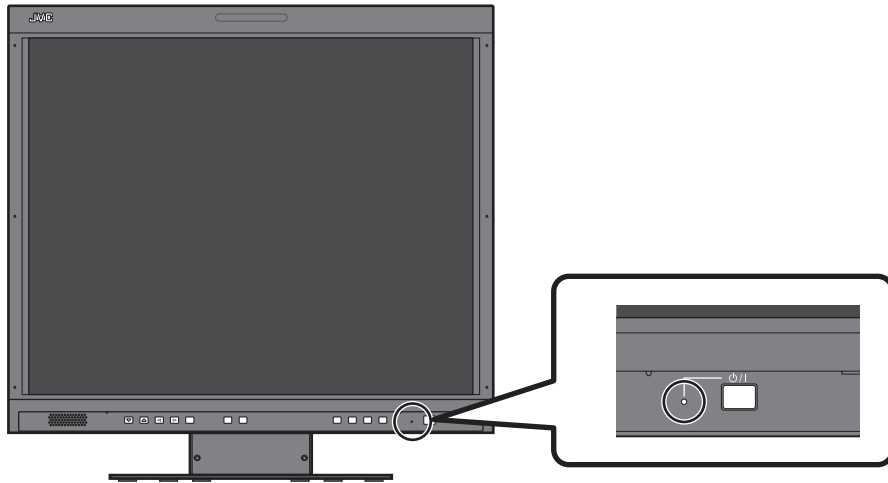

The illustration of the monitor is of LM-H191.

1 Disconnect the AC power cord from the AC outlet.

2 Contact your dealer.

- If you turn on the monitor soon after turning it off (or after a short-term power failure), the power lamp may flash and no image may be displayed. In this case, wait at least 10 seconds before turning on the monitor again. If the power lamp does not flash in red, you can use the monitor as normal.

Specifications

General

Model name	LM-H191	LM-H171
Type	LCD Display Monitor	
Screen size	Type 19 format	Type 17 format
Aspect ratio	5:4	
LCD panel	19", active matrix TFT	17", active matrix TFT
Effective screen size	Width: 376.3 mm (14 13/16") Height: 301 mm (11 13/16")	Width: 337.9 mm (13 7/16") Height: 270.3 mm (10 3/4")
Number of pixels displayed	1 280 x 1 024	
Number of colors displayed	16.77 million	
Viewing angle (TYP.) (CR > 10)	178° (Horizontally), 178° (Vertically)	160° (Horizontally), 160° (Vertically)
Panel brightness (TYP.)	300 cd/m ²	
Contrast ratio (TYP.)	1300:1	1000:1
Horizontal/vertical frequency (computer signal)	H: 31.5 kHz – 65 kHz V: 56 Hz – 75 Hz * Some signals within this frequency range may not be displayed ("Out of range" is displayed).	
Compliant video signal format	* "Available signals" on page 9	
Audio output	Internal speaker: 0.8 W (monaural)	
Operating conditions	Operating temperature: 0°C – 40°C (32°F – 104°F) Operating humidity: 20% – 80% (non-condensing) * Slightly variable depending on ambient conditions for installation.	
Power requirements	AC 120 V/AC 220 – 240 V, 50 Hz/60 Hz	
Rated current	0.9 A (AC 120 V)/0.7 A (AC 220 – 240 V)	0.7 A (AC 120 V)/0.5 A (AC 220 – 240 V)
External dimensions (excluding protruding parts)	Width: 413 mm (16 3/8") 413 mm (16 3/8") Height: 404.8 mm (16") 364 mm (14 3/8") Depth: 199 mm (7 7/8") 74 mm (3") (with the stand) (without the stand)	Width: 374 mm (14 3/4") 374 mm (14 3/4") Height: 374.8 mm (14 7/8") 334 mm (13 1/4") Depth: 199 mm (7 7/8") 74 mm (3") (with the stand) (without the stand)
Weight	8.2 kg (18.0 lbs) (with the stand) 6.4 kg (14.1 lbs) (without the stand)	7.5 kg (16.5 lbs) (with the stand) 5.8 kg (12.8 lbs) (without the stand)
Accessories	AC power cord x 2, Ferrite core x 1	

Unit: mm (inch)

Input/output terminals

Model name	LM-H191	LM-H171
Video		
VIDEO 1 IN/OUT VIDEO 2 IN/OUT	Input/output of composite signal: 1 line, BNC connector x 2, 1 V(p-p), 75 Ω * The input (IN) and output (OUT) terminals are bridge-connected (auto termination).	
VIDEO 1 Y/C	Input of Y/C signal: Y/C connector x 1 Y: 1 V(p-p), 75 Ω C: 0.286 V(p-p), 75 Ω (for NTSC) 0.3 V(p-p), 75 Ω (for PAL)	
DVI-D	DVI-D signal input: DVI-D connector x 1 (compatible with DDC2B)	
RGB	Input of analog RGB signal: D-sub 15-pin x 1 G: 1 V(p-p), 75 Ω G. on sync: 0.3 V(p-p) B, R: 0.7 V(p-p), 75 Ω H. sync: TTL V. sync: TTL C. sync: TTL TTL: LOW: 0 V – 0.8 V HIGH: 2.5 V – 5 V	
Audio		
AUDIO INPUT (VIDEO 1, VIDEO 2)	Analog audio signal input: 1 line, RCA connector, 500 mV (rms), high impedance	
AUDIO INPUT (RGB, DVI-D)	Analog audio signal input: 1 line, stereo mini jack, 500 mV (rms), high impedance	
External control		
REMOTE (MAKE/ TRIGGER)	☞ "External Control" on page 13	

- For easy understanding, pictures and illustrations are shown by being emphasized, omitted or composed, and may be slightly different from actual products.
- Design and specifications are subject to change without notice.
- All company names and product names mentioned herein are used for identification purposes only, and may be the trademarks or registered trademarks of their respective companies.

Notice on transportation

This monitor is precision equipment and needs dedicated packing material for transportation. Never use any packing material supplied from sources other than JVC or JVC-authorized dealers.

Dimensions

LM-H191

<Front view>

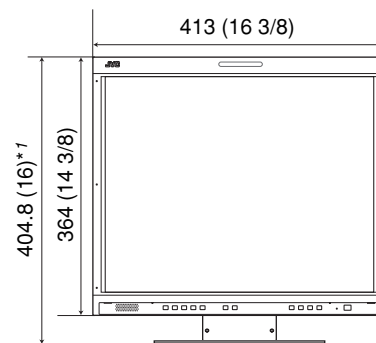

*1 369.5 mm (15 1/8") at the lower position

<Side view>

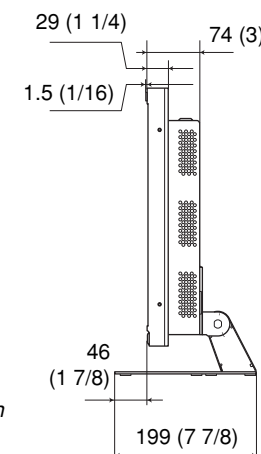

<Rear view (without the stand)>

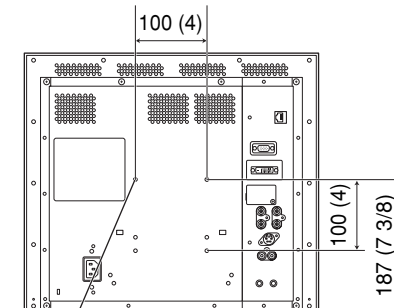

VESA mounting holes
(4-M4, depth: 10 mm)

LM-H171

<Front view>

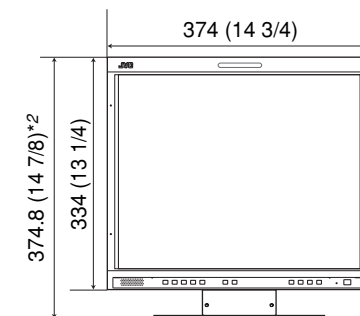

*2 339.5 mm (13 3/8") at the lower position

<Side view>

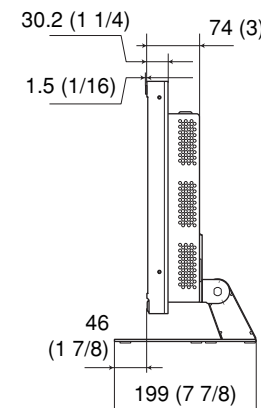

<Rear view (without the stand)>

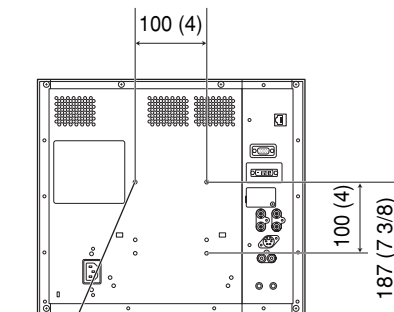

VESA mounting holes
(4-M4, depth: 10 mm)

Stand bottom

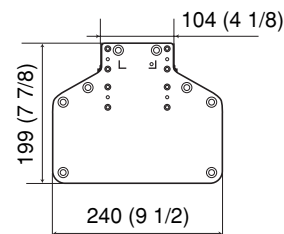

JVC