

The JBL logo is displayed in white, bold, sans-serif capital letters on a solid orange square background.

ARC10, ARC30, ARC1000, ARC Center simple set-up guide

thank you for choosing JBL. For over 50 years, JBL has been involved in every aspect of musical and film recording and reproduction, from live performances to monitoring the recordings you play in your home, car, or office.

We're confident that the **JBL loudspeakers** you have chosen will provide every note of enjoyment that you expected – and that when you think about purchasing additional audio equipment for your home, car, or office, you will once again choose JBL.

Please take a moment to complete the enclosed profile card. It enables us to keep you posted on our latest advancements, and helps us to better understand our customers and build products that meet your needs and expectations.

JBL Consumer Products

one. Speaker Placement

ARC10, ARC30

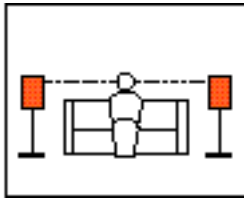
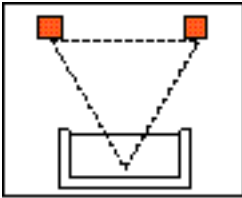

ARC1000

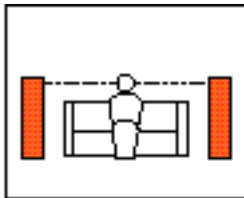
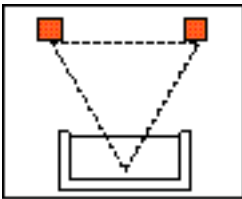

ARC Center

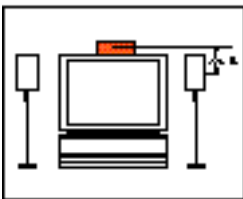

Specifications

	ARC10	ARC30
Frequency Response (-6dB):	75Hz – 20kHz	50Hz – 23kHz
Recommended Maximum Power Handling*:	50 watts	125 watts
Sensitivity @ 1 watt/1 meter:	86dB	90dB
Nominal Impedance:	8 ohms	8 ohms
Crossover Frequency:	2200Hz	3700Hz
Woofer:	5-1/4"	6-1/2"
Midrange:	N/A	N/A
Tweeter:	2" paper cone	1" pure titanium
Dimensions (HxWxD):	11 x 6-1/2 x 7-1/4 inches 280 x 165 x 184mm	17-3/8 x 9-5/8 x 8-1/4 inches 441 x 245 x 210mm
Weight (each):	7 lbs/3.2 kg	16 lbs/7.3 kg

	ARC1000	ARC Center
Frequency Response (-6dB):	36Hz – 23kHz	100Hz – 20kHz
Recommended Maximum Power Handling*:	175 watts	70 watts
Sensitivity @ 1 watt/1 meter:	90dB	89dB
Nominal Impedance:	8 ohms	8 ohms
Crossover Frequency:	930Hz, 5600Hz	9000Hz
Woofer:	10"	2 x 4-1/2"
Midrange:	5"	N/A
Tweeter:	1" titanium	2" paper cone
Dimensions (HxWxD):	39 x 12 x 11 inches 991 x 305 x 209mm	6 x 16 x 6-1/4 inches 152 x 406 x 159mm
Weight (each):	44 lbs/20 kg	9 lbs/4.1 kg

Occasional refinements may be made to existing products without notice, but will always meet or exceed original specifications unless otherwise stated.

*The maximum recommended amplifier power rating will ensure proper system headroom to allow for occasional peaks. We do not recommend sustained operation at these maximum power levels.

two. Speaker Connections

Connection Tips

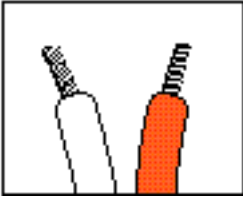

Speakers and electronics terminals have corresponding (+) and (-) terminals. It is important to connect both speakers identically: (+) on the speaker to (+) on the amplifier and (-) on the speaker to (-) on the amplifier. Wiring "out of phase" results in thin sound, weak bass and a poor stereo image.

ARC10, ARC30

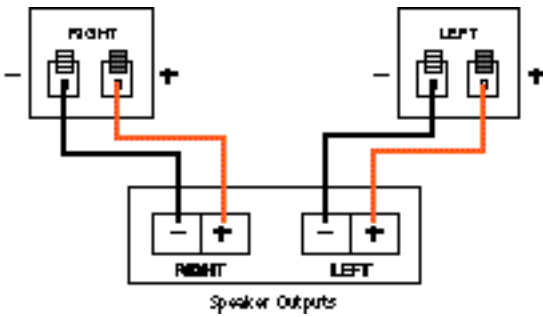

ARC Center

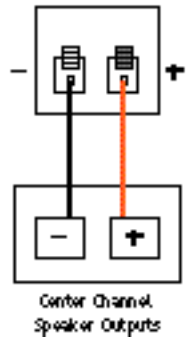

ARC1000 Standard Connection

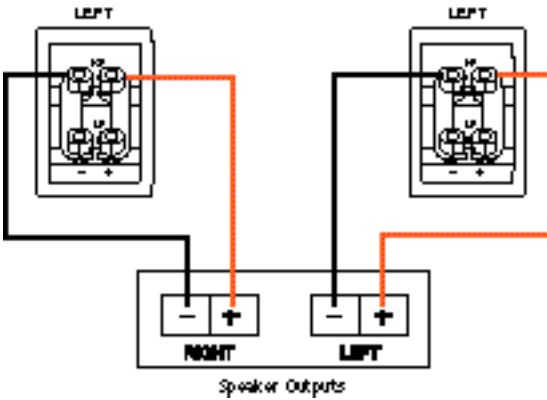

Bi-Wiring

The ARC1000's outer connection panel and internal dividing network are designed so that separate sets of speaker cable can be attached to the low-frequency transducer and midrange/high-frequency transducer portions of the

dividing network. This is called *bi-wiring*. Bi-wiring provides several sonic advantages and considerably more flexibility in power amplifier selection.

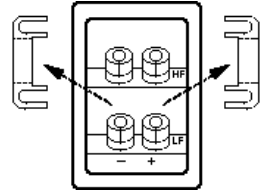

Remove strapping bars.

Single-Stereo Amplifier

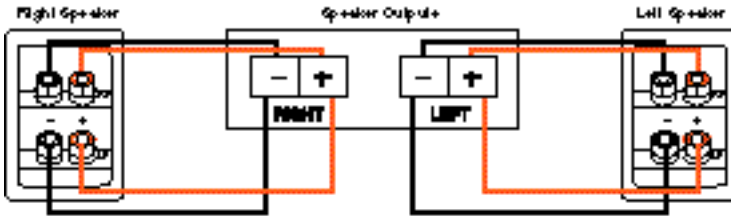

Dual-Stereo Amplifier

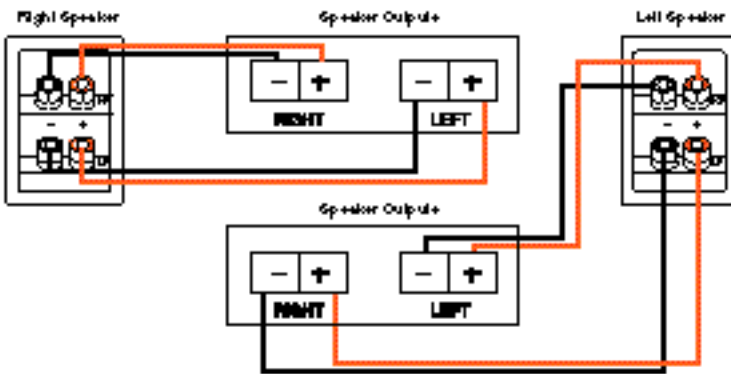

Troubleshooting

If there is no sound from any of the speakers, check the following:

- Receiver/amplifier is on and a source is playing.
- Review proper operation of your receiver/amplifier.

If there is no sound coming from one speaker, check the following:

- Check the "Balance" control on your receiver/amplifier.
- Check all wires and connections between receiver/amplifier and speakers.
- Make sure all wires are connected. Make sure none of the speaker wires is frayed, cut, or punctured.

If the system plays at low volumes but shuts off as volume is increased, check the following:

- Check all wires and connections between receiver/amplifier and speakers.
- Make sure all wires are connected. Make sure none of the speaker wires is frayed, cut, or punctured.
- If more than one pair of main speakers is being used, check the minimum impedance requirements of your receiver/amplifier.

If there is low bass output, check the following:

- Make sure the polarity (+ and -) of the left and right "Speaker Inputs" are connected properly.

If there is no sound from the center speaker, check the following:

- Make sure that your receiver's Center Channel Mode is in the "normal" or "wide" position. If it is in the "phantom" position, the center speaker will not play.
- Check all connections between processor/amplifier and the center speaker.



JBL Consumer Products
80 Crossways Park West, Woodbury, NY 11797
8500 Balboa Boulevard, Northridge, CA 91329
1-800-336-4JBL (4525) (USA only)
www.jbl.com

© 1997 JBL, Incorporated. JBL is a registered trademark of JBL, Incorporated.

3/97  Part No. ARCOM2

 A Harman International Company

Declaration of Conformity



We, JBL Europe A/S
Kongevejen 194B
DK-3460 Birkerød
DENMARK

declare in own responsibility, that the products described in this owner's manual are in compliance with technical standards:

EN 50 081-1/1992
EN 50 082-1/3:1995



Steen Michaelsen
JBL Europe A/S
Birkerød, DENMARK 3467