



ONE (1) YEAR LIMITED WARRANTY

EURO-PRO Operating LLC warrants this product to be free from defects in material and workmanship for a period of one (1) year from the date of the original purchase, when utilized for normal household use, subject to the following conditions, exclusions and exceptions.

If your appliance fails to operate properly while in use under normal household conditions within the warranty period, return the complete appliance and accessories, freight prepaid to

EURO-PRO Operating LLC, 94 Main Mill Street, Door 16, Plattsburgh, NY 12901

If the appliance is found to be defective in material or workmanship, **EURO-PRO Operating LLC** will repair or replace it free of charge. Proof of purchase date and \$ 9.95 to cover the cost of return shipping and handling must be included. *

The liability of **EURO-PRO Operating LLC** is limited solely to the cost of the repair or replacement of the unit at our option. This warranty does not cover normal wear of parts and does not apply to any unit that has been tampered with or used for commercial purposes. This limited warranty does not cover damage caused by misuse, abuse, negligent handling or damage due to faulty packaging or mishandling in transit. This warranty does not cover damage or defects caused by or resulting from damages from shipping or repairs, service or alterations to the product or any of its parts, which have been performed by a repair person not authorized by **EURO-PRO Operating LLC**.

This warranty is extended to the original purchaser of the unit and excludes all other legal and/or conventional warranties. The responsibility of **EURO-PRO Operating LLC** if any, is limited to the specific obligations expressly assumed by it under the terms of the limited warranty. **In no event is EURO-PRO Operating LLC** liable for incidental or consequential damages of any nature whatsoever. Some states/provinces do not permit the exclusion or limitation of incidental or consequential damages, so the above may not apply to you.

This warranty gives you specific legal rights, and you may also have other rights which vary from state to state or province to province.

***Important: Carefully pack item to avoid damage in shipping. Be sure to include proof of purchase date and to attach tag to item before packing with your name, complete address and phone number with a note giving purchase information, model number and what you believe is the problem with item. We recommend you insure the package (as damage in shipping is not covered by your warranty). Mark the outside of your package "ATTENTION CUSTOMER SERVICE". We are constantly striving to improve our products, therefore the specifications contained herein are subject to change without notice.**



PRODUCT REGISTRATION CARD FOR CANADIAN CONSUMERS ONLY

Please complete and return within ten (10) days of purchase. The registration will enable us to contact you in the event a product defect is discovered. By returning this card you acknowledge to have read and understood the instructions for use, and warnings set forth in the accompanying instructions. Please return to:

Canada: **EURO-PRO Operating LLC**, 4400 Bois Franc, St. Laurent, Quebec, H4S 1A7

GI468

 Appliance model

Date purchased _____ Name of store _____

Owner's name _____

Address _____ City _____ Prov./State _____ Postal/Zip Code _____



Professional Lightweight Iron

OWNER'S MANUAL

Model GI468

120V., 60 Hz., 1500 Watts

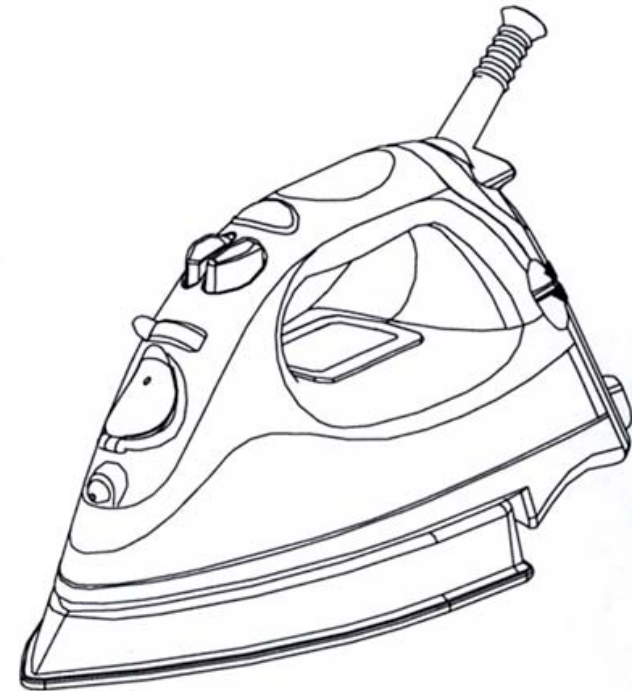

For information or assistance:

EURO-PRO OPERATING LLC

94 Main Mill Street, Door 16

Plattsburgh, NY 12901

Tel.: 1 (800) 798-9378

www.sharkcompany.com



IMPORTANT SAFETY INSTRUCTIONS

When using your iron, basic safety precautions should always be followed, including the following:

1. Read all instructions carefully.
2. Use iron only for its intended use.
3. To protect against risk of electrical shock, do not immerse the iron in water or other liquids.
4. Never yank cord to disconnect from outlet. Grasp plug and pull to disconnect.
5. Do not allow cord to touch hot surfaces. Let iron cool completely before putting away.
6. Always disconnect iron from electrical outlet when filling with water, emptying, or when not in use.
7. Do not operate iron with a damaged cord, or after the iron has been dropped or damaged in any manner. To avoid the risk of electric shock, do not disassemble the iron. Return the iron to **Euro-Pro Operating LLC** for examination and repair. Incorrect reassembly can cause the risk of electric shock when the iron is used.
8. Close supervision is necessary for any appliance being used by or near children. Do not leave iron unattended while connected or on an ironing board.
9. Burns can occur from touching hot metal parts, hot water or steam. Use caution when you turn a steam iron upside down; there may be hot water in the reservoir.
10. Never use or rest iron on an unstable surface.
11. While the iron is hot, never set iron on an unprotected surface - even if it is on its heel rest.
12. **CAUTION: TO PREVENT ELECTRIC SHOCK OR OTHER INJURY**, before filling the iron with water, make sure that the plug is removed from the outlet.
13. **WARNING: Never fill the iron with fabric conditioner, starches or any other solution, as these will damage the steam mechanism. Do not use contaminated water.**
14. **CAUTION: TO AVOID FIRE**, never leave iron unattended while it is plugged in.
15. **CAUTION: TO PREVENT ELECTRIC SHOCK**, never use the iron in a location where it can fall or be pulled into water or another liquid. If the iron falls into water or other liquid, unplug it immediately. **DO NOT** reach into the water or liquid.
16. **WARNING: Never** use scouring pads, abrasive or chemical cleaners, or solvents to clean the exterior or soleplate of your iron. Doing so will scratch and/or damage the surface.
17. **CAUTION: DO NOT** aim iron at face, towards yourself, or anyone else while using or adjusting steam. Burns or serious injury may occur.
18. Always store your iron standing upright, not on the soleplate. If stored face down, even the smallest amount of moisture will cause the soleplate to corrode and stain.
19. **This appliance is for household use only.**

SPECIAL INSTRUCTIONS

1. To avoid a circuit overload, do not operate another high-wattage appliance on the same circuit.
2. If an extension cord is absolutely necessary, use a 15-ampere cord. Cords rated for less amperage may overheat. Use care to arrange the cord so that it cannot be pulled or tripped over.

POLARIZED PLUG: This appliance has a polarized plug (one blade is wider than the other). As a safety feature, this plug will fit into a polarized outlet only one way. If the plug does not fit fully into the outlet, reverse the plug. If it still does not fit, contact a qualified electrician. Do not attempt to defeat this safety feature.

SAVE THESE INSTRUCTIONS

For Household Use Only

TROUBLESHOOTING

PROBLEM	POSSIBLE REASONS & SOLUTIONS
Iron does not heat	<ul style="list-style-type: none"> • Iron should be plugged into a 120V AC electrical outlet only. Make sure that the plug is securely in the socket. • Temperature setting too low. Turn to higher setting.
Some odor or small particles come out of steam vents of new iron	<ul style="list-style-type: none"> • This is normal. Follow instructions for first use and allow iron to steam through 2-3 fillings & press the steam burst button occasionally to eliminate small white particles.
Iron does not steam	<ul style="list-style-type: none"> • Water tank may be empty or water level is very low. Add water. • Make sure that the fabric/temperature setting and the variable steam control are correctly set. For maximum steam, (setting 'Max' on steam control), temperature setting should be set on '•••'. • Variable steam control dial is set on "0". Always allow the iron to reach the selected temperature with the variable steam control setting at '0'. Make sure the temperature setting is set in the correct steam area, e.g. '•', and the steam control is <u>not</u> on '0'. For more steam, turn temperature dial to higher setting, e.g. '•••', and the steam control to 'Max'. • If temperature setting and steam control setting are correct and there is no steam, <u>gently</u> tap the soleplate on the ironing board a few times. Move the variable steam control from '0' to 'Max' a few times.
Water droplets coming from steam vents	<ul style="list-style-type: none"> • Iron may not be hot enough. Set temperature to the 'Max' position. Always allow iron sufficient time to heat up before activating the variable steam control. • Overuse of steam burst. Allow more time between each burst. • Iron may have been overfilled. Turn iron off, empty water and follow instructions for filling. • Steam performance may be low if iron requires seasoning. To season, use regular tap water for 1 or 2 tanks until steam performance improves.

IRONING CHART

NOTE: Always refer to the garment care tag for ironing instructions. Before starting to iron delicate fabrics, it is best to first test the temperature of the iron on a hem or an inside seam.

DIRECTIONS ON LABEL					
FABRIC		SYNTHETIC FIBERS, e.g. acrylic, nylon polyester	SILK WOOL	COTTON LINEN	Please note that on the label means "THIS ARTICLE CANNOT BE IRONED!"
LED DISPLAY PANEL		MIN ●	● ●	MAX ● ● ●	
STEAM CONTROL		0	MINIMUM STEAM	MAXIMUM STEAM	
BURST OF STEAM					
SPRAY					

GETTING TO KNOW YOUR ELECTRONIC IRON

Before using your Shark Professional Lightweight Iron, remove any labels, stickers or tags that may be attached to the body or soleplate of the iron. When turned on for the first time, your new iron may emit an odor for up to 10 minutes. This is due to the initial heating of the materials used in making the iron.

The odor is safe and should not reoccur after initial heating. Also, before ironing with steam for the first time, allow iron to heat, hold in a horizontal position and hit the burst of steam button several times. The iron may emit some small particles from the steam holes. This is normal and will clear after pressing the burst of steam button several times.

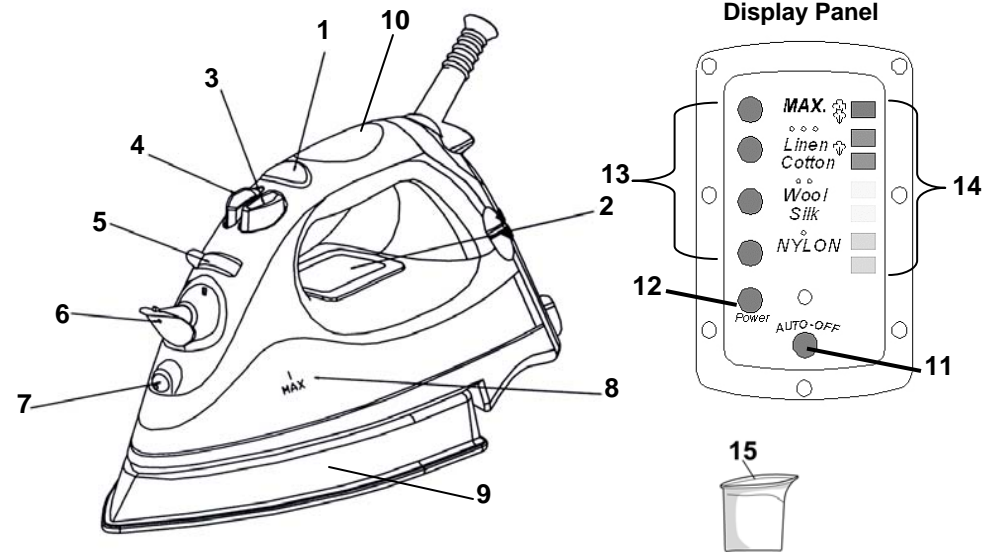

1. Electronic Temperature Control
2. Display Panel
3. Atomizer Spray Button
4. Burst of Steam Button
5. Variable Steam Control
6. Water Inlet Door
7. Spray Nozzle

8. Water Level Window
9. Stainless Steel Soleplate
10. Handle
11. Auto-Shut-Off
12. Power On Light
13. Fabric Settings
14. Temperature & Steam Indicators
15. Water Flask

Technical Specifications

Voltage: 120V, 60 Hz
Power: 1500 Watts

Illustrations may differ from actual product

FEATURES OF SHARK ELECTRONIC IRON

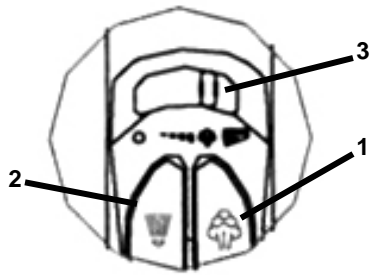

1. **BURST OF STEAM BUTTON**
Burst of steam provides extra, sudden bursts of steam which aid in removing stubborn wrinkles from fabrics such as denim, cotton or linen.
2. **ATOMIZER SPRAY BUTTON**
Pressing this button provides a defined jet of spray which gently moistens fabric.
3. **VARIABLE STEAM CONTROL**
Minimum to maximum steaming for different materials. Self cleaning feature flushes internal sole plate with water.
4. **ANTI-DRIP FUNCTION**
Cuts off water when the iron temperature is too low.
5. **BUILT-IN ANTI-CALCIUM FILTER**
Prevents calcium build-up and prolongs the life of the iron.
6. **STAINLESS STEEL SOLEPLATE**
Provides maximum glide-ability and heat retention.

LED Display Panel

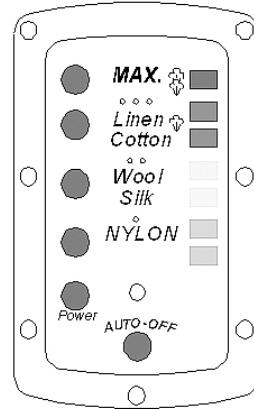

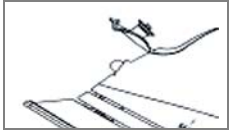
7. **LED DISPLAY PANEL**
Displays the fabric setting (left) and the temperature indicators (right).
- 
8. **WATER FILLING INLET**
The cover prevents dust and foreign matter from entering the water tank. It also stops any water from spilling during ironing.
 9. **PIVOT CORD**
For left or right handed use. Pivots up and down; prevents dragging along the fabric. The flexible cord protector protects the cord from fraying.

OPERATING INSTRUCTIONS

STORAGE

1. Always turn the variable steam control to "0" after you have emptied the water tank.
2. Allow the iron to cool down.
3. Always store the iron in the upright position to protect the soleplate.
4. From time to time, clean the exterior of the iron with a damp cloth and wipe dry.
5. If you use spray starch, wipe the soleplate occasionally with a soft damp cloth to prevent the build-up of deposits.
6. If the iron has not been used for a few weeks, hold the iron horizontally and allow to steam for 2 minutes before ironing.

NOTE: The anti drip function reduces water dripping and water stains. It does not prevent water dripping and water stains if you press the steam burst button too often or if the temperature is too low. The amount of water droplets will eventually decrease after the iron is used for 2 to 3 tankfuls of steaming and ironing.

OPERATING INSTRUCTIONS

AUTO SHUT-OFF

The SHARK Professional Lightweight Iron is equipped with an auto shut-off. The auto shut-off switches the iron off if it has been left standing unmoved in any position (sideways, flat or upright) for approximately 7-9 minutes. A red light on the LED display panel will flash when the iron switches itself off. (Fig. 6) To switch the iron back on, just shake the iron side-to-side several times.

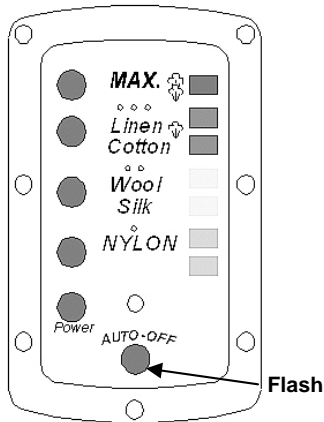

Fig. 6

EMPTYING THE IRON

1. Always empty iron after each use.
2. When finished using the iron, turn the variable steam control to "0" and press the electronic temperature control button until the power light is lit.
3. Unplug the iron from the electrical outlet.
4. Turn the iron upside down over the sink with the tip pointing downward and allow the water to flow from the opening.
5. Place iron upright and allow to cool before storing.

CAUTION Use caution when emptying the iron. Burns may occur from touching hot metal surfaces, hot water or steam.

SELF CLEANING

It is important to "Self Clean" the iron at least every two weeks to remove scale, calcium, etc. The harder the water, the more often the iron should be self cleaned.

1. Set the variable steam control to any steam position.
2. Fill the water tank up to the "MAX" level.
3. Stand the iron on its heel. Plug the iron into the electrical outlet.
4. Press the electronic temperature control button until you get the "MAX" temperature setting on the display panel and wait until the iron heats up and temperature setting light stops flashing.
5. Turn the variable steam control all the way to the right to the self-cleaning position and hold the iron horizontally over the sink. (Fig. 7)
6. Boiling water and steam will now be ejected from the holes in the soleplate. The impurities and scale are washed away with it.
7. Move the iron back and forth as this happens.
8. If there is any water left in the water tank after the iron stops steaming, just empty the remaining water in a sink following the instructions for emptying the iron.
9. Turn the variable steam control to the "0" position when the water tank is empty.
10. Place the iron back upright on its heel to cool down before storing.

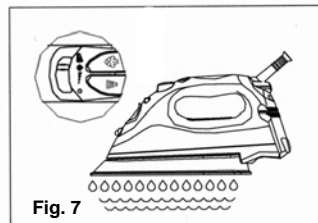

Fig. 7

OPERATING INSTRUCTIONS

This appliance is for HOUSEHOLD USE ONLY and may be plugged into any 120V AC polarized electrical outlet. Do not use any other type of outlet.

FABRIC & TEMPERATURE INDICATORS

Press on the Electronic Temperature Control to select the desired fabric setting. The red lights at the left of the LED Display Panel will light up. At the same time, the temperature indicator lights on the right side of the LED Display Panel will start to flash. They will stop flashing when the iron reaches the selected temperature.

DRY IRONING

For dry ironing, turn the variable steam control dial all the way to the right to "0". This will cut off the steam flow if water is in the water tank. All marked fabric settings on the LED Display Panel can be used for dry ironing.

1. Plug the cord into a polarized, 120V AC electrical outlet. The power "ON" light will come on, indicating that the iron is receiving power.
2. Press on the electronic temperature control button to select the desired fabric/temperature setting. Turn the variable steam control to "0". (See "Ironing Guide" for a guide to temperature selection.)
3. Place iron on its heel (on a stable, protected surface) while iron is warming to desired temperature.

STEAM IRONING

CAUTION DO NOT aim iron at face, towards yourself, or anyone else while using or adjusting steam. Burns or serious injury may occur.

WARNING Before filling the iron with water, be sure the iron is not plugged into the electrical outlet. The iron may be filled with water while it is hot.

CAUTION TO PREVENT THE RISK OF BURNS, use caution when filling iron with water. Burns can occur from touching hot metal parts, hot water, or steam.

NOTE: Because of the soleplate design, ordinary tap water may be used with this iron. However, in very hard water areas, we recommend using distilled or demineralized water.

WARNING: Never fill the iron with fabric conditioner, starches or any other liquid, as these will damage the steam mechanism. Do not use contaminated water.

1. Open the water filling inlet cover. Holding the iron at a slight angle, pour water slowly into the water filling inlet. See figure 1. Fill tank to desired level or to the "MAX" water level marking using the water filling flask. (When the iron is upright, the see-through water tank allows you to gauge the amount of water.) DO NOT overfill the tank. When finished filling the iron with water, close the water inlet cover before continuing.

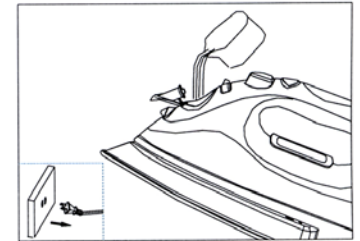

Fig. 1

2. Plug the cord into a polarized, 120V AC electrical outlet.
3. Press on the electronic temperature control button to select the desired fabric and temperature setting. Turn the variable steam control dial to the desired steam setting. (See "Ironing Guide" for a guide to temperature selection.)

OPERATING INSTRUCTIONS

- Place the iron on its heel on a stable, protected surface and allow the iron to heat for approximately two (2) minutes or until the temperature settings on the right side of the LED display panel have stopped flashing.
- Turn the variable steam control dial to the right to increase the amount of steam. When using extra steam, the iron uses more water and it may be necessary to fill the water tank more often. (Fig. 2)

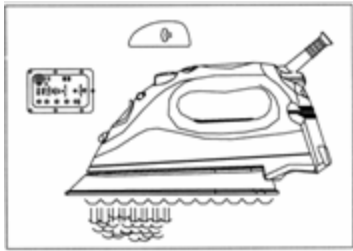

Fig. 2

BURST OF STEAM BUTTON

CAUTION DO NOT aim iron at face, towards yourself, or anyone else while using or adjusting steam. Burns or serious injury may occur.

The burst of steam position is useful when ironing denim, cotton and linens. It provides quick bursts of steam which aid in removing stubborn wrinkles.

The burst of steam feature can be used with Dry or Steam ironing as desired.

- Make sure the water tank is at least 1/2 filled with water.
- Select the desired fabric and temperature setting. Place the iron on its heel (on a stable, protected surface) and allow it to heat for approximately 2 minutes.
- Position variable steam control to the burst of steam position. (Fig. 3)
- With the iron in a horizontal position, press the steam button several times to prime the pump.

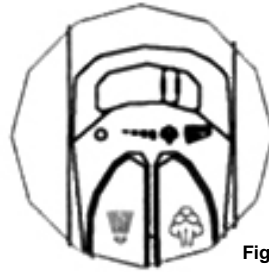

Fig. 3

- Slide the variable steam control up to increase the amount of steam. (Fig. 3) When using extra steam, the iron uses more water and it may be necessary to fill the tank more often. See page 4 for refilling the iron with water.
- Steam is produced as soon as the iron is held in the horizontal position. Steam will stop coming out when the iron is put on its heel in a vertical position or by setting the variable steam control to "0".

ATOMIZER SPRAY NOZZLE

The atomizer spray nozzle is useful on fabrics with stubborn wrinkles. Press the spray button and a jet of water will spray onto the fabric being ironed. (Fig. 4) The water spray can be used with dry or steam ironing as desired.

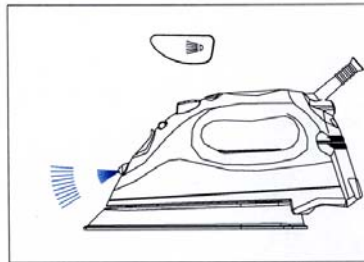

Fig. 4

OPERATING INSTRUCTIONS

SELECTING IRON TEMPERATURES

Always read garment labels and follow the manufacturer's ironing instructions. Refer to the "Ironing Chart" on page 9 for temperature recommendations:

- Use low settings for nylon and other synthetics.
 - Use moderate settings for wool, silks, and blends.
 - Use high settings for cottons and linens.
- Stand the iron upright on its heel.
 - Plug the cord into a polarized, 120V AC electrical outlet.
 - Press the electronic temperature control until you get the desired fabric/temperature setting.
 - The light on the right side of the LED display panel will stop flashing when the desired temperature has been reached. (Fig. 5)

IRONING HINTS

WARNING To prevent fire, do not leave iron unattended while connected.

- Sort articles to be ironed according to the type of fabric. This will reduce the need to adjust the temperature for different types of garments.
- If you are not sure of the fiber content of a garment, test fabric by ironing a small area such as a seam or inside hem section before ironing a visible area. Start with a low temperature setting and gradually increase to find the best setting.
- When reducing the temperature to iron sensitive fabrics, allow approximately 2 minutes for the iron to cool to the new temperature setting.
- Fabrics such as velour, wool, linen and silk are best ironed with an ironing cloth to prevent shine marks.

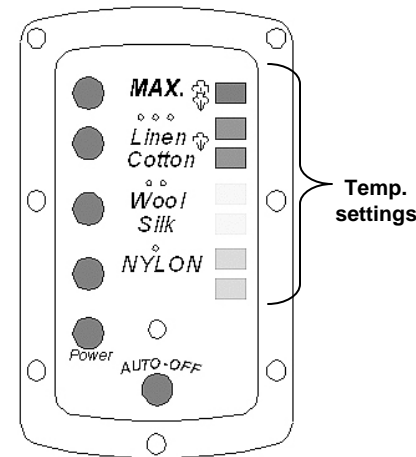

Fig. 5