

Panasonic®

Owner's Manual Portable Blu-ray Disc™ Player

Model No. DMP-B200



Dear customer

Thank you for purchasing this product.

For optimum performance and safety, please read these instructions carefully.

Before connecting, operating or adjusting this product, please read the instructions completely.

Please keep this manual for future reference.

If you have any questions contact
U.S.A. and Puerto Rico : 1-800-211-PANA (7262)
Canada : 1-800-561-5505

P

PC

VQT3C15

IMPORTANT SAFETY INSTRUCTIONS

Read these operating instructions carefully before using the unit. Follow the safety instructions on the unit and the applicable safety instructions listed below. Keep these operating instructions handy for future reference.

- 1) Read these instructions.
- 2) Keep these instructions.
- 3) Heed all warnings.
- 4) Follow all instructions.
- 5) Do not use this apparatus near water.
- 6) Clean only with dry cloth.
- 7) Do not block any ventilation openings. Install in accordance with the manufacturer's instructions.
- 8) Do not install near any heat sources such as radiators, heat registers, stoves, or other apparatus (including amplifiers) that produce heat.
- 9) Do not defeat the safety purpose of the polarized or grounding-type plug. A polarized plug has two blades with one wider than the other. A grounding-type plug has two blades and a third grounding prong. The wide blade or the third prong are provided for your safety. If the provided plug does not fit into your outlet, consult an electrician for replacement of the obsolete outlet.
- 10) Protect the power cord from being walked on or pinched particularly at plugs, convenience receptacles, and the point where they exit from the apparatus.
- 11) Only use attachments/accessories specified by the manufacturer.
- 12) Use only with the cart, stand, tripod, bracket, or table specified by the manufacturer, or sold with the apparatus. When a cart is used, use caution when moving the cart/apparatus combination to avoid injury from tip-over.
- 13) Unplug this apparatus during lightning storms or when unused for long periods of time.
- 14) Refer all servicing to qualified service personnel. Servicing is required when the apparatus has been damaged in any way, such as power-supply cord or plug is damaged, liquid has been spilled or objects have fallen into the apparatus, the apparatus has been exposed to rain or moisture, does not operate normally, or has been dropped.



The following mark and symbols are located on bottom of the unit.

<div style="display: inline-block; text-align: center; border: 1px solid black; padding: 2px;"> CAUTION <small>RISK OF ELECTRIC SHOCK DO NOT OPEN</small> </div>
CAUTION: TO REDUCE THE RISK OF ELECTRIC SHOCK, DO NOT REMOVE SCREWS. NO USER-SERVICEABLE PARTS INSIDE. REFER SERVICING TO QUALIFIED SERVICE PERSONNEL.



The lightning flash with arrowhead symbol, within an equilateral triangle, is intended to alert the user to the presence of uninsulated "dangerous voltage" within the product's enclosure that may be of sufficient magnitude to constitute a risk of electric shock to persons.



The exclamation point within an equilateral triangle is intended to alert the user to the presence of important operating and maintenance (servicing) instructions in the literature accompanying the appliance.

The unit should be installed near an accessible AC power outlet, with the power cord connected directly to it. To completely disconnect power from the unit, unplug the power cord from the AC power outlet.

WARNING:

TO REDUCE THE RISK OF FIRE, ELECTRIC SHOCK OR PRODUCT DAMAGE,

- DO NOT EXPOSE THIS APPARATUS TO RAIN, MOISTURE, DRIPPING OR SPLASHING AND THAT NO OBJECTS FILLED WITH LIQUIDS, SUCH AS VASES, SHALL BE PLACED ON THE APPARATUS.
- USE ONLY THE RECOMMENDED ACCESSORIES.
- DO NOT REMOVE THE COVER (OR BACK); THERE ARE NO USER SERVICEABLE PARTS INSIDE. REFER SERVICING TO QUALIFIED SERVICE PERSONNEL.

CAUTION!

DO NOT INSTALL OR PLACE THIS UNIT IN A BOOKCASE, BUILT-IN CABINET OR IN ANOTHER CONFINED SPACE. ENSURE THE UNIT IS WELL VENTILATED. TO PREVENT RISK OF ELECTRIC SHOCK OR FIRE HAZARD DUE TO OVERHEATING, ENSURE THAT CURTAINS AND ANY OTHER MATERIALS DO NOT OBSTRUCT THE VENTILATION VENTS.

CAUTION!

THIS PRODUCT UTILIZES A LASER. USE OF CONTROLS OR ADJUSTMENTS OR PERFORMANCE OF PROCEDURES OTHER THAN THOSE SPECIFIED HEREIN MAY RESULT IN HAZARDOUS RADIATION EXPOSURE. DO NOT OPEN COVERS AND DO NOT REPAIR YOURSELF. REFER SERVICING TO QUALIFIED PERSONNEL.

CAUTION - VISIBLE AND INVISIBLE LASER RADIATION WHEN OPEN AND INTERLOCK DEFEATED. DO NOT STARE INTO BEAM. FDA 21CFR/CLASS II (IIa)

CAUTION - CLASS 1M VISIBLE AND INVISIBLE LASER RADIATION WHEN OPEN AND INTERLOCKS DEFEATED. DO NOT VIEW DIRECTLY WITH OPTICAL INSTRUMENTS. IEC60825-1, +A2/CLASS 1M

ATTENTION - RAYONNEMENT LASER VISIBLE ET INVISIBLE, CLASSE 1M. EN CAS D'OUVREURE ET LORSQUE LA SECURITE EST NEUTRALISEE, NE PAS REGARDER DIRECTEMENT A L'AIDE D'INSTRUMENTS D'OPTIQUE.

(Bottom of product)

THE FOLLOWING APPLIES ONLY IN THE U.S.A.

FCC Note:

This equipment has been tested and found to comply with the limits for a Class B digital device, pursuant to Part 15 of the FCC Rules. These limits are designed to provide reasonable protection against harmful interference in a residential installation. This equipment generates, uses and can radiate radio frequency energy and, if not installed and used in accordance with the instructions, may cause harmful interference to radio communications. However, there is no guarantee that interference will not occur in a particular installation. If this equipment does cause harmful interference to radio or television reception, which can be determined by turning the equipment off and on, the user is encouraged to try to correct the interference by one or more of the following measures:

- Reorient or relocate the receiving antenna.
- Increase the separation between the equipment and receiver.
- Connect the equipment into an outlet on a circuit different from that to which the receiver is connected.
- Consult the dealer or an experienced radio/TV technician for help.

Any unauthorized changes or modifications to this equipment would void the user's authority to operate this device.

This device complies with Part 15 of the FCC Rules. Operation is subject to the following two conditions: (1) This device may not cause harmful interference, and (2) this device must accept any interference received, including interference that may cause undesired operation.

Responsible Party:

Panasonic Corporation of North America
One Panasonic Way Secaucus, NJ 07094

Support Contact:

Panasonic Consumer Electronics Company
Telephone No.: 1-800-211-PANA (7262)

THE FOLLOWING APPLIES ONLY IN CANADA.

This Class B digital apparatus complies with Canadian ICES-003.

Batteries

1 Battery pack (Lithium ion battery pack)

- Use the specified unit to recharge the battery pack.
- Do not use the battery pack with equipment other than the specified unit.
- Do not use the player outside if it is snowing or raining. (The battery pack is not waterproof.)
- Do not get dirt, sand, liquids, or other foreign matter on the terminals.
- Do not touch the plug terminals (+ and –) with metal objects.
- Do not disassemble, remodel, heat or throw into fire.
- Do not heat or expose to flame.
- Do not leave the battery(ies) in an automobile exposed to direct sunlight for a long period of time with doors and windows closed.

2 Button-type battery (Lithium battery)

- Insert with poles aligned.
- Do not touch the terminals (+ and –) with metal objects.
- Do not recharge, disassemble, remodel, heat or throw into fire.
- Keep out of reach of children.
- Do not heat or expose to flame.
- Do not leave the battery(ies) in an automobile exposed to direct sunlight for a long period of time with doors and windows closed.

If any electrolyte should come into contact with your hands or clothes, wash it off thoroughly with water.

If any electrolyte should come into contact with your eyes, never rub the eyes.

Rinse eyes thoroughly with water, and then consult a doctor.

3 Disposing of the batteries

Check and follow your local regulations before disposal.

Warning

Risk of fire, explosion and burns. Do not disassemble. Do not heat the batteries above the following temperatures or incinerate.

Button-type battery 100 °C (212 °F)

Battery pack 60 °C (140 °F)

CAUTION

Danger of explosion if battery is incorrectly replaced. Replace only with the same or equivalent type recommended by the manufacturer. Dispose of used batteries according to the manufacturer's instructions.

A lithium ion battery that is recyclable powers the product you have purchased.

At the end of its useful life, under various state and local laws, it is illegal to dispose of this battery into your municipal waste stream.

Please call 1-800-8-BATTERY for information on how to recycle this battery.



For USA-California Only

This product contains a CR Coin Cell Lithium Battery which contains Perchlorate Material - special handling may apply.

See

www.dtsc.ca.gov/hazardouswaste/perchlorate.

Product Identification Marking is located on the bottom of units.

AC adaptor

This AC adaptor operates on AC between 110 V and 240 V.

But

- In the U.S.A. and Canada, the AC adaptor must be connected to a 120 V AC power supply only.
- When connecting to an AC supply outside of the U.S.A. or Canada, use a plug adaptor to suit the AC outlet configuration.
- When connecting to a supply of greater than AC 125 V, ensure the cord you use is suited to the voltage of the AC supply and the rated current of the AC adaptor.
- Contact an electrical parts distributor for assistance in selecting a suitable AC plug adaptor or AC cord set.

WARNING

DRIVER MUST NOT OPERATE OR VIEW THIS UNIT WHILE OPERATING THE VEHICLE.

Doing so will distract the driver and could cause a collision resulting in serious injury or property damage.

Do not rest the unit on your lap for a long time while using it. The unit can become hot and cause burns.

To prevent damage

Avoid the following:

- Spraying flammable insecticides near the unit.
 - Pressing the LCD.
 - Touching the lens and other parts of the laser pickup.
- Do not use the unit in the following places:
- Sandy places such as beaches.
 - On top of cushions, sofas, or hot equipment such as amplifiers.
- Do not leave in an unventilated automobile or exposed to direct sunlight and high temperatures.

Listening caution



Do not play your headphones or earphones at a high volume. Hearing experts advise against continuous extended play. If you experience a ringing in your ears, reduce volume or discontinue use.

Do not use while operating a motorized vehicle. It may create a traffic hazard and is illegal in many areas.

You should use extreme caution or temporarily discontinue use in potentially hazardous situations.

Even if your headphones or earphones are the open-air type designed to let you hear outside sounds, don't turn up the volume so high that you can't hear what's around you.

Sound can be deceiving. Over time your hearing "comfort level" adapts to higher volumes of sound. So what sounds "normal" can actually be loud and harmful to your hearing.

Guard against this by setting your equipment at a safe level BEFORE your hearing adapts.

To establish a safe level:

- Start your volume control at a low setting.
- Slowly increase the sound until you can hear it comfortably and clearly, and without distortion.

Once you have established a comfortable sound level:

- Leave it there.

Table of contents

Getting started

IMPORTANT SAFETY INSTRUCTIONS	2
Accessories	4
Firmware updates	5
Unit and media care	5
Media (Disc and card) information	6
Overview	8
Adjusting the LCD screen angle	10
Preparing the Power Supply	10
Turning on/off the unit	12
Showing FUNCTION MENU	12
Adjusting the pictures on the LCD screen	13
Loading the disc or SD card	13

Playback

Basic play (Playing video contents)	14
Enjoying picture-in-picture in BD-Video	17
Playing still pictures	18
Playing music	20
Using this unit with other equipment	21
Linked operations with the TV (VIERA Link™ “HDAVI Control™”)	22

Settings

Changing settings with the on-screen menu	24
Changing the unit's settings	26

Reference

Enjoying High Bit rate Audio	30
About MP3/JPEG/MKV/AVCHD/MPEG2 files	31
Indicators and screen messages	33
Troubleshooting guide	34
Specifications	38
Licenses	39
Glossary	40
Limited Warranty (ONLY FOR U.S.A. AND PUERTO RICO)	42
Limited Warranty (ONLY FOR CANADA)	43
Index	Back Cover

Accessories



Please check and identify the supplied accessories. Use numbers indicated in parentheses when asking for replacement parts. (Product numbers correct as of December 2010. These may be subject to change.)

For U.S.A. and Puerto Rico

To order accessories, refer to “Accessory Purchases (United States and Puerto Rico)” on page 42.

For Canada

To order accessories, call the dealer from whom you have made your purchase.

- 1 Remote control** (N2QAJC000018)
- 1 Button-type battery for remote control**
(for replacement ⇄ 9)
- 1 AC adaptor** (RFEA219W)
- 1 AC power supply cord** (K2CB2CB00020)
 - For use with this unit only. Do not use it with other equipment. Also, do not use cords for other equipment with this unit.
- 1 Car DC Adaptor** (RFEC207P-AB)
- 1 Rechargeable battery pack** (DY-DB20)

For Canada

The enclosed Canadian French label sheet corresponds to the English display on the unit.

Firmware updates

Occasionally, Panasonic may release firmware updates for this unit that may add or improve the way a feature operates. These updates are available free of charge.

You can download the latest firmware version from the website "http://panasonic.jp/support/global/cs/" (This site is in English only.). After you burn the latest firmware to a CD-R disc, play the disc in the unit and update the firmware.
Only when connecting the AC adaptor.

During the firmware update "DO NOT TURN OFF OR UNPLUG THE UNIT OR OPEN THE DISC LID."

- The [Ⓛ] and [CHARGE] indicators light while updating the firmware and the indicators turn off when updating the firmware is finished. (⇒ 8)
- To check the version of the firmware on this unit, refer to "System Information" (⇒ 29)

Unit and media care

Handling the unit

- Close the LCD screen when moving the unit.
Don't hold by the LCD screen.
- The unit does not have magnetic shielding. Do not place the unit near televisions, personal computers or other devices easily influenced by magnetism. Do not keep this unit and magnetized cards (bank cards, commuter passes, etc.) close together.
- Do not place the unit with the LCD display-side down when the screen is open.
Doing so may scratch the surface of the LCD and around the LCD.

Disc and card handling

■ Clean discs

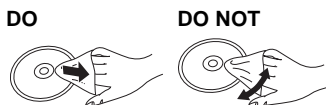

Wipe with a damp cloth and then wipe dry.

■ Disc and card handling precautions

- Handle discs by the edges to avoid inadvertent scratches or fingerprints on the disc.
- Do not attach labels or stickers to discs (This may cause disc warping, rendering it unusable).
- Do not write on the label side with a ball-point pen or other writing instrument.
- Do not use record cleaning sprays, benzine, thinner, static electricity prevention liquids or any other solvent.
- Do not use scratch-proof protectors or covers.
- Clean any dust, water, or foreign matter from the terminals on the rear side of the card.
- Do not use the following discs:
 - Discs with exposed adhesive from removed stickers or labels (rented discs etc).
 - Discs that are badly warped or cracked.
 - Irregularly shaped discs, such as heart shapes.

Maintenance

■ To clean this unit, wipe with a soft, dry cloth.

- Use eyeglass cleaner to remove stubborn dirt from the LCD.
- Do not use a microfiber dust cloth on the LCD screen. Follow the caution when wiping the outer casing.
- Never use alcohol, paint thinner or benzine to clean this unit.
- Wiping the LCD and around the LCD with a hard cloth or rubbing them strongly may scratch the surfaces.

■ Maintenance of the lens

- Remove dust carefully with an air blower for camera lenses (optional).
- Recommended product:
Lens cleaner kit (SZP1038C) (Available from Panasonic dealers.)
- You cannot use a CD type lens cleaner.
- Be careful not to touch the lens with your fingers.





To dispose or transfer this unit

- The unit may keep the user settings information in the unit. If you discard this unit either by disposal or transfer, then follow the procedure to return all the settings to the factory presets to delete the user settings. (⇒ 34, "To return all settings to the factory preset")
- The operation history may be recorded in the memory of this unit.

Media (Disc and card) information

Commercially sold discs

This chart shows the different type of retail/commercial discs you can use, and also includes the industry-standard logos that should appear on the discs and/or packaging.

Type of media and logo	Features	Indicated as
BD-Video 	This format supports High Definition video and audio content.	BD-V
DVD-Video  	This format supports high quality video and audio playback.	DVD-V
CD 	Compact Discs (CD's) that contain audio and music <ul style="list-style-type: none"> Operation and sound quality of CDs that do not conform to CD-DA specifications (copy control CDs, etc.) cannot be guaranteed. 	CD

Note about using a DualDisc

- The digital audio content side of a DualDisc does not meet the technical specifications of the Compact Disc Digital Audio (CD-DA) format so play may not be possible.
- Do not use a DualDisc in this unit as it may not be possible to insert it correctly and it may get scratched or scraped.

User recorded media

This chart shows the different type of discs recorded with other devices that you can use.

Finalized This mark means you must finalize the disc with the DVD recorder, etc. before playback. For details about finalizing, refer to the operating instructions for your equipment.

Type of media and logo	Formats	Indicated as
BD-RE 	<ul style="list-style-type: none"> Version 3 of the BD-RE Recording Format JPEG format 	BD-V JPEG
BD-R 	<ul style="list-style-type: none"> Version 2 of the BD-R Recording Format MKV format 	BD-V MKV
DVD-RAM 	<ul style="list-style-type: none"> Version 1.1 of the DVD Video Recording Format JPEG format AVCHD format 	DVD-VR JPEG AVCHD
DVD-R/RW Finalized  	<ul style="list-style-type: none"> DVD-Video Format Version 1.1 of the DVD Video Recording Format AVCHD format MKV format (DVD-RW is not supported) MP3 format (DVD-RW is not supported) JPEG format (DVD-RW is not supported) 	DVD-V DVD-VR AVCHD MKV MP3 JPEG
DVD-R DL Finalized 	<ul style="list-style-type: none"> DVD-Video Format Version 1.2 of the DVD Video Recording Format AVCHD format MKV format MP3 format JPEG format 	DVD-V DVD-VR AVCHD MKV MP3 JPEG
+R/+RW/+R DL Finalized	<ul style="list-style-type: none"> +VR (+R/+RW Video Recording) Format AVCHD format 	DVD-V AVCHD
CD-R/RW Finalized	<ul style="list-style-type: none"> CD-DA format MP3 format JPEG format MKV format 	CD MP3 JPEG MKV

- It may not be possible to play the above discs in some cases due to the type of discs, the condition of the recording, the recording method and how the files were created.
- When a disc recorded in the AVCHD format is being played, the video may be paused for a few seconds at portions spliced, due to deletion or editing.

Region management information

BD-Video

This unit plays BD-Video marked with labels containing the region code "A".

Example:



DVD-Video

This unit plays DVD-Video marked with labels containing the region number "1" or "ALL".

Example:



Discs that cannot be played in this unit

- 2.6 GB and 5.2 GB DVD-RAM
- DVD-RAM that cannot be removed from cartridge
- 3.95 GB and 4.7 GB DVD-R (Authoring)
- DVD-R, DVD-R DL, DVD-RW, +R, +R DL recorded on another unit and not finalized
- BD-Video with a region code other than "A"
- DVD-Video with a region number other than "1" or "ALL"
- Version 1.0 DVD-RW
- DVD-ROM, CD-ROM, CDV, CD-G, CVD, SACD, Photo CD, MV-Disc and PD
- DVD-Audio
- Video CD and SVCD
- WMA discs
- PAL discs
- DivX discs
- HD DVD
- BD-Video discs recorded at a rate of 50 fields/sec
- Any other disc that is not specifically supported

SD cards

This chart shows the different type of cards recorded with other devices that you can use.

Type of media*	Formats	Indicated as
SD Memory Card (from 8 MB to 2 GB)	<ul style="list-style-type: none"> • JPEG format • AVCHD format • MPEG-2 format 	
SDHC Memory Card (from 4 GB to 32 GB)		
SDXC Memory Card (48 GB, 64 GB)		

* Includes miniSD Card, microSD Card, microSDHC Card and microSDXC Card

The card types mentioned above will be referred to as "SD card" in these operating instructions.

- miniSD Card, microSD Card, microSDHC Card and microSDXC Card can be used, but must be used with an adaptor card. These are usually supplied with such card, or otherwise customer provided.

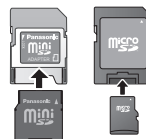

- We recommend using a Panasonic SD card. Please confirm the latest information on the following website.
<http://panasonic.jp/support/global/cs/>
(This site is in English only.)
- This unit is compatible with SD Memory Cards that meet SD Card Specifications FAT12 and FAT16 formats, as well as SDHC Memory Cards in FAT32 format (Does not support long file name.) and SDXC Memory Cards in exFAT.
- If the SD card is used with incompatible computers or devices, recorded contents may be erased due to the card being formatted etc.
- When using cards from 4 GB to 32 GB, only SD cards using the SDHC logo can be used.
- When using cards 48 GB and 64 GB, only SD cards using the SDXC logo can be used.
- Useable memory may be slightly less than the card capacity.
- If the SD card you are attempting to use was formatted on a PC, it is possible that the card may not work properly.
- Keep the Memory Card out of reach of children to prevent swallowing.
- When a card recorded in the AVCHD format is being played, the video may momentarily pause, especially where one recording ends and the next one begins. This is normal and does not indicate a problem.
- To protect the card's contents, move the record prevention tab (on the SD card) to "LOCK".

Overview

The Unit

Instructions for operations are generally described using the remote control in these operating instructions.

Front View

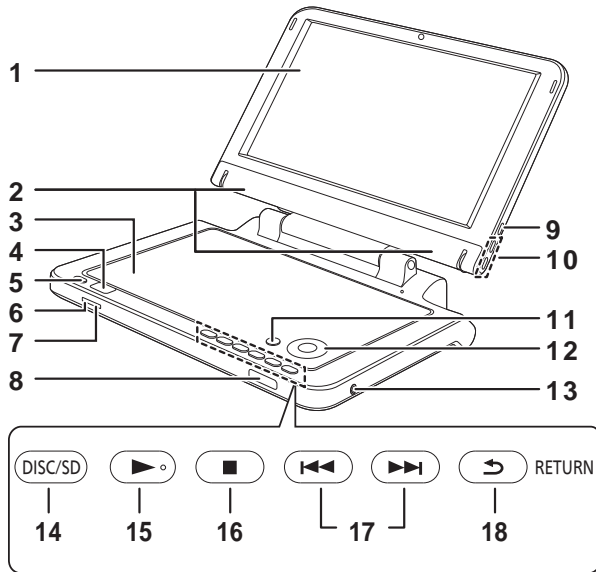

Rear View

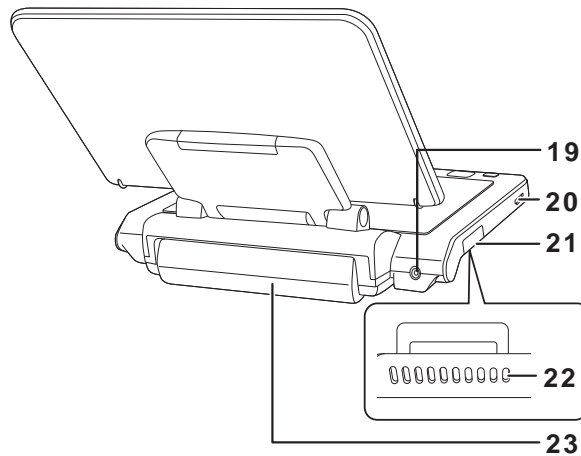

- 1 **LCD screen**
- 2 **Speaker**
- 3 **Disc lid**
- 4 **Open the disc lid**
- 5 **Turn the unit on and off (⇒ 12)**
- 6 **[⏻] indicator (⇒ 10)**

When the unit is connected to the AC mains supply, this indicator lights up in standby mode and goes out when the unit is turned on.

- 7 **[CHARGE] indicator (⇒ 11)**
While recharging the battery pack, this indicator lights up.
- 8 **Remote control signal sensor (⇒ 8)**
- 9 **Change the screen settings (⇒ 13)**
- 10 **Adjust the volume (⇒ 14)**
- 11 **Show the sub menu**
- 12 **Selection/OK**
 - To select: Press up, down, left, or right ([▲, ▼, ◀, ▶])
 - To enter: Press [OK]

- 13 **Headphone terminal [🔊] (φ 3.5 mm stereo mini jack)**
- 14 **Switch the media to playback**
It will switch every time it is pressed.

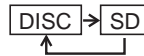

- 15 **Playback (⇒ 14)**
- 16 **Stop (⇒ 15)**
- 17 **Skip title numbers, etc. (⇒ 15)**
- 18 **Return to previous screen**
- 19 **DC IN terminal (⇒ 10)**
- 20 **HDMI AV OUT terminal (⇒ 21)**
- 21 **SD card slot (⇒ 13)**
- 22 **Exhaust opening**

About the exhaust opening:

Do not block the exhaust opening on the side, or use in a place that will block the exhaust opening. The heat will build up internally, and may cause a fire or deformation of the outer casing.

- 23 **Battery pack (supplied)**

Remote control

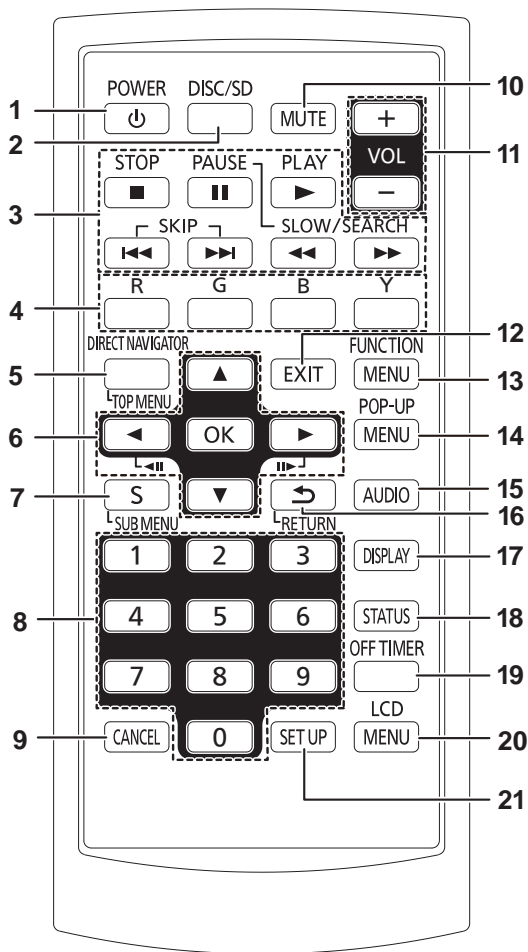

- 1 Turn the unit on and off (⇒ 12)
- 2 Switch the media to playback (⇒ 14)
- 3 Basic operations for playback (⇒ 14 – 15)
- 4 Use according to the instructions on the screen
- 5 Show Top menu/Direct Navigator (⇒ 14)
- 6 Selection/OK, Frame-by-frame
 - To select: Press up, down, left, or right ([▲, ▼, ◀, ▶])
 - To enter: Press [OK]
 - Frame forward / Frame backward:
(While paused) press left or right ([◀|||][||▶])
- 7 Show the sub menu
- 8 Select title numbers, etc./Enter numbers
- 9 Cancel the values that were entered
- 10 Mute the sound
Press again to clear
- 11 Adjust the volume (⇒ 14)
- 12 Exit the menu screen
- 13 Show FUNCTION MENU (⇒ 12)
- 14 Show Pop-up menu (⇒ 14)
- 15 Select audio (⇒ 16)
- 16 Return to previous screen
- 17 Show on-screen menu (⇒ 24)
- 18 Show status messages (⇒ 16)
- 19 Turn the unit off automatically (⇒ 12)
- 20 Change the screen settings (⇒ 13)
- 21 Change the setup of this unit (⇒ 26)

Getting started

■ Insert the button-type battery (supplied)

- ① Pull out the holder.

Bottom

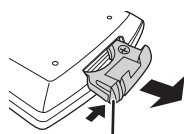

Pull out while pressing here

- ② Insert the battery and return the holder.

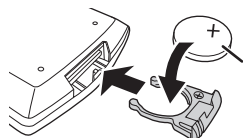

+ facing up
Lithium battery: CR2025

- Keep the button-type battery out of reach of children to prevent swallowing.

■ Range of use

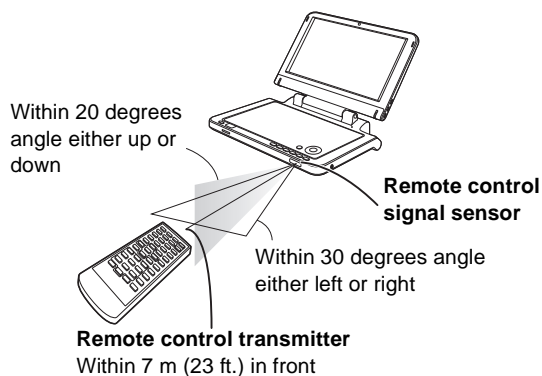

The distance and angles are approximate.

Adjusting the LCD screen angle

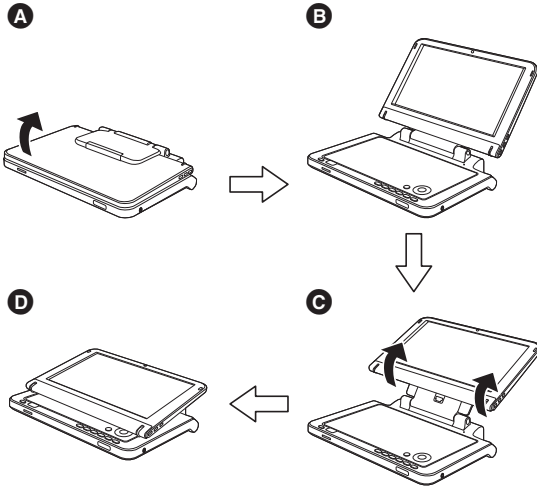

- A** Open the screen.
- B** Standard
- C** Free
- D** Compact

About the LCD screen

There may be 0.01 % or less chance of missing or constantly turned on pixels, but this is not a malfunction.

Preparing the Power Supply

Using the unit connected to the AC adaptor

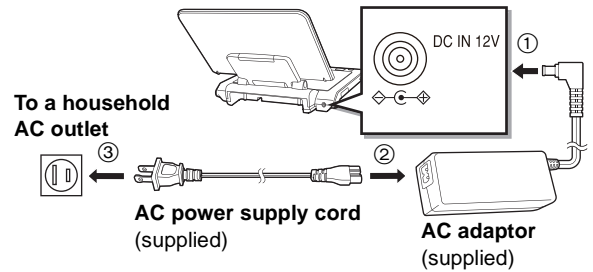

The unit is in the standby condition (the [⏻] indicator lights) when the AC power supply cord is connected. The primary circuit is always "live" as long as the AC adaptor is connected to an electrical outlet.

To conserve power

This unit consumes 0.3 W (**For U.S.A.**) or 0.4 W (**For Canada**) (Approximately 4 W (**For U.S.A.**) or 4.5 W (**For Canada**) when Quick Start is set to "On" of power even when turned off. When the unit is not going to be used for a long time, disconnect the AC power supply cord from the household AC outlet.

Using the battery pack

This unit can be used in places without an AC outlet, such as outdoors, by attaching the supplied battery pack.

- The battery is not charged at the time of purchase. Charge before initial use.
- The battery is designed only for use with this unit. It cannot be used with other equipment.

■ Attaching the battery pack

Turn the unit off before attaching or detaching the battery pack.

Bottom side of this unit

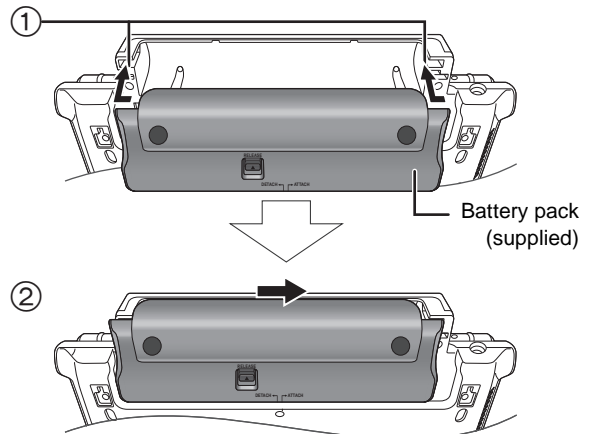

- 1** Bring in from the left, aligning the grooves.
- 2** Slide all the way to the right until you hear a "click". Check to make sure it is securely fastened.

■ Detaching the battery pack

Bottom side of this unit

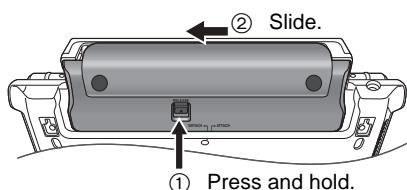

When not using for long periods of time

- Detach the battery pack (⇒ above).
(Even when the unit is turned off, there is a small amount of voltage running through the unit, and this may result in a malfunction.)
- Recharge the battery for re-use.

■ Recharging the battery pack

Attach the battery pack and connect the AC adaptor (⇒ 10). The [CHARGE] indicator (⇒ 8) lights while charging the battery, and the [CHARGE] indicator turns off when battery charging is finished.

- “ECO-charge”(⇒ 29) function can be used with this unit.
Charging mark is displayed for a few seconds on the lower right of the screen while the power is “Off”.

“ECO-charge”
is set to “On”

“ECO-charge”
is set to “Off”



■ Approximate recharging and play times (Hours)

Battery pack	Recharging ¹		Play ^{1,2}
	“ECO-charge”		
	“Off”	“On”	
DY-DB20 (supplied)	4	3.25	4
DY-DB30 (optional)	5	4	5
DY-DB300 (optional)	7	5.5	8

¹ at 20 °C (68 °F) / using headphones / LCD brightness level is “-5” (⇒ 13, “Adjusting the pictures on the LCD screen”).

² When the battery pack is recharged setting “ECO-charge” to “Off” (When the battery pack is recharged setting “ECO-charge” to “On”, the battery duration is about 80 %.)

- Play time indicated above may differ depending on the use.

■ Checking the remaining battery charge

Not displayed when the AC adaptor is in use.

Press [SUB MENU] while the power is “On”

Remaining charge is displayed for a few seconds at the bottom right of the screen.

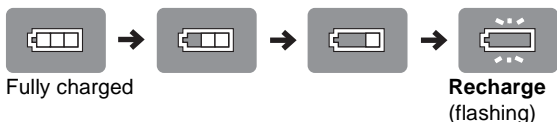

Charge the battery pack when the display starts to flash.

- Appears automatically when there is only a few minutes of charge remaining.
- The power may turn off without the display flashing when the media is played back with the battery low on charge.

Connecting the supplied Car DC Adaptor

Before connection, consult your car owner’s manual or your dealer.

- Connect to the cigarette lighter socket of a vehicle that has a 12 V battery. It is not compatible with a vehicle that has a 24 V battery.
- This is a special negative grounded Car DC Adaptor. Using this Car DC Adaptor with a plus grounded car can cause malfunction and lead to fire.

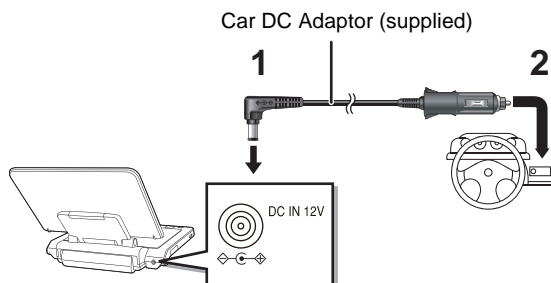

- 1 Connect the car DC adaptor to the unit.
- 2 Connect the car DC adaptor to the cigarette lighter socket.

Replacing the fuse

Replace only with the specified 125 V/250 V, 3.15 A fuse. Use of any other type can cause fire.

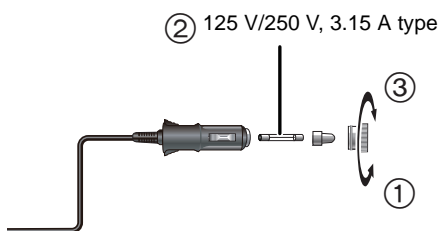

- ① Open the socket.
- ② Replace the fuse.
- ③ Close the socket.

Cautions

- To avoid draining your car battery
 - Disconnect the Car DC Adaptor from the cigarette lighter after use. The Car DC Adaptor continues to consume some power even if it is not being used, and if a battery pack is attached to this unit, it will start recharging which uses more power.
 - Do not use the Car DC Adaptor for long periods when the engine is not running.
- Leave some slack in the cord.
- No responsibility will be taken for damage that occurs due to faulty installation.

Turning on/off the unit



Press [POWER ].

The unit is turned off when [POWER ] is pressed again.

- Press [POWER ] for approx. 0.5 seconds to turn on the unit when the battery pack and the remote control are used.
- The power is shut off if the screen is closed while the power is "On".
- When the "Automatic Standby (No Action)" is set to "On" (initially set to "On"), the unit will be turned off automatically after 15 minutes (5 minutes when the battery pack is used) when it is in stopped status (⇒ 29).
- The startup will take time. The operation related to startup of the unit after turning on this unit can be quickened by setting the initial setup "Quick Start" (⇒ 29) to "On" (initially set to "Off"). (The power consumption will increase)
- You may hear operational sounds when the unit is turned on, but this is due to the initialization of the pickup unit, and it is not a malfunction.

Easy Setting

After opening the LCD screen and pressing [POWER ] for the 1st time, a screen for the basic settings will appear.

Follow the on-screen instructions and make the settings with [, ] and [OK].

"On-screen Language" (⇒ 28), "Picture Quality Mode" (⇒ 13) and "Quick Start" (⇒ 29) are set.

- You can perform this setup anytime by selecting "Easy Setting" in the Player Settings menu. (⇒ 29)
- You can also change this setting individually. (⇒ 13, 28, 29)

Turn the unit off automatically

The unit is turned off automatically after set time has passed.

Switch by pressing the [OFF TIMER].

e.g., 30 min.





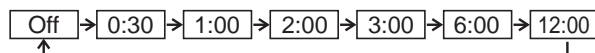

It will switch every time it is pressed.



Showing FUNCTION MENU

Some functions of this unit can be operated from FUNCTION MENU.

Press [, , , ] to select the item and press [OK].

- When multiple contents are recorded, select the types of contents or the title.
- If there are any other items, repeat these steps.

e.g.,

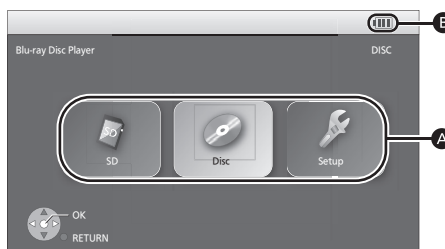

A Items

- ▷ SD
 - "Photos" (⇒ 18)
 - "Videos (AVCHD)" (⇒ 14)
 - "Videos (MPEG-2)" (⇒ 14)
- ▷ Disc
 - "Videos" (⇒ 14)
 - "Photos" (⇒ 18)
 - "Music (MP3)" (⇒ 20)
 - "Videos (AVCHD)" (⇒ 14)
- ▷ Setup
 - "Player Settings" (⇒ 26)
 - "LCD Menu" (⇒ 13)
 - "SD Card Management" (⇒ 17)

B Icon

 Remaining battery charge (⇒ 11)

 Using the AC adaptor

To show the FUNCTION MENU screen

Press [FUNCTION MENU].

- FUNCTION MENU also appears by pressing [SUB MENU] and selecting "FUNCTION MENU".

- Items to be displayed may vary with the media.

Adjusting the pictures on the LCD screen

1 Press [LCD MENU].

- It is also possible to display with the following procedures.
- ① Press [SUB MENU].
- ② Select "Other Functions" with [▲, ▼], and press [OK].
- ③ Select "LCD Menu" with [▲, ▼], and press [OK].

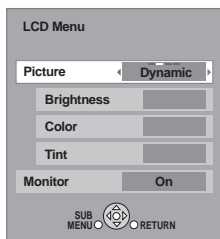

2 Select the item with [▲, ▼].

3 Change the setting with [▲, ▼, ◀, ▶].

Picture: Adjusting image quality

- ▷ Standard: Standard
- ▷ Dynamic: Picture with high contrast
- ▷ Night: Picture suitable for viewing in dark places
- ▷ User
 - Brightness: -5 to +5
 - Color: -5 to +5
 - Tint: -5 to +5

Monitor: Displaying images

- ▷ On: Image display
- ▷ Off: No image
- When "Off" is selected, select "Yes" with [◀, ▶], and then press [OK].

To exit the screen

Press [EXIT].

To display images when the "Monitor" is set to "Off"

Press [LCD MENU], [SUB MENU] or [DISC/SD].

- Underlined items are the factory presets.
- If you are not using the LCD on this unit, select "Off". No image mark is displayed on the lower left of the screen when it is set to "Off".



Loading the disc or SD card

Disc

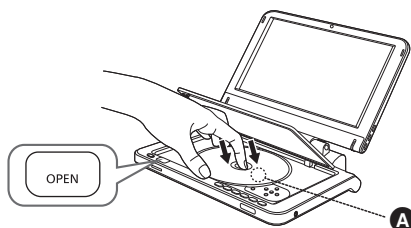

1 Press [OPEN].

2 Set the disc and close the lid.

- Set the disc securely until you hear a "click", with the label side up. (Double-sided disc: place the label side up that you want to play back)

- Some discs may start playing when they are loaded with the unit turned on.
- About discs with a cartridge
 - DVD-RAM, DVD-R: Remove the disc from the cartridge and set the disc in the tray. Cartridge discs cannot be used.
 - Place the disc back into the cartridge for storage to prevent dirt and scratches after use.
- Do not touch the lens as it may make it dirty.

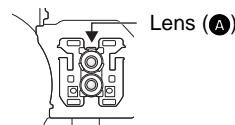

SD card

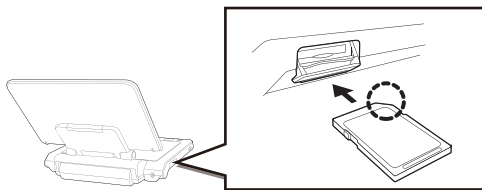

1 Open the cover at the side of the unit.

2 Insert the SD card into the SD card slot.

- With the label side up, insert the card straight in the direction shown in the figure, until you hear a sound.

3 Close the cover.

To remove the card

In step 2 above, press the center of the card until it "clicks", and pull the card out straight.

Basic play (Playing video contents)

BD-V DVD-V DVD-VR AVCHD MKV MPEG2

Instructions for operations are generally described using the remote control in these operating instructions.

Insert a disc or SD card (⇒ 13).

Play starts.

- If play does not start, press [▶] (PLAY).
- If a media with data in different file formats is inserted, the file selection menu is displayed. Press [▲, ▼] to select the desired file format and press [OK].
- If the menu is displayed, press [▲, ▼, ◀, ▶] to select the item and press [OK].
- If the screen prompting you to use the color buttons appears, continue to operate with the color buttons on the remote control.

- The producers of the disc can control how discs are played, so you may not always be able to control play as described in these operating instructions. Read the disc's instructions carefully.
- When playing a set of two or more BD-Video discs, the menu screen may continue to display even if the disc has been ejected.
- The start of playback may take time depending on the disc or SD card.
- The sound of rotation may be audible during disc playback, but this is not a malfunction.

To adjust the volume

Press [VOL -] or [VOL +].

- When using headphones, turn down the volume before connection.

Switch the media to playback

Press [DISC/SD] to select "DISC" or "SD".

- If a media is inserted while the unit is stopped, the drive switches automatically depending on the inserted media.

To show menus

Press [DIRECT NAVIGATOR/TOP MENU].

- Total title number may not be displayed properly on +R/+RW.

e.g., DVD-RAM

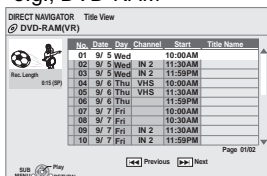

- The menu also appears by pressing [SUB MENU] and selecting "Top Menu" or "Menu".

To show Pop-up menu

BD-V

The Pop-up menu is a special feature available with some BD-Video discs. This menu may vary with discs. For the operating method, refer to the instructions for the disc.

- ① Press [POP-UP MENU].
 - ② Press [▲, ▼, ◀, ▶] to select the item and press [OK].
- Pop-up menu also appears by pressing [SUB MENU] and selecting "Pop-up Menu".
 - Press [POP-UP MENU] to exit the screen.

Displaying subtitle text

MKV

You can display subtitle text on MKV video disc with this unit. The operation might be different or it may not operate properly depending on the way the file was made or the state of this unit (playing, stopped, etc.).

Set "Subtitle" in "Media" (⇒ 24)

- MKV video files that do not display "Text" do not contain subtitle text.
- If the subtitle text is not displayed correctly, try changing the language settings. (⇒ 26)

Playing a title in another folder

MKV

- ① While the "DIRECT NAVIGATOR" is displayed Press [SUB MENU].
 - ② Press [▲, ▼] to select "Select Folder" and press [OK].
 - ③ Press [▲, ▼] to select a folder and press [OK].
- You cannot select folders that contain no compatible files.

Playing HD Video or SD Video

AVCHD MPEG2

It is possible to play the HD (High Definition) video recorded on the Panasonic High definition Video Camera on the DVD-RAM/ R/RW/R DL/+R/+RW/+R DL or SD card, and SD (Standard Definition) Video recorded on the Panasonic SD Video Camera on the SD card.

1 Insert a disc or SD card (⇒ 13).

"Video (AVCHD)" or "Video (MPEG-2)" screen is displayed.

e.g.,

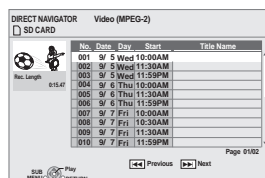

- If a media containing data in different file formats is inserted, the file selection menu may be displayed. Press [▲, ▼] to select "Videos (AVCHD)" or "Videos (MPEG-2)" and press [OK].

2 Press [▲, ▼, ◀, ▶] to select the title and press [OK].

- Total title number may not be displayed properly on +R/+RW.

To exit the menu screen

Press [EXIT].

- It may pause for a few seconds on the break of images when editing such as partial deletion is performed.
- High definition video (transfer rate of 18 Mbps or faster) cannot be played back correctly if it was recorded on a DVD compatible to double speed or slower.
- It is not possible to playback AVCHD and MPEG2 video which have been dragged and dropped, copied and pasted to the media.

Playing chapters or playlists

DVD-VR AVCHD

1 Insert a disc or SD card (⇒ 13).

If the menu is displayed, press [▲, ▼] to select the item and press [OK].

2 Press [▲, ▼] to select the title and press [SUB MENU].

e.g., DVD-VR

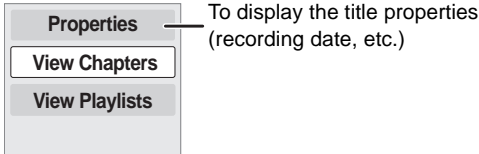

3 Press [▲, ▼] to select “View Chapters” or “View Playlists” and press [OK].

e.g., AVCHD

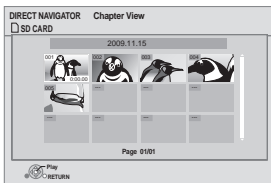

4 Press [▲, ▼, ◀, ▶] to select the chapter or playlist and press [OK].

To display “Title View” screen

While “Playlist View” screen is displayed, press [SUB MENU] and select “View Titles”.

To return to the previous screen

Press [RETURN].

To exit the screen

Press [EXIT].

Other operations during play

These functions may not work depending on the media and contents.



The stopped position is memorized.

Resume play function

Press [▶] (PLAY) to restart from this position.

- The memorized position is cleared in the following instances:
 - [■] is pressed several times
 - The disc or SD card is removed
 - The unit is turned off due to such occurrences as power outage, the removal of the AC adaptor or waste of the battery pack's remaining power when the unit is turned on
- **BD-V**: On BD-Video discs including BD-J (⇒ 40), the resume play function does not work.
- **MKV MPEG2**: The position is cleared if the unit is turned off.



- Press [||] again or [▶] (PLAY) to restart play.



The speed increases up to 5 steps.

- Press [▶] (PLAY) to revert to normal playback speed.
- For some discs, the speed may not change.

Search

While playing, press [◀◀] or [▶▶].

- **DVD-VR DVD-V**: Audio is heard during the first step of forward search.
- **BD-V AVCHD MKV MPEG2**: Audio is not heard during all steps of search.
- **CD MP3**: The speed is fixed to a single step.

Slow-motion

While paused, press [◀◀] or [▶▶].

- **BD-V AVCHD**: Forward direction [▶▶] only.
- **DVD-VR**: If continued for approx. 5 minutes, slow-motion play pauses automatically.



Skip to the title, chapter or track you want to play.

- Each press increases the number of skips.
- **MKV**: Backward direction [◀◀] only.



Frame-by-frame

While paused, press [◀] (◀||) or [▶] (||▶).

Each press shows the next frame.

- Press and hold to change in forward or backward succession.
- Press [▶] (PLAY) to revert to normal playback speed.
- **BD-V AVCHD**: Forward direction [▶] (||▶) only.

Screen Aspect

When black bars are shown at the top, bottom, left, and right sides of the screen, you can enlarge the image to fill the screen.

- 1 Press [SUB MENU].
- 2 Press [▲, ▼] to select “Other Functions” and press [OK].
- 3 Press [▲, ▼] to select “Screen Aspect” and press [OK].
- 4 Press [◀, ▶] to select “Side cut” or “Zoom”.

- ▷ Normal: Normal output
 - ▷ Side cut: The black bars on the right and left sides of the 16:9 image disappear and the image is enlarged. Please note that the right and left sides of the image are cut off when the black bar is not displayed.
 - ▷ Zoom: The black bars on the top and bottom sides of the 4:3 image disappear and the image is enlarged. Please note that the top and bottom sides of the image are cut off when the black bar is not displayed.
- Please note that the top, bottom and sides of the image will be cut off in images with no black bars.
 - Screen aspect will return to “Normal” in the following instances:
 - The drive is switched
 - The unit is turned on/off
 - **BD-V DVD-V**: “Side cut” does not have any effect.
 - When “TV Aspect” (⇒ 28) is set to “4:3 Pan & Scan” or “4:3 Letterbox”, the “Zoom” effect is disabled.

STATUS

Status messages

The status messages give you information about what is currently being played.

Each time you press [STATUS], the information displayed will change.

- It is also possible to display with the following procedures:
 - ① Press [SUB MENU].
 - ② Select “Status” with [▲, ▼], and press [OK].

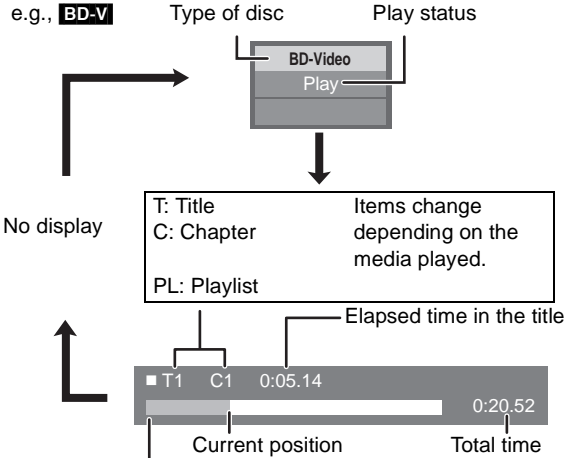

Depending on the kind of media or the playback status, this display may not appear.

AUDIO

Changing audio

- It is also possible to display with the following procedures:
 - ① Press [SUB MENU].
 - ② Select “Other Functions” with [▲, ▼], and press [OK].
 - ③ Select “Audio” with [▲, ▼], and press [OK].

BD-V DVD-V

e.g., **DVD-V**



English is selected.

You can change the audio channel number each time you press [AUDIO] or [▲, ▼]. This allows you to change the soundtrack language (⇒ 24, “Soundtrack”), etc.

DVD-VR MKV MPEG2

AudioLR→AudioL→Audio R

e.g.,

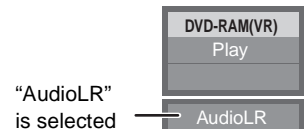

“AudioLR” is selected

You can change soundtracks each time you press [AUDIO].

Enjoying picture-in-picture in BD-Video

BD-V

- These discs may not be on sale in certain regions.
- The usable functions and the operating method may vary with each disc, please refer to the instructions on the disc and/or visit their website.

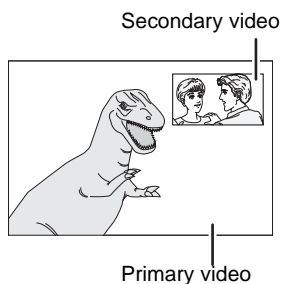

To turn on/off secondary video

Set “Video” in “Secondary Video” to “On” or “Off” (⇒ 24, Press [DISPLAY] ⇒ “Media” ⇒ “Signal Type”)

The secondary video is played.

To turn on/off secondary audio

Set “Soundtrack” in “Secondary Video” to “On” or “Off” (⇒ 24, Press [DISPLAY] ⇒ “Media” ⇒ “Signal Type”)

The secondary audio is played.

- During search/slow-motion or frame-by-frame, only the primary video is displayed.
- When “BD-Video Secondary Audio” in “Digital Audio Output” is set to “Off”, secondary audio will not be played even if you set “Soundtrack” in “Secondary Video” to “On”. Please check that “BD-Video Secondary Audio” is set to “On” (⇒ 27).
- The playback method determined by the disc will take priority, so it may not play back in the manner specified with this unit.
- When the secondary video is turned off, the secondary audio will not be played.

■ Formatting SD cards/Deleting data

- If the SD card you use is formatted, all data on the card will be erased. It cannot be recovered.

- ① Insert an SD card (⇒ 13). e.g.,
- ② Press [FUNCTION MENU].
- ③ Press [◀, ▶] to select “Setup” and press [OK].
- ④ Press [▲, ▼] to select “SD Card Management” and press [OK].
- ⑤ Press [▲, ▼] to select “BD-Video Data Erase” or “Format SD Card” and press [OK].
- ⑥ Press [◀, ▶] to select “Yes” and press [OK].
- ⑦ Press [◀, ▶] to select “Start” and press [OK].

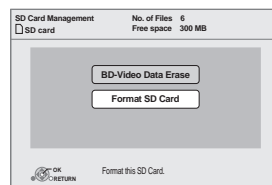

- If you experience any problems, first, try formatting the SD card in this unit.
- While using this feature, do not open the cover at the side of the unit, touch or remove the SD card.

Playing still pictures

JPEG

Playback of the BD-RE, DVD-RAM/R/R DL or CD-R/RW with still pictures recorded. This unit can also play still pictures recorded on the SD card.

(About structure of folders ⇒ 32, “Structure of folders that can be played in this unit”)

1 Insert a disc or SD card (⇒ 13).

- If the media containing data in different file formats is inserted, the file selection menu may be displayed.

Press [▲, ▼] to select “Photos” and press [OK].

2 Press [▲, ▼] to select the folder and press [OK].

e.g.,

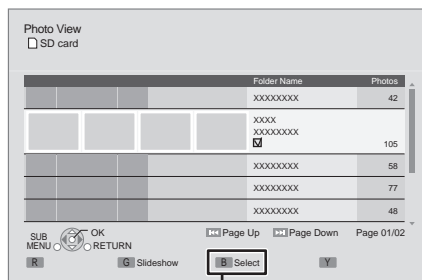

To select folders or still pictures that are played on slideshow.

3 Press [▲, ▼, ◀, ▶] to select the still picture and press [OK].

To return to the previous screen

Press [RETURN].

To exit the screen

Press [EXIT].

- Press [◀, ▶] to display the previous or next still picture.
- Press [◀◀, ▶▶] to show other pages.
- Playback is not possible for pictures other than JPEGs.
- Black bars may be displayed on the top, bottom or sides depending on the picture aspect ratio.
- Still pictures displayed as  cannot be played back with this unit.

Useful functions during still picture play

Start Slideshow

You can display still pictures one by one at a constant interval.

1 Press [SUB MENU].

- When “Slideshow” is displayed, press [OK].

2 Press [▲, ▼] to select “Start Slideshow” and press [OK].

To stop slideshow

Press [■].

Slideshow settings

1 While the “Photo View” screen is displayed Press [SUB MENU].

2 Press [OK].

3 To change the display interval

Press [▲, ▼] to select “Display Interval” and press [◀, ▶] to select the interval (“Long”, “Normal” or “Short”).

- When a still picture with a large number of pixels is played, the display interval may become longer. Even if the setting is changed, the display interval may not become shorter.

To set display method

Press [▲, ▼] to select “Transition Effect” and press [◀, ▶] to select “Fade”, “Motion” and “Random”.

- ▷ Fade: Still pictures are changed by fading out and fading in.
- ▷ Motion: Still pictures are changed by fading out and fading in, while they are enlarged, reduced, or moved up or down.
- ▷ Random: In addition to the “Motion”, still pictures are changed by various methods.

To repeat slideshow

Press [▲, ▼] to select “Repeat Play” and press [◀, ▶] to select “On” or “Off”.

To listen to Background Music in random order (SD card only)

The music CD can be played back as Background Music in random order during the slideshow.

Press [▲, ▼] to select “Random Soundtrack” and press [◀, ▶] to select “On” or “Off”.

- You cannot search or skip on the music.
- When the slideshow stops, the playback of the music also stops.

To listen to Background Music (SD card only)

The music CD can be played back as Background Music during the slideshow.

Press [▲, ▼] to select “Soundtrack” and press [◀, ▶] to select “CD” or “Off”.

- You cannot search or skip on the music.
- When the slideshow stops, the playback of the music also stops.

To return to the previous screen

Press [RETURN].

To change the Screen Aspect

- 1 While playing
Press [SUB MENU].
- 2 Press [▲, ▼] to select “Screen Aspect” and press [OK].
- 3 Press [◀, ▶] to select “Normal” or “Side cut”. (⇒ 16, “Screen Aspect”)

- “Zoom” does not have any effect.

To show the photo properties

While playing

Press [STATUS].

Each time you press [STATUS], the information displayed will change.

- It is also possible to display with the following procedures:

- ① Press [SUB MENU].
- ② Select “Status” with [▲, ▼], and press [OK].
- ③ Press [◀, ▶] to select “Off”, “Date” (Shooting date) or “Details” and press [OK].

e.g., “Details” screen

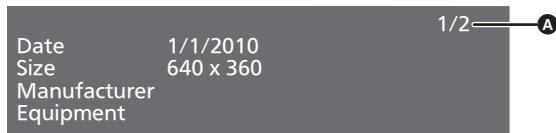

- Ⓐ Number of the still picture in the folder / total numbers of the still pictures in the folder

To exit the screen

Press [STATUS].

Rotate

- 1 While playing (except for slideshow)
Press [SUB MENU].
- 2 Press [▲, ▼] to select “Rotate Right” or “Rotate Left” and press [OK].

- The rotation information will be stored until the unit is turned off or the media is removed.

Playing music

CD MP3

You can play generally available music CDs or MP3 files recorded onto a DVD-R/R DL and CD-R/RW. (About structure of folders ⇒ 32, “Structure of folders that can be played in this unit”)

1 Insert a disc (⇒ 13).

“Music list” screen is displayed.

- If the media containing data in different file formats is inserted, the file selection menu may be displayed. Press [▲, ▼] to select “Music (MP3)” and press [OK].

2 Press [▲, ▼] to select the track and press [OK].

Play starts on the selected track.

- Playback for some discs may start automatically.

e.g., **CD**

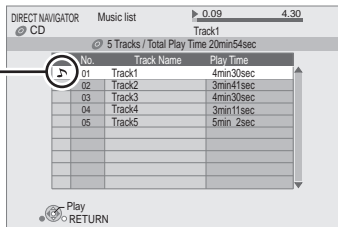

“” indicates the track currently playing.

- You can use search and skip functions. (⇒ 15)
- The screen switches to Screen Saver mode if there is no operation for 2 minutes after starting playback. (Playback continues.)

Playing a track in another folder

MP3

- 1 While the “Music list” is displayed Press [SUB MENU].
- 2 Press [▲, ▼] to select “Select Folder” and press [OK].
- 3 Press [▲, ▼] to select a folder and press [OK].

e.g.,

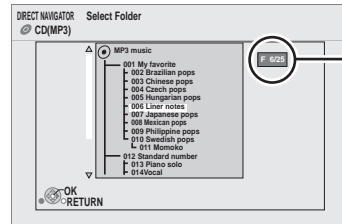

Selected folder No. /Total folders
If the folder has no track, “—” is displayed as folder number.

- You cannot select folders that contain no compatible tracks.

To return to the previous screen

Press [RETURN].

Using this unit with other equipment

It is possible to enjoy the high quality video and audio of this unit on the large screen by connecting this unit with the TV using a single cable.

- **Turn off all equipment before connecting and read the appropriate operating instructions.**
- **Linked operation is possible by connecting to a Panasonic TV (VIERA) or amplifier that is compatible with the VIERA Link (HDMI) function. (⇒ 22)**

- **Non-HDMI-compliant cables cannot be utilized.**
- **Please use High Speed HDMI Cables that have the HDMI logo (as shown on the cover). It is recommended that you use Panasonic's HDMI cable. When outputting 1080p signal (⇒ 28, "HDMI Resolution"), please use HDMI cables 5.0 meters (16.4 ft.) or less.**

Recommended part number:

RP-CDHS15 (1.5 m/4.9 ft.), RP-CDHS30 (3.0 m/9.8 ft.), RP-CDHS50 (5.0 m/16.4 ft.), etc.

Preparation

Connect the devices to the unit.

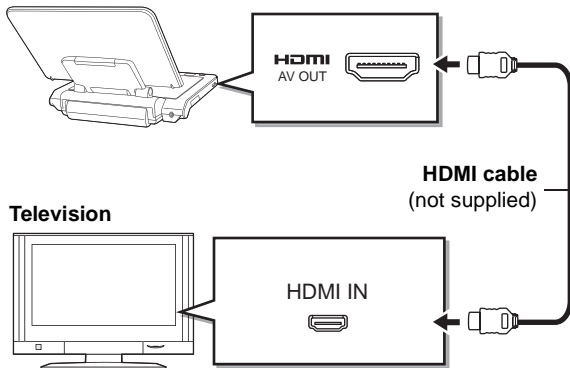

You can enjoy the high quality surround audio in Dolby Digital Plus and Dolby TrueHD by connecting this unit to the HDMI compatible multi-channel amplifier. (⇒ 30) (Only when connected to an amplifier compatible with each audio)

1 Turn on the power of the connected device (TV, etc.), and switch the input.

Example: Set the input to "HDMI" or similar (the name of input may be different depending on the connected device).

2 Start playback on this unit.

Video and audio are output from the connected device.

Notice

- To turn off the display of this unit, select "Off" for the "Monitor" in the "LCD Menu". (⇒ 13)
- The quality of video will lower on the screen of this unit when HDMI is connected, but it is not a malfunction.
- If you raise the volume on the television while playing this unit, the volume may abruptly become very loud when you switch to a television broadcast. Return the volume to its normal level before changing.

Linked operations with the TV

(VIERA Link™ “HDAVI Control™”)

What is VIERA Link “HDAVI Control”?

VIERA Link™ is a new name for EZ Sync™. VIERA Link “HDAVI Control” is a convenient function that offers linked operations of this unit, and a Panasonic TV (VIERA) or amplifier/receiver under “HDAVI Control”.

You can use this function by connecting the equipment with an HDMI cable. See the operating instructions for connected equipment for operational details.

- VIERA Link “HDAVI Control”, based on the control functions provided by HDMI which is an industry standard known as HDMI CEC (Consumer Electronics Control), is a unique function that we have developed and added. As such, its operation with other manufacturers' equipment that supports HDMI CEC cannot be guaranteed.
- **This unit supports “HDAVI Control 5” function.** “HDAVI Control 5” is the newest standard (current as of December, 2010) for Panasonic's HDAVI Control compatible equipment. This standard is compatible with Panasonic's conventional HDAVI equipment.
- Please refer to individual manuals for other manufacturers' equipment supporting VIERA Link function.

Setting VIERA Link™ “HDAVI Control™”

Preparation

Connect this unit to your TV or amplifier/receiver with an HDMI cable (⇒ 21).

- 1 Set “VIERA Link” to “On” (⇒ 29). (The default setting is “On”).**
- 2 Set the “HDAVI Control” operations on the connected equipment (e.g., TV).**
- 3 Turn on all “HDAVI Control” compatible equipment and select this unit's input channel on the connected TV so that the “HDAVI Control” function works properly.**
Also when the connection or settings are changed, repeat this procedure.

When you want to leave the TV on and set only this unit to standby mode

Press [POWER 

Automatic input switching

When the following operations are performed, the television will automatically switch the input channel and display the corresponding action.

- When play starts on the unit
- When an action that uses the display screen is performed (e.g., DIRECT NAVIGATOR screen)
- When the HDMI is connected, with the unit turned on (first time only)

Power on link

When the television is off and the following operations are performed, the television will automatically turn on and display the corresponding action.

- When play starts on the unit
- When an action that uses the display screen is performed (e.g., DIRECT NAVIGATOR screen)

Power off link

All connected equipment compatible with “HDAVI Control”, including this unit, automatically turns off when you switch the television off.

- This unit automatically turns off even during playback or any other operation.

- When [▶] (PLAY) is pressed on this unit for “Automatic input switching” or “Power on link”, the playback image is not immediately displayed on the screen and it may not be possible to watch the contents from where playback started. In this case, press [◀◀] or [◀◀] to go back to where playback started.

Playing music continuously even after turning off power to the television

When the unit is connected to a Panasonic TV (VIERA) that supports HDAVI Control 2 or later and other device supports VIERA Link, the unit is turned off if the power to the television is turned off, since “Power off link” (⇒ above) operates.

The following operations make it possible to keep the power of the unit ON and to play music continuously.

- ① While playing music
Press [SUB MENU].
 - ② Press [▲, ▼] to select “TV Power” and press [OK].
- Sound may be discontinued for several seconds when the power to the television is turned off.
 - If the operation mentioned above is executed while audio is output from the television, the sound may not be output from the device. It is recommended to set the device beforehand so that audio will be output from the device.

When not using “HDAVI Control”

Set “VIERA Link” in the Setup menu to “Off”. (⇒ 29)

Easy control only with VIERA remote control

If you connect this unit to the TV that supports "HDAVI Control 2" or later with an HDMI cable, you can enjoy using more convenient functions.

You can operate this unit using buttons on the TV remote control.

The buttons that you can use for this unit vary depending on the TV. For details, refer to the operating instructions of the TV. Use the remote control supplied with this unit if you cannot operate this unit using buttons on the TV remote control.

- The operation of this unit may be interrupted when you press incompatible buttons on the TV remote control.

Using the FUNCTION MENU to operate this unit

By using the TV remote control, you can play media using the FUNCTION MENU.

1 Press the button for VIERA Link on the remote control.

2 Select the player.

The FUNCTION MENU is displayed. (⇒ 12)

- When the AC adaptor is connected while the unit is turned off, the unit will automatically turn on. For details, please refer to the TV user manual.
- Keep the screen of this unit opened. If the screen of this unit is closed, this unit cannot be operated with the TV remote control in any other condition.

Using the sub menu to operate this unit

By using the TV remote control, you can play discs using the "Control Panel" and display the Top Menu (for BD-Video and DVD-Video) or Pop-up Menu (for BD-Video), etc.

1 Press [SUB MENU].

- This can also be displayed by using the VIERA menu screen.
- The sub menu may not appear while the Top Menu for BD-Video or DVD-Video is displayed.

e.g.,

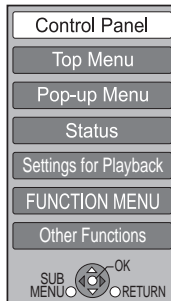

2 Select an item, then press [OK].

- Control Panel is displayed by selecting "Control Panel". Follow the indications on the screen.

Changing settings with the on-screen menu

On-screen menu operations

1 Press [DISPLAY].

- It is also possible to display with the following procedures:
 - ① Press [SUB MENU].
 - ② Select "Settings for Playback" with [▲, ▼], and press [OK].

e.g., BD-Video

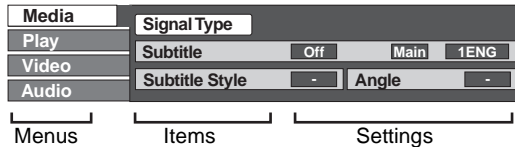

- Depending on the condition of the unit (playing, stopped, etc.) and media contents, there may be some items that you cannot select or change.

2 Press [▲, ▼] to select the menu and press [▶].

3 Press [▲, ▼, ◀, ▶] to select the item and press [▶].

4 Press [▲, ▼] to select the setting.

- Some items can be changed by pressing [OK].

To exit the on-screen menu

Press [DISPLAY] or [EXIT].

What you can change with the on-screen menu

Media

Signal Type

BD-V

▷ Primary Video

Video: The recording method of original video appears. (⇒ 25, "Video attribute")

Soundtrack: Select the type of audio or language. (⇒ 25, "Language", "Audio attribute")

▷ Secondary Video

Video: Select on/off of images.

The recording method of original video appears. (⇒ 25, "Video attribute")

Soundtrack: Select on/off of audio and the language. (⇒ 25, "Language", "Audio attribute")

Video

AVCHD

The recording method of original video appears. (⇒ 25, "Video attribute")

Soundtrack

AVCHD DVD-V

Select the type of audio or language. (⇒ 25, "Language", "Audio attribute")

DVD-VR MPEG2

The audio attributes appear. (⇒ 25, "Audio attribute")

MKV

Select the soundtrack number.

- Soundtrack numbers are displayed even when there is only one audio type.

Subtitle

BD-V AVCHD DVD-V

Turn the subtitle on/off and select the language. (⇒ 25, "Language")

DVD-VR (Only discs that contain subtitle on/off information)

Turn the subtitle on/off.

MKV

Turn the subtitle on/off and select "Text" or the subtitle number.

- Subtitle number is displayed even if there are not multiple subtitles.

Subtitle Style

BD-V

Select the subtitle style.

Audio channel

DVD-VR MKV MPEG2

Select the audio channel number.

(⇒ 16, "Changing audio")

Angle

BD-V DVD-V

Select the number of the angle.

Some items may be changed only on the disc specific menu. (⇒ 14)

Play

Repeat Play

(Only when the elapsed time is being displayed on the display.)

Select the item which you want to repeat. The items displayed differ depending on the type of media.

- ▷ All tracks: All tracks
- ▷ Chapter: Chapter
- ▷ Playlists: Playlist
- ▷ Title: Title
- ▷ One track: Track
- ▷ Off

Select "Off" to cancel.

Random

CD MP3

While playing, press [**▲**, **▼**] to select "On".

Random playback starts from the next track.

- ▷ On
- ▷ Off

Video

Picture

BD-V AVCHD DVD-VR DVD-V MKV MPEG2

Select the picture quality mode during play.

- ▷ Normal: Default setting
- ▷ Soft: Soft picture with smoother video
- ▷ Fine: Details are sharper
- ▷ Cinema: Mellows movies, enhances detail in dark scenes.
- ▷ User: You can make further adjustments.
(⇒ below)

① Press [**▶**] to select "Picture Adjustment" and press [OK].

② Select the item using [**▲**, **▼**] and adjust it with [**◀**, **▶**].

- Contrast: Increases the contrast between light and dark parts of the picture (-7 to +7).
- Brightness: Brightens the picture (0 to +15).
- Sharpness: Adjusts the sharpness of the edges of the horizontal lines (-6 to +6).
- Color: Adjusts the shade of the picture's color (-7 to +7).
- Gamma: Adjusts the brightness of dark portions of the screen (0 to +5).
- 3D NR: Reduces the rough noise in the background to give a greater feeling of depth (0 to +4).
When "24p Output" is set to "On", this function may not operate. (⇒ 28)
- Integrated NR: Smoothes block noise and reduces the smudging that appears around contrasting sections of the picture (0 to +3).

Progressive

Select the method of conversion for progressive output to suit the type of material being played (⇒ 40, "Film and video").

- ▷ Auto: Automatically detects the film and video content, and appropriately converts it.
- ▷ Video: Select when using "Auto" and the content is distorted.

24p

DVD-V

Movies and other material recorded on DVD-Video at 24p are output at 24p.

- ▷ On
- ▷ Off

Only when you have selected "On" in "24p Output" (⇒ 28)

Audio

Dialog Enhancer

BD-V AVCHD DVD-VR DVD-V MKV MPEG2

(3 channels or more only, including a center channel)

The volume of the center channel is raised to make dialog easier to hear.

- ▷ On
- ▷ Off

This function is effective for audio from the HDMI AV OUT terminal only when "Dolby D/Dolby D +/Dolby TrueHD" or "DTS" is set to "PCM".

Language

ENG:	English	THA:	Thai
FRA:	French	POL:	Polish
DEU:	German	CES:	Czech
ITA:	Italian	SLK:	Slovak
ESP:	Spanish	HUN:	Hungarian
NLD:	Dutch	FIN:	Finnish
SVE:	Swedish	ARA:	Arabic
NOR:	Norwegian	HIN:	Hindi
DAN:	Danish	PER:	Persian
POR:	Portuguese	IND:	Indonesian
RUS:	Russian	MRI:	Maori
JPN:	Japanese	BUL:	Bulgarian
CHI:	Chinese	RUM:	Romanian
KOR:	Korean	GRE:	Greek
MAL:	Malay	TUR:	Turkish
VIE:	Vietnamese	*	Others

Audio attribute

LPCM/ <input type="checkbox"/> Digital/ <input type="checkbox"/> Digital+/ <input type="checkbox"/> TrueHD/DTS/DTS 96/DTS-HD HI RES/DTS-HD MSTR/MPEG	Signal type
ch (channel)	Number of channels
k (kHz)	Sampling frequency
b (bit)	Number of bits
bps (bit per second)	Transfer rate of bit

Video attribute

MPEG-2/MPEG-4 AVC/VC-1	Video recording method
480/576/720/1080	Video Format
24p/50i/60i/50p/60p	Video Frame rate
YCbCr4:2:2/YCbCr4:4:4/RGB	Color Space
bps (bit per second)	Transfer rate of bit

Changing the unit's settings

Change the unit's settings if necessary. The settings remain intact even if you switch the unit to standby.

Setup menu operations

- 1 While stopped**
Press [SETUP].
- 2 Press [▲, ▼] to select the menu and press [OK].**
- 3 Press [▲, ▼] to select the item and press [OK].**
If there are any other items, repeat these steps.
- 4 Press [▲, ▼, ◀, ▶] to select the option and press [OK].**

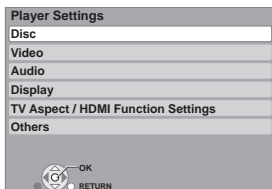

To return to the previous screen

Press [RETURN].

To exit the screen

Press [SETUP] or [EXIT].

- There may be differences in operation methods. If this happens, follow the on-screen instructions for the operation.

About the password

The password of the following items are common. Don't forget your password.

- "DVD-Video Ratings" (⇒ below)
- "BD-Video Ratings" (⇒ right)

Summary of settings

Underlined items are the factory presets.

Disc

DVD-Video Ratings

Set a ratings level to limit DVD-Video play.

Follow the on-screen instructions. Enter a 4-digit password with the numbered buttons when the password screen is shown.

- ▷ 8 No Limit:
All DVD-Video can be played.
- ▷ 1 to 7:
Prohibits play of DVD-Video with corresponding ratings recorded on them.
- ▷ 0 Lock All:
Prohibits play of all DVD-Video.

Changing settings (When level 0 to 7 is selected)

- ▷ Unlock Player ▷ Change Password
- ▷ Change Level ▷ Temporary Unlock

BD-Video Ratings

Set an age limit of BD-Video play.

Follow the on-screen instructions. Enter a 4-digit password with the numbered buttons when the password screen is shown.

- ▷ No Limit:
All BD-Video can be played.
- ▷ Enter year(s):
Prohibits play of BD-Video with corresponding ratings recorded on them.
- ▷ 0 to 21 year(s):
Prohibits play of BD-Video with corresponding ratings recorded on them.

Changing settings (When 0 to 254 year(s) is selected)

- ▷ Unlock Player ▷ Change Password
- ▷ Change Level ▷ Temporary Unlock

Audio Language

Choose the language for audio.

BD-V **DVD-V**

- Some discs start in a certain language despite any changes you make here.
 - When the selected language is not available on the disc, the default language is played. There are discs where you can only switch the language from the menu screen. (⇒ 14)
 - Enter a code (⇒ 29) with the numbered buttons when you select "Other *****".
- ▷ English ▷ French ▷ Spanish
 - ▷ Original:
The original language of each disc will be selected.
 - ▷ Other *****

Subtitle Language

Choose the language for subtitle.

BD-V **DVD-V**

- Some discs start in a certain language despite any changes you make here.
 - When the selected language is not available on the disc, the default language is played. There are discs where you can only switch the language from the menu screen. (⇒ 14)
 - Enter a code (⇒ 29) with the numbered buttons when you select "Other *****".
- ▷ Automatic:
If the language selected for "Audio Language" is not available, subtitles of that language will automatically appear if available on that disc.
 - ▷ English ▷ French ▷ Spanish
 - ▷ Other *****

Menu Language

Choose the language for disc menus.

BD-V **DVD-V**

- Some discs start in a certain language despite any changes you make here.
 - When the selected language is not available on the disc, the default language is played. There are discs where you can only switch the language from the menu screen. (⇒ 14)
 - Enter a code (⇒ 29) with the numbered buttons when you select "Other *****".
- ▷ English ▷ French ▷ Spanish
 - ▷ Other *****

Subtitle Text

MKV

Select a suitable item according to the language used for MKV subtitles text (⇒ 14).

- This item is displayed only after playing back a file.

Video

Still Mode (paused video)

BD-V **AVCHD** **DVD-V**

Select the type of picture shown when you pause playback (⇒ 40, "Frames and fields").

- ▷ **Auto:**
Automatically selects the type of picture shown.
- ▷ **Field:**
Select if jittering occurs when "Auto" is selected. (The picture is coarser.)
- ▷ **Frame:**
Select if small text or fine patterns cannot be seen clearly when "Auto" is selected.
(The picture is clearer and finer.)

Seamless Play

DVD-VR

Select the play mode between playlist chapter segments and partially deleted titles.

- ▷ **On:**
The chapters in playlists are played seamlessly. This does not work while searching or when there are several audio types included on the playlist. Additionally, the positioning of chapter segments may change slightly.
- ▷ **Off:**
The points where chapters in playlists change are played accurately, but the picture may freeze for a moment.

Audio

Dynamic Range Compression

BD-V **AVCHD** **DVD-V** **MKV**

You can listen at low volumes but still hear dialog clearly. (Dolby Digital, Dolby Digital Plus and Dolby TrueHD only)

- "Auto" is effective only when playing Dolby TrueHD.

- ▷ On
- ▷ **Off**
- ▷ Auto

Digital Audio Output

Press [OK] to show the following settings.

- For details on digital output (⇒ 30)

Dolby D/Dolby D +/Dolby TrueHD

DTS

Select whether Dolby Digital, Dolby Digital Plus, Dolby TrueHD or DTS Digital Surround is output in "Bitstream" or "PCM" format.

- Not making the proper settings may result in noise.
- If the unit is connected with the HDMI AV OUT terminal, the specifications of the connected equipment take precedence over this unit and audio selected in these items may not be output (e.g., when a television is connected, the HDMI audio output of this unit is limited to down-mixed 2ch.)

▷ **Bitstream:**

Select "Bitstream" when the connected equipment can decode the respective audio format.

- Connect equipment supporting HDMI (High Bit rate Audio) and use a High Speed HDMI Cable in order to output high bit rate audio such as Dolby Digital Plus or Dolby TrueHD.

▷ **PCM:**

Select "PCM" when the connected equipment cannot decode the respective audio format.

Refer to the operating instructions for connected devices to verify whether or not they can decode each of the audio formats.

BD-Video Secondary Audio

BD-V

Turn on/off the button click sound on the menu and audio with secondary video in picture-in-picture mode. (⇒ 17)

▷ **On:**

The primary audio and secondary audio are mixed and output. The sampling frequency is converted to 48 kHz.

▷ **Off:**

The button click sound on the menu and secondary audio are not output.

Downmix

Switch the downmix system for playing back multi-channel surround sound.

- When "Dolby D/Dolby D +/Dolby TrueHD" or "DTS" is set to "Bitstream", there are no downmix effects for the outputted audio.
- The audio will be output in "Stereo" in the following cases:
 - AVCHD playback
 - Playback of secondary audio (including the button click sound)
- ▷ Stereo:
When connected to equipment that does not support the virtual surround function.
- ▷ Surround encoded:
When connected to equipment that supports the virtual surround function (to convert 2-channel to multi channel surround).

Display

Status Messages

Choose whether to show status messages automatically.

- ▷ Automatic
- ▷ Off

On-screen Language

Choose the language for these menus and on-screen messages.

- ▷ English
- ▷ Français
- ▷ Español

Screen Saver Function

- ▷ On:
 - If there is no operation for 10 minutes or more, DIRECT NAVIGATOR screen switches to FUNCTION screen automatically.
 - While playing and pausing, etc., this function is not available.
 - As for Music (CD-DA, MP3), regardless of the setting, if there is no operation for 2 minutes, DIRECT NAVIGATOR screen switches to the other states automatically.
 - When playing the 4:3 image, the masked-off area on the screen become black.
[Only when connecting with an HDMI cable, "TV Aspect" (⇒ right) is set to "16:9" and "HDMI Resolution" (⇒ right) is set to any mode other than "480p".]
- ▷ Off

License

Information about the software used by this unit is displayed.

TV Aspect / HDMI Function Settings

TV Aspect

"TV Aspect" operates on the screen of the unit or the connected TV.

To view an image connected to a 4:3 TV:

- ▷ 4:3 Pan & Scan:
Video recorded for a widescreen is played as Pan & Scan (unless prohibited by the producer of the disc). When playing BD-Video, video is output as "4:3 Letterbox".
- ▷ 4:3 Letterbox:
Video recorded for a widescreen is played in the letterbox style.

To view an image on the unit or connected to a 16:9 widescreen TV:

- ▷ 16:9:
Video recorded for 4:3 aspect screen is displayed as a 4:3 ratio image in the center of the screen.
- ▷ 16:9 Full:
Video recorded for 4:3 aspect screen is displayed as a horizontally stretched 16:9 image.

HDMI Connection

Press [OK] to show the following settings.

HDMI Resolution*

The items supported by the connected devices are indicated on the screen as "*". When any item without "*" is selected, the images may be distorted.

* In this unit, a P4HD (⇒ 41) video processor is used to provide video of optimal resolution to the connected TV.

- If the image is distorted, set to "480p" or set again correctly.
- ▷ Auto:
Automatically selects the output resolution best suited to the connected television (1080p, 1080i or 480p).
- ▷ 480p
- ▷ 720p
- ▷ 1080i
- ▷ 1080p
- To enjoy high definition video up-converted to 1080p, you need to connect the unit directly to 1080p compatible HDTV (High Definition Television). If this unit is connected to an HDTV through other equipment, it must also be 1080p compatible.

24p Output

BD-V **DVD-V**

When this unit is connected to a TV supporting 1080/24p output using an HDMI cable, movies and other material recorded at 24p are output at 24p.

- When playing DVD-Video, set to "On" and then also set "24p" in "Video" (⇒ 25) to "On".
(Nothing will be displayed on the screen of this unit.)
- When BD-Video images other than 24p are played, images are output at 60p.
- ▷ On
- ▷ Off

HDMI RGB Output Range

Effective when connected to a device that only supports RGB output.

- ▷ Standard:
The video is output as it is.
- ▷ Enhanced:
When the black and white contrast of a video is low, the signal is enhanced to reproduce clear video.

HDMI Audio Output

Set whether or not to output audio from the HDMI AV OUT terminal.

- ▷ On ▷ Off

VIERA Link

Set to use "HDAVI Control" function when connected with an HDMI cable to a device that supports "HDAVI Control".

- ▷ On
- ▷ Off:
Select when you do not want to use "HDAVI Control".

Contents Type Flag

Depending on the playback content, the TV will output adjusting to the optimal method when a TV that supports this function is connected.

- ▷ Auto ▷ Off

Others

Quick Start

Speed of startup from power off is increased.

- Quick Start only functions when the AC adaptor is connected.
- ▷ On:
Since internal control unit will be powered, power consumption in standby mode (⇒ 38) will increase in comparison to when "Off".
- ▷ Off

Energy Saving Settings

Press [OK] to show the following settings.

Automatic Standby (No Action)

Select whether the unit is automatically turned off when about 15 minutes (about 5 minutes when using the battery pack) have elapsed while stopped.

- ▷ On
- ▷ Off:
Select when you do not want to use this function.

ECO-charge

Charging of the battery pack will be controlled to 80 % when set to "On", and therefore prevent exhaustion of the battery pack.

- ▷ On
- ▷ Off

Easy Setting

You can execute basic settings ("On-screen Language" and "Quick Start").

- ▷ Yes ▷ No

Restore Default Settings

This returns all values in the Setup menu and the on-screen menu, except for "On-screen Language", "DVD-Video Ratings" and "BD-Video Ratings" to the default settings.

- ▷ Yes ▷ No

System Information

Display firmware version of this unit.

Language code list

Enter the code with the numbered buttons.

Abkhazian: 6566	Catalan: 6765	Gujarati: 7185	Lingala: 7678	Rhaeto-Romance: 8465	Tamil: 8465
Afar: 6565	Chinese: 9072	Hausa: 7265	Lithuanian: 7684	Tatar: 8484	Tatar: 8484
Afrikaans: 6570	Corsican: 6779	Hebrew: 7387	Macedonian: 7775	Telugu: 8469	Telugu: 8469
Albanian: 8381	Croatian: 7282	Hindi: 7273	Malagasy: 7771	Russian: 8285	Thai: 8472
Amharic: 6577	Czech: 6783	Hungarian: 7285	Malay: 7783	Samoan: 8377	Tibetan: 6679
Arabic: 6582	Danish: 6865	Icelandic: 7383	Malayalam: 7776	Sanskrit: 8365	Tigrinya: 8473
Armenian: 7289	Dutch: 7876	Indonesian: 7378	Maltese: 7784	Scots Gaelic: 7168	Tonga: 8479
Assamese: 6583	English: 6978	Interlingua: 7365	Maori: 7773	Serbian: 8382	Turkish: 8482
Aymara: 6589	Esperanto: 6979	Irish: 7165	Marathi: 7782	Serbo-Croatian: 8372	Turkmen: 8475
Azerbaijani: 6590	Estonian: 6984	Italian: 7384	Moldavian: 7779	Shona: 8378	Twi: 8487
Bashkir: 6665	Faroese: 7079	Japanese: 7465	Mongolian: 7778	Sindhi: 8368	Ukrainian: 8575
Basque: 6985	Fiji: 7074	Javanese: 7487	Nauru: 7865	Singhalese: 8373	Urdu: 8582
Bengali; Bangla: 6678	Finnish: 7073	Kannada: 7578	Nepali: 7869	Slovak: 8375	Uzbek: 8590
Bhutanian: 6890	French: 7082	Kashmiri: 7583	Norwegian: 7879	Slovenian: 8376	Vietnamese: 8673
Bihari: 6672	Frisian: 7089	Kazakh: 7575	Oriya: 7982	Somali: 8379	Volapük: 8679
Breton: 6682	Galician: 7176	Kirghiz: 7589	Pashto, Pushto: 8083	Spanish: 6983	Welsh: 6789
Bulgarian: 6671	Georgian: 7565	Korean: 7579	Persian: 7065	Sundanese: 8385	Wolof: 8779
Burmese: 7789	German: 6869	Kurdish: 7585	Polish: 8076	Swahili: 8387	Xhosa: 8872
Byelorussian: 6669	Greek: 6976	Laotian: 7679	Portuguese: 8084	Swedish: 8386	Yiddish: 7473
Cambodian: 7577	Greenlandic: 7576	Latin: 7665	Punjabi: 8065	Tagalog: 8476	Yoruba: 8979
	Guarani: 7178	Latvian, Lettish: 7686	Quechua: 8185	Tajik: 8471	Zulu: 9085

Enjoying High Bit rate Audio

About audio output

The audio output differs depending on the settings on the unit. (⇒ 27, "Digital Audio Output")

- The number of channels listed is the maximum possible number of output channels.

"Dolby D/Dolby D +/Dolby TrueHD"/ "DTS"	"Bitstream" ¹		"PCM"	
	"On" ²	"Off"	"On"	"Off"
"BD-Video Secondary Audio"	Dolby Digital	Outputs using original audio	Down-mixed 2ch PCM	
Dolby Digital/ Dolby Digital EX				
Dolby Digital Plus/ Dolby TrueHD				
DTS Digital Surround/ DTS-ES	DTS Digital Surround	DTS Digital Surround DTS-ES		
DTS-HD High Resolution Audio/ DTS-HD Master Audio				
7.1ch LPCM	7.1ch PCM ³			

¹ When the connected equipment is not supported with these audio formats, the audio is output as Dolby Digital bitstream, DTS Digital Surround bitstream or down-mixed 2ch PCM (e.g., TV).

² When playing BD-Video without secondary audio or button click sound, the audio is output as the same format as if "BD-Video Secondary Audio" was set to "Off".

³ **BD-V** When secondary audio or button click sound is included and the setting of the "BD-Video Secondary Audio" is set to "On", audio is output as 5.1 ch.

Enjoying High Bit rate Audio of BD-Video

BD-V

This unit supports high bit rate audio (Dolby Digital Plus and Dolby TrueHD) adopted in BD-Video.

In order to enjoy these audio formats, the following conditions are necessary.

NECESSARY CONNECTIONS

- HDMI AV OUT terminal: (⇒ 21)

NECESSARY SETTINGS

- Set "BD-Video Secondary Audio" to "Off". (⇒ 27)
- Set "HDMI Audio Output" to "On". (⇒ 29)
- Set "Dolby D/Dolby D +/Dolby TrueHD" to "Bitstream". (⇒ 27)

- The button click sound on the menu and audio with secondary video in picture-in-picture mode (⇒ 17) is not output.

About MP3/JPEG/MKV/ AVCHD/MPEG2 files

MP3

File format	MP3
Extension	Files must have the extension “.mp3” or “.MP3”.
Compression rate	32 kbps to 320 kbps
Sampling rate	44.1 kHz/48 kHz
Reference	ID3 tags: version 1, 2.2, 2.3, 2.4 (Only titles and the names of artists)

JPEG

File format	JPEG
Extension	Files must have the extension “.jpg” or “.JPG”.
Picture resolution	between 34×34 and 8192×8192 pixels (sub sampling is 4:2:2 or 4:2:0)
Reference	JPEG conforming DCF* is supported. Thawing Time: approx. 2 sec (7M pixels.) <ul style="list-style-type: none">● MOTION JPEG and Progressive JPEG is not supported.

* Design rule for Camera File system: unified standard established by Japan Electronics and Information Technology Industries Association (JEITA).

- DVD-RAM must conform to UDF 2.0.
- BD-RE must conform to UDF 2.5.

MKV

File format	MKV
Extension	Files must have the extension “.MKV” or “.mkv”.
Picture resolution	Up to 1920×1080 pixels
Reference	Video <ul style="list-style-type: none">– Number of streams: Up to 1– Codec: MPEG-4 AVC/H.264– FPS (Frame Per Second):<ul style="list-style-type: none">From 320×240 to 1920×1080: 30 fpsSpecifically at 1280×720: 60 fps Audio <ul style="list-style-type: none">– Number of streams: Up to 8– Format: MP3, MPEG, Dolby Digital, DTS, PCM– Multi channel:<ul style="list-style-type: none">Dolby Digital is possible.MPEG multi is 2 ch conversion.

- DVD-R and DVD-R DL must conform to UDF 1.02 without ISO9660 and UDF 1.5 with ISO9660.
- BD-R must conform to UDF 2.5.
- Some MKV file may not be played back, depending on the video resolution and frame rate condition.

Subtitles text file of MKV

File format	Subtitles text file of MKV MicroDVD, SubRip, or TMLayer
Extension	Files must have the extension “.SRT”, “.srt”, “.SSA”, “.ssa”, “.ASS”, or “.ass”
Reference	<ul style="list-style-type: none">● The video file and subtitles text file are inside the same folder, and the file names are the same except for the file extensions.● Depending on the methods used to create the file or the state of the recording, only parts of the subtitles may be displayed, or the subtitles may not be displayed at all.

AVCHD

File format	AVCHD format (V1.0) used on High Definition Video Camera (Panasonic and some others)
Codec	MPEG-4 AVC/H.264
	<ul style="list-style-type: none">● Discs must conform to UDF 2.5.

MPEG2

File format	SD-Video format* used on Standard Definition Video Camera (Panasonic and some others)
Codec	MPEG2

* SD-Video Entertainment Video Profile

- With certain recording states and folder structures, the play order may differ or playback may not be possible.
- CD-R, CD-RW : ISO9660 level 1 or 2 (except for extended formats), Joliet
This unit is compatible with multi-session.
This unit is not compatible with packet writing.
- DVD-R, DVD-R DL (except for AVCHD) : ISO9660 level 1 or 2 (except for extended formats), Joliet, UDF bridge (UDF 1.02/ISO9660)
This unit is not compatible with multi-session.
This unit is not compatible with packet writing.

Structure of folders that can be played in this unit

You can play files on this unit by structure of folders as shown below. However depending on the method of writing data (writing software), play may not be in the order you numbered the folders.

 : Folder which can be displayed with this unit

* ** * : Numbers

XXX: Letters

¹ * ** * : from 001 to 999

² * ** * : from 100 to 999

XXXXX: 5 figures

³ * ** * * : from 0001 to 9999

XXXX: 4 figures

Structure of MP3 folders

in DVD-R/DVD-R DL/CD-R/CD-RW

Prefix the file names with 3-digit numbers in the order you want to play them.

e.g.,

Root

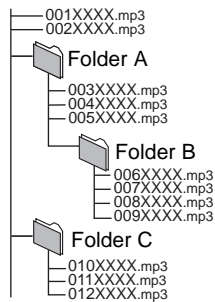

Structure of MKV folders

in BD-R/DVD-R/DVD-R DL/CD-R/CD-RW

Files inside a folder are displayed in the order they were updated or taken.

e.g.,

Root

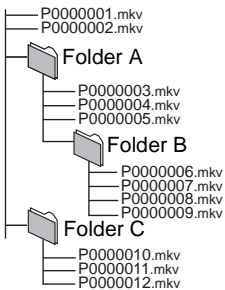

Structures of still picture (JPEG) folders

in DVD-R/DVD-R DL/CD-R/CD-RW

Files inside a folder are displayed in the order they were updated or taken.

e.g.,

Root

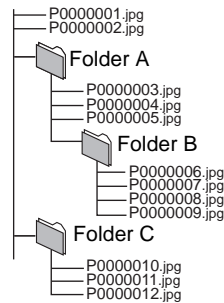

in BD-RE/DVD-RAM

● Folder structure is not displayed.

e.g.,

Root

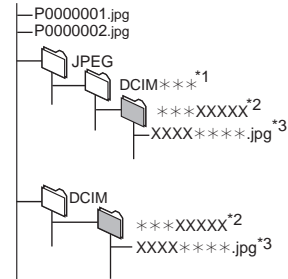

in SD card

Displays JPEG files in all folders.

● Folder structure is not displayed.

e.g.,

Root

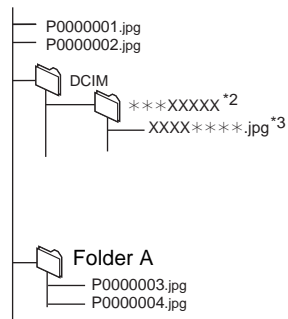

Indicators and screen messages

Indicators

The indicator flashes rapidly.

- The unit has malfunctioned. Consult your dealer.

The indicator flashes slowly.

- “Monitor” on LCD Menu is “Off” (no image).
Turn the unit off if you do not continue playing.

The indicator and the [CHARGE] indicator flash rapidly.

- Update of the firmware did not complete successfully.
Perform the update again. (⇒ 5)

The [CHARGE] indicator flashes rapidly.

- There is a problem with the battery pack. Turn the unit on and check the message on the LCD. (⇒ below)

The [CHARGE] indicator flashes slowly.

- Battery pack charge is low. The unit will turn off automatically after a few minutes.

Screen messages

Cannot read. Please check the disc.

- Clean the disc. (⇒ 5)
- You inserted a disc that has not been finalized. (⇒ 6)

ERROR U580

- A problem has occurred with the battery pack. Consult your dealer.

ERROR U581

- The battery pack has been recharging but has failed to recharge for some reason. Recharge again.

ERROR U582

- You are recharging in a location that is too hot or too cold.
Recharge at normal temperature [+5 to +35 °C (+41 to +95 °F)].

ERROR U583

- The battery pack is not compatible with this unit. Use a battery pack that is compatible with this unit. (⇒ 11)

F □□

H □□

(□□ stands for a number.)

- A problem has occurred. (Numbers following the “F” or the “H” will be different depending on the status of the unit) Turn off the unit once, and turn it back on. Alternatively, turn off the unit, disconnect the AC adaptor and the battery pack, and attach them back again.

Cannot play.

- You inserted an incompatible disc (Discs recorded in PAL video, etc.). (⇒ 6)

Cannot display on this unit.

- You tried to play a non-compatible image. (⇒ 31)
- Re-insert the SD card.

No disc is inserted.

- The disc may be upside down.

This operation is not available.

- Some operations are unsupported by the unit. For example;
 - **BD-V**: During playback, reverse slow-motion or reverse frame-by-frame is not possible.

This operation is prohibited by this disc.

- Depending on the disc, you may not be able to perform search or skip when film previews and warning screens are being played back.

Troubleshooting guide

Before requesting service, please perform the following steps.

Do you have the latest firmware installed?

Firmware updates may be released to correct operating irregularities that are discovered with certain movies. (⇒ 5)



Make the following checks and visit our website for more information.

For USA :

www.panasonic.com/help

Enter the model number.

For Canada :

<http://www.panasonic.ca>



Or visit our website to find a service center.

You can find a service center near you easily on our website.

Other support information:

"Customer Services Directory (United States and Puerto Rico)" (⇒ 42) or "Limited Warranty (ONLY FOR CANADA)" (⇒ 43).

The following do not indicate malfunction.

- Sound from the AC adaptor during recharging.
- The battery pack warming up when recharging or during use.
- The surface and area around the unit becoming warm when used for long periods.
Move the unit after waiting for 3 minutes after unplugging the AC adaptor when it needs to be moved or maintained.
- Operating noises when the unit is turned on.

Safety devices may be operating when the unit does not respond to operations.

- ① Press [POWER ⏻/⏻] on the unit to turn it off.
If the unit is not turned off, hold down for approximately 3 seconds to force the power off.
- ② Press [POWER ⏻/⏻] on the unit to turn it on.
If operation is still not possible after performing the above operations, consult the dealer where the unit was purchased.

To reset this unit

To return all settings other than some settings to the factory preset.

- Select "Yes" in "Restore Default Settings" in the Setup menu.
This returns all values in the Setup menu and the on-screen menu, except for "On-screen Language", "DVD-Video Ratings" and "BD-Video Ratings" to the default settings.
(⇒ 29)

To return all settings to the factory preset

- Only when connecting the AC adaptor, reset the unit as follows:
 - ① Press [POWER ⏻/⏻] on the unit to turn off the unit.
 - ② Press and hold [POWER ⏻/⏻] and [↩ RETURN] on the unit at the same time for more than 5 seconds.
 - ③ The unit will turn on and then turn off.

Power

No power.

- Check connections to the AC adaptor or battery pack. (⇒ 10)
- The unit has protection circuitry that is activated if it becomes too hot or too cold. The unit will not work if this occurs. Use the unit between 5 °C (41 °F) and 35 °C (95 °F).
- Hold down [POWER ⏻/⏻] for some time.
- The unit may not come on immediately after it is turned off.
Once the "BYE" display disappears, press [POWER ⏻/⏻] and turn the unit on.
- The unit can be turned on only when the unit's screen is open. (⇒ 10)

Unit turns off automatically.

- Check connections to the AC adaptor or battery pack. (⇒ 10)
- The unit turns off after it has been stopped for about 15 minutes (about 5 minutes when the unit is powered by the battery pack) to conserve power (only when "Automatic Standby (No Action)" in the Setup menu is set to "On").
(⇒ 29) Turn the unit on again.
- Press [OFF TIMER] and the unit will be turned off automatically. (⇒ 12)
- Safety devices may be operating. Press [POWER ⏻/⏻] and turn the unit on.
- When using VIERA Link (HDMI), the unit will be automatically turned off if the TV is turned off. If VIERA Link (HDMI) is not being used, set "VIERA Link" settings to "Off".
(⇒ 29)
- If the screen is closed when the unit is turned on, the display on the screen will disappear and the unit will be automatically turned off. (⇒ 10)
- The power may turn off without the remaining battery charge display flashing when the media is played back with the battery pack low on charge. Playback after charging the battery pack. (⇒ 11)

Cannot charge or the [CHARGE] indicator fails to light.

- The charging time increases when the temperature is too hot or too cold, and charging may not be possible under some circumstances.
- Check connections to the AC adaptor or battery pack. (⇒ 10)
- The battery pack is not compatible with this unit. Use a battery pack that is compatible with this unit. (⇒ 11)

Play time dramatically reduced after recharging.

- The battery pack has reached the end of its service life.
[It can be recharged about 500 times (When "ECO-charge" is set to "On") or 300 times (When "ECO-charge" is set to "Off").]

Operation

The unit is on but cannot be operated.

- The unit can be operated only when the LCD screen is open. (⇒ 10)
- Is the incorrect playback media or operation function selected?
- The unit may not be operating properly due to lightning, static electricity or some other external factor. Turn the unit off and then back to on. Alternatively, turn the unit off, disconnect the power source (AC or battery pack), and then reconnect it.
- Condensation has formed. Wait 1 to 2 hours for it to evaporate.

Play fails to start even when [▶] (PLAY) is pressed. Play starts but then stops immediately.

- Insert the media correctly with the label facing up. (⇒ 13)
- The media is dirty. (⇒ 5)
- You tried to play a blank media or unplayable media on this unit. (⇒ 6)

No response when remote control buttons pressed.

- The unit can be operated only when the LCD screen is open. (⇒ 10)
- Check that the battery is installed correctly. (⇒ 9)
- The battery is depleted: Replace it with new one. (⇒ 9)
- Point the remote control at the remote control sensor and operate. (⇒ 9)

Start up is slow.

It takes time before play starts.

- Make sure that "Quick Start" is set to "On". (⇒ 29)
- Start up takes time in the following situations.
 - Immediately after a power failure or the AC adaptor is connected.
 - When the unit is connected with an HDMI cable.

Played back image is distorted or does not play back correctly. (AVCHD)

- High definition video (transfer rate of 18 Mbps or faster) cannot be played back correctly if it was recorded on a DVD compatible to double speed or slower.

Cannot set "On" in "24p Output".

- Only when this unit is connected to a TV supporting 24p output via an HDMI cable, you can set to "On". (⇒ 28)

LCD

No picture on the LCD.

- Check connections. (⇒ 10)
- Select "On" in "Monitor". (⇒ 13)
- Nothing is displayed on the LCD when "24p" of playback setting is set to "On". (⇒ 25)
- **MKV**: Images may not be output due to how files were created. (⇒ 31)

The LCD is dark.

- Select the appropriate picture quality mode. (⇒ 13)

LCD pixels turn black or radiate different colors.

- The LCD is constructed with precision technology so 99.99 % of the pixels are active, but of the remaining of 0.01 %, there are pixels that may be black or emit light constantly. This phenomenon is not a malfunction.

Picture is distorted.

- The quality of video will lower on the screen of this unit when HDMI is connected. (⇒ 21)

There is a lot of after-image when playing video.

- Turn "3D NR" or "Integrated NR" off if it is on. (⇒ 25)

A black band is displayed around the edge of the screen.

The aspect ratio of the screen is abnormal.

- Confirm the "TV Aspect" is set properly. (⇒ 28)

Still pictures (JPEG) do not play back normally.

- The images that were edited on the PC, such as Progressive JPEG, etc., may not play back. (⇒ 31)

Sound

No sound from the unit's speaker.

- The speaker is off if headphones are connected.
- Turn up the volume. (⇒ 14)

Cannot hear the desired audio type.

- Press [AUDIO] to select the audio. (⇒ 16)
- **MKV**: Audio may not be output depending on how files were created. (⇒ 31)

Cannot switch audio.

- There are discs for which audio cannot be changed because of how the disc was created.

Connection

The images from this unit do not appear on the television.

Picture is distorted.

- Make sure that the television is connected to HDMI AV OUT terminal on this unit. (⇒ 21)
- Make sure that the television's input setting (e.g., VIDEO 1) is correct.
- When "24p Output" is set to "On", HDMI authentication takes place where 24p images switch to other images, and a black screen is displayed. (⇒ 28)
- When "24p Output" is set to "On", jittering may occur while playing DVD-Video other than 24p images. In this case, turn "24p Output" to "Off". (⇒ 28)
- An incorrect resolution is selected in "HDMI Resolution", when the television is connected to HDMI AV OUT terminal. Set the item again.
- Picture may not be seen when more than 4 devices are connected with HDMI cables. Reduce the number of connected devices.

Video is not output in high definition.

- Confirm that the "HDMI Resolution" in the Setup menu is set properly. (⇒ 28)

The 4:3 aspect ratio picture expands left and right. Screen size is wrong.

- Use the television to change the aspect. Refer to your television's operating instructions.
- When using an HDMI cable, change "TV Aspect" type to "4:3 Pan & Scan". (⇒ 28)

No sound from other speakers.

- Check all connections and settings. (⇒ 21)

Cannot hear the desired audio type.

- Audio may not be heard when more than 4 devices are connected with HDMI cables. Reduce the number of connected devices.

Cannot switch audio.

- When connecting an amplifier/receiver using an HDMI cable, you cannot switch the audio if "Dolby D/Dolby D +/Dolby TrueHD" or "DTS" is set to "Bitstream". Set "Dolby D/Dolby D +/Dolby TrueHD" or "DTS" to "PCM". (⇒ 27)

Card

Music on an SD card cannot be played.

- Data that can be played from an SD card are AVCHD, MPEG2 and JPEG data. (⇒ 7)

The contents of the card cannot be read.

- The card is not compatible or the contents on the card may be damaged. (⇒ 7)
- Turn off and then turn on the unit again.

Other difficulties with playback

Audio and video momentarily pause.

- This occurs between playlist chapters or scenes (**AVCHD**).
- When playing a title recorded on both layers, the unit automatically switches between layers and plays the title in the same way as a normal program. However, video and audio may momentarily cut out when the unit is switching layers.

BD-Video or DVD-Video is not played.

- Ensure the disc is for the correct BD-Video region code or DVD-Video region number, and is not defective. (⇒ 7)
- You have set a ratings level to limit BD-Video or DVD-Video play. Change this setting. (⇒ 26)
- Some BD-Video can only be output with HDMI.

Picture-in-picture is not played with BD-Video.

- Confirm whether the disc supports picture-in-picture.

Alternative soundtrack and subtitles cannot be selected.

- The languages are not recorded on the media.
- You may not be able to use the on-screen menu to change the soundtrack and subtitles on some discs. Use the disc's menus to make changes. (⇒ 14)

No subtitles.

- Subtitles are not recorded on the media.
- Turn the subtitles on. Set "Subtitle" on the on-screen menu to "On". (⇒ 24)

Angle cannot be changed.

- Angles can only be changed during scenes where different angles are recorded.

The resume play function does not work.

- The memorized position is cleared in the following instances:
 - [■] is pressed several times.
 - The disc or SD card is removed.
 - The unit is turned off due to such occurrences as power outage, the removal of the AC adaptor or waste of the battery pack's remaining power when the unit is turned on.
- The resume play function may not work depending on the media.
- **BD-V**: On BD-Video discs including BD-J, the resume play function does not work.

You have forgotten your ratings password.

- While the media is removed, press and hold [I◀◀] and [SUB MENU S] on the unit at the same time for more than 5 seconds. "DVD-Video Ratings" and "BD-Video Ratings" will return to the default settings.

The VIERA Link does not work.

- Is the LCD screen open? (⇒ 10)
 - The unit cannot be operated with the TV remote control in any other condition.
- When using the unit with only the battery pack, operate after turning the unit on. (⇒ 12)

When a recorder or player etc. is operated with a remote control, the unit is also simultaneously operated.

When the unit's remote control is operated, other Panasonic recorders or players etc. are also simultaneously operated.

- Change the remote control codes on the Panasonic recorders or players.

Specifications

Power supply: DC 12 V (DC IN terminal)/
DC 7.2 V (Exclusive battery terminal)

Power consumption (using supplied AC adaptor):

Play Mode: Approx. 15 W (Unit only Approx. 12 W)

Recharge mode (Quick Start "Off"): Approx. 18 W

Recharge mode (Quick Start "On"): Approx. 22 W

Standby mode (Quick Start "Off"):

For U.S.A. Approx. 0.3 W

For Canada Approx. 0.4 W

Standby mode (Quick Start "On"):

For U.S.A. Approx. 4 W

For Canada Approx. 4.5 W

AC adaptor:

Power source: AC 110 to 240 V, 50/60 Hz

Power consumption: 36 W

DC output: 12 V, 2000 mA

Car DC Adaptor:

DC output: 12 V, 2 A (Vehicle with 12 V battery only)

Battery pack (lithium ion): DY-DB20 (supplied)

Voltage: 7.2 V

Capacity (Minimum): 4200 mAh

Dimensions (W×D×H)

(excluding protrusions and battery):

238 mm (W)×188.3 mm (D)×52.7 mm (H)

(9 ³/₈"×7 ¹³/₃₂"×2 ¹/₁₆")

Mass:

(including battery) Approx. 1376 g (48.52 oz)

(without battery) Approx. 1143 g (40.30 oz)

Operating temperature range: +5 to +35 °C (+41 to +95 °F)

Operating humidity range: 10 to 80 % RH (no condensation)

LCD screen:

8.9" α-Si, TFT wide-screen LCD (1024×600×RGB)

HDMI AUDIO/VIDEO output:

Number of terminals: 1 system

Speaker:

Output: 0.5 W + 0.5 W (8 Ω)

Headphone output:

Output: φ 3.5 mm (1/8") stereo mini jack

Number of terminals: 1 system

Pickup:

Wave length: 405 nm/660 nm/780 nm (BD/DVD/CD)

Laser power:

For U.S.A.

CLASS II/CLASS II/CLASS I (BD/DVD/CD)

For Canada

CLASS 1M/CLASS 1M/CLASS 1M (BD/DVD/CD)

Playable disc:

BD-Video

BD-ROM: Version 2

BD-RE: Version 3 (Single Layer, Dual Layer),
JPEG

BD-R: Version 2 (Single Layer, Dual Layer),
MKV^{5, *6, *7}

DVD-RAM: DVD Video Recording format³,
AVCHD format, JPEG

DVD-R/DVD-R DL: DVD-Video format¹, DVD-Video
Recording format^{1, *3}, AVCHD format¹,
JPEG², MP3², MKV^{2, *4, *6, *7}

DVD-RW: DVD-Video format¹, DVD-Video
Recording format^{1, *3}, AVCHD format¹

+R/+RW/+R DL: Video¹, AVCHD format¹

DVD-Video: DVD-Video format

CD-Audio: CD-DA

CD-R/CD-RW: CD-DA, JPEG², MP3², MKV^{2, *6, *7}

SD card:

SD Memory Card⁸ formatted FAT12, FAT16, FAT32⁹, exFAT¹⁰;
JPEG, AVCHD format, MPEG-2

JPEG¹¹:

Pixels: 34 × 34 to 8192 × 8192

Sub Sampling: 4:2:2, 4:2:0

Maximum numbers of folders

● BD-RE, DVD-RAM, DVD-R, DVD-R DL,
SD card, CD-R, CD-RW: 500

Maximum numbers of files

● BD-RE, DVD-RAM, DVD-R, DVD-R DL,
SD card, CD-R, CD-RW: 10000

MP3:

Compression rate: 32 kbps to 320 kbps

Sampling rate: 44.1 kHz, 48 kHz

AVCHD (H.264):

File format: AVCHD format V1.0

HDMI:

480p (525p) / 1080i (1125i) / 720p (750p) /1080p (1125p)

This unit supports "HDAVI Control 5" function.

Specifications are subject to change without notice.

¹ Finalizing is necessary.

² ISO9660 level 1 or 2 (except for extended formats), Joliet

This unit is compatible with multi-session.

This unit is not compatible with packet writing.

³ CPRM discs are not supported.

⁴ UDF1.02 without ISO9660, UDF1.5 with ISO9660

⁵ UDF2.5

⁶ Maximum number of folders recognizable: 300 folders. (including the root folder)

Maximum number of files recognizable: 200 files.

⁷ MPEG-4 AVC(H.264) profile is up to High Profile, Level 4.

AAC-LC, MP3 and Dolby Digital audio can be decoded.

⁸ includes SDHC, SDXC card

includes miniSD Card (need a miniSD Adaptor.)

includes microSD/microSDHC/microSDXC Card (need a microSD Adaptor.)

⁹ Not support long file name

¹⁰ SDXC only

¹¹ Motion JPEG not supported

- Useable capacity will be less. (SD Card)

Licenses

Java and all Java-based trademarks and logos are trademarks or registered trademarks of Sun Microsystems, Inc. in the United States and other countries.
Manufactured under license from Dolby Laboratories. Dolby and the double-D symbol are trademarks of Dolby Laboratories.
Manufactured under license under U.S. Patent #'s: 5,451,942; 5,956,674; 5,974,380; 5,978,762; 6,487,535 & other U.S. and worldwide patents issued & pending. DTS and the Symbol are registered trademarks, & DTS 2.0+ Digital Out and the DTS logos are trademarks of DTS, Inc. Product includes software. © DTS, Inc. All Rights Reserved.
This item incorporates copy protection technology that is protected by U.S. patents and other intellectual property rights of Rovi Corporation. Reverse engineering and disassembly are prohibited.
HDMI, the HDMI Logo, and High-Definition Multimedia Interface are trademarks or registered trademarks of HDMI Licensing LLC in the United States and other countries.
This product is licensed under the AVC patent portfolio license and VC-1 patent portfolio license for the personal and non-commercial use of a consumer to (i) encode video in compliance with the AVC Standard and VC-1 Standard ("AVC/VC-1 Video") and/or (ii) decode AVC/VC-1 Video that was encoded by a consumer engaged in a personal and non-commercial activity and/or was obtained from a video provider licensed to provide AVC/VC-1 Video. No license is granted or shall be implied for any other use. Additional information may be obtained from MPEG LA, LLC. See http://www.mpegla.com .
HDAVI Control™ is a trademark of Panasonic Corporation.
VIERA Link™ is a trademark of Panasonic Corporation.
EZ Sync™ is a trademark of Panasonic Corporation.
MPEG Layer-3 audio coding technology licensed from Fraunhofer IIS and Thomson.
"AVCHD" and the "AVCHD" logo are trademarks of Panasonic Corporation and Sony Corporation.
SDXC Logo is a trademark of SD-3C, LLC.
"DVD Logo" is a trademark of DVD Format/Logo Licensing Corporation.

<p>This product incorporates the following software:</p> <ol style="list-style-type: none"> (1) the software developed independently by or for Panasonic Corporation, (2) the software owned by third party and licensed to Panasonic Corporation, (3) the software licensed under the GNU General Public License, Version 2 (GPL v2), (4) the software licensed under the GNU LESSER General Public License, Version 2.1 (LGPL v2.1) and/or, (5) open sourced software other than the software licensed under the GPL v2 and/or LGPL v2.1 <p>For the software categorized as (3) and (4), please refer to the terms and conditions of GPL v2 and LGPL v2.1, as the case may be at http://www.gnu.org/licenses/old-licenses/gpl-2.0.html and http://www.gnu.org/licenses/old-licenses/lgpl-2.1.html. In addition, the software categorized as (3) and (4) are copyrighted by several individuals. Please refer to the copyright notice of those individuals at http://www.am-linux.jp/dl/AWBPP11</p> <p>The GPL/LGPL software is distributed in the hope that it will be useful, but WITHOUT ANY WARRANTY, without even the implied warranty of MERCHANTABILITY or FITNESS FOR A PARTICULAR PURPOSE.</p> <p>At least three (3) years from delivery of products, Panasonic will give to any third party who contacts us at the contact information provided below, for a charge no more than our cost of physically performing source code distribution, a complete machine-readable copy of the corresponding source code covered under GPL v2/LGPL v2.1.</p> <p>Contact Information cdrequest@am-linux.jp</p> <p>Source code is also freely available to you and any other member of the public via our website below. http://www.am-linux.jp/dl/AWBPP11</p> <p>For the software categorized as (5) includes as follows.</p> <ol style="list-style-type: none"> 1 This product includes software developed by the OpenSSL Project for use in the OpenSSL Toolkit. (http://www.openssl.org/) 2 This product includes software developed by the University of California, Berkeley and its contributors. 3 FreeType code. 4 The Independent JPEG Group's JPEG software.

Glossary

AVCHD

AVCHD is a new format (standard) for high definition video cameras that can be used to record and play high-resolution HD images.

BD-J

Some BD-Video discs contain Java applications, and these applications are called BD-J. You can enjoy various interactive features in addition to playing normal video.

Bitstream

This is the digital form of multi-channel audio data (e.g., 5.1 channel) before it is decoded into its various channels.

Dolby Digital

This is a method of coding digital signals developed by Dolby Laboratories. Apart from stereo (2-channel) audio, these signals can also be multi-channel audio.

Dolby Digital Plus

Multi-channel audio and higher audio quality is made possible using Dolby Digital Plus. BD-Video supports up to 7.1 channel output.

Dolby TrueHD

Dolby TrueHD is a very high quality audio format that reproduces the studio master audio. BD-Video supports up to 7.1 channel output.

Down-mixing

This is the process of remixing the multi-channel audio found on some discs into fewer channels.

DTS (Digital Theater Systems)

This surround system is used in many movie theaters. There is good separation between the channels, so realistic sound effects are possible.

DTS-HD

DTS-HD is a high-quality, sophisticated audio format used in movie theaters. Previous DTS Digital Surround-compatible equipment can play DTS-HD as DTS Digital Surround audio. BD-Video supports up to 7.1 channel output.

- Original audio cannot be output from this unit.

DTS-HD High Resolution Audio

This is a signal format achieved by improving the previous DTS, DTS-ES and DTS 96/24 formats. It is compatible with sampling frequency 96 kHz/48 kHz. BD-Video supports up to 7.1 channel output.

- Original audio cannot be output from this unit.

DTS-HD Master Audio

This is a lossless audio format and compatible with 96 kHz/7.1ch or less. In addition, faithful reproduction of the master audio is enabled using lossless audio encoding technology. BD-Video supports up to 7.1 channel output.

- Original audio cannot be output from this unit.

Dynamic range

Dynamic range is the difference between the lowest level of sound that can be heard above the noise of the equipment and the highest level of sound before distortion occurs.

Dynamic range compression means reducing the gap between the loudest and softest sounds. This means you can listen at low volumes but still hear dialog clearly.

Film and video

DVD-Video are recorded using either film or video. This unit can determine which type has been used, then uses the most suitable method of progressive output.

Film: Recorded at 24 frames per second. (Recorded at 30 frames per second as well). Generally appropriate for motion picture films.

Video: Recorded at 30 frames/60 fields per second. Generally appropriate for TV drama programs or animation.

Folder

This is a place on the disc or SD card where groups of data are stored together. Additional folders can be created within folders, and you can make detailed classifications depending on the folder structure. (⇒ 32)

Frames and fields

Frames refer to the single images that constitute the video you see on your television. Each frame consists of two fields.

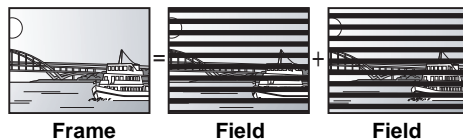

- A frame still shows two fields, so there may be some blurring, but picture quality is generally better.
- A field still shows less picture information so it may be rougher, but there is no blurring.

HDMI (High-Definition Multimedia Interface)

HDMI is a digital interface for consumer electronic products. Unlike conventional connections, it transmits uncompressed digital video and audio signals on a single cable.

JPEG (Joint Photographic Experts Group)

This is a system used for compressing/decoding color still pictures. If you select JPEG as the storage system on digital cameras, etc., the data will be compressed to 1/10–1/100 of its original size. The benefit of JPEG is less deterioration in picture quality considering the degree of compression.

LPCM (Linear PCM)

This is a type of PCM format.

These are uncompressed digital signals, similar to those found on CDs.

MPEG2 (Moving Picture Experts Group)

A standard for efficiently compressing and expanding color video.

MPEG2 is a compression standard used for DVD and satellite based digital broadcasting.

MP3 (MPEG Audio Layer 3)

An audio compression method that compresses audio to approximately one tenth of its size without any significant loss of audio quality.

P4HD (Pixel Precision Progressive Processing for HD)

This is a processor which makes use of an exclusive Panasonic algorithm. Various processing is supported, including a high-level conversion of the TV scanning format from interlace to progressive and a high-level conversion of standard resolution (480i or 576i) video signal to a 1080 High Definition video signal.

Consequently, this unit is able to provide video of optimal resolution to the connected TV.

Pan&Scan/Letterbox

In general, DVD-Video are produced with the intention that they be viewed on a widescreen television (16:9 aspect ratio), so images often don't fit regular (4:3 aspect ratio) televisions. Two styles of picture, "Pan & Scan" and "Letterbox", deal with this problem.

Pan&Scan: The sides are cut off so the picture fills the screen.



Letterbox: Black bands appear at the top and bottom of the picture so the picture itself appears in an aspect ratio of 16:9.



PCM (Pulse Code Modulation)

This is one format for converting analog audio into digital audio, enabling you to enjoy digital audio with no hassle.

Picture-in-picture

This is a function of BD-Video that plays the primary video and secondary video simultaneously. For instance, the function is capable of playing the original movie as the primary video while playing video commentary from the film director on a small screen as a secondary video.

Progressive/Interlace

The video signal standard of NTSC has 480 interlaced (i) scan lines, whereas progressive (p) scanning uses twice the number of scan lines, and this is referred to as 480p. Using progressive output, you can enjoy watching high resolution video.

Sampling frequency

Sampling is the process of converting the heights of sound wave (analog signal) samples taken at set periods into digits (digital encoding). Sampling frequency is the number of samples taken per second, so larger numbers mean more faithful reproduction of the original sound.

1080i

In one high definition image, 1080 (1125) alternating scan lines pass to create an interlaced image. Because 1080i (1125i) more than doubles current television broadcasts of 480i, the detail is much clearer and creates a more realistic and rich image.

1080p

In one high definition image, 1080 (1125) scan lines pass at the same time to create a progressive image. Since progressive video does not alternate scan lines like interlace, there is a minimal amount of screen flicker.

24p

This is a progressive image recorded at a rate of 24 frames per second (motion-picture film). Many BD-Video movie contents are recorded in 24 frames/second in accordance with the film materials.

720p

In one high definition image, 720 (750) scan lines pass at the same time to create a progressive image. Since progressive video does not alternate scan lines like interlace, there is a minimal amount of screen flicker.

Limited Warranty (ONLY FOR U.S.A. AND PUERTO RICO)

Panasonic Consumer Electronics Company,
Division of Panasonic Corporation of North America
One Panasonic Way, Secaucus, New Jersey 07094

Panasonic Blu-ray and DVD Products Limited Warranty

Limited Warranty Coverage (For USA and Puerto Rico Only)

If your product does not work properly because of a defect in materials or workmanship, Panasonic Consumer Electronics Company (referred to as "the warrantor") will, for the length of the period indicated on the chart below, which starts with the date of original purchase ("warranty period"), at its option either (a) repair your product with new or refurbished parts, (b) replace it with a new or a refurbished equivalent value product, or (c) refund your purchase price. The decision to repair, replace or refund will be made by the warrantor.

Product or Part Name	Parts	Labor
Blu-ray Disc Player, Portable Blu-ray Disc Player	1 year	90 days
Blu-ray Home Theater System	1 year	1 year
DVD Player, Portable DVD Player	1 year	90 days
DVD Recorder	1 year	90 days
Rechargeable Batteries (pack), DVD-RAM Disc (defective exchange)	10 days	Not Applicable
Headphones, Accessories (in exchange for defective item)	90 days	Not Applicable

During the "Labor" warranty period there will be no charge for labor. During the "Parts" warranty period, there will be no charge for parts. This Limited Warranty excludes both parts and labor for non-rechargeable batteries, antennas, and cosmetic parts (cabinet). This warranty only applies to products purchased and serviced in the United States or Puerto Rico. This warranty is extended only to the original purchaser of a new product which was not sold "as is".

Mail-In Service

For assistance in the U.S.A. and Puerto Rico in obtaining repairs, please ship the product prepaid to:

Panasonic Exchange Center
4900 George McVay Drive
Suite B
McAllen, TX 78503
panacare@us.panasonic.com

When shipping the unit, carefully pack, include all accessories, and send it prepaid, adequately insured and preferably in the original carton. If Lithium Ion batteries are shipped by air the package must be labeled "Contains Lithium Ion Battery (No lithium metal)". Damaged batteries are prohibited from shipment by US Mail. Batteries must be securely packed in a manner to prevent short-circuiting and a package cannot contain more than 3 Lithium Ion batteries. Include a letter detailing the complaint, a return address and provide a daytime phone number where you can be reached. A valid registered receipt is required under the Limited Warranty.

IF REPAIR IS NEEDED DURING THE WARRANTY PERIOD, THE PURCHASER WILL BE REQUIRED TO FURNISH A SALES RECEIPT/PROOF OF PURCHASE INDICATING DATE OF PURCHASE, AMOUNT PAID AND PLACE OF PURCHASE. CUSTOMER WILL BE CHARGED FOR THE REPAIR OF ANY UNIT RECEIVED WITHOUT SUCH PROOF OF PURCHASE.

Limited Warranty Limits And Exclusions

This warranty ONLY COVERS failures due to defects in materials or workmanship, and DOES NOT COVER normal wear and tear or cosmetic damage. The warranty ALSO DOES NOT COVER damages which occurred in shipment, or failures which are caused by products not supplied by the warrantor, or failures which result from accidents, misuse, abuse, neglect, mishandling, misapplication, alteration, faulty installation, set-up adjustments, misadjustment of consumer controls, improper maintenance, power line surge, lightning damage, modification, introduction of sand, humidity or liquids, commercial use such as hotel, office, restaurant, or other business or rental use of the product, or service by anyone other than a Factory Service Center or other Authorized Servicer, or damage that is attributable to acts of God.

User memo:

DATE OF PURCHASE _____
DEALER NAME _____
DEALER ADDRESS _____

TELEPHONE NUMBER _____

THERE ARE NO EXPRESS WARRANTIES EXCEPT AS LISTED UNDER "LIMITED WARRANTY COVERAGE".

THE WARRANTOR IS NOT LIABLE FOR INCIDENTAL OR CONSEQUENTIAL DAMAGES RESULTING FROM THE USE OF THIS PRODUCT, OR ARISING OUT OF ANY BREACH OF THIS WARRANTY.

(As examples, this excludes damages for lost time, travel to and from the servicer, loss of or damage to media or images, data or other memory or recorded content. The items listed are not exclusive, but for illustration only.)

ALL EXPRESS AND IMPLIED WARRANTIES, INCLUDING THE WARRANTY OF MERCHANTABILITY, ARE LIMITED TO THE PERIOD OF THE LIMITED WARRANTY.

Some states do not allow the exclusion or limitation of incidental or consequential damages, or limitations on how long an implied warranty lasts, so the exclusions may not apply to you.

This warranty gives you specific legal rights and you may also have other rights which vary from state to state. If a problem with this product develops during or after the warranty period, you may contact your dealer or Service Center. If the problem is not handled to your satisfaction, then write to the warrantor's Consumer Affairs Department at the addresses listed for the warrantor.

PARTS AND SERVICE, WHICH ARE NOT COVERED BY THIS LIMITED WARRANTY, ARE YOUR RESPONSIBILITY.

Customer Services Directory (United States and Puerto Rico)

Obtain Product Information and Operating Assistance; locate your nearest Dealer or Service Center; purchase Parts and Accessories; or make Customer Service and Literature requests by visiting our Web Site at:

<http://www.panasonic.com/help>

or, contact us via the web at:

<http://www.panasonic.com/contactinfo>

You may also contact us directly at:

1-800-211-PANA (7262)

Monday-Friday 9am-9pm,

Saturday-Sunday 10am-7pm EST

For hearing or speech impaired TTY users, TTY: 1-877-833-8855

Accessory Purchases (United States and Puerto Rico)

Purchase Parts, Accessories and Instruction Books online for all Panasonic Products by visiting our Web Site at:

<http://www.pstc.panasonic.com>

Or, send your request by E-mail to:

npcparts@us.panasonic.com

You may also contact us directly at:

1-800-332-5368 (Phone) 1-800-237-9080 (Fax Only)

(Monday-Friday 9am-9pm EST)

Panasonic Service and Technology Company

20421 84th Avenue South, Kent, WA 98032

(We accept Visa, MasterCard, Discover Card, American Express, and Personal Checks)

For hearing or speech impaired TTY users, TTY: 1-866-605-1277

As of November 2009

The model number and serial number of this product can be found on either the back or the bottom of the unit.

Please note them in the space provided below and keep for future reference.

MODEL NUMBER _____ DMP-B200
SERIAL NUMBER _____

Limited Warranty (ONLY FOR CANADA)

Panasonic Canada Inc.
5770 Ambler Drive, Mississauga, Ontario L4W 2T3

PANASONIC PRODUCT - LIMITED WARRANTY

Panasonic Canada Inc. warrants this product to be free from defects in material and workmanship under normal use and for a period as stated below from the date of original purchase agrees to, at its option either (a) repair your product with new or refurbished parts, (b) replace it with a new or a refurbished equivalent value product, or (c) refund your purchase price. The decision to repair, replace or refund will be made by Panasonic Canada Inc.

Technics Audio Product - One (1) year, parts and labour
Panasonic BD/DVD Product - One (1) year, parts and labour
Panasonic Audio Receivers - One (1) year, parts and labour
Home Theater Systems Product - One (1) year, parts and labour

This warranty is given only to the original purchaser, or the person for whom it was purchased as a gift, of a Panasonic brand product mentioned above sold by an authorized Panasonic dealer in Canada and purchased and used in Canada, which product was not sold "as is", and which product was delivered to you in new condition in the original packaging.

IN ORDER TO BE ELIGIBLE TO RECEIVE WARRANTY SERVICE HEREUNDER, A PURCHASE RECEIPT OR OTHER PROOF OF DATE OF ORIGINAL PURCHASE, SHOWING AMOUNT PAID AND PLACE OF PURCHASE IS REQUIRED

LIMITATIONS AND EXCLUSIONS

This warranty ONLY COVERS failures due to defects in materials or workmanship, and DOES NOT COVER normal wear and tear or cosmetic damage. The warranty ALSO DOES NOT COVER damages which occurred in shipment, or failures which are caused by products not supplied by Panasonic Canada Inc., or failures which result from accidents, misuse, abuse, neglect, mishandling, misapplication, alteration, faulty installation, set-up adjustments, misadjustment of consumer controls, improper maintenance, power line surge, lightning damage, modification, introduction of sand, humidity or liquids, commercial use such as hotel, office, restaurant, or other business or rental use of the product, or service by anyone other than an Authorized Servicer, or damage that is attributable to acts of God.

Dry cell batteries are also excluded from coverage under this warranty.

THIS EXPRESS, LIMITED WARRANTY IS IN LIEU OF ALL OTHER WARRANTIES, EXPRESS OR IMPLIED, INCLUDING ANY IMPLIED WARRANTIES OF MERCHANTABILITY AND FITNESS FOR A PARTICULAR PURPOSE. IN NO EVENT WILL PANASONIC CANADA INC. BE LIABLE FOR ANY SPECIAL, INDIRECT OR CONSEQUENTIAL DAMAGES RESULTING FROM THE USE OF THIS PRODUCT OR ARISING OUT OF ANY BREACH OF ANY EXPRESS OR IMPLIED WARRANTY. (As examples, this warranty excludes damages for lost time, travel to and from the Authorized Servicer, loss of or damage to media or images, data or other memory or recorded content. This list of items is not exhaustive, but for illustration only.)

In certain instances, some jurisdictions do not allow the exclusion or limitation of incidental or consequential damages, or the exclusion of implied warranties, so the above limitations and exclusions may not be applicable. This warranty gives you specific legal rights and you may have other rights which vary depending on your province or territory.

WARRANTY SERVICE

For product operation and information assistance, please contact:

PRODUCT OPERATION ASSISTANCE

Customer Care Centre: Telephone #: 1-800-561-5505
Fax #: (905) 238-2360
Email link: "Support → contact us → email" on www.panasonic.ca

PRODUCT REPAIRS

Please locate your nearest Authorized Servicentre.

Link: "Support → Panasonic Servicentre® locator" on www.panasonic.ca

IF YOU SHIP THE PRODUCT TO A SERVICENTRE

Carefully pack and send prepaid, adequately insured and preferably in the original carton.
Include details of the defect claimed, and proof of date of original purchase.

Index

A Audio		Q Quick Start	29
Changing audio	16	R Restore Default Settings	29
Language	24, 26	Resume play function	15
AVCHD	31, 40	S Subtitle	24
C Chapter	15	V VIERA Link™	
F File format	31	“HDAVI Control™”	22
Firmware update	5	24p	25, 28
L Language			
Audio	24, 26		
Menu	26		
On-screen	28		
Soundtrack	24		
Subtitle	24, 26		
P Playlist	15		
Pop-up Menu	14		



Information on Disposal in other Countries outside the European Union



This symbol is only valid in the European Union. If you wish to discard this product, please contact your local authorities or dealer and ask for the correct method of disposal.

Panasonic Consumer Electronics Company, Division of Panasonic Corporation of North America
 One Panasonic Way, Secaucus, New Jersey 07094
<http://www.panasonic.com>

Panasonic Canada Inc.
 5770 Ambler Drive
 Mississauga, Ontario
 L4W 2T3
www.panasonic.ca

