

OPTIMUS®

16-3869

Digital Camera

Thank you for purchasing this Optimus Digital Camera from RadioShack.



WHAT'S IN THIS PACKAGE

Digital Camera • User's Guide

Please read this user's guide before installing, setting up and using your new product.



OPTIMUS

16-3869

The FCC Wants You to Know

This equipment has been tested and found to comply with the limits for a Class B digital device, pursuant to Part 15 of the FCC Rules. These limits are designed to provide reasonable protection against harmful interference in a residential installation. This equipment generates, uses, and can radiate radio frequency energy and, if not installed and used in accordance with the instructions, may cause harmful interference to radio communications. However, there is no guarantee that interference will not occur in a particular installation. If this equipment does cause harmful interference to radio or television reception, which can be determined by turning the equipment off and on, the user is encouraged to try to correct the interference by one or more of the following measures:

- Reorient or relocate the receiving antenna.
- Increase the separation between the equipment and receiver.
- Connect the equipment into an outlet on a circuit different from that to which the receiver is connected.

Consult your local RadioShack store or an experienced radio/TV technician for help. If you cannot eliminate the interference, the FCC requires that you stop using your product. Changes or modifications not expressly approved by RadioShack may cause interference and void the user's authority to operate the equipment.

FCC Declaration of Conformity

This device complies with Part 15 of the FCC Rules. Operation is subject to the following two conditions: (1) This device may not cause harmful interference, and (2) This device must accept any interference received, including interference that may cause undesired operation.



Product	Digital Camera
Model	16-3869
Responsible Party	RadioShack 300 RadioShack Circle Fort Worth, TX 76102

READ THIS FIRST

Trademark Information

- Microsoft® and Windows® are U.S. registered trademarks of Microsoft Corporation.
- Pentium® is a registered trademark of Intel Corporation.
- Macintosh is a trademark of Apple Computer, Inc.
- SD™ is a trademark.
- Photo Explorer and Photo Express are trademarks.
- Other names and products may be trademarks or registered trademarks of their respective owners.







Product Information

- Product design and specifications are subject to change without notice. This includes primary product specifications, software, software drivers, and user's manual. This User Manual is a general reference guide for the product.
- The product and accessories that come with your digital camera may be different from those described in this manual. This is due to the fact that different retailers often specify slightly different product inclusions and accessories to suit their market requirements, customer demographics, and geographical preferences. Products very often vary between retailers especially with accessories such as batteries, chargers, AC adapters, memory cards, cables, carrying cases/pouches, and language support. Occasionally a retailer will specify a unique product color, appearance, and internal memory capacity. Contact your dealer for precise product definition and included accessories.
- The illustrations in this manual are for the purpose of explanation and may differ from the actual design of your digital camera.
- The manufacturer assumes no liability for any errors or discrepancies in this user manual.
- For user manual and driver updates, refer to our website or contact your dealer.









SAFETY INSTRUCTIONS

Read and understand all *Warnings* and *Cautions* before using this product.

Warnings

- | | |
|--|---|
| If foreign objects or water have entered the camera, turn the power OFF and remove the batteries. Continued use in this state might cause fire or electric shock. Consult the store of purchase. |  |
| If the camera has fallen or its case has been damaged, turn the power OFF and remove the batteries. Continued use in this state might cause fire or electric shock. Consult the store of purchase. |  |
| Do not disassemble, change or repair the camera. This might cause fire or electric shock. For repair or internal inspection, ask the store of purchase. |  |
| Do not use the camera in areas near water. This might cause fire or electric shock. Take special care during rain, snow, on the beach, or near the shore. |  |
| Do not place the camera on inclined or unstable surfaces. This might cause the camera to fall or tilt over, causing injury. |  |
| Keep the batteries out of the reach of children. Swallowing batteries might cause poisoning. If the battery is accidentally swallowed, immediately consult a physician. |  |
| Do not use the camera while you are walking, driving or riding a motorcycle. This might cause you to fall over or result in traffic accident. |  |

Cautions

- | | |
|--|---|
| Insert the batteries paying careful attention to the polarity (+ or -) of the terminals.
Inserting the batteries with its polarities inverted might cause fire and injury, or damage to the surrounding areas due to the battery rupturing or leaking. |  |
| Do not fire the flash close to anyone's eyes.
This might cause damage to the person's eyesight. |  |
| Do not subject the LCD monitor to impact.
This might damage the glass on the screen or cause the internal fluid to leak. If the internal fluid enters your eyes or comes into contact with your body or clothes, rinse with fresh water. If the internal fluid has entered your eyes, consult a physician to receive treatment. |  |
| A camera is a precision instrument. Do not drop it, strike it or use excessive force when handling the camera.
This might cause damage to the camera. |  |
| Do not use the camera in humid, steamy, smoky, or dusty places.
This might cause fire or electric shock. |  |
| Do not remove the battery immediately after long period of continuous use.
The battery becomes hot during use. Touching a hot battery might cause burns. |  |
| Do not wrap the camera or place it in cloth or blankets.
This might cause heat to build up and deform the case, resulting in fire. Use the camera in a well-ventilated place. |  |
| Do not leave the camera in places where the temperature may rise significantly, such as inside a car.
This might adversely affect the case or the parts inside, resulting in fire. |  |
| Before you move the camera, disconnect cords and cables.
Failure to do this might damage cords and cables, resulting in fire and electric shock. |  |

Notes on Battery Usage

When you use the battery, carefully read and strictly observe the *Safety Instructions* and the notes described below:

- Different battery types and surrounding temperatures may affect the battery performance.
- Avoid using batteries in extremely cold environments as low temperatures can shorten the battery life and reduce camera performance.
- Using the new rechargeable battery or rechargeable battery that has not been used for an extended period of time (the battery that passed the expiry date is an exception) might affect the number of pictures that can be taken. Therefore, to maximize its performance and lifetime, we recommend that you fully charge the battery and discharge it for at least one complete cycle before use.
- The battery may feel warm after long period of continuous use of the camera or the flash. This is normal and not a malfunction.
- The camera may feel warm after long period of continuous use. This is normal and not a malfunction.
- If the battery is not to be used for a long period of time, remove it from the camera to prevent leakage or corrosion.
- If the battery is not to be used for a long period of time, store it after no battery power left. If the battery is stored for a long time in a fully charged state, its performance may be impaired.
- Always keep the battery terminals in a clean state.
- Risk of explosion if battery is replaced by an incorrect type.
- Dispose of used batteries according to the instructions.

CONTENTS

INTRODUCTION.....	8	SELECTING PHOTOGRAPHY MODE.....	34
Overview.....	8	Auto Mode.....	34
Package Contents.....	9	Sports Mode.....	35
Optional Accessories.....	9	Night Scene Mode.....	36
 		Portrait Mode.....	37
COMPONENTS GUIDE.....	10	Landscape Mode.....	38
Front View.....	10	Backlight Mode.....	39
Rear view.....	11	 	
LED Indicators.....	12	MOVIE MODE.....	40
Scene Modes.....	13	 	
LCD Monitor Information.....	14	IMAGE PLAYBACK.....	41
 		Single Image Playback.....	41
PREPARING YOUR CAMERA.....	19	Magnifying Images.....	42
Installing the Battery.....	19	Viewing Nine Images At A Time.....	43
Charging the Battery.....	20	Viewing Video Clips.....	44
Loading an SD Memory Card (Optional Accessory).....	21	Automated Playback (Slide Show).....	44
Setting the Date and Time.....	22	Protecting Images.....	45
Choosing the Language.....	22	 	
Attaching the Camera Strap.....	23	DELETING IMAGES.....	46
 		Deleting Images/Video Clips Singly.....	46
BASIC FUNCTIONS.....	24	Deleting All Images/Video Clips.....	47
Turning the Power On.....	24	Formatting an SD Memory Card or Internal Memory.....	48
Turning the Power Off.....	24	 	
Using the LCD Monitor.....	25	SETTING THE DPOF.....	49
Using the Normal Mode.....	26	 	
Adjusting the Zoom.....	27	TRANSFERRING RECORDED IMAGES/VIDEO CLIPS TO YOUR COMPUTER.....	50
Using the Flash.....	28	Step 1: Install the USB Driver.....	51
Using the Self-Timer.....	30	Step 2: Connecting the Camera to Your Computer.....	52
Using the Macro Mode.....	31		
Setting the Image Resolution and Quality.....	32		

Step 3: Downloading Recorded Images/Video Clips.....	53
SOFTWARE INSTALLATION.....	54
Installing Photo Explorer.....	54
Installing Photo Express.....	55
USING THE DIGITAL CAMERA AS A PC CAMERA.....	56
Step 1: Install the PC camera driver.....	56
Step 2: Connect the digital camera to your computer.....	57
Step 3: Run your application software (i.e. Windows NetMeeting).....	57
LIST OF MENU OPTIONS.....	58
Capture Menu.....	58
Playback Menu.....	64
Video Menu.....	65
CAMERA SPECIFICATIONS.....	68
TROUBLESHOOTING.....	69

INTRODUCTION

Overview

Your new stylish digital camera delivers high quality, 2560 x 1920 resolution images using a 5.0 Megapixels CCD sensor. Using the 1.7" TFT color image LCD monitor, you can compose images and then examine them in detail. An auto-flash sensor automatically detects the shooting (lighting) conditions and determines whether the flash should be used. This feature helps ensure that your images turn out right.

16 MB internal memory (14 MB available for image storage) lets you capture and store images without the need for an additional memory card. However, you may wish to expand the memory capacity by using an external memory card.

In addition to still images, you can record short videos by using the movie function.

Images you have taken can be downloaded to your computer using the USB cable. You can enhance and retouch your images on your computer by using the provided editing software, or image editing software you may already own. You may share your images with your friends via e-mail, in a report, or on a website.

DPOF functionality allows you to print your images on a DPOF compatible printer by simply inserting the memory card.

Package Contents

Carefully unpack your camera and ensure that you have the following items. In the event that any item is missing or if you find any mismatch or damage, promptly contact to your dealer.

- Digital Camera
- User's Manual
- USB Cable
- Lithium ion rechargeable battery (650mA)
- Camera Strap
- Software CD-ROM
- Camera Pouch
- AC power adapter

Optional Accessories

- Memory card

COMPONENTS GUIDE

Front View

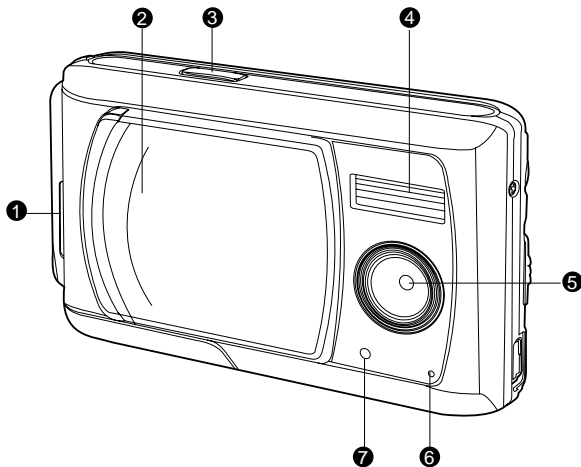

1. Strap eyelet

2. Lens cover

3. Shutter button

4. Flash

5. Lens

6. Microphone

7. Self-timer LED

Rear view

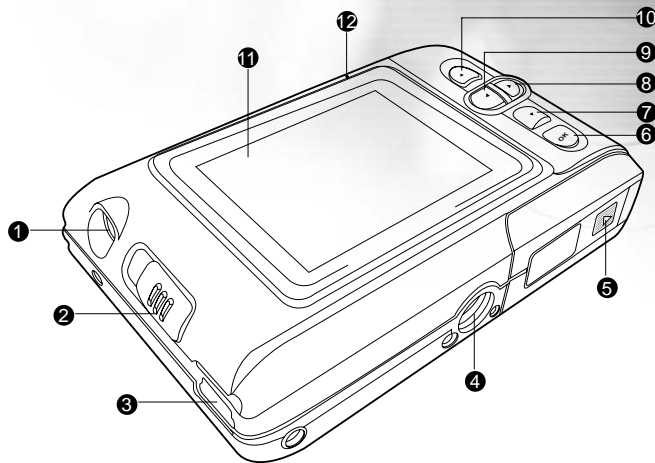

1. DC IN 5V terminal

2. Focus switch

Macro mode

Normal mode

3. USB terminal

4. Tripod socket

5. Battery/SD card

6. OK button

Zoom button

7. ▼ Arrow button (Down)
MODE Mode button

8. ► Arrow button (Right)
Flash button

9. ◀ Arrow button (Left)
Self-timer button

10. ▲ Arrow button (Up)
MENU Menu button

11. LCD monitor

12. Status LED





LED Indicators

Indicator	Status	Description/Activity	Sound
Status LED	None	The camera is powering up	Yes *(1)
Status LED	Solid green	The camera is powered and ready	No
Status LED	Blinking green	Charging the flash	No
Status LED	Blinking green	Image is being recorded to the memory card	No
Status LED	Solid green	USB communication/transfer in progress	No
Status LED	Solid green	The camera is ready to record images (or movies)	Yes *(1)
Self-timer LED	Blinking red	The self-timer function is activated	Yes *(Sec)
----	----	Button event	Yes *(1)

- (1) The camera sounds one beep.
- (Sec) The self-timer sounds 10 beeps for 10 seconds, 5 beeps for 5 seconds.

Scene Modes





Select the scene mode suitable for the occasion or situation.

Mode	Description
1. [A] Auto mode	Select this option to leave all the adjustments to the camera and take images casually.
2. [] Sports mode	Select this option to capture fast-moving subjects.
3. [] Night Scene mode	Select this option to take images of people against dark or nighttime background.
4. [] Portrait mode	Select this option to make people stand out with the background out-of-focus.
5. [] Landscape mode	Select this option to capture images of distant scenery or landscapes.
6. [] Backlight mode	Select this option to brighten subjects that are backlit and would come out dark if no flash was used.

LCD Monitor Information

These indicators are displayed when recording still images:





1. Scene mode

- [**A**] Auto mode
- [] Sports mode
- [] Night Scene mode
- [] Portrait mode
- [] Landscape mode
- [] Backlight mode

2. Image quality

- [] Fine
- [] Normal
- [] Economy

3. Image size



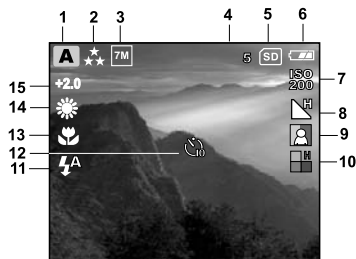

- [] 3072x2304
- [] 2560x1920
- [] 2048x1536
- [] 1280x960
- [] 640x480





4. Remaining pictures

5. [] Card indicator

6. Battery level

- [] Fully battery level
- [] Fairly consumed
- [] Nearly exhausted
- [] Virtually no battery power

7. ISO speed

- [No icon] Auto
- [] 100
- [] 200



8. Sharpness

- [] High
- [] Medium
- [] Low

9. Color

- [] Full Color
- [] Black & White
- [] Sepia



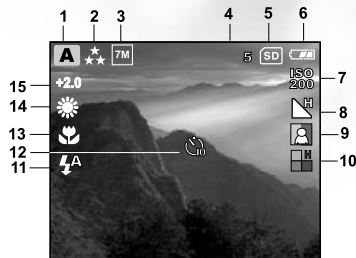

10. Saturation

- [] High
- [] Medium
- [] Low

These indicators are displayed when recording still images:







11. Flash mode

- [] Fill flash (on)
- [] Flash off
- [] Automatic flash
- [] Red-eye reduction

12. [] Self-timer mode

13. [] Macro mode icon







14. White balance

- [No icon] Auto
- [] Daylight
- [] Cloudy
- [] Tungsten
- [] Fluorescent

15. EV compensation





These indicators are displayed when playing images back:



1. Playback mode
2. [] Card indicator
3. Battery level
[] Fully battery level
[] Fairly consumed
[] Nearly exhausted
[] Virtually no battery power
4. [] Protect indicator
5. [] DPOF icon

These indicators are displayed when recording video clips:



1. Movie mode
2. Recording indicator
3. Video counter
4. [SD] Card indicator
5. Battery level
[] Fully battery level
[] Fairly consumed
[] Nearly exhausted
[] Virtually no battery power

These indicators are displayed when playing video clips back:



1. Playback mode
2. Battery level
[] Fully battery level
[] Fairly consumed
[] Nearly exhausted
[] Virtually no battery power
3. [] Card indicator
4. Index number of total number
5. Movie mode
6. Elapsed time
7. Elapsed playback indicator

PREPARING YOUR CAMERA

Installing the Battery

We highly recommend you to use the specified rechargeable lithium-ion battery to realize the full capability of your digital still camera. Make sure that the power of the digital still camera is off before inserting or removing the battery.

1. Make sure your camera is off.
2. Slide the battery/SD card cover lock.
3. Insert the battery in the correct orientation shown.
 - Tilt the battery lock lever in the direction of the arrow and orient the battery so that its label is facing to the front side of the camera, and then insert the battery.
4. Close the battery/SD card cover lock firmly.

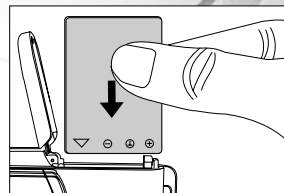

Removing the Battery

Open the battery/SD card cover and then release the battery lock lever. When the battery has come out a little, slowly pull it out the rest of the way.

Charging the Battery

Using the optional AC power adapter may charge the battery or operate the camera as power supply. Make sure that the power of the camera is off and then insert the battery before starting.

1. Insert one end of the AC power adapter into the DC IN terminal of the camera.
2. Insert the other end of the AC power adapter into a wall outlet.
 - The status LED flashes green when charging is started and lights green when charging is completed.
 - It is recommended to fully discharge or exhaust the battery before being charged.
 - Charging time varies according to the ambient temperature and the status of battery.

NOTE:

- This camera must be used with specified AC power adapter. Damage caused by the use of an incorrect adapter is not covered under the warranty.
- When the charging is not started even if following the above procedure, turn the power on at any mode after LCD monitor turns on, and then turn the power off.
- The battery may feel warm after it has been charged or immediately after being used. This is normal and not a malfunction.
When using the camera in cold areas, keep the camera and battery warm by holding them inside your outer cloth.
- If you open the battery cover without removing the battery, the power will not be terminated. If you remove the battery, you have to insert the battery again in a period of 2 hours in order to make sure that the date and time will not be reset.
- We recommend the battery should be charged 8 hours as first time use.

Loading an SD Memory Card (Optional Accessory)

Your camera comes with 16 MB of internal memory (14 MB available for image storage), allowing you to store images and video clips in the camera. However, you can also expand the memory capacity by using the SD memory card. Optional SD memory card provide removable, reusable storage for images and video clips.

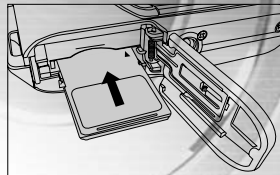

1. Make sure your camera is off.
2. Slide the SD card/battery cover lock.
3. Insert the SD memory card.
 - If the card cannot be inserted, check the orientation.
4. Close the SD card/battery cover lock firmly.

Note:

- To prevent valuable data from being accidentally deleted from an SD memory card you can slide the write protect tab (on the side of the SD memory card) to "LOCK".
- To save, edit, or delete data on an SD memory card, you must unlock the card.
- Be sure to format the memory card with this camera before its initial usage.

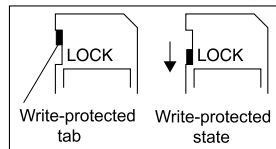

To remove an SD memory card

1. Make sure your camera is off.
2. Slide the SD card/battery cover lock.
3. Press lightly on the edge of the memory card and it will eject.

Note:

- Memory cards may become hot during use; observe due caution when removing memory cards.

Setting the Date and Time

The Date/Time screen will be presented if/when:

- The camera is turned on for the first time.
- The camera is turned on after removing the batteries for a long period of time.

1. Select the item field by using the ◀ / ▶ button.
 - To increase the value, press the ▲ button.
 - To decrease the value, press the ▼ button.
2. Press the **OK** button after all fields are set.

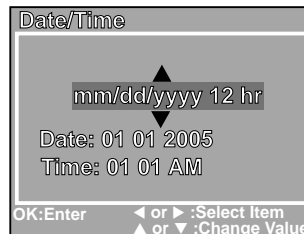

Choosing the Language

Follow the steps below to set the OSD (On-Screen Display) language.

1. Press the **MENU**.
2. Press the ▶ button to select [Setup] menu.
3. Press the ▲/▼ button to select [Language], and press the **OK** button.
4. Select a language that you prefer by using the ▲/▼ button.
5. Press the **OK** button after all fields are set.

Note:

- The language setting will be retained even if the camera is turned off.



Attaching the Camera Strap

To prevent accidental slippage during the use, always use the camera strap.

Attach the camera strap as follows:

1. Thread the small loop of the strap through the strap eyelet on the camera.
2. Pull the large loop through the small loop until the strap is firmly secured.

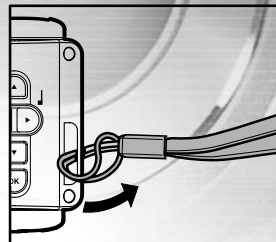

BASIC FUNCTIONS

Turning the Power On

1. Slide the lens cover to turn the camera on.
2. The camera sounds one beep when it is initiated.

Turning the Power Off

Slide the lens cover back to turn the camera off.

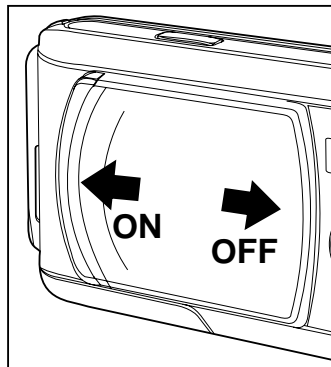

Using the LCD Monitor

Using the LCD monitor can help you to confirm an image while taking pictures, to replay recorded images/video clips or to adjust menu settings.

The mode icons, text and numbers that are displayed on the LCD monitor may vary according to the current settings.

1. Slide the lens cover to turn the camera on.
2. Set the scene mode in the Capture menu based on the desired scenery.
(Auto/Sports/Night Scene/Portrait/Landscape/Backlight).
3. Compose your image on the LCD monitor.
4. Press the shutter button.

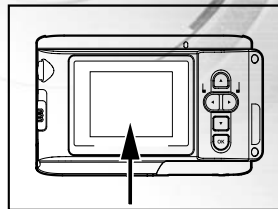

Note:

- The LCD monitor darkens in strong sunlight or bright light. This is not a malfunction.

Using the Normal Mode

Normal mode is used to take images where the distance to the subject 1.12m to infinity. Select this mode for general shooting, including portraits and scenery.

1. Set the focus to the [▲] position.
2. Compose your image.
3. Press the shutter button.

Note:

- LCD monitor will display [A] as indicating Normal mode.

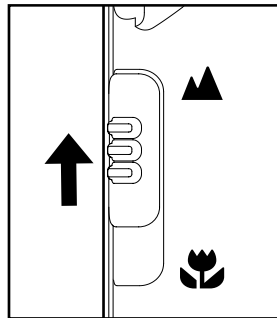

Adjusting the Zoom

Using digital zoom, images appear closer. Whereas digital zoom is a compelling feature, the more an image is enlarged (zoomed), the more pixelated (grainier) the image will appear.

1. Set the scene mode in the Capture menu based on the desired scenery.
(Auto/Sports/Night Scene/Portrait/Landscape/Backlight).
2. Press the **Q** button to activate the zoom function.
 - Digital zoom's range is from 1x to 2x to 4x.
 - To exit the digital zoom, press the **Q** button again and return to the capture status.
3. Press the shutter button to capture a "zoomed" image.

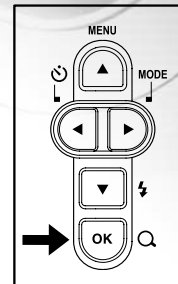

Note:

- You can only set the digital zoom at the resolution of 2560 x 1920 pixels; digital zoom is not available at the resolution of 3072 x 2304 pixels, 2048 x 1536 pixels, 1280 x 960 pixels or 640 x 480 pixels.
- Digital zoom cannot be used in [] Movie mode.

Using the Flash



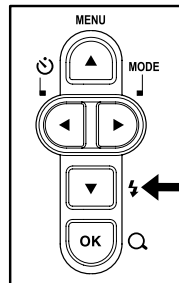

The flash is designed to function automatically when lighting conditions warrant the use of flash. You can take an image using a suitable flash mode to your circumstances.

1. Set the scene mode in the Capture menu based on the desired scenery.
(Auto/Sports/Night Scene/Portrait/Landscape/Backlight).
2. Press the  button located on the rear side of the camera repeatedly until your desired flash mode appears on the LCD monitor.
3. Compose your image and press the shutter button.







The camera has four flash modes: Fill flash (on), Flash off, Automatic flash and Red-eye reduction.



The table below will help to choose the appropriate flash mode:

Flash Mode	Description
[] Fill flash (on)	The flash will always fire regardless of the surrounding brightness. Select this mode for recording images with high contrast (backlighting) and deep shadows.
[] Flash off	The flash will not fire. Select this mode when taking images in a place where flash photography is prohibited, or when the distance to the subject is beyond the effective range of the flash.
[] Automatic flash	The flash fires automatically according to the ambient lighting conditions. Select this mode for general photography.
[] Red-eye reduction	The flash emits a precursor-flash before the main flash fires. This causes the pupil in the human eye to constrict, reducing the red-eye phenomenon. Select this mode when taking images of people and animals in low-light conditions.



Note:

- In [] Macro mode and [] Landscape mode, flash photography is not possible.
- In [] Night Scene mode, flash photography will automatically detect the ambient lighting. If the surrounding brightness is low, the flash will fire to [] Red-eye reduction.
- In [] Sports mode, Flash mode is automatically set to [] Flash off.

Using the Self-Timer

By using the  self-timer you can join into the screen when taking group shots. According to your preferences you can take pictures with the self-timer in any scene mode (Auto/Sports/Night Scene/Portrait/Landscape/Backlight).

Self-timer duration can be set as 10 seconds or 5 seconds. Self-timer mode appears cyclically as [10 s]→[5 s]→[Self-Timer Off]. After the self-timer is set, the shutter automatically releases after 10 seconds or 5 seconds. The self-timer lamp starts blinking relatively slow for the first 7 seconds or the first 2 seconds and then blinking rapidly for the last 3 seconds.

1. Secure the camera to a tripod or place it on a stable surface.
2. Slide the lens cover to turn the camera on.
3. Set the scene mode in the Capture menu based on the desired scenery. (Auto/Sports/Night Scene/Portrait/Landscape/Backlight).
4. Press the  button to select the desired self-timer mode.
5. Compose your image.
6. Press the shutter button.
 - To cancel the self-timer photography at any time, press the  button to disrupt the sequence.

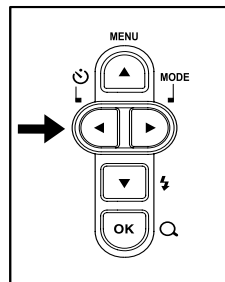



Note:

- After one shot is taken, the self-timer mode is turned to OFF.



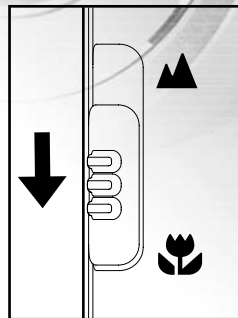

Using the Macro Mode

Use [] Macro mode to capture a close-up of the subject, such as flowers or insects. The effective range is between 0.6m to 1.14m.

1. Set the focus switch to the [] position.
 - LCD monitor will display [] as Macro mode.
2. Compose your image.
3. Press the shutter button.
 - To disable macro photography, slide the focus switch back to the [] Normal mode.



Note:

- In [] Macro mode, EV compensation, Scene mode and ISO speed cannot be set.
- In [] Macro mode, Flash mode is automatically set to [] Flash off.
- After a macro shot is taken DO NOT FORGET to reset the lens to the [] Normal position.

Setting the Image Resolution and Quality

Resolution and quality settings determine the pixel size (dimension), image file size, and compression ratio for your images. These settings affect the number of images that can be stored in memory, or on an SD memory card. As you get to know the camera, it is recommended that you try each quality and resolution setting to get an appreciation for the effects that these settings will have on your images.

Higher resolution and higher quality images offer the best photographic results but produce large file sizes. Therefore, fewer images will take up more memory space.

High resolution and quality settings are recommended for printed output and situations requiring the finest detail. Lower resolution/quality images take up less memory space and may be quite suitable for sharing images via e-mail, in a report, or on a web page.

To change image resolution or quality settings perform the steps below:

1. Press the **MENU** button to enter the [Capture] menu and select [Size] or [Quality] by using the ▼ / ▲ button. Press the **OK** button to enter the sub-menu.
2. After entering the sub-menu, select your option by using the ▼ / ▲ button. Press the **OK** button to confirm the setting.
3. To exit from the menu mode, use the ▼ / ▲ to select [Exit] and press the **OK** button.



Number of Recordable Images

The frame counter indicates the approximate number of images that can be stored on the internal memory or the SD memory card at the camera's image quality and size settings. The number of recordable images may vary depending on the recorded subject and the capacity of the memory card, or if there are files other than images, or when the recording is made while switching the picture quality/resolution.

Resolution	Quality	16 MB Internal Memory (14 MB available for image storage)	SD Memory Card						
			16 MB	32 MB	64 MB	128 MB	256 MB	512 MB	1 GB
3072x2304 7M	★★								
	★								
	★								
2560x1920 5M	★★								
	★								
	★								
2048x1536 3M	★★								
	★								
	★								
1280 x 960 1.2M	★★								
	★								
	★								
640 x 480 0.3M	★★								
	★								
	★								

* The above data shows the standard testing results. The actual capacity varies according to the shooting conditions and settings.

SELECTING PHOTOGRAPHY MODE

Auto Mode

Using [**A**] Auto mode the majority of the settings are adjusted by the camera. Simply point the subject and then shoot.

1. Press the **MENU** button to enter the [Capture] menu and select [Scene] by using the ▲ / ▼ button. Press the **OK** button to enter the sub-menu.
2. After entering the sub-menu, select [Auto] by using the ▲ / ▼ button. Press the **OK** button to confirm the setting.
 - LCD monitor will display [**A**] as Auto mode icon.
3. To exit from the menu mode, use the ▲ / ▼ to select [Exit] and press the **OK** button.

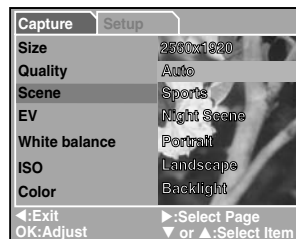

Note:

- Camera original status is set as [**A**] Auto mode.
- For other settings like Language, Power Off time or others, choose [Setup] in Capture/Video/Playback menu.



Sports Mode

For dynamic action choose [] Sports mode. This feature also letting you to capture moving subjects continuously.

1. Press the **MENU** button to enter the [Capture] menu and select [Scene] by using the **▲** / **▼** button. Press the **OK** button to enter the sub-menu.
2. After entering the sub-menu, select [Sports] by using the **▲** / **▼** button. Press the **OK** button to confirm the setting.
 - LCD monitor will display [] as Sports mode icon.
3. To exit from the menu mode, use the **▲** / **▼** to select [Exit] and press the **OK** button.



Note:

- In [] Sports mode, ISO speed cannot be set.
- In [] Sports mode, Flash mode is automatically set to [] Flash off.
- For other settings like Language, Power Off time or others, choose [Setup] in Capture/Video/Playback menu.



Night Scene Mode

Capturing human subjects by using [] Night Scene mode helps to provide a natural balance between the main subject and the background. The people in an evening sky or night scene are illuminated with lights from the flash while the background is captured at a slow shutter speed to prevent blurring and let the both (people and the background) appear accordingly exposure.

1. Press the **MENU** button to enter the [Capture] menu and select [Scene] by using the **▲** / **▼** button. Press the **OK** button to enter the sub-menu.
2. After entering the sub-menu, select [Night Scene] by using the **▲** / **▼** button. Press the **OK** button to confirm the setting.
 - LCD monitor will display [] as Night Scene icon.
3. To exit from the menu mode, use the **▲** / **▼** to select [Exit] and press the **OK** button.



Note:

- In [] Night Scene mode, Flash mode will automatically detect the ambient lighting. If the surrounding brightness is low, the flash will fire to [] Red-eye reduction.
- In [] Night Scene mode, ISO speed cannot be set.
- For other settings like Language, Power Off time or others, choose [Setup] in Capture/Video/Playback menu.



Portrait Mode

Taking pictures by selecting [] Portrait mode helps you to construct portraits in which the main subject stands out sharply and clearly while indistinct background's details.



1. Press the **MENU** button to enter the [Capture] menu and select [Scene] by using the **▲** / **▼** button. Press the **OK** button to enter the sub-menu.
2. After entering the sub-menu, select [Portrait] by using the **▲** / **▼** button. Press the **OK** button to confirm the setting.
 - LCD monitor will display [] as Portrait mode icon.
3. To exit from the menu mode, use the **▲** / **▼** to select [Exit] and press the **OK** button.









Note:

- In [] Portrait mode, ISO speed cannot be set.
- In [] Portrait mode, in a dark or night-time background, Flash mode defaults to [] Red-eye reduction.
- For other settings like Language, Power Off time or others, choose [Setup] in Capture/Video/Playback menu.



Landscape Mode

Taking images by choosing [] Landscape mode helps you to capture vivid and expansive landscape pictures with the enhancement of image's color and saturation. [] Landscape mode is used when the distance to the subject is between 1.1m to infinity.

1. Press the **MENU** button to enter the [Capture] menu and select [Scene] by using the  /  button. Press the **OK** button to enter the sub-menu.
2. After entering the sub-menu, select [Landscape] by using the  /  button. Press the **OK** button to confirm the setting.
 - LCD monitor will display [] as Landscape mode icon.
3. To exit from the menu mode, use the  /  to select [Exit] and press the **OK** button.



Note:

- In [] Landscape mode, ISO speed cannot be set.
- In [] Landscape mode, Flash mode is automatically set to [] Flash off.
- For other settings like Language, Power Off time or others, choose [Setup] in Capture/Video/Playback menu.



Backlight Mode

Use [] Backlight mode when light is coming from behind your subject, throwing their features into shadow, or when your subject is in the shade but the background is brightly lit.

1. Press the MENU button to enter the [Capture] menu and select [Scene] by using the ▲ / ▼ button. Press the OK button to enter the sub-menu.
2. After entering the sub-menu, select [Backlight] by using the ▲ / ▼ button. Press the OK button to confirm the setting.
 - LCD monitor will display [] as Backlight mode icon.
3. To exit from the menu mode, use the ▲ / ▼ to select [Exit] and press the OK button.



Note:

- In [] Backlight mode, Flash mode defaults to [] Fill flash (on).
- In [] Backlight mode, ISO speed cannot be set.
- For other settings like Language, Power Off time or others, choose [Setup] in Capture/Video/Playback menu.

MOVIE MODE

Using [] Movie mode allows you to record video clips at a resolution of 320 x 240 pixels.

1. Press the MODE button to enter the [] Movie mode.
2. You can start recording a video clip by pressing the shutter button.
3. To stop recording, press the shutter button again.



Note:





- In [] Movie mode, resolution/quality, self-timer cannot be set or activated.
- In [] Movie mode, the flash mode is automatically set to [] Flash off.
- To set [EV] or [White Balance], you may use the [Video] menu.

IMAGE PLAYBACK

In [] Playback mode, you can view, magnify your images or play video clips back. This mode even provides thumbnail images display and slide show, allowing you to quickly search for the image that you want or play the images back one by one automatically.



Single Image Playback

Play back still images one at a time.

1. Press twice the **MODE** button to enter [] Playback mode.
 - The last recorded image appears on the LCD monitor.
2. View and select your recorded images by using the ◀ / ▼ button.
 - To view the previous image, press the ◀ button.
 - To view the next image, press the ▼ button.



Note:

- To exit [] Playback mode, press the **MODE** button.
- The [] print indicator only appears on the LCD monitor when the image is set to print out.
- If there is no image stored in the internal memory or on the memory card, [No Image] message will appear on the LCD monitor.
- During playback, the recorded image appears to be larger than the one on preview in capture mode.

Magnifying Images

While reviewing your images, you may enlarge a selected portion of an image. This magnification allows you to view fine details.

1. Press twice the MODE button to enter [▶] Playback mode.
 - The last image frame appears on the LCD monitor.
2. View and select your images by using the ◀ / ▶ button.
3. Enlarge the image by pressing the OK button.
 - Pressing the OK button once magnifies the image to 2X.
4. Use the ▲ / ▼ / ◀ / ▶ button to select the area to enlarge.
5. To return to the regular display from 4X-enlarged status, press the OK button.







Note:

- Each press of the OK button, the modes switch cyclically:
1X → 2X → 3X → 4X → 1X.



Viewing Nine Images At A Time

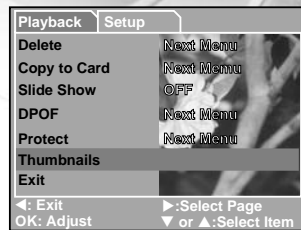

This function allows you to view nine thumbnail images on the LCD monitor simultaneously so that you can quickly scan for a particular image.

1. Press twice the MODE button to enter [] Playback mode.
2. Press the MENU button.
3. Use the  /  button to select [Thumbnails].
4. Press the OK button and nine thumbnail images appear on the LCD monitor.
(Assuming there are nine or more recorded images in the memory.)
5. Use the  /  /  /  button to move the cursor to select the image to be displayed at regular size.
6. Press the OK button to display the selected image on the full screen.



Viewing Video Clips





To view the recorded video clips, follow the steps below:

1. Press twice the **MODE** button to enter [] Playback mode.
2. Select the video clip that you want to view by using the  /  button.



Automated Playback (Slide Show)

Slide show function enables you to play your images back automatically in sequential order as a slide show. This is a very useful and entertaining feature reviewing recorded images and for presentations.

1. Press twice the **MODE** button to enter [] Playback mode. Then press the **MENU** button to enter the Playback menu.
2. Select [Slide Show] by using  /  button then press the **OK** button to enter the sub-menu.
3. Set the playback interval by using the  /  button and press the **OK** button to confirm.
 - The slide-show starts displaying your images on the LCD monitor, one by one, with the interval that you set.
 - To stop the slide-show display, press the **OK** button.

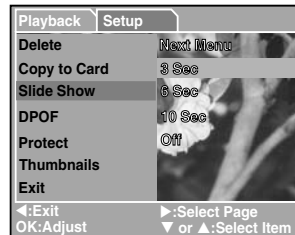

Note:

- To not set automated playback (slide show) you may press the **MENU** button to exit.

Protecting Images

This feature allows you to prevent recorded images from being accidentally erased.

1. Press twice the MODE button to enter [] Playback mode. Then press the MENU button to enter the Playback menu.
2. Select [Protect] by using the ▲ / ▼ button, and press the OK button.
3. You can select to protect single image or all images at one time by using the ▲ / ▼ button , and press the OK button.
 - [Single]: Protect one image at one time
 - [All]: Protect all images at once
4. Select [Unlock] or [Lock] by using the ▲ / ▼ button.
 - [Unlock]: Unlock the protected image.
 - [Lock]: Protect the selected image or all images.
5. Press the OK button again to confirm the setting.



DELETING IMAGES

Deleting Images/Video Clips Singly

You can delete a captured image or a recorded video clip at a time.

1. Press continuously the **MODE** button to enter [▶] Playback mode.
 - The last image frame appears on the LCD monitor.
2. View and select unwanted images by using the ◀ / ▼ button, then press the **MENU** button.
3. Select [Delete] by using the ▲ / ▼ button, and press the **OK** button.
4. Use the ▲ / ▼ button to select [Single], and press the **OK** button.
5. Use the ▲ / ▼ button to select [Execute] and press the **OK** button to confirm the deletion. To cancel the action, select [Cancel].
6. Continue the deletion if necessary.
 - If all images are deleted, [No Image] will pop up.
 - To exit the deletion, press the **MODE** button again.

Note:

- Please be aware of that deleted images cannot be recovered. Exercise adequate caution before deleting a file.
- Protected images cannot be deleted with the delete function.

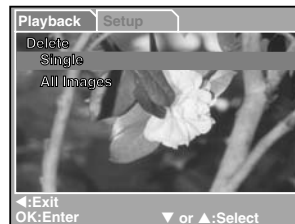

Deleting All Images/Video Clips

1. Press twice the MODE button to enter [] Playback mode. Then press the MENU button to enter the Playback menu.
2. Select [Delete] by using the ▲ / ▼ button, and press the OK button.
3. Use the ▲ / ▼ button to select [All Images], and press the OK button.
4. Use the ▲ / ▼ button, then select [Execute] and press the OK button to confirm the deletion. To cancel the action, select [Cancel].

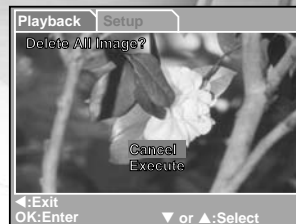

Note:

- Please be aware of that deleted images cannot be recovered. Exercise adequate caution before deleting a file.
- Protected images cannot be deleted with the delete function.
- If SD memory card is inserted; images and video clips recorded on the memory card will be deleted first.

Formatting an SD Memory Card or Internal Memory

This utility formats the internal memory (or memory card) and deletes all stored images and data.

1. Press the MENU button to enter [Setup] in any mode.
2. Select [Format] by using the ▲ / ▼ button. Press the OK button to enter the sub-menu.
3. If you want to format the SD memory card or the internal memory choose [Execute] by pressing ▲ / ▼ button, then press the OK button to confirm.
 - To cancel the action, select [Cancel].
 - [No Image] pops up after the SD memory card or the internal memory has been formatted.

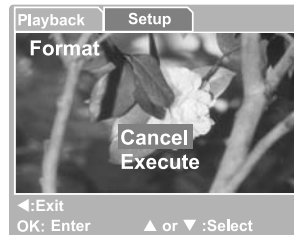

Note:

- Be sure the SD memory card is properly inserted into the camera before formatting it.
- To format images or video clips recorded in the internal memory, be sure to remove your SD memory card first.
- For complete compatibility, be sure NOT to select FAT 32 as the file system when you format the SD card on your computer. Memory cards formatted in FAT 32 file system will not be recognized by this camera.

SETTING THE DPOF

DPOF (Digital Print Order Format) allows you to embed printing information on your SD memory card.

By using DPOF, you can select an image to be printed and then specify how many prints or which image you would like. Take your SD memory card to a DPOF enabled printer or through laboratory printing services that accept memory cards. The DPOF/card-compatible printer will read the embedded information on the memory card and print your images as specified.

To Set DPOF:

1. Press twice the MODE button to enter [] Playback mode. Then press the MENU button to enter the Playback menu.
2. Select DPOF by using the ▲ / ▼ button, and press the OK button.
3. Select [Single] or [All] with the ▲ / ▼ button, and press the OK button.

The DPOF sub-menu options:

[Single]: Sets DPOF for each individual image.

[All]: Sets DPOF for all images at once.

4. Select [Print Num.] with the ▲ / ▼ button, and press the OK button.
5. Set the number of prints with the ▲ / ▼ button, and press the OK button.
You can set up to 9 prints for each image.
6. Select [Print Enable Execute] with the ▲ / ▼ button, and press the OK button. This creates a file containing the DPOF information. When the operation is finished, the screen returns to the playback screen.

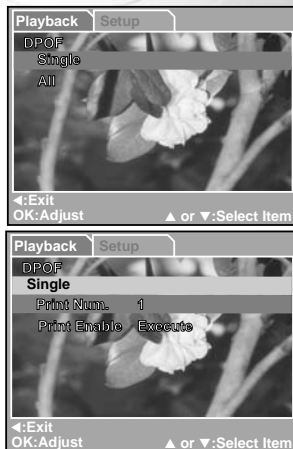

Note:

- To print out images recorded in the internal memory, it is necessary to copy your images to an SD memory card first.
- [] Print-order icon will also display on the LCD monitor to indicate selected images for printing.

TRANSFERRING RECORDED IMAGES/VIDEO CLIPS TO YOUR COMPUTER

You can share recorded images/video clips with your family or friends via e-mail or post them on the Web. Before doing these things, you need to connect the camera to your computer using the USB cable and then transfer the images/video clips.

To transfer images/video clips from the camera to your computer, follow the steps below:

Step 1: Installing the USB driver

Step 2: Connecting the camera to your computer

Step 3: Downloading images/video clips

	System Requirements (Windows)	System Requirements (Macintosh)
CPU	Pentium III 600 MHz processor or higher	PowerPC G3/G4
OS	Windows 98/98SE/ME/2000/XP	9.0 or higher
Memory	32MB (64MB RAM recommended)	32MB (64MB RAM recommended)
Free Space on Hard Disk	128MB hard disk space	128MB hard disk space
Required Devices	A CD-ROM Drive, An available USB port	A CD-ROM Drive, An available USB port
Color Monitor	Color Monitor (800x600, 24-bit or higher recommended)	Color Monitor (800x600, 24-bit or higher recommended)

Step 1: Install the USB Driver

■ Installation on Windows 98 & 98SE

The USB driver on the supplied CD-ROM is exclusively for Windows 98 and 98SE. Windows 2000/ME/XP users should not install the USB driver.

1. Insert the enclosed CD-ROM into your CD-ROM drive.
2. When the welcome screen appears, click "Install USB Driver". Follow the on-screen instructions to complete the installation.
3. After the USB driver has been installed, restart your computer.

■ Installation on MAC OS 9.0

For Mac OS 9.0 or higher, the computer will automatically recognize the digital camera and load its own USB drivers.

Step 2: Connecting the Camera to Your Computer

1. Turn the camera on.
2. Connect one end of the USB cable to an available USB port on your computer.
3. Connect the other end of the USB cable to the USB terminal on the camera.
4. The [USB] mode screen is displayed. Use ▲ / ▼ to select [Disk Drive], then press the OK button.
5. Look for a new "Removable Disk" icon appearing in the "My Computer" window. Your recorded images/video clips will be in a folder on this "removable disk". (For Mac users, double-click the "untitled" disk on the desktop.)

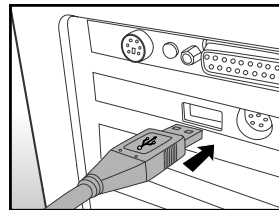

Step 3: Downloading Recorded Images/Video Clips

When the camera is turned on and connected to your computer, it is considered to be a disk drive, just like a floppy disk or CD. You can download (transfer) images by copying them from the “removable disk” (“untitled” disk on a Macintosh) to your computer hard disk.

For Computers Running Windows

Open the “removable disk” by double clicking on it. Double click on the folder contains your recorded images/video clips. Select the images/video clips that you prefer and then choose “Copy” from the “Edit” menu. After that, open the destination location and choose “Paste” from the “Edit” menu.

For Computers Running Mac OS

Open the “untitled” disk window and the hard disk or the destination location. Drag and drop from the camera disk to the desired destination.

Note:

- Memory card users may prefer to use a memory card reader (highly recommended).

SOFTWARE INSTALLATION

Installing Photo Explorer

Ulead® Photo Explorer provides a simple and efficient way to transfer, browse, modify and distribute digital media. Acquire photos, video or sound clips from various digital device types and easily browse or add personal descriptions; make timely modifications; or distribute the media through the medium of your choice: E-mail, Print, Slideshow Presentations. It is an indispensable all-in-one tool for owners of digital cameras, WebCams, DV camcorders, scanners, or anyone who strives to effectively organize a large collection of digital media.

1. Insert the enclosed CD-ROM into your CD-ROM drive.
2. When the welcome screen appears, click "Install Ulead® Photo Explorer". Follow the on-screen instructions to complete the installation.

Note:

- For more information about the operation of Photo Explorer application software, refer to its respective help documentation.
- For Windows 2000/XP users, please make sure to install and use the Photo Explorer in "Administrator" mode.
- Photo Explorer is not supported on the Mac. iPhoto or iPhoto2 is recommended.

Installing Photo Express

Ulead® Photo Express is complete photo project software for digital images. The step-by-step workflow, visual program interface, and in-program help assist users in creating exciting photo projects. Acquire digital photos effortlessly from digital cameras or scanners. Organize them conveniently with the Visual Browse mode. Use hundreds of ready-to-use templates such as albums, cards, posters, slideshows, and more. Edit and enhance images with photo editing tools, photographic filters, and special effects. Embellish projects by adding creative design elements such as frames, callouts, and stamp objects. Share results with family and friends via e-mail and multiple print options.

1. Insert the enclosed CD-ROM into your CD-ROM drive.
2. When the welcome screen appears, click "Install Ulead® Photo Express". Follow the on-screen instructions to complete the installation.

Note:

- For information on how to use Photo Express to edit and retouch your recorded images, please refer to its online help.
- For Windows 2000/XP users, make sure to install and use the Photo Express while logged in as a user with an Administrator account.

USING THE DIGITAL CAMERA AS A PC CAMERA

Your digital camera can act as a PC camera, which allows you to videoconference with business associates, or have a real-time conversation with friends or family. To use the digital camera for videoconferencing, your computer system must include the items as below:

- Microphone
- Sound card
- Speakers or headphones
- Network or Internet connection

Note:

- Video conferencing (or video editing) software is not included with the digital camera.
- This mode is not supported for Mac.

Step 1: Install the PC camera driver

The PC-camera driver included in the CD-ROM is exclusively for Windows. The PC camera function is not supported for Mac platforms.

1. Insert the enclosed CD-ROM into your CD-ROM drive.
2. When the welcome screen appears, click "Install USB Driver". Follow the on-screen instructions to complete the installation.
3. After the driver installation is completed, restart your computer.

Step 2: Connect the digital camera to your computer

1. Turn on the power of the camera.
2. Connect one end of the USB cable to an available USB port on your computer.
3. Connect the other end of the USB cable to the USB terminal on the camera.
4. The [USB] mode screen is displayed.
5. Use ▲ / ▼ to select [Pc Cam], then press the OK button.
6. The message "Connected to computer" will appear on the screen. Wait for the message to disappear before using application software.
 - * The LCD monitor will turn off automatically for the purpose of power-saving.
7. Position the digital still camera steadily on top of your computer monitor or use a tripod.



Note:

- When using this digital camera as a PC camera, it is necessary to install the battery into the digital camera.

Step 3: Run your application software (i.e. Windows NetMeeting)

To use Windows NetMeeting for videoconferencing:

1. Go to Start → Programs → Accessories → Communications → NetMeeting to launch the NetMeeting program.
2. Click the Start Video button to view live video.
3. Click the Place Call button.
4. Type the e-mail address or the network address of the computer that you are calling.
5. Click Call. The person that you are calling must also have Windows NetMeeting running and be willing to accept your call to start the videoconference.

Note:

- The video resolution for videoconferencing applications is generally 320 x 240.
- For more information about the operation of videoconference application software, refer to its respective help documentation.

LIST OF MENU OPTIONS

Capture Menu

This menu is for the basic settings to be used when taking still images.

1. Press the **MENU** button and then scroll through the options by using the ▲ / ▼ button.
2. Press the **OK** button to enter the sub-menu.
3. After entering the sub-menu, select your option by using the ▲ / ▼ button.
4. Press the **OK** button to confirm the setting.
5. To exit from the menu mode, use the ▲ / ▼ to select [Exit] and press the **OK** button.

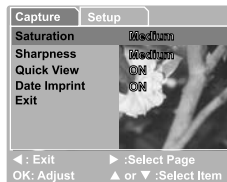

Size

This sets the size of the image that will be photographed.

[3072 x 2304]: 3072 x 2304 pixels

[2560 x 1920]: 2560 x 1920 pixels

[2048 x 1536]: 2048 x 1536 pixels

[1280 x 960]: 1280 x 960 pixels

[640 x 480]: 640 x 480 pixels

Quality

This sets the quality (compression rate) at which the image is taken.

[Fine]: Low compression rate

[Normal]: Normal

[Economy]: High compression rate

Scene

This sets the scene mode for capturing images.

[Auto]: The camera automatically adjusts the focus and exposure settings to take photographs.

[Sports]: Select this option to take photographs of fast-moving subjects.

[Night Scene]: Select this option to take photographs of people against a dusk or night-time background.

[Portrait]: Select this option to make people stand out with the background out-of-focus.

[Landscape]: Select this option to take photographs of distant scenery or landscapes.

[Backlight]: Select this option when you want to capture images when the light comes behind the object.

EV

Your camera adjusts the exposure each scene automatically. However, when the subject is too dark or too bright, the camera adjusts the brightness or darker. This is called EV compensation.

The EV compensation of your camera can be adjusted from [-2.0 EV] to [+2.0 EV] (0.5 EV step).

To adjust EV, press the ▲ / ▼ button and press the **OK** button to confirm.

Effective Subjects and Set Values

Positive (+) Compensation

- Copying of printed text (black characters on white paper)
- Backlit portraits
- Very bright scenes (such as snowfields) and highly reflective subjects
- Shots made up predominantly of sky

Negative (-) Compensation

- Spot lighted subjects, particularly against dark backgrounds
- Imaging of printed text (white characters on black paper)
- Scenes with low reflectivity, such as shots of green or dark foliage

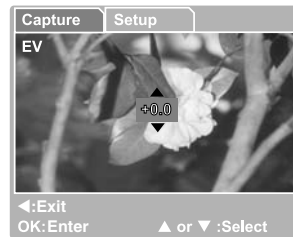

White Balance

When the brightness of the light changes, our eyes adapt the difference so that the white object remains white. For digital still cameras, they can also see the white object as white by averaging the light around the subject.

The camera determines the white balance by averaging the various kinds of light that actually enters the lens. You may set in advance the white balance when taking photographs under specific lighting conditions.

- [Auto]: Automatically adjusting the white balance.
- [Daylight]: For recording outdoors on a bright day.
- [Cloudy]: For recording overcast, shaded, twilight or evening skies.
- [Tungsten]: For recording under tungsten lighting condition.
- [Fluorescent]: For recording under fluorescent lighting condition.

ISO

Select the photographic ISO to be used when a photograph is taken.

The higher the ISO sensitivity value, the greater sensitivity, but the greater the noise. With a higher sensitivity selected, bright photographs can be taken with less light.

[Auto]: Automatic adjustment

[100]: Sensitivity equivalent to ISO100

[200]: Sensitivity equivalent to ISO200

Color

To capture an image, the camera offers three types of color (Full color/ Black & White/ Sepia) for you to match as your wish. Your images will demonstrate different impression by choosing different types of color.

[Full color]: Bright colors

[Sepia]: Sepia

[Black & White]: Monochrome

Saturation

To capture an image, the camera offers you three different degrees of color (High/Medium/Low) to match your preference. Your images will give a different impressions by choosing the different degrees of color. This is called Saturation.

Sharpness

Your camera will automatically emphasise the borders between light and dark areas of the image. This will make the image's edges look sharper.

- [High]: Hard touch
- [Medium]: Normal touch
- [Low]: Soft touch

Quick View

Set to display a photographed image on LCD monitor immediately after you have taken the shot.

- [ON]: Display quick view
- [OFF]: Do not display quick view

Date Imprint

If you set imprint function, your image will be displayed with date on it.

- [ON]: Date will be showed on the captured image.
- [OFF]: Date will not be showed on the captured image.

Exit

Select this option if you wish to exit from the menu mode.

Playback Menu

Use the Playback menu you can create an on-camera slide show or configure DPOF settings. You may also delete one or all stored images, format your SD memory card or the internal memory.

1. Press MODE button twice to enter [] Playback mode.
Then press the MENU button to enter Playback menu.
Scroll through the options by using the ▲ / ▼ button.
2. To enter the sub-menu, press the OK button. After settings are set, press the OK button to confirm.

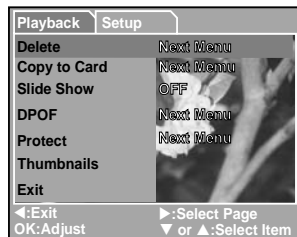

Delete

Delete still images and video clips that have not come out right.
Refer to section in this manual titled “Deleting Images/Video Clips” in DELETING IMAGES for further details.

Copy to Card

This feature allows you to copy your images/video clips from the camera’s memory.
This functions is enabled when the SD memory card is loaded and the internal memory contains images/video clips.

Slide Show

Automatically plays back still images in order one image at a time.
Refer to section in this manual titled “Automated Playback (Slide Show)” in IMAGE PLAYBACK for further details.

DPOF

Set the number of prints in the DPOF format to images that you want to print. (This function is available for still images only.)
You can print images easily just by inserting the SD card to a DPOF-compatible printer or a print shop.
Refer to section in this manual titled “SETTING THE DPOF” for further details.

Protect

Set the data to read-only to prevent images from being erased by mistake.
Refer to section in this manual titled “Protecting Images” in IMAGE PLAYBACK for further details.

Thumbnails

This feature allows you to view 9 thumbnail images on the LCD monitor at the same time.

Exit

Select this option if you wish to exit from the menu mode.

Video Menu

This menu is for the basic settings to be used when recording video clips.

EV

Refer to section in this manual titled “Capture Menu” in LIST OF MENU OPTIONS for further details.

White Balance

Refer to section in this manual titled “Capture Menu” in LIST OF MENU OPTIONS for further details.

Exit

Select this option if you wish to exit from the menu mode.

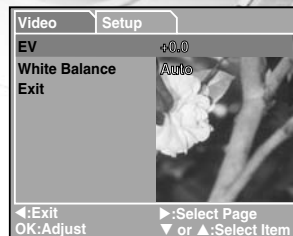

Setup Menu (in Capture/Video/Playback Menu)

You can select according to your preference for the camera settings in Setup of Capture/Video/Playback Menu. Navigate the options you wish to configure by using the ▲ / ▼ button.

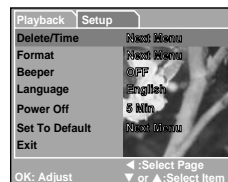
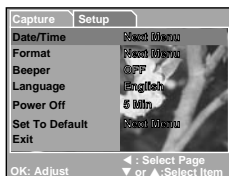

Date/Time

This sets the date and the time.

Refer to section in this manual titled "Setting the Date and Time" for further details.

Format

This utility formats the internal memory (or memory card) and erases all stored images and data.

Refer to section in this manual titled "Formatting an SD Memory Card or Internal Memory" for further details.

Beeper

Specify whether or not beeps are to be generated when buttons are pressed.

[ON]: Beeps are generated

[OFF]: Beeps are not generated

Language

Specify in which language menus and messages are to be displayed on the LCD monitor.

Power Off

If no operation is performed for a specific period of time, the power to the camera is automatically turned off. This feature is useful to reduce battery wear.

[3 Min], [5 Min], [10 Min], [30 Min], [OFF]

Set to Default

This function will restore all the parameters to the default settings.

[Cancel]: Remain the current settings

[Execute]: Reset to default settings

Exit

Select this option if you wish to exit from the menu mode.

CAMERA SPECIFICATIONS

Item	Description
Sensor	Approx. 5.0 Mega pixels
Image resolution	Still image: 3072 x 2304 (7MP, by interpolation) 2560 x 1920 (5MP, native resolution) 2048 x 1536 1280 x 960 640 x 480 Video clip: 320 x 240
Image quality	Fine/Normal/Economy
Recording media	16 MB internal memory (14 MB available for image storage) SD memory card (optional, up to 1 GB)
Lens	Aperture: 3.0 Focal length: 6.17mm
Range of focus	Macro: 0.6m - 1.14m Normal: 1.12m - infinity
LCD monitor	1.7" TFT color LCD
Self-timer	5-second/10-second delay
Zoom	4X digital zoom
Exposure compensation	Automatic exposure with manual EV compensation +/-2.0EV in 0.5EV steps
White balance	Automatic with presets for Daylight, Cloudy, Tungsten, Fluorescent
File format	EXIF 2.2, DCF 1.0, DPOF 1.0, MPEG-1
Interface	DC IN 5V terminal USB terminal
Operating environment	Operation: -5°C ~40°C, 15% ~90% humidity Storage: -20°C ~60°C, 10 %~95% humidity
Power supply	Lithium ion rechargeable battery (650mA) AC-DC Adapter
Dimensions	Approx. 89.5 x 56 x 24mm (without protruding parts)
Weight	Approx. 80g (without batteries and the SD memory card)

* Design and specifications are subject to change without notice.



TROUBLESHOOTING

Refer to the symptoms and measures listed below before sending the camera for repairs. If the problem persists, contact your local reseller or service center.

Power Supply

Symptom	Cause	Measure
The power does not come on.	The battery is not loaded.	Load the battery correctly.
	The battery is exhausted.	Recharge or use the AC power adapter.
The power cuts out during use.	The camera was left unattended and unused, so the auto power off cuts it off.	Turn the power back on.
	The battery is exhausted.	Recharge or use the AC power adapter.
The power does not go off.	Camera malfunction.	Reload the battery. If using the AC power adapter, reconnect it.
The battery runs out quickly.	It is being used in extreme low temperature.	
	Many shots are being captured in dark places inside, requiring flash.	
	The battery is not fully charged. The battery is not used for an extended period of time after charged.	Fully charge the battery and discharge it for at least one complete cycle before use to maximize its performance and lifetime.
The battery or camera feels warm.	Long period of continuous use of the camera or the flash.	

Shooting

Symptom	Cause	Measure
Even if I press the shutter button, the camera does not shoot.	The battery is running low.	Recharge or use the AC power adapter.
	The power is not on.	Turn the power on.
	The camera is not in shooting mode.	Toggle the MODE button to shooting mode.
	The shutter button is not pressed all the way.	Press the shutter button all the way.
	The internal memory or memory card does not have any free space.	Load a new card, or delete unwanted files.
	End of memory card life.	Load a new memory card.
	The flash is recharging.	Wait until the flash recharging process is completed.
	The memory card is unrecognized by the camera.	Format the memory card in this camera before its first use or when it was used other than this camera.
	The auto power off function is activated.	Turn the power on again.
Images do not appear on the LCD monitor.	The power is not on.	Turn the power on.
The camera does not focus.	The lens is dirty.	Wipe clean with a soft, dry cloth or lens paper.
	The distance to the subject is smaller than the effective range.	Get your subject within the effective focus range.
The flash does not fire. The flash cannot recharge.	The camera is set to  /  mode.	Switch to another mode other than one of those.
	The flash is set to no flash.	Set the flash to auto flash.
Even though the flash fired, the image is dark.	The distance to the subject is greater than flash effective range.	Get closer to your subject and shoot.
The image is too dark.	The image was captured in a dark place while set to no flash.	Set the flash to auto flash.
	It is under-exposed.	Set the exposure compensation to a larger value.
The image is too bright.	It is over-exposed.	Set the exposure compensation to a smaller value.
The image lacks natural color.	The image was captured in conditions that are hard for Auto White Balance to adjust to.	Add a white object to the composition.

Playback

Symptom	Cause	Measure
Cannot playback.	It is not set to playback mode.	Toggle the MODE button to playback mode.
The contents of memory card cannot be replayed.	You played back a memory card that was not formatted by this device.	Loaded a card that was formatted and stored on by this device.
Files cannot be deleted.	You played back a memory card that was not formatted by this device.	Loaded a card that was formatted and stored on by this device.
Cannot format a memory card.	The memory card is write-protected.	Remove the write-protection.
	End of memory card life.	Load a new memory card.

Other Problems

Symptom	Cause	Measure
Cannot load the memory card.	The card is facing the wrong way.	Load correctly.
Even when the camera's buttons are pressed, it does not operate.	The battery is running low.	Recharge or use the AC power adapter.
	Camera malfunction.	Turn the power off and remove the battery once, and try again.
The date and time is wrong.	The correct date and time is not set.	Set the correct date and time.

About connecting to your computer/software

Symptom	Cause	Measure
Cannot download images.	The free space on the hard disk in your computer may be insufficient.	Check whether the hard disk has a space for running Windows, and if the drive for loading image files has a capacity at least that of the memory card inserted in the camera.
	The USB driver is not installed (for Windows 98/98SE).	Install USB driver.