

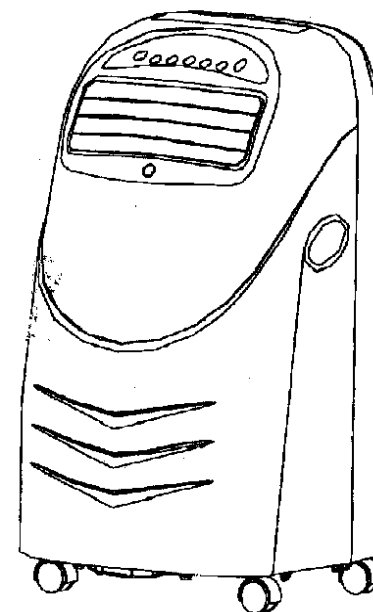

# Portable Air Conditioner Owner's manual

For ACP-1000E



Please read all the instructions carefully before use

# Contents

1. Safety instructions	
(1).Warning.....	2
(2).Precaution.....	3
(3).Maintenance.....	4
2. Parts list.....	
(1).Air conditioner and accessories.....	5
(2).Air conditioner control panel.....	6
(3).Remote controller.....	7
3. Operation instructions...	
(1).Starting the air conditioner for the first time operating modes and thermostat.....	8
(2).Setting the timer.....	9
(3).Adjusting the air flow.....	9
(4).Battery installation in the remote controller.....	10
(5).Emptying the auxiliary water tank.....	11-12
(6).Setting up the exhaust hose.....	13-14
4. Troubleshooting tips.....	15
5. Electrical diagram.....	16
6. Electrical specifications.....	17

## 1. Safety instructions

### Warning

- Connect the plug to an appropriate power outlet

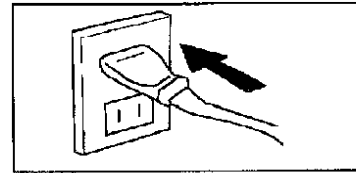

- Don't use the power supply cord as a substitute for the on / off button

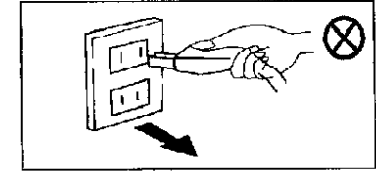

- Be careful not to damage the power cord, and don't use if the cord becomes damaged

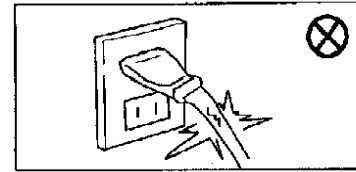

- Do not use an extension cord

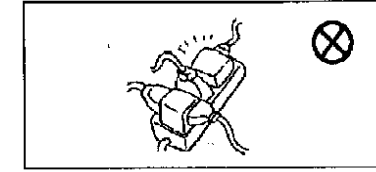

- Make sure your hands are clean and dry before operating the air conditioner

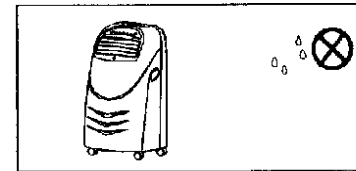

- To avoid injury, keep fingers and other objects out of the unit

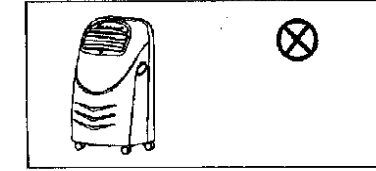

- Ensure that the air conditioner's ground wire is connected

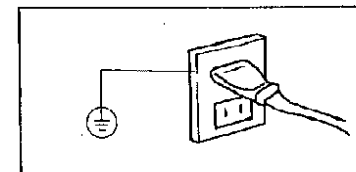

- Turn the unit off and disconnect the power plug if you notice smoke or an odd odor coming from the air conditioner

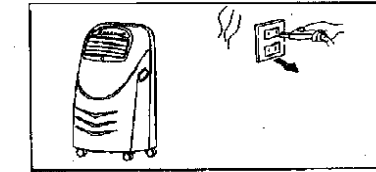

If the unit malfunctions, please contact the dealer or a professional repair center.

## 1. Safety instructions

### Precautions

- The air conditioner should be left in an upright position for at least two hours before using.
- The air conditioner shall be installed in accordance with national and local wiring regulations.
- Method of attachment of the supply cord is type Y. If the supply cord is damaged, it must be replaced by the manufacturer, its service agent, or a qualified repair person in order to avoid damage / voiding the warranty or bodily injury.
- Never use the unit in a place where there flammable gasses or chemicals are present.
- To prevent electromagnetic interference, place the air conditioner at least three feet away from radios or televisions.
- Hold the plug itself to connect or disconnect the power cord, never pull the power cord.
- If the unit will not be used for an extended period of time, disconnect the power cord and drain any water from the auxiliary water tank.
- Do not spray liquids directly onto the unit apply water or mild cleanser to the soft cloth that will be used to clean the air conditioner.
- The unit is not intended to support heavy objects, be used as a step-stool, or be shaken / bumped into. Keep this in mind when deciding where to place it within your room.
- Do not use harsh chemicals or cleansers on the air conditioner as it may cause the case to become warped or discoloured.
- If you choose to use the continuous drain function, be sure to have the condensation drain off into an appropriate receptacle.
- To insure adequate air circulation, place the air conditioner at least four inches away from walls and furnishings. Be careful of draperies or other items which may be drawn towards the intake vents and restrict the air flow.
- The air conditioner must be placed on a level, flat surface. Do not operate on an angle of more than 4°.

## 1. Safety instructions

### Maintenance

- To avoid electrical shocks, be sure to disconnect the power cord before cleaning the unit.
- Avoid using chemicals like benzene, alcohol, gas, or turpentine to clean the unit.
- We recommend that you clean the air filter every two months (more often if visibly soiled). Built up dust on the filter will decrease the air flow volume.
- How to remove the air filter from your air conditioner:
  1. Gently pull the air filter cover upwards
  2. Grasp the air filter and separate it from the cover

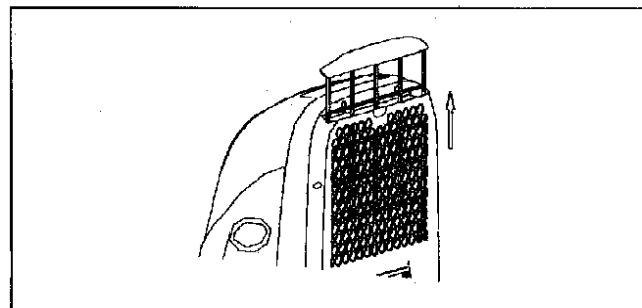

### Caution:

When cleaning the air filter, use warm water and a mild detergent only. Once it is washed, place it in a cool place and allow it to dry fully.

Remember that the external case should only be cleaned with a moist, soft cloth!

## 2. Parts List

Model: HP LaserJet FAX

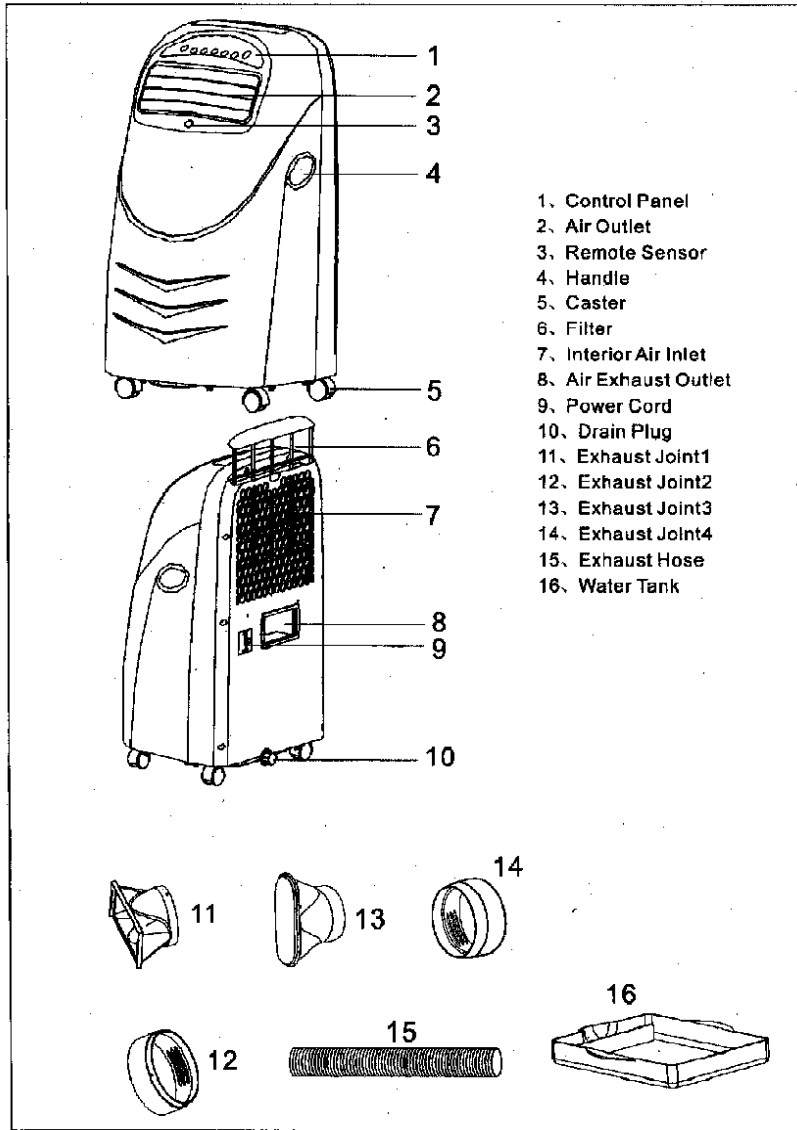

1. Control Panel
2. Air Outlet
3. Remote Sensor
4. Handle
5. Caster
6. Filter
7. Interior Air Inlet
8. Air Exhaust Outlet
9. Power Cord
10. Drain Plug
11. Exhaust Joint1
12. Exhaust Joint2
13. Exhaust Joint3
14. Exhaust Joint4
15. Exhaust Hose
16. Water Tank

## 2. Parts List

Display Panel

### Display Panel Icons

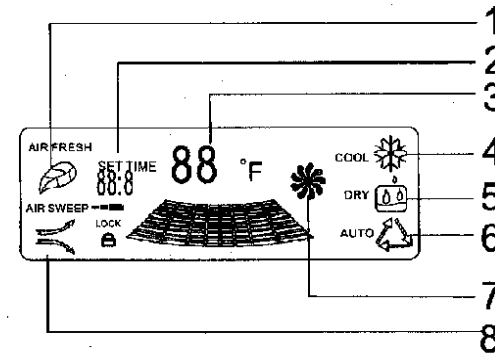

1. Fresh Air Icon (Ionizer)
2. Timer Icon
3. Temperature display  
(or, error code)
4. Cooling Icon
5. Dehumidification Icon
6. Auto-mode Icon
7. Fan / Speed Icon
8. Air Sweep Icon

### Control Panel Buttons

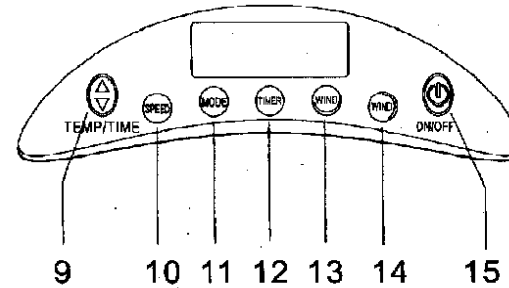

9. Temperature adjustment
10. Fan speed
11. Mode
12. Timer
13. Oscillation button1
14. Oscillation button2
15. On / Off

Note: Not all the controls will require adjustment, and some controls may be designed for other models.

## 2. Parts List

### Remote Control

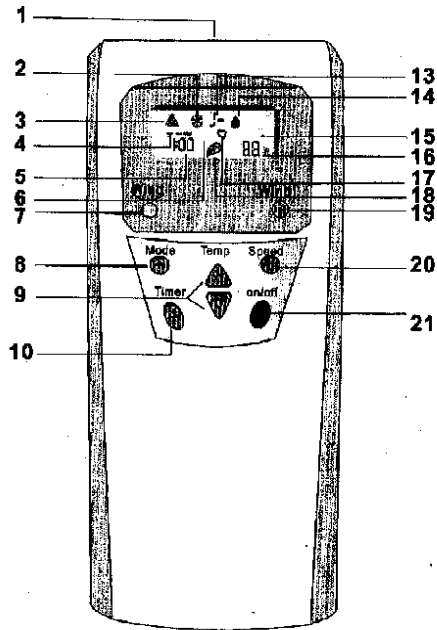

1. Display window
2. Cooling Icon
3. Auto-mode Icon
4. Output Icon
5. Time Display
6. Operation Icon
7. Oscillation button1
8. Mode button
9. Temperature button
10. Set Time button
11. Battery compartment
12. Battery cover
13. Fan Icon
14. Dehumidification Icon
15. Remote Signal
16. Temperature display
17. Oscillation Icon
18. Fresh Air Icon (Ionizer)
19. Oscillation button2
20. Fan speed button
21. Power button

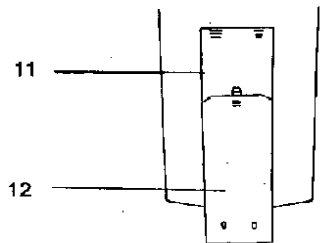

Remove the rear cover



Note: Not all the controls will require adjustment, and some controls may be designed for other models.

## 3. Operation instructions

1. When you first plug in the air conditioner, you will hear a tone indicating that the power is connected. Press the On button, the unit will start in Auto mode and will display the current room temperature.

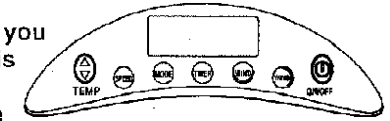

2. Select the Mode:  
Press the Mode button, it will cycle through the Auto, Fan, Cooling, and Dehumidifying options

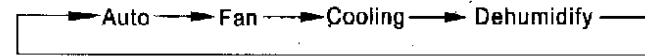

3. Adjust the Temperature:  
The temperature is adjustable between 60°F 88°F. Press the temperature button until the desired degree is displayed. The air conditioner will then cool to that temperature. Five seconds after setting your preferred temperature, the display will go back to showing the current room temperature.

4. Adjust Fan Speed  
Press the speed button to change the fan speed. You will cycle through the high, medium and low speed options.

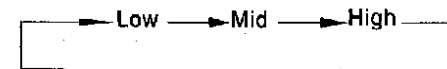

5. Turning off the unit  
When you press the Off button, the air conditioner will cease operation and you will hear a tone.
6. Fresh Air  
While the air conditioner is running, you can press the Fresh Air button to engage the built in Ion generator.

Note:  
While in dehumidification mode, the unit will automatically set the fan speed to low. It will not allow adjustment to the fan speed in this mode, nor will adjusting the temperature affect the operation.  
While in fan mode, adjusting the temperature will not affect the operation.  
If the unit is in standby mode, the remote control has a memory function. Your settings will be stored in the unit's memory, and when used next it will operate according to the last settings. Only the timer function will need to be reset (if you are using that function).

### 3. Operation instructions

---

#### Setting the timer function:

- While the unit is operating, press the Timer button. You will enter the time that you wish the unit to shut down. Then you will have the option of setting the time for the air conditioner to resume function (from half an hour to 12 hours, in half hour increments) or exiting the timer function.
- While the unit is in standby mode, you can also press the Timer button to set the operation times. You will begin by entering the time at which you want the air conditioner to begin working, and then you will be able to program the time at which you want the unit to go back into standby mode (from half an hour to 12 hours, in half hour increments) or exit the timer function.

Note: While in the set timeframe, the air conditioner will display a countdown of the time remaining until the next mode is initiated.

- **Adjusting the Airflow:**  
To have the airflow oscillate from ceiling to floor, press the oscillation button on the remote control. Right to left air flow is adjusted by manual adjusting the louvers.

Note:  
when turn off the unit, VFD indicator appear OF , till the sweep shut down.

### 3. Operation instructions

---

#### Battery Installation:

1. Open the battery compartment by sliding down the battery cover panel.
2. Remove and discard old batteries, replace with new batteries
3. Put the battery cover panel back in place.

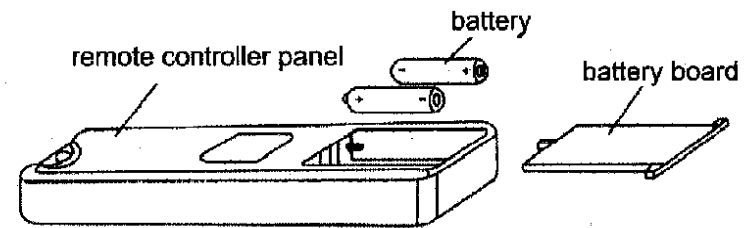

#### Notes:

1. The polarity of the batteries must match the indicator in the remote controller
2. Please don't mix new and old batteries in the remote controller
3. To prevent corrosion, remove the batteries if the controller will not be used over a lengthy period

### 3. Operation instructions

#### Drainage

While operating in cooling mode, condensation will form and the air conditioner will auto-evaporate this water. In unusually high humidity (over 80%) or while in dehumidification mode, more water will accumulate than the unit will be able to evaporate. In this case, the excess water will be collected in the auxiliary water tank. When this tank is filled, a buzzer will sound to alert the user that the water tank must be drained. An error code of E2 will also be shown on the display panel, indicating that the water tank is full. The unit will then shut down until the water tank is emptied.

#### Draining the water tank:

1. Turn off the unit
2. Place the square water collection container under the drainage hole.
3. Remove the drainage cap and rubber plug, allowing the water to flow out.
4. If the collection container fills before the tank is empty, reinsert the rubber plug into the drain, empty the container, replace it under the drain and remove the plug again. Repeat as needed until the tank is empty.
5. Reinsert the rubber plug and drainage cap.
6. Restart the air conditioner.

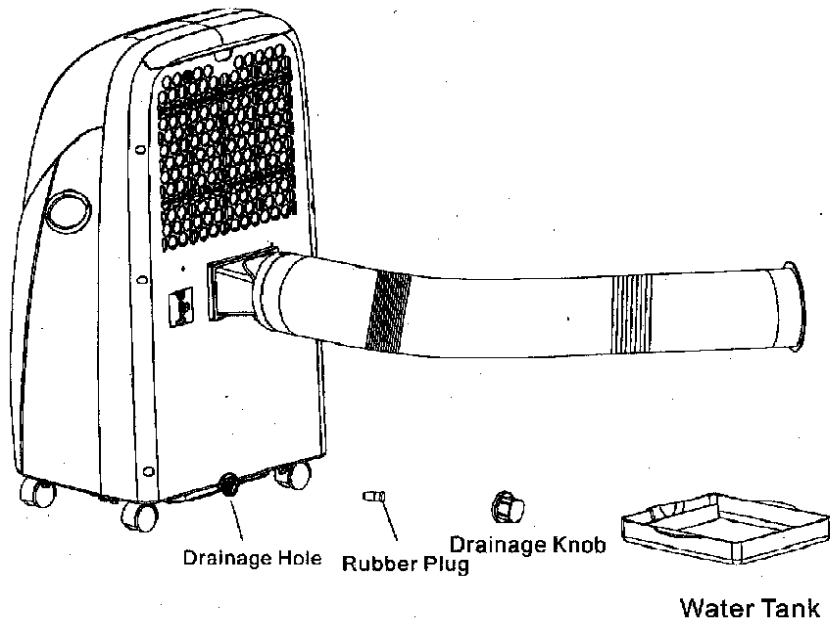

For usage in dehumidification mode or in high humidity situations, we recommend that you use the continuous drainage feature for this air conditioner.

1. Purchase an adequate length of soft plastic hose with  $\frac{3}{4}$ " internal diameter
2. Remove the drainage cap and rubber plug. Save these items for later use.
3. Connect the soft plastic hose to the drainage hole for continuous drainage.
4. Since the drain will rely on gravity to drain, the hose should be on a slight downward slope
5. The open end of the hose can drain into a large collection container, a water drain, or outdoors onto the ground.

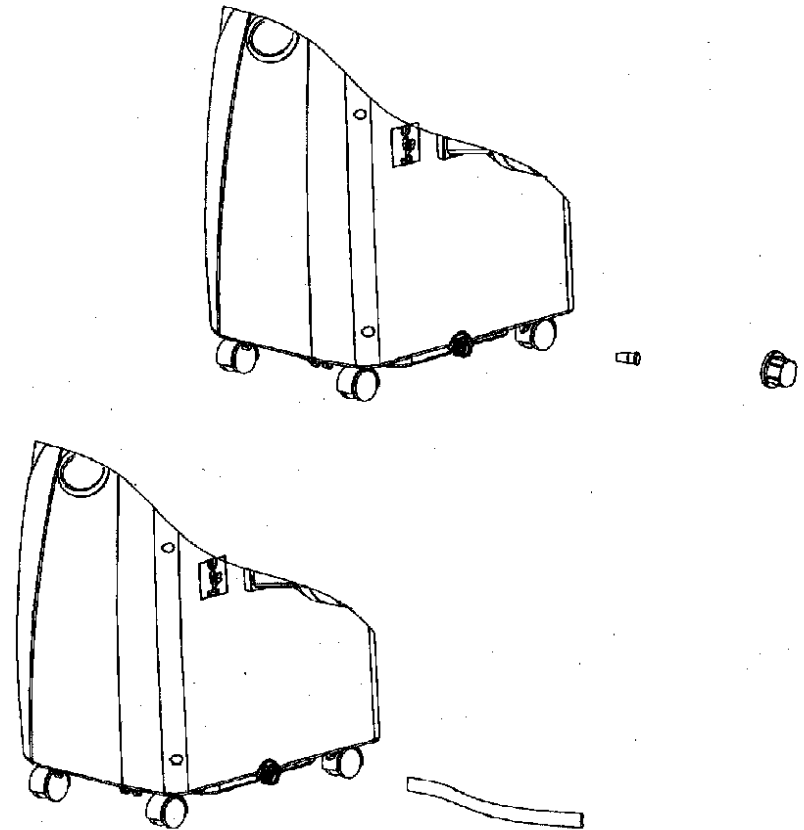

### 3. Operation instructions

#### Air Exhaust Hose

The hot air exhaust conducts the hot, moist air produced by the air conditioner away from the space that you are trying to cool. The window kit and exhaust hose can be moved along with the air conditioner from room to room.

1. Exhaust the hot air through a window or sliding glass door (window kit extension may be necessary)

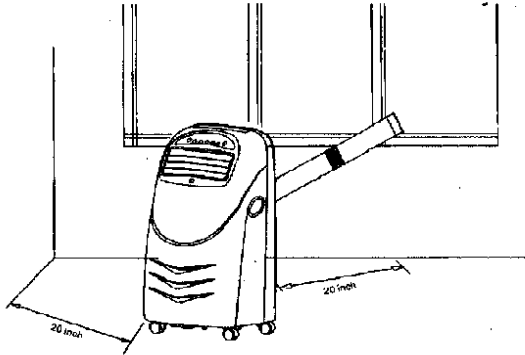

Open a window or sliding glass door, install the window kit, then connect the exhaust hose.

2. Exhaust the hot air through a custom opening through the wall or ceiling  
A custom opening can be cut in order to facilitate the exhaust hose if an existing window or sliding glass door cannot be used.

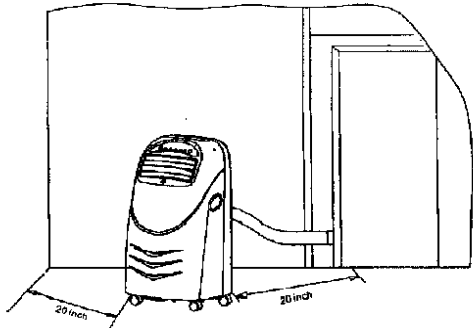

#### Note:

The hot air must be exhausted for this air conditioner to provide a cooling effect. When the air conditioner is not in use, please store the exhaust hose safely.

### 3. Operation instructions

#### Exhaust Hose

1. The exhaust hose can extend from 1.8 feet to 6.5 feet. The shorter the hose is, the better the cooling effect will be.

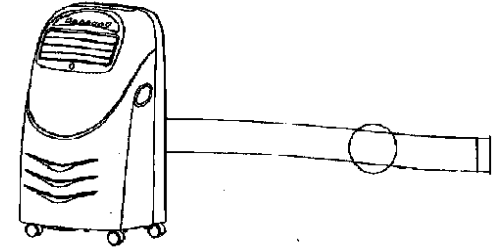

2. The hose should be as straight as possible, as sharp or unnecessary bends in the hose will prevent effective air-flow resulting in overheating and possible shut-down of the air conditioner.

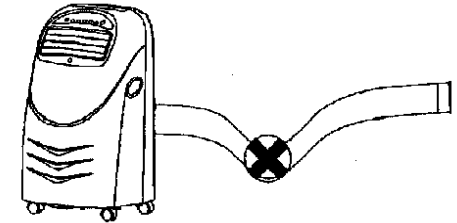
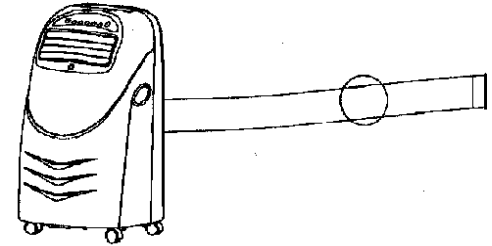

3. The length of the exhaust hose should not be extended beyond 6.5 feet. Replacement hoses are available for purchase through the vendor, we recommend that you use only New Air replacement parts.

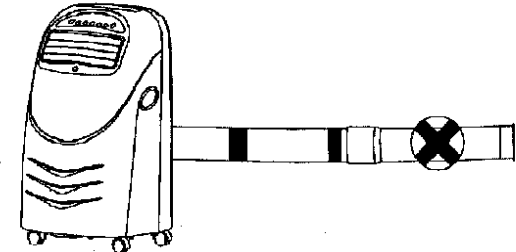



## 4、 Trouble Shooting

### Trouble Shooting on Air Conditioner

Before investing in repairs, double check the following:

Problems	Causes	Suggested Solutions
The unit doesn't work	<b>Power trouble</b> 1.The power cord is not plugged in 2.The circuit breaker has been tripped 3. There is something wrong with the socket or outlet 4.The fuse needs to be replaced or the power cord is damaged	1.Connect the power cord correctly 2.Reset the circuit at the breaker box 3.Change the socket or outlet 4.Take the unit to a qualified technician and have the fuse replaced (fuse specification: 3A/250V)
The unit stops working on its own	The timer has activated or the temperature in the room is lower than the set temperature	Turn the timer off or wait for the room temperature to rise
No cool air while in cooling mode	1.The room temperature is lower than the set temperature 2.The evaporator is frosted over	1.Normal operation 2.Allow the evaporator to defrost, it will then resume normal operation
No cool air while in dehumidifying mode	The evaporator is frosted, the unit is eliminating frost	After the evaporator defrosts, normal operation will resume
Error code E2 is displayed on the panel	The water tank is full	Empty the water tank and restart the unit
Error code E4 is displayed on the panel	The coil pipe is damaged	Replace the coil pipe
Error code E1 is displayed on the panel	1.The voltage is too high or too low 2.The unit is damaged	1.Restart when the voltage is normal 2.Take the unit for repair service

**Note:**

If the air conditioner needs repair, never service it by yourself. Please contact the dealer or a professional repair center for assistance.

## 5、 Electric Diagram

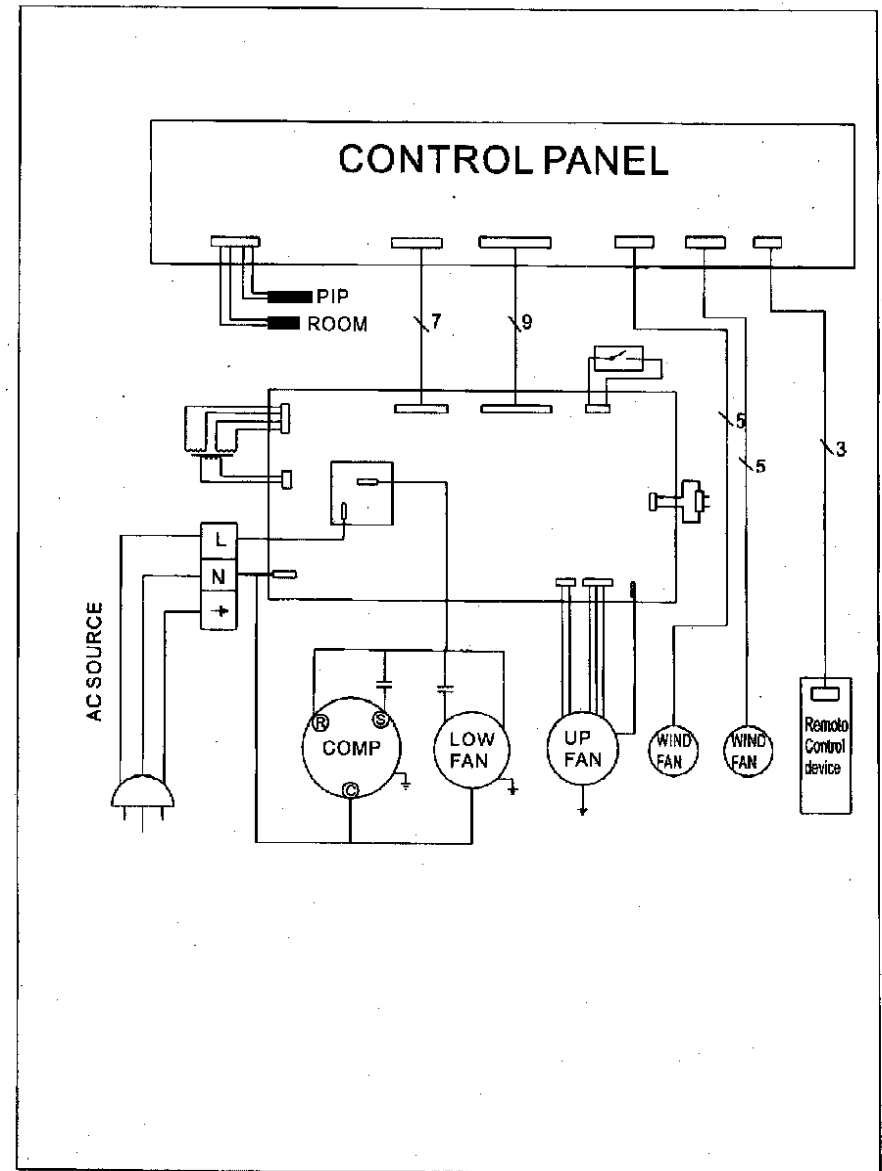

## 6. Technical Specification

Model Number		ACP-1000E
Cooling Capacity (Btu/h)		10000
Dehumidifying(Pints/day)		95
Power Supply		120V/60Hz
Power Consumption	Cooling	900W/7.8A
	Dehumidifying	750W/6.5A
Water Tank Capacity (Liter)		2L
Temperature Set Range		61°F-88°F
Noise Level(dB)		≤51
Unit Weight (Lb)		70
Unit Dimension (inch)		15.0x15.5x28.5
Refrigerant		R22(18.3oz)

### REMARKS:

The cooling capacity of the unit may be affected by the height of the ceiling, quality of insulation, number of windows, etc.