

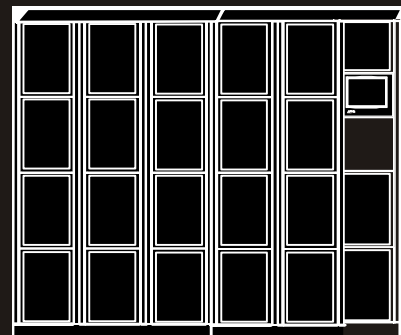

# Symmetra MW UPS

w/ Internal  
Bypass Static Switch

User  
Guide





# Contents

---

**Safety ..... 1**

**IMPORTANT SAFETY INSTRUCTIONS**  
**- SAVE THESE INSTRUCTIONS ..... 1**  
    Symbols used in this guide ..... 1  
    User Safety ..... 2

**UPS Display ..... 3**

**Display Symbols and Buttons. .... 3**  
    Navigation symbols ..... 3  
    Screen symbols ..... 3  
    Buttons ..... 4

**UPS Summary Screen. .... 5**

**Input Summary Screens ..... 6**

**Output Summary Screens ..... 7**

**Bypass Summary Screens. .... 8**

**Battery Summary Screens ..... 9**

**Operation Screen ..... 10**

**UPS Start-Up Screen. .... 11**

**UPS Shutdown screen ..... 12**

**Online to Static Bypass Screen. .... 13**

**Static Bypass to Online Screen. .... 14**

**Network Configuration Screens ..... 15**  
    Network Settings screen ..... 15  
    E-mail Settings screen ..... 16  
    SNMP Settings screen ..... 17  
    Remote Monitoring Service Settings screen ..... 18  
    APC ISX Manager Settings screen ..... 19

<b>User Configuration Screens</b> . . . . .	<b>20</b>
Touch-Screen Settings screen . . . . .	20
Password Settings screen . . . . .	21
Modbus Settings screen . . . . .	21
Regional Settings screen . . . . .	22
Battery Test screen . . . . .	22
<b>Event Log Screen</b> . . . . .	<b>24</b>
<b>Predictive Maintenance Screens</b> . . . . .	<b>25</b>
Inverter DC Capacitors screen . . . . .	25
Inverter AC Capacitors screen . . . . .	26
Top Fans screen . . . . .	27
Inverter Fans screen . . . . .	28
Main Static Switch Fans screen . . . . .	29

## **Operation Modes**..... **31**

<b>On-line Operation</b> . . . . .	<b>31</b>
<b>Battery Operation</b> . . . . .	<b>32</b>
<b>Bypass Operation</b> . . . . .	<b>33</b>
<b>Manual Bypass Operation</b> . . . . .	<b>34</b>
<b>System Start-Up from Manual Bypass Operation</b> . . . . .	<b>35</b>
System Start-Up from Manual Bypass to Online Operation of single mains/utility system - Step-by-Step . . . . .	36
System Start-Up from Manual Bypass to Online Operation of dual mains/utility system - Step-by-Step . . . . .	36
<b>System Shutdown from Online to Manual Bypass Operation</b> . .	<b>37</b>
System Shutdown from Online to Manual Bypass Operation of single mains/utility systems - Step-by-Step . . . . .	38
System Shutdown from Online to Manual Bypass Operation of dual mains/utility systems - Step-by-Step . . . . .	38
<b>Transfer from Online to Static Bypass Operation</b> . . . . .	<b>39</b>
<b>Transfer from Static Bypass to Online Operation</b> . . . . .	<b>40</b>

**Alarms/Troubleshooting .....41**

- Alarm Types ..... 41**
  - Info ..... 41
  - Warning ..... 41
  - Severe ..... 41
  - View active alarms ..... 42

**APC Symmetra MW Remote Display .....43**

- Starting web-based remote session ..... 44

**Warranty .....45**

- Factory Warranty ..... 45
- Life Support Policy..... 46

**Appendix A.....47**

- Air Filter Exchange ..... 47



# Safety

## IMPORTANT SAFETY INSTRUCTIONS - SAVE THESE INSTRUCTIONS

---

This guide contains important instructions that should be followed when handling the UPS, Battery Enclosures, and Batteries.

### Symbols used in this guide



#### **WARNING!**

Indicates an electrical hazard, which, if not avoided, could result in injury or death.



#### **CAUTION!**

Indicates a hazard, which, if not avoided, could result in injury or death.



#### **Note**

Indicates important information.



Indicates that more information is available on this subject in a different section of this manual.



#### **See also**

Indicates that more information is available on the same subject in a different manual.

## **User Safety**



**WARNING!**

**User functions: For safety reasons the user may only**  
- **Remove the finishing panels for air filter exchange**  
- **Operate the UPS display.**



**WARNING!**

**The UPS can be powered from more than one source.**



**CAUTION!**

The system is equipped with an optional auto-start function, enabling the system to start without any warning when power is applied.



**Note**

Typically, the UPS installation will be connected to an EPO (Emergency Power Off) button located on a wall near the entrance to the room. If activated, the EPO switches off power to the UPS, disconnects the UPS output, and switches off power to the entire room. This action will disconnect support to the load if the UPS is online.



# UPS Display

## Display Symbols and Buttons

---

### Navigation symbols



Home: Press to go to the UPS Summary screen.



Back: Press to go to previous screen.



Help: Press to access further details on current screen.



Page Up: Press to go to previous screen on same subject (only visible when there are more screens on the same subject).



Page Down: Press to go to next screen on same subject (only visible when there are more screens on the same subject).



Password logout: Press to log out from password protected screens.

### Screen symbols



Delta Inverter



Main Inverter

## **Buttons**



Press this button to switch ON the module.



Press this button to switch OFF the module.



EMO (Emergency Module OFF) button:  
Use in emergency situations to shut down the UPS. When the EMO button is engaged on the UPS, AC and DC input and output are disabled.

# UPS Summary Screen

The LCD touch-screen UPS display is the user interface. It is used to configure the UPS, monitor the system, and change the settings. The display also provides the user with audible and visual alarms.

The UPS display is organized hierarchically and the UPS Summary screen is the apex of the hierarchy. To navigate to the UPS Summary screen, touch the house icon in the upper right corner of the screen. The UPS Summary screen gives access to additional screens as shown below.

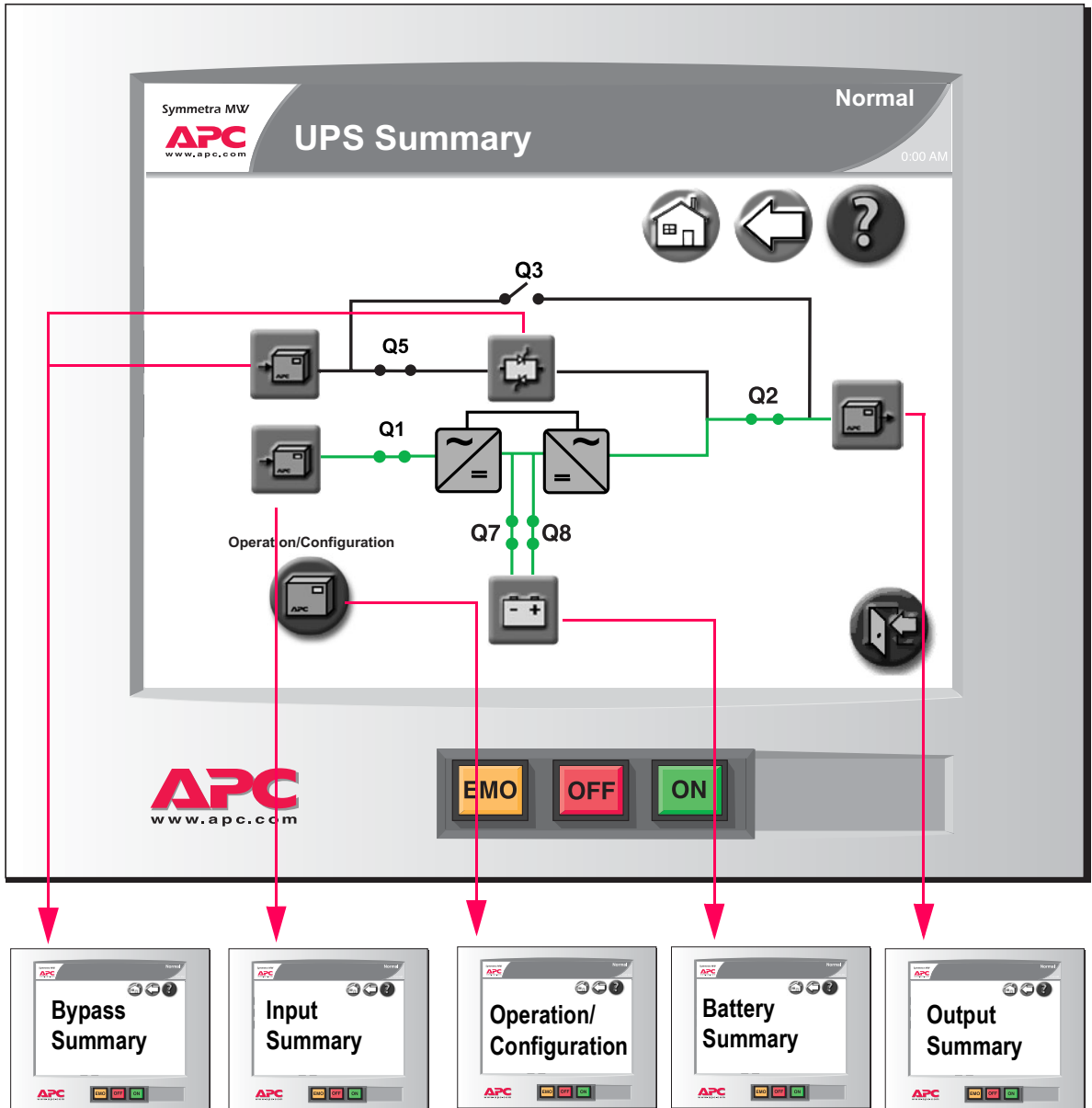

Note

The screens on the following pages are examples only. All values are not shown.

# Input Summary Screens

The three Input Summary screens provide input-specific status of voltage, power, current, frequency, etc.

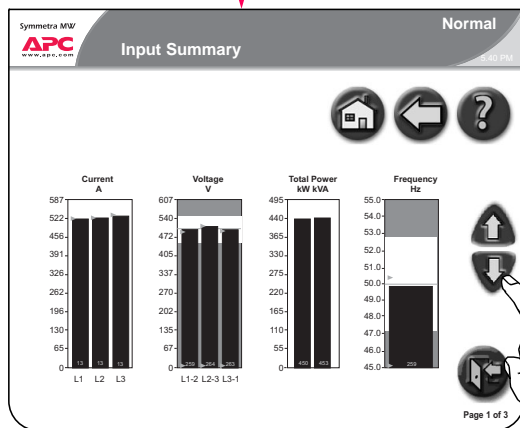
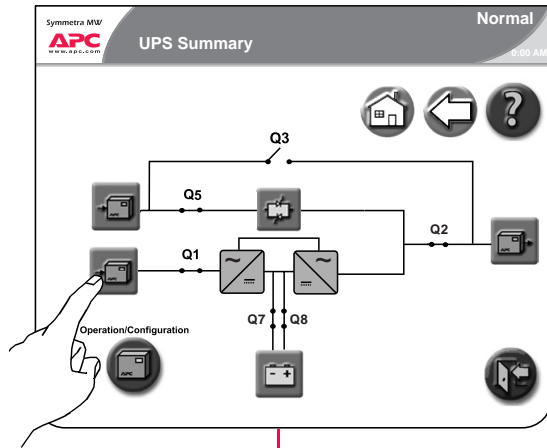

The black bars represent real-time data. Yellow triangles represent the maximum values recorded to date and blue triangles represent the minimum values recorded to date. These values will be reset when the input statistics are reset

The Input Summary screen displays detailed numerical data for Current, Voltage, Power, Frequency, and Temperature. A hand is shown interacting with the screen, specifically pointing to the Temperature data.

Current			Power			
	L1	L2	L3	L1	L2	L3
Current	22.6	17.4	12.4 A	410	410	402 kW
Current high	90.2	77.8	72.4 A	700	700	701 kW
THD	4.0	4.9	5.9 %	320	320	312 kVA
THD high	4.0	4.9	5.9 %	700	700	702 kVA
THD low	1.0	1.0	1.0 %	1.0	1.0	1.0
THD high	3.1	4.0	5.0 %	700	700	700 kW
THD low	3.0	3.9	4.9 %	518	518	518 kVA
Voltage tolerance	0.0	0.0	0.0 %			
Waveform tolerance			10 %			129 °F
Tolerance conditions			10 %			127 °F

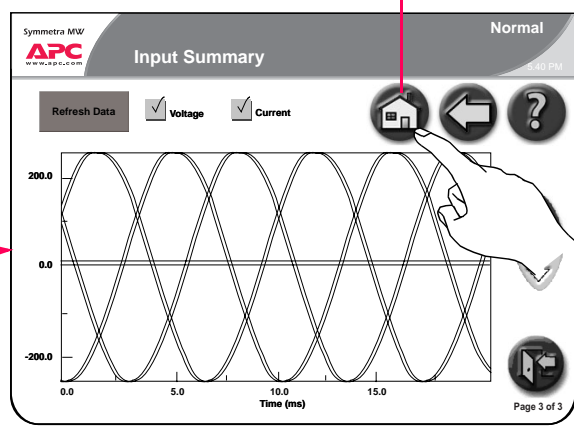

# Output Summary Screens

The three Output Summary screens provide output-specific status of voltage, power, current, frequency, etc.

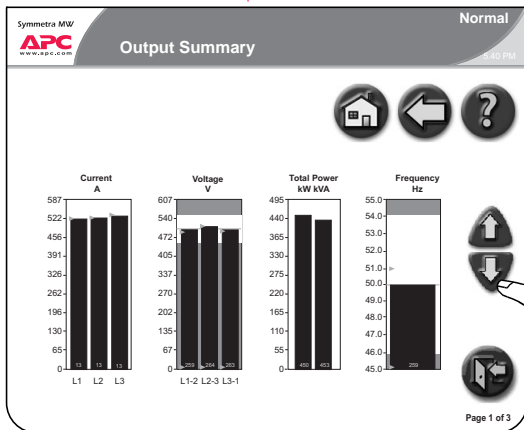
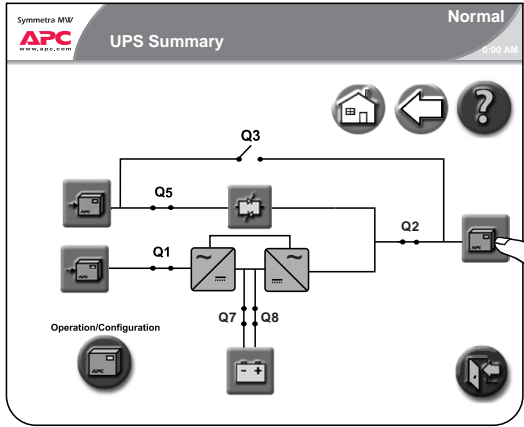

The black bars represent real-time data. Yellow triangles represent the maximum values recorded to date and blue triangles represent the minimum values recorded to date. These values will be reset when the output statistics are reset

The Output Summary screen displays detailed numerical data for Current, Voltage, Power, Frequency, and Load. A hand is shown pointing to a button on the right side of the screen.

Current			Power				
	L1	L2	L3	L1	L2	L3	
Current	57.0	59.0	62.0 A	Active power	380	381	382 kW
Current high	60.0	63.0	66.0 A	Active power high	700	701	702 kW
Peak current	20.0	19.5	20.0 A	Apparent power high	700	692	694 kVA
Peak current high	59.4	59.9	60.4 A	Apparent power high	690	682	684 kVA
THD	3.9	4.8	5.8 %	Power factor	0.92	0.81	0.82
THD high	3.8	4.7	5.7 %	Total active power	200 kW		
Crest factor	2.1	2.13	2.23	Total apparent power	150 kVA		
Crest factor high	2.03	2.06	2.16				

Voltage				Frequency	
	L1-2	L2-3	L3-1		
Voltage	220.0	221.0	222.0 V	Frequency	51.4 Hz
Voltage high	220.0	221.0	222.0 V	Frequency high	54.2 Hz
Voltage low	200.0	201.0	202.0 V	Frequency low	45.8 Hz
THD	4.8 %			Tolerance	2.0 %
THD high	2.7	3.6	4.6 %		
Voltage tolerance	5 %				
Waveform tolerance	6 %				
Tolerance conditions	29				

  

Load			
	L1	L2	L3
Load	60.0	68.0	78.0 %
Load high	58.0	66.0	76.0 %
Total load	142.0 %		
Total load high	250.0 %		

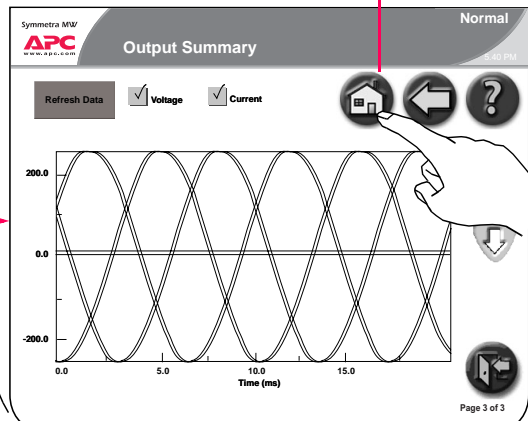

# Bypass Summary Screens

The two Bypass Summary screens provide status of voltage, power, current, frequency, etc.

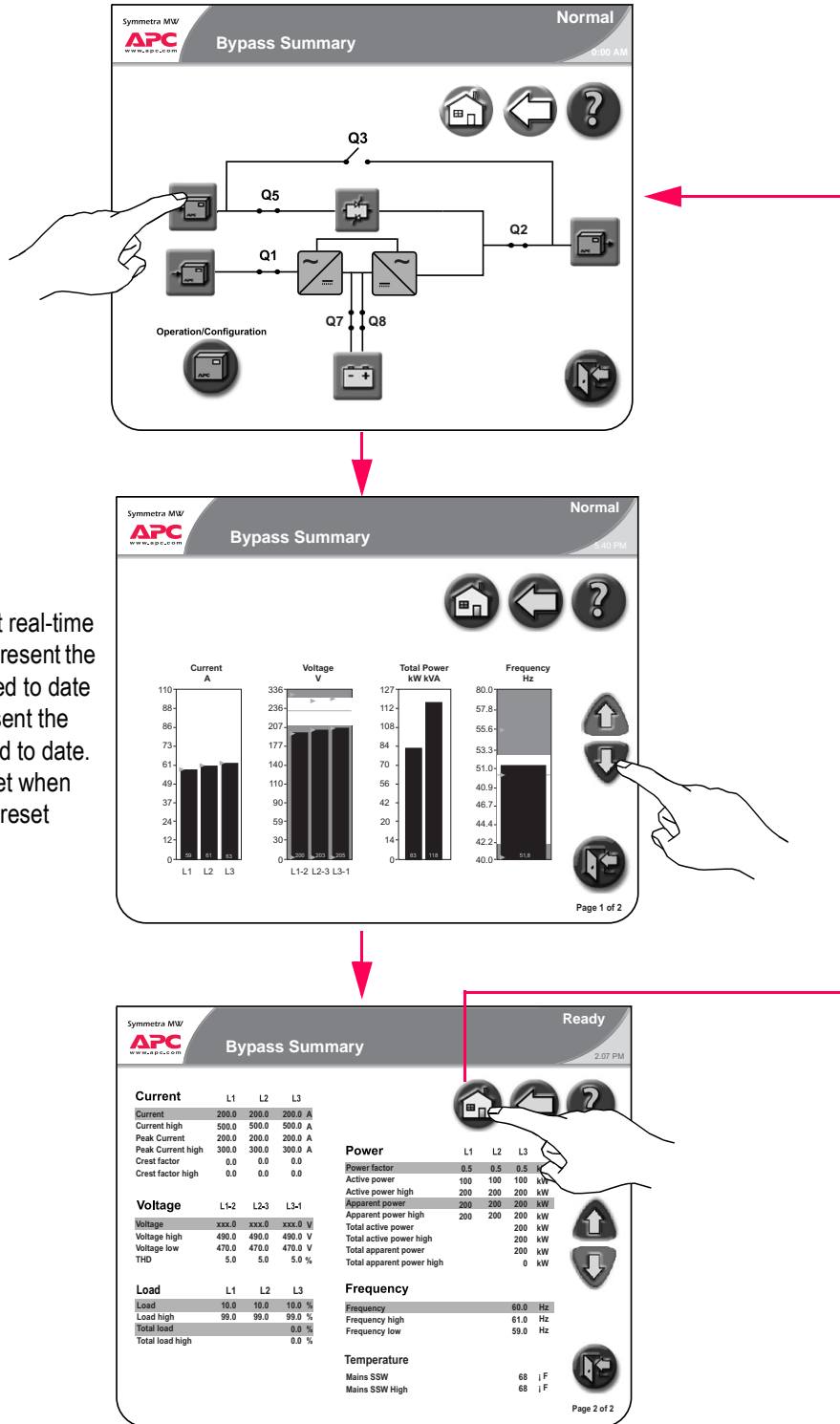

# Battery Summary Screens

The three Battery Summary screens provide battery-specific status of voltage, current, run-time remaining, temperature, power, etc.

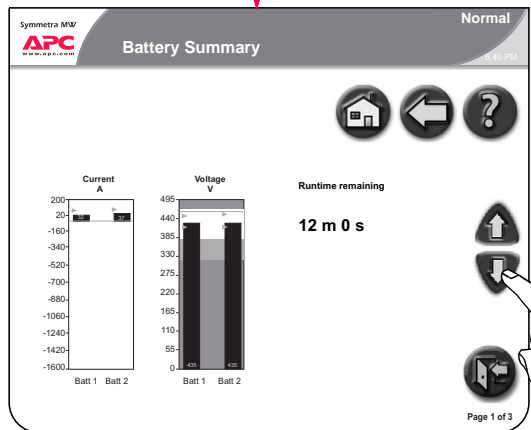
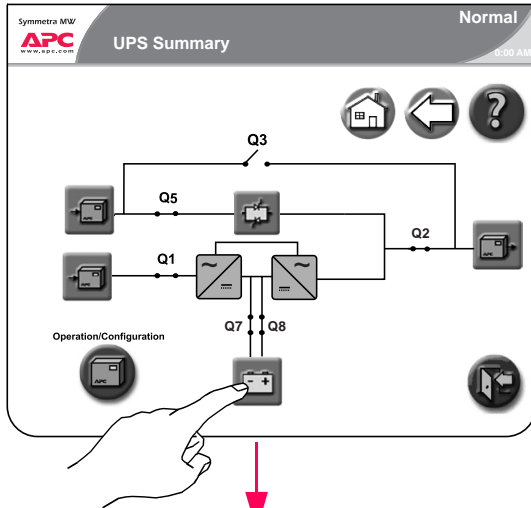

The black bars represent real-time data. Yellow triangles represent the maximum values recorded to date and blue triangles represent the minimum values recorded to date. These values will be reset when the battery statistics are reset

The Battery Summary screen shows detailed statistics for Voltage and Current, Charge, Temperature, and Power.

Voltage and Current	
Battery 1	
Voltage	440.0 V
Voltage high	450.0 V
Voltage low	420.0 V
Current	57.2 A
Current high discharge	119.5 A
Battery 2	
Voltage	451.0 V
Voltage high	460.0 V
Voltage low	420.0 V
Current	51.5 A
Current high discharge	120.0 A
Settings	
Min. voltage: warning	370 V
Min. voltage: shutdown	320 V
Max voltage: warning	460 V
Max voltage: shutdown	475 V
Statistics	
Battery charge	Floating
Time on battery	0 s
Runtime remaining	300 m 0 s
Total time on battery	0 m
Total # of times on battery	0
Charge	
Boost charge	false
Auto boost charge	false
Nominal charge	420 V
Boost charge	450 V
Estimated charge time	65 m
Estimated charge %	100 %
Batt 1 charge current high	-90.0 A
Batt 2 charge current high	-90.0 A
Temperature	
Battery	100 °F
Max battery	86 °F
Battery high	104 °F
Battery low	86 °F
Power	
Battery power	0 kW
Battery power high discharge	0 kW
Battery power high charge	0 kW

The curve shows the battery

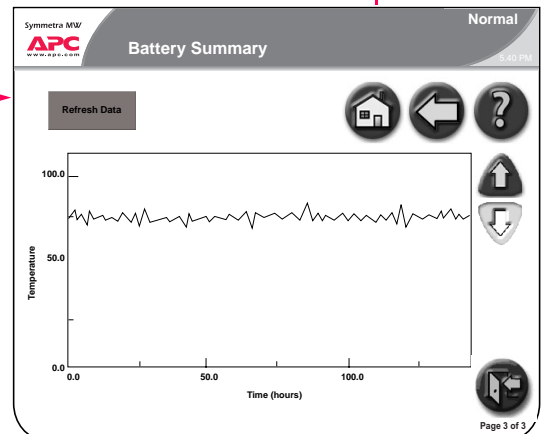

# Operation Screen

The Operation screen permits system operation and monitoring, and provides the ability to change display settings (as illustrated in the following menus).

- 1 Push the Operation/Configuration button to open the Operation screen.

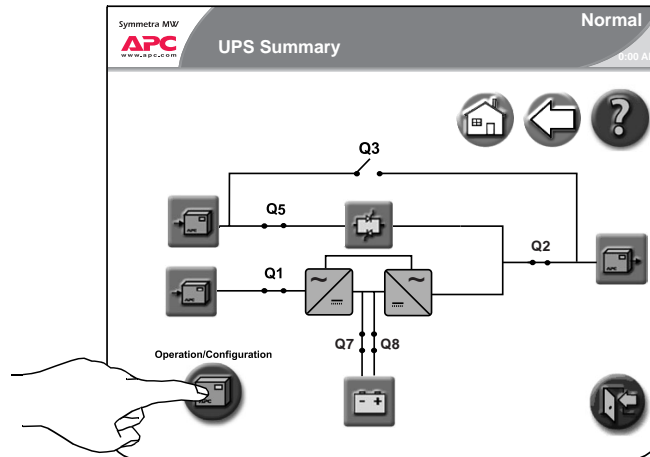

- 2 The Operation screen leads to the following screens:

- UPS Start-Up screen
- UPS Shutdown screen
- Online to Static Bypass screen
- Static Bypass to Online screen
- Network Configuration screens
- User Configuration screens
- View Event Log screen
- Predictive Maintenance screens

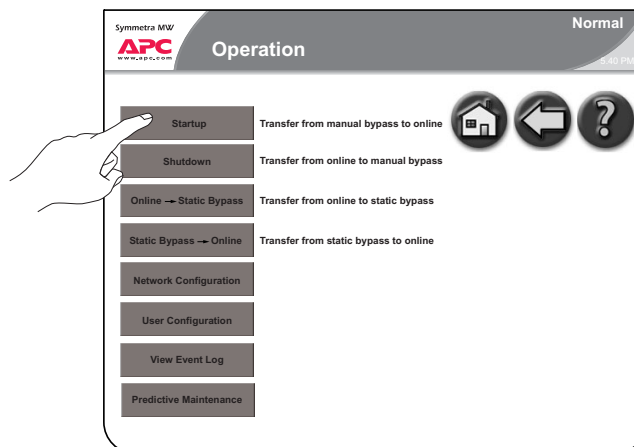



# UPS Start-Up Screen

From the UPS Start-Up screen, the power flow can be transferred from Manual Bypass to Online Operation.

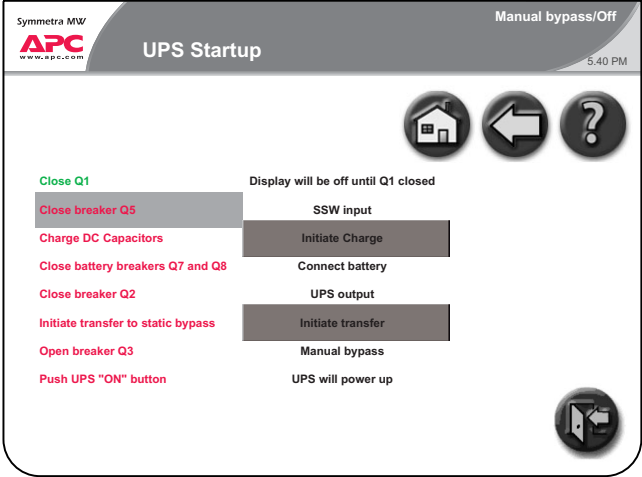

The UPS Start-Up screen shows a list of actions, which need to be completed in order to start up the UPS from Manual Bypass Operation. The actions are initially indicated in red to show that they have not yet been completed. A yellow bar will highlight the actions in the order in which they need to be completed. As actions are completed they will change to green.



The Start-Up procedure is described in “System Start-Up from Manual Bypass Operation” .

# UPS Shutdown screen

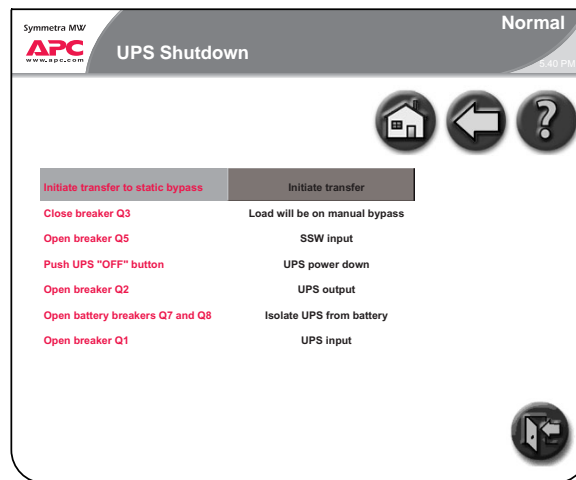

The UPS Shutdown screen shows a list of actions, which need to be completed in order to shut down the UPS. The actions are initially indicated in red to show that they have not yet been completed. A yellow bar will highlight the actions in the order in which they need to be completed. As actions are completed they will change to green.



The Start-Up procedure is described in “System Shutdown from Online to Manual Bypass Operation” .

# Online to Static Bypass Screen

From the Online to Static Bypass screen, the power flow can be transferred from Online to Static Bypass Operation.

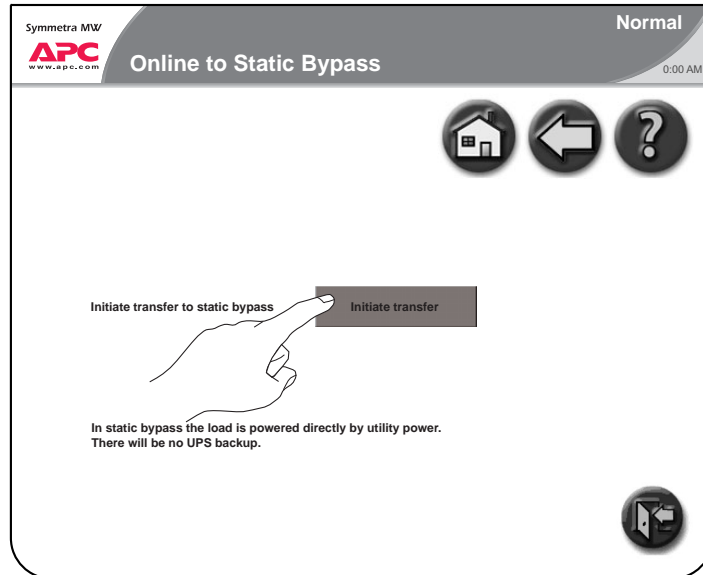

# Static Bypass to Online Screen

---

From the Static Bypass to Online screen, the power flow can be transferred from Static Bypass to Online Operation.

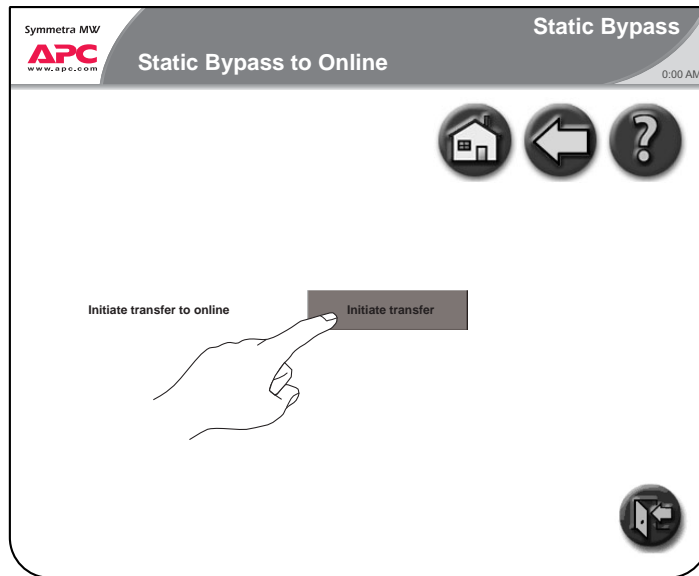

# Network Configuration Screens

There are five Network Configuration screens that will be described below:

- Network Settings screen
- E-mail Settings screen
- SNMP Settings screen
- Remote Monitoring Service Settings screen
- APC ISX Manager Settings screen

## Network Settings screen

All network settings information must be provided before any network functions can be used.

The screenshot shows the 'Network Configuration' screen for Symmetra MW. The interface includes a header with the APC logo and 'Symmetra MW' text. The main content area is titled 'Network Configuration' and contains several sections: 'Network Settings' with a checked 'Enable network' checkbox; 'IP Settings' with input fields for IP address, Subnet mask, and Gateway; 'Host Name Settings' with input fields for Hostname and Domain name; 'DNS Settings' with input fields for Primary and Secondary DNS servers; and 'SMTP Settings' with input fields for From address and SMTP server. Navigation icons (Home, Back, Help, Up, Down, Refresh) are located on the right side, and an 'Apply Changes' button is at the bottom center. The page number 'Page 1 of 5' is at the bottom right.

- Enable Network: Use the checkbox to connect or disconnect the UPS from the network.

### IP Settings.

- IP address: The static IP address.
- Subnet Mask: The subnet mask for the network segment that the UPS is on.
- Gateway: The network gateway for the segment that the UPS is on.

### DNS Settings.

- Primary DNS server: The IP address of the DNS server to be used by the UPS (optional).
- Secondary DNS server: The IP address of a DNS server to use if the primary server is not available (optional).

### Host Name Settings.

- Host name: The network host name for the system. This uniquely identifies the system on the network. Standard letters (a-z and A-Z), digits (1-9) and hyphen (-) can be used.
- Domain name: The DNS network domain that the UPS is on. Standard letters (a-z and A-Z), digits (1-9) and hyphen (-) can be used.

### SMTP Settings.

- From address: The from address to be used when sending e-mails.
- SMTP server: The SMTP server responsible for sending e-mails.

Select the Apply Changes button when all information has been entered.

### E-mail Settings screen



Network Settings information must be configured prior to enabling e-mail.

From the E-mail Settings screen, configure the e-mail recipients to be notified of alarms, which may occur on the system. The severity of the alarms may be informational, warning or severe and can be specified for each E-mail recipient. Up to 25 e-mail recipients can be entered.

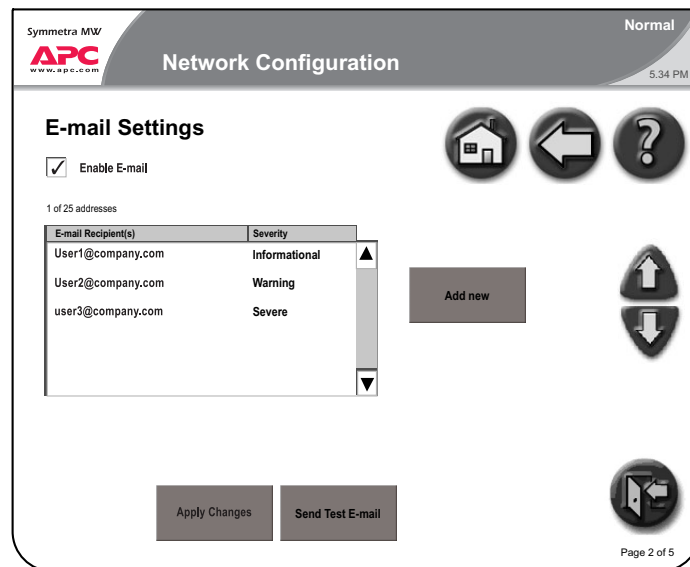

- Enable E-mail: Enable the e-mail notifications by selecting this checkbox.
- To add a new e-mail recipient, touch the Add New button, type in the e-mail address and specify the minimum severity of alarm.
- To edit or delete an e-mail recipient, select the recipient as they appear in the recipient list. Choose to either update or delete the recipient.

- **Apply Changes:** Select this button after all changes have been made. All entries will appear in red until Apply Changes is pressed.
- **Send Test E-mail:** When this button is pressed, a test E-mail is sent to all configured E-mail recipients. This button can be used to validate the e-mail settings.

## SNMP Settings screen

The UPS can be set to send SNMP traps if UPS alarm conditions occur, and when the conditions return to normal afterwards. Each trap contains a description of the alarm condition. Up to 10 Trap Receivers can be entered.

The Trap Receiver must have the APC PowerNet MIB (version 3.6.1 or later). The latest version of the PowerNet MIB can be downloaded from [www.apc.com](http://www.apc.com).



Network Settings must be configured prior to configuring the SNMP Settings.

**Note**

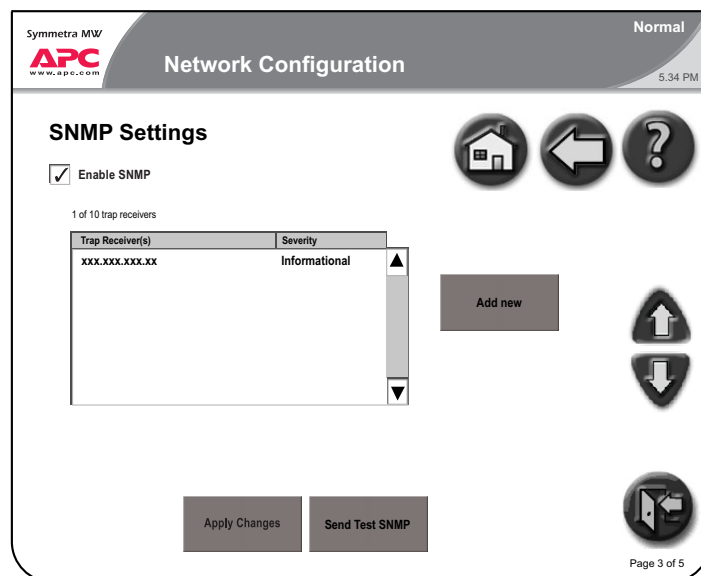

- **Enable SNMP:** Enable the SNMP functionality by selecting this checkbox.
- To add a new Trap Receiver, touch the Add New button, type in the address and specify the minimum severity of alarm.
- To edit or delete a Trap Receiver, select the recipient as they appear in the recipient list. Choose to either update or delete the Trap receiver.
- **Apply Changes:** Select this button after all changes have been made. All entries will appear in red until Apply Changes is pressed.
- **Send Test SNMP:** When this button is pressed, a test trap is sent to all configured Trap Receivers. This button can be used to validate SNMP settings.

## Remote Monitoring Service Settings screen



Network settings must be configured before the remote monitoring feature can be used.

The APC Remote Monitoring Service (RMS) is an APC professional service which securely monitors customer's power systems and surrounding environment from a remote 24×7 operation center, responding to events according to a pre-defined customer escalation procedure. Visit [rms.apc.com](http://rms.apc.com) to learn more about this service.

Symmetra MW  
APC  
www.apc.com

Normal  
5:39 PM

### Remote Monitoring Service Settings

Enable APC RMS

Use proxy

Proxy server address

Proxy server port

Use authentication

Proxy server login

Proxy server password

Apply Changes

Page 4 of 5

- **Enable APC RMS:** Select this checkbox to start using the service. Once selected, information about your UPS will periodically be sent to APC's Remote Monitoring Service.

The APC Remote Monitoring Service uses HTTP protocol to post information to its database. If a proxy server is used as Internet connection method, then the required proxy server port settings must be specified (a proxy server acts as an agent between a workstation user or other networked device and the Internet so that the security, administrative control and caching service can be regulated).

- **Use Proxy:** Select this checkbox if the Internet connection method uses a HTTP proxy server to connect to the Internet.
- **Proxy server address:** Enter the fully qualified IP address or fully qualified domain name of the proxy server. If you do not know the server address or port number, contact your network administrator.
- **Proxy server port:** Enter the port number of the proxy server.
- **Use authentication:** Select this checkbox if the proxy server requires a login. Then specify a Proxy server login (user name) and a Proxy server password.



## APC ISX Manager Settings screen

Symmetra MW  
**APC**  
 www.apc.com

Normal  
 5:34 PM

**Network Configuration**

**APC ISX Manager Settings**

Enable ISX Manager Discovery

Community Name

System Location

System Contact

Apply Changes

Page 5 of 5

The following settings have to be configured for the Symmetra MW to be discovered by the APC ISX Manager:

- Community name: Select the Enable ISX manager discovery check-box
- System Location (optional)
- System Contact (optional)



**Note**

By default the community string is set to public.



**Note**

Select the Apply Changes button after the APC ISX Manager screen has been completed.

# User Configuration Screens

---

There are five User Configuration screens:

- Touch-Screen Settings screen
- Password Settings screen
- Modbus Settings screen
- Regional Settings screen
- Battery Test screen

## Touch-Screen Settings screen

The Touch-Screen Settings screen is used to customize the brightness, contrast and backlight of the display.

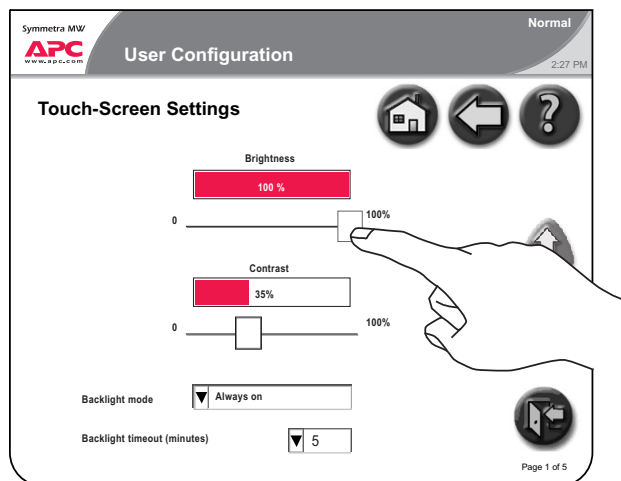

- Brightness: Put the finger on the indicator and slide to the left or right to the desired setting.
- Contrast: Put the finger on the indicator and slide to the left or right to the desired setting.
- Backlight mode: The backlight mode's default setting is that the light goes off after 5 minutes of inactivity.
- Backlight timeout (minutes): The display backlight can be set to be always on or to turn off after a certain period of screen inactivity.

## Password Settings screen

Some of the UPS Display screens (primarily configuration screens) are protected by a password.

On installation the password is set to “apc.” For security reasons, it is recommended to change the password.

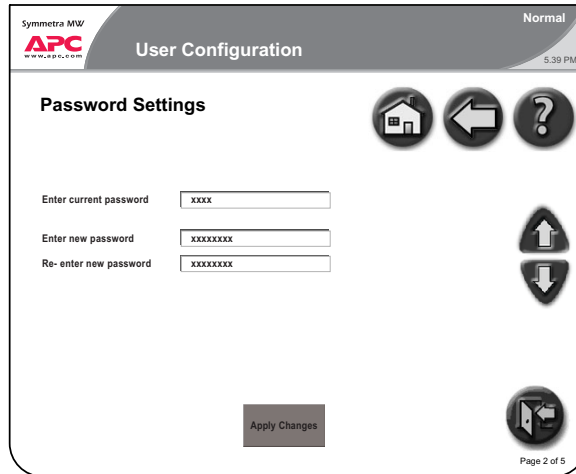

- Enter current password: Enter the current password.
- Enter new password: Enter the new password.
- Re-enter the new password: Re-enter the password to validate the password.



If you forget the password, contact your APC service representative who will be able to help you.

**Note**

## Modbus Settings screen

The Modbus Settings screen allows monitoring of the UPS system by a Building Management System (BMS).

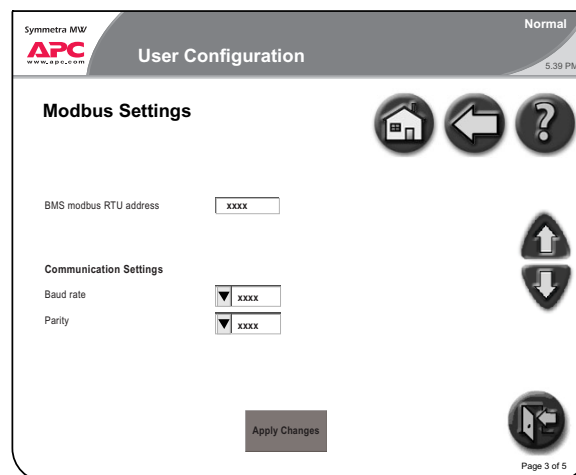

- BMS modbus RTU address: The modbus slave address of the UPS device.
- Baud rate
- Parity

### Regional Settings screen

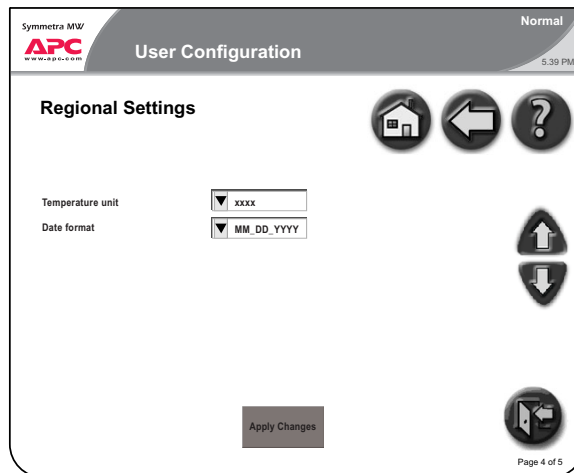

- Temperature unit: Select Celsius or Fahrenheit.
- Date format: Select the preferred date format.
- Apply Changes: Press the Apply Changes button when selections have been made.

### Battery Test screen

From the Battery Test screen two different battery tests can be performed and the battery monitor can be reset.

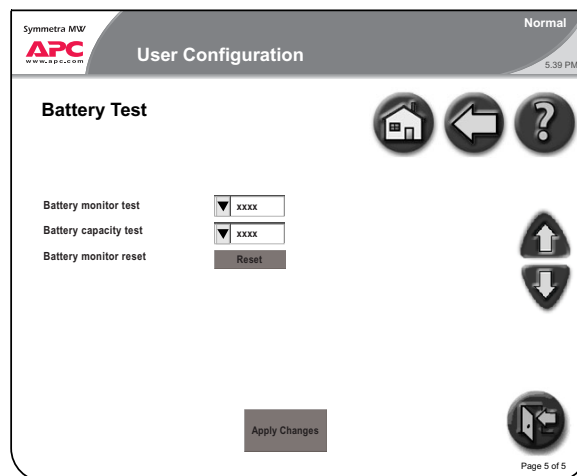

- Battery monitor test: Setting this value to True results in an automatic battery monitor test being performed at regular intervals specified by the Service Engineer. The three options are:
  - Auto battery test - every (N) week(s).
  - Auto battery test - on one day of the week.
  - Auto battery test - at a specific time of the day.
- Battery capacity test: Setting this value to True results in the batteries being discharged until a Battery Low Voltage Level is reached. This test can only be performed manually. The test is used to cycle the batteries in order to calibrate the backup time with the current load and battery modules installed.
- Battery monitor reset: In the event of a weak battery or another battery problem, use this button to reset the battery monitor.

# Event Log Screen

The Event Log screen contains a detailed record of the system's last 1024 events. This includes operation mode changes, system alarms, etc.

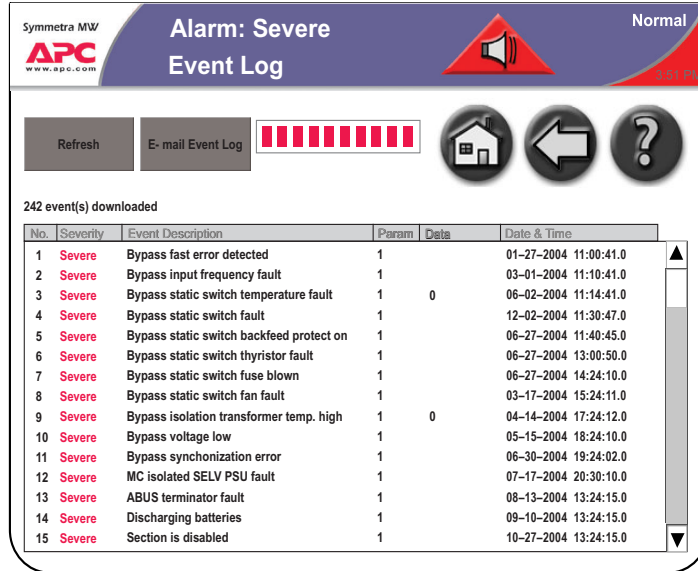

- Refresh: Select the Refresh button to update the Event Log.
- Stop (only visible during update): Select this button to stop the event log downloading.
- E-mail Event Log: Press this button to e-mail the event log to a specific e-mail address. Enter in the e-mail address and press the Send button.

# Predictive Maintenance Screens

The Predictive Maintenance screens display the stress status and the Expected Remaining Lifetime (ERL) of the critical components of the Symmetra MW UPS system.

There are five Predictive Maintenance screens:

- Inverter DC Capacitors screen
- Inverter AC Capacitors screen
- Top Fans screen
- Inverter Fans screen
- Main Static Switch Fans screen

## Inverter DC Capacitors screen

The Inverter DC Capacitor screen displays the actual status and Expected Remaining Lifetime (ERL) of the Inverter DC Capacitors. It is possible to sort the data on the screen by touching any of the column labels.

Number	Type	Stress Status	ERL (months)*
1	OK0046 DC Cap	Normal	120
2	OK0046 DC Cap	Normal	120
3	OK0046 DC Cap	Normal	120
4	OK0046 DC Cap	Normal	120
5	OK0046 DC Cap	Normal	120
6	OK0046 DC Cap	Normal	120
7	OK0046 DC Cap	Normal	120
8	OK0046 DC Cap	Normal	120
9	OK0046 DC Cap	Normal	120
10	OK0046 DC Cap	Normal	120
11	OK0046 DC Cap	Normal	120
12	OK0046 DC Cap	Normal	120

\* ERL - Expected Remaining Lifetime

- Stress Status: States the actual status of the Inverter DC Capacitors. The possible values are:
  - Normal (displaying in green)
  - Stressed (displaying in yellow)
  - Major Stress (displaying in red)
- ERL (months): Predicts the expected remaining lifetime of the particular component.

## Inverter AC Capacitors screen

The Inverter AC Capacitor screen displays the actual status and Expected Remaining Lifetime (ERL) of the Inverter AC Capacitors. It is possible to sort the data on the screen by touching either of the column labels.

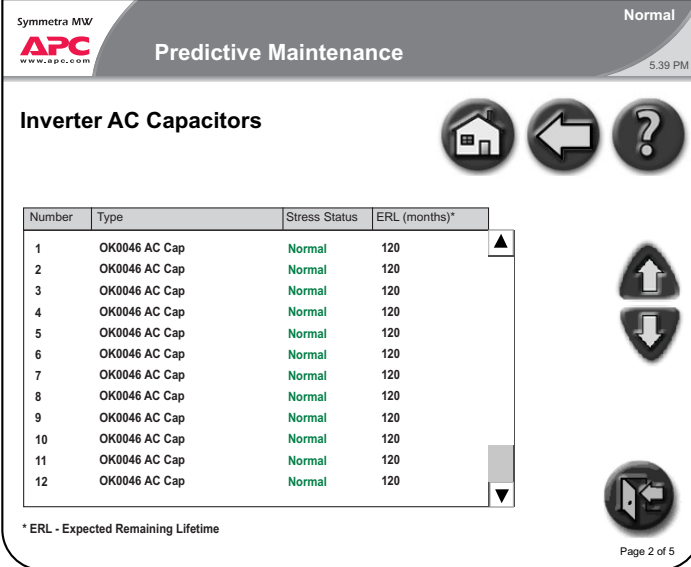

The screenshot shows the 'Inverter AC Capacitors' screen. At the top, it displays 'Symmetra MW APC www.apc.com' and 'Predictive Maintenance' with a 'Normal' status indicator and the time '5:39 PM'. Below the title, there are navigation icons: a home icon, a back arrow, and a question mark. The main content is a table with the following data:

Number	Type	Stress Status	ERL (months)*
1	OK0046 AC Cap	Normal	120
2	OK0046 AC Cap	Normal	120
3	OK0046 AC Cap	Normal	120
4	OK0046 AC Cap	Normal	120
5	OK0046 AC Cap	Normal	120
6	OK0046 AC Cap	Normal	120
7	OK0046 AC Cap	Normal	120
8	OK0046 AC Cap	Normal	120
9	OK0046 AC Cap	Normal	120
10	OK0046 AC Cap	Normal	120
11	OK0046 AC Cap	Normal	120
12	OK0046 AC Cap	Normal	120

Below the table, there is a note: '\* ERL - Expected Remaining Lifetime'. At the bottom right, it says 'Page 2 of 5'. There are also navigation icons for home, back, and help, and a scroll bar on the right side of the table.

- Stress Status: States the actual status of the Inverter AC Capacitors. The possible values are:
  - Normal (displaying in green)
  - Stressed (displaying in yellow)
  - Major Stress (displaying in red)
- ERL (months): Predicts the expected remaining lifetime of the particular component.



## Top Fans screen

The Top Fans screen displays the actual status and Expected Remaining Lifetime (ERL) of the Top Fans. It is possible to sort the data on the screen by touching either of the column labels.

Number	Type	Stress Status	ERL (months)*
1	490-00XX Top fan xxxx	Normal	120
2	490-00XX Top fan xxxx	Normal	120
3	490-00XX Top fan xxxx	Normal	120
4	490-00XX Top fan xxxx	Normal	120
5	490-00XX Top fan xxxx	Normal	120
6	490-00XX Top fan xxxx	Normal	120
7	490-00XX Top fan xxxx	Normal	120
8	490-00XX Top fan xxxx	Normal	120
9	490-00XX Top fan xxxx	Normal	120
10	490-00XX Top fan xxxx	Normal	120
11	490-00XX Top fan xxxx	Normal	120
12	490-00XX Top fan xxxx	Normal	120

\* ERL - Expected Remaining Lifetime

- Stress Status: States the actual status of the Top Fans. The possible values are:
  - Normal (displaying in green)
  - Stressed (displaying in yellow)
  - Major Stress (displaying in red)
- ERL (months): Predicts the expected remaining lifetime of the particular component.

## Inverter Fans screen

The Inverter Fans screen displays the actual status and Expected Remaining Lifetime (ERL) of the Inverter Fans. It is possible to sort the data on the screen by touching either of the column labels.

Number	Type	Stress Status	ERL (months)*
1	490-0039 PM Fan	Normal	120
2	490-0039 PM Fan	Normal	120
3	490-0039 PM Fan	Normal	120
4	490-0039 PM Fan	Normal	120
5	490-0039 PM Fan	Normal	120
6	490-0039 PM Fan	Normal	120
7	490-0039 PM Fan	Normal	120
8	490-0039 PM Fan	Normal	120
9	490-0039 PM Fan	Normal	120
10	490-0039 PM Fan	Normal	120
11	490-0039 PM Fan	Normal	120
12	490-0039 PM Fan	Normal	120

\* ERL - Expected Remaining Lifetime

Page 4 of 5

- Stress Status: States the actual status of the Inverter Fans. The possible values are:
  - Normal (displaying in green)
  - Stressed (displaying in yellow)
  - Major Stress (displaying in red)
- ERL (months): Predicts the expected remaining lifetime of the particular component.

## Main Static Switch Fans screen

The Main Static Switch Fans screen displays the actual status and Expected Remaining Lifetime (ERL) of the Main Static Switch Fans. It is possible to sort the data on the screen by touching either of the column labels.

Number	Type	Stress Status	ERL (months)*
1	490-00XX SSW Fan xxx	Normal	120
2	490-00XX SSW Fan xxx	Normal	120
3	490-00XX SSW Fan xxx	Normal	120
4	490-00XX SSW Fan xxx	Normal	120
5	490-00XX SSW Fan xxx	Normal	120
6	490-00XX SSW Fan xxx	Normal	120
7	490-00XX SSW Fan xxx	Normal	120
8	490-00XX SSW Fan xxx	Normal	120
9	490-00XX SSW Fan xxx	Normal	120
10	490-00XX SSW Fan xxx	Normal	120
11	490-00XX SSW Fan xxx	Normal	120
12	490-00XX SSW Fan xxx	Normal	120

\* ERL - Expected Remaining Lifetime

Page 5 of 5

- Stress Status: States the actual status of the Main Static Switch Fans. The possible values are:
  - Normal (displaying in green)
  - Stressed (displaying in yellow)
  - Major Stress (displaying in red)
- ERL (months): Predicts the expected remaining lifetime of the particular component.



# Operation Modes

## On-line Operation

During on-line operation, the critical load is supported by the inverters. The main inverter controls the output voltage and the delta inverter controls the input current. The delta inverter also provides battery-charging current. While the UPS is running in this mode, a single-line diagram will appear on the screen. The green line indicates the power flow from the utility supply through the UPS to the load.



### CAUTION!

Do not open Q2 when the UPS is in on-line operation, as this action may result in a load drop or a failure of the UPS to support the load.

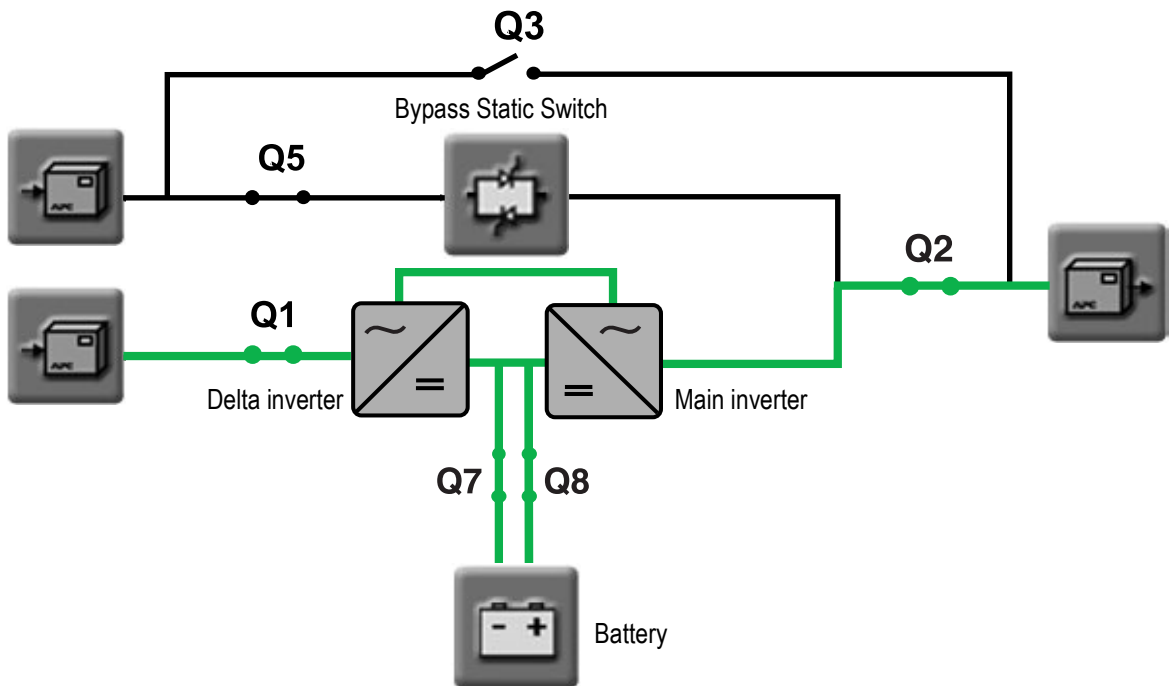

Breaker Identification			
Q1	UPS input breaker	Q5	Static bypass input breaker
Q2	UPS output breaker	Q7	Battery breaker 1
Q3	Manual bypass breaker	Q8	Battery breaker 2



### Note

Only operate a breaker when the associated breaker lamp is on.

# Battery Operation

During battery operation, the load is supported by the inverters. The inverters are supplied by battery power, ensuring uninterrupted support to the load.

While the UPS is running in battery operation, a single-line diagram will appear on the screen with a green line indicating the power flow from the batteries through the main inverter to the load for as long as the batteries are energized.



**CAUTION!**

Do not open Q2, Q7 or Q8 when the UPS is in battery operation, as this action may result in a load drop or a failure of the UPS to support the load.

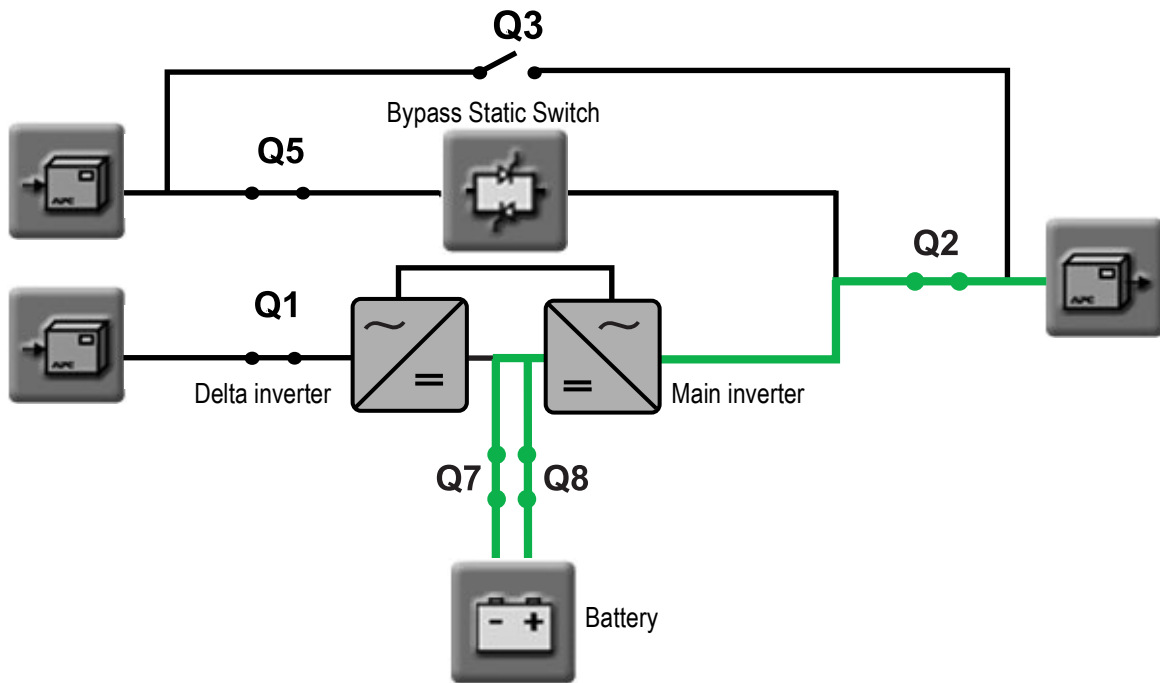

Breaker Identification			
Q1	UPS input breaker	Q5	Static bypass input breaker
Q2	UPS output breaker	Q7	Battery breaker 1
Q3	Manual bypass breaker	Q8	Battery breaker 2



Only operate a breaker when the associated breaker lamp is on.

# Bypass Operation

During bypass operation, the critical load is supplied directly by utility power. A single-line diagram will appear on the screen with an orange line indicating the power flow through the Bypass SSW to the load.



**CAUTION!**

Do not open Q2 or Q5 when the UPS is in bypass operation, as this action may result in a load drop or a failure of the UPS to support the load.

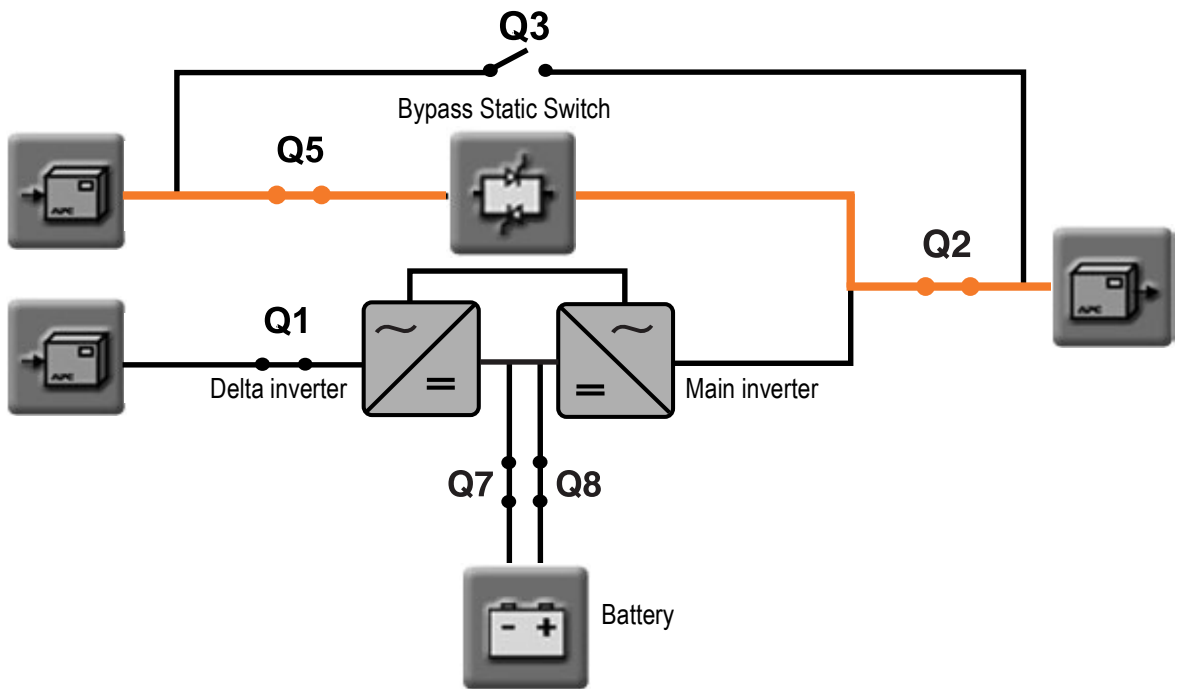

Breaker Identification			
Q1	UPS input breaker	Q5	Static bypass input breaker
Q2	UPS output breaker	Q7	Battery breaker 1
Q3	Manual bypass breaker	Q8	Battery breaker 2



**Note**

Only operate a breaker when the associated breaker lamp is on.

# Manual Bypass Operation

During manual bypass operation, the critical load is supplied directly by utility power, making it possible to isolate the UPS and the Bypass Static Switch for maintenance.



**Note**

Battery power is not available as an alternate power source while the system is running in manual bypass operation.

A single-line diagram will appear on the screen, with an orange line indicating the power flow from the utility to the load via the Q3 breaker.



**CAUTION!**

Do not open Q3 when the UPS is in manual bypass operation, as this action may result in a load drop or a failure of the UPS to support the load.

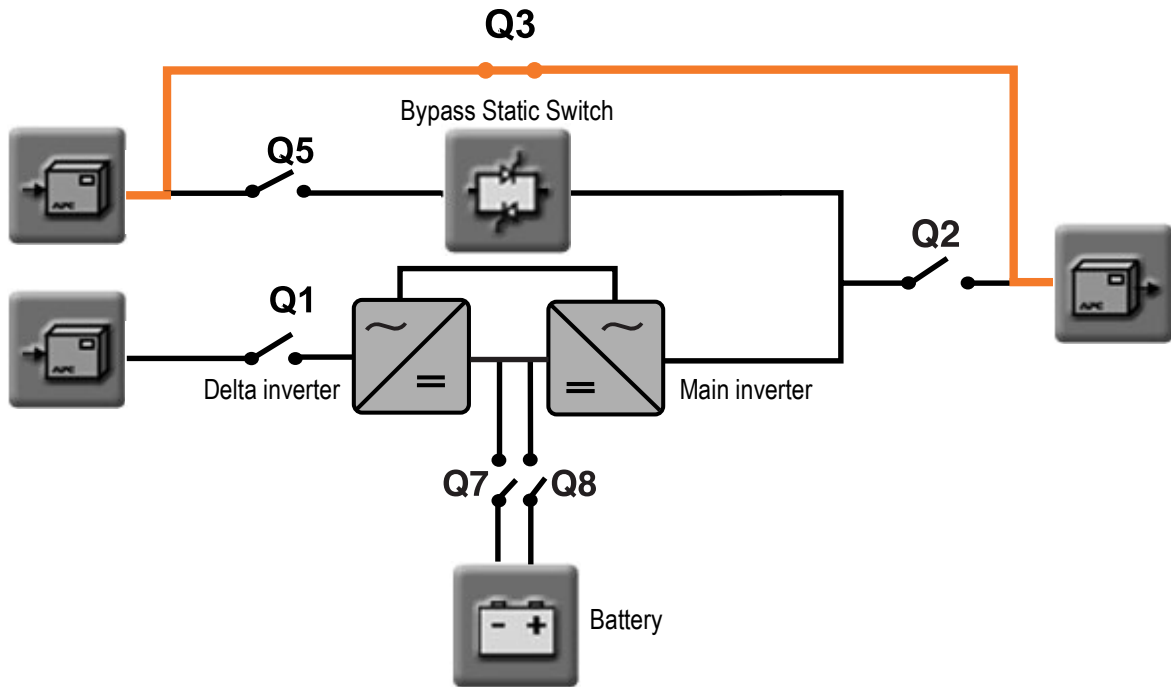

Breaker Identification			
Q1	UPS input breaker	Q5	Static bypass input breaker
Q2	UPS output breaker	Q7	Battery breaker 1
Q3	Manual bypass breaker	Q8	Battery breaker 2



**Note**

Only operate a breaker when the associated breaker lamp is on.



# System Start-Up from Manual Bypass Operation

If the UPS has been operating in manual bypass operation and no power is connected to the UPS, the UPS display will be inactive. To re-start the system from manual bypass and achieve on-line operation, close Q1 in the external maintenance bypass panel. This will power up the internal power supply. Wait for the display to become active and follow the screen-prompted instructions.



## CAUTION!

Follow these instructions carefully. Failure to do so could result in equipment damage.

The first screenshot, titled "UPS Summary", shows a circuit diagram with breakers Q1 through Q8. A hand icon points to the "Operation/Configuration" button. The second screenshot, titled "Operation", shows a menu with "Startup" selected. The third screenshot, titled "UPS Startup", shows a list of instructions: "Close Q1", "Close breaker Q5", "Charge DC Capacitors", "Close battery breakers Q7 and Q8", "Close breaker Q2", "Initiate transfer to static bypass", "Open breaker Q3", and "Push UPS 'ON' button".

Select Operation/Configuration

Select Start-up

Follow the start-up instructions on the screen.

Active commands initially appear in red. Once a command has been carried out successfully, its text will change to green. Important: After pressing "Initiate charge" in step 2, wait until the green lights go on alongside battery breakers Q7 and Q8 on front of the Battery Breaker Box before closing the breakers.

### **System Start-Up from Manual Bypass to Online Operation of single mains/utility system - Step-by-Step**

1. Close Q1 in the external maintenance bypass panel to power up the internal power supply. Wait for the display to become active.
2. Press Operation/Configuration on the UPS Summary screen on the UPS display.
3. Press Startup on Operation screen.
4. Press “Initiate Charge” on the UPS display to initiate the charging of the UPS DC capacitors.
5. When the green lights H7 and H8 are illuminated, close battery breakers Q7 and Q8 to connect the battery system.
6. Close Q2 breaker.
7. Press “Initiate Transfer” on the UPS display to transfer to Static Bypass Operation.
8. Open maintenance bypass breaker Q3.
9. Push ON button on the UPS to transfer to Online Operation

### **System Start-Up from Manual Bypass to Online Operation of dual mains/utility system - Step-by-Step**

1. Close Q1 and Q5 in the external maintenance bypass panel to power up the internal power supply. Wait for the display to become active.
2. Press Operation/Configuration on the UPS Summary screen on the UPS display.
3. Press Startup on Operation screen.
4. Press “Initiate Charge” on the UPS display to initiate the charging of the UPS DC capacitors.
5. When the green lights H7 and H8 are illuminated, close battery breakers Q7 and Q8 to connect the battery system.
6. Close Q2 breaker.
7. Press “Initiate Transfer” on the UPS display to transfer to Static Bypass Operation.
8. Open maintenance bypass breaker Q3.
9. Push ON button on the UPS to transfer to Online Operation

# System Shutdown from Online to Manual Bypass Operation

To shut down the UPS (transfer from on-line operation to manual bypass operation), follow the screen-prompted instructions as illustrated.



## CAUTION!

Do not open Q3 when the UPS is in manual bypass operation, as this action may result in a load drop or a failure of the UPS to support the load.

Select Operation/Configuration

Select Shutdown

Follow the shut-down instructions on the screen.

All instructions initially appear in red. Once a command has been carried out successfully, its text will change to green.

### **System Shutdown from Online to Manual Bypass Operation of single mains/utility systems - Step-by-Step**

1. Press Operation/Configuration on the UPS Summary screen.
2. Select Shutdown on the Operation screen.
3. Press “Initiate Transfer” to initiate the transfer to Static Bypass Operation.
4. Ensure that the green H3 light is illuminated and close the Q3 maintenance bypass breaker.
5. Push OFF button on UPS display to power down the UPS.
6. Ensure that the H2 light is illuminated, indicating that it is safe to operate the Q2 breaker, and open the Q2 breaker.
7. Ensure that the green H7 and H8 lights are illuminated, and open Q7 and Q8 breakers to isolate the UPS from battery power.
8. Open the Q1 breaker.

### **System Shutdown from Online to Manual Bypass Operation of dual mains/utility systems - Step-by-Step**

1. Press Operation/Configuration on the UPS Summary screen.
2. Select Shutdown on the Operation screen.
3. Press “Initiate Transfer” to initiate the transfer to Static Bypass Operation.
4. Ensure that the green H3 light is illuminated and close the Q3 maintenance bypass breaker.
5. Open the Q5 static input switch breaker.
6. Push OFF button on UPS display to power down the UPS.
7. Ensure that the H2 light is illuminated, indicating that it is safe to operate the Q2 breaker, and open the Q2 breaker.
8. Ensure that the green H7 and H8 lights are illuminated, and open Q7 and Q8 breakers to isolate the UPS from battery power.
9. Open the Q1 breaker.

# Transfer from Online to Static Bypass Operation

Follow the below procedure to transfer from Online to Static Bypass Operation:

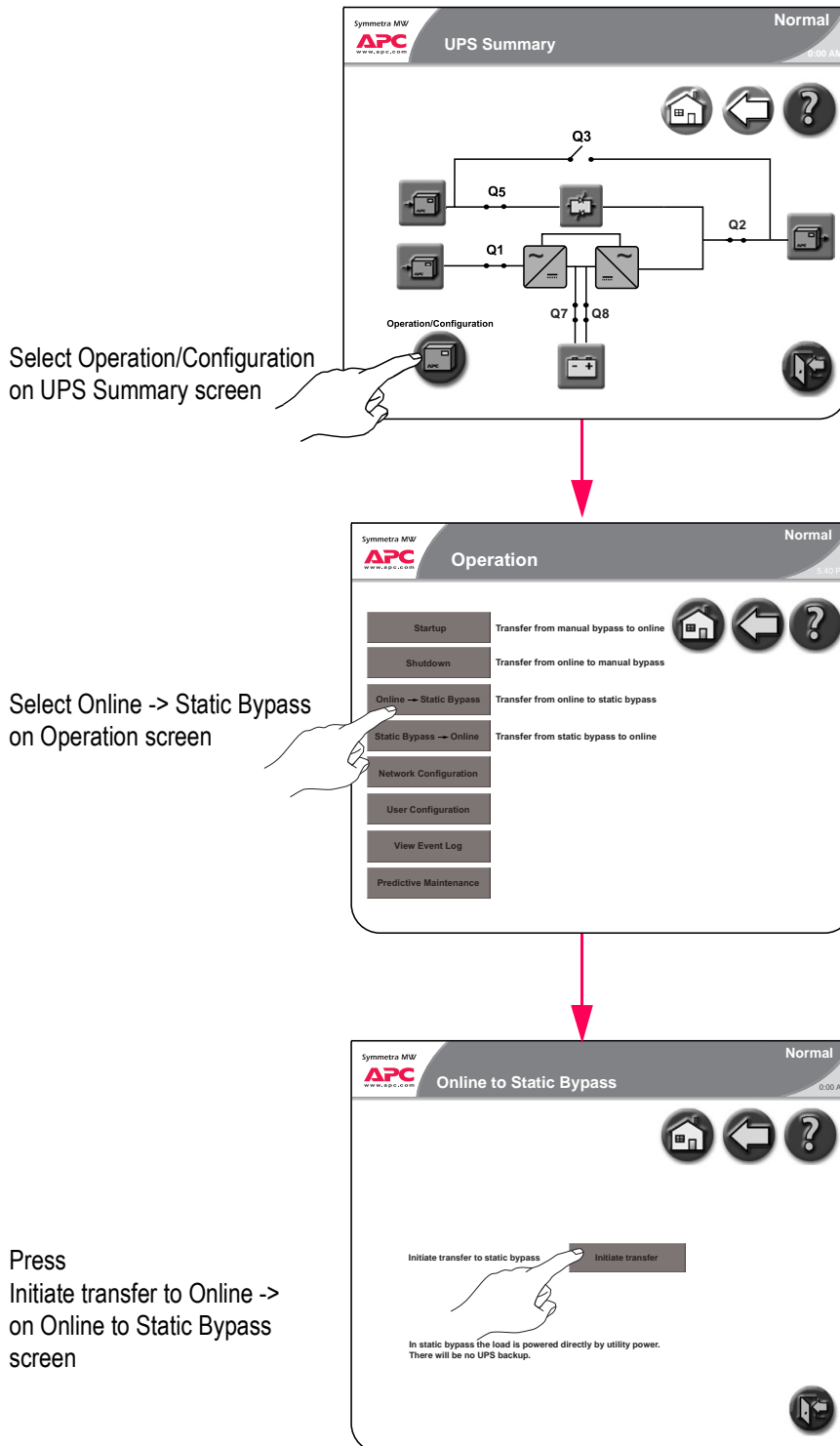

# Transfer from Static Bypass to Online Operation

Follow the below procedure to transfer from Static Bypass to Online Operation:

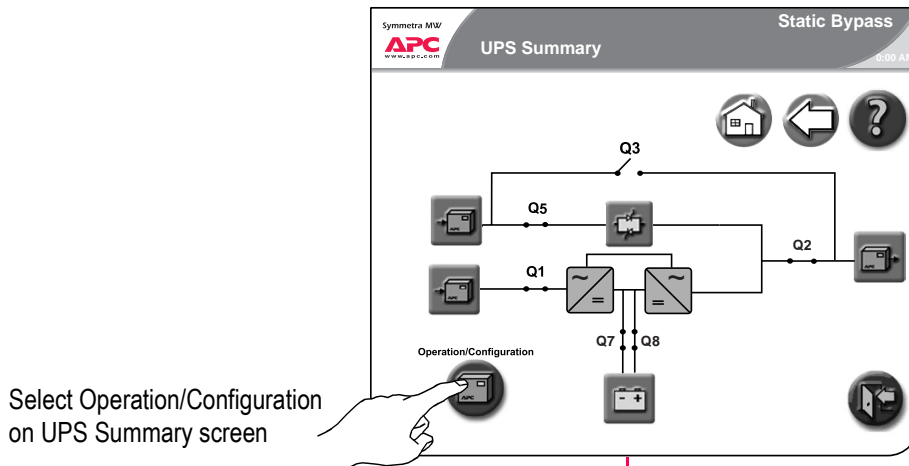

Select Operation/Configuration on UPS Summary screen

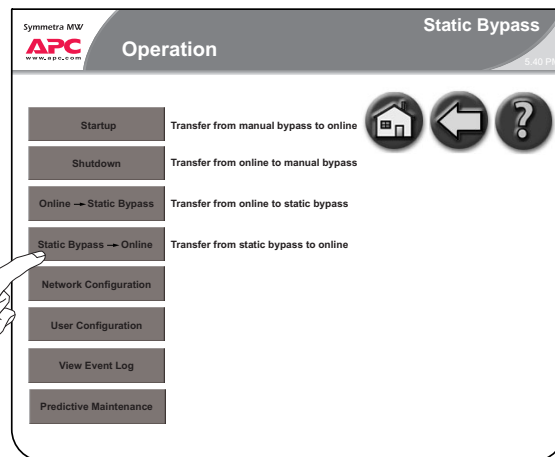

Select Static Bypass -> Online on Operation screen

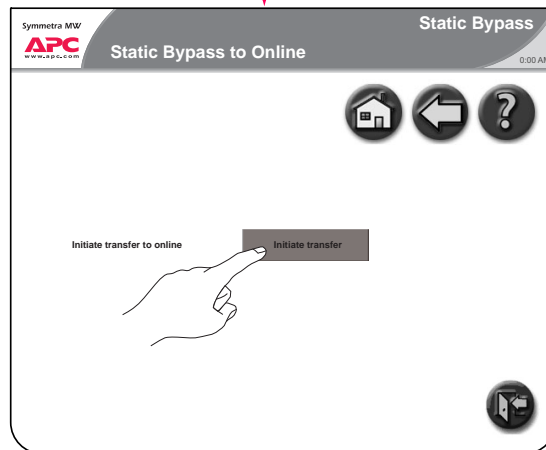

Press Initiate transfer -> on Static Bypass to Online screen

# Alarms/Troubleshooting

## Alarm Types

The color of the top of the screen switches from blue to red when an alarm situation occurs and the alarm symbol is shown at the top of the screen.



Alarm button. Pressing the alarm button will take the user to a screen showing all active alarms and how each alarm should be addressed. The 3 different alarm levels are described below. Hitting the alarm symbol or any other display button will automatically silence the alarm.

### Info



Informational Alarm. No immediate need to take action. Check the cause of the alarm at next maintenance visit.

### Warning



Warning Alarm. Example: The UPS system may have gone into bypass. The load remains supported, but action must be taken. Call Technical Support. The area in the right side of the top screen alternates between blue and red.

### Severe



Severe Alarm. Take immediate action. Call Technical Support. The red area of the top of the screen alternates between blue and red.

### View active alarms

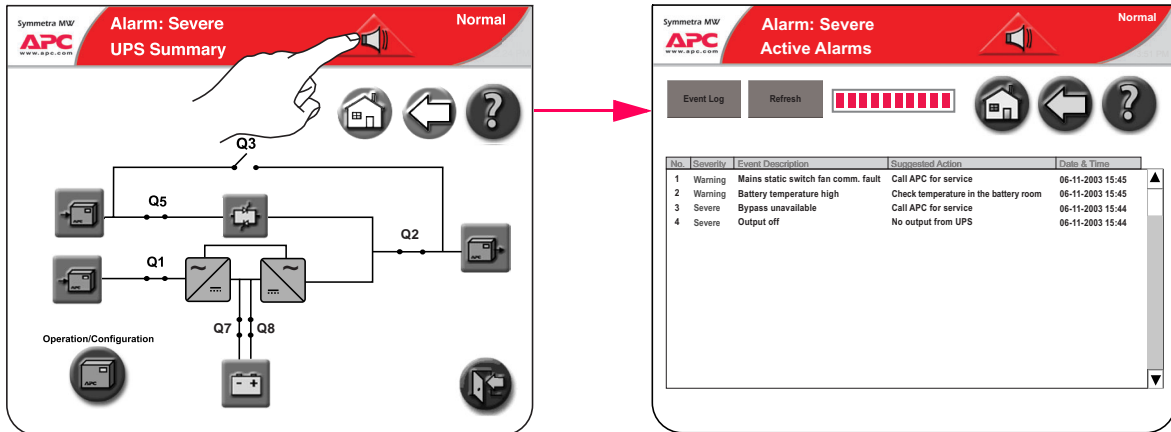

Press the red triangular alarm symbol to view active alarms. Only active alarms will appear on the screen. Pressing the alarm symbol will also mute audible alarms.

Previous alarms are stored in the Event Log, which contains a detailed record of the system's last 1024 events.



In the Active Alarms list, the user can see which actions to take to solve the problem.

**Note**



# APC Symmetra MW Remote Display

The read-only display screens can be accessed via an Internet Browser by typing the IP address of the Symmetra MW display into the browser's address field. The remote display feature provides a subset of the Symmetra MW display screens. Configuration of the Symmetra MW or the display through the remote display is not supported.

The remote display feature requires Microsoft Internet Explorer 6 SP1 or greater. For best results we recommend that the Sun JVM version 1.4.2\_05 or greater be installed. This is available from Sun's website.

The Netscape browser is not supported.

The following screens can be accessed during a remote session:

- UPS Summary screen
- Active alarms screen
- Event log screen
- Input Summary screens
- Output Summary screens
- Battery Summary screens
- Bypass Summary screens



**Note**

Operation/configuration must be done at the UPS.



**Note**

The event log screen can be accessed through the Operation screen. Only the 50 most recent events in the Event Log screen can be downloaded.



**Note**

Network settings must be configured before the remote display feature can be used.

## Starting web-based remote session

- Start the web-based remote session by entering the IP address of the APC Symmetra MW UPS in the web browser address field. After a few seconds, a new window will open and display the below screen:

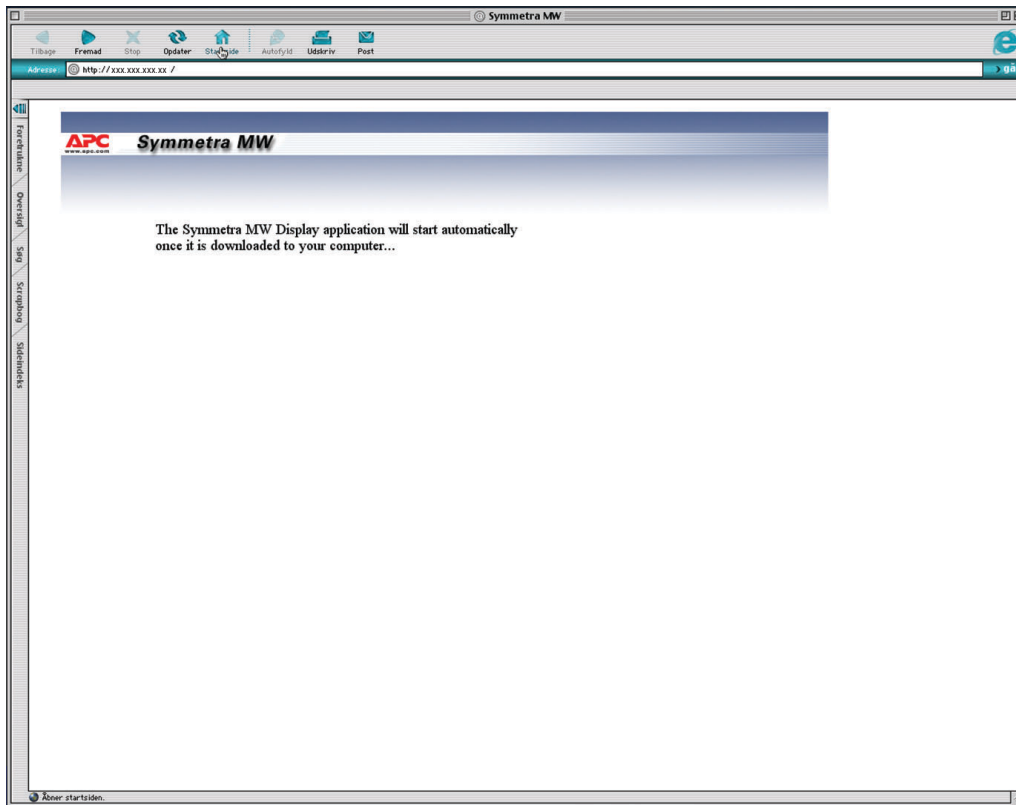

- After a few seconds, the UPS display is shown on the screen.
- Use the mouse to touch the buttons to see other screens.
- Close the window or the web browser to end the remote session.



**Note**

For security reasons, there is a time limit of 30 minutes for a remote session. The connection will be disconnected after 30 minutes and reconnection is required.



**Note**

Only one remote session at a time is allowed.

# Warranty

## Factory Warranty

---

APC warrants that the unit, when properly installed and commissioned by APC or APC authorized service personnel, shall be free from defects in materials and workmanship for a period of (1) year from the date of installation or maximum 18 months after manufacturing. In the event that the unit fails to meet the foregoing warranty, APC shall for a period of one (1) year repair or replace any defective parts, without charge for on-site labor and travel if trained & authorized APC personnel has conducted start-up of the unit.

An APC Start-Up Service must be performed/completed by APC or by service personnel authorized by APC. If not, the on-site factory warranty will be voided and replacement of defective parts only will be covered. APC shall have no liability and no obligation to repair the installed unit if non-authorized APC personnel performed the start-up and such start-up caused the unit to be defective.

APC shall not be liable under the warranty if its testing and examination disclose that the alleged defect in the product does not exist or was caused by purchaser's or any third person's misuse, negligence, improper installation or testing, unauthorized attempts to repair or modify, or any other cause beyond the range of the intended use, or by accident, fire, lightning or other hazard.

There are no warranties, expressed or implied, by operation of law or otherwise, of products sold, serviced or furnished under this agreement or in connection herewithin. APC disclaims all implied warranties of merchantability, satisfaction and fitness for a particular purpose. APC's express warranties will not be enlarged, diminished, or affected by and no obligation or liability will arise out of, APC rendering of technical or other advice or service in connection with the products. The foregoing warranties and remedies are exclusive and in lieu of all other warranties and remedies. The warranties set forth above, constitute APC's sole liability and purchaser's exclusive remedy for any breach of such warranties. APC's warranties apply only to purchaser and are not extended to any third parties.

In no event shall APC, its officers, directors, affiliates or employees be liable for any form of indirect, special, consequential or punitive damages, arising out of the use, service or installation, of the products, whether such damages arise in contract or tort, irrespective of fault, negligence or strict liability or whether APC has been advised in advance of the possibility of such damages.

# Life Support Policy

---

As a general policy, American Power Conversion Corporation and its affiliates and subsidiaries worldwide (APC) do not recommend the use of any of its products in life support applications where failure or malfunction of the APC product can be reasonably expected to cause failure of the life support device or to significantly affect its safety or effectiveness. APC does not recommend the use of any of its products in direct patient care. APC will not knowingly sell its products for use in such applications.

Examples of devices considered to be life support devices are neonatal oxygen analysers, nerve stimulators (whether used for anesthesia, pain relief, or other purposes), autotransfusion devices, blood pumps, defibrillators, arrhythmia detectors and alarms, pacemakers, hemodialysis systems, peritoneal dialysis systems, neonatal ventilator incubators, ventilators for both adults and infants, anesthesia ventilators, infusion pumps, and any other device designated as “critical” by the U.S.F.D.A.

# Appendix A

## Air Filter Exchange

Check air filters at regular intervals (every 3 months under normal working conditions) for accumulated dust on the surface facing the finishing panels. Change all filters at the same time.

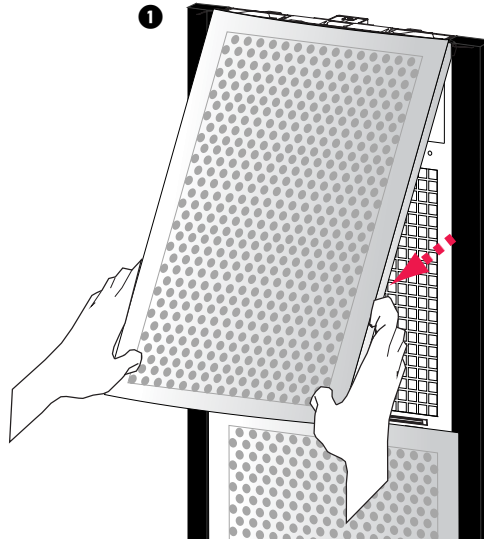

- 1 Pull lower part of top finishing panel free of the UPS.

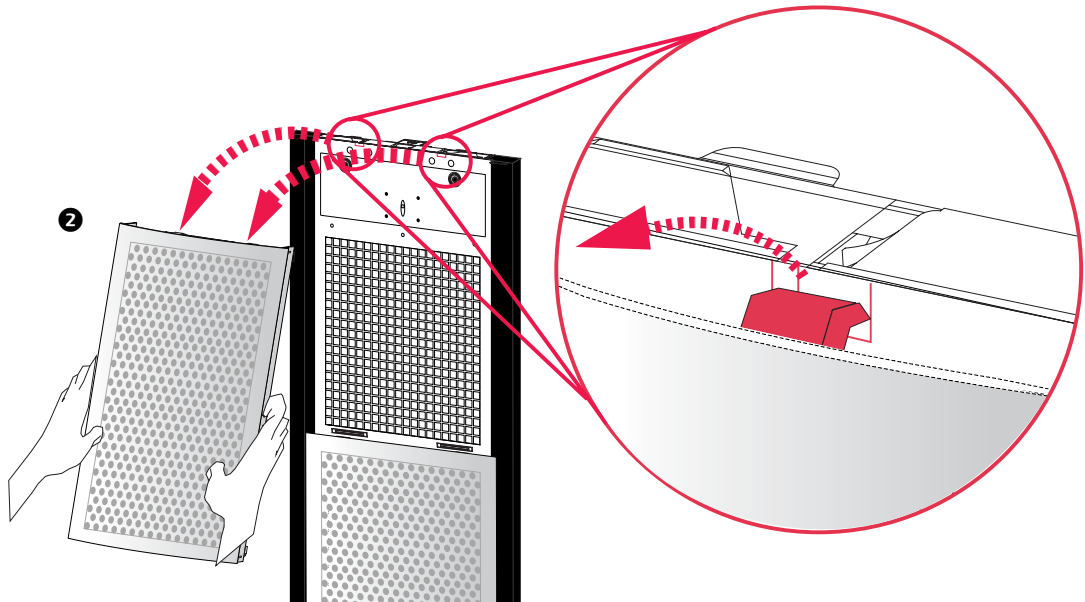

- 2 Lift finishing panel free of the dead front panel and remove.
- 3 Follow this procedure to remove the next finishing panel down, until all panels in one row have been removed. Use the same procedure for the next row of panels until all panels have been removed from the UPS system.

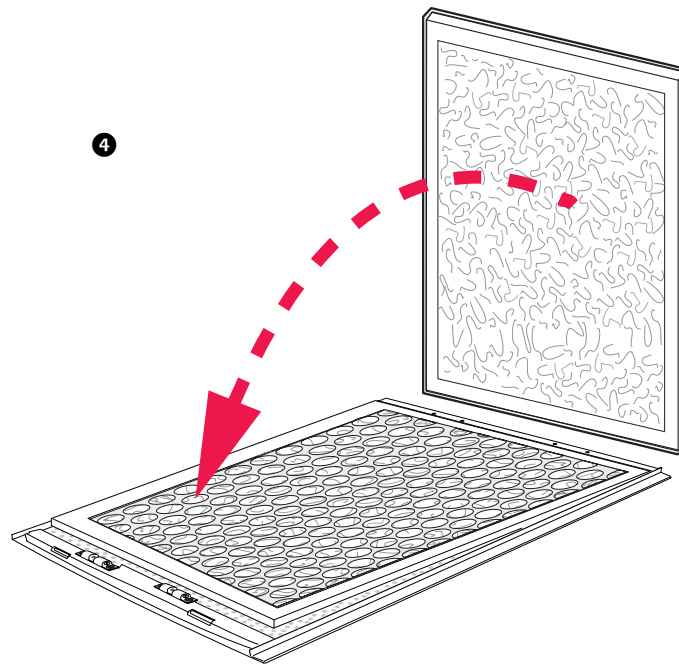

**Note**

Note the orientation of the filter.

- ④ Remove air filters and install new filters.
- ⑤ Refit finishing panels in reverse order.





## APC Worldwide Customer Support

Customer support for this or any other APC product is available at no charge in any of the following ways:

- Visit the APC Web site to access documents in the APC Knowledge Base and to submit customer support requests.
  - **www.apc.com** (Corporate Headquarters)  
Connect to localized APC Web sites for specific countries, each of which provides customer support information.
  - **www.apc.com/support/**  
Global support searching APC Knowledge Base and using e-support.
- Contact an APC Customer Support center by telephone or e-mail.
  - Regional centers:

Direct InfraStruXure Customer Support Line	(1)(877)537-0607 (toll free)
APC headquarters U.S., Canada	(1)(800)800-4272 (toll free)
Latin America	(1)(401)789-5735 (USA)
Europe, Middle East, Africa	(353)(91)702000 (Ireland)
Japan	(0) 3 5434-2021
Australia, New Zealand, South Pacific area	(61) (2) 9955 9366 (Australia)

- Local, country-specific centers: go to **www.apc.com/support/contact** for contact information.

Contact the APC representative or other distributor from whom you purchased your APC product for information on how to obtain local customer support.

Entire contents © 2005 American Power Conversion. All rights reserved. Reproduction in whole or in part without permission is prohibited. APC, the APC logo, and Symmetra are trademarks of American Power Conversion Corporation and may be registered in some jurisdictions. All other trademarks, product names, and corporate names are the property of their respective owners and are used for informational purposes only.

