

Panasonic®

Heavy Duty CD player/Weather Band Receiver

CQ-5301U



Operating Instructions



- Please read these instructions carefully before using this product and keep this manual for future reference.

Safety Information

- Read the operating instructions for the unit and all other components of your car audio system carefully before using the system. They contain instructions about how to use the system in a safe and effective manner. Panasonic assumes no responsibility for any problems resulting from failure to observe the instructions given in this manual.

- This manual uses pictographs to show you how to use the product safely and to alert you to potential dangers resulting from improper connections and operations. The meanings of the pictographs are explained below. It is important that you fully understand the meanings of the pictographs in order to use this manual and the system properly.



Warning

This pictograph intends to alert you to the presence of important operating instructions and installation instructions. Failure to heed the instructions may result in severe injury or death.



Caution

This pictograph intends to alert you to the presence of important operating instructions and installation instructions. Failure to heed the instructions may result in injury or material damage.

Warning

Observe the following warnings when handling this unit.

- The driver should not operate the system while driving.**
Operating the system will distract the driver from looking ahead of the vehicle and can cause accidents. Always stop the vehicle in a safe location and use the parking brake before operating the system.
- Use the proper power supply.**
This product is designed for operation with a negative grounded 12 V DC battery system. Never operate this product with other battery systems, especially a 24 V DC battery system.
- Do not expose the unit to direct sunlight or excessive heat.**
Otherwise these will raise the interior temperature of the unit, and it may lead to smoke, fire, or other damage to the unit.
- Keep batteries out of reach of infants.**
Batteries can be ingested, so keep them out of the reach of infants. If an infant ingests a battery, please seek immediate medical attention.
- Do not use the product where it is exposed to water, moisture, or dust.**
Exposure of the unit to water, moisture, or dust may lead to smoke, fire, or other damage to the unit. Make especially sure that the unit does not get wet in car washes or on rainy days.
- Protect the Deck Mechanism.**
Do not insert any foreign objects into the slot of this unit.
- Do not disassemble or modify the unit.**
Do not disassemble, modify the unit or attempt to repair the product yourself. If the product needs to be repaired, consult the shop where you purchased this unit or an authorized Panasonic Servicerenter.
- Do not use the unit when it is out of order.**
If the unit is out of order (no power, no sound) or in an abnormal state (has foreign matter in it, is exposed to water, is smoking, or smells), turn it off immediately and consult the store where you purchased it.
- The remote control unit should not lie about in the car.**
If the remote control unit lies about, it could fall on the floor

while driving, get wedged under the brake pedal, and lead to a traffic accident.

Observe the following warnings when installation.

- Disconnect the lead from the negative (-) battery terminal before installation.**
Wiring and installation with the negative (-) battery terminal connected may cause electrical shock and injury due to a short circuit.
Some cars equipped with the electrical safety system have specific procedures of battery terminal disconnection.
FAILURE TO FOLLOW THE PROCEDURE MAY LEAD TO THE UNINTENDED ACTIVATION OF THE ELECTRICAL SAFETY SYSTEM RESULTING IN DAMAGE TO THE VEHICLE AND PERSONAL INJURY OR DEATH.
- Never use safety-related components for installation, grounding, and other such functions.**
Do not use safety-related vehicle components (fuel tank, brake, suspension, steering wheel, pedals, airbag, etc.) for wiring or fixing the product or its accessories.
- Installing the product on the air bag cover or in a location where it interferes with airbag operation is prohibited.**
- Check for piping, gasoline tank, electric wiring, and other items before installing the product.**
If you need to open a hole in the vehicle chassis to attach or wire the product, first check where the wire harness, gasoline tank, and electric wiring are located. Then open the hole from outside if possible.
- Never install the product in a location where it interferes with your field of vision.**
- Never have the power cord branched to supply other equipment with power.**
- After installation and wiring, you should check the normal operation of other electrical equipment.**
The continuation of their using in abnormal conditions may cause fire, electrical shock or a traffic accident.
- In the case of installation to an airbag-equipping car, confirm warnings and cautions of the vehicle manufacturer before installation.**
- Make sure the leads do not interfere with driving or getting in and out of the vehicle.**



Caution

Observe the following cautions when handling this unit.

- Keep the sound volume at an appropriate level.**
Keep the volume level low enough to be aware of road and traffic conditions while driving.
- Do not insert or allow your hand or fingers to be caught in the unit.**
To prevent injury, do not get your hand or fingers caught in moving parts or in the disc slot. Especially watch out for infants.
- This unit is designed for use exclusively in automobiles.**
- Do not operate the unit for a prolonged period with the engine turned off.**
Operating the audio system for a long period of time with the engine turned off will drain the battery.
- Refer fuse replacement to qualified service personnel.**
When the fuse burns out, eliminate the cause and have it replaced with the fuse prescribed for this unit by a qualified service engineer. Incorrect replacement of the fuse may lead to smoke, fire, and damage to the product.

Observe the following cautions when installation.

- Refer wiring and installation to qualified service personnel.**
Installation of this unit requires special skills and experience. For maximum safety, have it installed by the shop where you purchased it. Panasonic is not liable for any problems resulting from your own installation of the unit.

- Follow the instruction to install and wire the product.**

Not following the instructions to properly install and wire the product could cause an accident or fire.

- Take care not to damage the leads.**

When wiring, take care not to damage the leads. Prevent them from getting caught in the vehicle chassis, screws, and moving parts such as seat rails. Do not scratch, pull, bend or twist the leads. Do not run them near heat sources or place heavy objects on them. If leads must be run over sharp metal edges, protect the leads by winding them with vinyl tape or similar protection.

- Use the designated parts and tools for installation.**

Use the supplied or designated parts and appropriate tools to install the product. The use of parts other than those supplied or designated may result in internal damage to the unit. Faulty installation may lead to an accident, a malfunction or fire.

- Do not block the air vent or the cooling plate of the unit.**

Blocking these parts will cause the interior of the unit to overheat and will result in fire or other damage.

- Do not install the product where it is exposed to strong vibrations or is unstable.**

Avoid slanted or strongly curved surfaces for installation. If the installation is not stable, the unit may fall down while driving and this can lead to an accident or injury.

- Installation Angle**

The product should be installed in a horizontal position with the front end up at a convenient angle, but not more than 30°.

The user should bear in mind that in some areas there may be restrictions on how and where this unit must be installed. Consult your dealer for further details.

CAUTION!

THIS PRODUCT UTILIZES A CLASS I LASER. USE OF CONTROLS OR ADJUSTMENTS OR PERFORMANCE OF PROCEDURES OTHER THAN THOSE SPECIFIED HEREIN MAY RESULT IN HAZARDOUS RADIATION EXPOSURE. DO NOT OPEN COVERS AND DO NOT REPAIR YOURSELF. REFER SERVICING TO QUALIFIED PERSONNEL.

Laser products:

Wave length: 790 nm

Laser power: No hazardous radiation is emitted with safety protection.

The following applies only in the U.S.A.

Part 15 of the FCC Rules







FCC Warning:

Any unauthorized changes or modifications to this equipment would void the user's authority to operate this device.

Accessories

1. Operating Instructions	1
2. Supplied Hardware.....	1 set (⇒ page 21)
3. Warranty Card.....	1

Contents

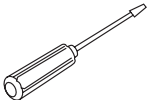
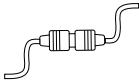
Safety Information(Part 15 of the FCC Rules)	Page 2	
Accessories	3	
<hr/>		
<input type="checkbox"/> Power and Sound Controls	5	
Power, volume, mute, display change, audio mode (Bass/Treble/Balance/Fader)		
<hr/>		
<input type="checkbox"/> Clock Setting	8	
Initial time, time reset		
<hr/>		
<input type="checkbox"/> Radio	9	
Radio mode, band, manual tuning, seek tuning, preset station setting, preset station calling, display change		
<hr/>		
<input type="checkbox"/> CD Player	12	
Disc insert and playback, stop and disc eject, listening to a CD, CD player mode, display change, track selection, track search, direct track selection, random play, scan play, repeat play,pause		
<hr/>		
<input type="checkbox"/> Troubleshooting	14	
Troubleshooting tips, where to get service help		
<hr/>		
<input type="checkbox"/> Maintenance	18	
Care of the unit, notes on discs, notes on CD-Rs/RWs		
<hr/>		
<input type="checkbox"/> Speaker Connections	19	
<hr/>		
<input type="checkbox"/> Installation Guide	20	
Installation hardware, overview, required tools dashboard specifications, identify all leads, connect all leads, final installation, final checks, preparation, to remove the unit		
<hr/>		
<input type="checkbox"/> Electrical Connections	24	
Cautions, wiring diagram		
<hr/>		
<input type="checkbox"/> Specifications	25	

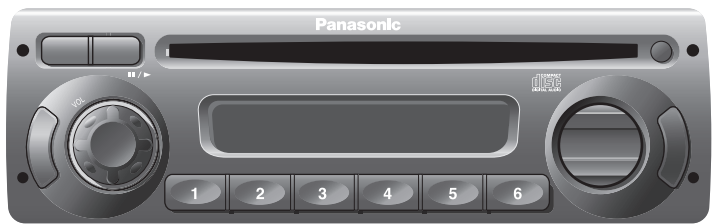



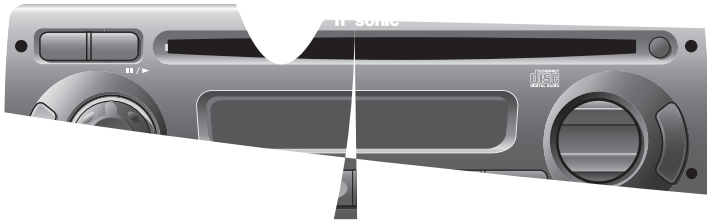

Radio

① Radio Mode

Press [MODE] to change to the radio mode.

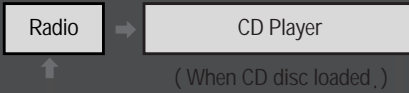

FM stereo indicator, lights while receiving an FM stereo signal.

MODE BAND

87.9 FM 1 

TUNE SEEK

② Band

Press [BAND] to change the band.

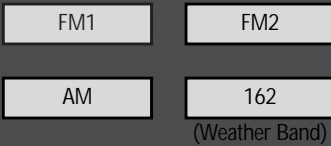

③ Manual Tuning

[TUNE]: Higher frequency

[TUNE]: Lower frequency

Seek Tuning

Press and hold for more than 0.5 seconds and release it.

[TUNE]: Higher frequency

[TUNE]: Lower frequency

Tuning will automatically stop when the next broadcast station is received.

Radio (Continued)

Preset Station Setting

Up to 6 stations can be saved in each of the FM1, FM2 and AM preset station memories.

Note: Existing saved stations are overwritten with new stations after following this procedure.

1 Band

Press **[BAND](APM)** to select a desired band.
(⇒ page 9)

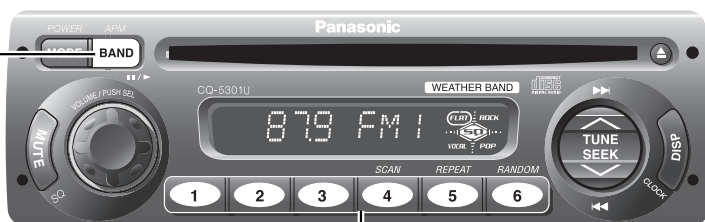

Preset buttons from [1] to [6]

2 Auto Preset Memory (APM)

Press and hold **[BAND]** (APM: auto preset memory) for more than 2 seconds.

- The 6 stations with good reception will be automatically saved in the memory under preset buttons from [1] to [6].
- Once set, the preset stations are sequentially scanned for 5 seconds each.
- To stop scanning, press one of the buttons from [1] to [6].

Manual Preset Memory

- 1 Use manual or seek tuning to find a station. (⇒ page 9)
- 2 Press and hold one of the preset buttons from [1] to [6] until the display blinks once.

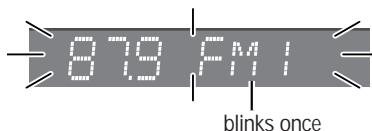

Preset Station Calling

Press the corresponding preset button from [1] to [6] to tune in a preset station.

Caution: To ensure safety, never attempt to preset stations while you are driving.

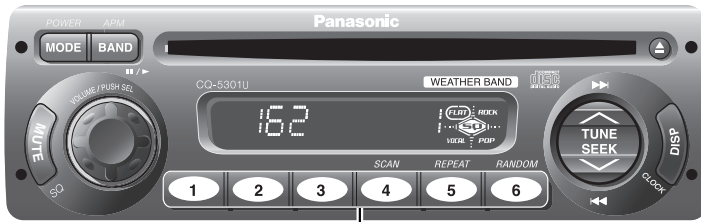

Tuning in a Weather Band Station

- Press **[BAND](APM)** to select WB (Weather Band). (➔ page 9)
- Press any of the buttons **[1]** to **[6]** to monitor the preset station.



WB

Weather Band Frequency (channel) Number

Note: The weather band (CH1-6) has been preset. CH7 is selected by pressing **[Λ]** or **[V]**.

Weather Band Stations

National Weather Radio Broadcasts from over 380 locations throughout the U.S. on seven VHF/FM frequencies.

Tune to weather band to receive continuous weather information 24 hours a day on one of the following frequencies.

1. 162.550 MHz
2. 162.400 MHz
3. 162.475 MHz
4. 162.425 MHz
5. 165.450 MHz
6. 162.500 MHz
7. 162.525 MHz

Occasionally the frequency of an existing or planned station must be changed because of unexpected radio frequency interfere with adjacent NOAA weather Radio Stations and/or with other Government or commercial Operations within the area. If you have a question concerning NOAA Weather Radio, please contact your nearest National Weather Service Office.

CD Player

Disc Insert and Playback

Disc insert

Playback will start automatically after the player recognized the loaded disc as an ordinary music CD. (When a CD-R or CD-RW which has CD-DA formatted data as the same as an ordinary music CD is loaded, this player recognizes it as an ordinary music CD.)

"LOAD" will be displayed until the disc is loaded.



Notes:

- Do not insert a disc when "DISC" indicator lights.
- The power will be turned on automatically when a disc is loading.

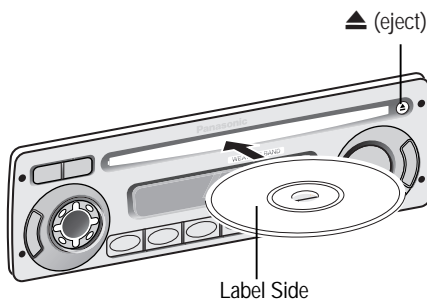

Stop and Disc Eject

Press **[▲]** (eject) to stop CD play and eject the disc. During disc ejection, "EJ" will be displayed.

Listening to a CD

Press **[MODE](POWER)** to change to the CD player mode. Playback will start automatically when a disc is loaded.

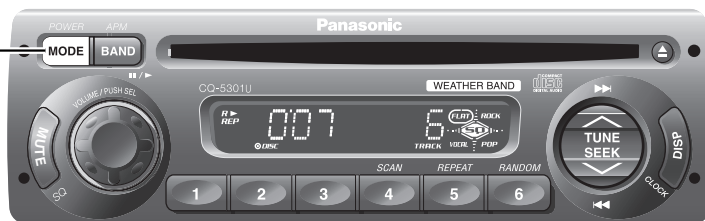
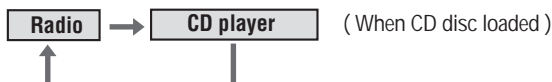

Cautions:

- Only 5" (12 cm) CD, CD-DA data recorded CD-R and CD-RW discs are available for this unit.
- This unit does not support CD text display.
- This unit does not support MP3 and WMA disc playback.
- Refer to page 18 about notes on CD-Rs/RWs.
- This unit is not designed for any 3" (8 cm) disc.
- If you insert an 3" (8 cm) disc and can not eject it, turn ACC of your car off once and turn it on again, then press [▲] (eject).
- Do not use irregular shaped discs.
- Do not use discs that have a seal or label attached.
- Do not insert foreign matter into the disc slot.

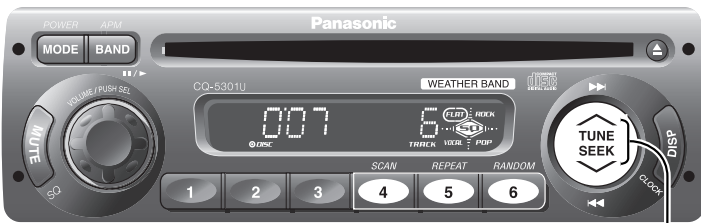

Track Selection

- Press [▶▶ TUNE]: Advance to the next track.
- Press [◀◀ TUNE]: Back to the beginning of the current track.
Back to the previous track. (Press twice.)

Track Search

- Press and hold...
[▶▶ TUNE]: Fast forward
[◀◀ TUNE]: Fast reverse
Release to resume the regular play.

Repeat play

- Press [5] (REPEAT) .
The current track is repeated.
- Press [5] (REPEAT) again to cancel.



Random play

- Press [6] (RANDOM).
All the tracks are played in random order.
- Press [6] (RANDOM) again to cancel.



Scan play

- Press [4] (SCAN).
The first 10 seconds of each track on the disc are played in sequence.
- Press [4] (SCAN) again to cancel.



Pause

- Press [BAND] (||▶).
- Press again to cancel.

Troubleshooting

Preliminary Steps

Check and take steps as described in the tables below.

If You Suspect Something Wrong

Immediately switch the power off.

Disconnect the power connector and check that there is neither smoke nor heat from the unit before asking for repairs. Never try to repair the unit by yourself because it is dangerous to do so.

Cautions:

- Do not use the unit if it malfunctions or if there is something wrong.
- Do not use the unit in irregular condition, for example, without sound, or with smoke or foul smell, which can cause ignition or electric shock. Immediately stop using it and call the store where you purchased it.

Troubleshooting Tips

☐ Common

Trouble	Cause/Step
No power.	Vehicle's ignition switch is not on. ➔ Turn your vehicle's ignition switch to ACC or ON.
	Cables are not correctly connected. ➔ Connect cables correctly.
	Power connector is not correctly connected. ➔ Connect the power connector to the terminal that is always active.
	Power connector is not correctly connected. ➔ Connect the power connector to your vehicle's ACC source.
No sound.	Grounding wire is not correctly connected. ➔ Connect the grounding wire to a metal part of the vehicle.
	Mute is set to ON. ➔ Set it to OFF.
Noise.	Cables are not correctly connected. ➔ Connect cables correctly.
	The ground lead is not connected properly. ➔ Connect the ground lead properly.

☐ Radio

Trouble	Cause/Step
Much noise in FM stereo and monaural broadcasts.	Station is too far, or signals are too weak. ➔ Select other stations of higher signal level.
	The radio antenna is not extended enough. ➔ Extend fully the radio antenna.
Preset station is reset.	Battery cable is not correctly connected. ➔ Connect the battery cable to the terminal that is always active.

☐ CD

Trouble	Cause/Step
Disc is in the CD compartment but no sound is made, or disc is ejected automatically.	Disc is upside down. ➔ Place disc in the correct direction with the label side up.
	<ul style="list-style-type: none">• Disc is dirty.• Disc has scratches. ➔ Clean disc, referring to the section on “Notes on Discs”.
	A disc that has data other than CD-DA type is loaded. ➔ Discs that have CD-DA type data should be used.
Sound skips, bad sound quality. (e.g. caused by noise)	➔ The unit may not successfully playback a CD-R/RW that is made in combination of writing software, a CD recorder (CD-R/RW drive) and a disc which are incompatible one another. Refer to instructions for the concerned devices for details.
	<ul style="list-style-type: none">• Disc is dirty.• Disc has scratches. ➔ Clean disc, referring to the section on “Notes on Discs”.
	➔ The unit may not successfully playback a CD-R/RW that is made in combination of writing software, a CD recorder (CD-R/RW drive) and a disc which are incompatible one another. Refer to instructions for the concerned devices for details.

Troubleshooting (Continued)

☐ CD (Continued)



Trouble	Cause/Step
Sound skips due to vibration.	Mounting angle is over 30°. ➔ Adjust mounting angle to less than 30°.
Disc is not ejected.	Instable mounting. ➔ Mount the unit securely with the mounting parts, referring to the section on installation. • Disc is defective. • Mechanical trouble. ➔ Press [▲] (eject). If normal operation is not restored, call the store where you purchased the unit or the nearest Servicenter to ask for repairs.
Time is counted but no sound comes out.	The first track of a mix mode disc was reproduced. (Mix mode is a format in which data except music is recorded on the first track and music data is recorded on other than the first track in a session.) ➔ Playback music data recorded on other than the first track.

☐ Sound Setting

Trouble	Cause/Step
No sound from left, right, front, or rear speaker.	Left and right balance, or front and rear balance is off on one side. ➔ Adjust BAL/FAD as appropriate. Cables are not correctly connected. ➔ Connect the cables correctly.
Left and right sounds are reversed in stereo listening.	The right speaker wire is connected to the left speaker and the left speaker wire to the right speaker. ➔ Connect the speaker wires to the correct ones.

Error Display Messages

□ CD

Trouble	Cause/Step
	Disc is dirty, or is upside down. A disc that has data other than CD-DA type is loaded. ➔ Check the disc.
	Disc has scratches. ➔ Check the disc.
	No operation by some cause. ➔ If normal operation is not restored, call the store where you purchased the unit or the nearest Servicenter to ask for repairs.

Maintenance

Care of the Unit

Cleaning this Unit

Use a dry, soft cloth to wipe.

Caution on Cleaning

Never use solvents such as benzene, thinner as they may mar the surface of the unit.

Notes on Discs

Do not play any ordinary music CDs with labels other than this one.



How to hold the disc

- Do not touch the underside of the disc.
- Do not scratch the discs.
- Do not bend disc.
- When not in use, keep the disc in the case.

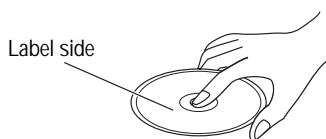

Do not use irregular shaped discs.

- Transparency discs maybe can not be played back

Do not leave discs on the following places:

- Direct sunlight
- Near car heaters
- Dirty, dusty and damp areas
- Seats and dashboards

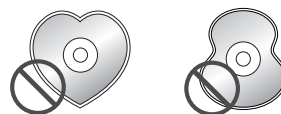

Do not use irregular shaped discs.

Disc cleaning

Use a dry, soft cloth to wipe from the center outward.

Do not attach any seals or labels to your discs.

Do not write on the disc label in a heavy pen or ballpoint pen stroke.

<Right>



<Wrong>



Notes on CD-Rs/RWs

- You may have trouble playing back some CD-R/RW discs recorded on CD recorders (CD-R/RW drives), either due to their recording characteristics or dirt, fingerprints, scratches, etc. on the disc surface.
- CD-R/RW discs are less resistant to high temperatures and high humidity than ordinary music CDs. Leaving them inside a vehicle for extended periods may damage them and make playback impossible.
- The unit may not successfully play back a CD-R/RW that was made by the combination of writing software, a CD recorder (CD-R/RW drive) and a disc if they are incompatible one another.
- This player cannot play the CD-R/RW discs if the session is not closed.
- This player cannot play the CD-R/RW discs which contains other than CD-DA data.
- Be sure to observe the instructions of CD-R/RW disc for handling it.

Speaker Connections

Caution: Please follow the instructions given below. Failure to do so will cause damage to the unit and speakers.

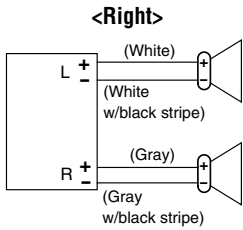

- Use ungrounded speaker only.
- The maximum speaker input should be 37 W or more. (If used with the optional power amplifier, the speaker input should be higher than the maximum amplifier output.)
- The speaker impedance should be 4 - 8 Ω .
- This unit uses the BTCL circuit, so each speaker should be connected separately using parallel vinyl insulated cords.
- The speaker cords and the power amplifier unit should be kept away (about 30 cm apart) from the antenna and antenna extension cord.

<Wrong>

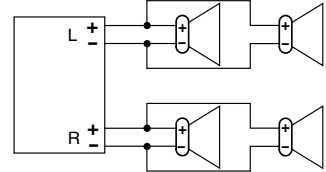
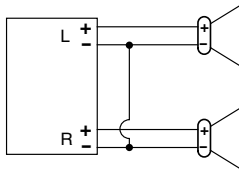
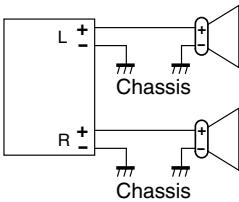

- Never connect the speaker cord to the body of the car.
- Do not use a 3-wire type speaker system having a common earth lead.
- Do not connect more than one speaker to one set of speaker leads.

Product Servicing

If the suggestions in the charts do not solve the problem, we recommend that you take it to your nearest authorized Panasonic Servicenter. The product should be serviced only by a qualified technician.

Maintenance

Your product is designed and manufactured to ensure the minimum of maintenance. Use a soft cloth for routine exterior cleaning. Never use benzine, thinner, or other solvents.

Caution

This product is designed without a fuse inside due to fuses already exist in your vehicle. We would recommend to use fuses of the specified rating (15 A). Using fuses that exceed the prescribed capacity could cause this product to start smoking, ignite or other malfunction.

If your vehicle is without the fuse or a circuit breaker to protect this unit, please your dealer add the specified fuse 15 A or a circuit breaker at the BATTERY lead of your vehicle's harness. please see page 26 to find out where "BATTERY + 12 V" is for your dealer adding the fuse or the circuit breaker.

Installation Guide



WARNING

❑ This installation information is designed for experienced installers and is not intended for non-technical individuals. It does not contain warnings or cautions of potential dangers involved in attempting to install this product.

Any attempt to install this product in a vehicle by anyone other than a qualified installer could cause damage to the electrical system and could result in serious personal injury or death.

❑ If your vehicle is equipped with air bag and/or anti-theft systems, specific procedures may be required for connection and disconnection of the battery to install this product.

Before attempting installation of this electronic component, contact your vehicle dealer or manufacturer to determine the required procedure and strictly follow their instructions.

FAILURE TO FOLLOW THE PROCEDURE MAY RESULT IN THE UNINTENDED DEPLOYMENT OF AIR BAGS OR ACTIVATION OF THE ANTI-THEFT SYSTEM RESULTING IN DAMAGE TO THE VEHICLE AND PERSONAL INJURY.

❑ Overview

This product should be installed by a professional. However, if you plan to install this product yourself, your first step is to decide where to install it. The instructions in these pages will guide you through the remaining steps:

(Please refer to the “WARNING” statement above.)

- Identify and label the car wires.
- Connect the vehicle wires to the wires of the power connector.
- Install the unit in the dashboard.
- Check the operation of the unit.

If you encounter problems, please consult your nearest professional installer.

Caution: This unit operates with a 12 V DC negative ground auto battery system only. Do not attempt to use it in any other system. Doing so could cause serious damage.

Before you begin installation, look for the items which are packed with your unit.

- **Warranty Card**...Fill this out promptly.
- **Panasonic Servicenter List for Service Directory**

...Keep for future reference in case the product needs servicing.

- **Installation Hardware**...Needed for in-dash installation.

❑ Dashboard Specifications

Thickness Min. $\frac{3}{16}$ " (4.75 mm)
Max. $\frac{7}{32}$ " (5.56 mm)

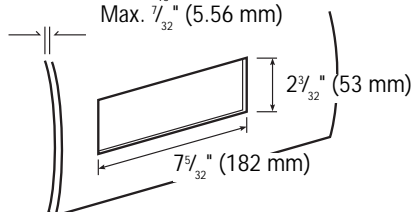

Installation (Continued)

Cautions:

- We strongly recommend that you wear gloves for installation work to protect yourself from injuries.
- When bending the mounting tab of the mounting collar with a screwdriver, be careful not to injure your hands and fingers.

First complete the electrical connections, and then check them for correctness. (→ page 24)

The included Mounting Collar ① is designed specially for this unit. Do not use it to attach any other model.

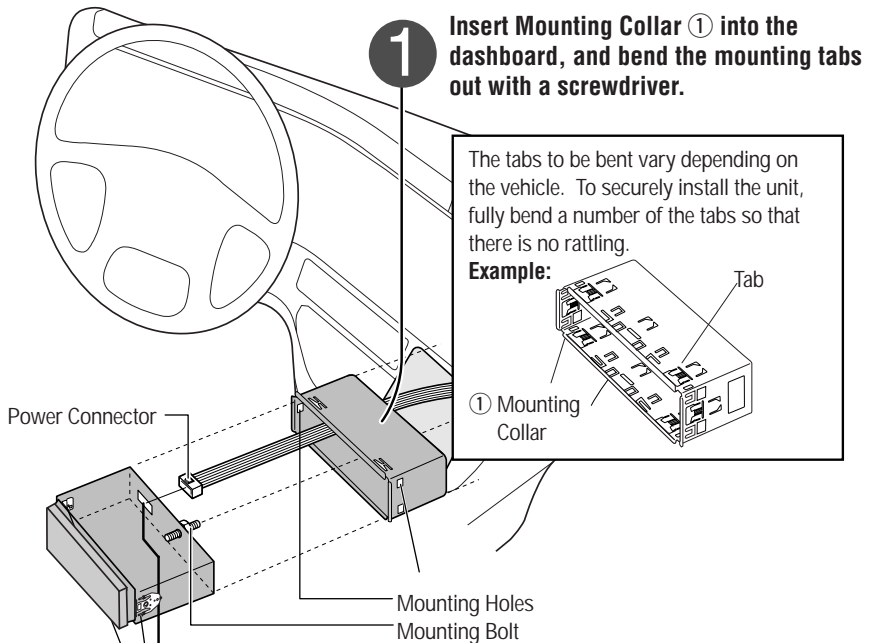

- 2** Establish the rear connection of the unit.
- After fixing Power Connector, fix the rear of the unit to the vehicle body by either method (a) or (b) shown in the previous page.

Mounting springs (※)

- 3** After installation reconnect the negative (-) battery terminal.

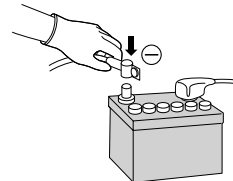
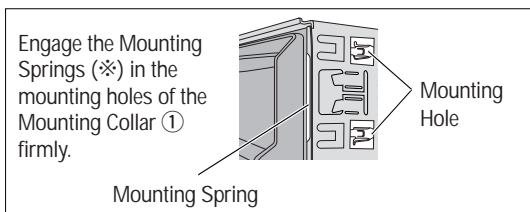

To Remove the Unit from the vehicle's dashboard

Insert each Removal Tool ⑧ and pull.

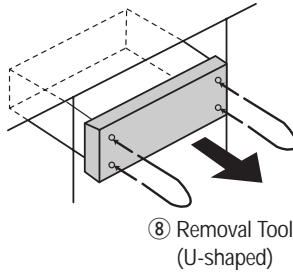

Note: Do not lose Removal Tools. They will be needed to remove the unit from the vehicle's dashboard.

Specifications

□ General

Power Supply:	12 V DC (11 V-16 V) test Voltage 14.4 V, Negative ground
Current consumption:	Less than 2.5 A (CD mode, 0.5 W 4-speaker)
Maximum Power Output:	37 W × 4 channels at 400 Hz, Volume Control maximum
Tone adjustment range:	
Bass:	± 12 dB at 100 Hz
Treble:	± 12 dB at 10 kHz
Power Output:	18 W per channel into 4 ohms, 40 to 30 000 Hz at 3 % THD
Suitable Speaker Impedance:	4-8 Ω
Dimensions (W × H × D):	7" × 1-15/16" × 5-7/8" (178 × 50 × 150 mm)
Weight:	2.8 lbs. (1.3kg)

□ FM Stereo Radio

Frequency Range:	87.9-107.9 MHz
Useable Sensitivity:	12 dBf. (1.1 μV/ 75 Ω, S/N 30 dB)
50 dB Quieting Sensitivity:	17 dBf. (1.8 μV/ 75 Ω)
Frequency Response:	30-15 000 Hz ±3 dB
Alternate Channel Selectivity:	75 dB
Stereo Separation:	35 dB at 1 kHz
Signal/Noise Ratio:	70 dB (Mono)

□ AM Radio

Frequency range:	530 kHz – 1 710 kHz
Usable sensitivity:	28 dB/μV (25 μV, S/N 20 dB)

□ Weather Band Radio

Frequency range:	162.40 – 162.55 MHz
Usable sensitivity:	3 dB/μV (S/N 20 dB)
Signal/Noise Ratio (40 dB/μV):	50 dB

□ CD Player

Sampling Frequency:	32 times oversampling
DA Converter:	MASH•1 bit/4 DAC System
Error Correction System:	Panasonic Super Decoding Algorithm
Pick-Up Type:	1-beam
Light Source:	Semiconductor laser
Wavelength:	790 nm
Frequency Response:	20 - 20,000 Hz (±1 dB)
Signal to Noise Ratio:	85 dB
Total Harmonic Distortion:	0.01 % (1 kHz)
Wow and Flutter:	Below measurable limits
Channel Separation:	75 dB

Above specifications comply with EIA standards.

Note: Specifications and the design are subject to modification without notice due to improvements in technology.

MEMO

A series of horizontal dashed lines for writing.

MEMO

A series of horizontal dashed lines for writing.

**Panasonic Consumer Electronics
Company, Division of Panasonic
Electric Corporation of North America**
One Panasonic Way, Secaucus,
New Jersey 07094