

Consumer Information

Visit us on line at
www.service.fisher-price.com

Call our Consumer Relations Department, toll-free at **1-888-892-6123**, 9 AM - 7 PM EST Monday through Friday and 11 AM - 5 PM EST Saturday. Hearing-impaired consumers using TTY/TDD equipment, please call 1-800-382-7470. Write to us at: Fisher-Price® Consumer Relations, 636 Girard Avenue, East Aurora, New York 14052.

For countries outside the United States:

CANADA: Questions? 1-888-892-6123. Mattel Canada Inc., 6155 Freemont Blvd., Mississauga, Ontario L5R 3W2; www.service.mattel.com.

GREAT BRITAIN: [Mattel UK Ltd. Vanwall Business Park, Maidenhead SL6 4UB. Helpline: 01628 500303.](http://www.service.mattel.com/uk)

AUSTRALIA: Mattel Australia Pty. Ltd., 658 Church Street, Locked Bag #870, Richmond, Victoria 3121 Australia. Consumer Advisory Service 1300 135 312.

NEW ZEALAND: 16-18 William Pickering Drive, Albany 1331, Auckland.

ASIA: Mattel East Asia Ltd, Room 1106, South Tower, World Finance Centre, Harbour City, Tsimshatsui, HK, China.

Fisher-Price®

P6843



Splatster™

A Whole "Mess" of Creative Fun & Games!

Get creative in eight different splat art studios, each with themed drawing tools (like stencils and stampers), crazy brushes (draw with spaghetti; paint with whipped cream!), backgrounds (step into the science lab or swamp) and more! Plus, you can mix 'n match studio tools for a whole mess of creative fun, and save and print your creations, too!



TV not included. Image clarity may vary from photo depiction.

Consumer Information

NOTICE ABOUT EPILEPSY AND SEIZURES PLEASE READ THIS NOTICE BEFORE YOU OR YOUR CHILD USE ANY VIDEO GAME.

A very small portion of the population has a condition, which may cause a momentary loss of consciousness when viewing certain kinds of flashing lights or patterns that are commonly present in our daily environment. This condition may cause seizures while watching some kinds of television pictures or playing certain video games. Players who have not had any previous seizures may nonetheless have an undetected epileptic condition.

If you or anyone in your family has experienced symptoms linked to an epileptic condition (e.g. a seizure or loss of awareness), consult your physician before playing video games. We recommend that parents observe their children while they play video games. If you or your child experience any of the following symptoms such as dizziness, altered vision, eye or muscle twitching, involuntary movements, loss of awareness, disorientation or convulsions, DISCONTINUE USE IMMEDIATELY and consult your physician.

Additionally, please follow these precautions whenever playing a video game:

- Do not sit or stand too close to the television screen. Play as far back from the screen as possible.
- Do not play if you are tired or need sleep.
- Always play in a well lit room.
- Be sure to take a 10-15 minute break every hour while playing.

Notes

- Please keep this instruction sheet for future reference, as it contains important information.
- Adult assembly is required for battery installation and setup.
- Requires four "AA" (LR6) and three "AAA" (LR03) **alkaline** batteries (not included) for operation.
- Tool required for battery installation: Phillips screwdriver (not included).

Care

- Wipe this product with a clean cloth dampened with a mild soap and water solution. Do not immerse this product.
- This product has no consumer serviceable parts. Do not take this product apart.

Features

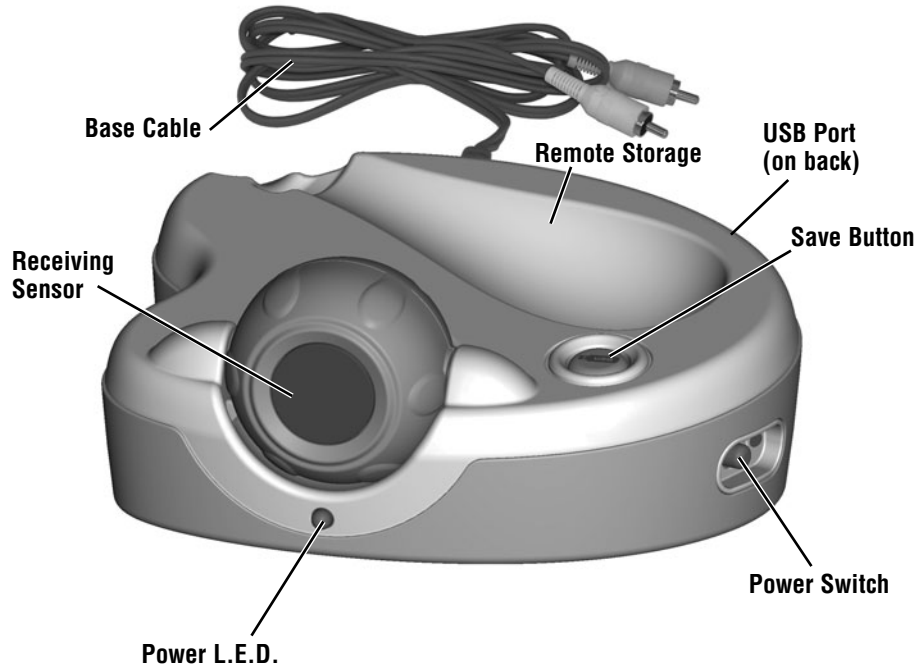

Base

Power Switch - Slide to turn power ON or OFF.

Power L.E.D. - Lights when power is ON. The L.E.D. flashes to indicate there is communication between the base and the wireless controller.

Base Cable - Plugs into your TV.

Save Button - Press to save your artwork on a USB flash drive (not included and sold separately).

USB Port (on back) - Insert a USB flash (not included and sold separately) into the port to save your artwork.

Receiving Sensor - Picks up a signal from the wireless controller. For best results, make sure the wireless controller is aligned with the sensor.

Features

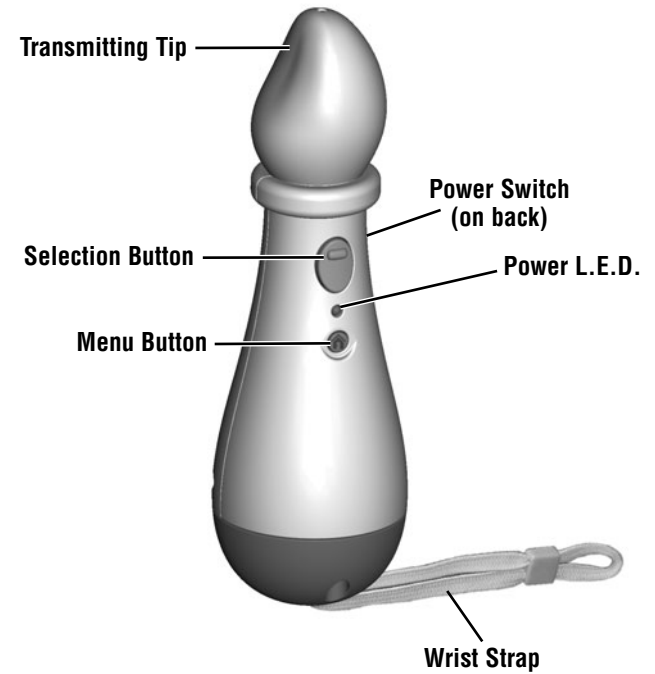

Wireless Controller

Power Switch (on back) - Slide to turn power ON or OFF.

Power L.E.D. - Lights when power is ON.

Transmitting Tip - Sends a signal to the sensor on the base.

Selection Button - Press to make on-screen selections. **Press and hold** when drawing, painting or spraying in the studios.

Menu Button - Press to access the main menu.



Wrist Strap - Always wear the wrist strap when using the wireless controller.

Battery Installation

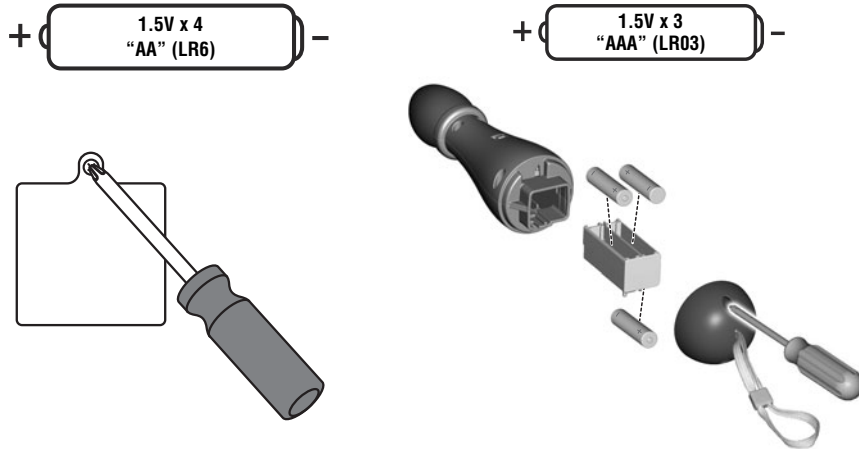

Note: We recommend using **alkaline** batteries for longer battery life. If the base/wireless controller begin to operate erratically, you may need to reset the electronics. Slide the power switch off and then back on.



Base

- Locate the battery compartment on the bottom of the base.
- Loosen the screws in the battery compartment door, and remove the door.
- Insert four "AA" (LR6) **alkaline** batteries.
- Replace the battery compartment door and tighten the screws. Do not over-tighten.
- When function is slow or stops or you see a low battery indicator   on your TV screen, it's time for an adult to change the batteries in the base.

Wireless Controller

- Locate the battery compartment on the end of the wireless controller.
- Loosen the screw in the battery compartment door, and remove the door.
- Insert three "AAA" (LR03) **alkaline** batteries.
- Replace the battery compartment door and tighten the screw. Do not over-tighten.
- When function is slow or stops or you see a low battery indicator   on your TV screen, it's time for an adult to change the batteries in the wireless controller.

Battery Safety Information

In exceptional circumstances, batteries may leak fluids that can cause a chemical burn injury or ruin your product. To avoid battery leakage:

- Do not mix old and new batteries or batteries of different types: alkaline, standard (carbon-zinc) or rechargeable (nickel-cadmium).
- Insert batteries as indicated inside the battery compartment.
- Remove batteries during long periods of non-use. Always remove exhausted batteries from the product. Dispose of batteries safely. Do not dispose of this product in a fire. The batteries inside may explode or leak.

- Never short-circuit the battery terminals.
- Use only batteries of the same or equivalent type, as recommended.
- Do not charge non-rechargeable batteries.
- Remove rechargeable batteries from the product before charging.
- If removable, rechargeable batteries are used, they are only to be charged under adult supervision

Connecting to Your TV

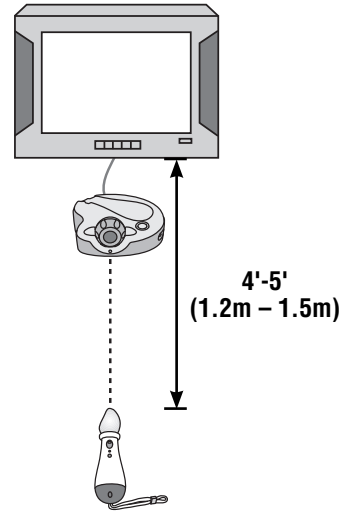
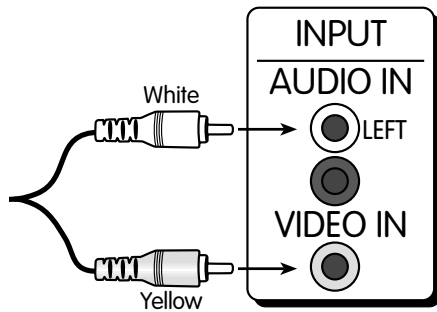

IMPORTANT! Your TV, VCR or DVD player must have audio and video input jacks.

- Locate the cable on the base.
- Plug the audio-video pins into the matching colored input jacks on your TV, VCR or DVD player (Yellow for Video In, White for Audio In).

Hint: We've included a detailed illustration to show how to connect the base to a TV or TV/VCR/DVD. Please see page 18.

- Position the base so that it is **centered in front of the TV.**
- Turn your TV, VCR or DVD player power ON.
- Slide the power switch on the base to turn it ON.
- To find the picture on your TV screen, set your TV's, VCR's or DVD player's mode selector to INPUT or VIDEO IN.
- Slide the power switch on the wireless controller ON.
- Have your child stand four to five feet (1.2m - 1.5m) away from the TV.
- Move the sensor up or down to get the best range for the wireless controller.
- Bright sunlight or incandescent light may affect the range between the wireless controller and the base. Try dimming the light slightly in the room of use.

Main Menu

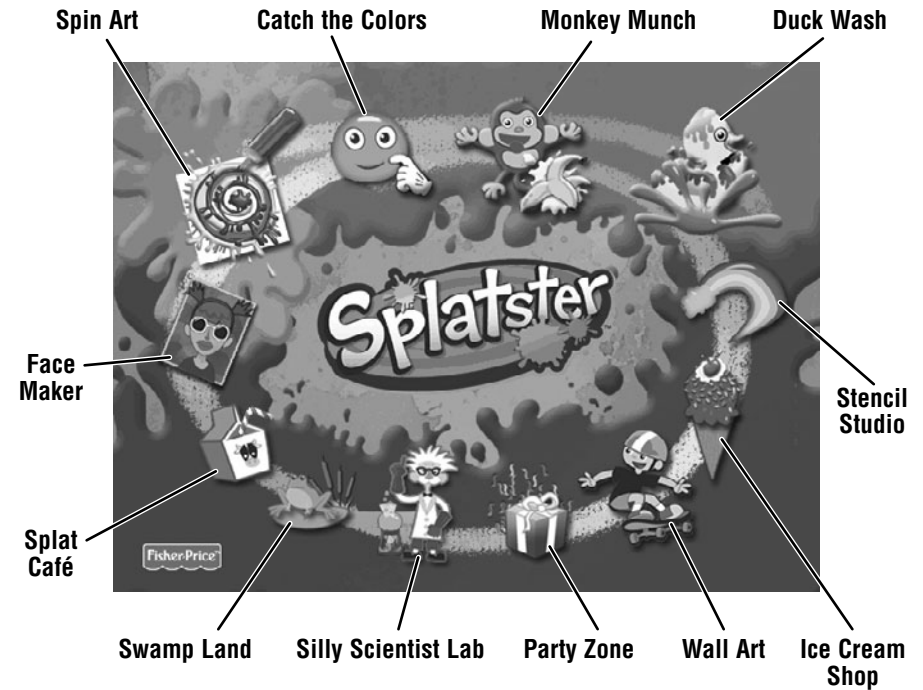

Splat Art Studios

- Choose from eight studios: Face Maker, Splat Café, Swamp Land, Silly Scientist Lab, Party Zone, Wall Art, Ice Cream Shop or Stencil Studio.

Splat Arcade Games

- Choose from three games with five levels of play!
 - Duck Wash - Ready, aim, spray & splat! Wash the paint-dirtied ducks squeaky clean, arcade-style!
 - Monkey Munch - There are 10 hungry monkeys that will eat anything you throw, but a miss sure makes a mess!
 - Catch the Colors - The colors have escaped from their paintings! You'll have to think and move fast to catch them!

Spin Art

- Choose from any of 10 colors to create awesome spin art!

Studios



- From the main menu, point the wireless controller at the studio you'd like to go to.
- Press the selection button on the wireless controller to choose the studio.

Color Palette

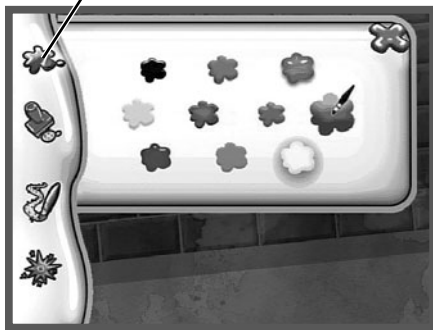

- Point the wireless controller at the color palette icon in each studio to choose a color.
- Press the selection button on the wireless controller.
- Point the wireless controller at the color you would like to use. Then, press the selection button to choose the color.



- Press and hold the selection button on the wireless controller while drawing on screen.



- Release the selection button and shake the wireless controller towards the TV to "splat" paint on your picture!

Studios

Stamper



- Point the wireless controller at the stamper icon in each studio to choose a stamp. Press the selection button on the wireless controller.
- Point the wireless controller at the stamper you would like to use. Then, press the selection button to choose the stamper.

Hint: Each studio has it's own stampers or click on the arrows to choose stampers from other studios!

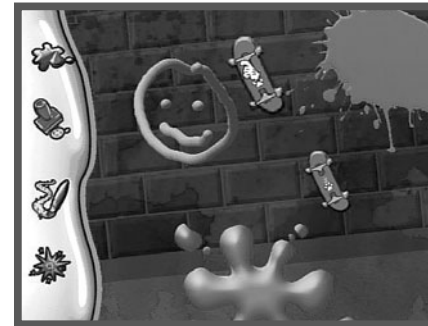

- Point the wireless controller at the screen and press the selection button to add it to your picture. You can also shake the wireless controller towards the TV to "splat" a larger version of the stamp onto your picture.

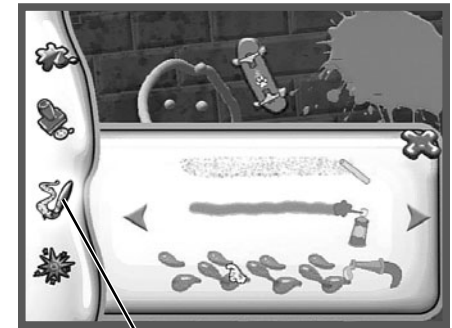

Brushes

- Point the wireless controller at the brushes icon to choose a special effect. Press the selection button on the wireless controller.
- Point the wireless controller at the effect you would like to use. Then, press the selection button to choose the effect.

Hint: Each studio has it's own special effects or point the wireless controller at the arrows and then press the selection button to choose special effects from other studios!



- Point the wireless controller at the screen and press and hold the selection button to paint on your picture. You can also shake the wireless controller towards the TV to "splat" a special effect on the picture.

Studios



Stencils

- Point the wireless controller at the stencils icon  to choose a stencil. Press the selection button on the wireless controller.
Hint: The stencils icon replaces the brushes icon in the Stencil Studio only.
- Point the wireless controller at the stencil you would like to use. Then, press the selection button to choose the stencil.

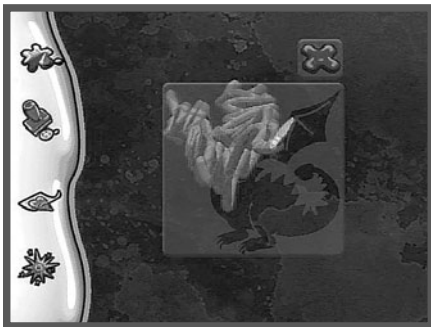

- Press and hold the selection button on the wireless controller while rubbing over the stencil.
Hint: You can also shake the wireless controller towards the TV to fill in the stencil faster!
- When you are finished, point the wireless controller at the  and press the selection button to remove the stencil and see your picture!

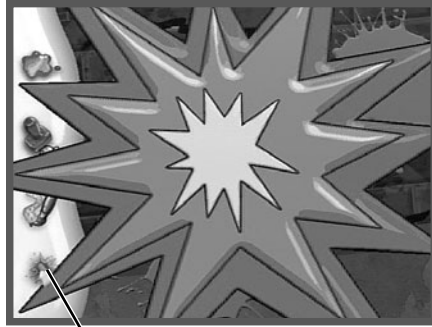

Erase

- Point the wireless controller at the erase icon  in any studio to erase your picture and start over. Press the selection button on the wireless controller.
Hint: You can save your picture before you erase it. See the Saving Pictures section on page 16.

Arcade Games

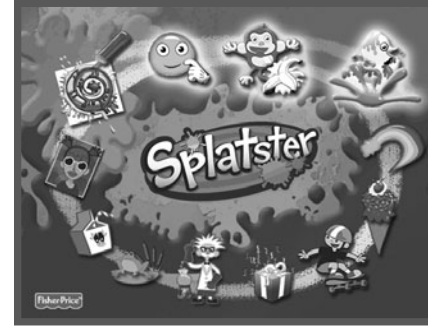

- Choose from three arcade games, each with five levels of fun!
- Point the wireless controller at the arcade game you would like to play on the main menu.
- Press the selection button on the wireless controller to choose the game.

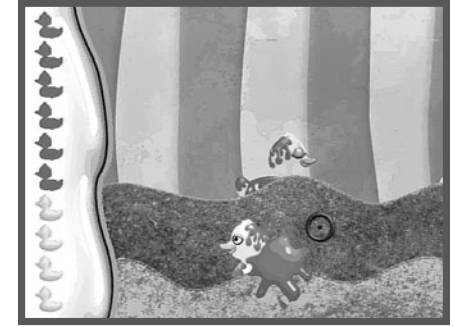

 Duck Wash

Wash the paint off all the paint-dirtied ducks

- Point the wireless controller at the ducks as they swim by. Press and hold the selection button on the wireless controller to spray them.
- You can also shake the wireless controller towards the TV to spray water at the ducks as they swim by.
- Try to wash all 10 ducks!

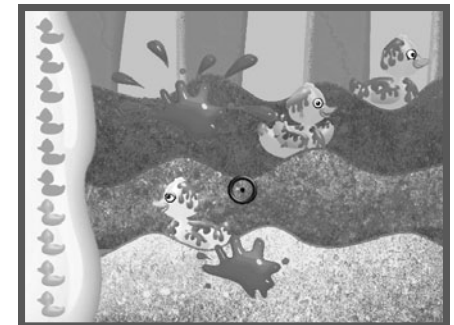

- Wash a different color duck in every level.
Hint: Try to wash the multi-colored duck in levels 3-5 to help you wash all the ducks faster!

Arcade Games



Feed the Monkeys

Help feed the monkeys!

- Point the wireless controller at the monkeys when they jump up. Press the selection button on the wireless controller to feed them.
- Hint: You can also shake the wireless controller towards the TV to throw them bigger bunches of food.*
- Try to feed all 10 monkeys.



- Feed the monkeys a different food in every level.
- Hint: Try to feed the swinging monkey in levels 3-5 to feed the monkeys faster!*

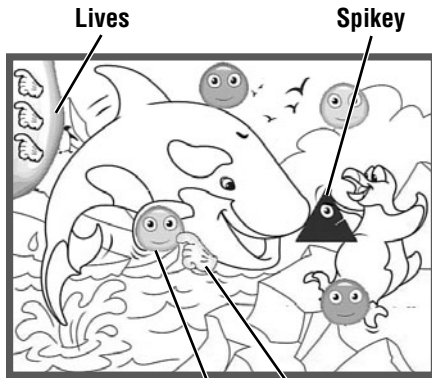

Catch the Colors

Catch the lost colors from the paintings!

- Move the wireless controller towards each color circle on screen to catch it.
- Don't catch a "spikey" or you will lose a (you have three in each game)!
- The color circles move faster and there are more "spikies" to avoid in every level. Catch the multi-colored circle to freeze the "spikies" while you catch the color circles.



- Catch all the colors to see the completed painting and move on to the next level.
- Finish all five levels and win a prize!

Spin Art



- Point the wireless controller at the spin art icon on the main menu.
- Press the selection button on the wireless controller to choose this activity.

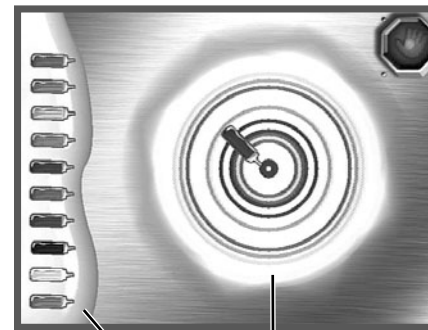

Colors Spinner

- Point the wireless controller at the color you would like to use. Press the selection button on the wireless controller to choose the color.
- Point the wireless controller at the spinner and press the selection button to add the color to your artwork.
- Repeat this procedure to add more colors.



- When you are finished, point the wireless controller at the red stop icon and press the selection button.
- Look at the splattered artwork you created!
- Point the wireless controller at the green go icon to create another spin art.
- Hint: You can save your picture before you erase it. See the Saving Pictures section on page 16.*

Saving Pictures



- To save your pictures from any of the studios or spin art, insert a USB flash drive (not included and sold separately) into the USB port on the back of the base.



- Press the save button on the base.

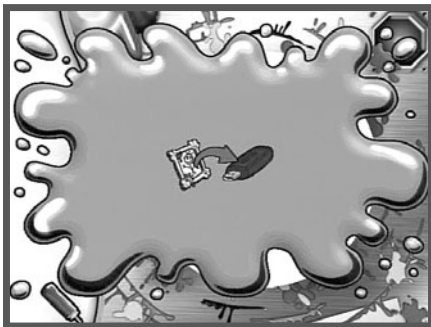

- This will save a bitmap (.bmp) file on your USB flash drive.



- Remove the USB flash drive from the base and insert it into the USB port on your computer (not included and sold separately).

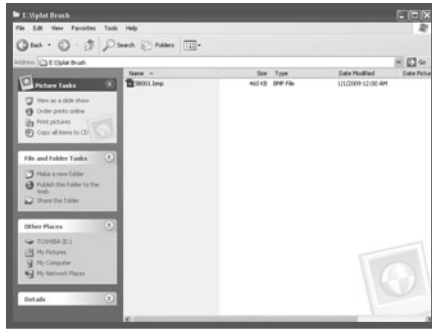

- From your computer, locate your flash drive.
Hint: The picture files are compatible on a PC or Mac.
- Double-click on the flash drive to open it. Then, locate and double click on the Splatster folder.



- Open the file on your computer with any picture viewing program to view and print your pictures.

Troubleshooting

Problem	Cause	Solution
No image on TV	TV or VCR/DVD player is not set to the proper input	Change the TV or VCR/DVD player's mode to INPUT or VIDEO IN.
		Press the channel down button on your TV or VCR/DVD player to change to a channel below channel 2.
		Consult your TV or VCR/DVD player's instruction manual.
	Batteries in the base are weak or exhausted	Replace the batteries in the base with four, new "AA" (LR6) alkaline batteries.
Base timed out (sleep mode)	The base times out after several minutes of inactivity. Press any button to turn it back on.	
No wireless connection between the base and the wireless remote	The base times out after several minutes of inactivity. Press any button to turn it back on.	Make sure you have a clear path between the base and the wireless controller. Do not place the base in a closed cabinet.
		The wireless controller is not aligned with the sensor on the base. Move the sensor up or down/make sure the wireless controller is in front of the sensor.
Images on TV look grainy or lose color	Batteries in the base are weak or exhausted	Replace the batteries in the base with four, new "AA" (LR6) alkaline batteries.
Base is not responding to actions from wireless controller	Signal from wireless controller to the base may not work properly if there is bright light behind you	Dim the lights behind you. Or use over-head/side lighting when possible.
	Interference from other remote controllers	Do not use other remote controllers at the same time as you are using this toy.
	Batteries in the wireless controller are weak or exhausted	Replace the batteries in the wireless controller with three "AAA" (LR03) alkaline batteries.
	Wireless controller is not pointing towards the base	Make sure the transmitting tip (brush end) on the wireless controller is pointed towards the sensor in the base.
Image is stretched or distorted on a wide screen TV	TV aspect ratio set incorrectly	This product is designed for use with a 4:3 aspect ratio (display setting) and you should see black bars on the sides of the image. For best picture, do not use a 16:9 aspect ratio (stretched) wide screen setting. For more information on changing this setting, refer to your TV owner's manual.

Consumer Information

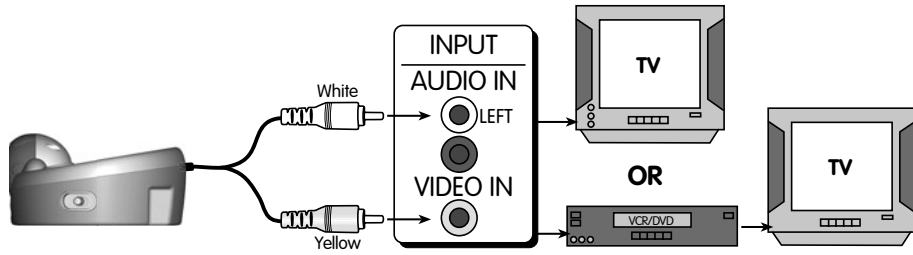

IMPORTANT! Your TV, VCR or DVD player must have audio and video input jacks. The input jacks may be on the back of your TV, VCR or DVD player.

Consumer Information

FCC Statement (United States Only)

This equipment has been tested and found to comply with the limits for a Class B digital device, pursuant to Part 15 of the FCC Rules. These limits are designed to provide reasonable protection against harmful interference in a residential installation. This equipment generates, uses and can radiate radio frequency energy and, if not installed and used in accordance with the instructions, may cause harmful interference to radio communications. However, there is no guarantee that interference will not occur in a particular installation. If this equipment does cause harmful interference to radio or television reception, which can be determined by turning the equipment off and on, the user is encouraged to try to correct the interference by one or more of the following measures:

- Reorient or relocate the receiving antenna.
- Increase the separation between the equipment and receiver.
- Consult the dealer or an experienced radio/TV technician for help.

Note: Changes or modifications not expressly approved by the manufacturer responsible for compliance could void the user's authority to operate the equipment. This device complies with Part 15 of the FCC Rules. Operation is subject to the following two conditions: (1) this device may not cause harmful interference and (2) this device must accept any interference received, including interference that may cause undesired operation.

ICES-003

This Class B digital apparatus complies with Canadian ICES-003. Operation is subject to the following two conditions: (1) this device may not cause harmful interference and (2) this device must accept any interference received, including interference that may cause undesired operation.

NMB-003

Cet appareil numérique de la classe B est conforme à la norme NMB-003 du Canada. L'utilisation de ce dispositif est autorisée seulement aux conditions suivantes : (1) il ne doit pas produire de brouillage et (2) l'utilisateur du dispositif doit être prêt à accepter tout brouillage radioélectrique reçu, même si ce brouillage est susceptible de compromettre le fonctionnement du dispositif.



- Protect the environment by not disposing of this product with household waste (2002/96/EC). Check your local authority for recycling advice and facilities (Europe only).