

850 GLT Owner's Manual OWNER'S MANUAL

• **USA & CANADA**
VOLVO
850 GLT
1 9 9 3

This manual deals with the operation and care of your Volvo



Welcome to the world-wide family of Volvo owners. We trust that you will enjoy many years of safe driving in your Volvo, an automobile designed with your safety and comfort in mind. To help ensure your satisfaction with this vehicle, we encourage you to familiarize yourself with the equipment descriptions, operating instructions and maintenance requirements/recommendations in this manual. We also urge you and your passengers to wear seat belts at all times in this (or any other) automobile. And, of course, please do not operate a vehicle if you may be affected by alcohol, medication or any impairment that could hinder your ability to drive.

Your Volvo is designed to meet all applicable safety and emission standards, as evidenced by the certification labels attached to the door opening and on the left wheel housing in the engine compartment. For further information regarding these regulations, please contact your dealer.

Contents

Important!

You should be familiar with the information in the first three chapters before you operate the car. Information contained in the balance of the manual is extremely useful and should be studied after operating the vehicle for the first time.

This manual is structured so that it can be used for reference. It should thus be kept in the car for ready access.

Do not export your Volvo to another country before investigating that country's applicable safety and exhaust emission requirements. In some cases it may be difficult or impossible to comply with these requirements. Modifications to the emission control system(s) may render your Volvo not certifiable for legal operation in the U.S., Canada or other countries.

All information, illustrations and specifications contained in this manual are based on the latest product information available at the time of publication. Volvo reserves the right to make model changes at any time, or to change specifications or design, without notice and without incurring obligation.

[Instruments and controls ... 1](#)

[Body and interior ... 2](#)

[Occupant safety, Reporting safety defects ... 3](#)

[Starting and driving ... 4](#)

[Wheels and tires ... 5](#)

[In case of emergency ... 6](#)

[Car care ... 7](#)

[Service and routine maintenance ... 8](#)

[Specifications ... 9](#)

© Volvo Cars of North America



[Contents](#) | [Top of Page](#)

Instruments and Controls

Instruments, switches and controls

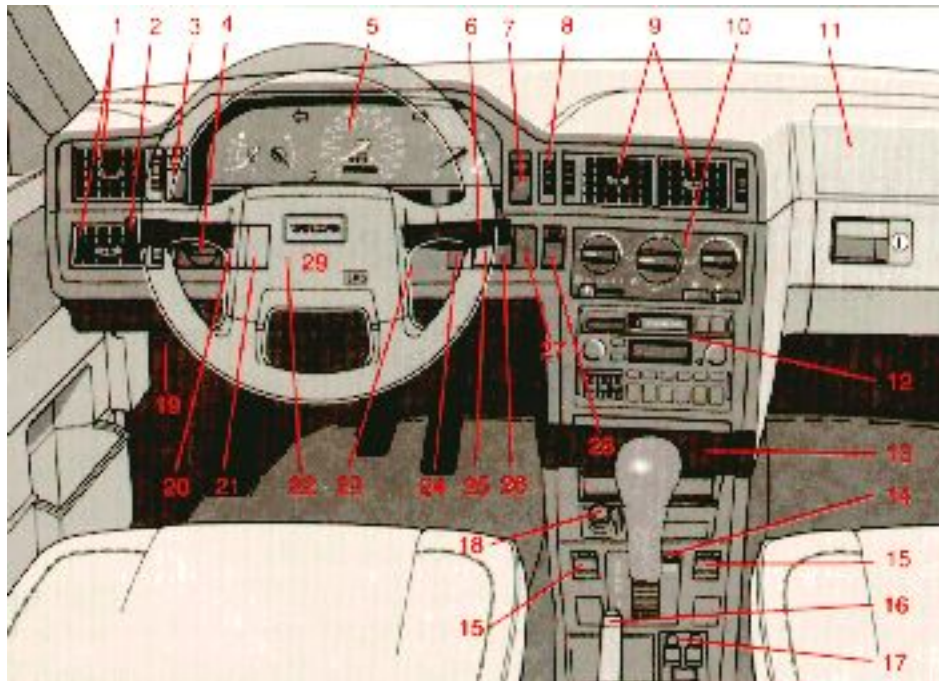

pg. 1:1 Instruments, switches and controls (cont.)

IMPORTANT! (Automatic transmission only)
Your car is equipped with a Shiftlock-Keylock system.

SHIFTLOCK: When your car is parked, the gear selector is locked in the (P)ark position. To release the selector from this position, turn the ignition key to position II (or start the engine), depress the brake pedal, press the button on the front side of the gear selector and move the selector from (P)ark. If it is necessary to manually override the Shiftlock system, see page 6:18 for instructions.

KEYLOCK: This means that when you switch off the ignition, the gear selector must be in the (P)ark position before the starting (ignition) key can be removed from the ignition switch.

The pages in this section provide detailed descriptions of the vehicle's instruments and controls. Note that vehicles may be equipped differently, depending on special legal requirements.

- [1:15](#) 1 Air vent
- [1:6](#) 2 Turn signals, high/low beams,
- [1:14](#) cruise control
- [1:8](#) 3 Rear fog light, instrument lighting

- [1:6](#) 4 Headlights, parking lights
- [1:2-1:5](#) 5 Instruments
- [1:7](#) 6 Windshield wiper/washer
- [1:9](#) 7 Hazard warning flashers
- [1:15](#) 8 Air mix
- [1:15](#) 9 Air vents
- [1:15-1:19](#) 10 Heating and ventilation controls
- [3:6](#) 11 Passenger side SRS (air bag) hatch
- [1:21-1:37](#) 12 Audio system
- [1:13](#) 13 Ash tray
- [6:18](#) 14 Shiftlock override button
- [1:12](#) 15 Electrically-heated front seats (optional)
- [1:13](#) 16 Parking brake
- [1:20](#) 17 Electrically operated windows
- [2:7](#) and side door mirrors
- [1:13](#) 18 Cigarette lighter
- [2:10](#) 19 Hood release
- 20 Space for additional equipment
- 21 Space for additional equipment
- [1:14](#) 22 Adjustable steering wheel
- [1:7](#) 23 Starting (ignition) switch/steering wheel lock
- 24 Space for additional equipment
- [1:4](#), [1:9](#) 25 Traction control system (optional)
- [2:9](#) 26 Electrically operated sun roof (optional)
- 27 Space for additional equipment
- [1:9](#) 28 Heated rear window/heated door mirrors
- [3:4](#) 29 Horn/SRS

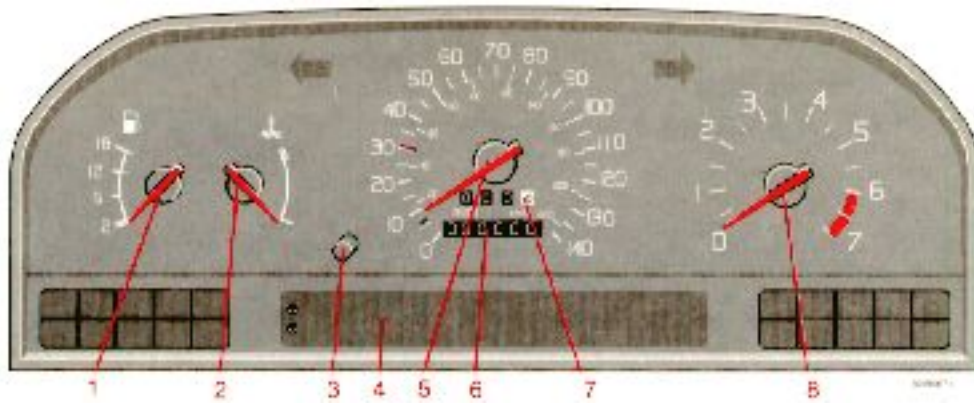

1 Fuel gauge

The fuel tank holds approximately 19.3 US gals. (73 liters). When the warning light comes on there is approximately 1.8 US gals. (8 liters) of fuel remaining. See "Refueling" for further information.

2 Temperature gauge

The pointer should be approximately midway on the gauge face when driving. If the pointer approaches the red range repeatedly, check coolant level and fan belt tension. Do not drive the car with the pointer in the red range. See sections "Coolant" and "Drive belts".

3 Trip odometer reset button

4 Clock, Ambient temperature sensor

5 Speedometer

6 Odometer

7 Trip odometer

Used for measuring shorter distances. The last digit indicates 1/10 mile/kilometer. A black number on a white background = original speedometer. A red number on a white background = replacement speedometer.

8 Tachometer

Reads thousands of engine rpm. Engine should not be operated in red range. The highest permitted constant engine speed is 6,300 rpm.



- 1 Turn signal, left
- 2 Turn signal, right
- 3 Low engine oil level (certain models)
- 4 Low washer fluid level
If the lamp glows continuously when the engine is running, there is only about 1/2 - 1 US qt. remaining in the washer fluid reservoir.
- 5 Low fuel level
When the lamp glows, only about 1.8 US gals. (8 liters) of fuel remain
- 6 Rear fog light
- 7 High beams
- 8 (Not in use)
- 9 Bulb failure warning sensor
- 10 Bulb failure warning sensor, trailer
- 11 (Not in use)
- 12 SRS
- 13 Generator not charging
- 14 Low engine oil pressure
- 15 Brake warning light
- 16 Parking brake applied
- 17 ABS-system
- 18 Transmission mode "W", or gear positions 3 or L engaged (automatic transmission)
- 19 Low coolant level
- 20 Traction Control System (option)
- 21 Malfunction indicator lamp
- 22 Service reminder indicator

pg. 1:4 Warning lights

The warning lights described on pages 1:4 and 1:5 should never stay on when driving

When the ignition key is turned on and before the engine starts, all of the warning lights should go on to

test the function of the bulbs. Should a light not go off after the engine has started, the system indicated should be inspected. However, the parking brake reminder light will not go off until the parking brake has been fully released.



Generator warning light

If the light comes on while the engine is running, check the tension of the generator drive belt as soon as possible.

NOTE: This warning light is illuminated if the generator is not charging. However, parking brake, brake failure and bulb failure warning lights will be illuminated at the same time due to the design of the system.



Malfunction indicator lamp

If the lamp comes on (or stays on after the vehicle has started), the engine diagnostic system has detected a possible fault in the emission controls. Although driveability may not be affected, see an authorized Volvo dealer as soon as possible for inspection.



Oil pressure warning light

If the light comes on while driving, the oil pressure is too low. Stop the car and then stop the engine immediately and check the engine oil level. See the section titled "Engine oil". If the light stays on after restart, have the car towed to the nearest authorized Volvo dealer. After hard driving, the light may come on occasionally when the engine is idling. This is normal, provided it goes off when the engine speed is increased.



Parking brake reminder light

This light will be on when the parking brake (hand brake) is applied. The parking brake lever is situated between the front seats. Canadian models are equipped with this warning light: 



Brake fluid warning light

If the light comes on while driving or braking, this indicates that the brake fluid level is too low. Stop immediately, open the hood and check the brake fluid level in the reservoir (see section "Engine

compartment" for reservoir position)!

Canadian models are equipped with this warning light: 

WARNING! If the level is below the MIN mark in either section of the reservoir: **DO NOT DRIVE.** Tow the car to a Volvo dealer and have the brake system checked and any leakage repaired.



TRACS warning light (option)

If this lamp comes on while driving, a fault is indicated in the TRAction Control System. The system should be checked by an authorized Volvo dealer. See page 1:9 for additional information.

pg. 1:5 Warning lights (cont.)

ABS

Anti-lock Brake system (ABS)

If the warning lamp lights up there is a malfunction of the ABS system (the standard braking system will however function). The vehicle should be driven to a Volvo dealer for inspection. See page 4:16 for additional information.

Canadian models are equipped with this warning light: 



Mode "W" engaged

The lamp will light up when the Winter starting mode is engaged or if gears "3" or "L" are selected. If the warning lamp begins to flash, this means that there is a fault in the automatic gearbox. Contact your Volvo dealer.

**LOW OIL
LEVEL**

Low engine oil level (certain models)

This lamp will light up when the ignition is switched on. If it remains on after the engine has started, park the car on a level surface and check the oil according to the instructions on page 8:10. If the lamp remains on even if the oil level is correct, the system should be checked by an authorized Volvo dealer.

SRS

Supplemental Restraint System (SRS)

If the light comes on (or stays on after the vehicle has started), the SRS diagnostic system has detected a fault. Drive to an authorized Volvo dealer for an inspection of the system. See the SRS section for more information.



Service reminder indicator

This light will come on at 10,000 mile (16,000 km) intervals, after 750 hours of driving or after 12 months, whichever occurs first. It is a reminder to the driver that the service interval has been exceeded. The light will stay on 2 minutes after the start until reset by the servicing dealer.



Coolant level sensor

If the light comes on while driving, the coolant level is low. The coolant level in the expansion tank should be checked immediately and topped up if necessary. The cooling system should be inspected by an authorized Volvo dealer.



Turn signal indicators, trailers

When towing a trailer, this light will flash simultaneously with the turn signals on the trailer. If the light does not flash when signalling, neither the trailer's turn signals nor the car's turn signals are functioning.



Bulb failure warning light

The light will come on if any of the following bulbs are defective:

- one of the low beam headlights
- one of the tail lights
- one of the brake lights when the brake pedal is depressed.

Check the fuse and bulb. See sections "Replacing bulbs" and "fuses".

Should the warning light come on after a defective outside bulb has been replaced, the corresponding bulb on the other side of the car should also be replaced.

pg. 1:6 Headlights, Parking lights, Turn signals

Headlights and parking lights

 All lights off *

 Parking lights on *

 Headlights and parking lights are on if starting (ignition) switch is in position I or II.

If the headlight switch is in position  all lights will go out when starting switch is switched off.
With the headlight switch in position  the parking lights will stay on.

The high beams can only be switched on if the headlight switch is in position .

Switch from high to low beams and vice versa by moving the turn signal switch lever on the left side of the steering column towards the steering wheel.

* Canadian models equipped with Daytime Running lights: The low beams will come on automatically when the engine is started.

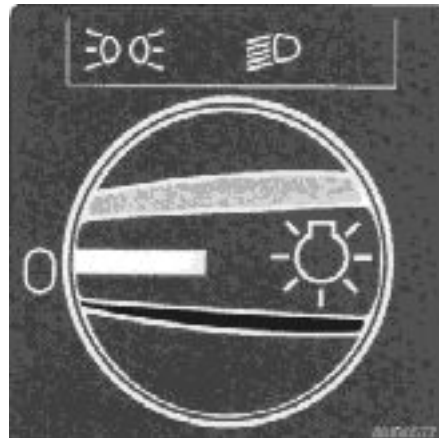

Turn signals

1 Lane change position : In maneuvers such as lane changing, the driver can flash the turn signals by moving the turn signal lever to the first stop and holding it there. The lever will return to the neutral position when released.

2 Signal lever engaged for normal turns.

3 High beam/low beam switch (headlights on)

Move the lever towards the steering wheel and release it.

4 Headlight flasher (headlights off)

Move the lever towards the steering wheel. The headlight high beam will be on until the lever is released.

NOTE: A defective turn signal bulb will cause the turn signal indicator and remaining signal lights to flash more rapidly than normal.

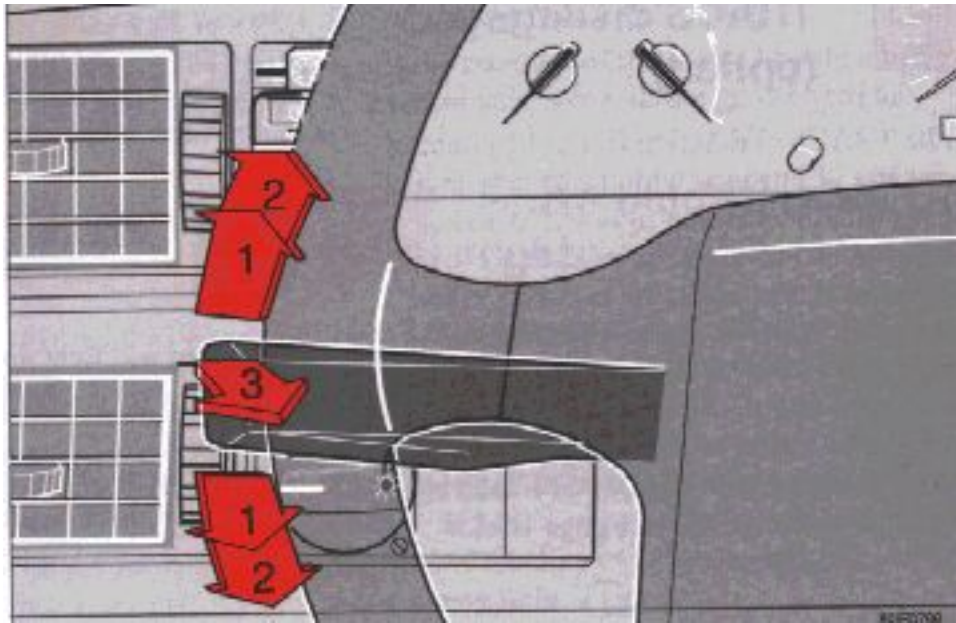

[Contents](#) | [Top of Page](#)

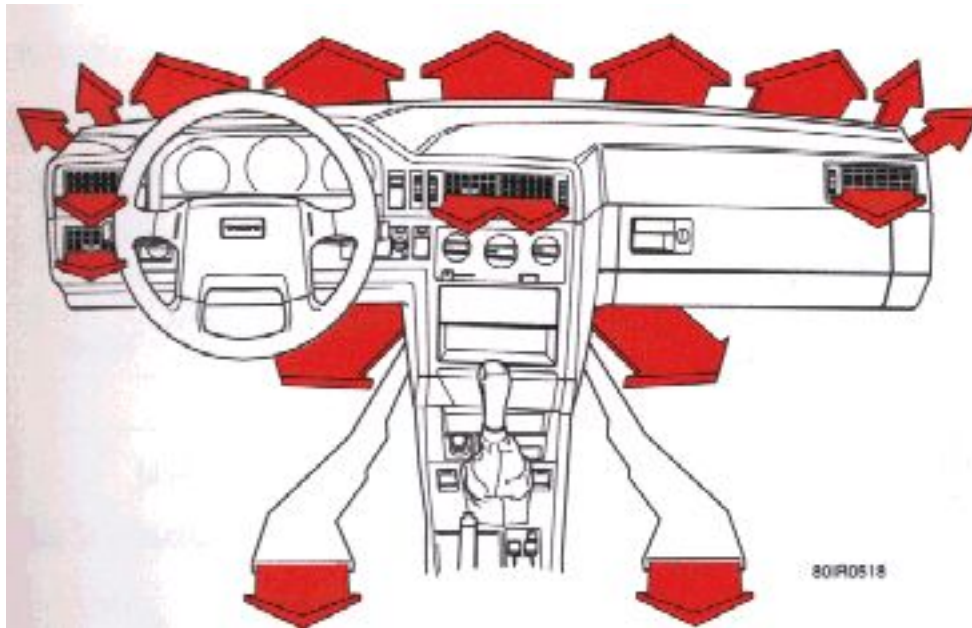

Heating and air conditioning

Your Volvo is equipped with a heating system combined with air conditioning. Depending on which function you select, warm or cool/cold air is distributed to the different parts of the passenger compartment.

A slight amount of condensation may be emitted from the air vents when the air conditioning is initially switched on. This can occur when both humidity and ambient temperature are high and is normal.

Refrigerant

The air conditioning system in your car contains a CFC-free refrigerant - R134a. This is an environmentally friendly substance having minimal effect on the earth's ozone layer. The system contains 1.65 lbs (0.75 kg) R134a.

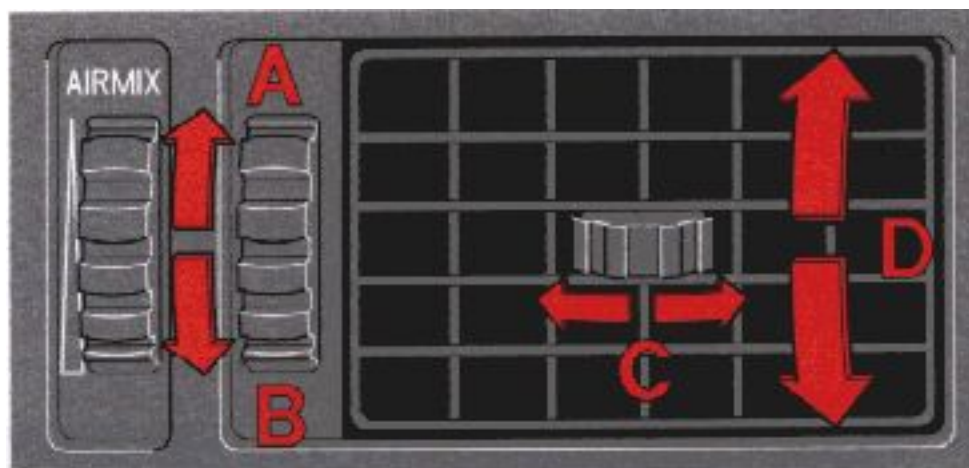

Air vents (dash)

A Closed

B Open

C Directing air flow horizontally

D Directing air flow vertically



Air mix

The center panel vents have an air mix function which allows fresh air to enter the passenger compartment when the vents are open (position B).

pg. 1:16 Heating, ventilation and air conditioning (standard unit)

Temperature dial Driver's side Set desired temperature	Function selector Set desired function	Temperature dial Passenger's side Set desired temperature
---	--	--



Blower 0 = Off 4 = Highest blower speed	 Air in the passenger compartment recirculates. Will not function in defrost setting. The light is ON when the function is engaged.	 The AC system is engaged when the light is ON.
--	--	--

 Air through the panel vents



Defrost. Air to windshield and side windows



Air to floor, windshield and side windows



Air through floor vents



Bi-level. Air through floor and panel vents

pg. 1:17 Heating, ventilation and air conditioning (standard unit) (cont.)

Maximum heating:

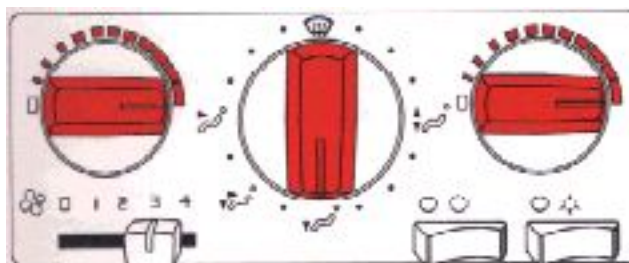

Close the center panel vents. When the passenger compartment has become sufficiently warm, set the blower control to position 2 and adjust the temperature.

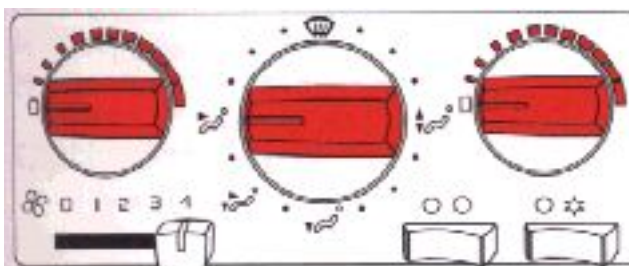

Maximum cooling:



Open the vents. The AC system should be ON. Adjust the temperature with the temperature selectors.

To demist / defrost the windows:



Set the function selector to . When the windows have cleared, set the blower control to position 2 and the function selector to . Always keep the air intake grille at the base of the windshield under the rear edge of the hood free of snow.

Additional information

- The air conditioning system will function best if it is used regularly (at least once a month).
- Water under the vehicle in hot weather can be the result of condensation from the air conditioning system and is quite normal.
- The air conditioning system functions only at temperatures above 45° F (7° C).
-  Choose this position if the outside air is contaminated with exhaust gases, smoke, etc or to heat/cool the car quickly. In this position, very little air is drawn into the passenger from the outside. Do not leave the system in this mode for more than 10-15 minutes since the air inside the car will become stale. The temperature can be controlled with the temperature selectors.
- If the panel vents are open, a certain amount of air will always flow through, regardless of the position the function selector is in. To increase the flow of air to either the floor or the windows, close the panel vents. The outer vents can be opened to avoid mist on the side windows.
- The panel vents may emit some condensation when the air conditioning is initially switched on and is quite normal. This may occur if the ambient temperature and humidity are high.
- The air conditioning is momentarily disengaged during full-throttle acceleration.

pg. 1:18 Heating, ventilation and air conditioning (Electronic Climate Control) - option

Temperature dial Driver's side Set desired temperature	Function selector Set desired function	Temperature dial Passenger's side Set desired temperature
---	--	--

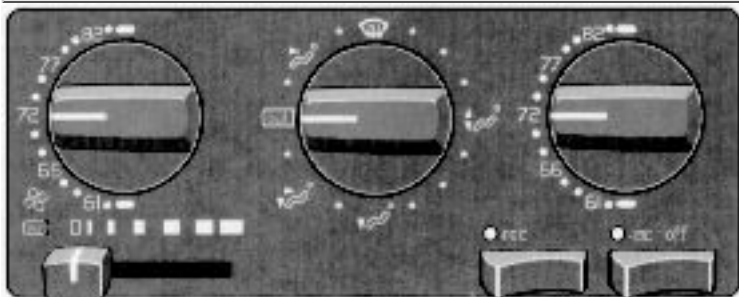

The AC system is engaged when the light is OFF.

When the function selector is in the defrost setting, the AC system is ON regardless of the button position.

<p>Blower = Blower speed automatically regulated 0 = off Move the knob to the right to increase the blower speed.</p>	<p>Air in the passenger compartment recirculates. Will not function in defrost setting. The light is ON when the function is engaged.</p>
---	---

Air distribution automatically regulated.



Air through the panel vents



Defrost. Air to windshield and side windows



Air to floor, windshield and side windows



Air through floor vents



Bi-level. Air through floor and panel vents.

pg. 1:19 Heating, ventilation and air conditioning (Electronic Climate Control) - option (cont.)

Automatic setting

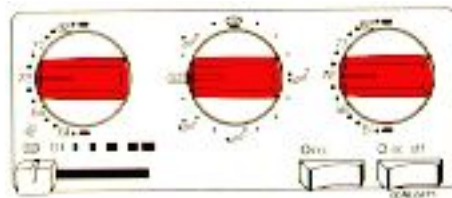

Set the mode selector to and select the desired temperature. The blower will run at its maximum speed in either the max heating or max cooling positions.

Optimum defrosting

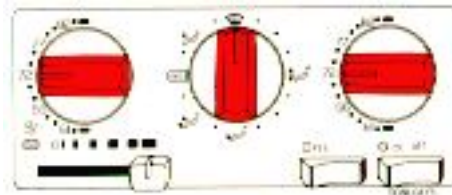

Set the function selector to  and move the blower control to the maximum speed position (as far to the right as possible). When the windows have cleared, set the blower at a lower speed or in the position.

Additional information

- The air conditioning system will function best if it is used regularly (at least once a month).
- Always keep the air intake grille at the base of the windshield under the rear edge of the hood free of snow.
- Water under the vehicle in hot weather can be the result of condensation from the air conditioning system and is quite normal.
- The air conditioning is disengaged when the blower is set at 0 and the speed of the vehicle is less than 30 mph (50 km/h).
- The air conditioning system functions only at temperatures above 45°F (7°C).
- Recirculation : Choose this position if the outside air is contaminated with exhaust gases, smoke etc. or to heat/cool the car quickly. In this position, very little air is drawn into the passenger compartment from outside. Do not leave the system in this mode for more than 10-15 minutes since the air inside the car will become stale and condensation will form on the windows. The temperature can be controlled with the temperature dials.
- If the panel vents are open, a certain amount of air will always flow through, regardless of the position the function dial is in. To increase the flow of air to either the floor or the windows, close the panel vents. The outer vents can be opened to avoid mist on the side windows.
- The panel vents may emit some condensation when the air conditioning is initially switched on and is quite normal. This may occur if the ambient temperature and humidity are high.
- The temperature sensor (located at the top center of the dashboard) should not be covered in any way as this could cause incorrect information to be sent to the ECC system.
- The air conditioning is momentarily disengaged during full-throttle acceleration.

Faults in the ECC system

The and lights will flash for approximately 20 seconds if a fault is detected in the ECC system. If this flashing recurs the next time the system is switched on, the climate control unit should be checked by an authorized Volvo dealer.

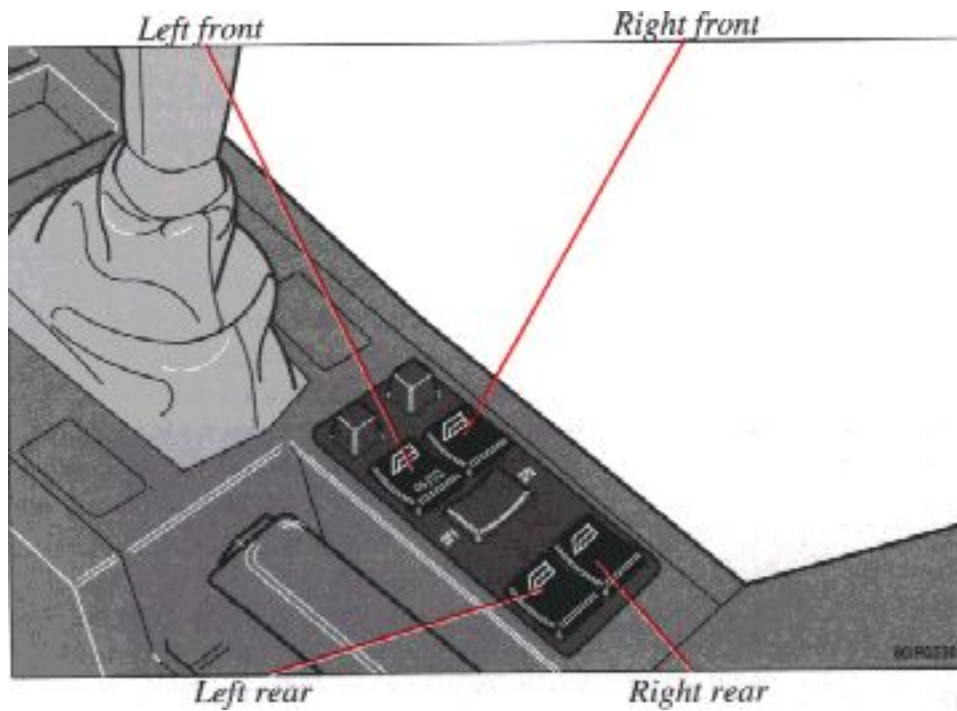

Electrically-operated windows

The electrically operated windows are controlled by switches in the center console as shown in the illustration above.

The starting (ignition) switches must be ON (position II) for the electrically-operated windows to function. The window is lowered if the rear part of the switch is pressed and raised if the front part of the switch is pressed.

NOTE: Driver's window only (AUTO): The window can be opened completely by pressing the rear part of the switch lightly and releasing it immediately. The window can be stopped by pressing the button again. If the button is held down, the window will be lowered until the button is released.

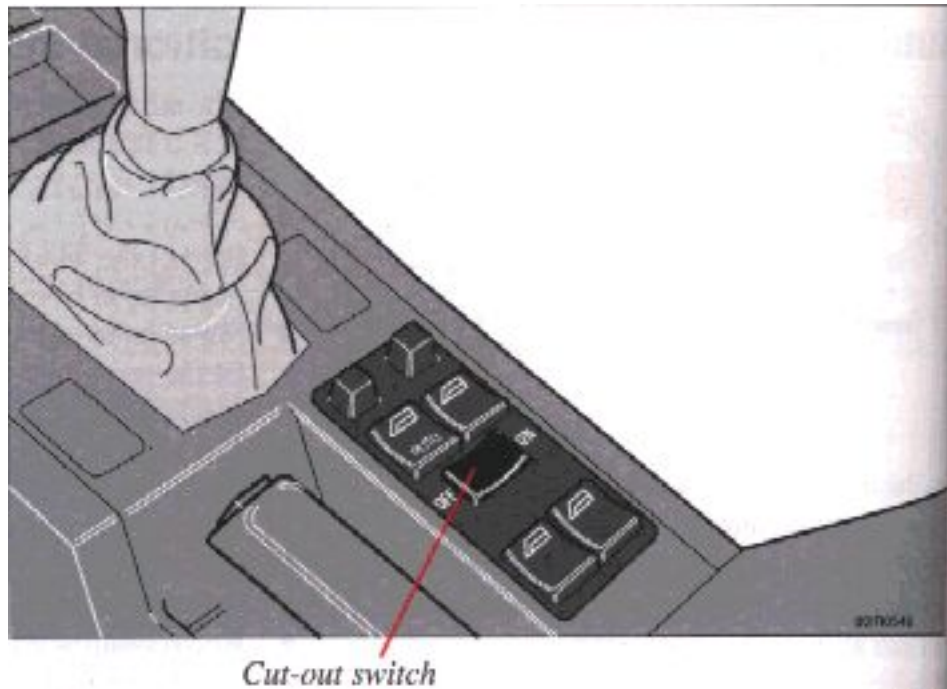

Cut-out switch for electrically-operated rear-door windows

If your car is equipped with electrically-operated rear door windows, this function can be disabled by a switch located on the center console. This switch is positioned 90° in relation to the other switches. The rear door windows can be raised or lowered with the respective door switches as well as with the switches on the center console.

The rear door windows cannot be raised or lowered with the respective door switches but instead only with the corresponding switches on the center console.

WARNING! Remove the starting (ignition) key when children are left unattended in the vehicle.

Make sure that children's hands are clear before raising the windows.



[Contents](#) | [Top of Page](#)

The following pages describe the use of your SC-810 Cassette Radio and CD remote control



1.

- On/off (turn)
 - Volume (turn)
 - Pause/Mute (push)
2. CD mode selector
3. Bass control
4. Treble control
5. Fader control
6. Waveband selectors (FM)
7. Waveband selectors (AM)
8. Preset buttons
- CD - Disc No. selector
9. Autostore memory (FM)
10. Autostore memory (AM)
- 11.
- Manual tuning
 - Seek tuning (push)

12. Tape direction selector REV

CD - Random play

13. Cassette eject

14. Display

15. Cassette slot

16. TP -Next song

CD -Next track UP

17. TP -Fast forward

CD -Music search UP

18. TP -Rewind

CD -Music search DOWN

19. TP -Previous song REPEAT

CD -Previous track DOWN

20. Tape mode selector

TP = Applicable only in tape mode

CD = Applicable only when in CD mode and connected to a CD changer

pg. 1:22 Anti-theft code

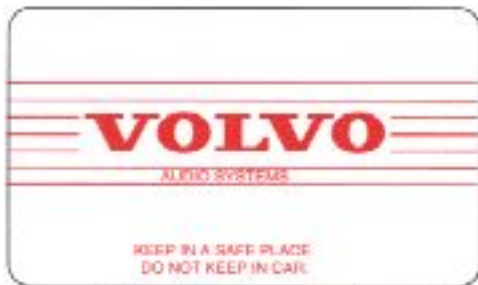



Anti-theft code

The radio features anti-theft circuitry. If the set is removed from the vehicle or if the battery power is disconnected, a special code must be entered to enable operation of the set.

Refer to the radio code card supplied with your vehicle or ask your retailer for the correct code .

To enter the code

After installation or when the set has been disconnected from power, the set displays "codE" when it is switched on.

Enter the 4-digit code using the preset buttons. If the correct code is entered, "on" is displayed and the set is ready to use.

If you enter an incorrect code you must enter the correct code again from the beginning.

Incorrect code

If an incorrect code has been entered "rPt" is displayed. Enter the correct code.

After three unsuccessful coding attempts the set will lock and remain locked for two hours.

"OFF" is displayed.

After two hours have elapsed, re-enter the correct code.

NOTE: During the two hours waiting period, the set must be connected and turned on.



A - On/off switch and volume control

Turn the button clockwise to switch on and to increase the volume.

B - Waveband selector

The desired waveband is set by pressing one of the waveband selector buttons. The frequency and waveband is shown on the display.

NOTE: There are two FM wavebands and two AM wavebands. This makes it possible to store 2 x 6 FM stations and 2 x 6 AM stations in memory.

C - Manual tuning

Turn the knob counter-clockwise to tune to lower frequencies and clockwise to tune to higher frequencies. The tuned frequency is displayed.

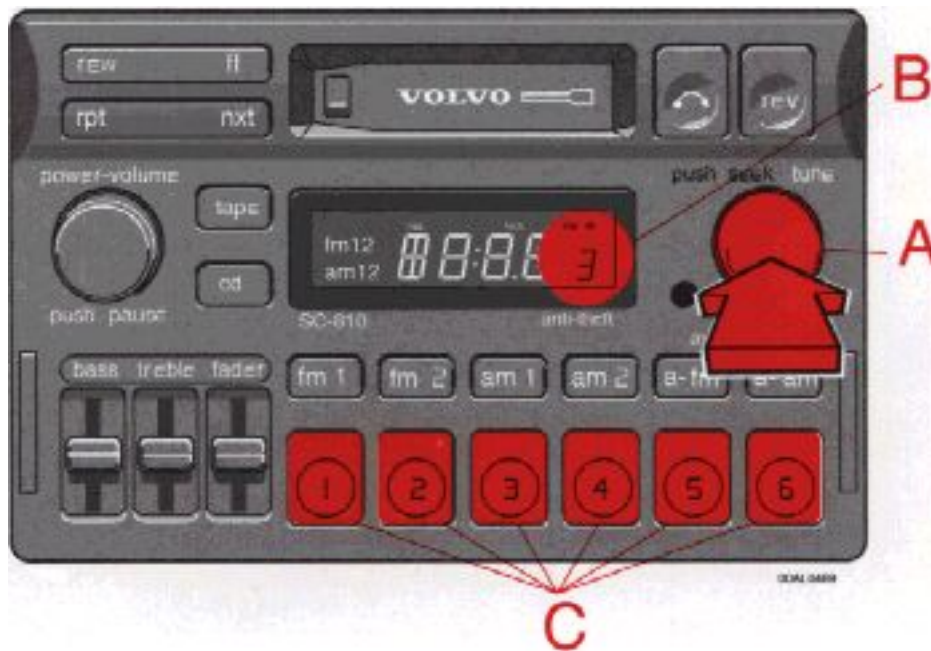

A - Seek tuning

Push the tuning knob to seek for higher frequencies. The radio seeks the next audible station and stops there. If you wish to continue the seek tuning, press the tuning knob again.

B - Preset programming

1. Tune to the desired frequency.
2. Depress and hold a preset button. The audio will cut out. Keep the button depressed until the audio comes on again (approx. 2 seconds).
3. The frequency is now stored on this preset button.

C - Preset buttons

To select a pre-programmed radio frequency, depress the preset button. The set frequency will be displayed.

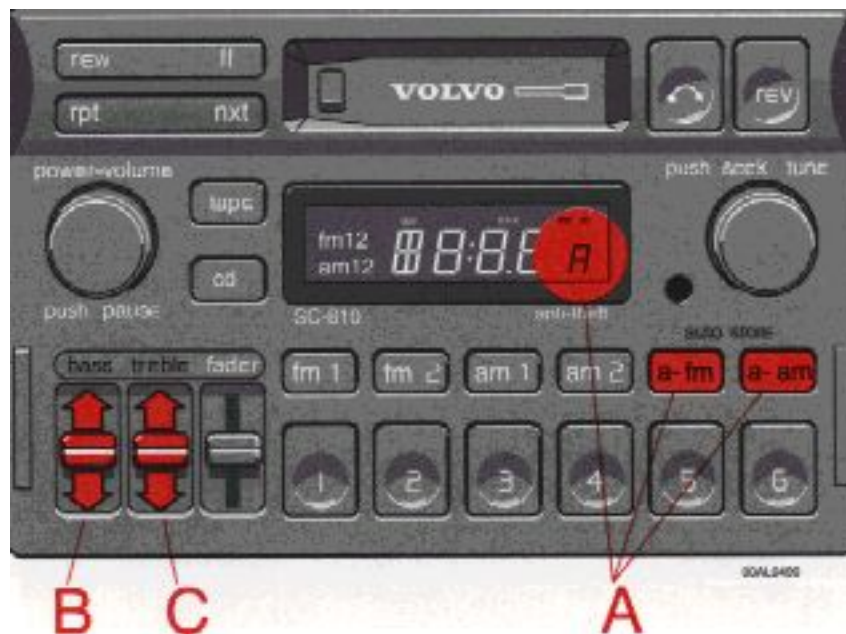

A - Automatic programming (Autostore)

This function automatically seeks and stores up to 8 strong AM or FM stations. This is especially useful when traveling in areas where radio stations are unfamiliar.

1. Depress and hold one of the "auto store" buttons for at least 1 second. A number of strong stations (max. 8) on the chosen waveband are now automatically stored in the memory. The lowest frequency station is heard. If there are no audible stations, "no" is displayed.
2. Press one of the "auto store" buttons (for less than 1 second) to obtain another autostored station. A new station will be selected each time one of these buttons is pressed.

B - Bass control

Adjust the bass by sliding the control up or down (up to increase, down to decrease). A "detent" indicates "equalized" bass.

C - Treble control

Adjust the treble by sliding the control up or down (up to increase, down to decrease). A "detent" indicates "equalized" treble.



Mute function

Press the "power-volume" knob to temporarily mute the sound. "PAUSE" is displayed.

Fader control

Adjust front/rear speaker balance by sliding the control up or down.
(Up to direct more sound to the front speakers, down to direct more sound to the rear speakers.
The "detent" indicates "equalized" front/rear balance position.



[Contents](#) | [Top of Page](#)



A - Cassette slot

The cassette is inserted with the open side to the right (side 1 or A of the cassette upwards). When the cassette is inserted, the radio is disengaged and the cassette will start to play automatically. "TAPE 1" or "TAPE 2" is displayed to indicate which side of the tape is being played. When one side of the tape has been played the unit will automatically play the other side (auto-reverse). The cassette can be inserted or ejected even when the unit is switched off.

B - Reversing the tape (rev)

Press the button to play the other side of the tape.
The side of the tape being played will be displayed.

C - Fast winding

The tape is advanced with "ff" and rewind with "rew". The tape side indicator in the display will flash rapidly during fast winding. Fast winding can be stopped by pressing the button again.



A - "nxt" (next) selector

Press the "nxt" button and the tape will automatically advance to the next song. There must be a pause of approx. 5 seconds between songs for this function to operate.

B - "rpt" (repeat) selector

Press the "rpt" button to rewind the tape to the beginning of the song. Press the button again to rewind to the beginning of the previous song. There must be a pause of approx. 5 seconds between songs for this function to operate.

C - Pause

If you press the "power-volume" knob the tape is stopped, the unit is silent and "PAUSE" is displayed. To restart the tape press the knob again.



A - Cassette eject

If the button is pressed the tape will stop and the cassette will be ejected. The radio will be automatically engaged. The radio or CD will engage automatically (depending on which mode was activated before the tape was played).

B - To re-enter Radio mode

There are three alternative ways to re-enter Radio mode:

- Push one of the waveband selector buttons
- Push either of the autostore buttons
- Push one of the preset buttons

When the unit re-enters Radio mode, the cassette will not be ejected.

C - To re-enter Tape mode

If the Tape function has been disconnected and the cassette has not been ejected, the Tape mode can re-entered by pressing the "tape" button.

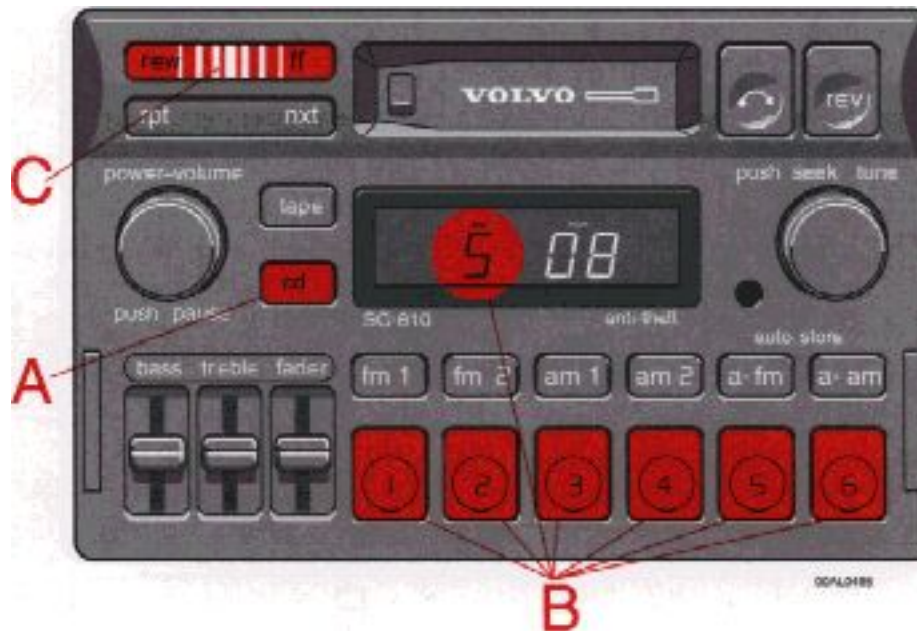

A - CD mode selector

Press "cd" to actuate the CD mode. The disc/track last listened to will continue to play. If the CD-changer cartridge* is empty, "---" will be displayed.

If a selected disc does not exist, the disc number and "5--" will be displayed and the next disc will be automatically selected.

* The functions pertaining to the CD-changer are only applicable if the unit has been connected to the Volvo CD-changer which is sold separately as an accessory.

B - Disc number selector

Depress one of the preset buttons (1-6) to select the disc number desired. The selected disc number and track number will be displayed.

C - Music search

Press the "rew" or "ff" button to search within a track. While the button is depressed the playing time for this track will be displayed.

pg. 1:31 CD - Remote (accessory) (cont.)



A - Track number selector

Turn the knob to select the track number desired.

B - Changing the selected track number

Press "nxt" for forward selection or "rpt" for backward selection. The chosen disc number and track number will be displayed.

C - Playing-time display

When this button is pressed the playing time for the current track is displayed for 5 seconds.

pg. 1:32 CD Remote (accessory) (cont.)



A - Random choice

Press "rev" to actuate the random mode. From a disc chosen at random, 4 tracks will be played (also chosen at random). A new disc will then be played in the same way. "RND" will be displayed when this function is engaged.

B - Pause

If you press the "power-volume" knob, the disc is stopped, the unit is silent and "PAUSE" is displayed. To restart the disc press the knob again.

C - To re-enter the Radio mode

There are two ways to re-enter Radio mode:

- Push one of the waveband selector buttons
- Push either of the autostore buttons

D - To re-enter Tape mode

If a cassette is already inserted, the tape deck will re-engage if the "tape" button is pressed.

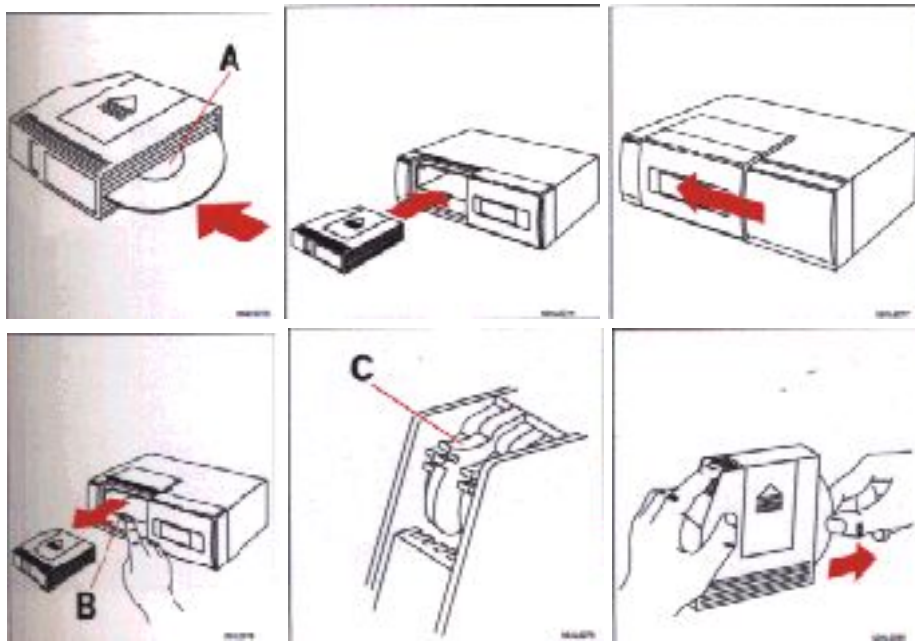

CD changer

The CD changer, which is available separately, is loaded with a cartridge containing 6 discs. Extra cartridges are available at your Volvo dealer.

Insert the discs into the cartridge, label (A) up. Insert the cartridge and close the cover.

Eject the cartridge by pressing the eject button (B).

Remove the discs by depressing the lock tabs (C).

Operating tips :

- Before using a new disc for the first time, remove any burrs in the center/outer edge by running the stem of a pen or similar object around the hole/edge of the disc.
- Use high quality discs only.
- Keep the discs clean. Wipe them with a soft, clean, lint-free cloth, working from the center outwards. If necessary, dampen the cloth with a neutral soap solution. Dry thoroughly before using.
- Never use cleaning spray or anti-static liquid. Use only cleaners specifically made for CD's.
- Use discs of the correct size only (3.5" discs should never be used).
- Do not put tape or labels on the disc itself.
- Condensation may occur on discs/optical components of the changer in cold winter weather. The disc can be dried with a clean, lint-free cloth. Optical components in the CD changer may, however, take up to one hour to dry off.
- Never attempt to play a disc which is damaged in any way.
- When not in use, the discs should be stored in their covers. Avoid storing discs in excessive heat, direct sunlight or dusty locations.



[Contents](#) | [Top of Page](#)

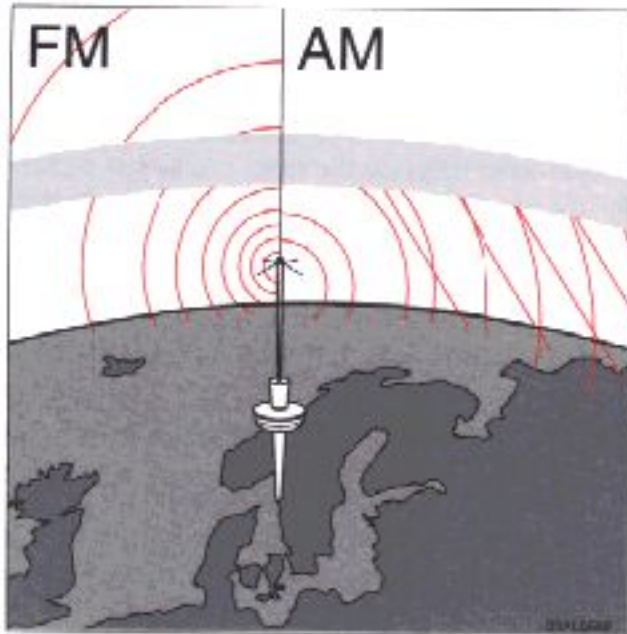

Sending signals

The FM waves do not follow the earth's surface nor do they bounce off the atmosphere. For this reason their range is limited. The AM waves follow the earth's surface and reflect against the atmosphere, giving them a wide range.

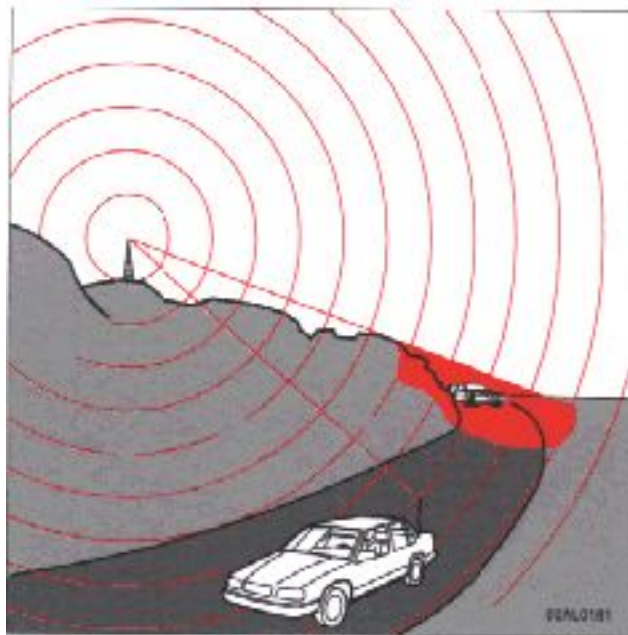

Weak reception (fading)

Because of the limited range of the FM senders and the fact that these waves are very reflective, this problem usually occurs with FM reception. If the sender is blocked by buildings or mountains, static can result.

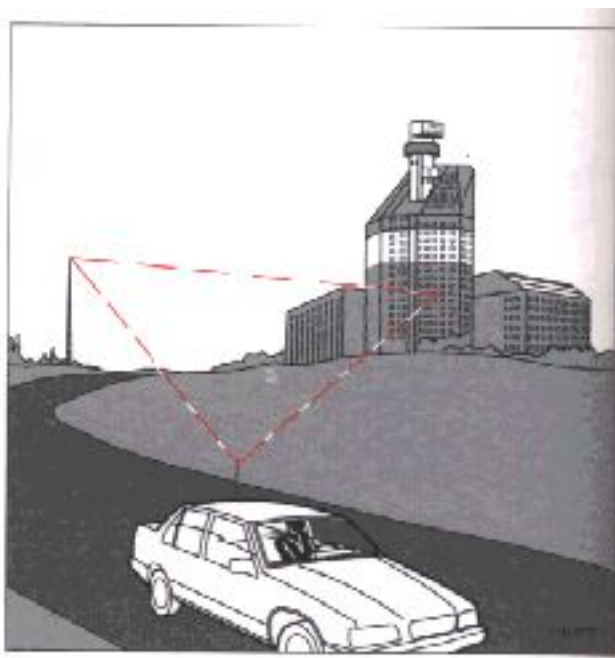

Static

The reason why FM but not AM is audible in covered parking areas, under bridges, etc., is that FM signals reflect against solid objects such as buildings. Because these waves are very reflective, static can result. This static is the result of the reflected signal and the direct signal reaching your antenna at slightly different times causing a cancellation of all signals. This problem occurs largely in built-up areas. To help minimize this situation, turn down the treble and turn off loudness.

pg. 1:35 Cross modulation, FM - reasons for distortion, AM - reasons for distortion

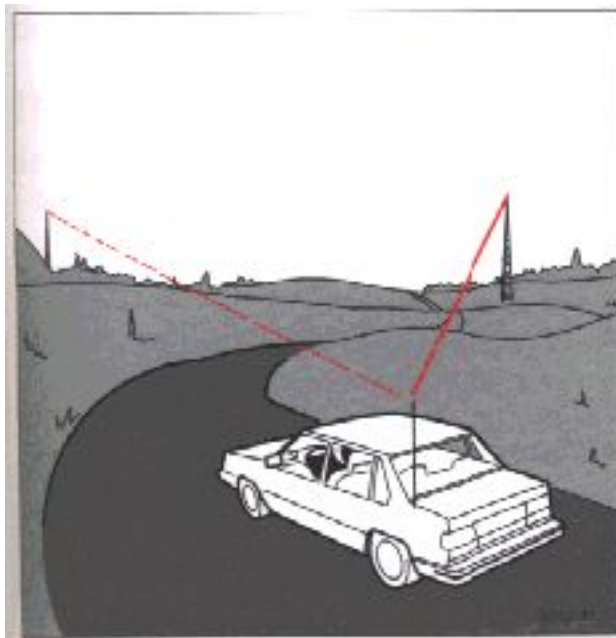

Cross modulation

If you listen to a weak station in the vicinity of a stronger one, both stations may be received simultaneously.

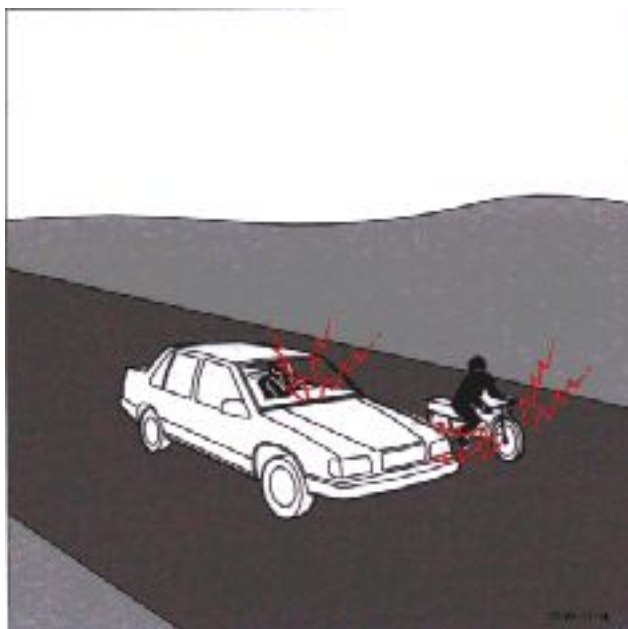

FM - reasons for distortion

FM is affected by the electrical systems of nearby vehicles, especially those without suppression. The distortion increases if the station is weak or poorly set.

The FM reception is not as sensitive to electrical disturbances as AM.



AM - reasons for distortion

AM reception is sensitive to electrical disturbances such as power lines, lightning, etc.

pg. 1:36 Radio

FM stereo reception

Stereo reception places very high demands on the signal quality which means the type of distortions previously mentioned become even more obvious. The signal strength needs to be stronger for good stereo reception and this limits the effective range of the slender.

We hope that this information proves to be useful and provides you with a better understanding of the problems related to car radio reception.

Reception conditions are not always optimum and this is, of course, beyond our control. However, we have endeavored to make the Volvo Audio System of a quality that will enable you to enjoy the best possible reception no matter what the reception conditions may be.

Radio antenna

NOTE: Always lower the antenna when using an automatic car wash or entering a garage. The antenna should be cleaned at least every 10,000 miles (16,000 km) or more frequently if needed. Use WD40 for cleaning.

Spray the antenna with WD40 and wipe it clean and dry with a rag. Spray it again. Lower and raise the antenna. Wipe it clean and dry again. Lower and raise the antenna 4-6 times. Make sure it is dry and free from dirt/lubricating oil.

Cassettes

- Store cassettes in their cases.
- Do not touch the tape surface with your fingers.
- Tapes should not be exposed to direct sunlight or extreme temperatures.
- Keep tapes away from oil, grease and other contaminants.
- For optimal tape deck performance Volvo does not recommend the use of C-120 tapes.
- Take up slack using a pen or a pencil before inserting a cassette in the cassette slot.

Cassette cleaning

We recommend the use of the Volvo Cleaning Cassette available as a genuine Volvo accessory. Regular use improves sound quality, cleans vital parts and prevents tape tangle.

pg. 1:37 Technical specifications

Technical specifications

Output: 4 x 20 W (10% dist.)

Output impedance: 4 Ohms

System voltage: 12 Volts, negative ground

Fuse: 5 A

Radio

System: superheterodyne system with HF-step.

Electronic suppression device

Frequency range:

SC - 810 FM 87.9 - 107.9 MHz

AM 530 - 1710 kHz

Sensitivity: FM 1.1 μ V

AM 20 μ V

Stereo separation: 35 dB

Cassette deck 4-track, 2 channel stereo

Tape speed: 4.76 cm/sec.

Channel separation: 48 dB

Frequency range: 30-15000 hz

S/N (120 μ V) 55 dB

S/N (70 μ V) 55 dB

Wow and Flutter: 0.13 %



[Contents](#) | [Top of Page](#)

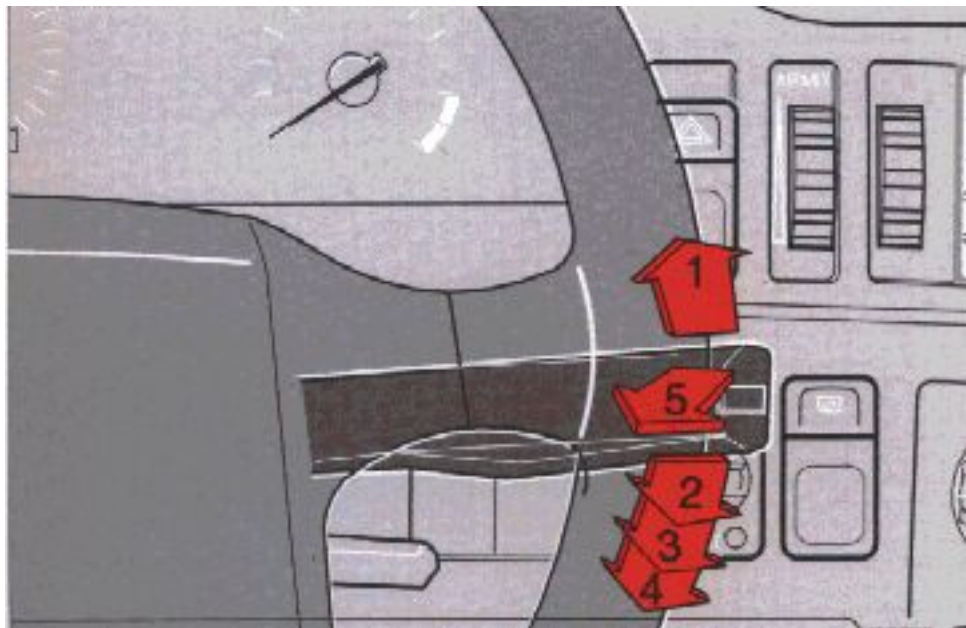

Windshield wiper/washer

1 Intermittent wiper.

With the switch in this position, the wipers will sweep approximately every seventh second.

2 "Single sweep" position:

The switch returns automatically when released

3 Wipers, normal speed.

4 Wipers, high speed

5 Windshield wiper/washer

The wiper will make 2-3 complete sweeps after lever is released.

O Locked position:

Remove the key to lock the steering wheel*

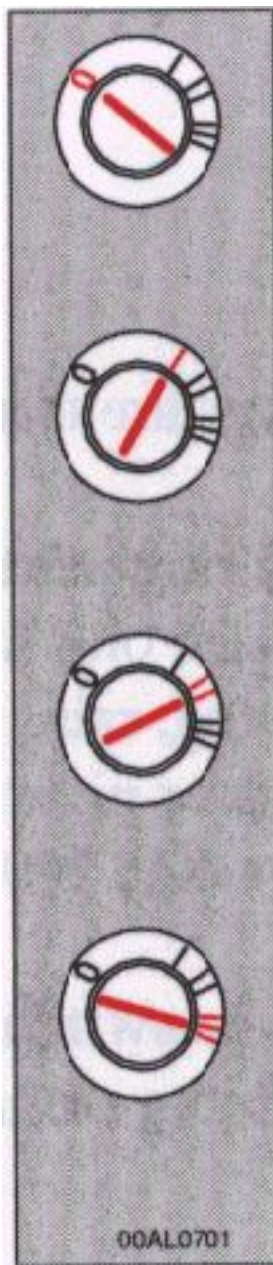

WARNING! Never turn the key to position O while driving or when the car is being towed.

I Intermediate position:
Certain accessories, etc. on.

II Drive position:
Key position when engine is running.

III Starting position:
Release the key when the engine starts. The key returns automatically to driving position.

* On cars equipped with an automatic transmission the gear selector must also be in the (P)ark position.

Starting (ignition) switch/steering wheel lock

The steering wheel lock might be under tension when the car is parked. Turn the steering wheel slightly to free the ignition key.

In order to reduce car theft, make sure the steering wheel lock is engaged before leaving the car.

A chime will sound if the starting key is left in the ignition lock and the front door on the driver's side is opened.

pg. 1:8 Instrument illumination, Fog light

A - Instrument illumination

To increase the brightness: move the slide switch to the right.

To decrease the brightness: move the slide switch to the left.

B - Rear foglight

The rear foglight (located in the driver's side tail light cluster) is considerably brighter than the normal tail lights and should be used only when the atmospheric conditions, such as fog, rain, snow, smoke or dust reduce the daytime or nighttime visibility of other vehicles to less than 500 ft (150 meters). For the rear fog light to function, the low beam headlights must be switched on.

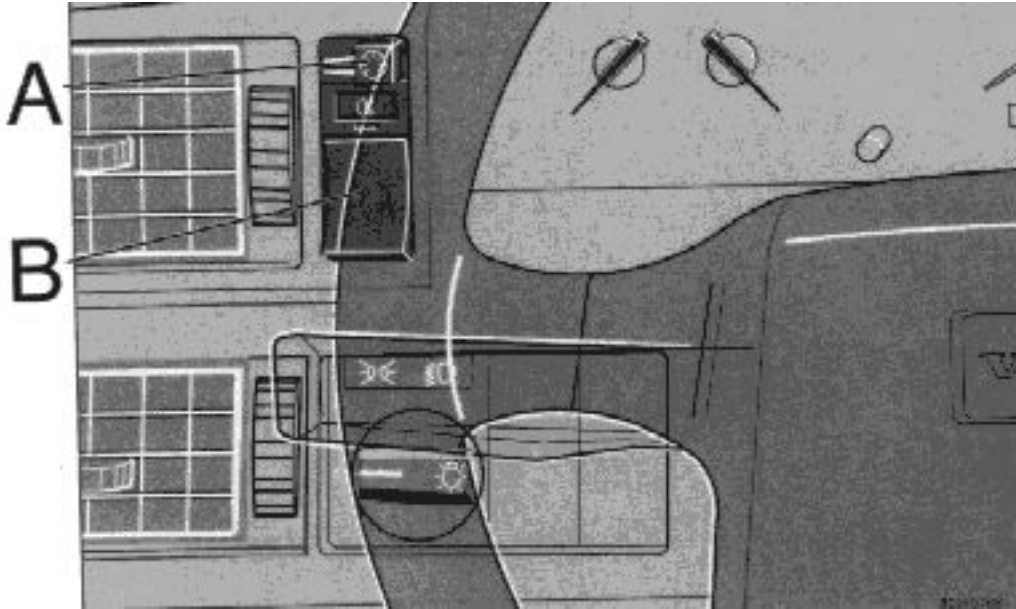

pg. 1:9 Sun roof, TRACS, Hazard warning flashers, Rear window demister

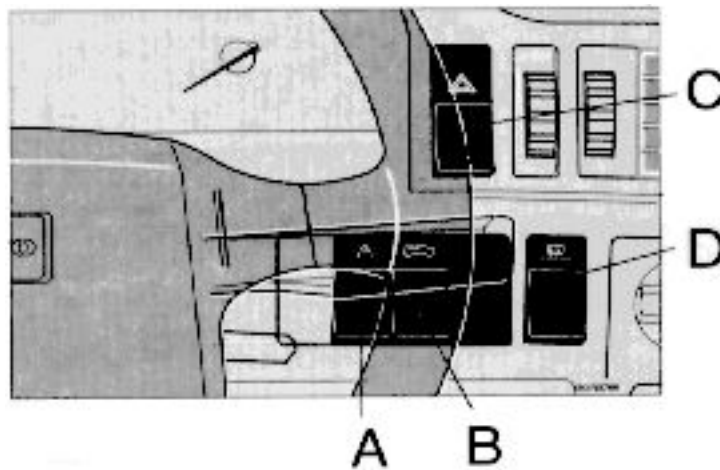

A - TRAction Control System (TRACS) - option

TRACS is a system designed as an aid when starting/driving off if one of the drive wheels has poor traction due to weather conditions or the road surface and connected to the ABS control module.

TRACS is switched on manually with a button on the dashboard (see page 1:9). The indicator lamp in the button will light up when the system is ON. With the button in the ON position, TRACS activates automatically if one of the front wheels loses traction, shifting power to the wheel with best traction. A sound from the ABS control module may be audible at this time. The system functions only at speeds under 25 mph (40 km/h).

B - Electrically operated sun roof - option

The sun roof can be operated in two ways; as a conventional sliding roof or the rear edge can be raised to provide increased ventilation. To open the sun roof as a sliding roof, depress the lower section of the switch. To raise the rear edge of the sun roof, depress the upper section of the switch.

To close the sun roof, depress the side of the rocker switch opposite the side used to open the roof.

NOTE: In case of a sun roof malfunction, see "Emergency sun roof operation", page 6:17.

C - Hazard warning flashers

The four-way flasher should be used to indicate that the vehicle has become a traffic hazard.

NOTE: Regulations regarding the use of the hazard warning flasher may vary from state to state.

D - Rear window demister, heated side-view mirrors

Press the switch to start heating the rear window and side-view mirrors. The control light in the switch will illuminate.

A timer switches off the system after approximately 12 minutes. The control light will go out correspondingly.

pg. 1:10 Clock, Ambient temperature sensor



Resetting the clock

The digital clock can be reset by pressing one of the two buttons (A and B) with a pointed object such as the tip of a pen.

h = hours

m = minutes

Maintain the pressure on the buttons for more than four seconds to change the time more quickly.

Ambient temperature sensor

This sensor indicates the temperature slightly above the road surface. A red warning lamp (C) lights up when the temperature is in the range of 23 - 36° F (-5 - +2° C). At low speeds or when the car is not moving, the temperature readings may be slightly higher than the actual ambient temperature due to the heat generated by the engine.

Display alternatives

If buttons A and B are pressed down simultaneously, it is possible to shift between four different display alternatives, as follows:

Press 1st time: 12 hour clock and °F

Press 2nd time: 24 hour clock and °F

Press 3rd time: 12 hour clock and °C

Press 4th time: 24 hour clock and °C

pg. 1:11 Cruise control

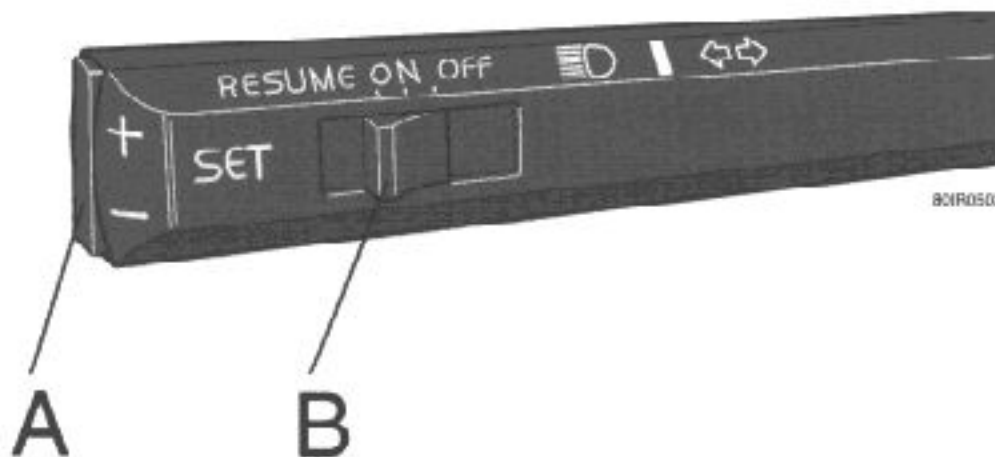

Cruise control

The cruise control switches are located on the turn signal switch lever.

To engage and set the desired speed:

1. Set switch (B) to ON.
2. Accelerate to the desired cruise speed.

NOTE: The cruise control cannot be engaged at speeds below 22 mph (35 km).

3. Press the + or - area of the SET button (A) to set the desired speed.

Braking

This will automatically disengage the cruise control. Previously selected cruise speed is retained in the memory and by momentarily setting the switch to the RESUME position, that speed will be re-engaged. If the cruise control is already engaged, the cruising speed can be increased or decreased by depressing the SET button (A) towards either + or -. One short press on the button corresponds to a speed change of approx. 1 mph (1.6 km/h). When the button is released, the vehicle will maintain the current speed. If actual speed falls below 70% of set speed or if the wheels spin or lock, the cruise control will disengage automatically.

NOTE: (AUTOMATIC TRANSMISSION)

When driving up steep hills with the cruise control engaged, the transmission may shift intermittently. This can be avoided by switching between transmission modes E or S while on the hill. Normally, the (E)conomy mode should be used when the cruise control is engaged.

Acceleration

Momentary acceleration, such as for passing, does not interrupt cruise control operation. The previously selected speed will be maintained without having to set the switch to RESUME.

To disengage the cruise control system:

Set switch (B) to OFF, depress the brake pedal or move the gear selector to position N. Switching off the starting (ignition) switch will automatically disengage the cruise control system.

On cars equipped with manual transmissions, the cruise control can also be disengaged by depressing the clutch.

WARNING! The cruise control should not be used in heavy traffic or when driving on wet or slippery roads.

pg. 1:12 Heated front seats

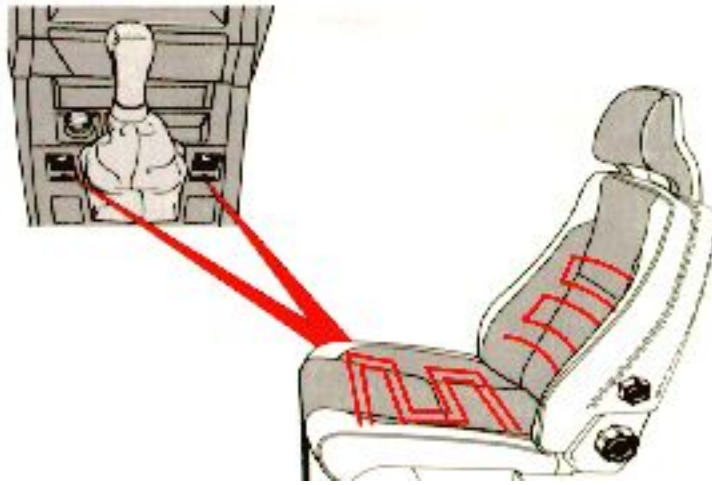

Heated front seats

The heated front seats can be switched on and off as required. When switched on, the system senses the ambient temperature and regulates the level of heat applied. When the optimum temperature is reached, the heating is switched off automatically. While driving, the passenger seat heating should be switched off when the seat is not occupied.

pg. 1:13 Parking brake, Cigarette lighter, Ashtrays

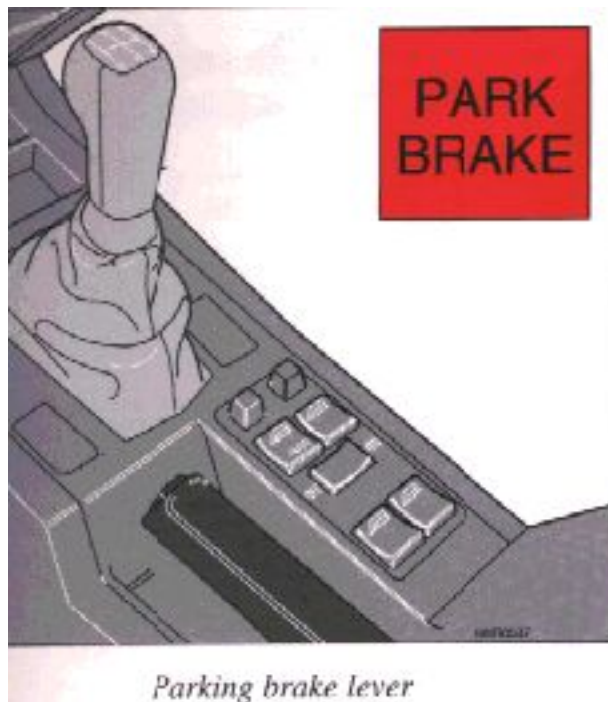

Parking brake (hand brake)

The lever is situated between the front seats. The brake is applied to the rear wheels.

WARNING! Always use the parking brake (hand brake) when parking. On hills, also turn the front wheels toward the curb.

In order to obtain the best possible performance from the parking brake, the brake linings should be broken in. See section "Break-in period".

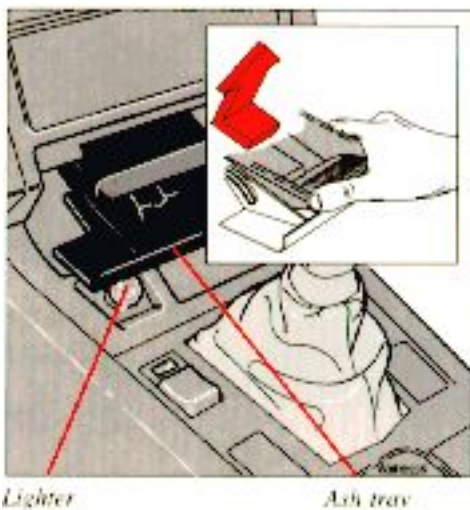

Lighter

Ash tray

Cigarette lighter

To operate, depress the knob fully. When the knob automatically releases, the cigarette lighter is ready for use.

The starting (ignition) switch must be either in position I or II for the cigarette lighter to function.

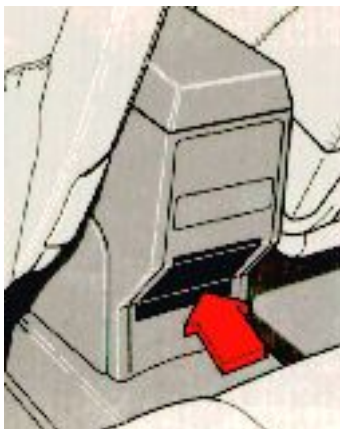

Rear seat ash tray

Ash trays

To open the front ash tray, press lightly on the panel.

To open the rear ash tray, pull it straight out.

To empty the front ash tray, grasp the removable insert on the sides, push it in and then pull it straight up. Only this insert can be removed for cleaning.

To empty the rear ash tray, pull it out, lift up the rear edge and remove.

pg. 1:14 Steering wheel adjustment

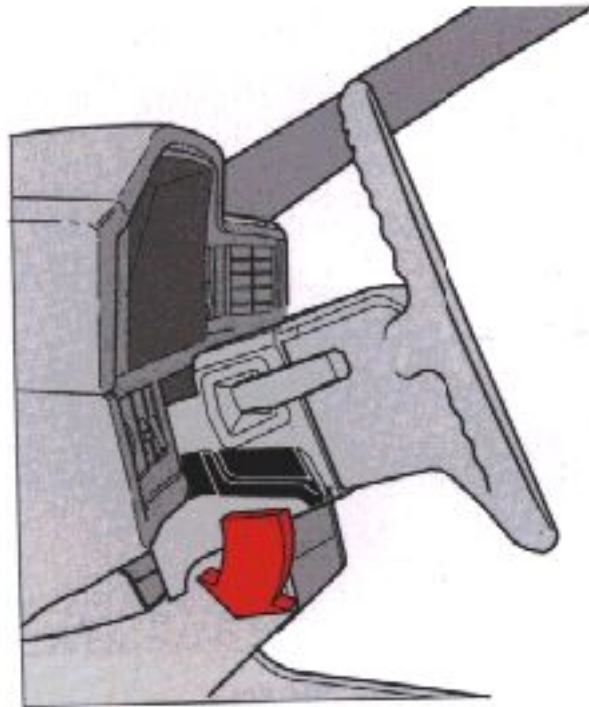

Depress....

Steering wheel adjustment

Both the height and the reach of the steering wheel can be adjusted to a comfortable position for the driver. Press down the lever on the left of the steering column and hold it in place. Adjust the steering wheel to a suitable position and press the lever back into place to lock the steering wheel in the new position. Check that the steering wheel is locked in the new position.

WARNING! Never adjust the steering wheel while driving.

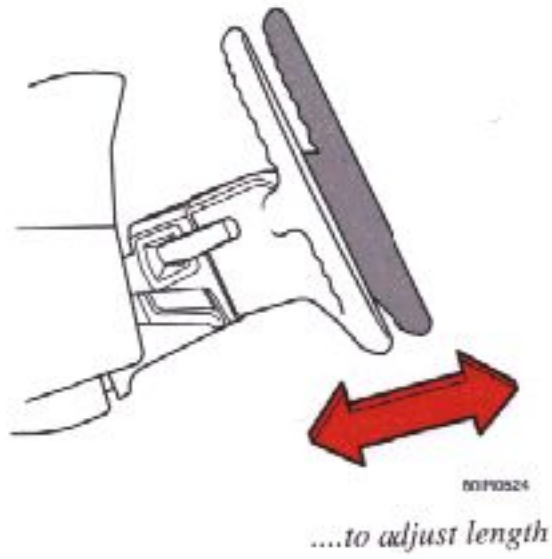
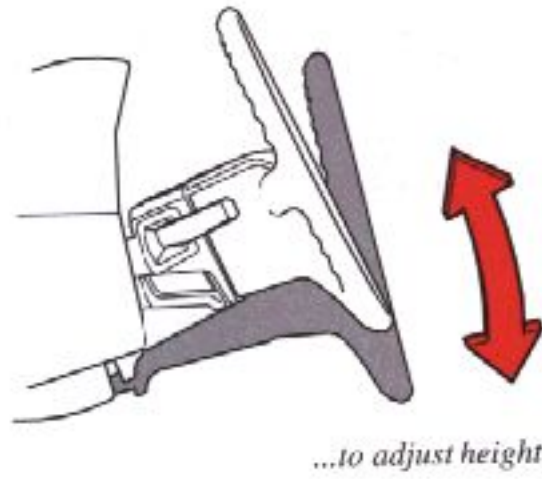

[Contents](#) | [Top of Page](#)

Body and Interior

pg. 2:1 Body and interior

Body and interior

The seats, seat belts, sun roof, mirrors, etc. are described on the following pages.

- [2:2](#) Keys
- [2:3](#) Doors and Locks
- [2:4](#) Remote keyless entry system
- [2:5](#) Child safety locks, Trunk lid
- [2:6](#) Front seats
- [2:7](#) Rear/side view mirrors
- [2:8](#) Interior light, Vanity mirror
- [2:9](#) Sun roof
- [2:10](#) Hood, Alarm
- [2:11](#) Trunk light, Spare tire, Jack
- [2:12](#) Storage compartments
- [2:13](#) Folding rear seat
- [2:14](#) Folding front seat, Long load storage
- [2:15](#) Cargo anchorage eyelets

pg. 2:2 Keys

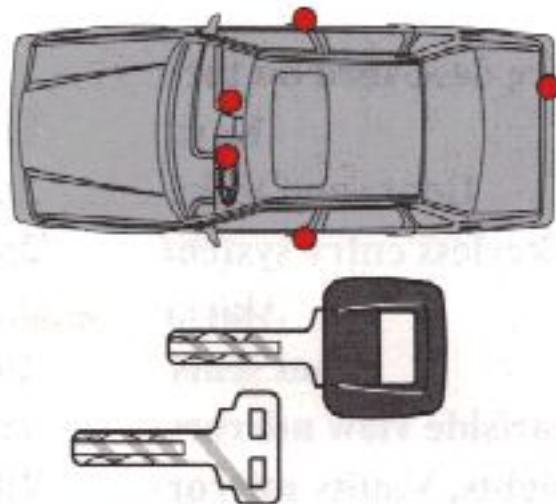

Master key and wallet key

This key operates all locks

The key number codes are stamped on a separate tag supplied with the keys. This tag should be separated from the key ring and kept in a safe place (the back of the tag is coated with adhesive tape). As an added anti-theft measure, new keys have been developed which may take slightly longer to copy or replace if the original keys are misplaced.

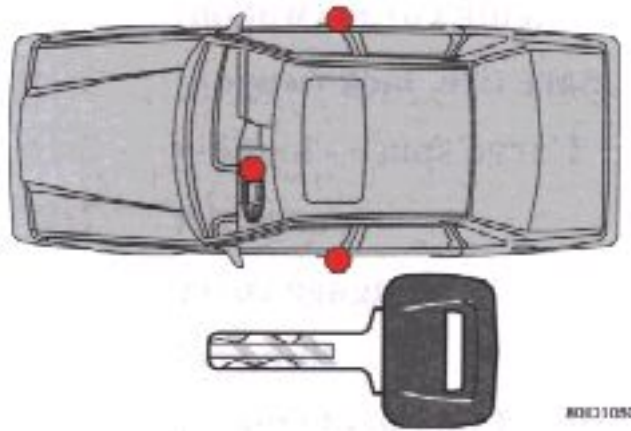

Service key

Front doors, starting (ignition) switch/steering wheel lock

In the event the original keys are lost, duplicates may be ordered from your Volvo dealer. The central locking system is described in detail in the section "Doors and locks".



Number tag



Doors and locks

Your car is equipped with a central locking system. This means that all of the doors (including the trunk lid and fuel tank flap) can be locked or unlocked from either of the front doors or the trunk lid. If the driver/passenger door or trunk lid is locked or unlocked using the key, the other doors will also be locked or unlocked automatically. To lock or unlock the car from the inside, push or pull the lock buttons on either of the front doors. If either of the front doors is opened from the inside, all of the doors and trunk lid will be unlocked. Check the action of the buttons on the other doors to verify their correct function (lock/unlock). The driver's door can be locked only by using the key when outside the vehicle.

On vehicles equipped with the optional remote control locking system, refer to the following page.

WARNING! The lock button should not be in the down position while driving. In case of an accident, this may hinder rapid access to the occupants of the vehicle. (Also see information on "Child safety locks").

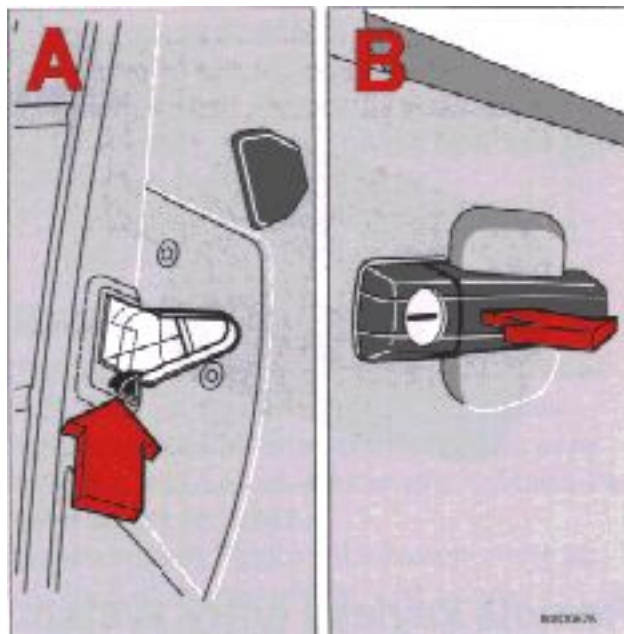

To avoid battery drain

The courtesy lights and the warning lights in the rear of the doors come on when a door is opened. To avoid battery drain when the doors are opened for prolonged periods, these lights can be switched off by pressing the lock mechanism (A) located in the rear facing side of the driver's door. To return the lights to their normal function, pull the door handle out before closing the door (B).

pg. 2:4 Remote keyless entry system (option)



Remote keyless entry system

As an option, your car can be equipped with a remote control transmitter. This transmitter uses a radio frequency which will allow "keyless" entry into the passenger compartment or the trunk. You will be supplied with two coded key ring transmitters, which will enable you to lock/unlock all doors and the

trunk from a distance of 10-15 feet (3-5 meters).

To operate the system press either the LOCK or UNLOCK button. On vehicles equipped with an alarm, the alarm will also be activated/deactivated by this system.

This device complies with the FCC rules Part 15. Operations is subject to the following two conditions: (1) This device may not cause harmful interference and (2) this device must accept any interference that may be received, including interference that may cause undesired operation.

Volvo does not recommend using the transmitter to lock the doors from inside the car. On cars equipped with an alarm, the alarm would be activated and would sound when one of the doors is opened. However, as a safety feature, the doors and trunk can be unlocked if the starting (ignition) key is in position I or II.

WARNING! The doors must not be locked using the remote transmitter while the vehicle is being driven or is occupied. In case of an accident, this may hinder rapid access to the occupants of the vehicle.

As an anti-theft precaution, the transmitter should NOT be left with the keys when the car is brought to a workshop for service/repairs. If one of the transmitters is misplaced, contact the nearest authorized Volvo dealer for assistance.



Battery replacement

If you have to stand closer to the car than normal to operate the system, this is a good indication that the battery should be replaced.

To replace the battery:

Remove the battery cover on the back of the transmitter with a coin.

Replace the battery (type CR2025). The new battery should be put in with the text side up so that the cover can be closed.

Install the battery cover again, making sure it is on tightly to help prevent water from entering the transmitter.

pg. 2:5 Child safety locks, Trunk lid

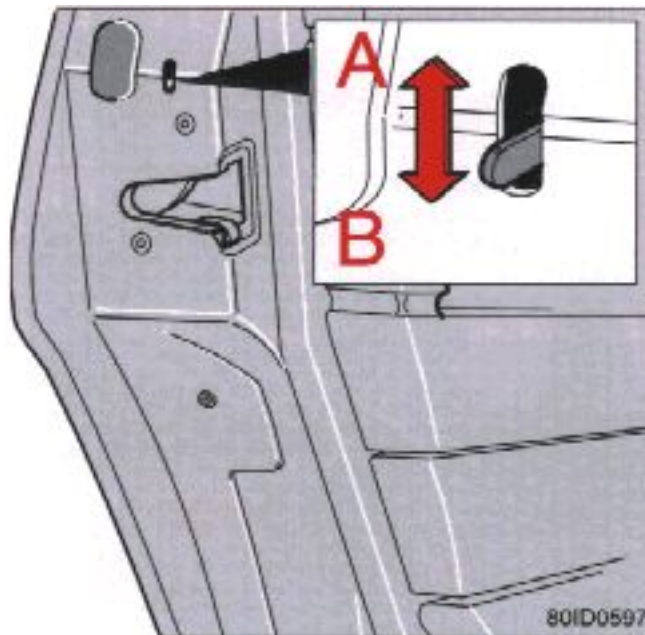

Child safety locks

The controls are located on the rear door jambs.

A The door cannot be opened from the inside. Normal operation from the outside.

B The door lock functions normally.

WARNING! Remember, in the event of an accident, the rear seat passengers cannot open the doors from the inside with the buttons in position A.

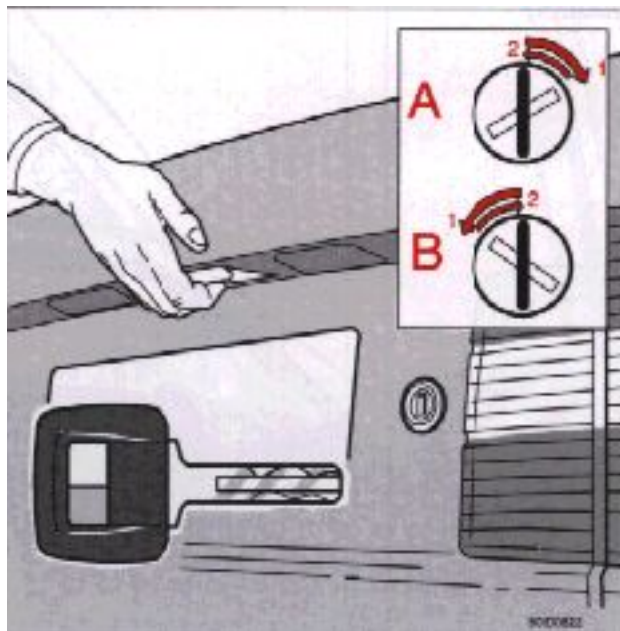

Trunk lid

The trunk lock is incorporated in the central locking system. This means that you can either lock or unlock the trunk by means of either of the front doors.

You can also operate the trunk lock directly with the master (or wallet) key even if the vehicle is centrally locked.

Locking or unlocking the trunk lid will also unlock the doors.

The trunk can also be disconnected from the central locking system by turning the key counterclockwise as shown below:

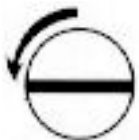

Withdraw the key in the horizontal position.

The trunk is now always locked. The optional folding rear seatback can also be locked from the trunk (see page 2:13). This feature can be used for example, if you lend your car to someone. If you give only the service key to the driver it will not be possible to gain access to the trunk.

To reconnect the lock to the central locking system:



Withdraw the key in the vertical position

1 Height adjustment (manual)

The front section of the driver's seat can be adjusted to seven different height settings and the rear section of either seat can be adjusted to nine different height settings.

Lever forward = adjustment of front section

Lever rearward = adjustment of rear section

The front edge of the passenger's seat can be adjusted to six different height settings. The rear edge can also be adjusted, however, suitable tools must be used to carry out this adjustment.

WARNING! Do not adjust the seat while driving. The seat should be adjusted so that the brake pedal can be depressed fully. In addition, position the seat as far rearward as comfort and control allow. The seat rails on the floor must not be obstructed in any way when the seat is moved.

2 Forward-rearward seat adjustment (manual)

Pull the control upward, then slide the seat forward or rearward to the desired position. Make sure that the seat is properly secured when you release the control.

Quick release

The passenger's seat backrest has a quick forward release mechanism which can be used when long loads are carried. See page 2:14.

3 Backrest angle (manual)

Rotate the control mechanism counterclockwise to tilt the backrest rearward and clockwise to tilt the backrest forward.

4 Lumbar support

Firm: turn clockwise. Soft: turn counter-clockwise.



Electrically operated seats with memory function (certain models)

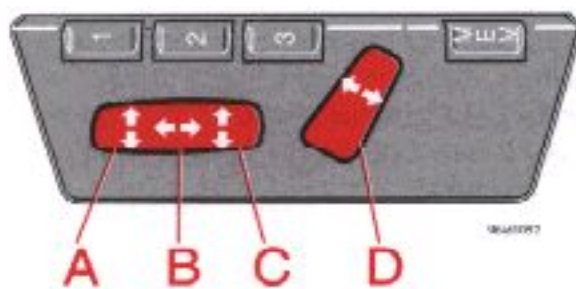

Power seat control panel

- A Seat front (raise/lower)
- B Forward - rearward
- C Seat rear (raise/lower)
- D Backrest tilt

On certain models, the starting (ignition) key must be turned to at least position I before the seat can be operated.

WARNING! On certain models, the power seats are operable with the ignition OFF. Therefore, children should never be left unattended in the car.

Movement of the seat can be STOPPED at any time by pressing any button on the power seat control panel.

Refer to the following page for information on programming the memory function.

pg. 2:7 Electrically operated driver's seat, Rear/side-view mirrors



Programming the memory

Three seat positions can be programmed. To program a seat position:

1. Adjust the seat to the desired position.
2. Depress the MEM button.
3. Press button 1 to program the current position of the seat.

Buttons 2 and 3 can be programmed in the same way. To move the seat to a programmed position, depress button 1, 2 or 3 until the seat stops.

If the button is released before the seat has reached the programmed position, it will stop as a safety precaution.

NOTE: The seat has an overload protector which engages if an object blocks the movement of the seat. If this happens, remove the object and wait 20 seconds before operating the seat again.

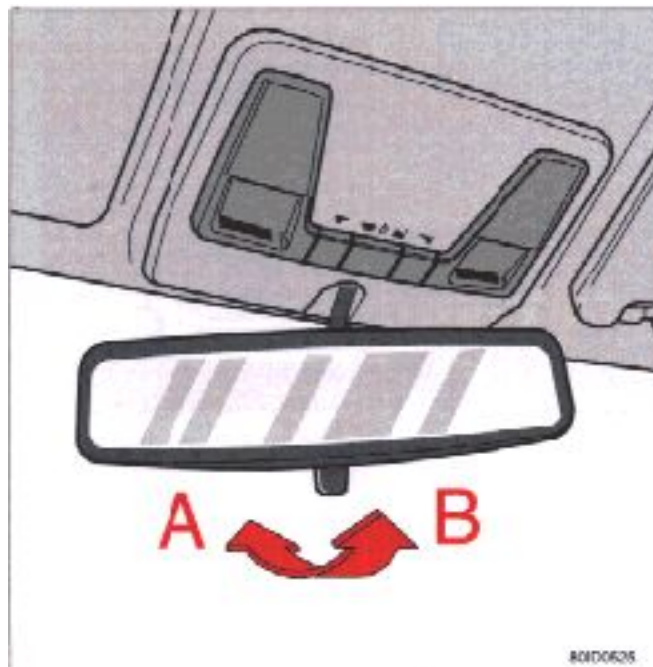

Rear-view mirror

A Normal position

B Night position, reduces glare from following headlights

CAUTION: Never use ice scrapers made of metal as they can easily scratch the mirror surface.

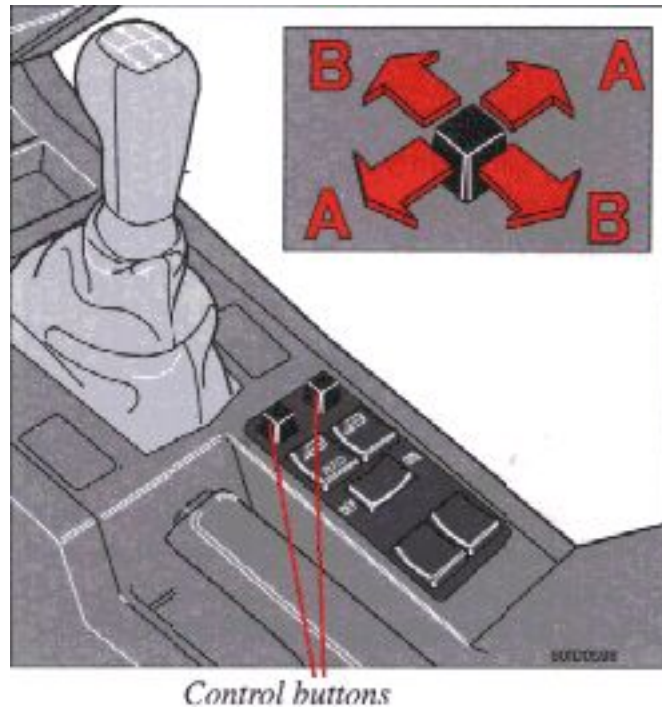

Electrically operated side-view mirrors

The control switches are located in the central console, beside the parking brake.

A Lateral adjustment

B Vertical adjustment

WARNING! The mirrors should always be adjusted prior to driving.
Objects seen in the wide-angle right side-view mirror are closer than they appear to be.



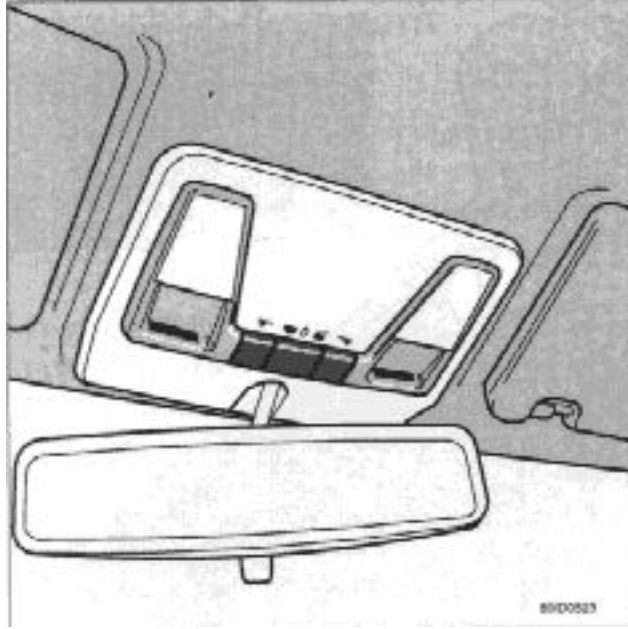

Front courtesy lights

The front courtesy lighting consists of two reading lights for the front seat occupants.

- Front and rear reading lights always on
- Front and rear reading lights always off
- Front and rear reading lights come on when a door is opened
- Left or right reading light illuminates if the center switch is in the position

The courtesy lights remain illuminated for 30 seconds after the doors have been closed but will be switched off if the ignition is turned on or the doors are locked.

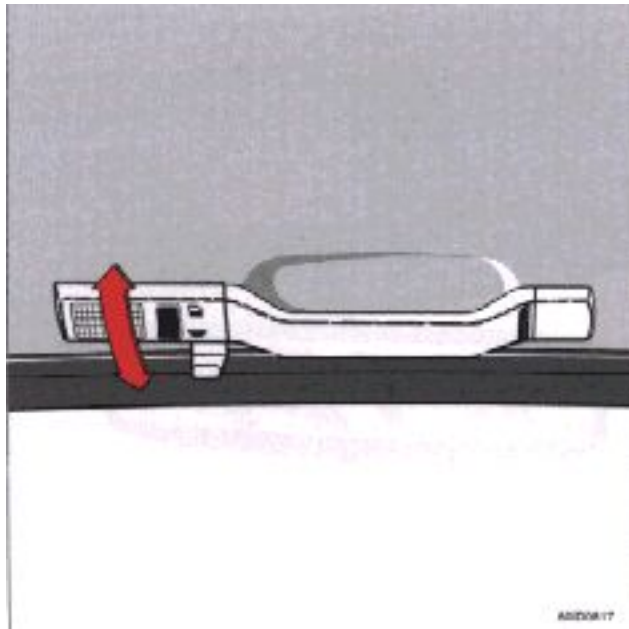

Reading lights, rear seat

There are two reading lights for the rear seat passengers. These are turned on/off by using the adjacent switches.

- ☐ Light is on if the front switch is in position ☐
- ☐ Light turns on if any door is opened

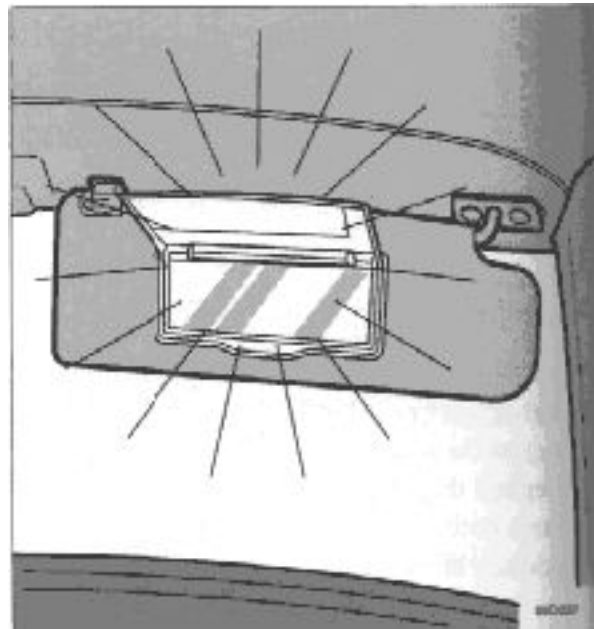

Vanity mirrors (on both sides)

The light illuminates when the cover is opened.

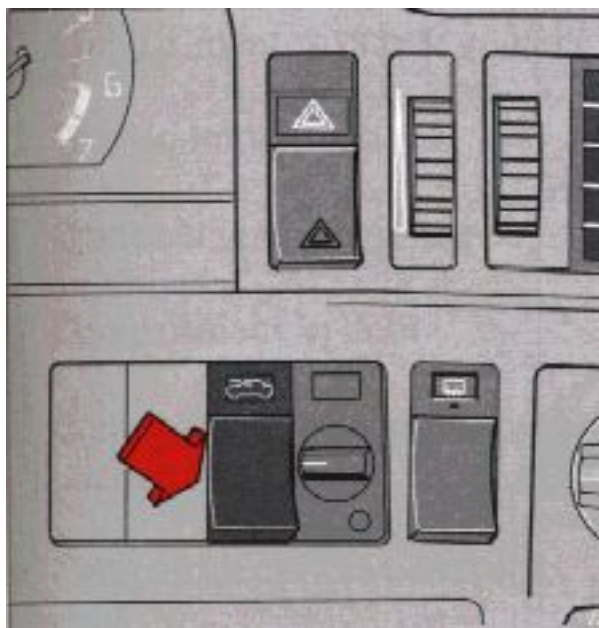

Electrically-operated sun roof

The switch for operating the sun roof is located on the instrument panel. The starting (ignition) key must first be turned to the drive position.

- To slide open the sun roof: press the lower section of the switch.
- To close the sun-roof : press the upper section of the switch.
- To open the rear edge of the sun roof (ventilation position) : press the upper section of the switch. Press the lower section of the switch to return the sun roof to the closed position.



Ventilation position

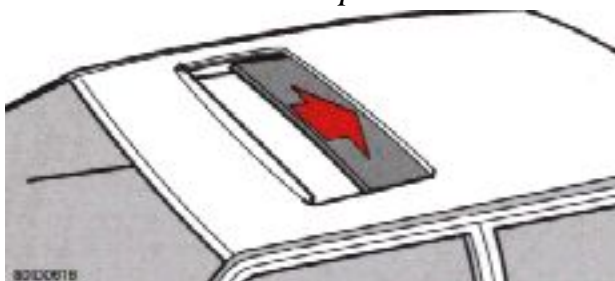

The sun roof also features a manually-operated sliding sun visor. The sun visor automatically slides back

slightly when the sun roof is opened to the ventilation position.

CAUTION: Do not close the sun visor when the sun roof is in the ventilation position as this could damage the mechanism.

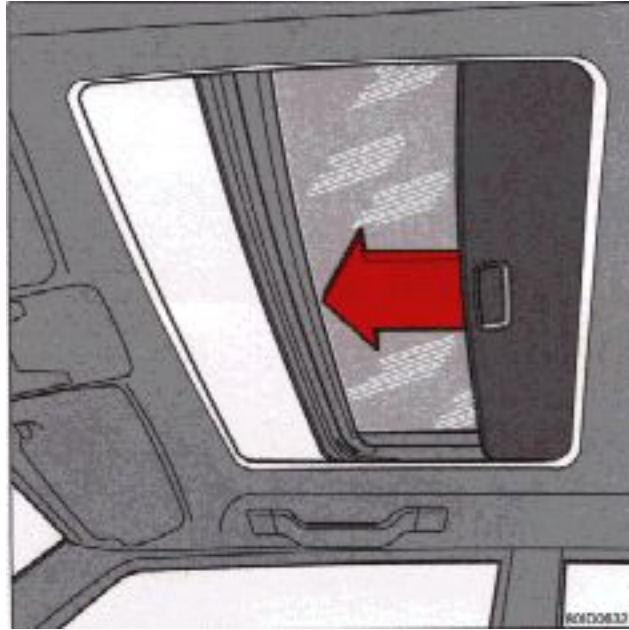

NOTE: The electrically-operated sun roof has an overload protecting circuit breaker which is activated when an object blocks the sun roof. Should this occur, remove the object and wait 20 seconds for the circuit breaker to reset. The sun roof should then function normally.

In case of a sun roof malfunction, see "Emergency sun roof operation", page 6:17.

pg. 2:10 Hood, Alarm (option)

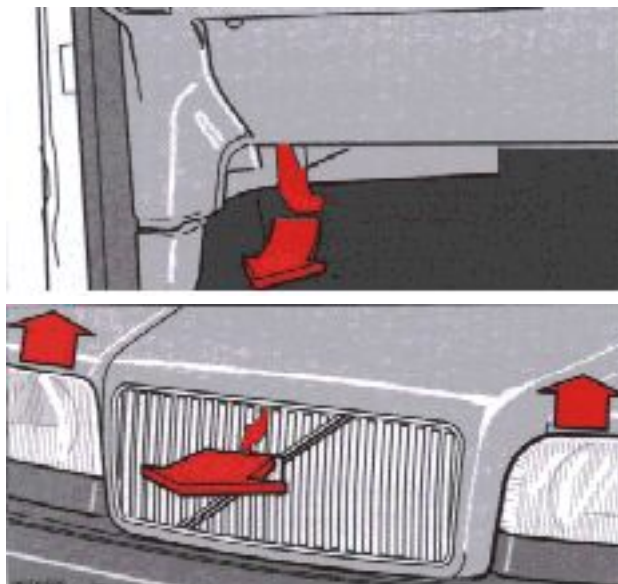

To open the hood

Pull the release handle located under the left side of the dash. This releases the safety catch handle in the front of the grille.

Lift the hood slightly to expose the safety catch.

Pull the safety catch handle and open the hood.

Do not lift the hood using the safety catch.

WARNING! Check that the hood locks properly when closed.

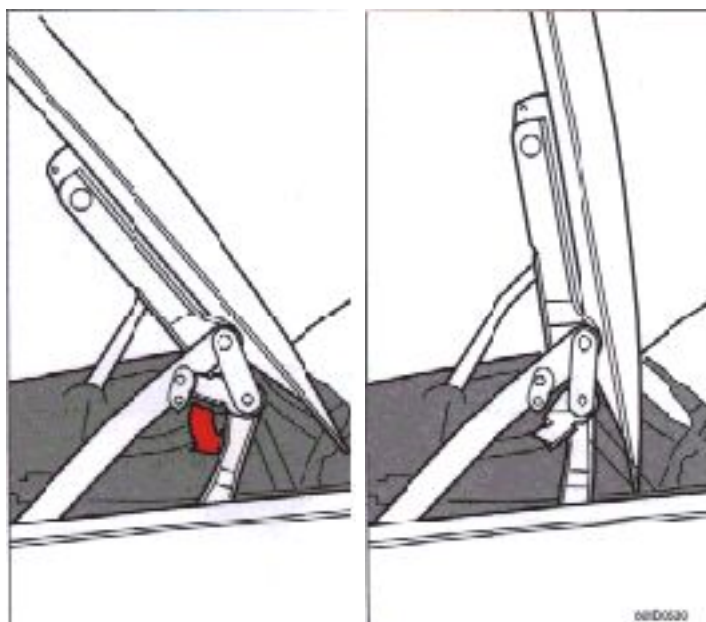

The hood normally opens to an angle of 57°. The hood can be opened to the vertical position by rotating the hinge catches (see illustrations). The catches will return to their normal positions when the hood is closed. Take care in low-roof garages!

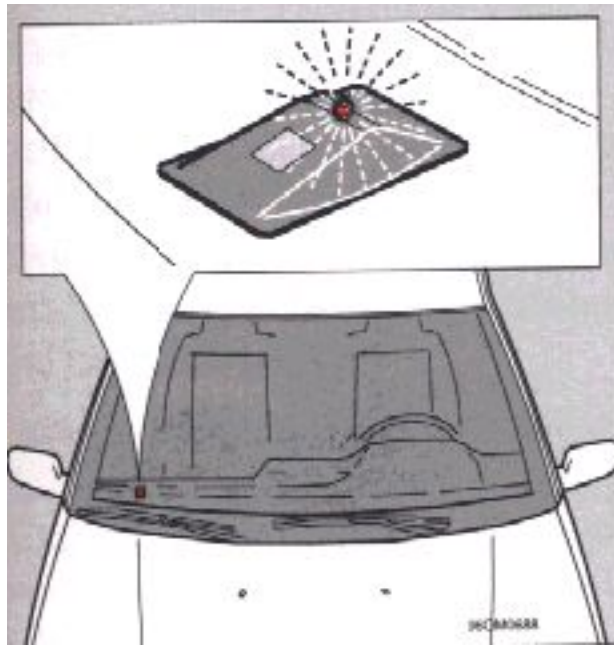

Alarm

Alarm

As an option you car may be equipped with an alarm.

The alarm system is connected to the doors, hood, trunk and the starting (ignition) switch.

The alarm can be deactivated by turning the key in either of the front door locks or the trunk. A red LED flashes on the top-center section of the dash to indicate that the alarm has been activated. If an attempt has been made to break into the car, the LED will glow continuously until the ignition is switched on.

NOTE: The alarm is activated when either of the front doors or the trunk is locked using a key (or optional remote control locking system), even if a door or the trunk is open.

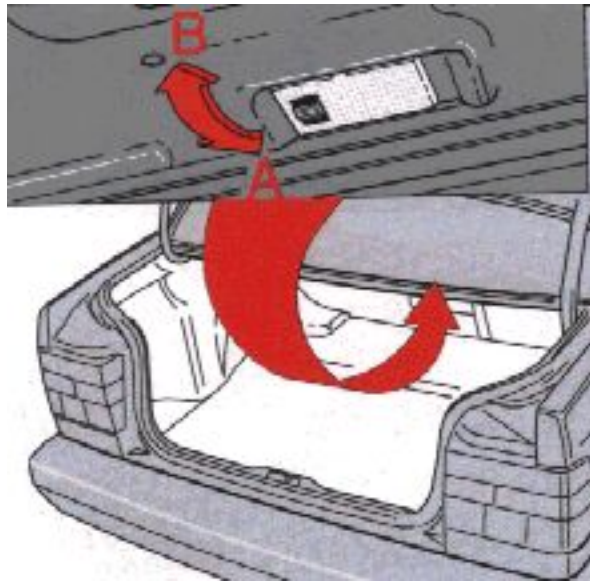

Trunk light

A Light always off

B Light is on when trunk lid is open

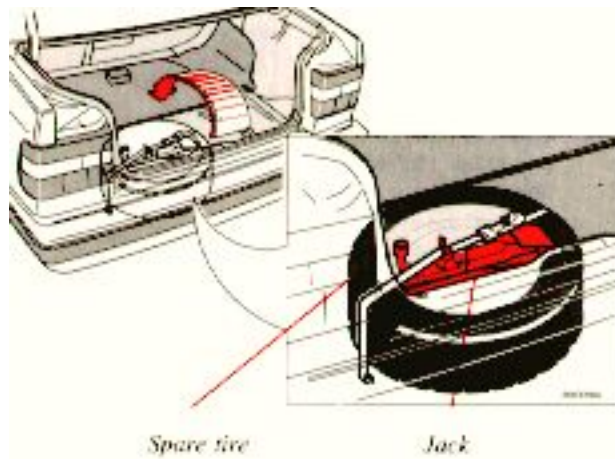

Spare tire

The spare tire is located under the carpet in a special well under the floor of the trunk. The jack is placed inside the wheel rim. Make sure that the jack is properly secured in this position after use. Refer to the decal on the inside of the trunk lid for storage instructions.

NOTE: See pages 6:2-6:3 for information on how the jack should be used.

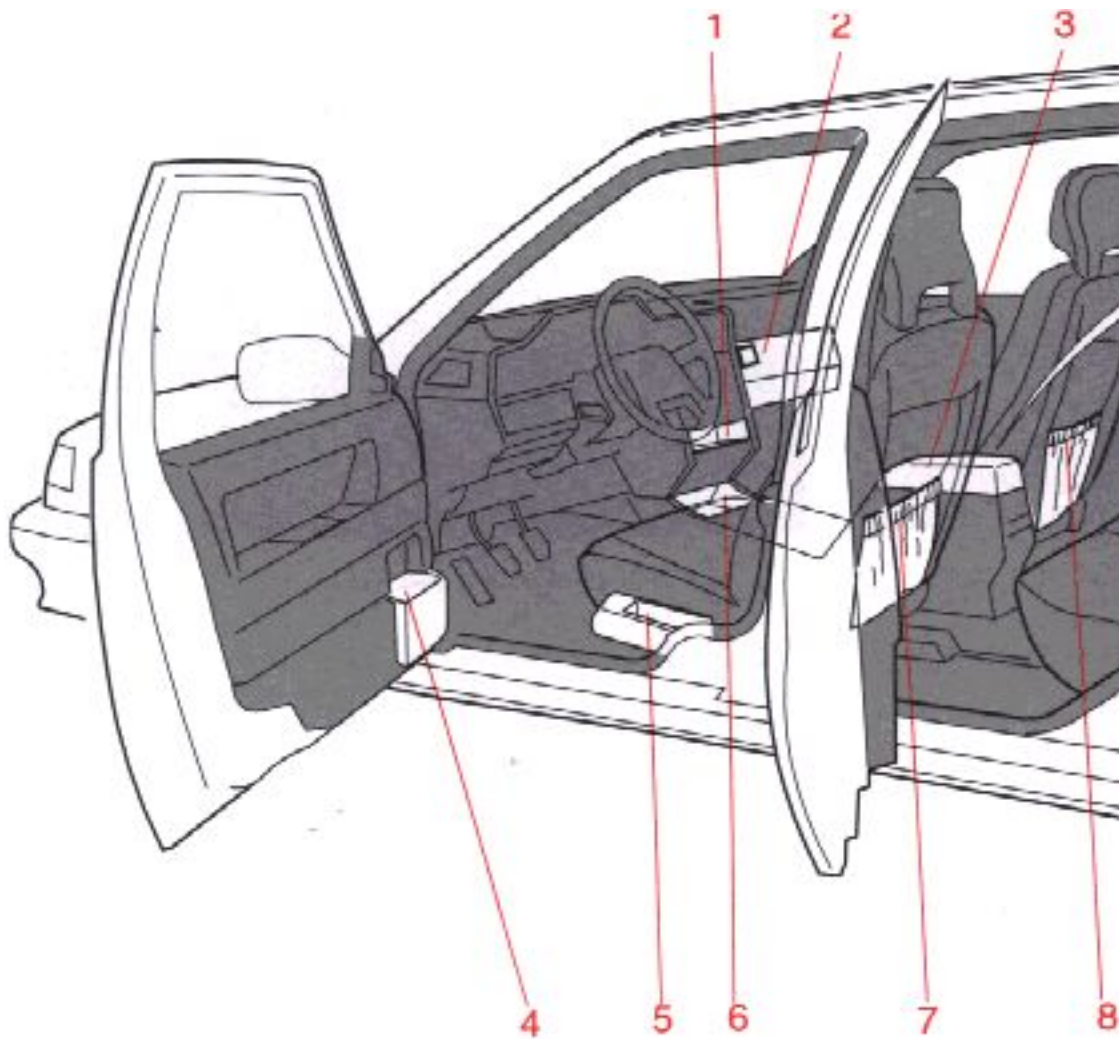

- 1 Compartment in center console
- 2 Glove compartment
- 3 Compartment in armrest
- 4 Compartment in door
- 5 Compartment beside front seat
- 6 Compartment between front seats
- 7 Pocket on rear of front seat
- 8 Pocket on rear of front seat

WARNING! Packages on the rear window shelf can obscure vision and may become dangerous projectiles in the event of a sudden stop or an accident.

pg. 2:13 Folding rear seat

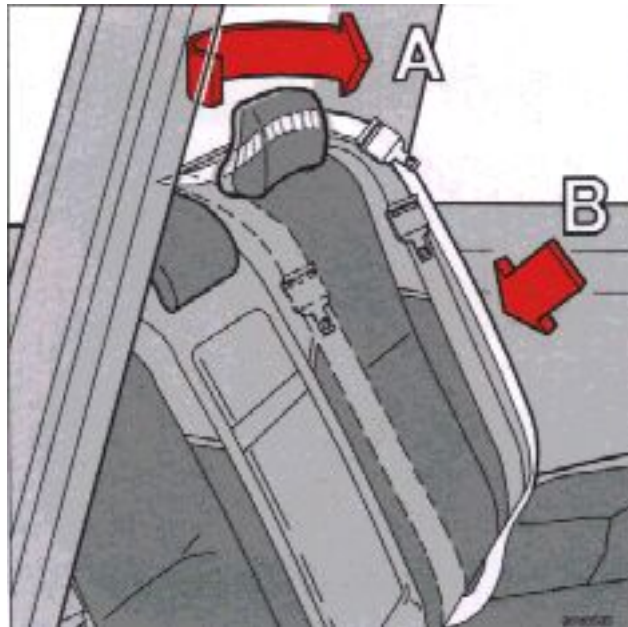

Folding rear seat

The rear seat is split into two sections so that each section can be folded independently.

- Lift the rear seat belts to the fixed section of the backrest. The center seat belt can also be folded across the fixed part of the backrest so that it does not get in the way if the right-hand backrest is folded down (see illustration above).
- Pull the catch forward and fold the backrest down.

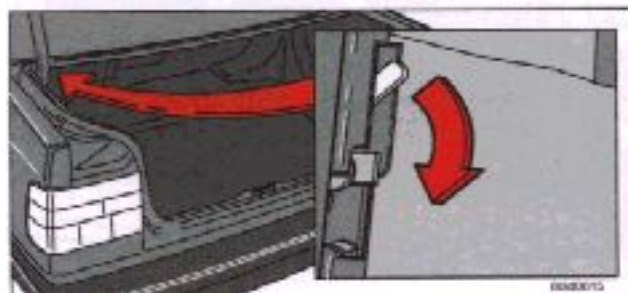
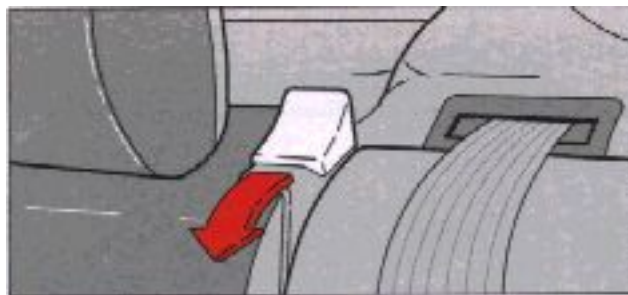

Locking levers

The two red levers on the rear side of the backrests can be used to bypass the folding mechanism and prevent the backrests from being folded down from inside the car.

Push the levers down to lock the backrests in the upright position.

This function can be used to limit access to the trunk.

- When folding the backrests up, make sure the seat belts return to their normal positions.

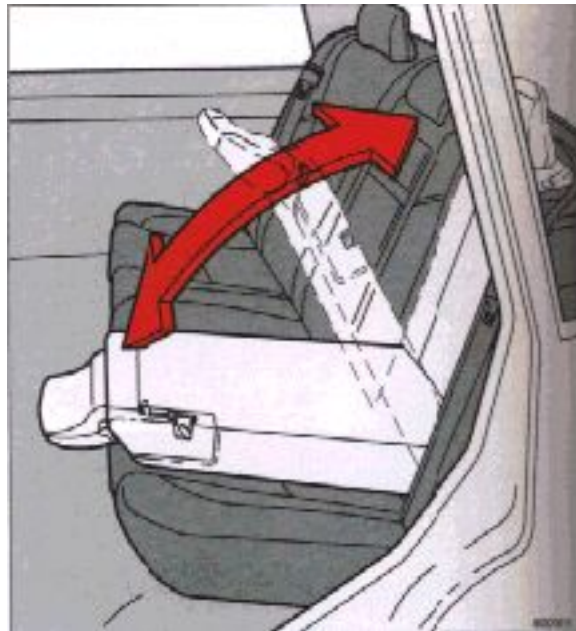

pg. 2:14 Folding front seat, Long load storage

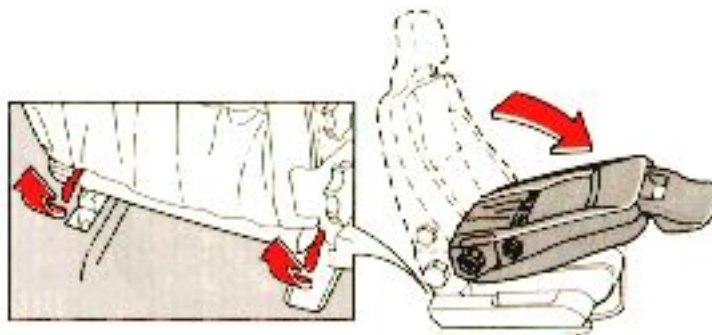

Folding front seat

The passenger seat backrest can be folded down to the horizontal position for carrying long loads. To fold down the backrest:

- Move the seat as far forward as possible
- Lift the catches on the lower rear side of the backrest
- Without releasing the catches, push the backrest forward

WARNING! Cover sharp edges on load to help prevent injury to occupants. Secure load to help prevent shifting during sudden stops.

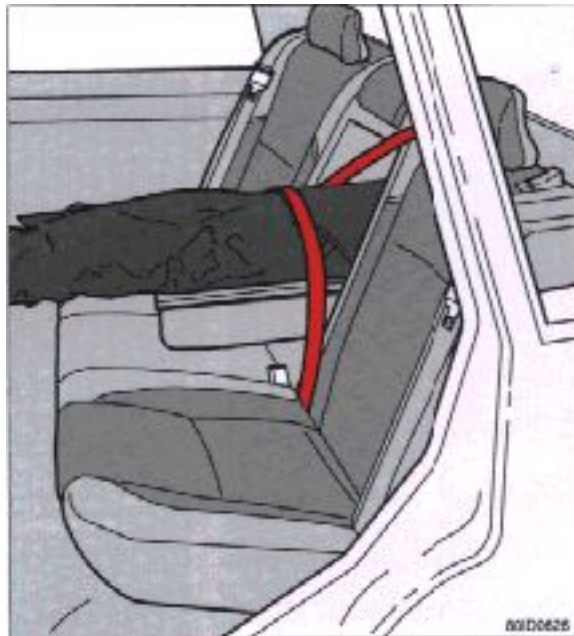

Long load storage

There is a flap located in the panel behind the rear seat which makes it possible to carry long loads such as skis, etc. To open, lower the child booster cushion, press the catch upward and pull the upper edge of the flap forward.

Protective covers (for skis) should be used to avoid soiling or tearing the upholstery. Please note that the flap in the rear seat is only intended for light loads such as skis, wood, etc.

Max length: 6 1/2 ft (2 meters)

Max weight: 55 lbs (25 kg)

WARNING! Always turn engine off and apply the parking brake when loading/unloading the vehicle. Place transmission selector in P (PARK) position to help prevent inadvertent movement of selector.

pg. 2:15 Cargo anchorage eyelets

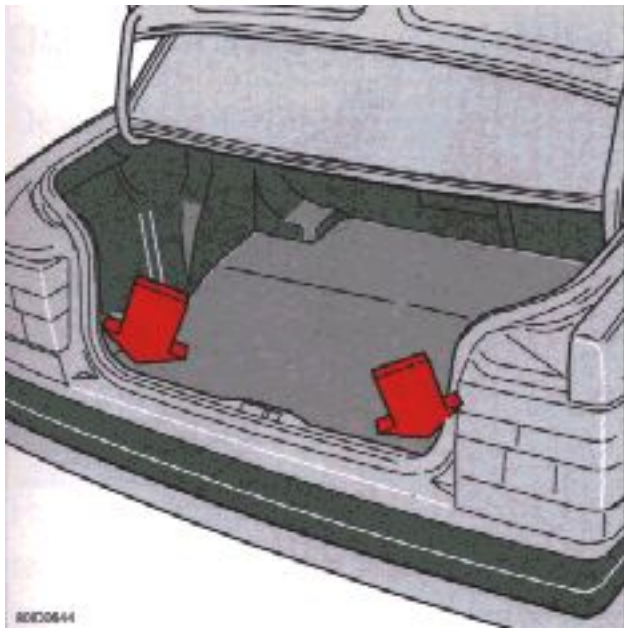

Eyelets in trunk

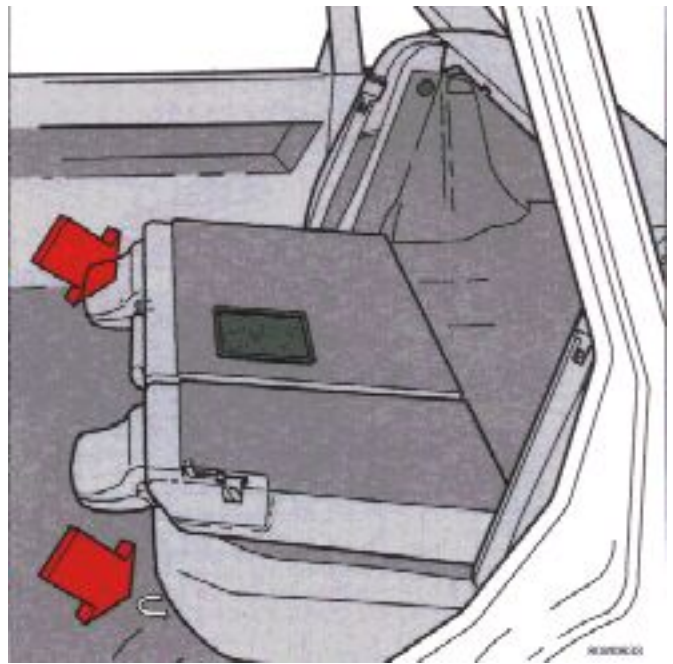

Eyelets inside the car

Securing cargo

As a safety precaution, your car is equipped with four eyelets to which straps can be attached to secure luggage.

WARNING! The eyelets are not to be used as passenger restraints or as anchorages for child restraints. See page 3:7.



[Contents](#) | [Top of Page](#)

Occupant Safety, Reporting Safety Defects

pg. 3:1 Occupant safety

Despite our strongest recommendations and your best intentions, not wearing a seat belt is like believing "It'll never happen to me!". Volvo urges you and all adult occupants of your car to wear seat belts and ensure that children are properly restrained, using an infant, car or booster seat determined by age, weight and height.

Fact: In every state and province, some type of child-restraint legislation has been passed. Additionally, most states and provinces have already made it mandatory for occupants of a car to use seat belts.

So, urging you to "buckle up" is not just our recommendation - legislation in your state or province may mandate seat belt usage. The few seconds it takes to buckle up may one day allow you to say, "It's a good thing I was wearing my seat belt".

Occupant safety

[3:2](#) Seat belts

[3:4](#) Volvo SRS

[3:7](#) Child safety

[3:10](#) Occupant safety

[3:10](#) Reporting Safety Defects



pg. 3:2 Seat belts

Seat belts

Always fasten the seat belts before you drive or ride.

Two lights above the rear view mirror will be illuminated for 4-8 seconds after the starting (ignition) key is turned to the driving position. A chime will sound at the same time if the driver has not fastened his seat belt. The rear seats are provided with self-retracting inertia reel belts. The front seats are provided with single roller belts with tensioners.

To buckle:

Pull the belt out far enough to insert the latch plate into the receptacle (buckle for rear seats) until a

distinct snapping sound is heard. The seat belt retractor is normally "unlocked" and you can move freely, provided that the shoulder belt is not pulled out too far. The retractor will lock up as follows:

- if the belt is pulled out rapidly
- during braking and acceleration
- if the vehicle is leaning excessively
- when driving in turns

For the seat belt to provide maximum protection in the event of an accident, it must be worn correctly.

When wearing the seat belt remember:

- The belt should not be twisted or turned.
- The lap belt must be positioned low on the hips (not pressing against the abdomen).

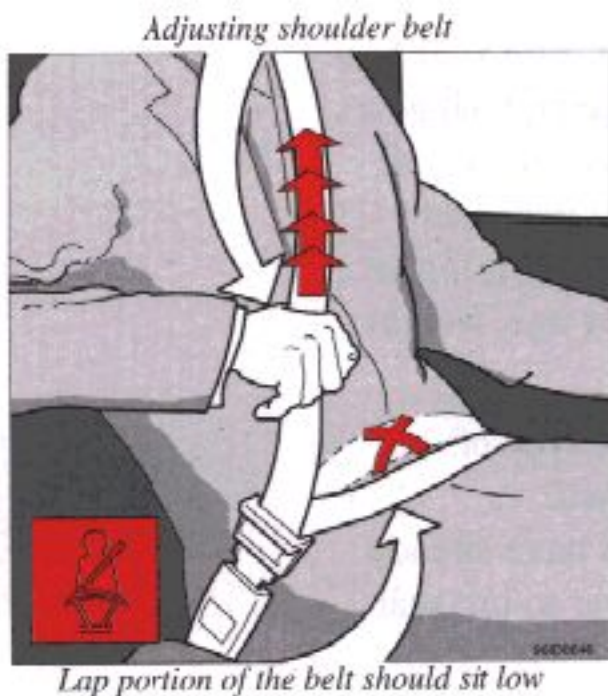

- The shoulder section of the front seat belts adjusts automatically to the driver's height. Make sure that the shoulder belt is rolled up into its retractor and that the shoulder and lap belts are taut. Before exiting the car, check that the seat belt retracts fully after being unbuckled. If necessary, guide the belt back into the retractor slot.

NOTE: Legislation in your state or province may mandate seat belt usage.

WARNING! Any device used to induce slack into the shoulder belt portion of the three-point belt system will have a detrimental effect on the amount of protection available to you in the event of a collision.

The seat back should not be tilted too far back. The shoulder belt must be taut in order to function properly.



During pregnancy

Pregnant women should always wear seat belts. Remember that the belt should always be positioned in such a way as to avoid any possible pressure on the abdomen. The lap portion of the belt should be located low, as shown in the above illustration.

WARNING! Never use a seat belt for more than one occupant. Never wear the shoulder portion of the belt under the arm or otherwise out of position. Such use could cause injury in the event of an accident. As the seat belts lose much of their strength when exposed to violent stretching, they should be replaced after any collision, even if they appear to be undamaged. Never repair the belt on your own; have this work done by an authorized Volvo dealer only.

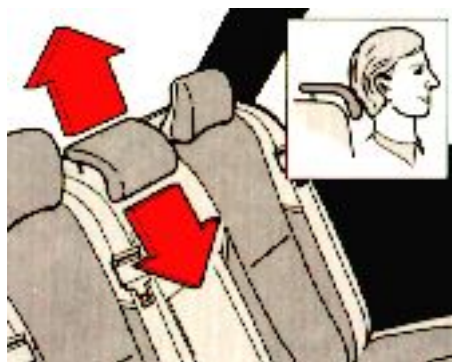

Center head restraint

The center head restraint can be adjusted according to the passenger's height. The restraint should be carefully adjusted to support the occupant's head.

To raise: Pull straight up

To lower: Pull forward and push down

pg. 3:4 Volvo SRS

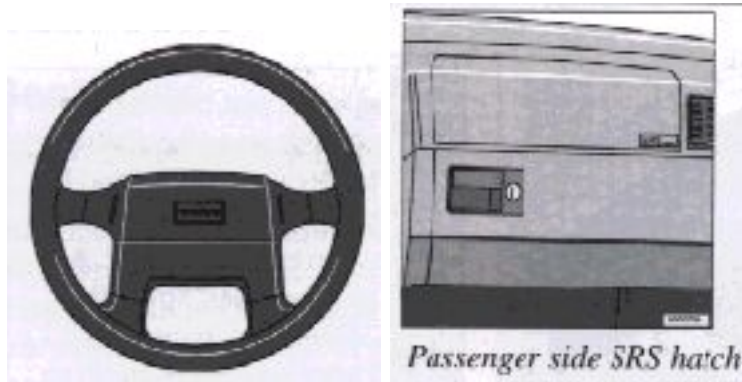

As an enhancement to the three-point seat belt system, your Volvo is equipped with a Supplemental Restraint System (SRS). The Volvo SRS consists of an airbag (2) and knee bolster (5) on both the driver's and passenger's sides and seat belt tensioners in both front door pillars (4). The system is designed to supplement the protection provided by the three-point seat belt system.

The interior of an SRS-equipped Volvo looks very much the same as any other. The only indication of the system's presence are the "SRS" embossed on the steering wheel pad and above the glove compartment, the knee bolsters beneath the steering column and the glove compartment and a decal on the far right side of the dash.

The airbags are folded and located in the center of the steering wheel and above the glove compartment. They are released only during certain frontal or front-angular collisions, depending on the crash severity, angle, speed and object impacted. Both air bags and seat belt tensioners will deploy, even if the passenger seat is not occupied.

WARNING! As its name implies, SRS is designed to be a SUPPLEMENT to - not a replacement for - the three-point seat belt system. The airbag is designed not to be released in the event of a side or rear-end collision or during a rollover situation. For maximum protection, wear seat belts at all times. Be aware that no system can prevent all possible injuries that may occur in an accident.

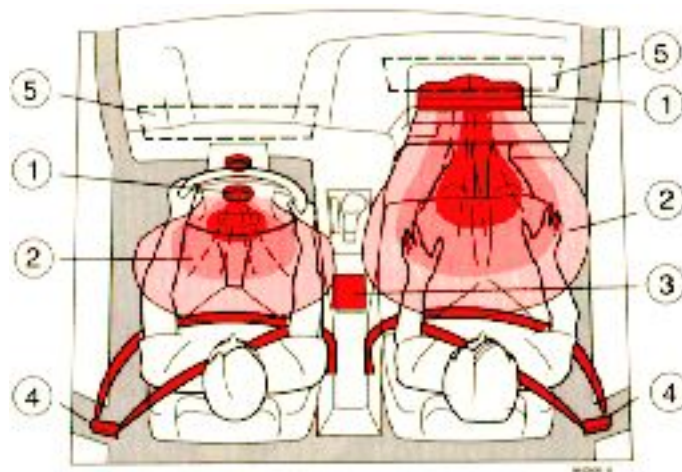

The airbag system includes gas generators (1) surrounded by the airbags (2) and front seat belt tensioners for both of the front seats (4). To deploy the system, the sensor (3) activates the gas generators causing the airbags to be inflated with nitrogen gas. As the movement of the seats' occupants compresses the airbags, some of the gas is expelled at a controlled rate to provide better cushioning. Both seat belt tensioners also deploy, minimizing any seat belt slack.

The entire process, including inflation and deflation of the airbags, takes approximately two-tenths of a second.

WARNING! When installing any optional equipment make sure that the SRS system is not damaged. Do not attempt to service any component of the SRS yourself. Attempting to do so may result in serious personal injury. If a problem arises, take your car to the nearest authorized Volvo dealer for inspection as soon as possible.

pg. 3:5 Volvo SRS (cont.)



A self-diagnostic system incorporated in the sensor monitors the SRS. If a fault is detected, the "SRS" warning light will illuminate. The light is included in the warning/indicator light cluster in the

instrument panel. Normally, the SRS warning lamp should light up when the ignition is switched on and should go out after 10 seconds or when the engine is started. Check that this light is functioning properly every time the car is started.

The following items are monitored by the diagnostic system:

- Sensor unit
- Cable harness
- Gas generator ignitors

WARNING! Never drive an SRS equipped car with your thumbs on the steering wheel pad/airbag housing.

WARNING! If the SRS warning light stays on after the engine has started or if it comes on while you are driving, drive the car to the nearest authorized Volvo dealer for inspection as soon as possible.



The above is a sample of the label found on all seat belts equipped with tensioners, located on the front seat belts near the lower anchorage point.



The above is a sample of the decal which can be found on the driver's door pillar.

There is no maintenance to perform on the SRS yourself. The only periodic maintenance recommended on the SRS is that the air bag modules and front seat belts (including tensioners) should be replaced approximately every ten years and that the other components in the system (wiring, connectors, etc.) should also be inspected at this time. The SRS decal on your car shows the month and year servicing is due. This service must be performed by an authorized Volvo dealer.

Should you have any questions about the SRS system, please contact your authorized Volvo dealer or

the Consumer Affairs Department.

pg. 3:6 Volvo SRS (cont.)



*SRS text at far right of instrument panel
and on inside of driver side sun visor*

WARNING! Do not use child safety seats or child boosters cushions/backrests in the front passenger's seat. We also recommend that children who have outgrown these devices sit in the rear seat with the seat belt properly fastened.

In order for the SRS system to provide the protection intended, seat belts should be worn at all times.

General SRS information

In a collision where deployment occurs, the air bags and seat belt tensioners activate. Some noise occurs and a small amount of powder is released. This powder is not harmful and does not indicate fire. Several air bag components get hot after inflation. Do not attempt to touch them.

NOTE: Deployment of SRS components occurs only one time during an accident.

If you are involved in an accident which has resulted in air bag deployment, we recommend the following:

- Have the car towed to an authorized Volvo dealer or collision repair shop. Even if the car is driveable after an accident, we do NOT recommend driving the car with deployed air bags.

WARNING! (Passenger side air bag)

- Occupants in the front passenger's seat must never sit on the edge of the seat, sit leaning toward the instrument panel or otherwise sit out of position. The occupant's back must be upright as comfort allows and be against the seat back with the seat properly fastened.
- Feet must be on the floor, e.g. not on the dash, seat or out of the window.
- Children must never be allowed to stand in front of the passenger seat.
- No objects or accessory equipment, e.g. dash covers, may be placed on, attached to or installed near the SRS hatch (the area above the glove compartment) or the area affected by air bag deployment.
- There should be no loose articles, e.g. coffee cups, on the floor, seat or dash area.
- Never try to open the SRS cover on the steering wheel or the passenger side SRS hatch. This should only be done by an authorized Volvo service technician.

- Have the SRS replacement performed by an authorized Volvo dealer OR ask the body shop performing the collision repairs to have the SRS replacement done at a Volvo dealer.
- Have all deployed/damaged SRS components (air bags and front seat belt assemblies) replaced with new, genuine Volvo-brand components.



[Contents](#) | [Top of Page](#)

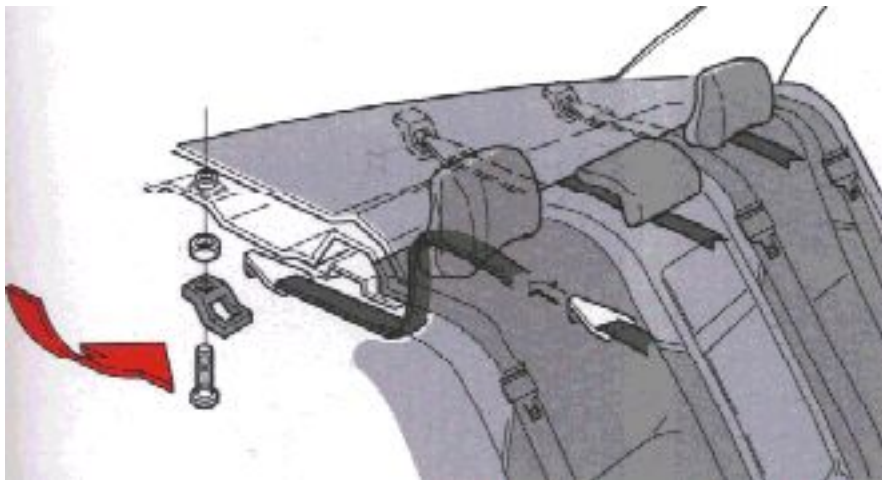

Child Restraint Anchorages

Volvo cars can be fitted with Child Restraint Top Tether Anchorages in the rear seat. There are three pre-drilled anchorage points under the rear window shelf. These anchorages are not visible from the passenger compartment. In cars designated for Canada, one top tether anchorage set will be in the glove box.

The top tether anchorage set includes the top tether anchorage plate, a 5/16" UNC bolt and a plastic trim cover. If another set is needed, consult your Volvo dealer.

Installing the top tether

The pre-drilled holes for the child restraint anchorages are underneath the rear window shelf and can be accessed from the trunk or by lowering the rear seat backrests. Refer to the child seat manufacturer's instructions for securing the seat.

An additional bolt may be required. This may be obtained from your authorized Volvo dealer.

WARNING! Child Restraint Anchorages are designed to withstand only those loads imposed by correctly fitted Child Restraints. Under no circumstances are they to be used for adult seat belts or harnesses.

The anchorages are not able to withstand excessive forces on them in the event of collision if full harness seat belts or adult seat belts are installed to them. An adult who uses a belt anchored in a Child Restraint Anchorage runs a great risk of suffering severe injuries should a collision occur.



Integrated booster cushion

Integrated booster cushion

Volvo's own integrated booster cushion has been specially designed to help safeguard a child seated in the center position of the rear seat.

In combination with the standard three-point seat belt, it is approved for children weighing between 50 and 80 lbs (23 and 36 kg) and between 46 and 54 inches (108 and 135 cm) in height.

WARNING! In the event of a collision while the integrated booster cushion was occupied, the entire booster cushion and center seat belt must be replaced. The booster cushion should also be replaced if it is badly worn or damaged in any way. This work should be performed by an authorized Volvo dealer only. The seat should be cleaned while in place in the vehicle if possible. If not, please consult your Volvo dealer.

With the child seat on the booster cushion the hip section of the three-point seat belt must fit snugly across the child's hips, not across the stomach. The head restraint should also be properly adjusted to the child's height.

Press control A to fold the booster cushion up when it is not in use.

pg. 3:9 Child safety (cont.)

Child safety

Volvo recommends the proper use of restraint systems for all occupants including children. Remember that, regardless of age and size, a child should always be properly restrained in a car.

Restraint systems for children are designed to be secured in the vehicle by lap belts or the lap portion of a lap-shoulder belt. Such child restraint systems can help protect children in cars in the event of an accident only if they are used properly. However, children could be endangered in a crash if the child restraints are not properly secured in the vehicle. Failure to follow the installation instructions for your

child restraint can result in your child striking the vehicle's interior in a sudden stop.

Holding a child in your arms is NOT a suitable substitute for a child restraint system. In an accident, a child held in a person's arms can be crushed between the vehicle's interior and an unrestrained person. The child could also be injured by striking the interior, or by being ejected from the vehicle during a sudden maneuver or impact. The same can also happen if the infant or child rides unrestrained on the seat.

Other occupants should also be properly restrained to help reduce the chance of injuries or increasing the injury of a child. All states and provinces have legislation governing how and where children should be carried in car. Find out the regulations existing in your state or province. Recent accident statistics have shown that children are safer in rear seating positions than front seating positions when properly restrained. A child restraint system can help protect a child in a vehicle. Here's what to look for when selecting a child restraint system:

- It should have a label certifying that it meets applicable Federal Motor Vehicle Safety Standards (FMVSS 213-80) - or in Canada, CMVSS 213.
- Make sure the child restraint system is approved for the child's height, weight and development - the label required by the standard or regulation, or instructions for infant restraints, typically provide this information.
- In using any child restraint system, we urge you to look carefully over the instructions that are provided with the restraint.
Be sure you understand them and can use the device properly and safely in this vehicle. A misused child restraint system can result in increased injuries for both the infant or child and other occupants in the vehicle.
- If your child restraint requires a top tether strap, consult your authorized Volvo dealer for top tether anchorage and installation information.

When a child has outgrown the child safety seat, you should use the rear seat with the standard seat belt fastened. The best way to help protect the child here is to place the child on a cushion so that the seat belt is properly located on the hips. See page 3:8. A specially designed and tested safety cushion for this purpose can be obtained from your Volvo dealer.

pg. 3:10 Occupant safety

Seat belt maintenance

Check periodically that the anchor bolts are secure and that the belts are in good condition. Use water and a mild detergent for cleaning. Check seat belt mechanism function as follows:

Attach the seat belt. Pull rapidly on the strap.

WARNING! Check other traffic before performing the following check.

Brake firmly from approximately 30 mph (50 km/h) or turn in a tight circle while pulling on the belt. In the above checks you should not be able to pull the belt out.

Volvo Concern for Safety

Safety is the cornerstone for Volvo. Our concern dates back to 1927 when the first Volvo rolled off the production line. Three-point seat belts, safety cages, and crumple zones were designed into Volvo cars long before it was fashionable or required by government regulation. We will not compromise our commitment to safety. We continue to seek out new safety features and to refine those already in our cars. You can help. We would appreciate hearing your suggestions about improving automobile safety. We also want to know if you ever have a safety concern with your car.

Thank you.

Occupant safety

How safely you drive doesn't depend on how old you are but rather on:

- how well you see
- your ability to concentrate
- how quickly you make decisions under stress to avoid an accident.

The tips listed below are suggestions to help you cope with the ever changing traffic environment.

- Never drink and drive.
- If you are taking any medication, consult your physician about its potential effects on your driving abilities.
- Take a driver-retraining course
- Have your eyes checked regularly.
- Keep your windshield and headlamps clean.
- Replace wiper blades when they start to leave streaks.
- Take into account the traffic, road, and weather conditions, particularly with regard to stopping distance.

Reporting Safety Defects in the U.S.

If you believe that your vehicle has a defect which could cause a crash or could cause injury or death, you should immediately inform the National Highway Traffic Safety Administration (NHTSA) in addition to notifying Volvo Cars of North America. If NHTSA receives similar complaints, it may open an investigation, and if it finds that a safety defect exists in a group of vehicles, it may order a recall and remedy campaign. However, NHTSA cannot become involved in individual problems between you, your dealer, or Volvo Cars of North America. To contact NHTSA, you may either call the Auto Safety Hotline toll-free at 1-800-424-9393 (or 366-0123 in Washington, D.C. area) or write to: NHSTA, U.S.

Department of Transportation, Washington D.C. 20590. You can also obtain other information about motor vehicle safety from the Hotline.



[Contents](#) | [Top of Page](#)

Starting and Driving

pg. 4:1 Starting and driving

Starting and driving

This section on starting and driving contains items such as starting the engine, operating gear selector, towing, trailers.

- [4:2 Break-in period](#)
- [4:2 Fuel requirements, Octane rating](#)
- [4:4 Driving economy](#)
- [4:5 Starting the engine](#)
- [4:6 Manual transmission](#)
- [4:7 Automatic Transmission](#)
- [4:9 Points to remember](#)
- [4:12 Emergency towing](#)
- [4:13 Vehicle Towing Information](#)
- [4:14 Starting with an auxiliary battery \(jump starting\)](#)
- [4:15 Three-way catalytic converter](#)
- [4:16 Brake system, ABS](#)
- [4:17 Trailer towing](#)
- [4:18 Winter driving](#)
- [4:19 Long distance trips, City driving](#)
- [4:20 Vehicle storage](#)

pg. 4:2 Break-in period, Fuel requirements

A new car should be broken-in

Refrain from utilizing your car's full driving potential during the first 1,200 miles (2,000 km) including the "kick-down" function (automatic transmission).

NOTE - ENGINE OIL:

Although some oil consumption occurs during normal engine operation, more oil is consumed when the engine is new as the internal parts generate higher friction while wearing-in to each other. From the time

the engine is new until the first service is performed, the oil consumption could be higher than normal. For this reason, it is especially important to check the oil every time you refuel your car during this period. See page 8:10.

In general, the rate of oil consumption depends on such factors as: engine temperature, length of trip, driving conditions, oil viscosity and quality, engine speed and acceleration/deceleration.

Checking your engine oil level each time the car is refuelled is one of the most important items you can perform to help keep your car in good running order.

Manual transmission

The following speeds should not be exceeded during the break-in period:

	Up to 600 miles (1000 km)	600 - 1,200 miles (1000 - 2000 km)
1st gear	20 mph (30 km/h)	25 mph (40 km/h)
2nd gear	30 mph (50 km/h)	40 mph (70 km/h)
3rd gear	45 mph (80 km/h)	65 mph (100 km/h)
4th gear	70 mph (110 km/h)	80 mph (130 km/h)
5th gear/ overdrive	80 mph (130 km/h)	95 mph (150 km/h)

Posted speed limits should not be exceeded.

Breaking-in parking brake (hand brake)

To obtain the best parking brake performance, the brake linings should be broken-in. Stop 5-7 times from 30 mph (50 km/h) with the transmission in neutral, applying the parking brake with the release button pressed in during the stop.

The force must not lock the rear wheels. If this happens, release the brake enough to let the wheels rotate. Drive a mile (1.6 km) between each stop to cool the brakes. Check for proper parking brake operation.

WARNING! The brake lights are not illuminated when applying the parking brake. To warn traffic from behind it is therefore advisable to depress the brake pedal to illuminate the brake lights.

Deposit control gasoline

Volvo recommends the use of gasoline containing deposit control additives. These additives have shown to be efficient in keeping injectors and intake valves clean. Consistent use of deposit control gasolines will help ensure good driveability and fuel economy. If you are not sure whether the gasoline contains deposit control additives, check with the service station operator.

pg. 4:3 Fuel requirements, Refueling

Unleaded Fuel

Each Volvo has a three-way catalytic converter and must use only unleaded gasoline (as specified on the instrument panel and by a label near the filler inlet). U.S. and Canadian regulations require that pumps delivering unleaded gasoline be labelled "UNLEADED". Only these pumps have nozzles which fit your car's filler inlet. It is unlawful to dispense leaded fuel into a vehicle labelled "unleaded gasoline only". Leaded gasoline damages the three-way catalytic converter and the heated oxygen sensor system. Repeated use of leaded gasoline will lessen the effectiveness of the emission control system and could result in loss of emission warranty coverage. State and local vehicle inspection programs will make detection of misfueling easier, possibly resulting in emission test failure for misfueled vehicles.

Octane Rating

Volvo engines are designed for optimum performance on unleaded premium gasoline with an octane rating, AKI of 91, or above. AKI (ANTI KNOCK INDEX) is an average of the Research Octane Number, RON, and the Motor Octane Number, MON, $(RON + MON/2)$. The minimum octane requirement is AKI 87 (RON 91).

Gasoline Containing Alcohol and Ethers

"Oxygenated fuels"

Some fuel suppliers sell gasoline containing "oxygenates" which are usually alcohols or ethers. In some areas, state or local laws require that the service pump be marked indicating use of alcohol or ethers. However, there are areas in which the pumps are unmarked. If you are not sure whether there is alcohol or ethers in the gasoline you buy, check with the service station operator. To meet seasonal air quality restrictions, some states require the use of "oxygenated" fuel in certain areas. Volvo allows the use of the following "oxygenated" fuels; however, the octane ratings listed on this page must still be met.

Alcohol -- Ethanol

Fuels containing up to 10% ethanol by volume may be used. Ethanol may also be referred to as Ethyl alcohol, or "Gasohol".

Ethers -- MTBE

Fuels containing up to 15% MTBE may be used.

Refueling

The fuel tank filler cap is located behind the door on the left rear fender. Open cap slowly during hot weather conditions.

When filling, position the cap in the special bracket on the door. After filling the tank, install the cap and turn until a "click" is heard. The fuel tank is designed to hold approximately 19.3 US gals (73 liters) with sufficient volume left over to accommodate possible expansion of the fuel in hot weather. The "usable" tank capacity will be somewhat less than the specified maximum. When the fuel level is low, such factors as ambient temperature, the fuel's "vapor pressure" characteristics, and terrain can affect the fuel pumps' ability to supply the engine with an adequate supply of fuel. Therefore, it is advisable to refuel as soon as possible when the needle nears the red zone, or when the fuel warning light comes on.

CAUTION: Take care not to spill gasoline during refueling. Gasolines containing alcohol can cause damage to painted surfaces, which may not be covered under the New Vehicle Limited Warranty or Corrosion Protection Warranty. Do not use gasolines containing methanol (methyl alcohol, wood alcohol). This practice can result in vehicle performance deterioration and can damage critical parts in the fuel system. Such damage may not be covered under the New Vehicle Limited Warranty.

pg. 4:4 Driving economy

Economical driving does not necessarily mean driving slowly

Better driving economy may be obtained by thinking ahead, avoiding rapid starts and stops and adjusting the speed of your vehicle to immediate traffic conditions. Observe the following rules:

- Bring the engine to normal operating temperature as soon as possible by driving with a light foot on the accelerator pedal for the first few minutes of operation. A cold engine uses more fuel and is subject to increased wear.
- Whenever possible, avoid using the car for driving short distances. This does not allow the engine to reach normal operating temperature.
- Drive carefully and avoid rapid acceleration and hard braking.
- Do not exceed the speed limit.
- Avoid carrying unnecessary items (extra load) in the car.
- Check tire pressure regularly (check when tires are cold).
- Remove snow tires when the threat of snow or ice has ended.
- Note that roof racks, ski racks, etc., increase air resistance and thereby fuel consumption.
- Avoid using the automatic transmission kick-down feature unless necessary.
- Avoid using the air conditioning when it is not required. When engaged, the air conditioner's compressor places an additional load on the engine.

Other factors which decrease gas mileage are:

- Low tire pressure

- Worn or dirty spark plugs
- Incorrect spark plug gap
- Dirty air cleaner
- Dirty engine oil and clogged oil filter
- Dragging brakes
- incorrect front end alignment

Some of the above mentioned items and others are checked at the standard Maintenance Service intervals.

NOTE: (D)rive or 5th gear (manual transmissions) should be used as often as possible to help improve fuel economy.

Engine warm-up

Engines in vehicles driven short distances are subject to abnormally rapid wear because the engine never reaches normal operating temperature. It is advisable to try to reach normal operating temperature as soon as possible. This is best achieved by driving with a light foot on the accelerator pedal for a few minutes after starting, rather than prolonged idling.

pg. 4:5 Starting the engine

Starting and stopping

1 Fasten the seat belt.

WARNING! Before starting, check that the seat is adjusted properly. Make sure the brake pedal can be depressed completely. Move the seat closer if necessary. Refer to section "Front seats".

2 Apply the parking brake, if not already set. The gear selector (automatic transmission) is locked in the (P)ark position (SHIFT LOCK).

3 Without touching the accelerator pedal , (depress the clutch pedal - manual transmission), turn the ignition key to the starting position. Allow the starter to operate for up to 5 seconds. Release the key as soon as the engine starts. If the engine fails to start, repeat step 3.

For cold starts at altitudes above 6000 ft (1800 m), depress the accelerator pedal halfway and turn the key to the starting position. Release the accelerator pedal slowly when the engine starts.

4 To release the gear selector from the (P)ark position (automatic transmission) the ignition key must be in position II and the brake pedal must be depressed.

See page 6:18 for instructions on manually releasing the SHIFTLCK system.

Do not race a cold engine immediately after starting. Oil flow may not reach some lubricating points fast enough to prevent engine damage.

NOTE: (Automatic transmission only)

Your car is equipped with a KEYLOCK system.

- When the engine is switched off, the gear selector must be in the (P)ark position before the starting key can be removed from the ignition switch.

5 Select the desired gear. The gear engages after a slight delay (automatic transmission) which is especially noticeable when selecting R.

CAUTION: (Automatic transmission only) The engine should be idling; never accelerate until after you feel the gear engage! Too-rapid acceleration immediately after selecting a gear will cause harsh engagement and premature transmission wear.

6 Release the brakes and accelerate.

To stop the car, release the accelerator pedal (depress the clutch - manual transmission) and apply the brakes.

NOTE: Selecting P or N (automatic transmission) when idling at a standstill for prolonged periods of time will help prevent overheating of transmission oil.

WARNING! Always place the gear selector (automatic transmission) in Park and apply the parking brake before leaving the vehicle. Never leave the car unattended with the engine running. Always open the garage doors fully before starting the engine inside a garage to ensure adequate ventilation. The exhaust gases contain carbon monoxide, which is invisible and odorless but very poisonous.

B 5254 S (5-cylinder engine)

This engine features hydraulic valve lifters which means that valve clearance is adjusted automatically. It is possible that the valve lifters will produce a ticking sound for the first few seconds after the engine is started, while the oil pressure is increasing.

If the car has not been used for a long period of time, this ticking sound may last for up to 15 minutes. This is entirely normal.

Do not exceed 3000 rpm until the ticking sound disappears.

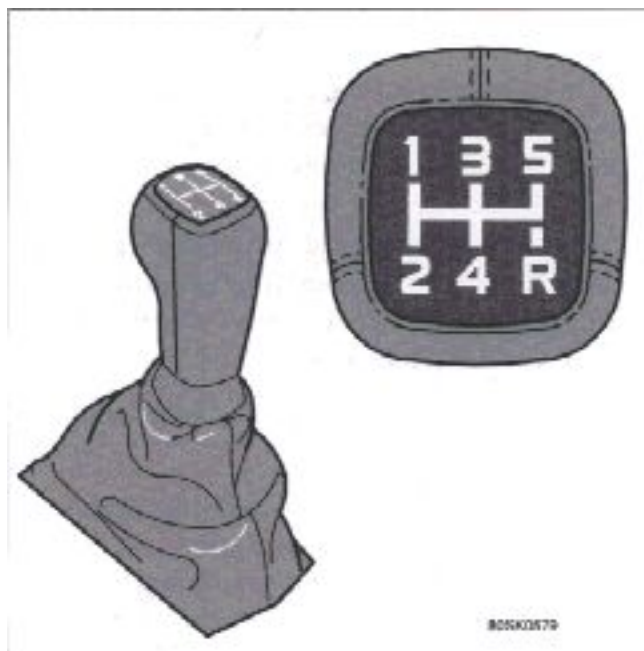

Shift positions

Depress the clutch pedal completely when changing gears.

Remove your foot from the clutch pedal while driving.

Overdrive (5th gear) should be used as often as possible to help improve fuel economy. This gear can be engaged at speeds above approx. 50 mph (80 km/h).

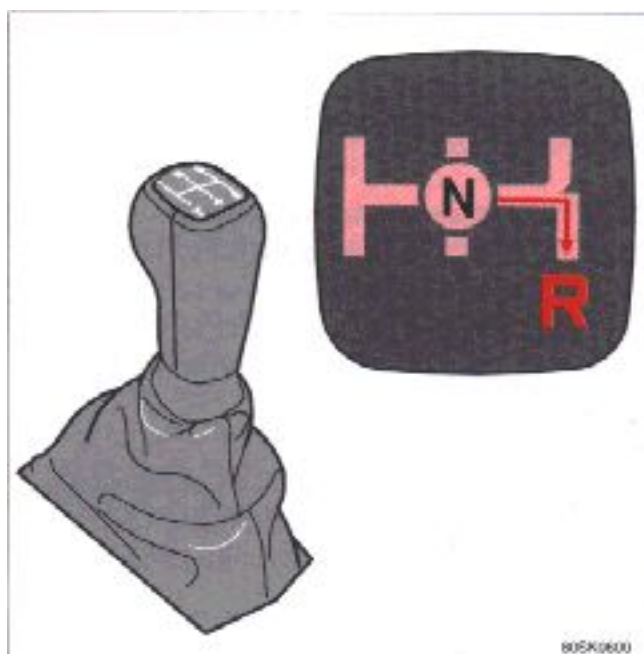

Engaging reverse gear

The gear lever must first be moved to neutral in order to engage reverse gear.

CAUTION: Be careful that you do not inadvertently engage reverse while moving forward.



[Contents](#) | [Top of Page](#)

pg. 4:15 Three-way catalytic converter

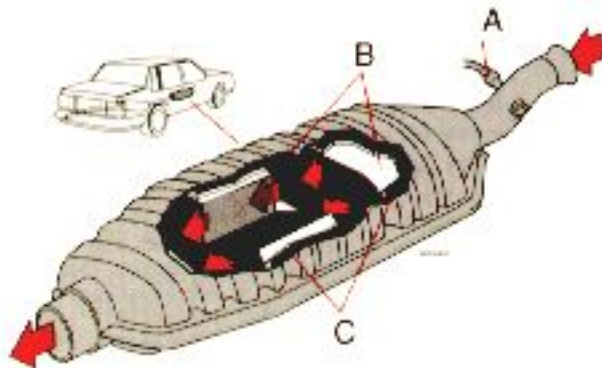

A - heated oxygen sensor, B - ceramic core, C - insulation

Three-way catalytic converter cautions

- Keep your engine properly tuned. Certain engine malfunctions, particularly involving the electrical, fuel or distributor ignition systems, may cause unusually high three-way catalytic converter temperatures. Do not continue to operate your vehicle if you detect engine misfire, noticeable loss of power or other unusual operating conditions, such as engine overheating. A properly tuned engine will help avoid malfunction that could damage the three-way catalytic converter.
- Remember that tampering or unauthorized modification to the engine or the vehicle may be illegal and can cause three-way catalytic converter or exhaust system overheating. This includes:
 - Altering fuel injection settings or components. Adjusting distributor ignition timing beyond specified limits.
 - Altering emission system components or location or removing components
 - Repeated use of leaded fuel.
- Do not park your car over combustible materials, such as grass or leaves, which can come into contact with the hot exhaust system and cause such materials to ignite under certain wind and weather conditions.
- Excessive starter cranking (in excess of one minute), with an intermittently firing or flooded engine, can cause three-way catalytic converter or exhaust system overheating.

NOTE: Unleaded fuel is required for cars with three-way catalytic converters. A label on the instrument panel and inside fuel tank filler door will remind owners and filling station attendants of this requirement.

Important! It is unlawful to dispense leaded fuel into any vehicle labeled "unleaded gasoline only".

pg. 4:16 Brake system



Brake circuit malfunction

If one of the brake circuits should malfunction, the red warning light will come on, the pedal stroke increases slightly, the pedal feels softer and extra pressure is required for normal braking. If the light comes on while driving or braking, stop immediately and check the brake fluid level in the reservoir.

WARNING! If the fluid level is below the MIN mark in either section of the reservoir: **DO NOT DRIVE.** Tow the car to a Volvo dealer and have the brake system checked and repaired.

The logo consists of the letters "ABS" in a white, sans-serif font, centered within a solid red square.

Anti-lock Brake System ABS

If the warning lamp lights up there is a malfunction of the ABS system (the standard braking system will however function) and the vehicle should be driven to a Volvo dealer for inspection. The Anti-lock Braking System (ABS) helps to improve vehicle control (stopping and steering) during severe braking conditions by limiting brake lock-up. When the system "senses" impending lock-up, braking pressure is automatically modulated in order to help prevent lock-up, which could lead to a skid.

The system performs a self-diagnostic test when the vehicle is started and at 20 mph (30 km/h). The brake pedal will pulsate several times and a sound may be audible from the ABS control module. This is normal.

To obtain optimal effect from the ABS system, constant pressure should be kept on the brake pedal while the system is modulating the brakes.

The switching of the ABS modulator will be audible and the brake pedal will pulsate at this time. Please be aware that ABS does not increase the absolute braking potential of the vehicle. While control will be enhanced, ABS will not shorten stopping distances on slippery surfaces.

Moisture on brake discs and brake pads affects braking.

Driving in rain and slush or passing through an automatic car wash can cause water to collect on the brake discs and pads. This will cause a delay in braking effect when the pedal is depressed. To avoid such a delay when the brakes are needed, depress the pedal occasionally when driving through rain, slush etc. This will remove the water from the brakes. Check that brake application feels normal! This should also be done after washing or starting in very damp weather.

Severe strain on the brake system

The brakes will be subject to severe strain when driving in mountains or hilly areas. The speed is usually low which means that the cooling of the brakes is less efficient than when driving on level roads. To reduce the strain on the brakes it is advisable not to use the brakes excessively. Instead, shift into a lower gear, position 3 or in some cases, L (automatic transmission) and let the engine help with the braking. Do not forget that, if you are towing a trailer, the brakes will be subjected to greater load than is normal.

If the brake power-assist does function:

The power assist to the brakes functions only when the engine is running. When the car is moving without the engine running, the brake pedal pressure required to stop the car is increased by 3-4 times. The brake pedal feels stiff and hard.

pg. 4:17 Trailer towing

When preparing for trailer towing, observe the following:

- Use a trailer which meets Federal Safety Standards for rear end collisions (FMVSS 301-75). For trailer weights exceeding 2000 lbs. (908 kg), use only a trailer hitch offered as a Genuine Volvo accessory.

NOTE: Models with automatic transmission are equipped with a transmission oil cooler as standard equipment. This cooler helps prevent overheating of the transmission during times of increased load, as when towing a trailer.

- Maximum trailer weight recommended by Volvo is:

Trailers without brakes : 1540 lbs (700kg)

Trailers with brakes: 2" (50 mm) ball - 3300 lbs (1500 kg), 1 7/8" (47 mm) ball - 2000 lbs (900 kg).

Observe the legal requirements of the state/province in which the vehicles are registered.

WARNING! Bumper-attached trailer hitches must not be used on Volvos, nor should safety chains be attached to the bumper. Trailer hitches attaching to the vehicle rear axle must not be used.

WARNING! Never connect a trailer's hydraulic brake system directly to the vehicle brake system, nor a trailer's lighting system directly to the vehicle lighting system. Consult your nearest authorized Volvo dealer for correct installation.

All Volvo models are equipped with energy-absorbing shock-mounted bumpers. Trailer hitch installation should not interfere with the proper operation of this bumper system.

Trailer towing does not normally present any particular problems, but take into consideration:

- The rear suspension can be equipped with "Nivomat", an automatic levelling system which compensates for load variations. The system operates when the vehicle is in motion. The rear of the vehicle will however droop if for instance you are carrying a lot of luggage in the trunk or if the vehicle is hitched to a trailer. However, as soon as you start driving, the "Nivomat" system will raise the rear of

the vehicle to the most suitable level.

- Recommended hitch tongue load is 110 (50 kgs) for trailer weights below 2,650 lbs (1,200 kgs) and 165 lbs (75 kgs) for trailer weights above 2,650 lbs (1,200 kgs).
- For trailer weights between 2,650-3,300 lbs (1,200-1,500 kgs) a top speed of 50 mph (80 km/h) should never be exceeded.
- Increase tire pressure to recommended full See section "Wheels and load pressure. tires".
- Engine and transmission are subject to increased loads. Therefore, engine coolant temperature should be closely watched when driving in hot climates or hilly terrain. Use a lower gear and turn off the air conditioner if the temperature gauge pointer enters the red range.
- Avoid overload and other abusive operation.
- Hauling a trailer affects handling, durability, and economy.
- It is necessary to balance trailer brakes with the towing vehicle brakes to provide a safe stop (check and observe State/Local regulations).
- Do not connect the trailer's brake system directly to the vehicle's brake system.
- More frequent vehicle maintenance is required.
- Remove the ball and drawbar assembly when the hitch is not being used.
- Volvo recommends the use of synthetic engine oil when towing a trailer over long distances or in mountainous areas.

NOTE: Refer to section "Automatic transmission" for additional trailer hauling tips.

pg. 4:18 Winter driving

Cold weather precautions

- If you wish to check your car before the approach of cold weather, the following advice is worth noting:
 - Make sure that the engine coolant contains at least 50 percent antifreeze: that is, 5.3 qts. (5 liters) Volvo Genuine Coolant/Antifreeze. This gives protection against freezing down to -31°F (-35°C). See section "Coolant". The use of "recycled" antifreeze is not approved by Volvo. Different types of antifreeze may not be mixed.
 - Try to keep the fuel tank well filled - this prevents the formation of condensation in the tank. In addition, in extremely cold weather conditions it is worthwhile to add fuel line de-icer before refueling.
 - The viscosity of the engine oil is important. Oil with low viscosity (thinner oil) improves cold-weather starting as well as decreasing fuel consumption while the engine is warming up. For winter use, 5W-30 oil, particularly the synthetic type, is recommended. Be sure to use good quality oil but do not use this cold-weather oil for hard driving or in warm weather. See section "Engine oil" for more information.
 - The load placed on the battery is greater during the winter since the windshield wipers, lighting, etc. are used more often. Moreover, the capacity of the battery decreases as the temperature drops. In very cold weather, a poorly charged battery can freeze and be damaged. It is therefore advisable to check the state of charge more frequently and spray an anti-rust oil on the battery posts.

- To prevent the washer fluid reservoir from freezing, add washer solvents containing antifreeze. This is important since the dirt is often splashed on the windshield during winter driving, thus requiring frequent use of the washers and wipers. The Volvo Washer Solvent should be diluted as follows: Down to 14°F (-10°C): 1 part anti-freeze and 4 parts water Down to 5°F (-15°C): 1 part anti-freeze and 3 parts water Down to 0°F (-18°C): 1 part anti-freeze and 2 parts water Down to -18°F (-28°): 1 part anti-freeze and 1 part water
- Use Volvo Teflon lock spray or grease in the locks.

NOTE: Avoid the use of de-icing sprays as they can cause damage to the locks.

pg. 4:19 Long distance trips, City driving

Before a long distance trip

It is always worthwhile to have your car checked at a Volvo dealer before driving long distances. Your dealer will also be able to supply you with bulbs, fuses, spark plugs and wiper blades for your use in the event that problems occur.

If you prefer to check the car yourself, please note the following:

- Check that the engine runs smoothly and that fuel consumption is normal.
- Check engine oil, coolant levels, and for possible fuel leakage.
- Check transmission oil level.
- Check condition of drive belts.
- Check state of charge of battery.
- Examine tires carefully (the spare tire as well), and replace those that are worn. Check tire pressures.
- The brakes, front wheel alignment, and steering gear should be checked by your Volvo dealer only.
- Check all lights, including high beams.
- Reflective warning triangles are legal requirement in some countries.
- Have a word with your Volvo dealer concerning engine adjustments if you intend to drive in countries where it may be difficult to obtain correct fuel.
- Consider your destination. If you will be driving through an area where snow or ice are likely to occur, consider snow tires.

City driving

City driving can be a severe driving condition. Low operating speeds, long periods of idling combined with high operating temperatures. Air conditioning usage, etc. will make more frequent servicing necessary (twice a year or at 5,000 mile ((8,000 km)) intervals).

pg. 4:20 Vehicle storage

If you do not intend to use your car for a long time

The following points may be of use if you do not intend to use your car for a long time (e.g. because of a long holiday, winter, etc.)

- Fill fuel tank to prevent water from condensing inside the tank.
- Wash the car carefully and wax it to protect the paint, don't forget the chromed parts.
- The vehicle should be left in a dry, well ventilated garage.
- Do not apply the hand brake. Block the wheels instead. Disconnect the battery.
- Lift the wiper arms away from the windshield. Increase tire pressure to maximum allowed, i.e. 36 psi.
- Open one of the windows slightly for ventilation.
- Ensure that the coolant contains sufficient anti-freeze to provide protection down to - 22° F (- 30° C).

Volvo anti-freeze also provides resistance against corrosion.

- Remove all valuables and lock the car.
- Keep the battery fully charged.



[Contents](#) | [Top of Page](#)

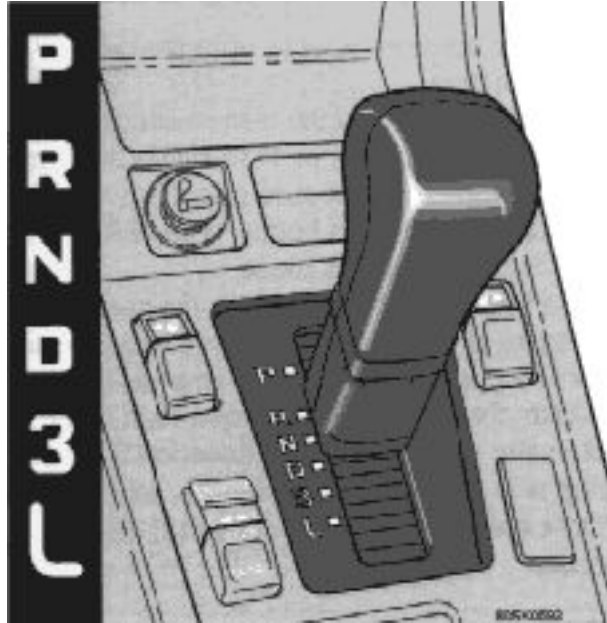

P (Park)

Use this position when starting the engine or parking the car.

Never use P while the car is in motion.

The parking brake should also be used when parking on grades.

The gear selector is mechanically locked in the P position (Shift lock).

To release the selector, start the engine and depress the brake pedal. If it is necessary to manually release the gear selector, see page 6:18 for instructions.

WARNING! Never leave the car when the engine is running. If, by mistake, the gear selector is moved from P the car may start moving.

R (Reverse)

Never engage R while the car is moving forward.

N (Neutral)

Neutral = no gear is engaged. Use the parking brake. The engine can be started with the gear selector in this position.

D (Drive)

D is the normal driving position and should be used as often as possible to help improve fuel economy.

When modes E or S are selected, upshift and downshift of the forward gears occur automatically and are governed by accelerator pedal position and engine speed.

CAUTION:

- Never select P or R while the car is in motion.
 - When initially selecting positions D, 3, L or R, your right foot should press firmly on the brake pedal to ensure that the car is standing still with the engine idling.
 - The gear selector should not be downshifted to L at speeds above 75 mph (125 km/h)*
- * Always observe posted speed limits!

3 (intermediate position)

Automatically shifts up and down between 1st, 2nd, and 3rd gears when in driving modes E or S. There is no upshift from 3rd gear. Position 3 can be used for driving in hilly terrain, for towing trailers or for increased engine braking power.

L (low position)

No upshift can occur when L is engaged. Select position L for driving in first and second gears. Use this position to select low gear with no upshift, e.g. when ascending and descending steep grades.

Kick-down

Automatic shift to a lower gear (kick-down) is achieved by depressing the accelerator pedal fully and briskly. An upshift will be achieved when approaching the top speed for a particular gear or by releasing the accelerator pedal slightly. Kick-down can be used for maximum acceleration or when passing at highway speeds.

"Lock-up"

The transmission has a "lock-up" function which reduces engine speed and saves fuel. "Lock-up" is based on the fact that the gearbox's torque converter is disengaged for changes between 2nd, 3rd and 4th gears.

"Lock-up" can sometimes be felt as an additional gear change.

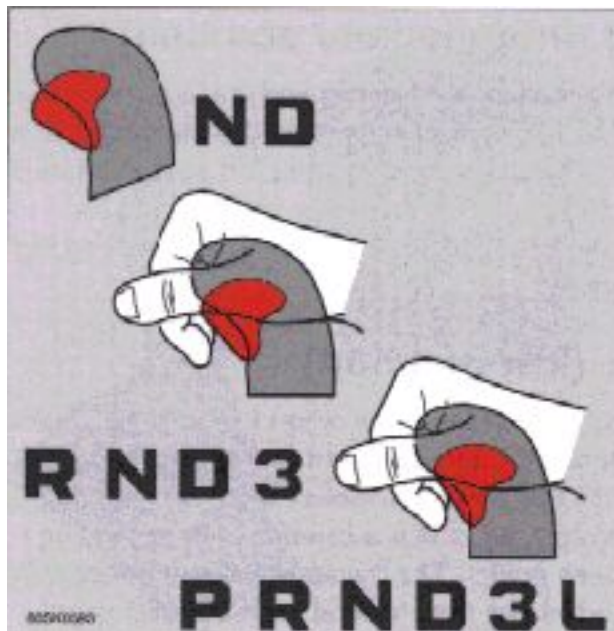

Shift gate positions

Shift gate positions

The gear selector can be moved freely between D and 3. Selections of other positions are obtained by depressing the selector knob prior to moving the selector.

Slightly depressing the selector knob allows selection of positions N, D, 3 and L. Fully depressing the selector knob allows selection of positions R and P. This is also necessary when initially bringing the selector out of position P. Fully depressing the selector knob permits shifting freely between all positions.



Mode selector

Mode selector

The push-buttons to the left of the gear lever are for selection of modes E, S and W. The desired mode can be selected at any time, including while the car is moving.

ECON Economy Mode

This mode is used for normal driving. The gearbox changes gears at a lower engine speed to help achieve the lowest possible fuel consumption.

SPORT Sport Mode

This mode is adapted to "sporty" driving characteristics. The transmission changes up and down at higher engine speeds so as to offer maximum performance.

WINTER Winter mode

This mode may be selected for starting/moving off on slippery roads.

In this mode:

- * In position D, the gearbox starts in 3rd gear and changes up to 4th gear.
- * In position 3, 2nd gear is locked and there is no change up to 3rd gear.

In position L, 1st gear is locked.

- * These positions always offer the kick-down function.

The indicator lamp in the instrument panel  lights up when Winter mode is selected. Press button WINTER in order to disengage the Winter mode.

When Winter mode is disengaged, the gearbox automatically reverts to the previously selected S or E mode. If the indicator lamp  begins to flash, this is an indication of a fault in the automatic gearbox. Please contact your Volvo dealer if this occurs.

CAUTION: Driveability and fuel economy will be adversely affected by prolonged driving in this mode. Volvo recommends using this mode only when starting in extremely slippery conditions.

pg. 4:9 Points to remember

"Special Tips"

- For steep hills and when driving for prolonged periods at low speeds, position L should be selected. Avoid, however, repeated changes since this can cause overheating of the transmission oil. For driving on long continuous uphill gradients, select position 3.

- Select position L when descending long, steep downgrades and position 3 for less steep downgrades, in order to obtain the best possible engine braking effect.
- Do not hold the car stationary on an incline by using the accelerator pedal. Instead, apply the hand brake (parking brake). This prevents the transmission oil from becoming overheated.
- When towing a trailer, select shift position 3.
- The (E)conomy mode should be selected when the cruise control is engaged.
- While towing a trailer in hilly terrain, do not drive continuously at engine speeds above 4500 rpm to help avoid high engine oil temperatures.

Cooling system

The risk for engine overheating is greatest, especially in hot weather, when:

- towing a trailer up steep inclines for prolonged periods at wide open throttle and low engine rpm.
- idling for prolonged periods while the air conditioning system is in operation.
- stopping the engine suddenly after high speed driving (so-called "after-boiling" can occur).

To avoid overheating, the following rules should be followed:

- Do not drive for prolonged periods at engine speeds above 4500 rpm if you are towing a trailer in hilly terrain.
- Reduce speed and downshift when towing a trailer up long, steep inclines. The risk of overheating can be reduced by switching off the air conditioning system for a short time.
- Do not let the engine idle unnecessarily for prolonged periods.
- Do not mount auxiliary lamps in front of the grill.

When the risk of overheating is imminent, or in the event of overheating, (the temperature gauge goes repeatedly into, or stays continually in, the red section) the following precautions should be taken:

- Switch off the air conditioning system.
- Stop the car and put the gear lever into neutral. Do not stop the engine!
- If the vehicle is overheating, switch the heater to full (maximum) position. Increase the engine speed to approx. 2000 rpm (twice idling speed).
- Check the level of coolant in the expansion tank. Top-up, if necessary. See "Cooling System".

The engine must be switched off before topping-up coolant.

CAUTION: Drive slowly and carefully if going through standing water (i.e. flooded roadways, etc.). Damage to engine could result if excess water is ingested through the air intake system. Never drive the vehicle in water deeper than 1 foot (300 mm).

WARNING! Do not drive with trunk lid or tailgate open!

Poisonous exhaust gases may enter via the open trunk lid or tailgate.

If the trunk lid/tailgate must be kept open for any reason, proceed as follows:

- Close the windows.
- Set the ventilation system control to air flow to floor, windshield and side windows and blower control to its highest setting.

pg. 4:10 Points to remember (cont.)**Electrical system**

When replacing the battery or when carrying out work involving the electrical system, the following should be observed:

- A battery connection to the wrong terminal will damage the diodes. Before connections are made, check the polarity of the battery with a voltmeter.
- If booster batteries are used for starting, they must be properly connected to minimize the risk of the diodes being damaged. For correct connection, see "Jump starting" section.
- Never disconnect the battery circuit (for example, to replace the battery) while the engine is running, as this will immediately ruin the generator. Always make sure that all the battery connections are properly tightened.
- If any electrical welding work is performed on the vehicle, the ground lead and all the connecting cables of the generator must be disconnected and the welder cables placed as near the welding point as possible.
- The radio must be turned off before the battery is disconnected.
- If the radio has an anti-theft code and the battery has been disconnected, the code must be re-entered before the radio will function properly.

pg. 4:11 Points to remember (cont.)**Weight distribution affects handling**

At the specified curb weight your car has a tendency to understeer, which means that the steering wheel has to be turned more than might seem appropriate for the curvature of a bend. This ensures good stability and reduces the risk of rear wheel skid. Remember that these properties can alter with the vehicle load. The heavier the load in the trunk (max. 220 lbs, 100 kg), the less the tendency to understeer.

Handling, roadholding

Vehicle load, tire design, and inflation pressure, all affect vehicle handling. Therefore, check that the tires are inflated to the recommended pressure according to the vehicle load. See "Tire pressure" section. Loads should be distributed so that capacity weight or maximum permissible axle loads are not exceeded.

WARNING! It is recommended that tires of the same make and dimensions be used on all four wheels. Do not use bias ply tires as this will adversely alter vehicle handling characteristics.

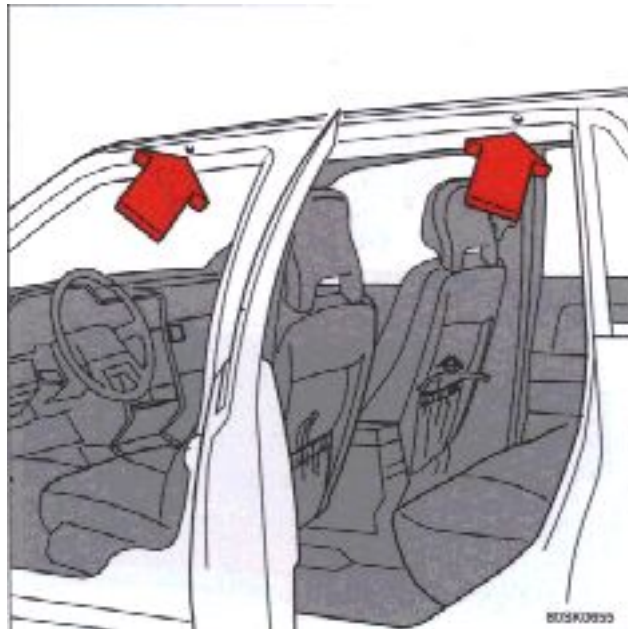

Holes for roof rack

Roof racks

Roof racks are available as Volvo accessories. Observe the following points when is use:

- Avoid single-point loads. Distribute the load evenly.
- Place heavier cargo at the bottom of the load.
- Observe that the center of gravity and handling are influenced by load weight.
- Increasing load size increases wind resistance and, thus, adversely affects fuel economy.
- Anchor the cargo correctly with appropriate cords.
- Drive carefully. Avoid rapid starts, fast cornering and hard braking.
- Max. roof load is 220 lbs. (100 kg).

WARNING! An extra mat on the driver's floor can cause the accelerator pedal to catch. Check that the movement of the accelerator pedal is not impeded. Not more than one protective floor covering may be used at one time.

pg. 4:12 Emergency towing (pulling of vehicles)

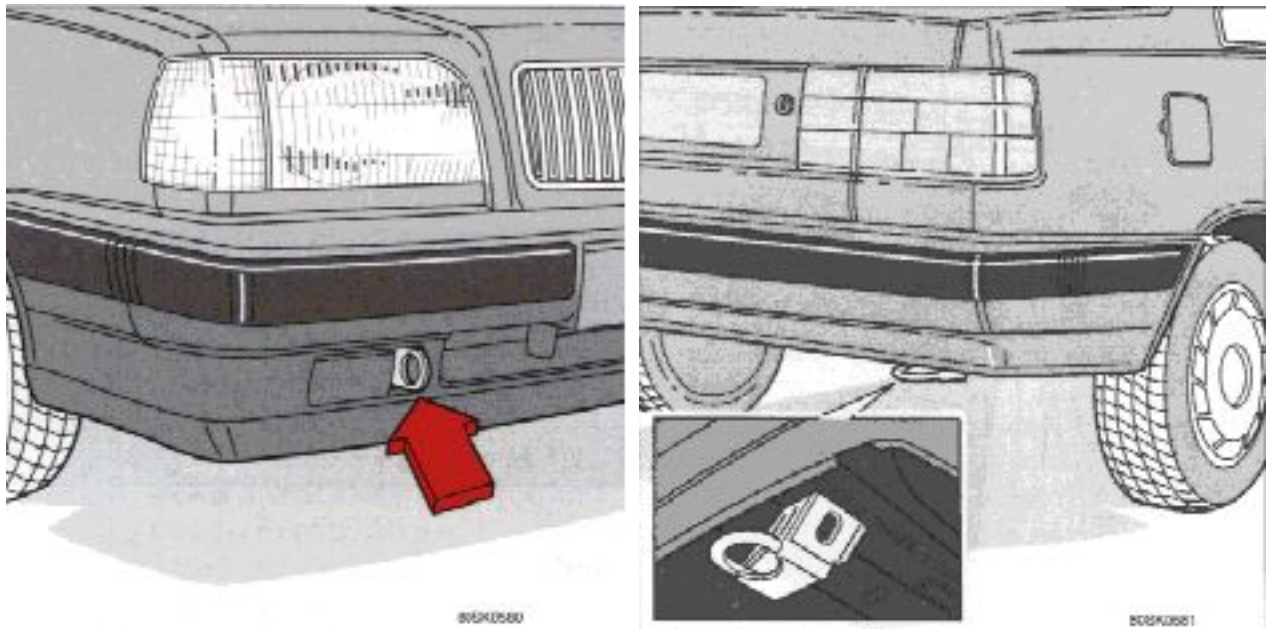

Front eyelet Rear eyelet

Precautionary steps to observe when the car is in tow

- Steering must be unlocked.
- Please check with state and local authorities before attempting this type of towing, as vehicles being towed are subject to regulations regarding maximum towing speed, length and type of towing device, lighting, etc.
- Remember that power brake and power steering assists will not be available when engine is inoperative. Brake pedal pressure required is 3 - 4 times above normal and greater steering effort must be exerted.
- Gear selector in position N. Check transmission oil level (see section titled "Transmission oil").
- Maximum speed: 20 mph (30 km/h).
- Maximum distance with front wheels on ground: 20 miles (30 km).
- (Automatic transmissions only): If the battery is dead, it is not possible to release the gear selector by pressing the brake pedal. Release the gear selector manually, by pressing the OVERRIDE button near the base of the gear selector.

CAUTION: The towing eyelets must not be used for pulling another vehicle out of a ditch or any similar purpose involving severe strain.
Do not attempt to start the car by pushing or pulling it as damage to the three-way catalytic converter can result.

pg. 4:13 Vehicle towing information

Only use wheel lift or flat bed equipment.

CAUTION: Sling-type equipment applied at the front will damage radiator and air conditioning lines. It is equally important not to use sling-type equipment inside the rear wheels; serious damage to the rear axle may result.

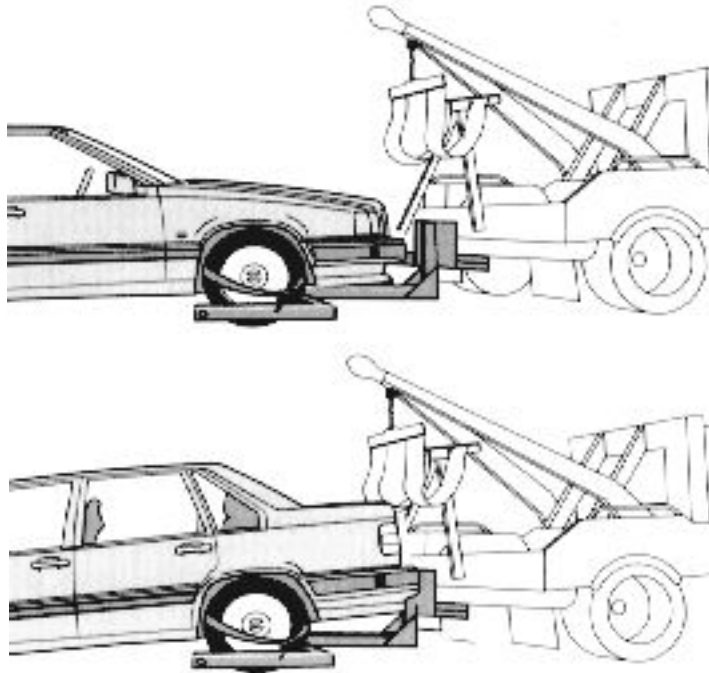

pg. 4:14 Jump starting

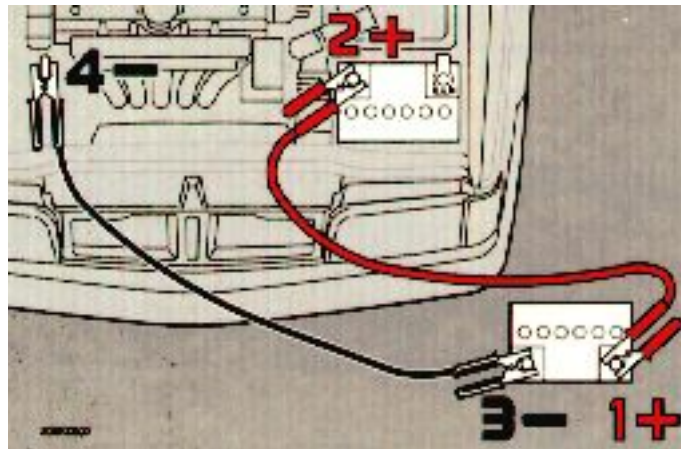

CAUTION: Improper hook-up of jumper cables or use of other than 12-volt batteries could result in damage to equipment and/or battery.

If the booster battery to be used is in another car, check that the cars are not touching to prevent premature completion of a negative circuit. Note the position of the battery terminals and using jumper cables:

- First connect the booster battery positive (+) terminal (1) to car battery positive (+) terminal (2).

- Then connect the booster battery negative (–) terminal (3) to a stationary solid metal part on the engine at a point away from the battery (4).

Do not connect the jumper cable to any part of fuel system or to any moving parts. Avoid touching hot manifolds.

After the engine has started, first remove the negative (–) terminal jumper cable. Then remove the positive (+) terminal jumper cable.

WARNING!

- To reduce the possibility of explosion, never expose the battery to open flame or electric spark.
- Do not smoke near battery.
- Batteries generate hydrogen gas which is flammable and explosive.
- Battery fluid contains sulfuric acid. Do not allow battery fluid to contact eyes, skin, fabrics or painted surfaces. If contact occurs, flush affected area immediately with water. Obtain medical attention immediately if eyes are affected.

Failure to follow the instructions for jump starting can lead to personal injury.



[Contents](#) | [Top of Page](#)

Wheels and tires

pg. 5:1 Wheels and tires

Wheels and tires

The handling and riding comfort of the vehicle is dependent on the inflation pressure and the type of tires fitted. Read the following pages carefully.

[5:2](#) General information, Snow chains

[5:3](#) Wear indicator, Tire economy, Flat spots, Winter tires

[5:4](#) Inflation pressure

pg. 5:2 Wheels and tires (cont.)

General information

Your vehicle is equipped with 195/60R15 tires. The tire designation is coded as follows:

195 = tire width in mm.

60 = tire profile. This is the relationship (in percent) between the section height and the width of the tire.

R = radial tires.

15 = diameter in inches

The tires have good road holding characteristics and offer good handling on dry and wet surfaces. It should be noted however that the tires have been developed to give these features on snow/ice-free surfaces. For optimum road holding on icy or snow covered roads - we recommend suitable winter tires. When replacing tires, be sure that the new tires are the same size designation, type (radial) and preferably from the same manufacturer, on all four wheels. Otherwise there is a risk of altering the car's road-holding and handling characteristics.

NOTE: When storing wheel/tire assemblies (e.g. winter tires and wheels), either stand the assemblies upright or suspend them off the ground. Laying wheel/tire assemblies on their sides for prolonged periods can cause wheel and/or tire damage.

Snow chains

Snow tire chains can be used on your Volvo with the following restrictions:

- Snow chains should be installed on front wheels only.
- Snow chains can be used on the tires and wheels provided as original production equipment with your Volvo.

If accessory, aftermarket or "custom" tires and wheels are installed and are of a size different than the original tires and wheels, chains in some cases CANNOT be used. Sufficient clearances between chains and brakes, suspension and body components must be maintained.

- Some strap-on type chains will interfere with brake components and therefore CANNOT be used.

CAUTION:

- Check local regulations regarding the use of snow chains before installing.
- Always follow the chains manufacturer's installation instructions carefully. Install chains as tightly as possible and re-tighten periodically.
- Never exceed the chain manufacture's specified maximum speed limit. (Under no circumstances should that limit be higher than 30 mph (45 km/h).
- Avoid bumps, holes or sharp turns when driving with snow chains.
- The handling of the vehicle can be adversely affected when driving with chains. Avoid fast or sharp turns as well as locked wheel braking.

pg. 5:3 Wheels and tires (cont.)

Wear indicator

The tires have a so-called "wear indicator" in the form of a number of narrow strips running across or parallel to the tread. When approx. 1/16" (1.6 mm) is left on the tread, these strips show up and indicate that the tire should be replaced.

Tires with less than 1/16" (1.6 mm) tread have a very poor grip in rain or snow.

When replacing worn tires, it is recommended that the tire be identical in type (radial) and size as the one being replaced. Using a tire of the same make (manufacturer) will prevent alteration of the driving characteristics of the vehicle.

To improve tire economy:

- Maintain correct tire pressure.
- Drive smoothly: avoid fast starts, hard braking and tire screeching.
- Tire wear increases with speed.
- Do not change wheel location unless necessary.
- Correct front wheel alignment is very important.
- Unbalanced wheels impair tire economy and driving comfort.
- Hitting curbs or potholes can damage the tires and/or wheels permanently.

Flat spots

All tires become warm during use. After cooling, when the vehicle is parked, the tires have a tendency to

distort slightly, forming flat spots. These flat spots can cause vibrations similar to the vibrations caused by imbalanced wheels.

They do, however, disappear when the tire warms up. The degree to which the flat spots form depends on the type of cord used in the tire. Remember that, in cold weather, it takes longer for the tire to warm up and consequently longer for the flat spot to disappear.

Snow tires, studded tires

Tires for winter use:

Use snow tires fitted to the standard 15" wheels on all four wheels (preferably steel). Do not mix tires of different design, as this could negatively affect overall tire road grip especially during slippery road conditions.

Studded tires should be run-in 300-600 miles (500-1000 km) during which the car should be driven as smoothly as possible to give the studs the opportunity to seat properly in the tires. The car tires should have the same rotational direction throughout their entire lifetime. In other words, if you wish to rotate the wheels, make sure that the same wheels are always on the same side of the car.

NOTE: Regulations governing the use of studded tires may vary from one state or province to another.

WARNING! Special wheel rims for air dams

Only special wheel rims, tested and approved by Volvo, are suitable for use with the air dam installed on the 850.

pg. 5:4 Wheels and tires (cont.)

Checking and correcting tire pressure

- Check the tire pressure when refueling.
- The tire pressure should be corrected only when the tires are cold.
- With warm tires, correct only when the pressure is too low. The tire temperature rises after driving just a few miles.

Vehicle Loading

The tires on your Volvo will perform to specifications at all normal loads when inflated as recommended on the tire information label located on the inside of the fuel filler flap. This label lists both the tire and vehicle design limits.

Do not load your car beyond the load limits indicated.

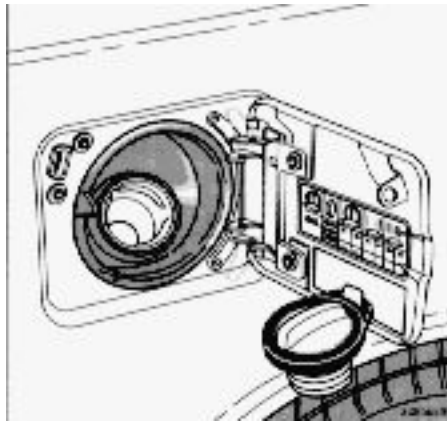

Tire pressure label



[Contents](#) | [Top of Page](#)

In case of emergency

pg. 6:1 In case of an emergency

In case of an emergency

Even if you maintain your car in good running condition, there is always the possibility that something might go wrong and prevent you from driving, such as a punctured tire, blown fuse or bulb, etc. For additional information, see section "ON CALL Road Assistance".

[6:2](#) Wheel changing[6:4](#) Spare tire[6:5](#) Replacing bulbs[6:12](#) Replacing fuses[6:14](#) Replacing wiper blades[6:15](#) Service diagnosis (Trouble-shooting)

pg. 6:2 Wheel changing

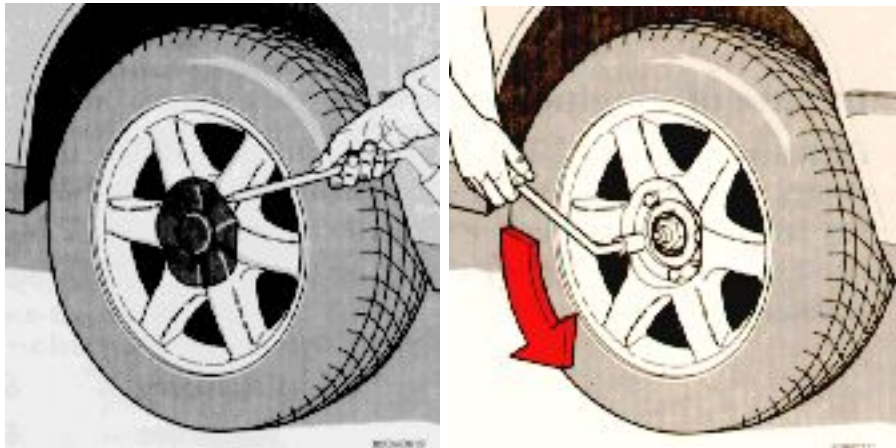
**Changing a wheel**

The spare wheel is located under the carpet on the trunk floor. The jack and crank are secured in the wheel recess.

- Engage the parking brake.
- Put the gear selector in (P)ark (automatic) or in Reverse (manual).
- Remove the wheel cap using the lug wrench in the tool kit.
- With the car still on the ground, use the lug wrench to loosen the wheel bolts 1/2 - 1 turn. Turn the

bolts counterclockwise to loosen.

- Fold out the crank handle on the jack by pressing the nob on the handle downward. To attach the jack, refer to the illustration on the following page.

NOTE: To avoid excessive wear and the necessity of rebalancing, mark and reinstall wheels in same location and position as before removal. To lessen the chance of imbalance, each wheel hub is equipped with a guide stud to ensure that a removed wheel can be reinstalled in its original position (as when changing over to winter tires/wheels).

pg. 6:3 Wheel changing (cont.)



There is a jack attachment located in the center on each side of the car. Position the jack on the bar in the attachment as shown in the illustration above and crank while simultaneously guiding the base of the jack to the ground. The base of the jack must be flat on a level, firm, non-slippery surface. Before raising the car check that the jack is still correctly positioned in the attachment. Raise the vehicle until both wheels on the side of the car where the jack is attached are lifted off the ground. Unscrew the wheel bolts completely and carefully remove the wheel so as not to damage the tread on the studs.

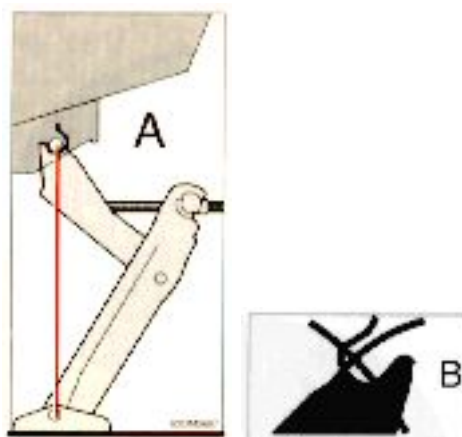

Jack attachment

Installing the wheel

Clean the contact surfaces on the wheel and hub. Lift the wheel and place it on the hub. Make sure that you align the wheel with the guide stud on the wheel hub prior to installation. Install the wheel bolts cross-wise and tighten by turning lightly clockwise. Lower the vehicle to the ground and alternately tighten the bolts to 81 ft. lbs. (110 Nm). Install the wheel cap.

CAUTION: Correct tightening torque on wheel bolts must be observed.

WARNING!

- The jack attachment must engage the bar in the jack attachment (A). The car's weight must not rest on the jack's attachment (B).
- Be sure the jack is on firm and level ground.
- Never allow any part of your body to be extended under a car supported by a jack.
- Use the jack intended for the car when replacing a wheel. For any other job, use stands to support the end of the car being worked on.
- Apply the parking brake, select position P (automatic transmission) or Reverse gear (manual transmission).
- Block the wheels standing on the ground, use rigid wooden blocks or large stones.
- The jack should be kept well-greased.

pg. 6:4 Spare tire

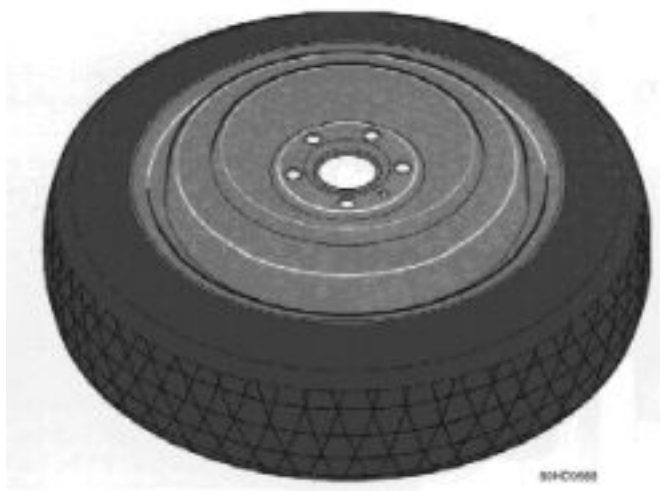

Temporary Spare

The spare tire in your car is what is called a "Temporary Spare". It has the following designation: T115/70 R 15.

Recommended tire pressure (see decal on fuel filler flap) should be maintained irrespective of which

position of the car the Temporary Spare tire is used on.

In the event of damage to this tire, a new one can be purchased from your Volvo dealer.

WARNING! Current legislation prohibits the use of the "Temporary Spare" tire other than as a temporary replacement for a punctured tire. In other words, it must be replaced as soon as possible by a standard tire.

Roadholding, etc., may be affected with the "Temporary Spare" in use. Do not, therefore, exceed 50 mph (80 km/h).



[Contents](#) | [Top of Page](#)

pg. 6:12 Replacing fuses

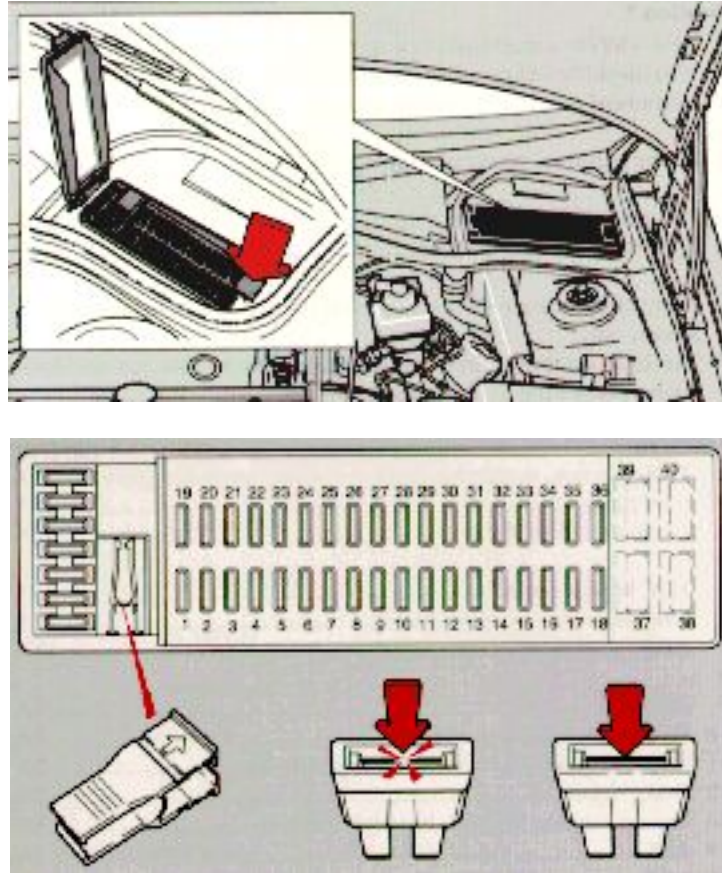

Fuse removal tool Defective fuse Intact fuse

Replacing fuses

If an electrical component fails to function, it is likely that a fuse has blown due to a temporary circuit overload.

The fuse box is located in the engine compartment (see illustration) and can be opened by lifting the cover.

A label on the inside of the cover indicates the amperage and the electrical components that are connected to each fuse.

The easiest way to see if a fuse is blown is to remove it. Pull the fuse straight out. From the side, examine the curved metal wire to see if it is broken. If so, put in a new fuse of the same color and amperage (written on the fuse). Spare fuses are stored in a compartment in the fuse box.

If fuses burn out repeatedly, have the electrical system tested at a Volvo dealer.

If you find it difficult to remove a fuse, you will find a special fuse tool clipped in the fuse box.

pg. 6:13 Fuses

Location * Amperage

- 1 Fuel injection, distributor ignition system, automatic gearbox 15A
- 2 Fuel pump, alarm 15A
- 3 Interior courtesy lights, oil level sensor 10A
- 4 –
- 5 ECC blower (speed 4) 30A
- 6 Central locking system 25A
- 7 Audio system 15A
- 8 Power antenna, electrical connector for trailer 25A
- 9 ABS, TRaction Control System 30A
- 10 –
- 11 Electrically heated rear window and side-view mirrors 30A
- 12 Brake lights 10A
- 13 Hazard warning flashers, headlight flashers 15A
- 14 ABS, TRaction Control System 30A
- 15 Audio system, courtesy lights, door open warning lights, glove compartment light, trunk light, doorstep courtesy light, remote operated central locking system, oil level sensor 10A
- 16 Space for optional equipment –
- 17 Key reminder 10A
- 18 Heated front seats, power side-view mirrors 25A
- 19 Left high beam 15A
- 20 Right high beam, high beam indicator light 15A
- 21 Left low beam 15A
- 22 Right low beam 15A
- 23 Left parking lights, license plate lights 10A
- 24 Right parking lights 10A
- 25 Rear fog light, rear fog light indicator light 10A
- 26 –
- 27 Backup lights, direction indicators 15A
- 28 Cruise control, heated rear window, seat belt reminder light, bulb failure warning sensor, shiftlock 10A
- 29 ABS, TRaction Control System 15A
- 30 Cigarette lighter 10A
- 31 ECC blower (speeds 1-3), ECC 25A
- 32 Audio system 10A
- 33 Power seat, OBD test socket 15A
- 34 Wipers/washers, horn 25A
- 35 Instrument panel lights, TRaction Control System, Power sun roof 10A
- 36 –
- 37 Power windows, power sun roof AUT/CB **
- 38 –

39 Power seat (driver's side) AUT/CB **

40 –

* Some of the equipment/systems listed may be available on certain models only and/or as optional items only.

** This is an automatic circuit breaker located in the fuse box and does not normally need to be replaced.

For more detailed information concerning function and location of relays, fuses, etc., refer to the Volvo Service Manuals. These can be purchased directly using the Service Literature Brochure/Order Form or through your Volvo dealer.

pg. 6:14 Replacing wiper blades

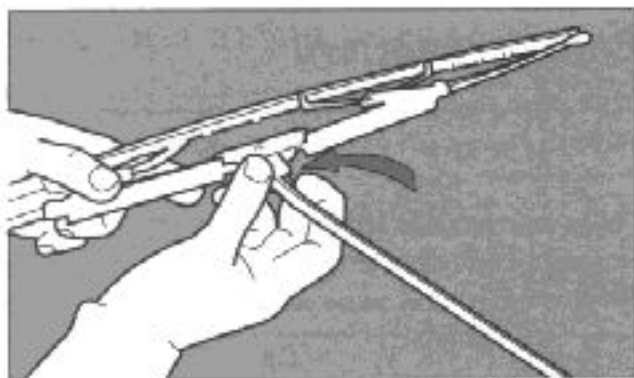

Replacing wiper blades

Lift the wiper arm off the windshield and hold blade at right angles to arm. Pinch the end of the plastic clip located at the back of the arm.

Slide the wiper blade along the arm to release it from the hook.

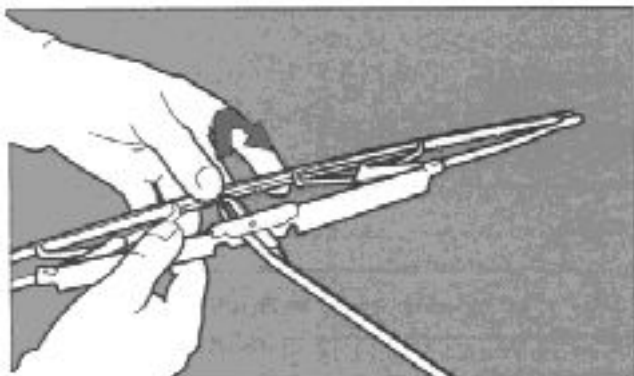

Install new blade (installation is the reverse of removal) and make sure that it is properly attached to the wiper arm.

NOTE: For reasons of safety, you should change the windshield wiper blades as soon as they start to leave marks on the windshield or fail to wipe efficiently and cleanly.

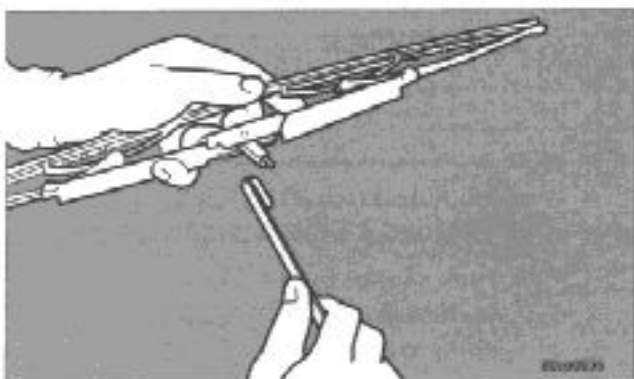

To obtain maximum lifetime from a set of wiper blades, clean them with a stiff-bristle brush and warm, soapy water as part of a normal car wash.

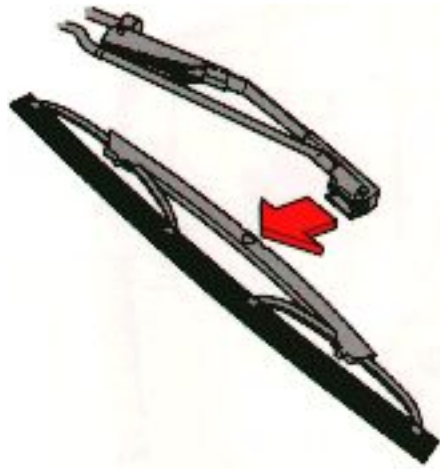

Replacing headlight wiper blades

Pull the wiper blade in the direction indicated by the arrow in the illustration to remove it. Press the new blade into place.

Check that the new blade is properly attached to the wiper arm.

pg. 6:15 Service diagnosis

The diagnoses outlined below are intended to serve only as guides to locate and temporarily correct minor faults. Causes of unsatisfactory performance should be investigated and corrected by your Volvo dealer only. See section "Road Assistance".

Engine fails to start or is difficult to start

The instructions for starting the engine have not been followed, see page 4:5.
Start the engine according to the instructions.

Weak battery or dead cell

With the starting (ignition) switch in the "Driving" or "On" position, check to see if the warning lights on the dashboard come on and if they stay on when the starter is engaged. If the lights do not come on or if they go off when the starter is engaged the battery is discharged, or see below.

Fault in the electrical/distributor ignition system

Check all the electrical connections to the starter motor and battery.

Clean or replace battery terminals if necessary.

The ground strap should also be checked for looseness or corrosion.

Check the spark plugs (gap should be 0.7 mm), clean or replace if necessary.

No fuel reaches the engine

Check that there is fuel in the tank.

Check that none of the hoses/connections in the fuel system are loose or kinked.

Check that the fuel pump fuse (no. 2) is not blown.

Open circuit between starting (ignition) switch and starting (ignition) switch terminal on starter

The circuit is closed if a ticking sound is heard from the starter when it is engaged. If no clicking sound is heard, check that the blue wire at the starter is secure. If still no clicking sound is heard, the starting, (ignition) switch or the wire is defective.

Blocked air cleaner/fuel filter

Replace filter(s).

Imbalance, resonance, or heavy steering during driving

Wheel imbalance

Have the wheels re-balanced.

Insufficient oil in the power steering pump

Check the oil level, see page 8:12.

Engine overheats

Radiator hoses cracked or leaking

Check the radiator hoses and replace if necessary

Insufficient coolant

Check the coolant level and add as necessary. See page 8:16.

Fault in electric cooling fan

Check that the electric cooling fan functions properly.

WARNING! The electric cooling fan may start or continue to operate (for up to 6 minutes) after the engine has been switched off.

pg. 6:16 Service diagnosis (cont.)

Excessive fuel
consumption

Spark plugs worn.
Replace plugs.

Erratic idle
(misfiring)

Intake system leaking.
Check vacuum hose connections to manifold and idle air control valve.

Worn spark plugs.
Remove. Clean or replace plugs if necessary.

Engine stall at irregular
intervals

Defective wires.
Check terminals at: fuel pump, coil, ignition switch and relays.

Intake system leaking.
Check vacuum hose connections at manifold and idle air control valve.

Fuel filter clogged.
Clean fuel tank filter and replace fuel line filter.

Misfiring at highway driving
speed

Spark plugs fouled.
Drive the vehicle in a lower gear and keep the engine rpm higher for a few miles in order to remove carbon deposits on the spark plugs. If this procedure is not effective, clean or replace the spark plugs. Please be aware that faulty plugs can damage the three-way catalytic converter.

Fuel filler flap does not open

Faulty motor in fuel filler flap

Remove the cover panel on the right tail light unit and pull on the hook. The filler flap can then be opened.

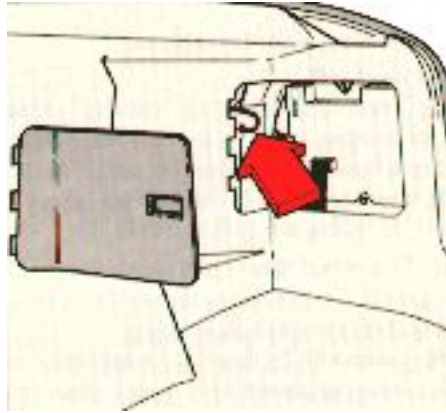

Emergency release for fuel filler flap

pg. 6:17 Service diagnosis (cont.)

Electrically operated sun roof cannot be closed

No current to sun roof motor

The overload circuit breaker (no. 37 in fuse box) has been activated.

Wait approx. 20 seconds for the circuit breaker to cool down.

Check fuse no. 28.

Faulty sun roof motor

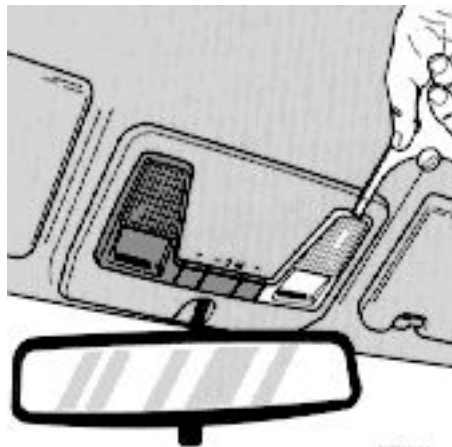

Remove the roof lamp glass lens with the sun roof combination tool (located in the glove compartment).

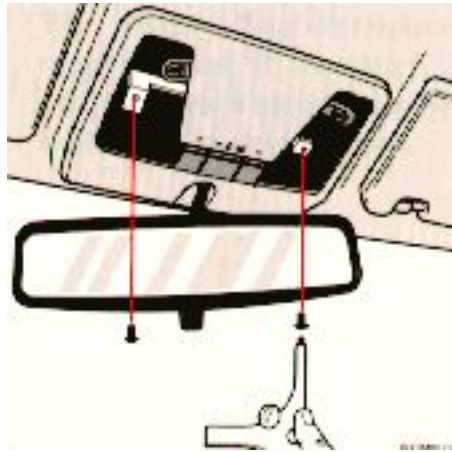

Loosen the two screws in the sun roof motor's cover panel and remove the panel.

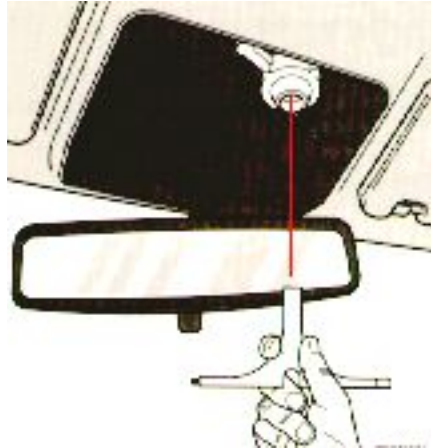

Press the combination tool into place and turn until the sun roof is closed.

pg. 6:18 Service diagnosis (cont.)



Shiftlock release (automatic transmission only)

The gear selector is locked in the (P)ark position. To manually release the shiftlock, turn the starting

(ignition) key to position I and press firmly on the "SHIFTLOCK OVERRIDE" button located to the right of the base of the gear selector. While holding the override button down, press the button on the front of the gear selector and move the selector from the (P)ark position.



[Contents](#) | [Top of Page](#)

Replacing bulbs

The method for replacing bulbs in the various lighting units is shown on the following pages. Make sure when installing bulbs, that the guide pin on the socket fits into its corresponding recess. When installing Halogen bulbs, do not touch the glass with your fingers because grease, oil or any other impurities can be carbonized onto the bulb and damage the reflector. Use bulbs of correct type and voltage. Failure to do so could cause the bulb failure warning light to activate.

Headlight adjustment

The height of the headlight beams can be adjusted according to vehicle load. The headlights should be re-aimed if heavy loads are carried in the trunk/rear seat or when towing a trailer.

To adjust the headlights:

- Park the car on a level surface and open the hood.
- The headlights are equipped with a level which can be seen by looking through the clear "window" on the top of the headlight lens.
- Turn the height adjustment knob (A) on the top of the headlight housing until the bubble in the level aligns with the "0" marks.

Lateral headlight adjustment should only be carried out by an authorized Volvo dealer. The lateral adjustment knob (B) should be preset at "0".

NOTE: If your car is equipped with the optional self-levelling rear suspension (NIVOMAT), headlight adjustment is NOT necessary to compensate for vehicle load/trailers.

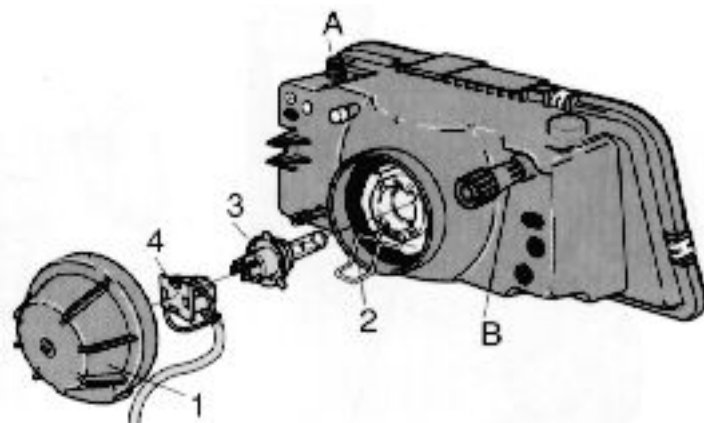

1. Plastic cover
2. Spring-loaded clip
3. Bulb HB2/9003
4. Ring connector

Headlight bulb replacement

1. Turn the plastic cover counter-clockwise and remove it.

2. Withdraw the connector. It may be very firmly seated.
3. Press the spring-loaded clip to release it and move it to the side.
4. Remove the bulb.
5. Insert the new bulb without touching the glass. The bulb has three guide lugs to ensure proper positioning.
6. Reinstall the unit in reverse order.

pg. 6:6 Replacing bulbs (cont.)

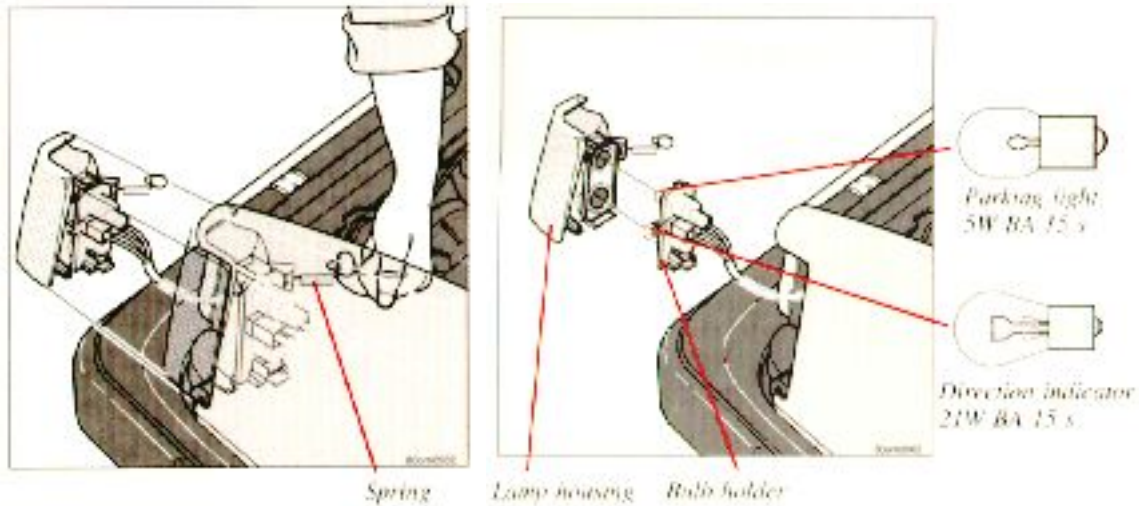

Parking light/direction indicator

1. Loosen the spring which retains the lamp housing.
2. Withdraw the entire lamp housing; separate the bulb holder from the lamp unit.
3. Leave the connector with its wires in the bulb holder.
4. Remove the bulb from the holder by pressing in and turning counter-clockwise.
5. Insert a new bulb and reinstall the unit in the reverse order.

NOTE: The direction indicators and parking lights are combined in one bulb on U.S. and Canadian models.

pg. 6:7 Replacing bulbs (cont.)

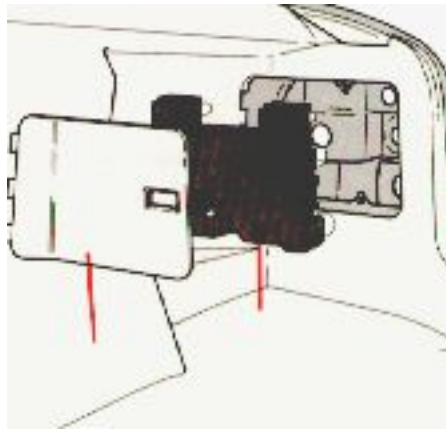

Lamp location, right side

Tail light bulbs

1. Tail light
2. Direction indicator
3. Brake light
4. Tail light
5. Back-up light
6. Rear fog light

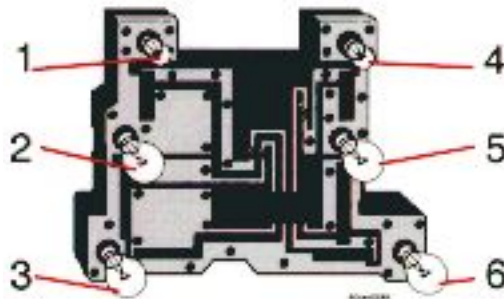

Location of bulbs in holder

All the bulbs in the tail light unit are replaced from inside the trunk as follows:

1. Press the plastic catch and remove the cover from the rear lamp unit. The cover is attached at the side.
2. Loosen and remove the bulb holder.
3. Let the connector with its wires remain attached to the bulb holder.
4. Remove the bulb by pressing in and turning counter-clockwise.
5. Insert a new bulb into the holder and reinstall the holder into the tail light assembly.
6. Close the cover.



Bulbs 1, 4:

5W BA 15 s

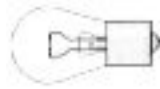

Bulbs 2, 3, 5, 6:
21W BA 15 s

pg. 6:8 Replacing bulbs (cont.)

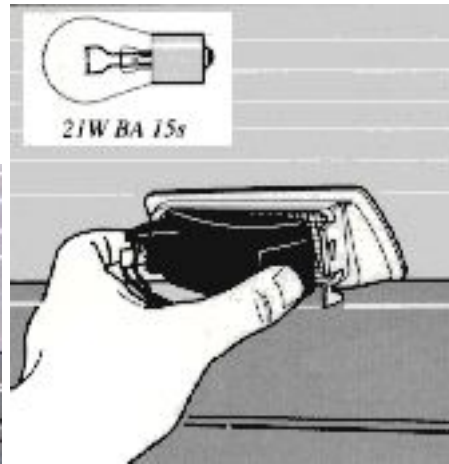
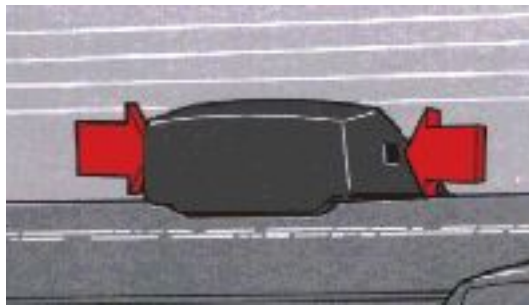

Depress the catches Press in the springs

High-mounted brake light

- Turn off the ignition.
- Press in the springs on both sides of the holder.
- Pull the cover towards you.
- Depress the catches on both sides of the reflector and withdraw it from the holder.
- Replace the bulb.
- Reinstall the reflector.
- Press the cover into place.

pg. 6:9 Replacing bulbs (cont.)

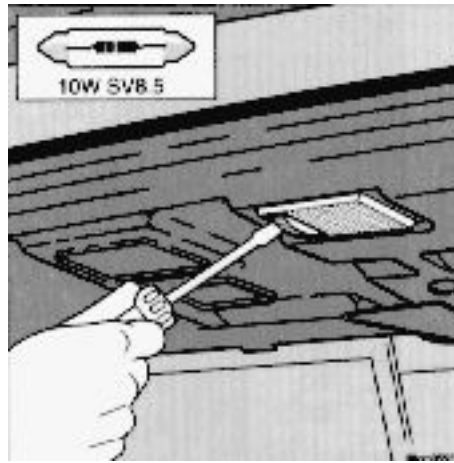

Insert screwdriver and turn

Trunk light

- Switch off the lights.
- Press in the catch with a screwdriver and remove the bulb holder.
- Replace the bulb and reinstall the bulb holder.

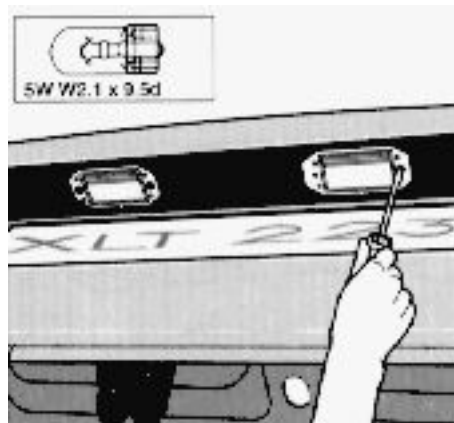

Phillips-head screwdriver for glass lens

License plate lights

- Switch off the lights.
- Unscrew the two screws.
- Insert the screwdriver and turn carefully to loosen the glass lens.
- Replace the bulb and press the glass lens back into place.

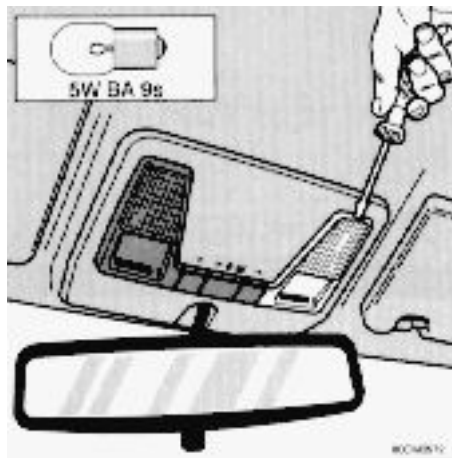

Insert screwdriver, turn and pull downward

Front courtesy lights

- Switch off the lights.
- Insert the screwdriver and turn carefully to loosen the glass lens.
- Replace the bulb and press the glass lens back into place.

pg. 6:10 Replacing bulbs (cont.)

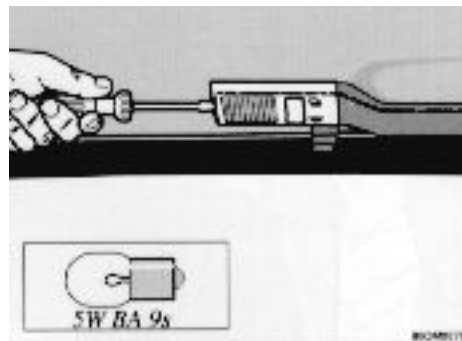

Insert a screwdriver and turn

Rear reading lights

- Switch off the lights.
- Insert a screwdriver and turn to loosen the lamp unit.
- Replace the bulb and press the lamp unit back into place.

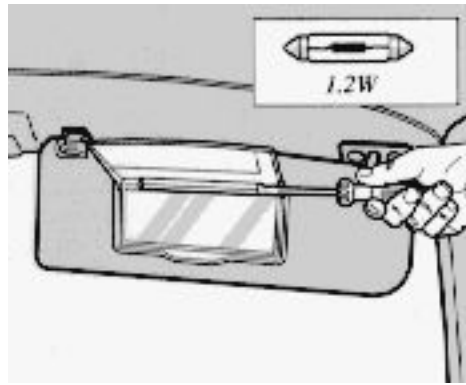

Insert a screwdriver and turn

Vanity mirror

- Insert a screwdriver under the lower edge and turn to loosen the glass lens.
- Push out the bulb and replace it.
- Press the lower edge of the lens into place above the four catches.
- Press the upper edge of the lens into place.

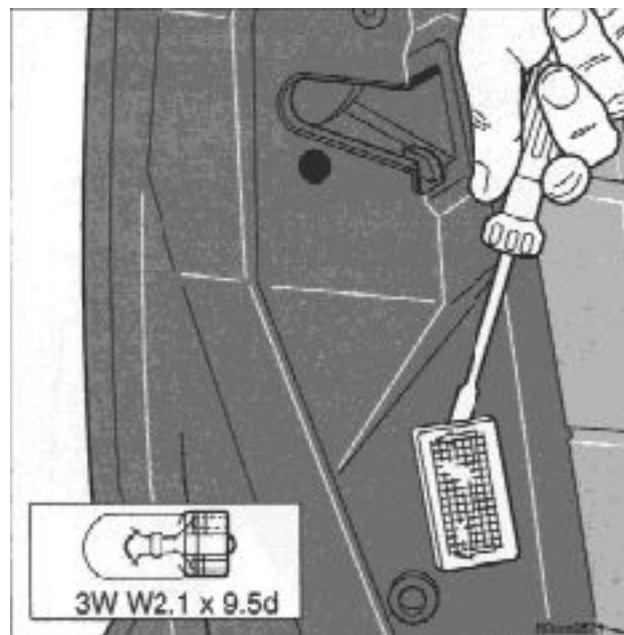

Insert a screwdriver and turn

Door warning lights

Front

- Slide the lamp unit upward and lift it out.
- Twist off the bulb holder.
- Pull the bulb straight out.
- Replace the bulb
- Reinstall the holder and lamp unit in reverse order.

Rear

- Insert a screwdriver and turn carefully to loosen the glass lens.
- Pull the bulb straight out.
- Replace the bulb.
- Press the lens back into place.

pg. 6:11 Replacing bulbs (cont.)

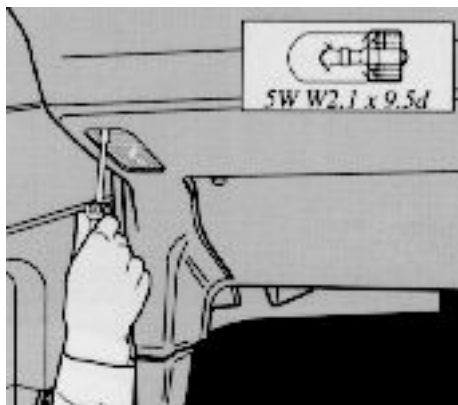

Insert a screwdriver and turn

Door step courtesy lights

- Insert a screwdriver and turn carefully to loosen the glass lens.
- Withdraw the lamp unit, bend back the tabs and remove the plate.
- Replace the bulb.
- Reinstall the plate.
- Press the lamp unit back into place.

NOTE: Other bulbs may be difficult for the owner to replace. Let your Volvo dealer replace these bulbs if necessary.



[Contents](#) | [Top of Page](#)

Car care

pg. 7:1 Car care

Car care

Car care includes not only maintaining the appearance of the car, but also protecting the car exterior from the effects of air pollution, rain and mud.

The rustproofing compound under the car should be checked regularly and, if necessary, damaged areas should be repaired. The paintwork should also be touched up immediately, if damaged, to prevent rust formation.

[7:2 Rustproofing](#)

[7:4 Paint touch-up](#)

[7:6 Washing](#)

[7:7 Automatic car washing, Polishing and waxing](#)

[7:8 Cleaning the upholstery](#)

pg. 7:2 Rustproofing

What causes rust

The two most common causes of rust to your car are:

- The accumulation of road dirt and moisture in hard-to-get-at cavities and other areas under the car.
- The removal of paint and protective coatings on the outside of the car and underneath through damage by stones, gravel or minor accidents.

Several factors influence the speed at which corrosion will occur:

- The length of time various parts of a car stay wet. Parts of the car filled with road dirt and water remain damp for long periods of time even after other parts have dried. Particular attention should be paid to the underside of the car and floor sections inside. The floor sections stay wet because moisture collects and remains under the floor matting. Drain holes located at the bottom of the doors can get clogged with dirt, trapping water inside the door and causing the door to rust at the bottom.
- Corrosion will be accelerated in areas of higher relative humidity, especially where temperatures often stay above the freezing point and where the atmosphere is affected by industrial pollution, or where salt is used for de-icing the roads. Where parts of the car are covered with road dirt containing road salt, corrosion will be accelerated at lower relative humidity than if the surface were clean.
- Increased temperature will cause an accelerated rate of corrosion of those parts of the car which are

not well ventilated to permit quick drying.

- Industrial pollution and the presence of salt will also accelerate the deterioration of paint finishes.

The foregoing identifies the need for every car owner to keep his or her car particularly the underside as clean and dry as possible and to repair any minor damage to paintwork and protective coating as soon as possible.

The need is more important in those areas where road salt is used for de-icing, the relative humidity is higher, air pollution is present, and temperatures regularly stay above freezing.

Rustproofing, inspection and touching-up

Your Volvo was carefully and thoroughly rustproofed at the factory. The underbody and wheelhousings were sprayed with a thick, durable rustproofing compound and the beams, internal cavities and end sections were sprayed with a low viscous, penetrating rustproofing agent.

There are two very effective methods of maintaining this protection:

- Keep your car clean. Clean the underbody, wheelhousings and the edges of the fenders using water at high pressure.
- Inspect and touch-up the rustproofing if necessary.

The invisible (internal) rustproofing

As part of your maintenance schedule, it is important that the invisible rustproofing (used for beams, internal cavities and end sections) be retreated first after 36 months and, thereafter, every 24 months. Bear in mind, if good results are to be obtained, that these sections must be treated with a fine spray of Volvo-approved rustproofing compound by your authorized Volvo dealer.

pg. 7:3 Rustproofing (cont.)

The visible rustproofing

The visible (external) rustproofing must be inspected by an authorized Volvo dealer at least once a year. If it is necessary to touch-up the rustproofing, this should be done immediately to prevent moisture penetration. Wash and dry thoroughly before touching up. Use spray-on or brush-on rustproofing compounds. An oil can with a long flexible spout may be used for parts which are difficult to reach.

There are three different types of rustproofing compounds available:

- A) thin (ML), for seams under the car.
- B) thin (transparent) for visible parts.
- C) thick, for parts on the underbody and wheel housing which experience most wear.

Parts of the car which may need to be touched up (and the recommended rustproofing compound) are:

- visible welded seams and panel seams-(thin)
- underbody and wheel housings-(thick)
- door hinges-(thin)
- hood hinges and locks-(thin)

After completion of all work on the vehicle, remove excess rustproofing compound with a cloth soaked in kerosene. The sheet metal surfaces of the engine compartment are protected by a transparent wax-based rustproofing compound. The compound withstands normal washings without deterioration. Mineral based solvents will, however, dissolve the compound, especially so if they contain emulsifiers. In such cases the wax protection should be renewed.

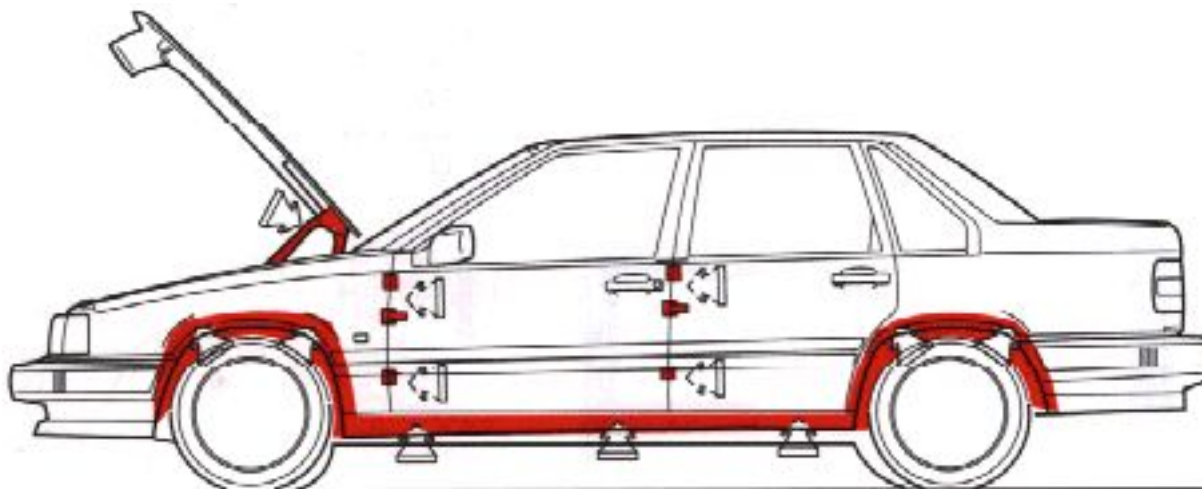

pg. 7:4 Paint touch-up

Paint touch-up

Paint damage requires immediate attention to avoid rusting. Make it a habit to check the finish regularly - when washing the car for instance. Touch up if necessary.

Paint repairs require special equipment and skill. Contact your Volvo dealer for any extensive damage. Minor scratches can be repaired by using Volvo touch-up paint.

NOTE: When ordering touch-up paint from your Volvo dealer, use the paint code indicated on the model plate. The plate is located on the panel above the right-side head lights.

VOLVO		
YV1453100000		10
1230	kg	1413
	kg	0
10830	kg	
2 150	kg	

Minor stone chips and scratches

Material:

Primer - can

Paint - spray can or touch-up bottle

Brush

Masking tape

NOTE: When touching up the car, it should be clean and dry. The surface temperature should be above 60° F (15° C).

Scars on the surface

If the stone chip has not penetrated down to the metal and undamaged layer of paint remains, the touch-up paint can be applied as soon as the spot has been cleaned.

Deep scars

1. Place a strip of masking tape over the damaged surface. Pull the tape off so that any loose flakes of paint adhere to it.

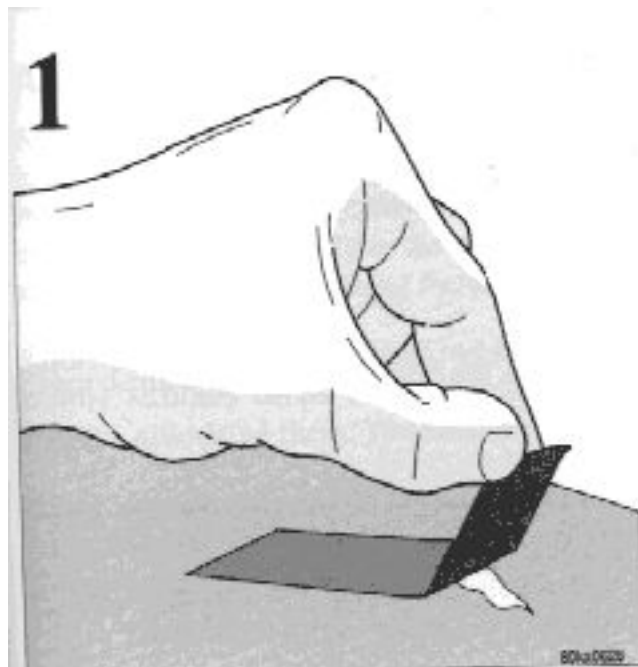

2. Thoroughly mix the primer and apply it with a small brush.

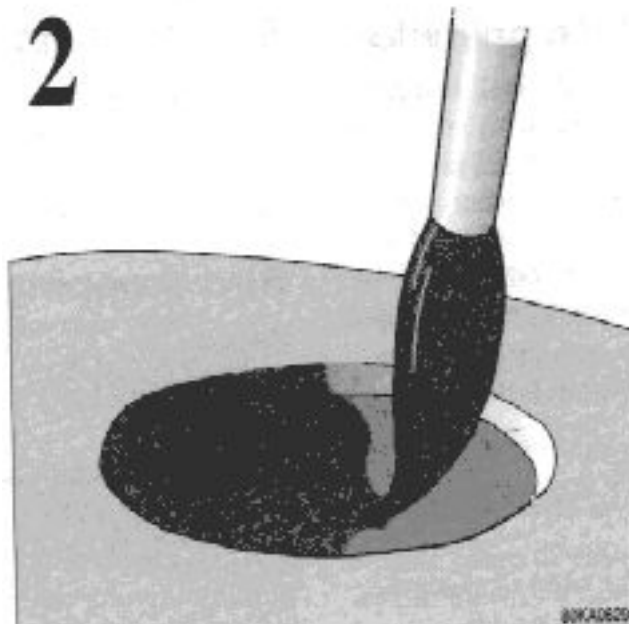

When the primer surface is dry, the paint can be applied using a brush. Mix the paint thoroughly; apply several thin paint coats and let dry after each application.

pg. 7:5 Paint touch-up (cont.)

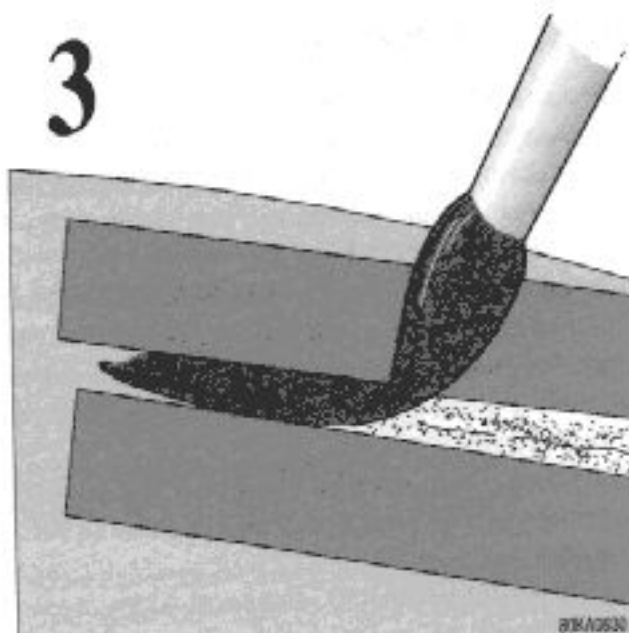

3 If there is a longer scratch, you may want to protect surrounding paint by masking it off.

Touching up damaged paint on fender edges and sills

Material:

Primer - spray can

Paint - spray can
Masking tape

Note: When touching up the car, it should be well cleaned and dry and have a temperature exceeding 60° F (+15°C).

When large surfaces have to be repainted, suitably mask the surrounding area with masking tape and paper.

Remove this masking as soon as the final coat has been sprayed on, before the paint dries.

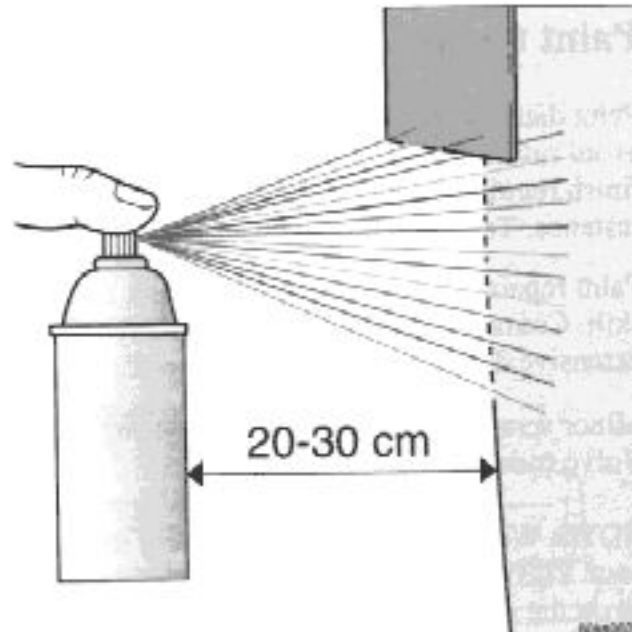

1. Remove loose flakes of paint with masking tape.
2. Move the spray can slowly and regularly from side to side, about 8-12 inches (20-30 cm) from the surface.

WARNING! Spray painting should be done in a well-ventilated and dust-free area.

3. When the primer has dried apply the surface enamel in the same way. Spray on several times and allow the paint to dry a minute or so between each application.

pg. 7:6 Washing

Washing the car

The car should be washed at regular intervals since dirt, dust, insects and tar spots adhere to the paint

and may cause damage.

When washing the car, do not expose it to direct sunlight. Use luke-warm water to soften the dirt before you wash with a sponge, and plenty of water, to avoid scratching.

A detergent can be used to facilitate the softening of dirt and oil.

A water-soluble grease solvent may be used in cases of sticky dirt. However, use a wash place equipped with a drainage separator.

Dry the car with a clean chamois and remember to clean the drain holes in the doors and rocker panels.

The power radio antenna must be dried after washing.

Tar spots can be removed with kerosene or tar remover after the car has been washed.

A stiff-bristle brush and lukewarm soapy water can be used to clean the wiper blades. Frequent cleaning improves visibility considerably.

NOTE: It is particularly important to wash the car frequently in the wintertime to prevent corrosion, when salt has been used on the roads.

Also wash off the dirt from the underside (wheel housings fenders, etc.).

In areas of high industrial fallout more frequent washing is also recommended.

NOTE: During high pressure washing the spray mouth piece must never be closer to the vehicle than 13" (30 cm). Do not spray into the locks.

When washing or steam cleaning the engine, avoid spraying water or steam directly on the electrical components or toward the rear side of the engine.

After cleaning the engine, the spark plug wells should be inspected for water and blown dry if necessary.

Suitable detergents

Special car washing detergents or household detergent can be used. A suitable mixture is about 2.5 fl. oz. (8.5 cl) of detergent to 2.6 US gal. (10 liters) of warm water. After washing with a detergent the car should be well rinsed with clean water.

Bird droppings

Remove from paintwork as soon as possible. Otherwise the finish may be permanently damaged.

WARNING! When the car is driven immediately after being washed, apply the brake several times in order to remove any moisture from the brake linings.

Engine cleaning agents should not be used when the engine is warm. This constitutes a fire risk.

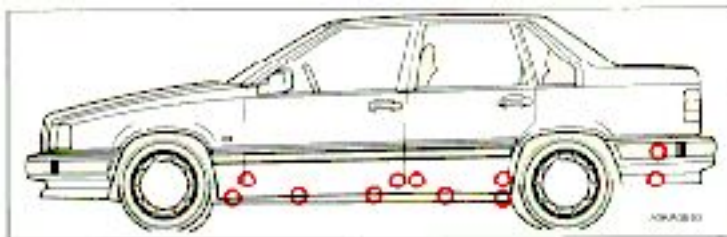

NOTE: When washing the car, remember to remove dirt from the drain holes in the doors and sills.

pg. 7:7 Automatic car washing, Polishing and waxing

Automatic washing - simple and quick

An automatic wash is a simple and quick way to clean your car, but it is worth remembering that it may not be as thorough as when you yourself go over the car with sponge and water. Keeping the underbody clean is most important, especially in the winter. Some automatic washers do not have facilities for washing the underbody.

Before driving into an automatic wash, make sure that the side view mirrors, auxiliary lamps, etc., are secure, otherwise there is risk of the machine dislodging them. You should also lower the antenna.

We recommend that you do not wash your car in an automatic wash during the first six months (because the paint will not have hardened sufficiently).

Polishing and waxing

Normally, polishing is not required during the first year after delivery, however, waxing may be beneficial.

Before applying polish or wax the car must be washed and dried. Tar spots can be removed with kerosene or tar remover. Difficult spots may require a fine rubbing compound.

After polishing use liquid or paste wax.

Several commercially available products contain both polish and wax.

Waxing alone does not substitute for polishing of a dull surface.

A wide range of polymer-based car waxes can be purchased today. The waxes are easy to use and produce a long-lasting, high-gloss finish that protects the bodywork against oxidation, road dirt and fading.

pg. 7:8 Cleaning the upholstery

Cleaning the upholstery

The fabric can be cleaned with soapy water or a detergent.

For more difficult spots caused by oil, ice cream, shoe polish, grease, etc., use a clothing/clothing fabric stain remover.

The plastic in the upholstery can be cleaned with a soft cloth and mild soap solution.

Leather upholstery can be cleaned with a soft cloth and mild soap solution.

For more difficult spots, consult your Volvo dealer.

On no account must gasoline, naphtha or similar cleaning agents be used on the plastic or the leather since these can cause damage.

Cleaning the seat belts

Clean only with lukewarm water and mild soap solution.

Cleaning floor mats

The floor mats should be vacuumed or brushed clean regularly, especially during winter when they should be taken out for drying. Spots on textile mats can be removed with a mild detergent.

Bear in mind

- Take extra care when removing stains such as ink or lipstick since the coloring can spread.
- Use solvents sparingly. Too much solvent can damage the seat padding.
- Start from the outside of the stain and work toward the center.



[Contents](#) | [Top of Page](#)

Service and routine maintenance

pg. 8:1 Volvo Service

Service - an investment

An investment which will pay dividends in the form of improved reliability, durability, and resale value.

[8:2](#) Label Information

[8:3](#) Maintenance service, Warranty

[8:4](#) Maintenance schedule

[8:6](#) Servicing

[8:9](#) Engine compartment

[8:10](#) Engine oil

[8:12](#) Power steering fluid, Brake/clutch system fluid reservoir

[8:13](#) Automatic transmission fluid

[8:14](#) Drive belt

[8:15](#) Windshield washer nozzle, Washer fluid reservoir

[8:16](#) Coolant

[8:17](#) Engine compartment

pg. 8:2 Label information

1 Vehicle Identification Number (VIN) *

The VIN plate is located on the top left surface of the dashboard. The VIN is also stamped on the right hand door pillar.

2 Vehicle Emission Control Information

Your Volvo is designed to meet all applicable emission standards, as evidenced by the certification label on the right side of the firewall. For further information regarding these regulations, please consult your Volvo dealer.

3 Model plate

Vehicle Identification Number (VIN). Codes for color and upholstery etc. This plate is located on panel above the right headlight.

4 Loads and Tire Pressures

5 Federal Motor Vehicle Safety Standards (FMVSS) specifications (USA) and Ministry of Transport (CMVSS) Standards (Canada)

Your Volvo is designed to meet all applicable safety standards, as evidenced by the certification label on

the facing side of the driver's door. For further information regarding these regulations, please consult your Volvo dealer.

* The Vehicle Identification Number (VIN) should always be quoted in all correspondence concerning your vehicle with the dealer and when ordering parts.

All specifications are subject to change without notice.

pg. 8:3 Maintenance service, Warranty

Maintenance service at 10,000 mile (16,000 km) intervals

Volvo advises you to follow the service program at 10,000 mile (16,000 km) intervals which is outlined in the "Maintenance Records Manual". This maintenance program contains inspections and services necessary for the proper function of your car over the next 10,000 miles (16,000 km).

The maintenance services contain several checks which require special instruments and tools and therefore must be performed by a qualified technician.

To keep your Volvo in top condition, specify time tested and proven Genuine Volvo Parts and Accessories.

The Federal Clean Air Act - U.S.

The Clean Air Act requires vehicle manufacturers to furnish written instructions to the ultimate purchaser to assure the proper functioning of those components that control emissions.

The maintenance instructions listed in the "Servicing" section of this Manual represent the minimum maintenance required. These services are not covered by the warranty. You will be required to pay for labor and material used. Refer to your Warranty booklet for further details.

Maintenance services

Your Volvo has passed several major inspections before being delivered to you, according to Volvo specifications. The maintenance services outlined in this book should be performed every 10,000 miles (16,000 km). The extended maintenance service intervals make it even more advisable to follow this program. Inspection and service should also be performed any time a malfunction is observed or suspected.

It is recommended that receipts for vehicle emission services be retained in the event that questions arise concerning maintenance. See your "Maintenance Records Manual".

Applicable warranties - U.S.

In accordance with U.S. Federal Regulations, the following list of applicable U.S. warranties is provided. For Canadian specification vehicles, see your separate warranty booklet.

- New Car Limited Warranty
- Parts and Accessories Limited Warranty
- Corrosion Protection Limited Warranty
- Seat belt and Supplemental Restraint Systems Limited Warranty
- Emission Design and Defect Warranty
- Emission Performance Warranty

These are the Federal warranties; other warranties are provided as required by state law. Refer to your separate Warranty booklet for detailed information concerning each of the warranties.

pg. 8:4 Servicing

Maintenance schedule

A = Adjust (Correct if necessary) I = Inspect (Correct or Replace if necessary)

R = Replace L = Lubricate

Maintenance Operation thousand miles (thousand km)	1.5 (2.4)	5 (8)	10 (16)	20 (32)	30 (48)	40 (64)	50 (80)	60 ² (96)
EMISSION SYSTEM MAINTENANCE								
Engine oil and oil filter ¹	I	R ₄	R	R	R	R	R	R
Engine drive belts ³					R			
Air cleaner filter					R			R
Spark plugs					R			R
Automatic transmission fluid	I		I	I	I	I	I	I
Timing belt - B 5254 S							R	

1) See section "Engine oil" for detailed information.

NOTE: The oil should be changed at these intervals or after 750 hours of driving or after 12 months which ever occurs first. See "Service Reminder indicator", page 1:5.

2) For services beyond 60,000 miles (96,000 km), consult your "Maintenance Records booklet".

3) Every 30,000 miles (48,000 km): lubricate belt tensioner pulley

4) No cost to owner.

pg. 8:5 Servicing (cont.)

Maintenance Operation thousand miles (thousand km)	1.5 (2.4)	10 (16)	20 (32)	30 (48)	40 (64)	50 (80)	60 (96)
MISCELLANEOUS MAINTENANCE							
ENGINE							
Fuel line filter							R
PCV Nipple (orifice)/hoses,clean							I
Battery charge		I	I	I	I	I	I
EGR valve, clean							I
BRAKES							
Inspect brakes, replace components as necessary		I	I	I	I	I	I
Brake Fluid	I ¹			R			R
STEERING/SUSPENSION							
Tire wear (align front end if needed)		I	I	I	I	I	I
Check power steering level	I ¹	I	I	I	I	I	I
Suspension bolts/nuts (check torque)	I ¹						I
BODY							
Power antenna (clean)		I	I	I	I	I	I
Trunk/hood, hinges and latches		L	L	L	L	L	L

1) No cost to owner

The following items should be checked weekly by the driver (it takes only a few minutes).

Engine oil level Operation of all lights

Brake fluid level Horns

Radiator coolant level Windshield wipers

Tire pressure (all five tires) Level of windshield washer fluid

The following should also be carried out at regular intervals:

Washing

Polishing

Cleaning

Rust protection



[Contents](#) | [Top of Page](#)

pg. 8:12 Power steering fluid, Brake/clutch fluid reservoir

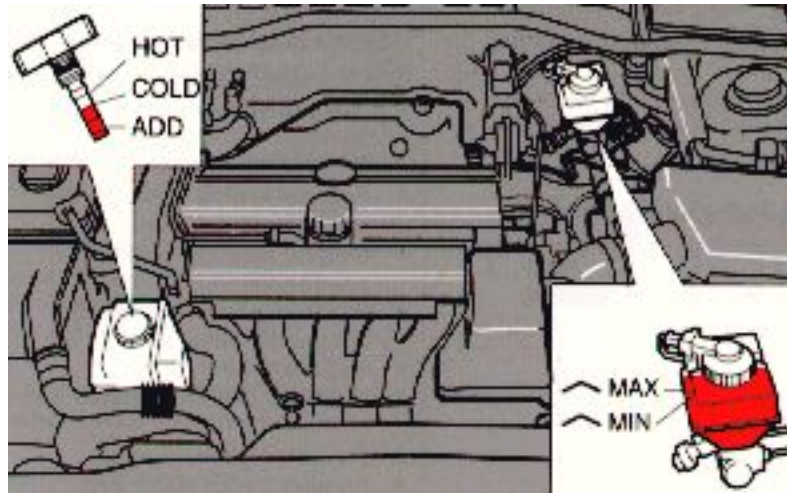

Power steering fluid

The dipstick has marks for checking hot and cold oil. The oil level when the engine is cold must never be higher than the COLD mark. After the engine has reached normal operating temperature, the level may not be higher than the HOT mark. Top up when the level is at the ADD mark. Check the level at every service.

Fluid type: ATF

Replace: no fluid change required.

Brake and clutch systems

The brake and clutch systems share the same fluid reservoir. The fluid level should be between the MIN and MAX marks.

Fluid type: DOT 4+

Replace: Every second year or 30,000 miles (48,000 km). The fluid should be replaced once a year or every 15,000 miles (25,000 km) when driving under extremely hard conditions (mountain driving, etc.).

Check, without removing the cap, that the level is above the "MIN" mark of the fluid reservoir. Always entrust brake/clutch fluid changing to an authorized Volvo dealer.

pg. 8:13 Automatic transmission fluid

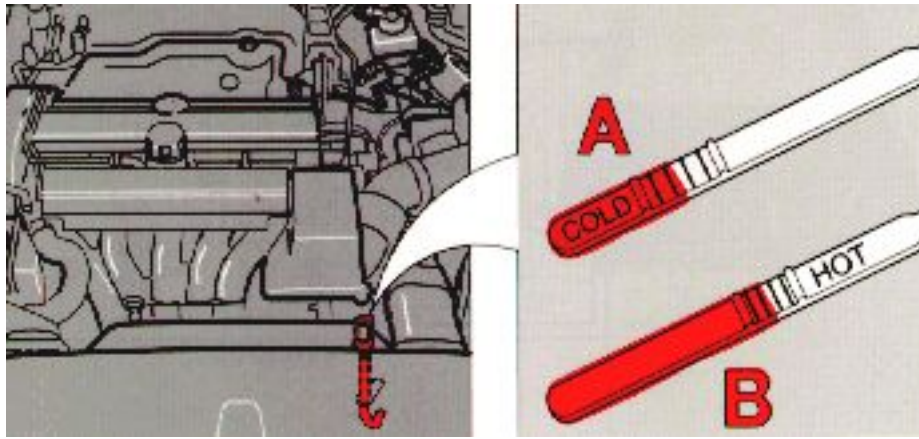

Check the oil level as follows:

Park the car on a level surface with the engine idling . Slowly move the gear selector lever through all the shift positions and then to position P. Wait 3 minutes before checking the oil level.

As the illustration shows, the dipstick has a COLD and a HOT side. The oil level should be between the MIN and MAX marks. Wipe the dipstick with a clean cloth.

WARNING! The oil may be very hot.

Do not use rags that could leave lint on the dipstick. The transmission is topped up via the dipstick tube. The space between the MIN and MAX marks on the dipstick corresponds to 0.5 US qt. (0.5 liter). Do not fill the transmission with too much oil, since this can result in oil being ejected from the transmission. Too little oil, on the other hand, can negatively affect transmission operation, particularly in very cold weather.

A Cold transmission: oil temperature 105° F (40° C). This is a normal temperature for the transmission after idling for about 10 minutes. At oil temperatures below 105° F (40° C), the level may be below the MIN mark.

B Warm transmission: oil temperature 169° F (80° C). This temperature after driving for about 30 minutes. At oil temperatures above 190° F (90° C), the level may be above the MAX mark.

Fluid type: ATF Dexron IIE or Mercon.

WARNING! Oil spilled on a hot exhaust pipe constitutes a fire risk.

pg. 8:14 Drive belt

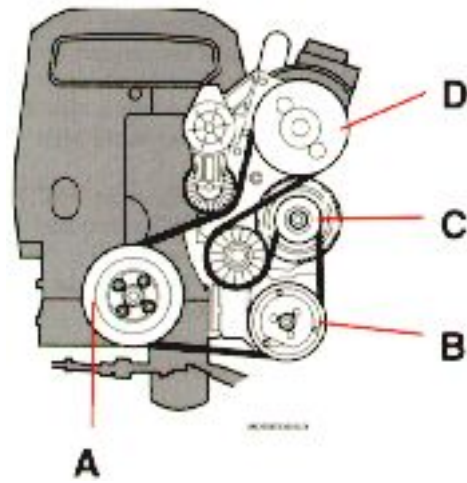

*A - crankshaft, B - A/C compressor,
C - generator, D - power steering pump*

Belt check

Check the belt regularly to make sure it is in good condition and is clean. A worn or dirty belt can cause poor cooling and low generator output as well as impair the operation of the power steering and the air conditioning unit.

NOTE : The belt on the 850 is equipped with a self-tensioning mechanism and requires no adjustment between changes.

WARNING! The engine must not be running when this check is performed.

pg. 8:15 Windshield washer nozzles, Washer fluid reservoir



Adjusting washer nozzles

The washer jets should spray the windshield as shown above. Use the edge of a small screwdriver to adjust the nozzles if necessary.

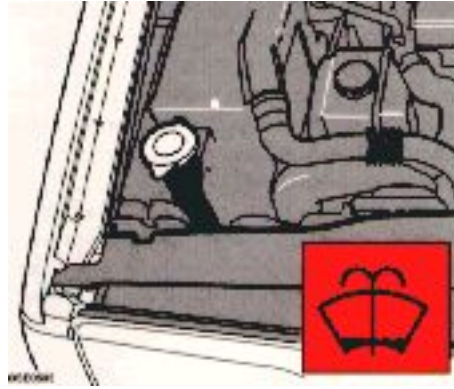

Washer fluid reservoir

The washer fluid reservoir is located in the engine compartment and holds approx. 3.2 US qts. (3.0 liters).

During cold weather, the reservoir should be filled with windshield washer solvent containing anti-freeze.

pg. 8:16 Coolant

Check coolant level

The cooling system must be filled with coolant and not leak to operate at maximum efficiency. Check the coolant level regularly. The level should be between the "MAX" and "MIN" marks on the expansion tank. The check should be made with particular thoroughness when the engine is new or when the cooling system has been drained.

Do not remove the filler cap other than for topping up with coolant. Frequent removal may prevent coolant circulation between the engine and the expansion tank during engine warm up and cooling.

Changing coolant

Normally, the coolant does not need to be changed. If the system must be drained, use the following procedure:

- 1 Remove the expansion tank cap.
- 2 Move the temperature adjustment control to max. heat. Open the drain cocks at the rear left of the engine block and at the bottom right corner of the radiator.
- 3 Disconnect the lower right radiator hose.

Filling:

- 4 Close the drain cocks and reconnect the hose.
- 5 Fill the expansion tank to the MAX mark or slightly above.
- 6 Run the engine until hot. Check the cooling system connections for tightness. Recheck the coolant level.

Capacity: Approx. 1.9 US gals (7.2 liters)

Coolant: Volvo Genuine Coolant/Antifreeze only

NOTE: Do not top up with water only. Water by itself reduces the rust-protective and anti-freeze qualities of the coolant and has a lower boiling point. It can also cause damage to the cooling system if it should freeze.

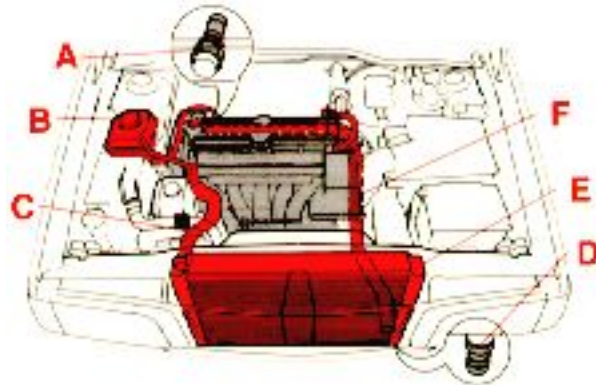

*A- drain cock, B- expansion tank, C- hose,
D- drain cock, E- radiator, F- lower hose*

WARNING: If the engine is warm and you are going to top up coolant, unscrew the cap slowly in order to allow any excess pressure to escape.

CAUTION: The cooling system must always be kept filled to correct level. If it is not kept filled, there can be high local temperatures in the engine which could result in damage.
Different types of anti-freeze/coolant may not be mixed.

pg. 8:17 Lubrication

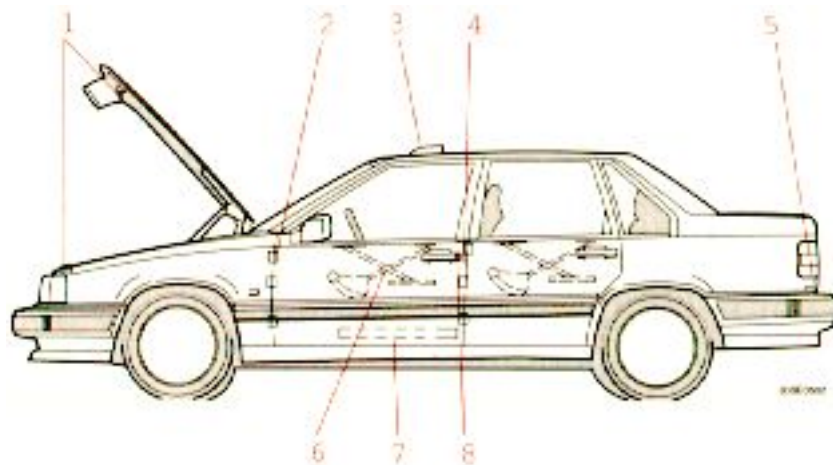

No.	Lubrication point	lubricant	No.	Lubrication point	lubricant
1	Hood lock and latch	Oil	5	Trunk lid lock	Low temperature grease
2	Door stop and hinges	Oil	6	Window winder (on inside of door)	Oil, grease, low temperature grease
3	Sun roof wind deflector	Oil	7	Front seat side rail and latch	Oil
4	Door lock catch plate	Oil	8	Door locks	Low temperature grease or Volvo teflon lock oil

To avoid rattles and unnecessary wear, the body should be lubricated a few times per year. This should be done by an authorized Volvo dealer.



[Contents](#) | [Top of Page](#)

The following precautions must be observed when carrying out repairs to the vehicle

WARNING! The distributor ignition system operates at very high voltages. Special safety precautions must be followed to prevent injury. Always turn the ignition off when:

- Connecting engine test and diagnostic equipment to the vehicle (timing light, tach-dwell tester, ignition oscilloscope, etc.).
- Replacing distributor ignition components e.g. plugs, coil, etc.
- Do not touch any part of the distributor ignition system while the engine is running. This may result in unintended movements and body injury.

Battery

- Check that the battery cables are correctly connected and properly tightened.
- Never disconnect the battery when the engine is running, for example when changing the battery.
- The battery should be disconnected when a boost charger is used.
- Switch off the radio before disconnecting the battery. If your radio has an anti-theft code and the battery is disconnected, the radio code has to be re-entered in order for the radio to function.

Replacing spark plugs

The spark plugs should be changed every 30,000 miles (48,000 km). However, city driving or fast highway driving may necessitate changing after 15,000 miles (24,000 km) of driving. When installing new plugs, be sure to fit the right type and use correct torque, see "Specifications". When changing the plugs, check that the suppressor connectors are in good condition. Cracked or damaged connectors should be replaced. When changing the spark plugs, clean the terminals and the rubber seals.

Hoisting the car

If a garage jack is used to lift the car, the two jack attachments points should be used. They are specially reinforced to bear the weight of the car. A garage jack can also be placed under the front of the engine support frame and under the reinforced plate in the spare wheel well. Take care not to damage the splash guard under the engine. Ensure that the jack is positioned so that the car cannot slide off it. Always use axle stands or similar structures.

If a two-post hoist is used to lift the car, the front and rear lift arms should be positioned under the reinforced lift plates on the bottom rail. The position of these plates is marked with arrows on the side of the bottom rail, see illustration below.

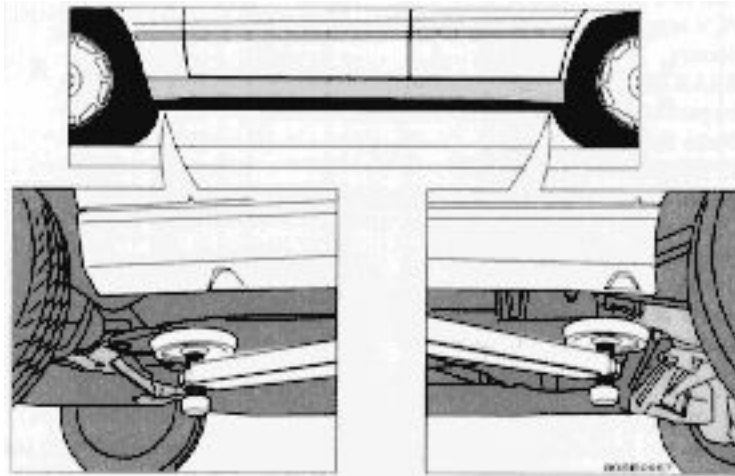

pg. 8:7 Servicing (cont.)

Torque exhaust and intake manifold nuts

A loose manifold could alter air/fuel ratio and cause an increase in emission and/or poor driveability.

Air cleaner

Replace the air cleaner cartridge with a new one every 30,000 miles (48,000 km). The cartridge should be replaced more often when driving under dirty and dusty conditions. The filter cannot be cleaned and therefore should always be replaced with a new one.

Vacuum fittings, hoses and connections

Unstable idle, misfiring, or poor emission control is often caused by leaking vacuum hoses or connections. Check hoses and connections on the distributor vacuum unit, connections on heater control servo systems and hydraulic brake servo.

Checking and adjusting idle air control system

Your Volvo is equipped with an electronically controlled idle air control system that requires no checking or adjustment.

Fuel system cap, tank and lines, and connections

The effectiveness of the fuel system to contain hydrocarbons is dependent largely on a leak-free system. Check for proper sealing of the gasoline filler cap which contains "O" ring type seals.

Fuel (line) filter

The fuel line filter is located next to the fuel pump. This filter is to be changed every 60,000 miles (96,000 km). The filter is replaced as one complete unit.

Replace more frequently if contaminated fuel is introduced into the tank (or if there is reason to suspect that this has occurred).

Timing gear belt

Volvo recommends that the timing gear belt be replaced at 50,000 miles (80,000 km) intervals. The first replacement is at 50,000 miles (80,000 km).

Exhaust Gas Recirculation (EGR)

This system operates by returning some of the exhaust gases to the engine to be recombusted since this lowers the combustion temperature and the amount of nitrogen oxides released into the atmosphere is reduced.

The EGR valve should be inspected at 60,000 miles (96,000 km) and thereafter cleaned every 20,000 miles (32,000 km).

pg. 8:8 Servicing (cont.)

Fuel System

The fuel system is all-electronic and is microprocessor-controlled. It can continually compensate for variation in engine load, speed and temperature to give the best economy and power. A mass air sensor or a pressure meter on certain models, measures the inducted air. In this way the system can make instantaneous adjustments for changes in air temperature or density, thus always assuring the best economy with the lowest possible exhaust emissions.

Heated oxygen sensor

This is an emission control system designed to reduce emissions and improve fuel economy. The heated oxygen sensor monitors the composition of the exhaust gases leaving the engine. The exhaust gas analysis is fed into an electronic module. This adjusts the air-fuel ratio to provide optimum conditions for combustion and efficient reduction of the three major pollutants (hydrocarbons, carbon monoxide and nitrous gases) by a three-way catalytic converter.

Pulsed Secondary Air Injection (certain models)

This system adds air to the hot exhaust gases as they are expelled from the engine. This causes a

secondary combustion of residual hydrocarbons and carbon monoxide, resulting in lower emissions levels in the exhaust gases.

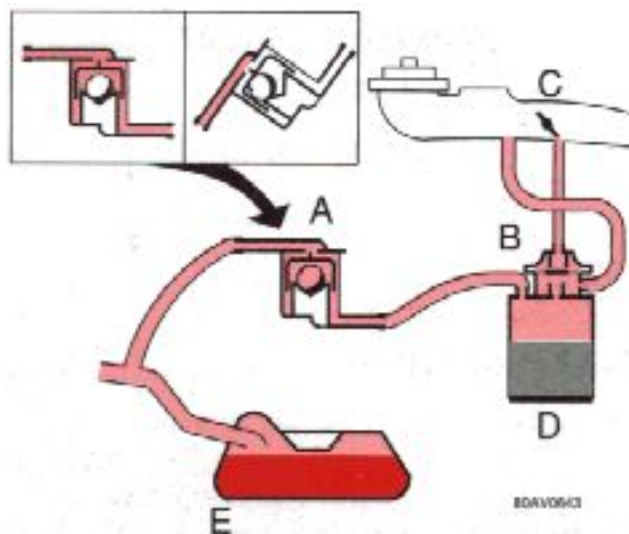

A- roll over valve, B- vacuum valve, C- inlet manifold, D- charcoal canister, E- fuel tank

Evaporative control system

The car is equipped with a gas evaporative control system, which prevents gasoline fumes from being released into the atmosphere. The system is comprised of an expansion chamber in the fuel tank, a roll-over valve on the cross member in front of the fuel tank and a charcoal canister with a built-in vacuum valve under the left-front wheel housing.

The components are interconnected by hoses which channel fuel vapor from the gas tank to the charcoal filter, where it is stored until the engine is started and then drawn into the engine's air intake system.

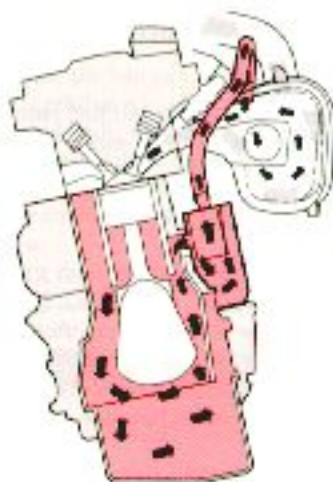

Crankcase ventilation

The engine is provided with positive crankcase ventilation which prevents crankcase gases from being

released into the atmosphere. Instead, the crankcase gases are admitted to the intake manifold and cylinders.

PCV system

The orifice nipple in the intake manifold and the filter at the end of the PCV hose in the air cleaner should be inspected every 60,000 miles (96,000 km).

Check/replace rubber hoses at the same time.

pg. 8:9 Engine compartment

Engine compartment 850 (engine B 5254 S)

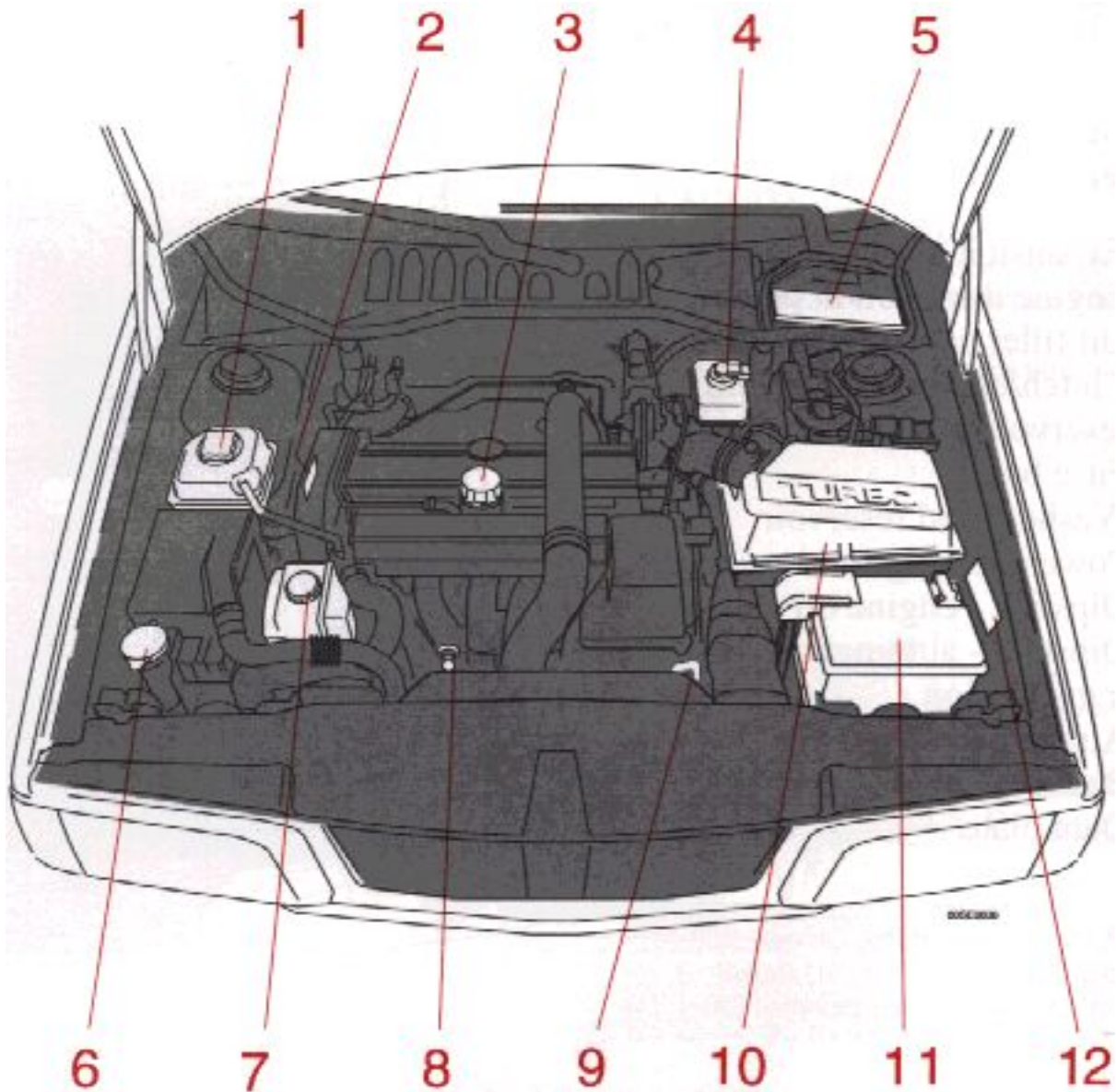

1 Expansion tank, coolant

- 2 Engine designation plate
- 3 Oil filler cap, engine
- 4 Clutch/brake system fluid reservoir
- 5 Fuse box
- 6 Washer fluid reservoir
- 7 Power steering fluid reservoir
- 8 Dipstick - engine oil
- 9 Dipstick - automatic transmission
- 10 Air cleaner
- 11 Battery
- 12 Data plate

WARNING! The cooling fan may start or continue to operate (for up to 6 minutes) after the engine has been switched off.

pg. 8:10 Engine oil

Checking the oil level

The oil level should be checked every time the car is refuelled. This is especially important during the engine break-in period (up to the first service).

CAUTION : Not checking the oil level regularly can result in serious engine damage if the oil becomes too low.

Park the car on a level surface and wait for at least 3 minutes after the engine has been switched off. Be sure the oil level is maintained between the upper and lower marks on the dipstick. Low oil level can cause internal damage to the engine and over-filling can result in high oil consumption. The distance between the dipstick marks represents approx. 1 US qts (1 liter). The oil should preferably be checked when the oil is cold, before the engine has been started. If the oil is at the MIN mark, fill as follows:
Cold engine: 1 US qt (1 liter)
Warm engine: 0.5 US qt (0.5 liter)

Approx. 1 US qt (1 liter)



NOTE: The engine must be stopped when checking the oil.

Draining the oil

Drain the oil after driving while it is still warm.

WARNING! The oil may be very hot.

If you change the engine oil and filter yourself, your Volvo Dealer can assist you in disposing of the used oil. Engine oil can be harmful to your skin - gloves should worn when performing this work.

To add or change oil

Add oil of the same kind as already used. Capacity (including filter): 5.6 US qts (5.3 liters). The oil filter should be replaced at every oil change

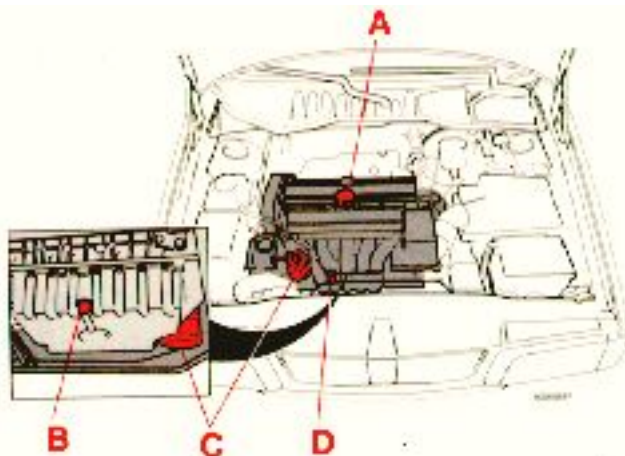

A - oil filler cap, B - drain screw, C - oil filter, D - Oil dipstick

WARNING! Oil spilled on a hot exhaust pipe constitutes a fire risk.

pg. 8:11 Engine oil (cont.)

Oil quality

Meeting API specification SG

For best fuel economy and engine protection, consult with your authorized Volvo dealer for recommended oils. Oil with designation SG/CD complies with this requirement. Oil with a different quality rating may not provide adequate engine protection.

Viscosity (stable ambient temperatures):

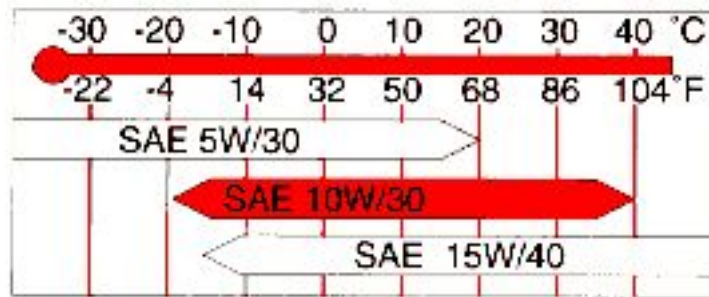

Do not use oils with other viscosity ratings. The use of incorrect viscosity oil can shorten engine life. Volvo recommends the use of energy-conserving oils. Look for the API label. Synthetic oils complying with oil quality requirements are recommended for driving in areas of sustained temperature extremes (hot or cold), when towing a trailer over long distances or for a prolonged driving in mountainous areas. Volvo does not recommend additional oil additives, as they can adversely affect the engine. SAE 15W/40 is recommended for use in driving conditions that raise oil temperature and increase oil consumption (i.e., mountain driving; trailer towing).

NOTE: SAE 15W-40 must not be used at low ambient temperatures; see viscosity chart.

Changing oil and oil filter

Oil and oil filter changes should be made as specified in the following table:

If driving conditions include:	Then the correct oil/oil filter change interval is:
<ul style="list-style-type: none"> Extended period of idling and/or low speed operation Frequent short trips (less than 7 miles = 11 km) Extended periods of driving in dusty and/or sandy areas Trailer towing Driving in mountainous areas 	<p>EVERY 6 MONTHS OR EVERY 5,000 miles= 8,000 KM WHICHEVER COMES FIRST</p>
<ul style="list-style-type: none"> Primarily highway driving Frequent trips of longer than 7 miles = 11 km Normal driving 	<p>EVERY 12 MONTHS OR EVERY 10,000 miles = 16,000 KM WHICHEVER COMES FIRST</p>



Volvo recommends the use of oils with the American Petroleum Institute (API) label. This label certifies the oil conforms to the applicable standards and specifications of the API.



[Contents](#) | [Top of Page](#)

Specifications

pg. 9:1 Specifications

Specifications

This chapter contains facts and figures pertaining to the technical specifications of your car.

[9:2 Oil/Fluids specifications](#)

[9:3 Engine specifications](#)

[9:4 Cooling/fuel distributor ignition systems](#)

[9:4 Front/rear suspensions](#)

[9:5 Transmission, Capacities, Vehicle loading](#)

[9:6 Electrical system/bulbs](#)

[9:7 Dimensions and weights](#)

[9:8 Service manuals, Road assistance](#)

[9:9 Customer support](#)

pg. 9:2 Oil/Fluids Specifications

Oil quality

Meeting API specification SG

For best fuel economy and engine protection, consult with your authorized Volvo dealer for recommended oils. Oil with designation SG/CD complies with this requirement. Oil with a different quality rating may not provide adequate engine protection.

Volvo recommends the use of energy-conserving fuels. Look for the API label.

Synthetic oils complying with oil quality requirements are recommended for driving in areas of sustained temperature extremes (hot or cold), when towing a trailer over long distances or for prolonged driving in mountainous areas.

Volvo does not recommend additional oil additives, as they can adversely affect the engine.

Viscosity (stable ambient temperatures):

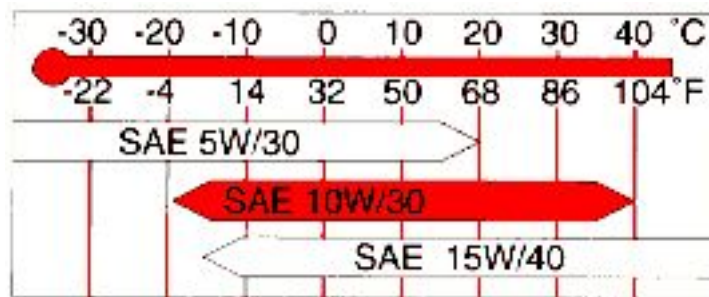

Capacity (including filter):

850 (5-cyl. engine) 5.6 US qts (5.3 liters)

Automatic transmission fluid	Quality: ATF Dexron IIE or Mercon	Capacity: 8 US qts. (7.6 liters)
Manual transmission fluid	Quality: Volvo synthetic gearbox oil 97308 or ATF type F/G	Capacity: 1.8 US qts (2.1 liters)
Power steering fluid	Quality: ATF	Capacity: 0.7 US qts. (0.8 liters)
Brake fluid	Quality: DOT 4+	Capacity: 0.5 US qts. (0.6 liters)

All specifications are subject to change without notice.

pg. 9:3 Engine

Engine

Liquid-cooled gasoline, 5-cylinder, in-line engine. Aluminum alloy cylinder block with cast-iron cylinder liners cast directly into the block. Aluminum alloy cylinder head with double overhead camshafts and separate intake and outlet channels.

Engine lubrication is provided by an eccentric pump driven from the crankshaft. Full-flow type oil filter. Exhaust emission control accomplished by multiport fuel injection, heated oxygen sensor and three-way catalytic converter

Type designation Volvo B 5254 S 5 cyl.

Output 168 hp at 6300 rpm (125 kw/103 rps)

Max torque 162.3 ft. lbs. at 3300 rpm (220 Nm/55 rps)

Number of cylinders 5

Bore 3.27" (83 mm)

Stroke 3.54" (90 mm)

Displacement 2.5 liters
Compression ratio 10.5:1
Valve clearance Self-adjusting

All specifications are subject to change without notice.

pg. 9:4 Specifications

Cooling system

Type: Positive pressure, closed system
Thermostat begins to open at 186° F (90° C)
Coolant: Volvo original coolant/anti-freeze
Capacity: 7.6 US qts. (7.2 liters)

Fuel system

The engine is equipped with a multiport fuel injection system (type LH-Jetronic 3.2)

Distributor ignition system

Firing order 1-2-4-5-3
Distributor ignition setting 10° B.T.D.C. at 800 rpm
Spark plugs Bosch FR 6 DC (or equivalent)
Spark plug gap 0.028" (0.7 mm)
Tightening torque 18.4 ft. lbs. \pm 3.7 ft. lbs. (25 Nm \pm 5 Nm)

Front suspension

Spring strut suspension with integrated shock absorbers and control arms linked to the support frame.
Power-assisted rack and pinion steering. Safety type steering column.
The alignment specifications apply to an unladen car but include fuel, coolant, and spare wheel.
Toe-in measured on the wheel rims: 2.4 mm \pm 0.7 mm
Toe-in measured on tire sides: 2.9 \pm 0.9 mm

Rear Suspension

Delta-link individual rear wheel suspension with longitudinal support arms, double link arms and track rods.
Toe-in measured on the tire sides: 0° \pm 8'.

All specifications are subject to change without notice.

pg. 9:5 Specifications (cont.)

Power transmission

Manual transmission: M56L

Single-disc dry plate clutch. All-synchromesh on all gears including reverse; integrated final drive.

Operation via a floor mounted gear lever. Overdrive.

Final drive ratio 3.77:1

Reduction ratios

1st gear 3.38:1

2nd gear 1.90:1

3rd gear 1.19:1

4th gear 0.87:1

5th gear 0.70:1

Reverse 3.30:1

Automatic transmission: AW 50-42 LE

4-speed automatic electronically controlled gearbox comprising a hydraulic torque converter with a lock-up function; planetary gear, integrated final drive.

Operation via a floor mounted gear selector lever. Drive shafts with symmetrical joint location.

Final drive ratio 2.74:1

Reduction ratios

1st gear 3.61:1

2nd gear 2.06:1

3rd gear 1.37:1

4th gear 0.98:1

Reverse 3.95:1

Capacities

Fuel tank 19.3 US gals (73 liters)

Cooling system 1.9 US gals (7.2 liters)

Engine oil (incl. filter) 5.6 US qts. (5.3 liters)*

Automatic transmission 2 US gals (7.6 liters)

Manual transmission 2.2 US qts. (2.1 liters)

Power steering fluid 0.8 US qts. (0.8 liter)

Washer fluid reservoir 3.2 US qts. (3.0 liters)

Brake/clutch system 0.6 US qts (0.6 liters)

Vehicle Loading

The tires on your Volvo should perform to specifications at all normal loads when inflated as recommended on the tire information label. The label is located on the inside of the fuel filler flap. The label lists both tire and vehicle design limits. Do not load your car beyond the load limits indicated.

WARNING! Improperly inflated tires will reduce tire life, adversely affect vehicle handling and can possibly lead to failure resulting in loss of vehicle control prior warning.

All specifications are subject to change without notice.

pg. 9:6 Specifications (cont.)

Electrical system

12 Volt, negative ground.

Voltage-controlled generator. Single-wire system with chassis and engine used as conductors.

Battery

Voltage 12 V

Capacity 520 A/100 min

(certain markets) 440 A/85 min

The battery contains corrosive and poisonous acids. It is of the utmost importance that old batteries are disposed of correctly. Your Volvo dealer can assist you in this matter.

Generator

Rated output 1400 W

Max. current 100 A

Bulbs

Bulb	Power	Socket	No. of bulbs
Headlights	60/55 W	—	2

Front parking lights/turn signals	5 W	BA 15s	1
Turn signals, rear	21 W	BA 15s	2
Tail lights	5 W	BA 15s	4
Brake lights	21 W	BA 15s	2
Back-up lights	21 W	BA 15s	2
Rear fog light	21 W	BA 15s	1
License plate light	5 W	W 2.1x9.5d	2
Door open warning light	3 W	W 2.1x9.5d	4
Door step courtesy light	5 W	W 2.1x9.5d	2
Front courtesy lights	5 W	BA 9s	2
Rear reading lights	5 W	BA 9s	2
Trunk light	10 W	SV 8.5	1
Glove compartment light	2 W	BA 9s	1
Vanity mirror lights	1.2 W		2
Instrument lighting	3 W	W 2.1x9.5d	3
Illumination, control panel	1.2 W	W 2x4.6 d	—
gear selector (automatic trans.)	1.2 W	W 2x4.6 d	1
rear ashtray	1.2 W	W 2x4.6 d	1
seat belt lock	1.2 W	W 2x4.6 d	1
Instrument warning/indicator lights	1.2 W	W 2x4.6 d	—



[Contents](#) | [Top of Page](#)

pg. 9:7 Specifications (cont.)

Dimensions and weights

Length 183.4 in. (466 cm)

Width 69.3 in. (176 cm)

Height 55.9 in. (142 cm)

Wheelbase 104.7 in. (266 cm)

Track, front 59.8 in. (152 cm)

Track, rear 57.9 in. (147 cm)

Turning circle (between curbs) 33.5 ft. (10.2 m)

Trunk capacity 14.7 cu. ft. (0.44 m³) Canada only

Gross Vehicle Weight (GVW) 4140 lbs (1878 kg) 1880 kg

Curb weight 3105-3207 lbs (1410-1455 kg) 1410-1455 kg

Capacity weight * 930 lbs (422 kg) 425 kg

Permissible axle weight, front 2240 lbs (1016 kg) 1020 kg

Permissible axle weight, rear 1960 lbs (889 kg) 890 kg

Max. roof load 220 lbs (100 kg)

Max. trailer weight with brakes (2" ball) 3520 lbs (1600 kg)

Max. trailer weight with brakes (1 7/8" ball) 2000 lbs (900 kg)

Max. trailer weight without brakes 1540 lbs (700 kg)

Max. trailer tongue weight ** 165 lbs (75 kg)

* The max permissible axle loads must not be exceeded.

** See also section "Trailer towing".

WARNING! When adding accessories, equipment, luggage and other cargo to your vehicle, the total loaded weight capacity of the vehicle must not be exceeded.

All specifications are subject to change without notice.

pg. 9:8 Service manuals, Road Assistance

Service Manuals for your Volvo are available for purchase. These are the same manuals used by competent Volvo technicians.

Major sections within the Service Manual System include:

0 General Information

1 Lubrication and Service

- 2 Engine
- 3 Electrical System
- 4 Power Transmission
- 5- Brakes
- 6- Suspension and Steering
- 7 Springs, Shock absorbers and Wheels
- 8 Body and Interior

A literature Catalog Request Card was placed in the car prior to delivery from the dealer to you. Complete ordering information is provided.



Volvo supports Voluntary Mechanic Certification by the A.S.E. Certified mechanics have demonstrated a high degree of competence in specific areas.

Besides passing exams each mechanic must also have worked in the field for two or more years before a certificate is issued. These professional mechanics are fully able to analyze vehicle problems and perform the necessary service procedures to keep your Volvo at peak operating condition.

NOTE: The above pertains to the U.S.A. only.



Your new Volvo comes with a three year road assistance program called "ON-CALL". Additional information, features, and benefits are described in a separate information package in your glove compartment.

pg. 9:9 Customer Support

Vehicle Information (see "Label information" section)

Vehicle License Number
Vehicle Identification Number (VIN)
Service Designation Number
Engine Designation (see "Specifications" section)
Color code
Upholstery
Tire designation (See "Tires" section)
Vehicle Capacity

Do not export your volvo to another country before investigating that country's applicable safety and exhaust emission requirements. In some cases it may be difficult or impossible to comply with these requirements. Modifications to the emission control system(s) may render your Volvo not certifiable for legal operation in the U.S., Canada and other countries.

Inside Back Cover

WARNING!**Detergents and solvents**

Do not use gasoline containing lead or benzene as a detergent or solvent. Both lead and benzene are toxic and may be hazardous to your health.

Installation of optional equipment/use of mobile telephones

Incorrectly installed optional equipment, alarm systems or the use of mobile telephones which are not connected to a suitable antenna can cause faults in the car's electronic control systems. Consult your Volvo dealer before installing any such products.

Carbon monoxide

Carbon monoxide is a poisonous, colorless and odorless gas which is present in all exhaust gases. If you ever smell exhaust fumes from inside the vehicle, make sure the passenger compartment is ventilated and immediately return the vehicle to your dealer for correction.

Never sit in a parked or stopped car for any extended amount of time, nor have it unattended while the engine is running.

Never operate the engine in confined, unventilated areas.

Back Cover

The following should be checked regularly *

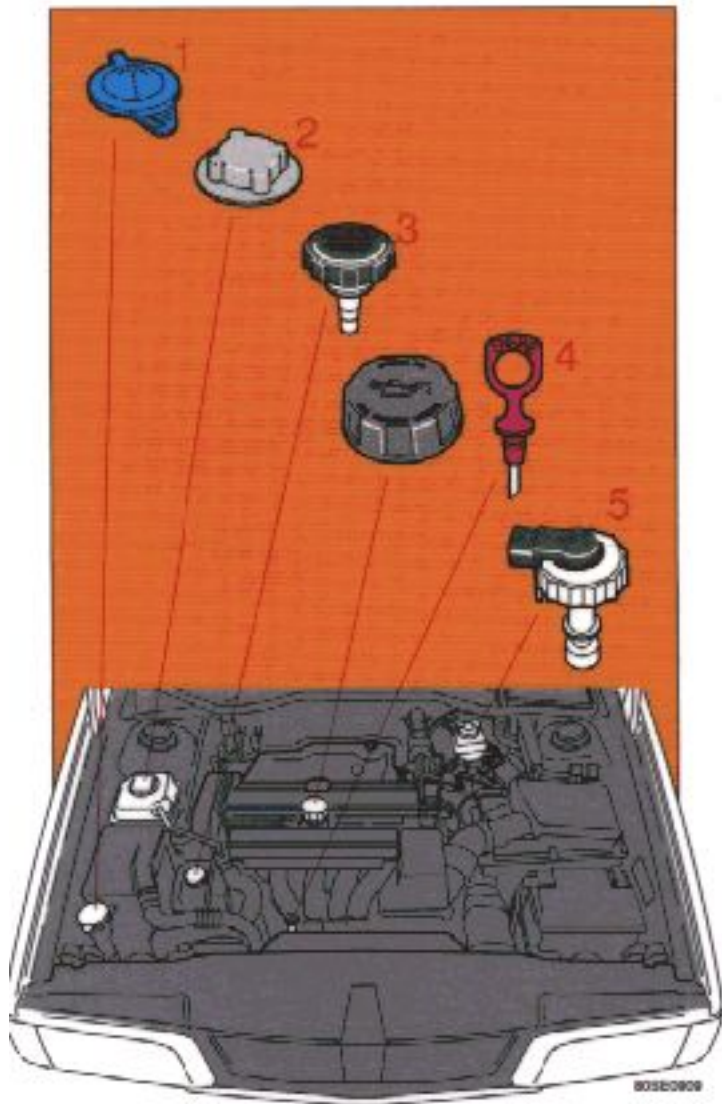

1 Washer fluid reservoir should be filled with water and solvent (wintertime: windshield washer anti-freeze). See page 8:15.

2 Coolant level should be between the expansion tank marks. Mixture: 50% anti-freeze and 50% water. See page 8:16.

3 Power steering - When cold, the level must not be above the COLD mark and when hot it must not be above the HOT mark. Top up if the level drops to the ADD mark with ATF fluid. See page 8:12.

4 Engine oil level should be between the dipstick marks. The distance between the marks represents approx. 1 US qt. (1 liter). See page 8:10.

5 Brake fluid - check, without removing the cap, that the level is above the MIN mark. Use brake fluid DOT 4+. See page 8:12.

* Engine oil should be checked each time the car is refuelled.

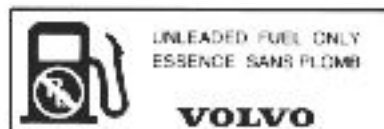

Octane rating, see page 4:3

Tire pressure, see label located on inside of fuel filler flap.



Bulbs	Power	Socket
1	HB2	9003
2	5 W	BAY 15s
3	21 W	BAY 15s

VOLVO

Volvo Car Corporation

Göteborg, Sweden

TP 3374/2 (Canada & USA) 31.000.09.92 Printed in Sweden, Graphic Systems AB, Göteborg, Sweden
199



[Contents](#) | [Top of Page](#)