



**AUDIOVOX<sup>®</sup>**  
ELECTRONICS CORP.

**LCM500NP 5 Inch Monitor  
with  
2 Video Input Capability**



**Installation and Operation Manual**

## Important Notice

It is unlawful in most jurisdictions for a person to drive a motor vehicle which is equipped with a television viewer or screen that is located in the motor vehicle at any point forward of the back of the driver's seat, or that is visible directly or indirectly, to the driver while operating the vehicle.



### CAUTION

1. Do not operate the monitor at temperatures below 32°F (0°C) or above 104°F (40°C).
2. Keep the monitor clean and dry.
3. Always seek qualified personnel to perform repairs. Never attempt your own repairs.
4. Do not drop the monitor or expose to strong impacts.
5. Do not expose to direct sunlight for extended periods of time.

## The Materials included in this package:

- |    |   |       |
|----|---|-------|
| 1. | LCM500NP Monitor                          | (1pc) |
| 2. | Remote Control Unit                       | (1pc) |
| 3. | Interconnection Box (AVX-6865)            | (1pc) |
| 4. | Monitor Cable Assembly 16 Feet (5 Meters) | (1pc) |
| 5. | Power Cable Assembly                      | (1pc) |
| 6. | Surface Mount (S2)                        | (1pc) |
| 7. | Headrest Shroud                           | (1pc) |
| 8. | Trim Ring For Shroud                      | (1pc) |
| 9. | Removal Tool                              | (1pc) |

## LCM500NP SYSTEM OVERVIEW

The LCM500NP is comprised of a 5" Thin Film Transistor (TFT) Liquid Crystal Display ( LCD) monitor. The monitor display is a widescreen display (16:9 Aspect Ratio ) that allows the user to select from two video sources (Not Supplied). The housing has a built-in location for the installation of an optional infrared audio transmitter ( Audiovox IRT 456, IRT 457) for use with optional two channel wireless headphones. The monitors will display all functions with the comprehensive On Screen Display (OSD).

## OPTIONAL AUDIO CONNECTION

### Required Materials:

- |    |   |       |
|----|---|-------|
| 1. | IRT456 (CHA) Infrared Transmitter         | (1pc) |
| 2. | IRT457 (CHAB) Infrared Transmitter Remote | (1pc) |
| 3. | WHS200 Two Channel Infrared Headphones    |       |

Before installing the IRT boards gently bend the three IR LEDs closest to the center of the vehicle toward the center of the vehicle.

IRT 456 CH A BEFORE

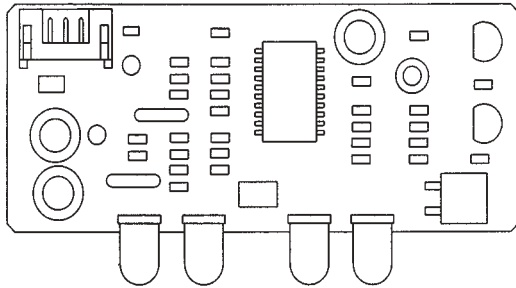

IRT 456 CH A AFTER

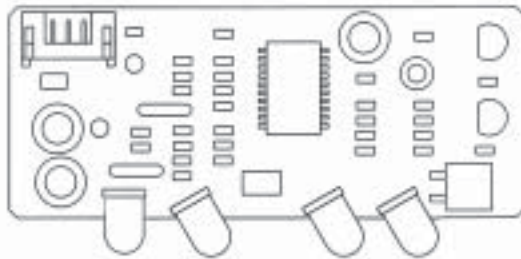

IRT 457 CH B BEFORE

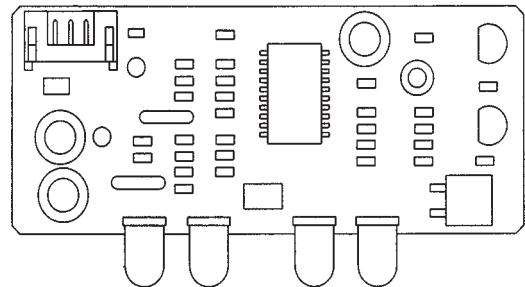

IRT 457 CH B AFTER

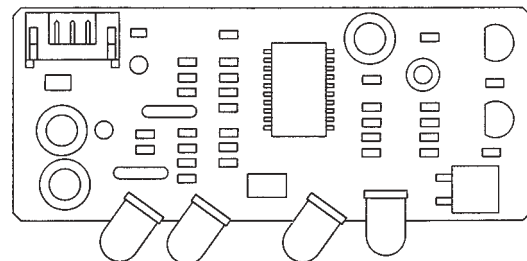

Insert the IRT boards into their respective compartments in the monitor housing and insert the plug into the IRT board. When the user switches the video source utilizing the ON/OFF/MODE switch, the A/B switch on the WHS200 headphones must also be switched to select the desired audio source.

## VEHICLE PREPARATION:

- 1) Decide on the system configuration and the options that will be installed (i.e.what components, VCP, DVD, TV Tuner, Video Game, Monitor, FM Modulator, etc.).
- 2) Read the manuals and get familiar with the electrical requirements and connections.
- 3) Decide on the mounting locations and methods of mounting the products.
- 4) Prepare the vehicle by removing any interior trim necessary to gain access to the vehicle's wiring as well as all areas where interconnecting wire harnesses will be located. If any access holes need to be cut into the vehicle, headrests, or other trim components, this should be performed now. (Refer to the Installation Procedure).
- 5) Run the wiring harnesses throughout the vehicle as necessary. (Refer to the Wiring Diagram on page 7, as well as the wiring instructions for the individual components and accessory options being installed). Be sure, that all the wiring is protected from sharp edges and is routed in such a manner that it will not be pinched, when it is fully installed. Be sure to leave enough slack in the wiring at each component to allow sufficient working room.
- 6) Remove all the A/V system components from their packaging and then place them in the vehicle at their respective locations.
- 7) Connect all the components together (electrically) and verify the proper operation of all the system functions. **NOTE:** This is best done BEFORE the components are permanently mounted.
- 8) After verifying the proper operation of the system, proceed to mount each component.
- 9) When all the components are mounted, recheck the function of the entire system to be sure it is functioning correctly. Make sure that no wiring was pinched, or connected improperly during the final installation.
- 10) Locate the following: an accessory power source (+12VDC present when the ignition key is in the accessory and run positions). 0VDC should be present, when the ignition key is in the OFF position. A constant power source (+12VDC present at all times). Generally, these wires can be found at the ignition switch or fusebox. (**NOTE:** Ensure that the power leads are fused at the source. Failure to do so may result in vehicle wiring damage.) Ground the black wire to a chassis ground close to the mounting location of AV sources.
- 11) The mounting method, and the location will vary from vehicle to vehicle, so this manual will only focus for the installation of the LCM500NP Monitor in the supplied configuration.
- 12) The best location for the LCM500NP System components are:
  - a) Monitor : Headrest
  - b) Interconnection Box: Under either seat where monitors are located.

Tools and Materials Required:

- Utility knife or box cutter with sharp blade
- Sharpie™ marker or similar
- Tie Wraps

Remove the headrest from the vehicle for easiest installation.

Lay headrest on a flat surface

Center trim collar on headrest as shown.

**NOTE:** Depending on the angle of the headrest the trim ring and housing may be mounted upside down.

Using a Sharpie™ marker or similar marking pen, mark headrest material along the interior of the trim collar.

Remove the trim collar and mark an “X” from corner to corner as shown



Using the utility knife, cut the headrest material along the “X” lines. Do not cut the material along the other lines at this time.



This will leave you with an “X” cut as shown.



Pull the flaps up and cut the foam beneath the material to the proper depth. Cut all four sides of the foam.



Using your fingers, tear the foam out of the headrest leaving a recess where the shell will be inserted.

At this point you will need to install the harness up through the area into the recess. It may be helpful to follow one of the posts and tie wrap it to the post for restraint.



Lay the flaps of headrest material down into the recess and insert the clamshell into the recess. Check for fit. If it does not fit properly, you may need to remove some more foam.

**NOTE:** The clamshell will need to be secured to the headrest, either by using tie straps, screws, ect..

If used, remove the clamshell and insert the IR transmitter and plug into the IR transmitter board. Reinsert the clamshell into the recess and secure using tie wraps or screws.

Plug the remaining connector into the monitor.

Turn the monitor around and insert it into the clamshell housing. Snap into place.

Connect the wiring to the video system and test.



The supplied Release Key is for removing monitor from housing. Refer to the drawing below.

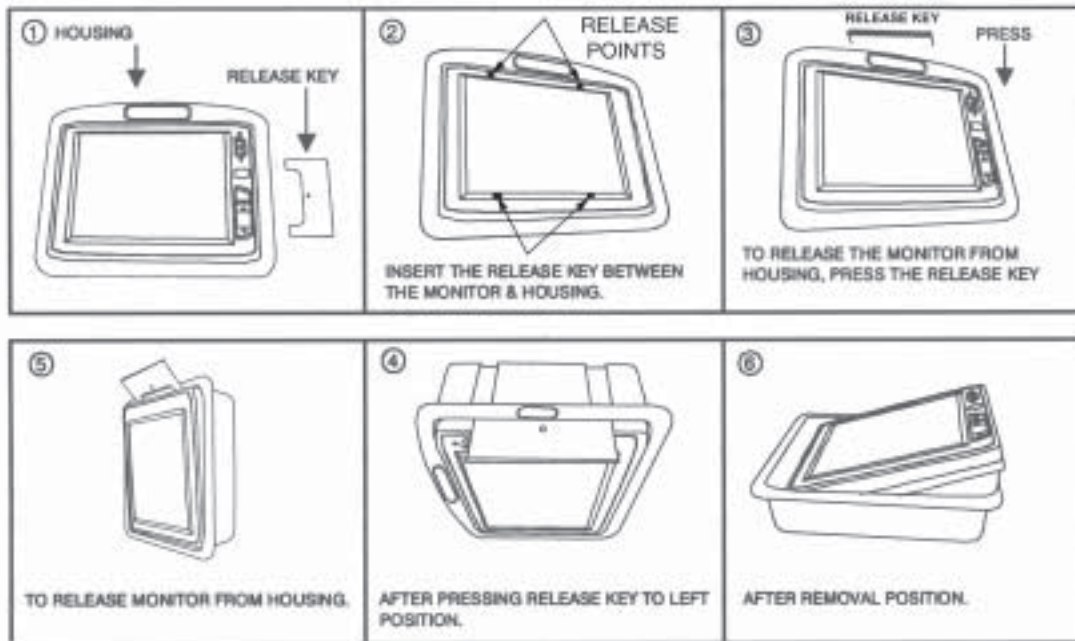

### MONITOR SURFACE MOUNTING:

1. Slide the monitor onto the mount S2 and tighten using the fastener.

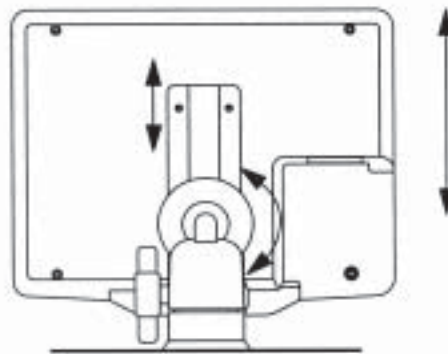

2. Firmly attach surface mount to a flat surface and adjust the viewing angle of the monitor by loosening the fastener on the side. Tilt the monitor for a good viewing angle and retighten the fastener.

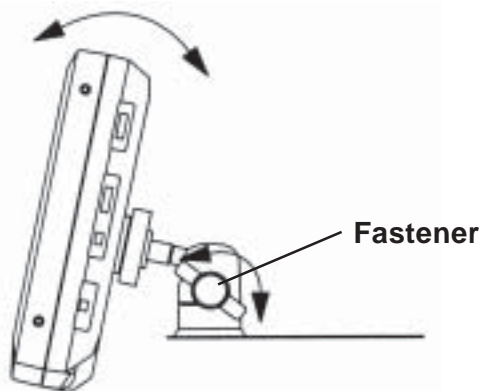



## LCM500NP SYSTEM WIRING DIAGRAM

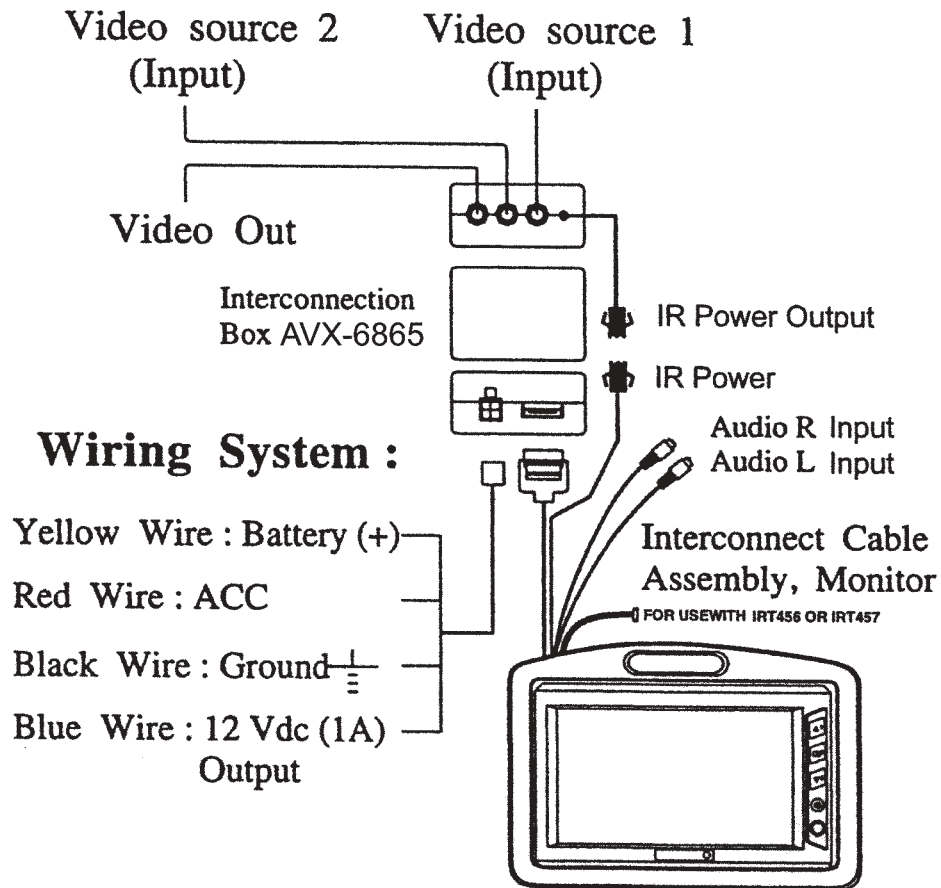

- 1.) Make sure the LCM500NP has been installed properly, as described in the procedures as stated on pages 2, 3, and 5.
- 2.) Plug the 15 pin connector into the jack labelled -15 pin to MONITOR on the AVX-6865 Interconnection Box.
- 3.) Connect the 2 pin connector to the jack labelled IR POWER output on the AVX-6865 Interconnection Box.
- 4.) Connect the video source to the jack labelled VIDEO IN 1 on the AVX-6865 Interconnection Box.
- 5.) Connect the audio source to the 2 RCA connectors that are incorporated in the Monitor Cable Assembly (for optional audio connection).
- 6.) Power Connections:
  - a) Red (ACC): Connect to switched 12Vdc.
  - b) Yellow (Batt): Connect to constant 12Vdc.
  - c) Blue (Remote Out): 12Vdc output.
  - d) Black (Ground): Connect to chassis ground.

# Controls and Indicators

## Monitor Panel Controls

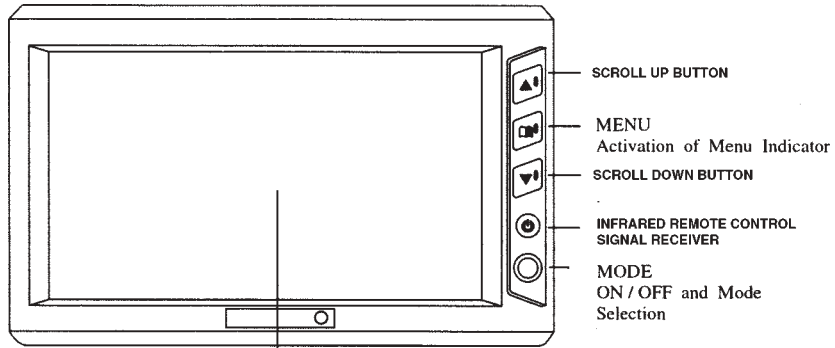

On Screen Display (OSD) Indicator

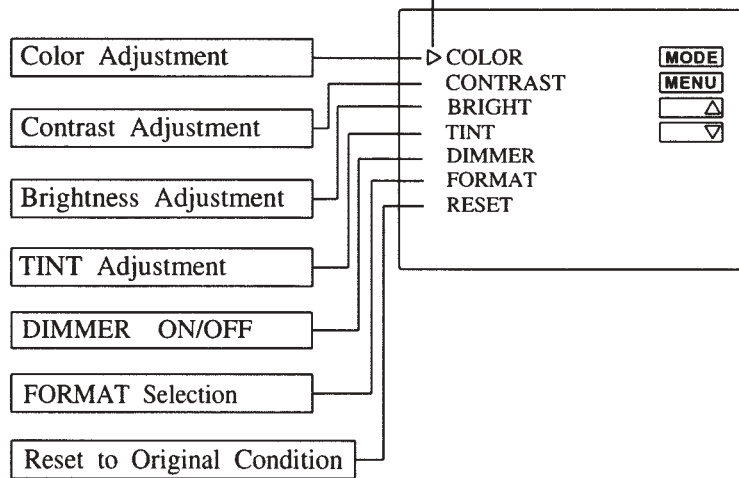

# Remote Control Unit

## Remote Control Unit Controls

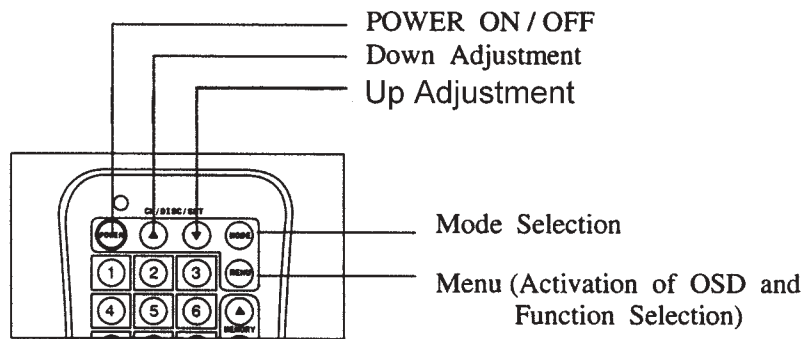

Using Menu Function Key :

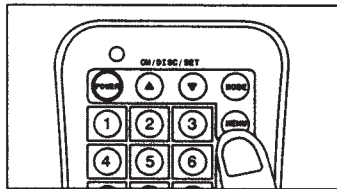

Press Menu Key

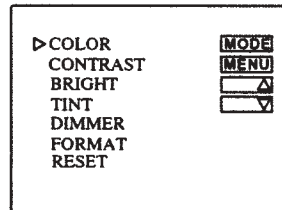

OSD will appear on screen

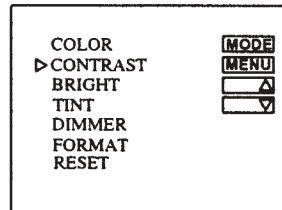

Press Menu key until OSD indicator is at the correct function mode

# Remote Control Unit Controls Continued

**▲ KEY**



Press the ▲ to the desired setting

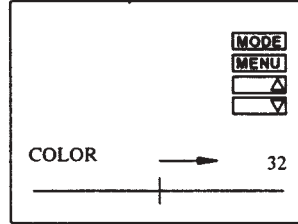

**▼ KEY**



Press the ▼ to the desired setting

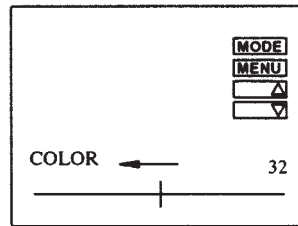

Press the MODE key to select the desired video source input (Input 1 or Input 2)

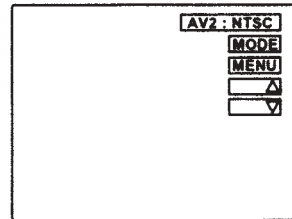
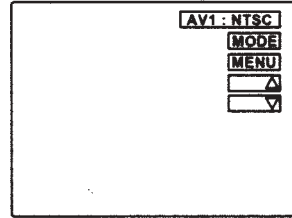
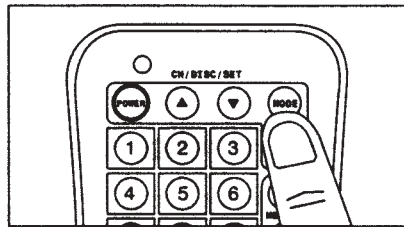

## Display Mode

1. Press MENU to get the On Screen Display (OSD).
2. Select FORMAT.
3. Press the ▲ or the ▼ to switch the screen aspect ratio.

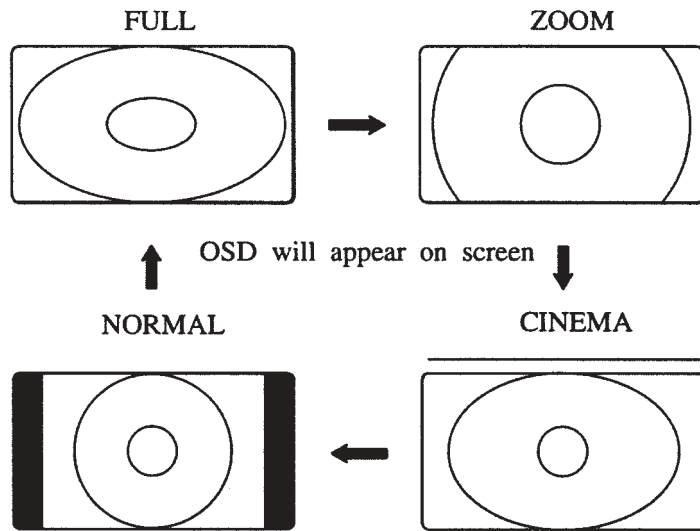
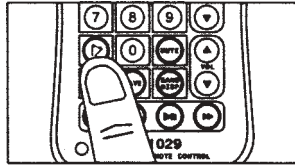

**FULL:**

16:9 picture is fully displayed.

**ZOOM:**

Picture is stretched vertically and horizontally.

**CINEMA:**

Picture is displayed with uniform horizontal enlargement.

**NORMAL:**

When 4:3 picture is displayed on a wide screen, black bands appear on the right and left of the picture

## OPERATING INSTRUCTIONS

### 1. POWER ON/OFF/MODE

Press the POWER button to turn power on.

Pressing the POWER button again momentarily will change video inputs.

Press the ▲ for NTSC input.

Press the ▼ for PAL input.

Press and hold the POWER button for three seconds to turn power off.

### 2. ▲ Scroll Up Button

This button is used to increase selected menu items (Brightness, Contrast, Color, Tint, [NTSC] Only) This button will also switch selected items (DIM, RESET, FORMAT).

### 3. ▼ Scroll Down Button

This button is used to decrease selected menu items (Brightness, Contrast, Color, Tint, [NTSC] Only) This button will also switch selected items (DIM, RESET, FORMAT).

### 4. MENU Button

Press the MENU button once to display the menu On Screen Display.

Press the button again until the desired menu item is highlighted.

Use the ▲ or ▼ to adjust or switch the selected item. The On Screen Display menu will disappear if no buttons are pressed for four seconds.

## MONITOR SPECIFICATIONS

1. Type : TFT Active Matrix LCD
2. Display Screen Size : 4.3 x 2.5 inches (109.2 x 63.5) (W x H)
3. Resolution: 1200 (W) x 234 (H)
4. Pixels: 280,800
5. Back Light : Cold Cathode Fluorescent Lamp
6. Power Source : +12 VDC
7. Power Consumption : 510 mA, 7W
8. Connection Terminals : 1-12 Vdc Constant -Yellow  
1-12 Vdc Switched -Red  
1- Ground-Black  
1-12 Vdc Output -Blue  
2-Video Inputs-RCA  
1-Video Output-RCA  
2- Audio L/R In-RCA
9. Operating Temperature : 32°F – 104°F (0°C – 40°C)
10. Storage Temperature : -4°F – 176°F (-20°C – +80°C)
11. Monitor Cabinet : 5.3 in x 3.3 in x 1 in (WxHxD)  
Dimensions (134.6 x 83.2 x 25.4 mm)
12. Weight : 11.1 oz (314.67g)
13. Video Format : PAL, NTSC (Switchable)



For Customer Service  
Visit Our Website At  
**[www.audiovox.com](http://www.audiovox.com)**  
Product Information, Photos,  
FAQ's Owner's Manuals