

CEILING CONCEALED TYPE AIR CONDITIONER

Operation & Installation Manual

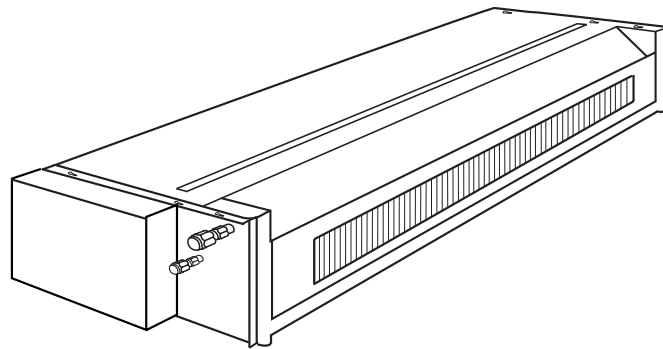

No. 0010573573
A

- Please read this operation manual before using the air conditioner.
- Please keep this manual carefully and safely.

Table of Contents

Cautions	1-2
Part Description	3
Important Points of Safety	4-6
Trouble Shooting	7-8
When Fault Occurs	9
Notice to Users	10
Installation Precautions	11-12
Installation Procedure	13-19
Installation Check and Trial Run	20

Cautions

Disposal of the old air conditioner

Before disposing an old air conditioner that goes out of use, please make sure it's inoperative and safe. Unplug the air conditioner in order to avoid the risk of child entrapment.

It must be noticed that air conditioner system contains refrigerants, which require specialized waste disposal. The valuable materials contained in a air conditioner can be recycled. Contact your local waste disposal center for proper disposal of an old air conditioner and contact your local authority or your dealer if you have any question. Please ensure that the pipework of your air conditioner does not get damaged prior to being picked up by the relevant waste disposal center, and contribute to environmental awareness by insisting on an appropriate, anti-pollution method of disposal.

Disposal of the packaging of your new air conditioner

All the packaging materials employed in the package of your new air conditioner may be disposed without any danger to the environment.

The cardboard box may be broken or cut into smaller pieces and given to a waste paper disposal service. The wrapping bag made of polyethylene and the polyethylene foam pads contain no fluorochloric hydrocarbon.

All these valuable materials may be taken to a waste collecting center and used again after adequate recycling.

Consult your local authorities for the name and address of the waste materials collecting centers and waste paper disposal services nearest to your house.

Safety Instructions and Warnings

Before starting the air conditioner, read the information given in the User's Guide carefully. The User's Guide contains very important observations relating to the assembly, operation and maintenance of the air conditioner.

The manufacturer does not accept responsibility for any damages that may arise due to non-observation of the following instruction.

- Damaged air conditioners are not to be put into operation. In case of doubt, consult your supplier.
- Use of the air conditioner is to be carried out in strict compliance with the relative instructions set forth in the User's Guide.
- Installation shall be done by professional people, don't install unit by yourself.
- For the purpose of safety, the air conditioner must be properly grounded in accordance with specifications.
- Always remember to unplug the air conditioner before opening inlet grill. Never unplug your air conditioner by pulling on the power cord. Always grip plug firmly and pull straight out from the outlet.



Cautions

- All electrical repairs must be carried out by qualified electricians. Inadequate repairs may result in a major source of danger for the user of the air conditioner.
- Do not damage any parts of the air conditioner that carry refrigerant by piercing or perforating the air conditioner's tubes with sharp or pointed items, crushing or twisting any tubes, or scraping the coatings off the surfaces. If the refrigerant spurts out and gets into eyes, it may result in serious eye injuries.
- Do not obstruct or cover the ventilation grille of the air conditioner. Do not put fingers or any other things into the inlet/outlet and swing louver.
- Do not allow children to play with the air conditioner. In no case should children be allowed to sit on the outdoor unit.

Part Description



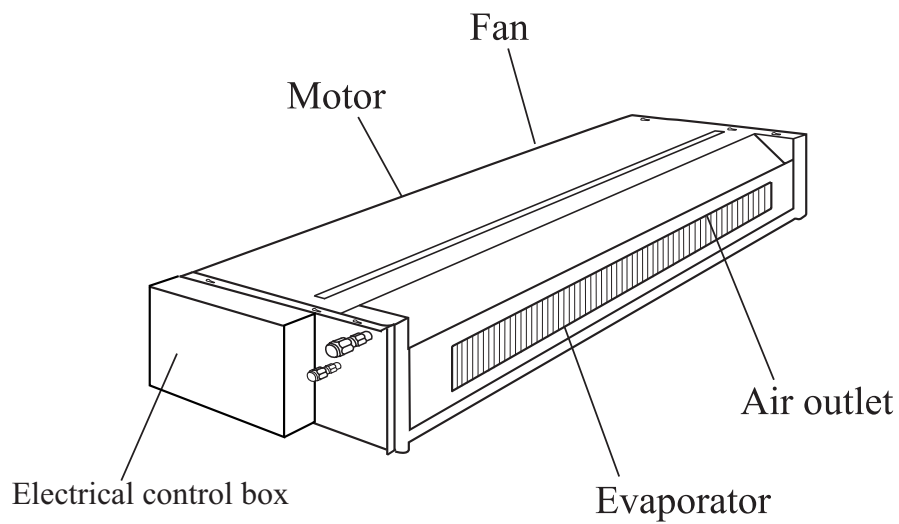

NOTE

When the unit have the Return air box (see the following picture) when shipping from the factory and they are of back-side return air type. During the installation, the unit also can be changed to a Down-side Return air according to the user's need.







Important Points of Safety







The following four important points of safety and suggestions should be paid great attention:



-  Warning: Misuse may cause fatal result such as death or serious injury etc.
-  Attention: Misuse may cause human injury or damage of machine, in some case fatal results.
-  : Content marked with this 'forbidden' sign should be absolutely forbidden, otherwise may cause damage of machine and human injury of the user.
-  : Content marked with this 'compulsory' sign should be executed compulsively, otherwise may cause damage of machine and human injury of the user.

Comply with the following important points of safety.
 Put these important points of attention and suggestions nearby and convenient for reference in need.
 Hand over this instruction manual to new user if you resell this machine.











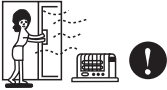

 Warning	
Warning for installation	<ul style="list-style-type: none"> ● Entrusted Installation Installation of the machine should be entrusted to certified person of after service. Unauthorized installation may cause water leakage, electric shock or fire hazard for improper operation.  ● To prevent leakage of refrigerant, let certified person of after service do it. ● Leakage of refrigerant over certain consistence may result in shortage of oxygen. Enough precautions MUST be done to avoid oxygen shortage in case of refrigerant leaking if the room where the air-conditioner is installed is small. 
	<ul style="list-style-type: none"> ● The power supply must be fitted with earth line to ensure valid earthing of the air-conditioner. No or incomplete earthing connection may cause the risk of electric shock.  ● Test run After indoor units are installed,all cassettes hinded models should be tested.when the units are confirmed to be normal,other fitments can be installed. 

Important Points of Safety

 Warning		
Warning for use	<ul style="list-style-type: none"> ● Avoid your body being blown directly by cold wind for long period, otherwise your health may be affected.  ● Don't extend your fingers or any other article into the inlet or outlet during operation of the machine for touching revolving fans may cause human injury or damage of machine.  	<ul style="list-style-type: none"> ● If something abnormal (e.g.: burnt smell etc.) occurs, stop running the machine, shut down the manual power switch and contact after service. Continuous operation in disorder may cause fire hazard or electric shock etc. 
Warning for move and repair	<ul style="list-style-type: none"> ● When you have to disassemble and reinstall the machine, entrust it to after service. Improper installation may cause fire hazard, electric shock or damage of machine.  	<ul style="list-style-type: none"> ● Unauthorized alteration or repair work is strictly forbidden. Improper alteration or maintenance may cause fire hazard, electric shock or water leakage. Repair work should be entrusted to certified person of after service. 



 Attention		
Attention points for installation	<ul style="list-style-type: none"> ● Ensure the drainage hose work normally during installation. Improper installation of drainage can cause water leakage and damp articles.  ● DO NOT install the machine in place where flammable gas releases easily to avoid fire hazard. 	<ul style="list-style-type: none"> ● Ensure electric leakage breaker being installed. Electric leakage breaker MUST be installed, otherwise electric shock may be caused.  ● If the power supply cord is damaged, call a certified electrician of the manufacturer or other maintenance department to replace it.

Important Points of Safety

⚠ Attention	
Attention points for use	<ul style="list-style-type: none"> * Ensure ventilation of the room if the machine is used with burning facilities. Deficient ventilation can cause oxygen shortage. <div style="text-align: right;">  </div> * Check whether installation bench of the machine is damaged after a long period of use. Machine on damaged bench may fall down and cause human injury or other damage. <div style="text-align: right;">  </div> * In place where winds produced by the machine can reach, don't lay any animals or plants which may be hurt otherwise. <div style="text-align: right;">  </div> * Don't put vases containing water or other else on the unit assembly. Otherwise, the machine may be immersed internally and result in bad electric insulation causing electric shock. <div style="text-align: right;">  </div> * The is machine CANNOT be used for the purpose of preserving food, animals, plants, precision instruments and artwork etc., which may be destroyed otherwise. <div style="text-align: right;">  </div> * DON'T replace fuse with material other than fuse of proper capacity. Replacing fuse with metal wire or copper etc. can cause fire hazard or other faults. <div style="text-align: right;">  </div>
	<ul style="list-style-type: none"> * DON'T lay any burning facilities in place where winds produced by the machine can reach. Incomplete combustion of burning facility may be caused otherwise. <div style="text-align: right;">  </div> * DON'T clean the machine with water. Electric shock may occur otherwise. <div style="text-align: right;">  </div> * DON'T put flammable spray articles nearby or spray them to the machine. Fire hazard may occur otherwise. <div style="text-align: right;">  </div> * DON'T operate switch with wet hand. Electric shock may occur otherwise. <div style="text-align: right;">  </div> * Stop operation and shut down manual power switch before cleaning and maintenance. <div style="text-align: right;">  </div> * The power supply MUST be of rated voltage and connected with special electrical supply circuit. <div style="text-align: right;">  </div>

Trouble Shooting



The following cases are not troubles.

<p>Water flow sound is heard.</p> <p>"Hua-Hua"</p> 	<p>During operation, the air conditioner may sometimes exhibit a sound of "clatter" or "rumble". This is the common sound of refrigerant flow but not a trouble.</p>
<p>A sound of "Pi-Pa" is generated.</p>	<p>This is caused by the thermal expansion or cold shrinkage of plastics.</p>
<p>Smells are given off.</p>	<p>Sometimes there are smells in the air flow from the indoor unit. This is caused by the smell of cigarettes or paint coatings inside the unit.</p>
<p>During operation, mist or steam are blown out.</p>	<p>During COOL or DRY operation, the unit may blow out a thin mist. This is the condensate water mist caused by sudden cooling of the indoor air blown out from the indoor unit.</p>
<p>During COOL operation, it automatically changes to FAN mode.</p>	<p>In order to prevent frost accumulation on the heat exchanger in the indoor unit, sometimes it will automatically transfers to FAN mode, but soon will return to COOL mode.</p>
<p>The system couldnt be re-started immediately after turning off.The unit can ' t start?</p> 	<p>This is due to the systems self-protection function, which prevents it from restarting in 3 min after stops.</p>  <p>Please wait for 3 min.</p>

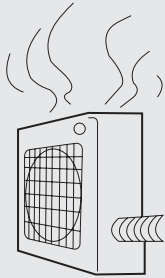
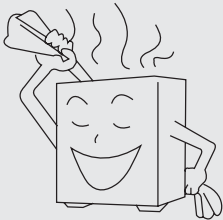
Trouble Shooting

<p>During DRY operation, there is no air sent out or fan speed cant be changed.</p>	<p>In DRY operation,when the room temperature reaches 2°C higher than temp. setting,the unit will run at"low"fan speed regardless of fan speed setting.</p>
<p>In HEAT mode, the outdoor unit generates water or steam.</p> 	<p>This occurs during removal of the frost (in defrosting operation) on the radiator of outdoor unit.</p>  <p>Defrost operation</p>
<p>In HEAT mode, the indoor fan still keeps running even the unit operation stops.</p>	<p>After the unit stops, the indoor fan will continue to run for a while to eliminate residual heat.</p>

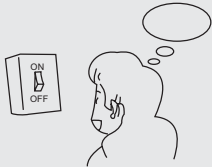
Before asking for after-service to an authorized service center, please check your air conditioner for the following items



The system couldn't start		
<p>Is power on/off switched on?</p>  <p>The power on/off switch is not at position of "ON".</p>	<p>Is the power supply line normal?</p> 	<p>Is current leakage breaker triggered?</p> <p>Please do immediately cut off power supply and contact the authorized service center.</p>

When Fault Occurs

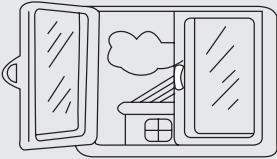
Poor cooling or heating

<p>Is the operation controller adjusted as required?</p>	<p>Are there any obstructs before the air inlet or outlet?</p>	<p>Is there any door or window left open?</p> 
--	--	--

Poor cooling

<p>Is there any other heat source in the room?</p> 	<p>Is there any direct sunlight into the room?</p> 	<p>Are there too many people in the room?</p> 
--	--	---

If, after the above checks and the corresponding corrective actions, the system remains abnormal operation, or the following facts appear, please turn off the air conditioner and then contact the local authorized service center.

- Frequent open of fuse or breaker.
- There is water leakage during COOL or DRY operation.
- The operation is abnormal or abnormal sound is heard.

Notice to Users

Notice to users

- To ensure proper operation of the system, the user shall follow this instruction manual to install the unit.
- When handling the air conditioner, please be care not to scratch the case surface. This instruction manual describes the installation method aided with the installation tools specified by manufacturer .
- The maximum length of connection pipe is 50 m, and the maximum difference between levels of indoor unit and outdoor unit shall be 30 m.
- Please keep the installation instruction manual well for reference in maintenance or changing installation position.
- After installed, please follow the operational instruction manual to use the air conditioner properly.

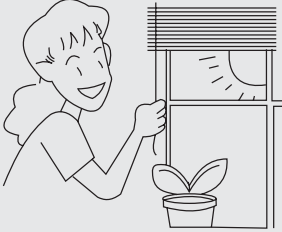
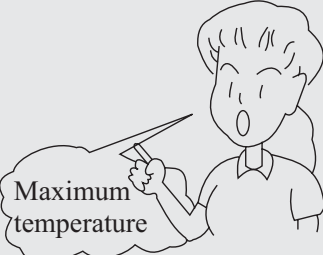
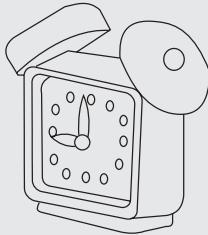
Information about application	
<p>Adjust your desired air flow direction</p> 	<p>Avoid direct sunlight and gas flow</p> 
<p>Keep appropriate room temperature Too cool or too warm wont benefit to your health, but causes an increased energy consumption.</p> 	<p>Effectively use the timer Using TIMER mode you can enjoy a comfortable room temperature when wake up or come back home.</p> 

Caution: After installation, please confirm no refrigerant leaks.

Installation Precautions

- Before installing, do read this "Safety precautions" carefully to guarantee the proper installation.
- The below attentive matters are divided into "⚠ Warning" and "⚠ Note" two parts. When the wrong installation occur, it is very possible death and severe injury and other serious accidents will happen. For those items are listed in "⚠ Warning" part. But even the items listed in "⚠ Note" part can also cause serious accidents. Above all, both the two parts are very important contents related to safety, so they must be obeyed.
- After finishing the installation work, do test run to verify everything is normal. After that please explain the using and maintenance methods to the user. Additionally, give this installation manual and operation manual to the user and ask them to keep it properly.

⚠ Warning

- The distributing shop, where you bought the air conditioner, or the specified shops shall do the installation work. If you do the installation work by yourself, the improper installation will cause water leakage, electric shock fire and other accidents.
- The installation work shall be in line with what the installation manual specified. If installation is not proper, water leakage, electric shock, fire and other accidents will occur.
- Install the air conditioner to a place where can definitely stand its weight. Places not firm enough will cause drop down of unit resulting in body hurt.
- The installation work shall be preventive to typhoon and earthquake. If the installation work is not met with the requirements, overturn of the unit will occur resulting in accidents.
- The wiring work shall be done by a qualified person and referred to the "technical standard of electric equipment", "indoor wiring regulation" and what the manual specified. Do use special circuit. If the capacity of the circuit is not enough or bad work, electric shock, fire and other accidents will happen.
- Using the specified cable to do wiring work and connecting firmly and properly. Fix the connecting part of the terminals to prevent it from the external force. Improper connection and fixing will cause heating and fire etc. accidents.
- Wiring shall be kept in correct shape avoiding extrusion. After installation, the electric box cover and the external panel shall not nip the wire. Improper installation will cause heating and fire etc. accidents.
- When setting or moving the air conditioner do not let the air and things alike get into the refrigeration system except the specified refrigerant. If air and other things enter, abnormal high pressure will occur, which easily cause break and body injuries etc. Accidents.
- When installing, do use the accessories or specified parts. If not using the parts specified by our company, water leakage, electric shock, fire and refrigerant leakage will occur.
- Do not lead the drainpipe to drain where the sulfur gas may be involved. Otherwise, the poisonous gas will enter into the indoor.
- During installation, if refrigerant leakage occurs, do the ventilation work immediately. As soon as the refrigerant gas meets fire, poisonous gas will be produce. If the refrigerant gas enters into room and meet the air blowing heater, heater or stove etc. fire source, the poisonous gas may be produced. After installation, confirm there is no leakage of refrigerant.
- Do not install the unit in a place where the combustible gas may be leaked. In any case the combustible gas leaks and accumulated around the unit, fire accident will occur.
- Do heat insulation work to the refrigerant gas pipes and liquid pipes to reach the purpose of heat preservation. If the heat insulation measure is not sufficient, water generated by condensing dew will drip leading to wet the floor and indoor articles.

⚠ Note

- Do grounding work. Do not connect the grounding wire to gas pipe, tap, lighting rod or telephone line. Improper grounding will cause electric shock.
- After electric installation, power on them to do electric leakage test.

Installation Precautions

The indoor unit shall be installed at locations where cold and hot air could evenly circulated. The following locations should be avoided:

- Places with rich saline matters (seaside regions).
- Places with plenty of gas sulfides (mainly in warm spring areas where the copper tube and braze weld is prone to corrosion).
- Locations with much oil (including mechanical oil) and steam.
- Locations using organic solvents.
- Places where there are machines generating HF electromagnetic waves.
- Positions adjacent to door or window in contact with high-humidity external air. (Easy to generate dew).
- Locations frequently using special aerosols.
- Less than 2.7 meters above the floor for air outlet opening.

⚠ Attention

This description does not address to all possible cases. For new requirement and query, please consult the regional sales center of Haier Air Conditioner General Co., Ltd.

⚠ Warning

This instruction manual must be read carefully before beginning of installation, improper installation may cause accidents and thus bring about machine damage and personal casualty.

Installing tools

- | | | |
|--------------------------------|------------------|------------------------------------|
| 1. Screw driver | 6. Pipe cutter | 10. Leakage detector or soap water |
| 2. Hacksaw | 7. Pipe expander | 11. Measuring tape |
| 3. Driller of 70mm diameter | 8. Knife | 12. Scraper |
| 4. Spanner (diameter 17, 27mm) | 9. Pinchers | 13. Refrigeration oil |
| 5. Spanner (14, 17, 19, 27mm) | | |

Indoor unit

1. Select suitable places the outlet air can be sent to the entire room, and convenient to lay out the connection pipe, connection wire and the drainage pipe to outdoor.
2. The ceiling structure must be strong enough to support the unit weight.
3. The connecting pipe, drain pipe and connection wire shall be able to go though the building wall to connect between the indoor and outdoor units.
4. The connecting pipe between the indoor and outdoor units as well as the drain pipe shall be as short as possible. (See Figure 1)
5. If its necessary to adjust the filling amount of the refrigerant, please refer to the installation manual attached with the outdoor unit.
6. The connecting flange should be provided by the user himself.
7. The indoor unit have 2 drainage outlet, one outlet be jamedwith rubber cap, during installation only use another outlet (In/Out liquid pipe side). When necessary, use the two together.
8. Do not place the TV, equipment, facility, piano etc, expensive goods below the AC. This is to prevent the water dropping down from the AC and lead to damage to the goods.

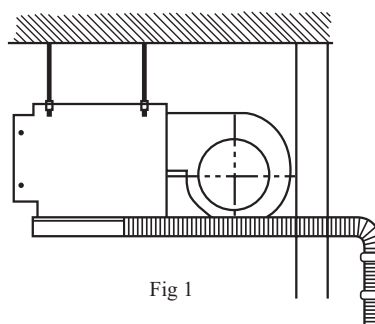

Installation Procedure

After selecting the unit installation location, proceed the following steps:

1. Drill a hole in the wall and insert the connecting pipe and wire through a PVC wall-through tube purchased locally. The wall hole shall be with a outward down slope of at least 1/100. (See Figure 2)
2. Before drilling check that there is no pipe or reinforcing bar just behind the drilling position. Drilling shall avoid at positions with electric wire or pipe.
3. Mount the unit on a strong and horizontal building roof. If the base is not firm, it will cause noise, vibration or pipe broken and refrigerant leakage (see Figure 6).
4. Support the unit firmly.
5. Change the form of the connection pipe, connection wire and drain pipe so that they can go through the wall hole easily.

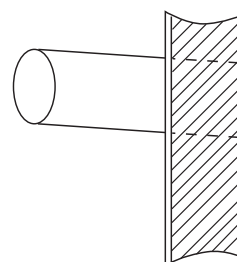
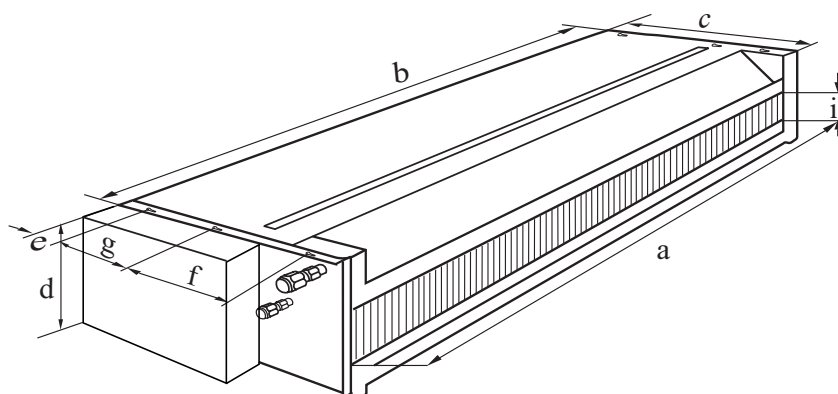

Fig 2

Figure showing installation dimensions: (unit:mm)

Model	a	b	c	d	e	f	g	i
Series 07-09	615	648	452	225	55	125	225	100
Series 12-14	770	804	452	225	55	125	225	100
Series 18-21	990	1024	452	225	55	125	225	100



Notes

1. For electrical heating unit, the air outlet not allowed directly connecting with canvas etc. easy catching fire goods.
2. This series' indoor unit are all middle static pressure(50 Pa external static pressure).
3. An access port must be provided during installation of indoor unit for maintenance.

Installation Procedure

- When installing the ceiling concealed type indoor unit, a specially designed return air bellows shall be installed, as shown in Figure 3, Figure 4.

Figure 3

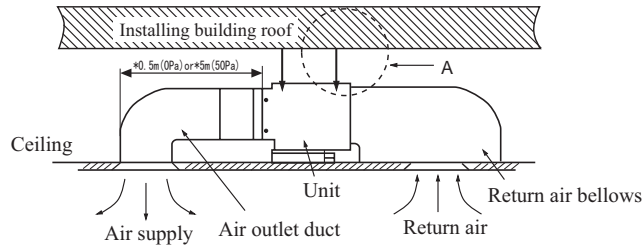
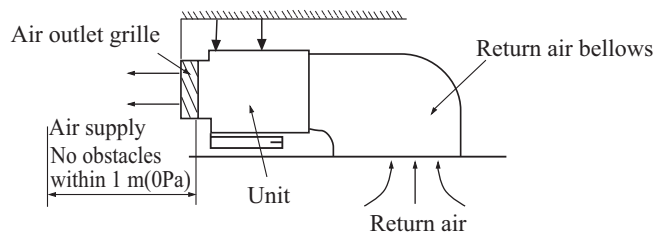
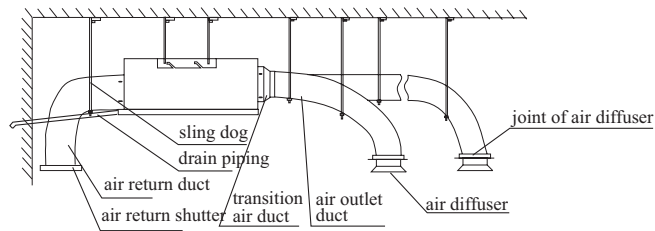

Figure 4



- Each air return and supply duct should fix to the floor precast slab by using an iron stand. Use glue to seal the interface closely. Recommend the distance between the air return duct and the wall is more than 150mm.
- The distance between air duct outlet and air conditioner outlet is according to the length of actually installed air duct and in service behavior of the static pressure terminal: Installation sketch map for long and short air duct is showed below, when connect to short air duct, using low static terminal (terminal color is white), the distance between air duct outlet and air conditioner outlet is no more than 0.5m; when connect to long air duct, using middle static terminal (terminal color is red), the distance between air duct outlet and air conditioner outlet could be within 5m at this point.

Figure 5



- Drain piping of condensed water should keep a downhill grade of 1% or more. Use insulating pipe to cover the drain piping of condensed water to keep warmth.
- As figure shown, suspend and install the unit.

Figure 6

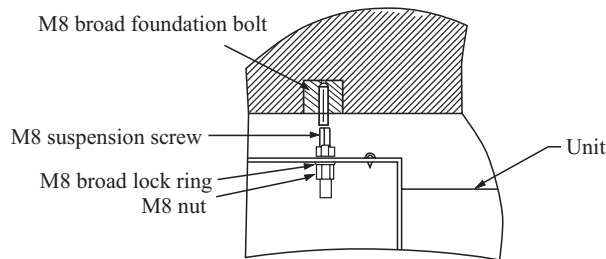

Figure 6

Installation Procedure

Installation for air duct of indoor unit

1. Installation of air discharge duct

- This type of unit uses circular air duct with its caliber of 180mm.
- An additional transitive air duct is necessary for the circular air duct to connect to the air supply inlet. It should be also connected to its respective air diffuser separately. See Fig.1. Adjust the wind speed of each air diffuser outlet to keep in line on the whole, so as to meet a demand of the air conditioner in the room.

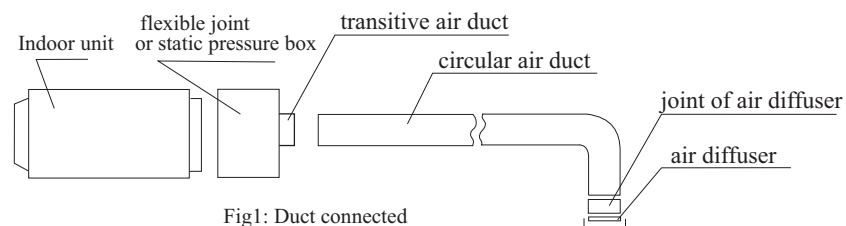

Fig1: Duct connected

2. Installation of air return duct

- Use rivets to connect the air return duct to the air return inlet of the indoor unit. The other end connects to the air return shutter. as shown in Fig.2.

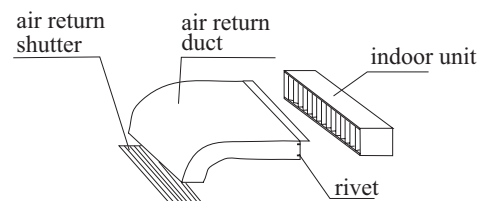

Fig2: Duct return connected

3. Air duct insulation

- Insulation layer is needed for air supply and return duct. First, paste a glue nail to the air duct, and then attach the insulation cotton that has a tinfoil layer and use the glue nail cover to fix. Finally, seal the air duct interface with tinfoil adhesive tape closely. as shown in Fig3.

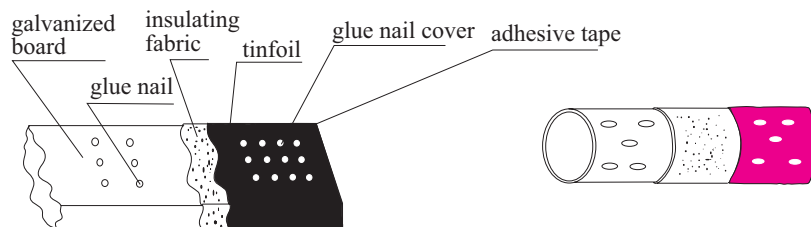

Fig3

Installation Procedure

Installing the suspension screw:

Use M8 or M10 suspension screws (4, prepared in the field) (when the suspension screw height exceeds 0.9 m, M10 size is the only choice). These screws shall be installed as follows with space adapting to air conditioner overall dimensions according to the original building structures.

Wooden structure

A square wood shall be supported by the beams and then set the suspension screws.

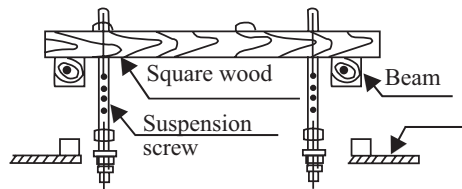

New concrete slab

To set with embedded parts, foundation bolts etc.



Knife embedded part

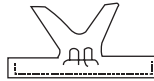

Guide plate embedded part

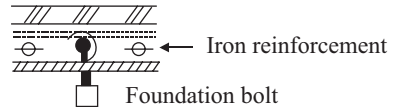

Pipe suspension foundation bolt

Original concrete slab

Use hole hinge, hole plunger or hole bolt.

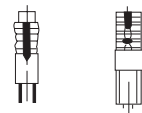

Steel reinforcement structure

Use steel angle or new support steel angle directly.

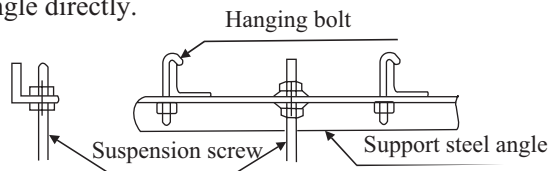

Hanging of the indoor unit

- 1 Fasten the nut on the suspension screw and then hang the suspension screw in the T slot of the suspension part of the unit.
- 1 Aided with a level meter, adjust level of the unit within 5 mm.

Installation Procedure

⚠ Caution

- In order to drain water normally, the drain pipe shall be processed as specified in the installation manual and shall be thermal insulated to avoid dew generation. Improper hose connection may cause indoor water leakage.

Requirements

- The indoor drain pipe shall be thermal insulated.
- The connection part between the drain pipe and the indoor unit shall be insulated so as to prevent dew generation.
- The drain pipe shall be slant downwards (greater than 1/100). The middle part shall not be of S type elbow, otherwise abnormal sound will be produced.
- The horizontal length of the drain pipe shall be less than 20 m. In case of long pipe, supports shall be provided every 1.5 ~ 2m to prevent wavy form.
- Central piping shall be laid out according to the following figure.
- Take care not to apply external force onto the drain pipe connection part.

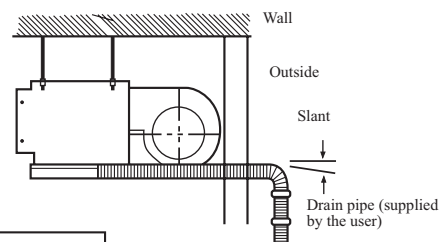
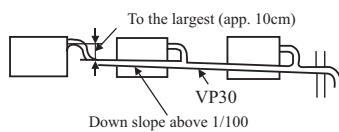
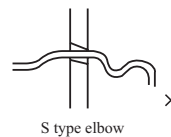
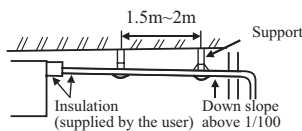

Pipe and insulation material

Pipe	Rigid PVC pipe VP31.5mm (internal diameter)
Insulation	Foamed PE with thickness above 7mm

Hose

Drain pipe size: $\varnothing 19.05\text{mm}^2$ (3/4") PVC pipe

The hose is used for adjusting the off-center and angle of the rigid PVC pipe.

- Directly stretch the hose to install without making any deformation.
- The soft end of the hose must be fastened with a hose clamp.
- Please apply the hose on horizontal part

Insulation treatment:

- Wrap the hose and its clamp until to the indoor unit without any clearance with insulating material, as shown in the figure.

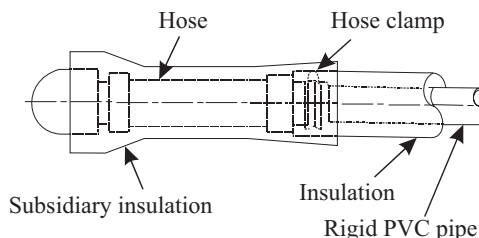

Drain confirmation

During trial run, check that there is no leakage at the pipe connection part during water draining even in winter.

Installation Procedure

Allowable pipe length and drop

These parameters differ according to the outdoor unit. See the instruction manual attached with the outdoor unit for details.

Supplementary refrigerant

The refrigerant supplementation shall be as specified in the installation instructions attached with the outdoor unit. The added refrigerant shall be R22.
The adding procedure shall be aided with a measuring meter for a specified amount of supplemented refrigerant

Requirement

Overfilling or underfilling of refrigerant will cause compressor fault. The amount of the added refrigerant shall be as specified in the instructions.

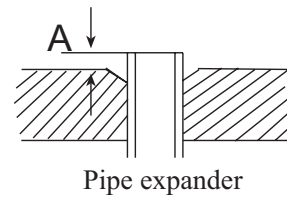

Connection of refrigerant pipe

Conduct flared connection work to connect all refrigerant pipes.

Pipe cutting and expanding

If the pipe is too long or the flare is damaged, it needs to be cut or expanded.

1. Pipe cutting
2. Removing burrs
3. Insertion nut
4. Pipe expansion

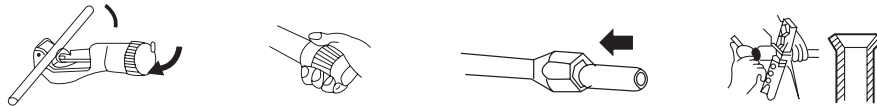

Pipe expansion dimensions as follows:

Pipe diameter \ddot{y}	Size A (mm)
6.35 mm (1/4")	0.8 ~ 1.5
9.52 mm (3/8")	1.0 ~ 1.8
12.7 mm (1/2")	1.2 ~ 2.0
15.88 mm (5/8")	1.4 ~ 2.2

Correct	Incorrect				
	Slope	Damage	Bur	Partial	Overlong

- The connection of indoor unit pipes must use double spanners.
- The installing torque shall be as given in the following table.

Connecting pipe O.D.(mm)	Installing torque (N-m)	Increased installing torque (N-m)
\ddot{y} 6.35	11.8 (1.2kgf-m)	13.7 (1.4 kgf-m)
\ddot{y} 9.52	24.5 (2.5kgf-m)	29.4 (3.0 kgf-m)
\ddot{y} 12.70	49.0 (5.0 kgf-m)	53.9 (5.5 kgf-m)
\ddot{y} 15.88	78.4 (8.0 kgf-m)	98.0 (10.0 kgf-m)

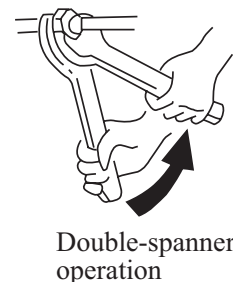

Installation Procedure

Vacuum pumping

With a vacuum pump, create vacuum from the stop valve of the outdoor unit.

- 1 Emptying with refrigerant sealed in the outdoor unit is absolutely forbidden.

Open all valves

Open all the valves on the outdoor unit.

Gas leakage detection

Check with a leakage detector or soap water that if there is gas leakage at the pipe connections and bonnets.

Insulation treatment

Conduct insulation treatment on both the gas side and liquid side of pipes respectively. During cooling operation, both the liquid and gas sides are cold and thus shall be insulated so as to avoid dew generation.

- 1 The insulating material at gas side shall be resistant to a temperature above 120*.
- 1 The indoor unit pipe connection part shall be insulated.

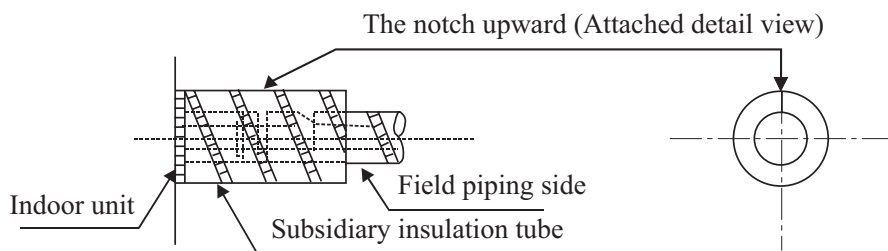



Installation Check and Trial Run

Check if the drain pipe and connection wires are arranged properly.

The drain pipe shall be put below. The connection wire shall be put above. Be sure to wrap the drain pipe (especially the indoor part and the part inside the machine) with thermal insulating materials.

The drain pipe shall be made into slope. Avoid bulging up or down or phenomena shown right figure in the run.

Installation check

- Are the power cord and the indoor/outdoor
- Is there any gas leakage at the pipe joints?
- Connection wire connected properly?
- Are the wires pressed firmly?
- Do the supply voltage meet the requirement?
- Is the noise too big?
- Could the drainage water completely discharged to outdoor
- Do the terminal numbers of the indoor/outdoor connection wire coincide with each other?
- Is the pipe connection part thermally insulated?
- Is the indoor unit mounted firmly and reliably?

Trial operation

The installation serviceman must conduct a trial operation and check:

- Does the temperature regulator work normally?
- Does the installation location selection meet the related requirements?

Wrap with the protective plastic tape

Wrap the connection pipe, the drain pipe and the connection wire together with PVC tape.

Caution:

The connection pipe must be wrapped individually with insulating material from down to up.