



# Delfield®

## UC4448N SALAD TOP

### Reduced Height Front-Breathing Self-Contained Compact Salad Top Refrigerators

Project \_\_\_\_\_

Item \_\_\_\_\_

Quantity \_\_\_\_\_

CSI Section 11400

UC4448N REDUCED HEIGHT FRONT-BREATHING SELF-CONTAINED COMPACT SALAD TOP REFRIGERATORS

**MODELS:**
 **UC4448N-8** Two section with doors  
Eight pan capacity

 **UCD4448N-8** Two section with drawers  
Eight pan capacity

 **UC4448N-12** Two section with doors  
Twelve pan capacity

 **UCD4448N-12** Two section with drawers  
Twelve pan capacity
**STANDARD FEATURES**

- Patented air screen ensures product stays cold without drying it out
- All 4400 Series units are 100% front breathing, which allows the unit to be pushed against a wall or built into a cabinet or an existing line up
- Durable, rugged stainless steel sides, top and front
- Features Delfield's exclusive ABS interior (on sides). ABS is extremely durable - it won't dent, chip or corrode and is backed by a limited lifetime warranty
- Delfield supplies 1/6 size pans and adapter bars for top opening
- Salad top refrigerators are standard with 10" wide, dishwasher safe polyethylene cutting board treated with antimicrobial agent
- "D" prefix models feature Delfield's new drawer system. Drawers are backed by a 10-year warranty on the track assembly
- Environmentally friendly R404A refrigerant
- High density foamed in place polyurethane keeps energy costs low
- Black recessed quick grip handle
- Standard on 2" casters for easy cleaning and installation
- 7' cord and plug supplied
- One epoxy coated wire shelf standard, installed per door section
- ACT solid state electronic control
- One year parts and 90 day labor standard warranty.

**OPTIONS AND ACCESSORIES**

- Flat lift off cover
  - 18" wide single tier overshelf
  - Stainless steel finish on back
  - Plastic laminate on front
  - Additional wire shelves
  - Door lock
  - Exterior thermometer
  - Glass door(s)
  - \*220V/50 Hertz electrical system
- \*Inclusion of this option will alter electrical specifications of the unit.



Model UC4448N-12

**SPECIFICATIONS**

**Exterior top** is one-piece 22-gauge stainless steel with integral 2.12" (5.1cm) square nosing on the front. Top has openings to accept 8 or 12 1/6-size 4" - 6" (10.1cm - 15.2cm) deep plastic pans. Adapter bars and 1/6 pans are supplied by Delfield. Lid is constructed of 20-gauge stainless steel. Temperature in top opening to maintain 33°F (1°C) to 41°F (5°C), with pans recessed 2.5" (6.4cm) at 86°F ambient room temperature, meeting NSF 7 requirements. One 48" x 10" x .5" (121.9cm x 25.4cm x 1.3cm) polyethylene cutting board treated with antimicrobial agent is mounted on the top at the front edge.

**Exterior back and bottom** are two-piece 24-gauge galvanized steel. Exterior ends are stainless steel.

**Interior sides** are thermoformed ABS plastic with integral shelf supports. Base is fully insulated with high-density foamed in place polyurethane.

**Refrigeration system** uses HFC-404A refrigerant. Compressor is 1/5 H.P., with condenser coil and hot gas condensate evaporator mounted on rear of the cabinet. Evaporator coils are located on the interior rear wall of the cabinet. Refrigerant flow is controlled by a capillary tube. Cabinet maintains an interior cabinet temperature of 36°F to 40°F (2°C to 4°C).

**ACT control.** ACT electronic, solid state control, mounted on the exterior rear of the cabinet, allows unit to maintain precise temperatures in heavy duty conditions.

**Electrical connections** are 115 volt, 60 Hertz, single phase. Unit has a 7' (2.1m) long electrical cord and NEMA 5-15P plug.

**Casters:** Equipment is mounted on 2" (5.08cm) diameter front locking plate casters. 2.5" (6.35cm) ride height.

**Doors** have a 24-gauge stainless steel exterior, with thermoformed ABS plastic interior liner. Cabinet of door models has one adjustable epoxy-coated wire shelf.

**Drawers** have a 24-gauge stainless steel exterior with thermoformed ABS plastic interior liner. Drawer frames are 12-gauge stainless steel. Drawer slides are 11-gauge stainless steel with Delrin bearings. Each top drawer holds one full size 12" x 20 (30.5cm x 50.8cm) pan and three 1/9 size pans 4" - 6" (10.2cm - 15.2cm) deep. Each bottom drawer holds one 12" x 20 (30.5cm x 50.8cm) pan and three 1/9 size pans 4" (10.2cm) deep. Pans are supplied by others.



980 S. Isabella Road  
Mt. Pleasant, MI 48858  
www.delfield.com

Phone: 800-733-8948  
Fax: 800-669-0619  
Email: info@delfield.com

Approval \_\_\_\_\_

Date \_\_\_\_\_

# UC4448N Reduced Height Front-Breathing Self-Contained Compact Salad Top Refrigerators

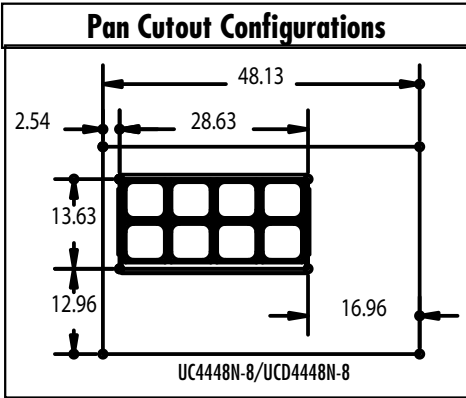

**INSTALLATION NOTE:**  
 Refrigeration system is designed so that air will flow under the unit, through the compressor area and out the front of the unit. Any restriction to this air flow path will void the warranties.

**PLEASE NOTE:**  
 Air flow through the louver on the back of the unit is not necessary for operation, however, any air which passes through the louver is beneficial.

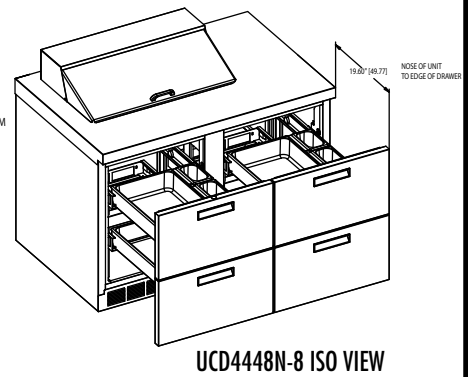
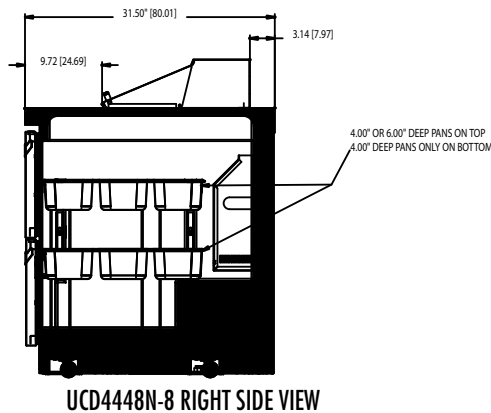
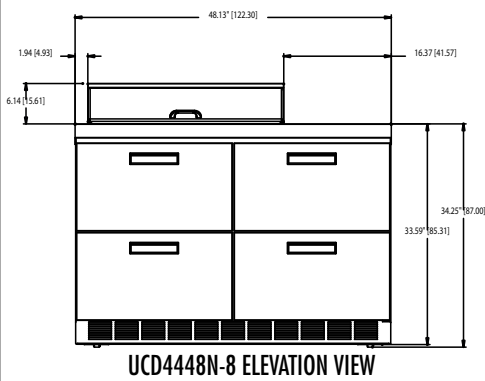
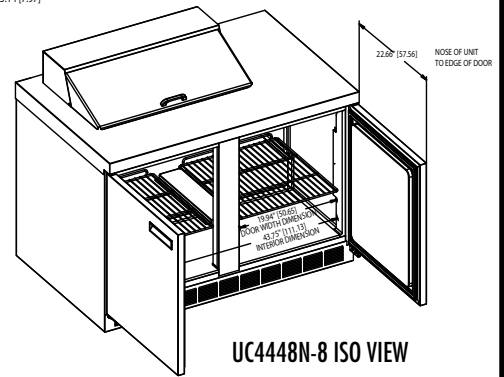
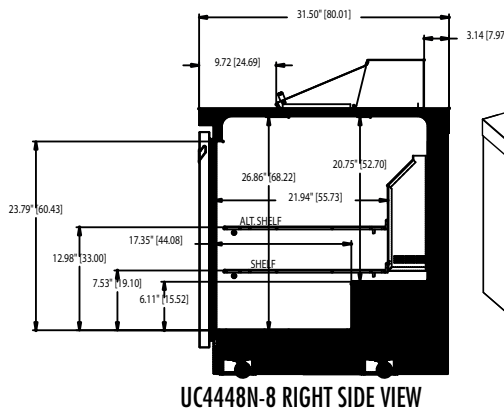
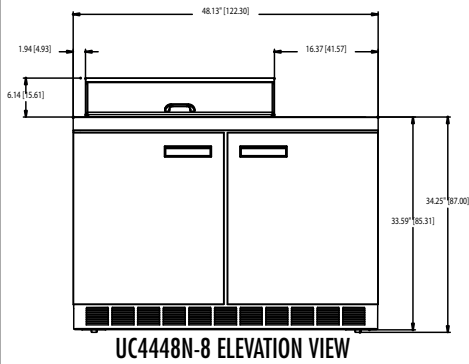

# UC4448N Reduced Height Front-Breathing Self-Contained Compact Salad Top Refrigerators

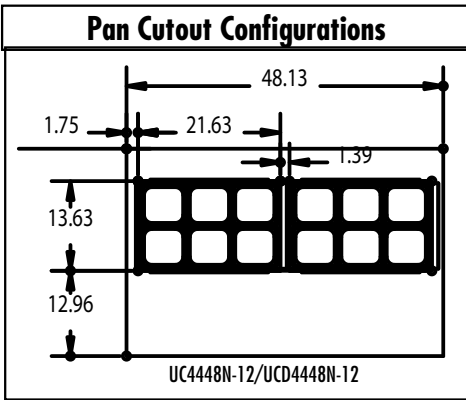

**INSTALLATION NOTE:**  
 Refrigeration system is designed so that air will flow under the unit, through the compressor area and out the front of the unit. Any restriction to this air flow path will void the warranties.

**PLEASE NOTE:**  
 Air flow through the louver on the back of the unit is not necessary for operation, however, any air which passes through the louver is beneficial.

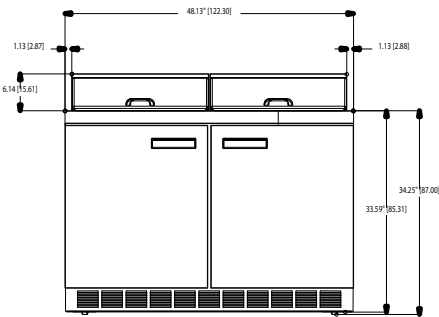

UC4448N-12 ELEVATION VIEW

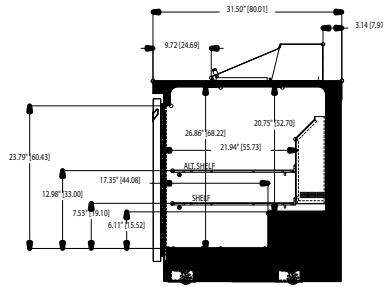

UC4448N-12 RIGHT SIDE VIEW

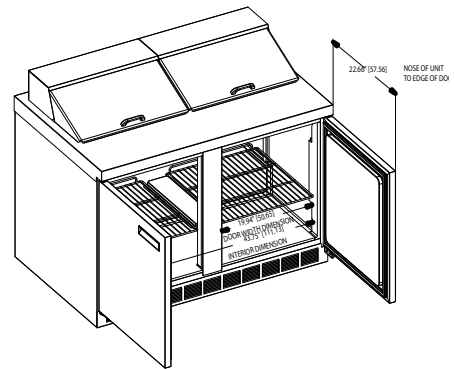

UC4448N-12 ISO VIEW

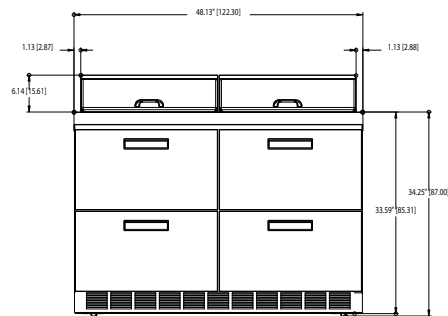

UCD4448N-12 ELEVATION VIEW

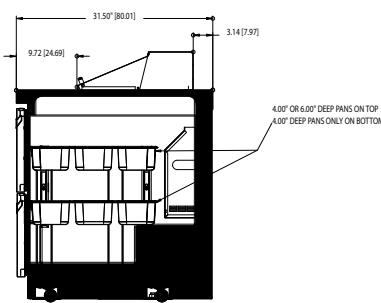

UCD4448N-12 RIGHT SIDE VIEW

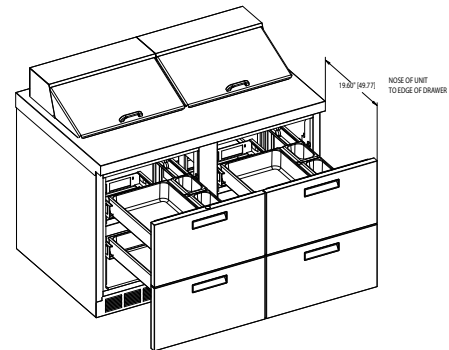

UCD4448N-12 ISO VIEW

## Mechanical Data - Standard Unit

MODEL NUMBER	1/6 SIZE PAN CAPACITY	# OF SHELVES	SHELF AREA SQ.FT.	STORAGE CAP. CU.FT.	H.P.	VOLTS/HERTZ/PHASE	AMPS	NEMA PLUG	SHIP WEIGHT
UC4448N-8	8	2	4.53	10.7	1/5	115/60/1	7.2	5-15P	320LBS./145KG.
UCD4448N-8	8	NA	NA	2.7	1/5	115/60/1	7.2	5-15P	395LBS./179KG.
UC4448N-12	12	2	4.53	10.7	1/5	115/60/1	7.2	5-15P	320LBS./145KG.
UCD4448N-12	12	NA	NA	2.7	1/5	115/60/1	7.2	5-15P	395LBS./179KG.



980 S. Isabella Road  
Mt. Pleasant, MI 48858  
[www.delfield.com](http://www.delfield.com)

Phone: 800-733-8948  
Fax: 800-669-0619  
Email: [info@delfield.com](mailto:info@delfield.com)

Printed in the USA.  
10/08  
DSUC4448N-S