

clarion CDC635/RDC635/RDC634 Owner's manual

6 DISC CD CHANGER

C-BUS OPTICAL DIGITAL OUTPUT (CDC635/RDC635 only)
 2 TIMES OVERSAMPLING DIGITAL FILTER / DUAL 1 BIT DAC

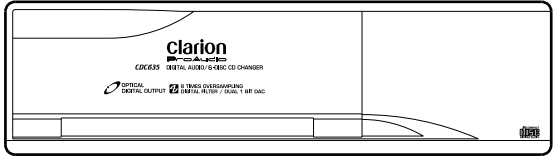

Thank you for purchasing the CDC635/RDC635/RDC634 system. The CDC635/RDC635/RDC634 is designed incorporating the latest digital technologies, while featuring a newly developed CD mechanism to achieve excellent performance and good reliability. **Please read this owner's manual entirely before proceeding with installation.**

1. PRECAUTIONS

1. Please read this manual carefully before installing the unit.
2. Make sure all of the mounting hardware is complete before you install the CDC635/RDC635/RDC634.
3. It is recommended that you remove the negative (-) terminal from the car battery before you install the CDC635/RDC635/RDC634. This will prevent accidental short circuiting installation.
4. Do not open CDC635/RDC635/RDC634 cases. There are no user serviceable parts inside. If you drop anything into the unit during installation, consult your nearest CLARION dealer or an authorized CLARION service center.
5. Never clean the surface of your CDC635/RDC635/RDC634 with chemical solvents, as they could damage the finish. Use a clean dry cloth.
6. If the car is parked for a long time in the sun during summer or in a cold location during winter, the temperature inside the car will reach extreme levels. As the unit may not function properly in such a case, use it only after the ambient temperature has returned to normal.

CAUTION:

This equipment has been tested and found to comply with the limits for a Class B digital device, pursuant to Part 15 of the FCC Rules. These limits are designed to provide reasonable protection against harmful interference in a residential installation. This equipment generates uses, and can radiate radio frequency energy and, if not installed and used in accordance with the instructions, may cause harmful interference to radio communications. However, there is no guarantee that interference will not occur in a particular installation. If this equipment does cause harmful interference to radio or television reception, which can be determined by turning the equipment off and on, the user is encouraged to consult the dealer or an experienced radio/TV technician for help.

USE OF CONTROLS, ADJUSTMENTS, OR PERFORMANCE OF PROCEDURES OTHER THAN THOSE SPECIFIED HEREIN, MAY RESULT IN HAZARDOUS RADIATION EXPOSURE. THE COMPACT DISC PLAYER SHOULD NOT BE ADJUSTED OR REPAIRED BY ANYONE EXCEPT PROPERLY QUALIFIED SERVICE PERSONNEL.

CHANGES OR MODIFICATIONS NOT EXPRESSLY APPROVED BY THE MANUFACTURER FOR COMPLIANCE COULD VOID THE USER'S AUTHORITY TO OPERATE THE EQUIPMENT.

INFORMATION FOR USERS:

CHANGES OR MODIFICATIONS TO THIS PRODUCT NOT APPROVED BY THE MANUFACTURER WILL VOID THE WARRANTY AND WILL VIOLATE FCC APPROVAL.

Bottom View of CD Changer Unit

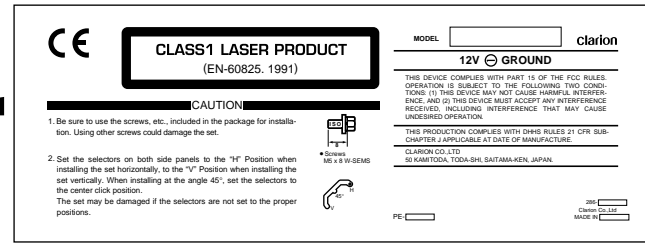
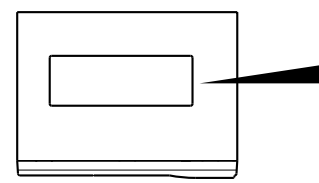

2. IDENTIFICATION OF PARTS

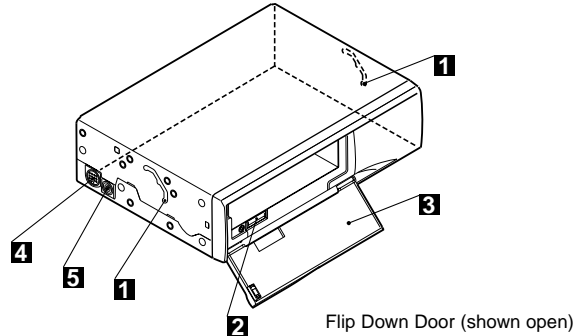

- 1 Installation selector levers
- 2 Eject button
Press the eject button for ejecting the magazine.
- 3 Flip down door
- 4 C-BUS terminal (13 pin)
- 5 Optical digital output terminal (CDC635/RDC635 only)

3. WIRE CONNECTION

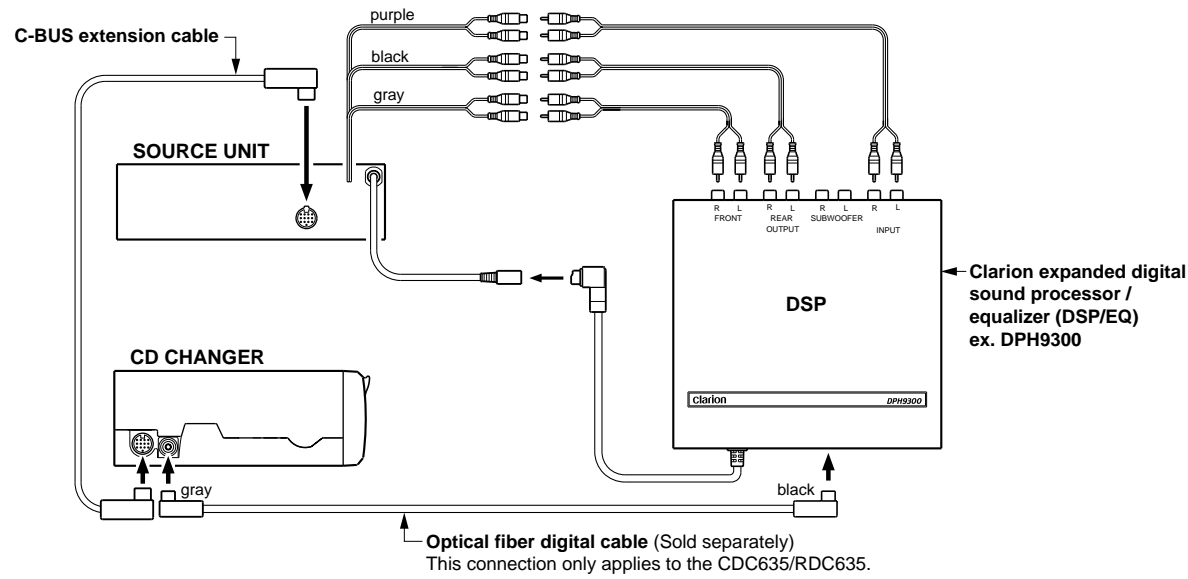

4. CD MAGAZINE

■ INSERTING THE CD

1. Turn the magazine over to its rear, put your finger on the disc holder release knob and draw out the disc holder. (Fig. 1)

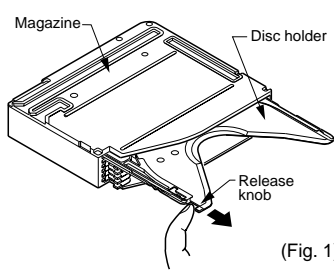

2. Line up the CD with the groove of the disc holder. Make sure the label on the CD faces downwards. (Fig. 2)

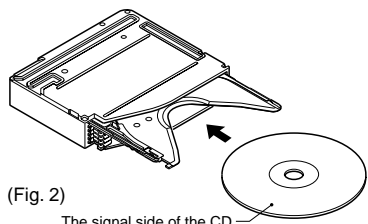

3. Press in on the disc holder until it locks securely into the magazine.

CAUTION

The disc holder may come completely out of the magazine if you pull too hard on the disc holder. If the disc holder should come completely out, reinsert it into the magazine correctly while pressing on the lever.

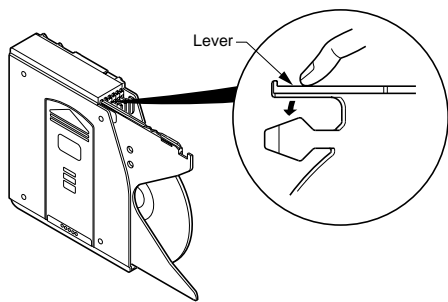

Note:
Be sure you insert the disc holder evenly and at the same level as the magazine.

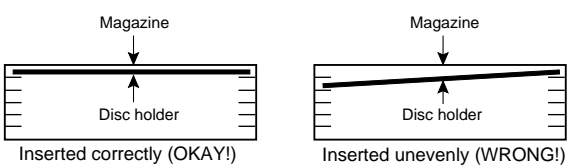

■ EXTRACTING THE CD

Take out the CD after pulling out the disc holder.

Note:
When taking out the CD do not let your fingers touch the signal side of the CD.

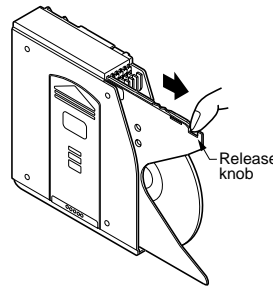

■ INSERTING THE MAGAZINE

1. Open the flip down door 3 outwards.
2. Set the magazine facing up as shown below and insert into the unit with the CD load/unload side on the right. Press the magazine into the unit until it locks securely.

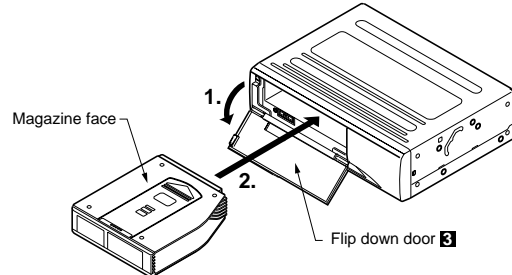

3. Close the flip down door 3.

CAUTION

Dust and other objects can cause malfunctions if they get into the unit. Always be sure to shut the flip down door once finished with loading or unloading the magazine.

■ EXTRACTING THE MAGAZINE

1. Open the flip down door 3 outwards.
2. Press the eject button 2 and take out the magazine.

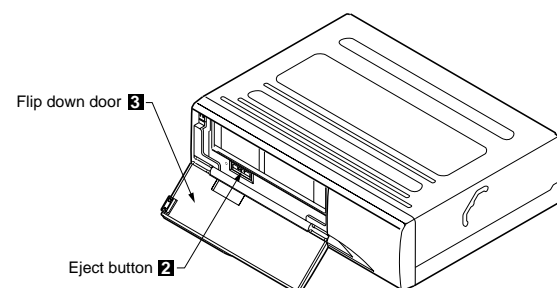

5. INSTALLATION

1. In order to prevent short circuits during installation, the negative (-) terminal of the battery must be disconnected prior to installation.

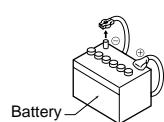

2. Give consideration to safety and easy handling when deciding on the installation place. Avoid the following places:

- A place which hampers driving.
- A place where the safety of the passengers is compromised during an emergency brake situation.

- A place which is exposed to direct sunlight or the hot air from the heater.
- A place which is exposed to rain or which comes into contact with water.

3. Only the provided screws and brackets should be used during installation. Using screws other than those specified will cause damage.

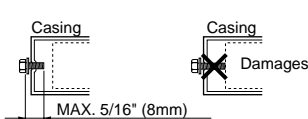

4. Before installation, check that there is no harness hidden behind any panels before drilling any holes.

5-1. Installation of connectors

1. When handling the cord, take the following precautionary measures:
 - Avoid places that heat up such as the engine, the exhaust pipe and the heater vent.
 - Keep it separate from the car's own coiled and connected cords.
 - Take care not to place it across the burr edge of the metal sheet.
2. To ensure reliable cable connections make sure that the C-BUS extension cable (13 pin) or the optical fiber digital cable (CDC635/RDC635 only) are fully inserted. After connecting the cable, fasten it in place with lead clamps.

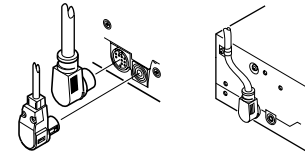

3. When removing the optical fiber digital cable, grip the slide cap (gray color part of the unit) and then pull gently. (CDC635/RDC635 only)

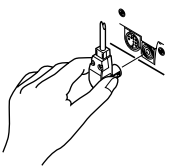

4. Do not coil up the optical fiber digital cable with a radius of less than 1" (3cm). With a radius of less than 1", the performance of the cable will be greatly impaired.
5. After connecting, use the lead clamp or tape to secure the cable.

5-2. Installation of CD Changer Unit

■ Prior to Installation

- 1) Before attempting to use this unit you must first remove the packing safety lock screws (3 positions) with a screwdriver. Store these lock screws carefully so they can be used again if needed.

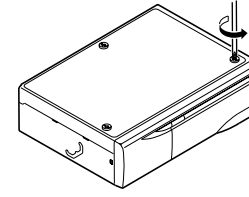

Note:
Reinstall these lock screws when shipping the unit back for repair.

- 2) Decide on the installation place and direction.
- 3) Adjust the installation selector levers 1 to the desired installation position.

* During shipment from the factory, the levers are placed in a horizontal position.

- #### ■ Switching the Installation Selection Lever 1
- Insert an item such as a screwdriver with a fine point or the tip of a ballpoint pen into the round hole of the installation selector lever 1 to switch to the position you need.

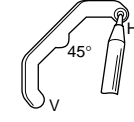

■ After Setting the Installation Selector Levers

- After setting the installation selector levers 1 at both places, use the attached label to close up the adjustment holes.

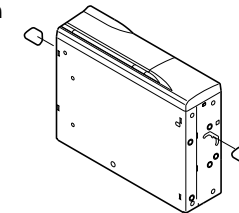

H: Horizontal	45: Slope	V: Vertical
Align the installation selector levers 1 on both sides of the unit with the "H" position.	Align the installation selector levers 1 on both sides of the unit with the "45°" position.	Align the installation selector levers 1 on both sides of the unit with the "V" position.

CAUTION

- Set the installation selector levers to the same position on both sides.
- When the unit is installed below the horizontal position (up to 15 degrees) the ejected magazine, when left in that position, will drop due to vibrations from the car.
- Adjust the installation selector levers into the correct locations. Setting the locations incorrectly or in varied positions will cause skipping.
- Do not move the installation selector levers while the unit is in use. This will cause damage to the mechanism and the disc.

5-3. Installation Procedure

1. Use the double seamed hexagonal bolts to fix the lead clamp and installation bracket to the unit (on both sides) in the desired direction of installation.

- Vertical Position
- Horizontal Position and Suspending Position

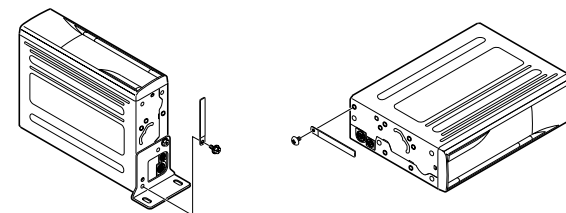

- * For horizontal or suspending installation, use the attached installation screw to fix the lead clamp.

2. Use the wing nut to hold in place the installation bracket with bolt to the installation bracket, which is attached to the unit. Then affix the cushion rubber.

- Vertical Position
- Horizontal Position
- Suspending Position

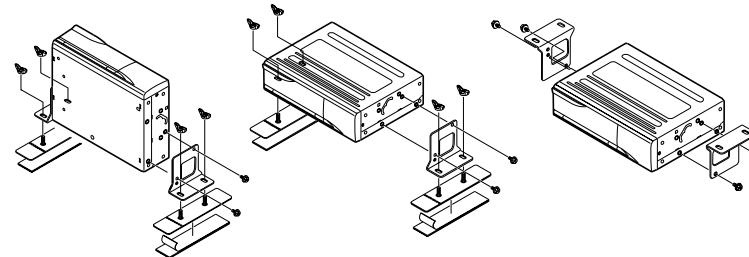

3. Remove the floor carpet and decide on the place to install. Adjust the installation bracket with bolts to suit the place of installation.

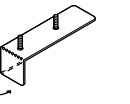

- * The installation bracket with bolt may be broken off if it is bent many times at the perforated line.

4. Remove the separator of the cushion rubber that is attached to the installation bracket with bolt and install accordingly.

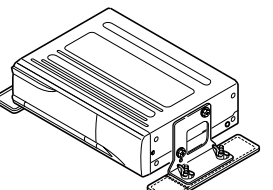

5. Unfasten the wing nut and remove the unit.

6. Return the floor carpet to its original place. Use a knife to cut into the carpet where the bolt can be felt, and allow the bolt to protrude from the carpet.

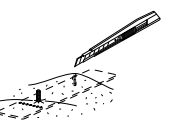

7. Align the unit with the bolts and secure it with the wing nuts.

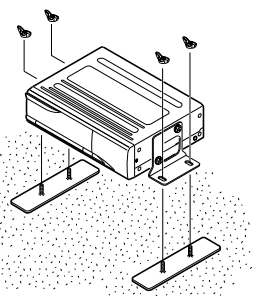

6. CAUTIONS

1. For safety reasons, install the magazine only when the car is stationary. To prevent accidents, it is best that the volume inside the car does not exceed that of the outside.
2. Use a soft dry cloth to clean the unit. Do not use abrasive pads, benzene, thinners or alcohol. For stubborn dirt, use a soft cloth, lightly moistened with (warm) water and wipe gently.
3. At the recess end of the flip down door lies the built-in pick up which is the core part of the player. If dust or dirt comes into contact with this core part it will cause damage to the unit. Therefore, do not leave the flip down door open for long periods of time.

- If the unit is played immediately after switching on the heater when the inside of the car is extremely cold, the discs and the pick up will fog up. If this happens, the unit may not work normally. (Condensation)
Use a soft cloth to wipe the disc when it fogs up. The fog will naturally disappear in about one hour and thereafter the disc will work normally again.
- 4. While the system is in play, do not plug or unplug the cables as this will cause damage.
- 5. Do not expose the magazine to direct sunlight, the car heater or other sources of strong heat.

7. TROUBLESHOOTING

Symptom	Cause	Remedy
Loss of power	Bad connection	Check connections.
Magazine cannot be loaded	Magazine inserted wrongly A magazine is already in the player. Distorted magazine	Insert correctly. Eject the magazine and insert the other. Buy New Magazine CAA-355.
"No Disc" sign appears when searching for discs.	Disc inserted upside-down Moisture or dirt on disc	Read the section on "INSERTING THE CD" carefully and reinsert the CD correctly. Wipe disc free of moisture and dirt.
Noise, skipping	The installation selector levers are set to different positions on both sides. The unit installation direction and the installation selector lever positions do not match. Disc bent or badly damaged Disc is very dirty	Set the installation selector levers to the same position on both sides. Set the unit installation direction and the installation selector lever positions to match each other. When installed at an angle, change the installation selector lever to a position (H,45°) not prone to noise or sound loss. Compare with another disc. If bad, discard the damaged disc. Clean the disc.
Mechanism does not function.	Mechanical error	① Referring to section "INSTALLATION", check the three angle of installation selector levers are properly set. If not, set them at the proper position for the angle of installation. ② Check whether the CD magazine can be ejected by pressing eject button, then insert a new CD magazine.
Magazine is ejected even when inserted into the unit.	Disc holder is not correctly inserted into the magazine.	Read the section on "INSERTING THE CD" carefully and reinsert the disc holder correctly.

8. SPECIFICATIONS

Sampling Frequency: 44.1 kHz
 Frequency Response: 5Hz ~ 20kHz (± 1dB)
 Signal to Noise Ratio: 105dB (1kHz) IHF-A
 Wow and Flutter: Below measurement limits
 Power Supply: DC14.4V (10.8 ~ 15.6V)
 negative ground
 Current Consumption: Less than 1A
 Weight: 3.8 lb. (1.7 kg)

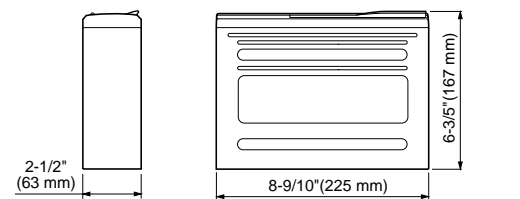

*Due to improvements, the design and these specifications may be modified without prior notice.

9. HANDLING COMPACT DISCS

1. When the inside of the car is very cold and the player is used soon after switching on the heater, dew may form on the disc or the optical parts of the player and proper playback may not be possible. If dew forms on the disc, wipe it with a soft cloth. If dew forms on the optical parts of the player, do not use the player for about one hour and the condensation will disappear naturally to allow normal operation.
2. Driving on bumpy roads which cause severe vibration may cause the sound to skip.

This unit has been designed specifically for reproduction of compact discs bearing the mark. No other discs can be played.

To remove the compact disc from its storage case, press down on the centre of the case and lift the disc out, holding it carefully by the edges.

To remove fingerprints and dust, use a soft cloth, and wipe in a straight motion from the centre of the compact disc to the outside.

New discs may have some roughness around the edge. The set may not work or the sound may skip if such discs are used. Use a ball-point pen, etc., to remove roughness from the edge of the disc.

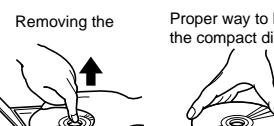

Always handle the compact disc by the edges. Never touch the surface.

Note on Compact Discs

Never stick labels on the surface of the compact disc or mark the surface with a pencil or pen.

Do not use any solvents such as commercially available cleaners, anti-static spray, or thinner to clean compact discs.

Do not use compact discs that have large scratches, are misshaped, cracked, etc. Use of such discs will cause misoperation or damage.

Do not expose compact discs to direct sunlight or any heat source.

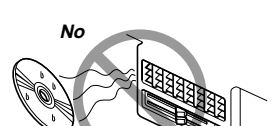
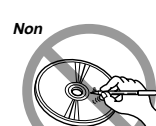

Note:

Do not use commercially available CD protection sheets or discs equipped with stabilizers, etc. These may get caught in the internal mechanism and damage the disc.