

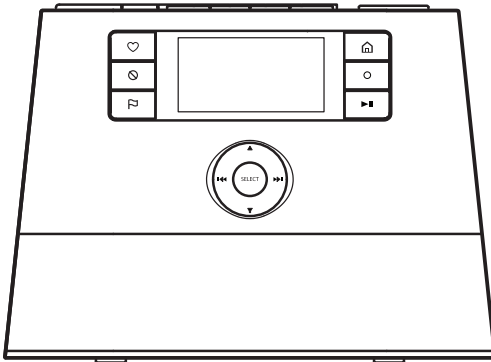

ARIR201



It is important to read this user manual prior to using your new product for the first time.

IMPORTANT SAFETY INSTRUCTIONS

PLEASE READ AND SAVE FOR FUTURE REFERENCE

 <p>THE LIGHTNING FLASH AND ARROWHEAD WITHIN THE TRIANGLE IS A WARNING SIGN ALERTING YOU OF "DANGEROUS VOLTAGE" INSIDE THE PRODUCT.</p>	CAUTION RISK OF ELECTRIC SHOCK DO NOT OPEN CAUTION: TO REDUCE THE RISK OF ELECTRIC SHOCK, DO NOT REMOVE COVER (OR BACK). NO USER-SERVICEABLE PARTS INSIDE. REFER SERVICING TO QUALIFIED SERVICE PERSONNEL.	 <p>THE EXCLAMATION POINT WITHIN THE TRIANGLE IS A WARNING SIGN ALERTING YOU OF IMPORTANT INSTRUCTIONS ACCOMPANYING THE PRODUCT.</p>
SEE MARKING ON BOTTOM / BACK OF PRODUCT		

WARNING: TO PREVENT FIRE OR ELECTRICAL SHOCK HAZARD, DO NOT EXPOSE THIS PRODUCT TO RAIN OR MOISTURE.

Some of the following information may not apply to your particular product; however, as with any electronic product, precautions should be observed during handling and use.

- Read these instructions.
- Keep these instructions.
- Heed all warnings.
- Follow all instructions.
- Do not use this apparatus near water.
- Clean only with dry cloth.
- Do not block any ventilation openings. Install in accordance with the manufacturer's instructions.
- Do not install near any heat sources such as radiators, heat registers, stoves, or other apparatus (including amplifiers) that produce heat.
- Protect the power cord from being walked on or pinched particularly at plugs, convenience receptacles, and the point where they exit from the apparatus.
- Only use attachments/accessories specified by the manufacturer.
- Use only with the cart, stand, tripod, bracket, or table specified by the manufacturer, or sold with the apparatus. When a cart is used, use caution when moving the cart/apparatus combination to avoid injury from tip-over.
- Unplug this apparatus during lightning storms or when unused for long periods of time.
- Refer all servicing to qualified service personnel. Servicing is required when the apparatus has been damaged in any way,



Portable Cart Warning

such as power-supply cord or plug is damaged, liquid has been spilled or objects have fallen into the apparatus, the apparatus has been exposed to rain or moisture, does not operate normally, or has been dropped.

ADDITIONAL SAFETY INFORMATION

- The AC/DC adapter supplied with this product is intended to be correctly oriented in a vertical or floor mount position.
- Do not use unauthorized chargers or power adapters. Use only chargers or power adapters that came with your product or that is listed in the user's guide.
- Apparatus shall not be exposed to dripping or splashing and no objects filled with liquids, such as vases, shall be placed on the apparatus.
- Always leave sufficient space around the product for ventilation. Do not place product in or on a bed, rug, in a bookcase or cabinet that may prevent air flow through vent openings.
- Do not place lighted candles, cigarettes, cigars, etc. on the product.
- Care should be taken so that objects do not fall into the product.
- Do not attempt to disassemble the cabinet. This product does not contain customer serviceable components.
- The marking information is located at the bottom of apparatus.
- To be completely disconnect the power input, the AC/DC adaptor of apparatus shall be disconnected from the mains.
- AC/DC adaptor is a disconnect device. The AC/DC adaptor should not be obstructed OR should be easily accessed during intended use.
- The ventilation should not be impeded by covering the ventilation openings with items such as newspaper, table-cloths, curtains etc.
- No naked flame sources such as lighted candle should be placed on the apparatus.
- Attention should be drawn to the environmental aspects of battery disposal.
- The use of apparatus in moderate climates.

Plugging in for power

AC OUTLET POWER SUPPLY:

100 - 240 V ~ 50/60 Hz

Important battery precautions

- Any battery may present a risk of fire, explosion, or chemical burn if abused. Do not try to charge a battery that is not intended to be recharged, do not incinerate, and do not puncture.
- Non-rechargeable batteries, such as alkaline batteries, may leak if left in your product for a long period of time. Remove the batteries from the product if you are not going to use it for a month or more.
- If your product uses more than one battery, do not mix types and make sure they are inserted correctly. Mixing types or inserting incorrectly may cause them to leak.
- Discard any leaky or deformed battery immediately. They may cause skin burns or other personal injury.
- Please help to protect the environment by recycling or disposing of batteries according to federal, state, and local regulations.

WARNING: The battery (battery or batteries or battery pack) shall not be exposed to excessive heat such as sunshine, fire or the like.

Ecology

Help protect the environment - we recommend that you dispose of used batteries by putting them into specially designed receptacles.

Headset safety

To use a headset safely, please keep the following in mind:

- Do not play your headset at a high volume. Hearing experts advise against continuous extended play.
- If you experience ringing in your ears, turn down the volume or stop using the headset.
- Do not use a headset while driving a motorized vehicle or riding a bike. It may cause a traffic hazard and is illegal in many areas.
- Even if your headset is an open-air type designed to let you hear outside sounds, don't turn up the volume so high that can't hear sounds around you.

FCC information

Note: This equipment has been tested and found to comply with the limits for a Class B digital device, pursuant to Part 15 of FCC Rules. These limits are designed to provide reasonable protection against harmful interference in a residential installation. This equipment generates, uses, and can radiate radio frequency energy and, if not installed and used in accordance with the instructions, may cause harmful interference to radio communications.

However, there is no guarantee that interference will not occur in a particular installation. If this equipment does cause harmful interference to radio or television reception, which can be determined by turning the equipment off and on, the user is encouraged to try to correct the interference by one or more of the following measures:

- Reorient or relocate the receiving antenna.
- Increase the separation between the equipment and receiver.
- Connect the equipment into an outlet on a circuit different from that to which the receiver is connected.
- Consult the dealer or an experienced radio/TV technician for help.

Changes or modifications not expressly approved by Audiovox could void the user's authority to operate the equipment.

Contains FCC ID: XB5-UMS5002

Contains IC ID: 8459A-UMS5002

Contents

Important safety instructions		
IMPORTANT SAFETY INSTRUCTIONS.....	1	
Plugging in for power.....	2	
Important battery precautions	2	
Ecology.....	2	
Headset safety	2	
FCC Information.....	3	
Contents	4	
End user license agreement.....	5	
Before you begin		
Unpack the unit	7	
Setup your AR Infinite Radio accounts.....	8	
Optional: Insert AAA batteries in the base of the radio	8	
Optional: For use with a "Wired" connection	9	
Plug in and turn on the radio	9	
Set up the radio	10	
Check IP address.....	12	
Getting the latest firmware and information.....	12	
Frequently asked questions	12	
General controls		
Front and top.....	13	
Rear.....	13	
Turning on or off	14	
Volume control.....	14	
Source selection	14	
Weather forecast.....	14	
Clock and alarm	14	
Using the menus	14	
Clock and alarm		
Accessing the digital clock	16	
Setting the clock.....	16	
Using the alarm clock.....	16	
Sleep mode.....	17	
Slacker Radio*		
Accessing Slacker Radio.....	18	
Listening to Slacker Radio.....	18	
Tag Options	19	
Pandora Radio*		
Accessing Pandora Radio	20	
Logging in to Pandora Radio	20	
Tag Options	21	
System Maintenance.....	21	
Internet Radio		
Accessing Internet Radio.....	22	
Listening to Internet Radio.....	22	
Recording Internet Radio.....	23	
Adding Internet Radio stations.....	23	
MP3tunes		
MP3tunes Locker setup	24	
Accessing MP3tunes mode	24	
Listening to music in MP3tunes Locker	24	
FM/AM Tuner		
FM/AM antenna	25	
Accessing FM/AM Radio	25	
Listening to FM/AM Radio	25	
Recording FM/AM Radio.....	25	
Recordings		
Accessing Recordings.....	26	
Listening to recordings.....	26	
Deleting recordings.....	26	
USB Input		
Accessing USB Input mode	27	
Listening to audio files.....	27	
Weather		
Weather broadcast.....	28	
Emergency Broadcast System alert**	29	
Settings		
Changing radio's settings.....	30	
Account info.....	30	
Display	30	
Network setup.....	30	
Software updates	30	
Weather.....	30	
Advanced settings	30	
More information		
Troubleshooting tips.....	31	
Copyright warning.....	32	
Check for updates	32	
Product registration	32	
Technical specification	32	
Electrical power source.....	32	
Specifications.....	33	
For your records	33	
Warranty information		
12 Month Limited Warranty	34	

*Note that Slacker and Pandora may not be available in all countries, please check availability in your country.

**Emergency Broadcast System alert is not available in all locations.

End user license agreement

This is a copy of the EULA that you need to agree to in order to use this product.



EN

End user license agreement

IMPORTANT: READ CAREFULLY BEFORE DOWNLOADING OR INSTALLING THIS SOFTWARE!

THIS END USER LICENSE AGREEMENT (THIS "EULA") IS A LEGAL AGREEMENT BETWEEN YOU AND AUDIOVOX CORPORATION AND, AS APPLICABLE, ANY AUDIOVOX SUBSIDIARY, AS DEFINED BELOW (COLLECTIVELY "AUDIOVOX"), FOR THE ACOUSTIC RESEARCH® BRAND INTERNET RADIO DEVICE APPLICATION/DRIVER SOFTWARE PROGRAM WHICH MAY INCLUDE ASSOCIATED SOFTWARE COMPONENTS, SOFTWARE LICENSED BY AUDIOVOX FROM THIRD PARTIES ("LICENSORS") AND ASSOCIATED DOCUMENTATION, IF ANY (COLLECTIVELY, THE "PROGRAM"). THIS EULA CONTAINS IMPORTANT LEGAL LIMITATIONS, RESTRICTIONS AND DISCLAIMERS, AND ALSO SPECIFIES THE DURATION OF YOUR LICENSE.

BY INSTALLING THE PROGRAM OR CLICKING ON THE ACCEPTANCE BUTTON OF THE PROGRAM, COPYING OR OTHERWISE USING THE PROGRAM, YOU ACKNOWLEDGE AND AGREE THAT YOU HAVE READ THIS EULA, UNDERSTAND IT, AND AGREE TO BE BOUND BY ITS TERMS AND CONDITIONS. THIS PROGRAM IS PROTECTED BY COPYRIGHT LAWS AND INTERNATIONAL COPYRIGHT TREATIES, AS WELL AS OTHER INTELLECTUAL PROPERTY LAWS AND TREATIES. YOU MAY USE THE PROGRAM ONLY IN ACCORDANCE WITH THIS EULA, AND ANY SUCH USE IS HEREBY UNDERSTOOD TO BE CONDITIONAL UPON YOUR SPECIFIC AGREEMENT TO THE UNMODIFIED TERMS SET FORTH HEREIN. IF YOU DO NOT AGREE WITH ALL OF THE TERMS OF THIS EULA, CLICK ON THE REJECTION BUTTON AND/OR DO NOT INSTALL THE PROGRAM AND/OR DO NOT USE THE PROGRAM.

1. LICENSE

- (a) Under this EULA, you are granted a non-exclusive, non-sublicensable, non-assignable and non-transferable (except as expressly set forth below) license (i) to use and install the Program on a single workstation, and (ii) to make one (1) copy of the Program into any machine-readable form for backup of the Program, provided the copy contains all of the original Program's proprietary notices.
- (b) You may transfer the Program and license to another party only as a part of the Acoustic Research® brand Internet Radio Device (the "Device"), and only if the other party agrees to accept the terms and conditions of this EULA. If you transfer the Program, you must at the same time either transfer all copies to the same party or destroy any copies not transferred.
- (c) The terms of this EULA will govern any software upgrades or updates provided by AUDIOVOX that replace and/or supplement the original Program, unless such upgrade or update is accompanied by separate license terms and conditions in which case the terms of that separate license will govern. You acknowledge and agree that AUDIOVOX may automatically download upgrades or updates to the Program software to your computer in order to update, enhance, and/or further develop the Program.

2. LICENSE RESTRICTIONS

- (a) Except for the licenses expressly granted to you in this EULA, no other licenses or rights are granted or implied.
- (b) You may not (i) make the Program available over a network where it could be used by multiple computers at the same time; (ii) modify, translate, reverse engineer, decompile, disassemble (except to the extent that this restriction is expressly prohibited by law), or create derivative works based upon the Program; (iii) copy the Program, except as

expressly permitted herein; (iv) remove or alter any copyright notices on all copies of the Program; or (v) rent, lease or lend the Program. You agree that you shall only use the Program in a manner that complies with all applicable laws in the jurisdictions in which you use the Program, including, but not limited to, applicable restrictions concerning copyright and other intellectual property rights.

- (c) The Program may contain pre-release code that does not perform at the level of a final code release. In such case, the Program may not operate properly. Updated versions of the Program may be downloaded from www.arinfinteradio.com.
- (d) AUDIOVOX is not obligated to provide support services for the Program.
- (e) The Program is provided with "RESTRICTED RIGHTS". Use, duplication, or disclosure by the U.S. Government is subject to restrictions as set forth in subparagraph (c)(1)(ii) of DFARS 252.227-7013, or FAR 52.227-19, or in FAR 52.227-14 Alt. III, as applicable.

3. TERM AND TERMINATION

- (a) Your license is effective on the date you accept this EULA and remains in effect until this EULA is terminated by either party.
- (b) You may terminate this EULA and the associated license, without any notice or delay, by destroying or permanently erasing the Program and all copies thereof.
- (c) If you fail to comply with any of the terms of this EULA, in whole or part, your license will automatically terminate without notice from AUDIOVOX.
- (d) Upon termination of this EULA and your associated license, you shall cease all use of the Program and destroy or permanently erase the Program and all full or partial copies thereof.

4. WARRANTY DISCLAIMER

THE PROGRAM IS PROVIDED "AS IS" WITHOUT WARRANTY OF ANY KIND, EITHER EXPRESSED OR IMPLIED, INCLUDING, BUT NOT LIMITED TO THE IMPLIED WARRANTIES OF MERCHANTABILITY, FITNESS FOR A PARTICULAR PURPOSE, TITLE OR NON-INFRINGEMENT. THE ENTIRE RISK AS TO THE QUALITY AND PERFORMANCE OF THE PROGRAM IS WITH YOU. SHOULD THE PROGRAM PROVE DEFECTIVE, YOU (AND NOT AUDIOVOX, ITS LICENSORS, SUPPLIERS, OR ITS DEALERS) ASSUME THE ENTIRE COST FOR ALL NECESSARY REPAIR OR CORRECTION.

This exclusion of warranty may not be allowed under some applicable laws. As a result, the above exclusion may not apply to you, and you may have other rights depending on the law that applies to you.

5. OWNERSHIP RIGHTS

All title and intellectual property rights, including but not limited to copyrights, in and to the Program and any copies thereof are owned by AUDIOVOX, its Licensors or its suppliers. All title and intellectual property rights in and to the content which may be accessed through use of the Program is the property of the respective content owner and may be protected by applicable copyright or other intellectual property laws and treaties. This license grants you no rights to use such content. All rights not expressly granted are reserved by AUDIOVOX or its Licensors.

6. LIMITATION OF LIABILITY

- (a) TO THE MAXIMUM EXTENT PERMITTED BY APPLICABLE LAW, IN NO EVENT SHALL AUDIOVOX, ITS LICENSORS, OR ITS DEALERS BE LIABLE FOR ANY SPECIAL, INCIDENTAL, INDIRECT, OR CONSEQUENTIAL DAMAGES WHATSOEVER (INCLUDING, WITHOUT LIMITATION, DAMAGES FOR LOSS OF

PROFITS, BUSINESS INTERRUPTION, CORRUPTION OF FILES, LOSS OF BUSINESS INFORMATION, OR ANY OTHER PECUNIARY LOSS) REGARDLESS OF CAUSE OR FORM OF ACTION, INCLUDING CONTRACT, TORT, OR NEGLIGENCE, ARISING OUT OF YOUR USE OF OR INABILITY TO USE THE PROGRAM, EVEN IF AUDIOVOX HAS BEEN ADVISED OF THE POSSIBILITY OF SUCH DAMAGES. BECAUSE SOME STATES AND JURISDICTIONS DO NOT ALLOW THE EXCLUSION OR LIMITATION OF LIABILITY OF CONSEQUENTIAL OR INCIDENTAL DAMAGES, THE ABOVE LIMITATION MAY NOT APPLY TO YOU.

- (b) YOU ASSUME RESPONSIBILITY FOR THE SELECTION OF THE APPROPRIATE PROGRAM TO ACHIEVE YOUR INTENDED RESULTS, AND FOR THE INSTALLATION, USE, AND RESULTS OBTAINED.

7. WINDOWS MEDIA

This product is protected by certain intellectual property rights of Microsoft. Use or distribution of such technology outside of this product is prohibited without a license from Microsoft.

The software embedded within your Device (the "Device Firmware") contains software licensed from Microsoft that enables you to play Windows Media Audio (WMA) files ("WMA Software"). The WMA Software is licensed to you for use with your Device under the following conditions. By installing and using this version of the Device Firmware, you are agreeing to these conditions. IF YOU DO NOT AGREE TO THE END USER CONDITIONS OF THIS SECTION 7, DO NOT INSTALL OR USE THIS VERSION OF THE DEVICE FIRMWARE.

The WMA Software is protected by copyright and other intellectual property laws. This protection also extends to documentation for the WMA Software, whether in written or electronic form.

GRANT OF LICENSE. The WMA Software is only licensed to you as follows:

You may use this version of the Device Firmware containing the WMA Software only as such use relates to your Device.

You may not reverse engineer, decompile, or disassemble the WMA Software, except and only to the extent that such activity is expressly permitted by applicable law.

You may transfer your right to use the Device Firmware only as part of a sale or transfer of your Device, on the condition that the recipient agrees to the conditions set forth herein. If the version of the Device Firmware that you are transferring is an upgrade, you must also transfer all prior versions of the Device Firmware that you have which include the WMA Software. MICROSOFT IS NOT PROVIDING ANY WARRANTY OF ANY KIND TO YOU FOR THE WMA SOFTWARE, AND MICROSOFT MAKES NO REPRESENTATION CONCERNING THE OPERABILITY OF THE WMA SOFTWARE.

The WMA Software is of U.S. origin. Any export of this version of the Device Firmware must comply with all applicable international and national laws, including the U.S. Export Administration Regulations, that apply to the WMA Software incorporated in the Device Firmware.

8. RealNetworks, Inc.

Portions of this software are included under license from RealNetworks, Inc. Copyright 1995-2007, RealNetworks, Inc. All rights reserved.

The portions of the Program licensed from RealNetworks, Inc. ("RN") are provided AS IS WITHOUT WARRANTY OF ANY KIND. TO THE MAXIMUM EXTENT PERMITTED BY APPLICABLE LAW, RN FURTHER DISCLAIMS ALL WARRANTIES, EXPRESS AND IMPLIED,

INCLUDING WITHOUT LIMITATION ANY IMPLIED WARRANTIES OF MERCHANTABILITY, FITNESS FOR A PARTICULAR PURPOSE, AND NON-INFRINGEMENT. TO THE MAXIMUM EXTENT PERMITTED BY LAW IN NO EVENT SHALL RN BE LIABLE FOR ANY CONSEQUENTIAL, INCIDENTAL, INDIRECT, SPECIAL, PUNITIVE OR OTHER DAMAGES (INCLUDING, WITHOUT LIMITATION, DAMAGES FOR LOSS OF PROFITS). BECAUSE SOME STATES AND JURISDICTIONS DO NOT ALLOW THE EXCLUSION OR LIMITATION OF LIABILITY OF CONSEQUENTIAL OR INCIDENTAL DAMAGES, THE ABOVE LIMITATION MAY NOT APPLY TO YOU.

You may not modify, translate, reverse engineer, decompile, disassemble (except to the extent that this restriction is expressly prohibited by applicable law) or use other means to discover the RN Source Code or otherwise replicate the functionality of the Real Format Client Code.

9. THIRD PARTY SOFTWARE

ANY THIRD PARTY SOFTWARE THAT MAY BE PROVIDED WITH THE PROGRAM IS INCLUDED FOR USE AT YOUR OPTION. IF YOU CHOOSE TO USE SUCH THIRD PARTY SOFTWARE, THEN SUCH USE SHALL BE GOVERNED BY SUCH THIRD PARTY'S LICENSE AGREEMENT, AN ELECTRONIC COPY OF WHICH WILL BE INSTALLED IN THE APPROPRIATE FOLDER ON YOUR COMPUTER UPON INSTALLATION OF THE SOFTWARE. AUDIOVOX IS NOT RESPONSIBLE FOR ANY THIRD PARTY'S SOFTWARE AND SHALL HAVE NO LIABILITY FOR YOUR USE OF THIRD PARTY SOFTWARE.

10. GOVERNING LAW

If you acquired this Device in the United States, this EULA shall be governed and construed in accordance with the laws of the State of New York, U.S.A. without regard to its conflict of laws principles. If you acquired this Device outside the United States or the European Union, then local law may apply.

11. GENERAL TERMS

This EULA can only be modified by a written agreement signed by you and AUDIOVOX, and changes from the terms and conditions of this EULA made in any other manner will be of no effect. If any portion of this EULA shall be held invalid, illegal, or unenforceable, the validity, legality, and enforceability of the remainder of the Agreement shall not in any way be affected or impaired thereby. This EULA is the complete and exclusive statement of the agreement between you and AUDIOVOX, which supersedes all proposals or prior agreements, oral or written, and all other communications between you and AUDIOVOX, relating to the subject matter of this hereof. AUDIOVOX'S Licensors shall be considered third party beneficiaries of this Agreement and shall have the right to enforce the terms herein.

"AUDIOVOX SUBSIDIARY" shall mean any person, corporation, or other organization, domestic or foreign, including but not limited to subsidiaries, that is directly or indirectly controlled by Audiovox Corporation including, but not limited to, Audiovox Consumer Electronics, Inc. and Audiovox Electronics Corporation. For purposes of this definition only, the term "control" means the possession of the power to direct or cause the direction of the management and policies of an entity, whether by ownership of voting stock or partnership interest, by contract, or otherwise, including direct or indirect ownership of at least fifty percent (50%) of the voting interest in the entity in question.

Before you begin

EN

Dear Acoustic Research customer,

Thank you for purchasing the AR Wi-Fi Infinite Radio. This product will let you listen to Slacker™ Radio (where available), Pandora Radio, Internet Radio, MP3tunes, AM/FM tuner, weather forecast and music recorded in the internal memory or a USB device.

To start using your Wi-Fi Infinite Radio, please follow the setup instructions in the following pages.

1. Unpack the unit

You should find the following items in the box:

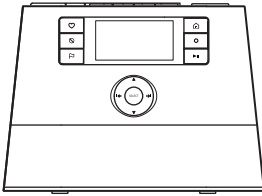

Radio



Power adapter



Ethernet cable



AM loop antenna



Quick Start
Guide

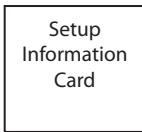

Setup
Information
Card

Additional requirements

- Broadband Internet service
- Broadband (cable/DSL) modem, usually supplied by your Internet service provider
- An 802.11 b or g (Wi-Fi) wireless home network or Ethernet router/switch/hub with available LAN port

For Wi-Fi connections, you may also need:

- Your wireless network's SSID
- Your access password (for secure networks)

- **Exit the DEMO mode after turning on :** Press and release preset **1**, then **SLEEP/SNOOZE**, then preset **6**.
- Note that Slacker and Pandora may not be available in all countries, please check availability in your country.



2. Setup your AR Infinite Radio accounts

To simplify setup on the radio please complete these steps:

- A. Find the Setup Information Card that contains your radio's MAC address number (MAC: 00-21-2A-XX-XX-XX) and activation PIN # (PIN: XXXX). (This number is also found in the Device Info screen under the Settings menu in your radio.)
- B. Using any Internet-connected computer, go to www.arinfiniteradio.com/setup and follow the online instructions.
 - You will need to input your radio's MAC address and PIN # to associate your radio with your personal settings.

3. Optional: Insert AAA batteries in the base of the radio

Follow the polarity markers in the battery compartment. The batteries power the clock and alarm* whenever the radio loses electricity. We recommend that you replace the batteries every year (or more often in case of multiple power outages) to avoid low battery power. Otherwise, clock and alarm accuracy may be affected when electricity supply is interrupted.

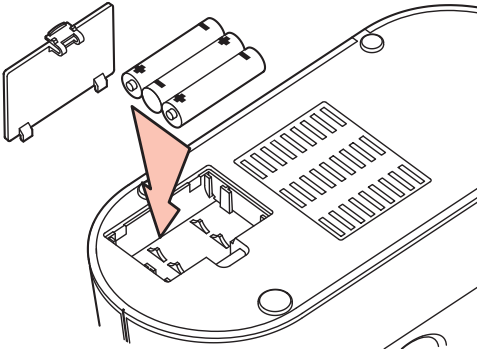

* When the battery backup functions, the clock display will not light. However, the function of alarm still occurs during the power interruption if remaining battery power is adequate.

4. Optional: For use with a "Wired" connection

Use the supplied Ethernet cable if you do not have a wireless (Wi-Fi) access point.

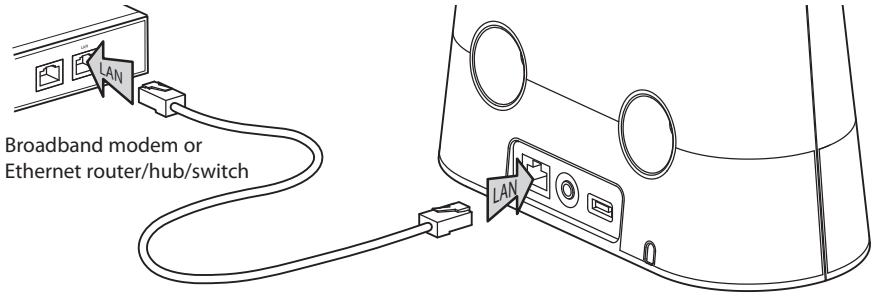

5. Plug in and turn on the radio

Only use the power adapter which is included with your product.



Electrical outlet

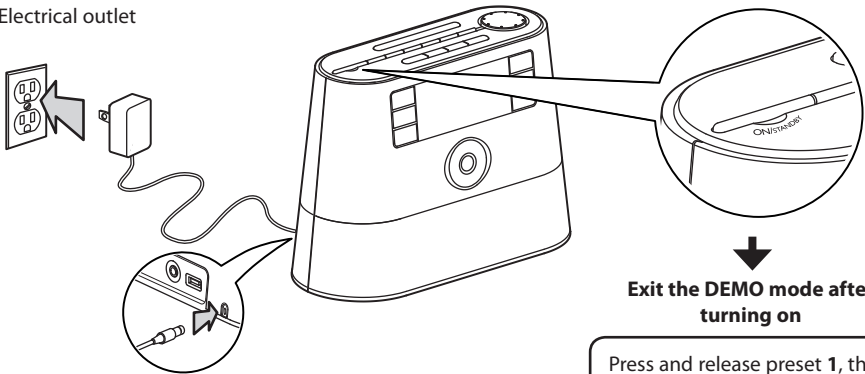

Press and release preset 1, then **SLEEP/SNOOZE**, then preset 6.

6. Set up the radio

Refer to **Using the menus** on page 14-15 for more information on making choices and inputting information in menus.



- A. **NOTE:** When you turn on the radio for the first time, it will be in "DEMO" mode. To exit this mode, press and release preset **1**, then **SLEEP/SNOOZE**, then preset **6** on top of the radio.
- B. After exiting the DEMO mode, the radio displays the **Select Language** screen. Press **▲** or **▼** to choose your language and then press **SELECT**.

DEVICE SETUP
Select Language
English
Français
Español

- C. The **Network Setup** screen displays connection options:

NETWORK SETUP
Wired
Wireless
Connection info

- Select **Wired** to connect using an Ethernet cable. **Go to step D to complete the connection.**
- Select **Wireless** to connect using an existing Wi-Fi access point. **Go to step E to complete the connection.**

D. Wired

This method uses an Ethernet cable shown in step 4 on page 9 to wire the radio directly up to your broadband modem, router, hub, or switch. Make sure your Ethernet cable is properly connected.

- At the **Network Setup** screen, press **▲** or **▼** to select **Wired** and then press **SELECT**.
- Before the connection is complete, the radio may take some time to check for updates and retrieve account info from the server. Please wait until you hear a short congratulations message and "Setup is complete, enjoy the music" is displayed.
- If the radio requires your IP address, you can find this information on your broadband modem, router or access point's administration setup page or manual.

E. Wireless

This method uses your existing Wi-Fi access point, broadband modem or router to connect the radio to your existing network.

You need to know your Wireless Network's name (SSID) and if your wireless network has security enabled, you will also need to know your wireless network password (sometimes called passphrase or key). You can find this information on your broadband modem, router or access point's administration setup page or manual. You may also call your Internet Service Provider (ISP) if you do not know how to access the administration page in order to find this information. They usually have a 1-800 number available. Once you have the below information you may write it down for future reference.

- **Wireless network name (SSID)**
- **Security Type** (Only needed if your network has security enabled and your SSID is hidden, not broadcasted)
- **Password/Key** (Only needed if your network has security enabled)

- At the **Network Setup** screen, press ▲ or ▼ to select **Wireless** and then press **SELECT**. The **Network Setup** screen then shows with three setup options. Press ▲ or ▼ to choose an option and then press **SELECT**.

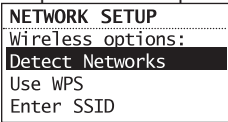

- Detect Networks:** to automatically scan for available networks and display a list of networks to choose from. **Go to step F to complete the connection.**
- Use WPS:** to enter WPS pairing mode. **Go to step G to complete the connection.**
- Enter network SSID:** to manually enter your network information. Select this option if your Network SSID is hidden. **Go to step H to complete the connection.**

- F. If **Detect Networks** is selected, the SSID (network name) of those found will be displayed after searching. Press ▲ or ▼ to select a desired network and then press **SELECT**.

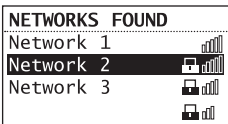

- Signal strength is indicated by ▬▬▬▬.
- Secured network is indicated by (unsecured network has none, as Network 1 in the above example).
- If a secured network is selected, you will be required to enter your password in the **Network Security** screen. The radio should then connect to the Internet. Please wait until you hear a short congratulations message "Setup Complete! Enjoy the music!" and the clock screen is displayed.



- If the network SSID is hidden (not broadcasted), you will only see a padlock icon and signal strength bars like the 4th network shown above. Press ▼ to highlight **Enter SSID** on the display and then press **SELECT**.

Then go to step H to complete your connection.

- Interference may sometimes block your network from showing up in the list. If this happens, press ▼ to show **Refresh List** and then press **SELECT** to try again.
- G. If **Use WPS** is selected, you can select from **Push Button Mode** or **PIN Mode**.

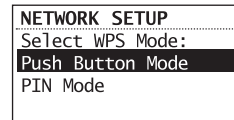

- If **Push Button Mode** is selected, the unit will remind you to press the WPS button on your router. The open WPS device of those found will be displayed after searching. Some routers may timeout the connection in one minute, you may repeat the process again if the connection fail.

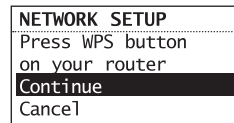

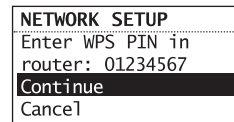

- If **PIN Mode** is selected, the **Network Setup** screen will be displayed and the PIN which required to be entered into the WPS router's settings is shown.

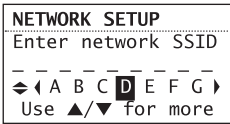

- If the unit is successfully paired up with open WPS router, the radio should then be connected to the Internet. Please wait until you hear a short congratulations message and the clock screen is displayed.

H. If **Enter SSID** is selected, the **Network Setup** screen will be displayed. Enter your SSID.



- If your network is secured (indicated by ) you will be asked to enter your network's security type and password. The radio should then connect to the Internet. Please wait until you hear a short congratulations message and the clock screen is displayed.

About password:

- Do not get your Network Password confused with your Windows or Mac system logon password since they can be different.
- Some wireless access point or routers may call the Wireless Network Password a passphrase or key. These terms are the same.

About passphrase:

- This radio supports secured access points using the Wireless Equivalent Privacy (WEP) keys or Wi-Fi Protected Access (WPA and WPA2) standards.
- WEP keys are either 10 or 26 characters long (characters: 0-9 and A-F) (e.g. 6E78214A52). Note that some Wi-Fi routers support passphrase generation for WEP security. However, there is no industry standard for WEP passphrase generation and this radio does not support WEP passphrases.
- If you are using a WEP secured access point, enter the WEP key (HEX format) instead of the passphrase.

After connecting to the Internet

- If you did not activate your Infinite Radio accounts, or if the radio cannot get your details from the Infinite Radio server, the radio may ask for your country. Input your country.

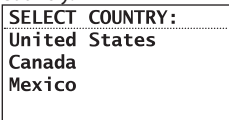

- Input your ZIP code if you select United States.

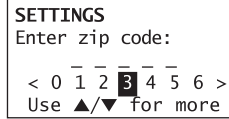

- Input your Postal code if you select Canada.

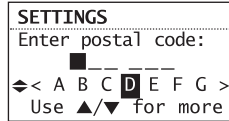



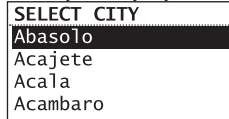



- Select your city if you select Mexico.



The radio should then connect to Internet Radio.

- If your radio has successfully connected to the Internet, a short congratulations message "Setup Complete! Enjoy the music." will be presented.

Check IP address

- Press  to display the Source menu.
- Press  or  to highlight **Settings** and then press **SELECT**.
- Press  or  to highlight **Network Setup** and then press **SELECT**.
- Press  or  to highlight **Connection Info** and then press **SELECT**.

Getting the latest firmware and information

The radio will automatically alert you for upgrade if new firmware is available. You may also go to www.arinfiniteradio.com for the latest firmware and user manual for your radio. Follow the instructions there to download and install files.

Frequently asked questions

For answers to frequently asked questions (FAQ's), go to www.arinfiniteradio.com.

General controls

Front and top

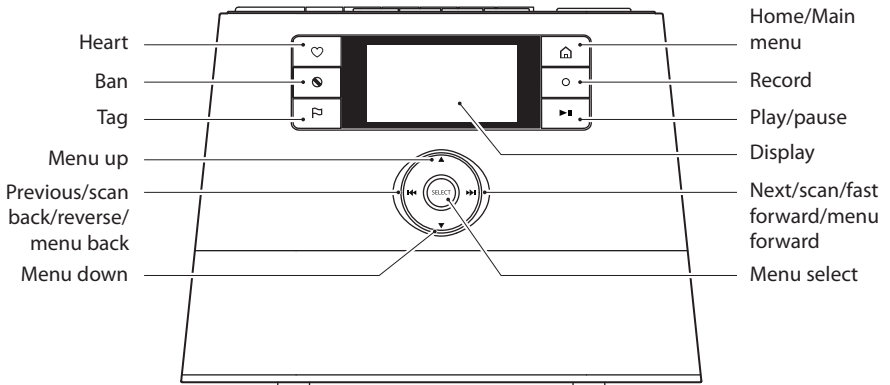
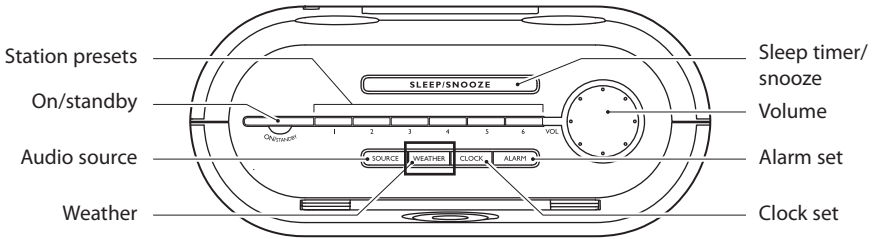

Rear

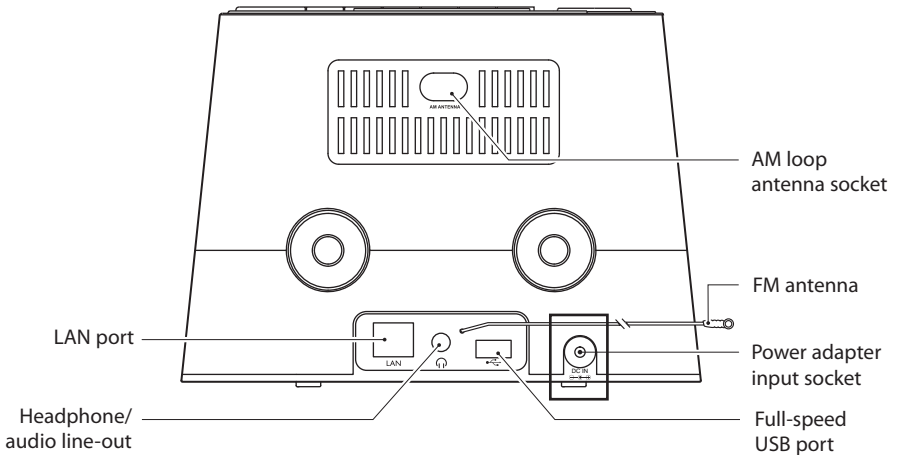

You can connect USB devices to the USB port: The radio can play open MP3, WMA and RealAudio audio files stored on the connected USB device.

Turning on or off

Press **ON/STANDBY** to turn the radio on or off (standby mode).

Volume control

Rotate the **VOL.** knob to adjust the volume.

Source selection

Press **SOURCE** repeatedly to select among the following audio content sources. The selected source will be activated after 1.5 seconds.

- Slacker Radio
- Pandora Radio
- Internet Radio
- MP3tunes
- FM Tuner
- AM Tuner
- Recordings
- USB Input

Weather forecast

Press **WEATHER** to check current and 3-day forecast. Refer to page 28 for more information.

Clock and alarm

- Press **CLOCK** once to show the current time or press and hold to set the clock time.
- Press **ALARM** once. Then press ▲ or ▼ to select activate, deactivate, set the alarm time or set the alarm sound and then press **SELECT**.
- Refer to page 16-17 for more information.

Using the menus

The display window shows the playback screen, browse screen, settings screen, messages etc. What appears on the window varies depending on the function you are using.

To display the Source menu:

- Press **⏏** to display the Source menu for selection of an audio source.



- **Now Playing** – appears at the top of the Source menu when a station is playing. Select this option to return to the play screen.

To navigate in the menus:

- Use the navigation controls to make choices and input information.

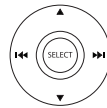

▲	Moves highlight up
▼	Moves highlight down
⏪	Moves selection/navigates left
⏩	Moves selection/navigates right
SELECT	Confirms selected option or character

**To input characters:**

- Some menus require character input (e.g. password, ZIP code).

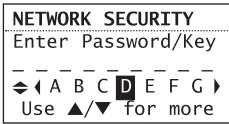

- When inputting characters, press **◀** or **▶** to enter the alpha-numeric characters listed at the bottom of the screen. Press **SELECT** to confirm selections.
- Press **▲** or **▼** to choose among uppercase, lowercase, numeric, special characters or commands.

Character sets (▲ or ▼)	Options (◀ or ▶)
Upper case	A B C D E...X Y Z
Lower case	a b c d e...x y z
Numeric	1 2 3 4 5 6 7 8 9 0
Special	_ - ! @ # \$ % ^ & * . , : () + = [] { } \ / ? < > ' ~
Commands	(read below)

- Commands: press **◀** or **▶** (or **▲** or **▼**) to choose the desired command and then press **SELECT**.

Commands	Actions
DONE	Ends entry
Delete	Deletes highlighted input
Space	Inserts a blank space, characters to the right will move one location over
Back	Moves the highlight back within the entered character without deleting
Next	Moves the highlight forward within the entered character without deleting
Cancel	Exits input screen without changes

To exit the input screen without saving, select the **Cancel** command.

Clock and alarm

Accessing the digital clock

The Wi-Fi Internet Radio also includes a digital clock which will be automatically updated when connected to the Internet.

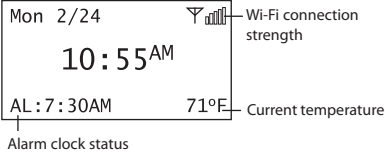

- Press **CLOCK** to show the clock without interrupting audio playback.
- To hide the clock and return the display to the previous screen, press **CLOCK** again.
- The clock is also displayed when the radio is turned off (standby mode).

Setting the clock

With your locale set, the clock time will be automatically updated when connected with the Internet. However, you may still be able to set it manually.

Setting the clock:

1. Press and hold **CLOCK**. Press **▲** or **▼** to select Manual and then press **SELECT**. The hour time is highlighted (reversed color) on the display.

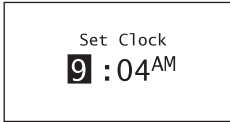

2. Press **▲** or **▼** to select the hour time.
3. Press **▶▶** to shift to minute time.
4. Press **▲** or **▼** to select the minute time.
 - If you have set the clock to 24-hour display mode (refer to page 30), press **SELECT** after setting the minute time and skip steps 5-7.
5. Press **▶▶** to shift to AM/PM.
6. Press **▲** or **▼** to select between AM and PM.
7. Press **SELECT** again to confirm the setting.

You may also adjust the clock time manually and turn off the automatic time update (Auto Sync) when connected with the Internet. Refer to **Advanced Settings** on page 30 for more information.



Using the alarm clock

To set the wake time and sound:

1. Press **ALARM** to show the alarm menu. Then press **▲** or **▼** to highlight **Set Alarm Time** and then press **SELECT**.

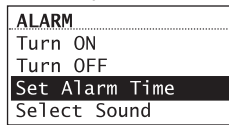

2. The hour time of the alarm clock is highlighted (reversed color) on the display. Press **▲** or **▼** to select the wake hour time.



3. Press **▶▶** to shift to minute time.
4. Press **▲** or **▼** to select the wake minute time.
5. Press **▶▶** to shift to AM/PM.
 - If you have set the clock to 24-hour display mode (refer to page 30), press **SELECT** and then go to step 7.
6. Press **▲** or **▼** to select between AM and PM and then press **SELECT**.
7. Press **▲** or **▼** to highlight **Select Sound** and then press **SELECT**.

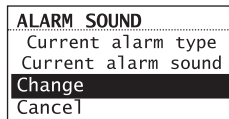
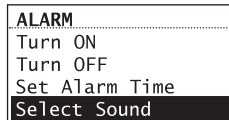

8. Press ▲ or ▼ to highlight one of the sources of wake sound:

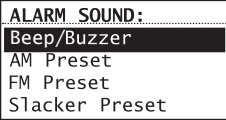

- Beep/Buzzer
- AM Preset
- FM Preset
- Slacker Preset
- Slacker Library (premium account required)
- Pandora Preset
- Internet Preset

Read relevant sections (e.g. Internet Radio) in this user manual to understand how to preset stations.



9. Press **SELECT** on the highlighted source of wake sound and then press ▲ or ▼ to select the desired sound or preset item.
10. Press **SELECT** to confirm the selected item as the wake sound.
- When the radio loses electricity, the alarm clock will be powered by the batteries inserted at the base (refer to page 8). The wake sound selected will be reverted to the default buzzer.
 - When the selected sound is no longer available, the default buzzer will sound.

To set recordings and USB audio files to the alarm clock:

1. Start playback of a recording or a USB audio file. Refer to page 26-27 for more information.
2. Press and press ▲ or ▼ to highlight **Send to Alarm**.
3. Press **SELECT** to confirm.

To activate or deactivate the alarm clock:

1. Press **ALARM**.
2. Press ▲ or ▼ to highlight **Turn On** or **Turn Off** and then press **SELECT**.

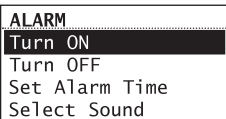

- When the alarm is turned ON, the set alarm time (e.g. AL: 7:00AM) will show in the lower left corner of the clock display.
- When the alarm is turned OFF, "AL: Off" will show on the clock display.

To turn off the alarm clock when it sounds:

- Press **ALARM** or **ON/STANDBY** to turn off the alarm clock. It will sound again on the next day if settings have not been changed.
OR
- Press **SLEEP/SNOOZE** to turn off the alarm clock temporarily for extra sleep time. The alarm will sound again after 10 minutes.
OR
- The alarm clock will turn off automatically after 60 minutes.

Sleep mode

You can set the radio to play for a set length of time before turning off automatically.

1. Press **SLEEP/SNOOZE** to turn on the Sleep mode while listening to the radio. If no source is currently playing, the last tuned source is started.
- The default time is 15 minutes.

Sleep: 15 min

Press again to add more time

2. If necessary, press **SLEEP/SNOOZE** again to add extra sleep time up to 90 minutes. Each press of the button will add 15 minutes, up to 90 minutes, then wraps to zero which turns off the sleep mode. Adding extra sleep time will leave the unit playing the current source.
- The remaining time before turning off automatically will show at bottom right of the clock display, replacing the weather information.
- To cancel the Sleep mode sooner, press **ON/STANDBY** or press **SLEEP/SNOOZE** until "Sleep: Off" is displayed.

Slacker Radio

Slacker Radio is a premium, streaming content provider partner which offers "personalization" through the use of selectable "Heart" and "Ban" buttons. It also uses artist recommendation and related artists to further assist discovery of music and enjoyment of stations.

You can listen to Slacker Radio with an anonymous account for a limited time only with some limited functionality. Register for a FREE account in order to take full advantage of the custom station creation and intelligent song rating system. A premium subscription is also available, but not required. For more information regarding Slacker Radio accounts, please visit www.slacker.com/partners/udiovox.

To use your Slacker account, the account information in the radio (refer to **Account Info** on page 30) must match your Slacker account information online.



Accessing Slacker Radio

- Press **SOURCE** repeatedly to select **Slacker Radio**.
- OR
- Press ▲ or ▼ to highlight **Slacker Radio** in the Source menu and then press **SELECT**.

Listening to Slacker Radio

To select a station (free account users):

1. Press ▲ or ▼ to highlight a station genre and then press **SELECT**.

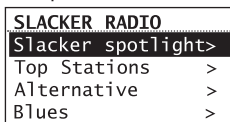

- Some genres may contain sub-genres for selection.
2. While a station is highlighted, press **SELECT**. The selected station will start to play.

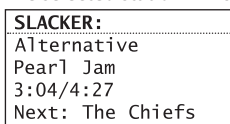

- Press ▶▶ to pause or resume playback.

Pause for Slacker is limited to a short period (e.g. three minutes) due to buffering issues.



3. Press ▶▶ to skip to the next song.
- Free account limits to 6 skips per hour per station.

To select a station

(Slacker Premium account users):

1. Press ▲ or ▼ to highlight **Station** or **Library** and then press **SELECT**.

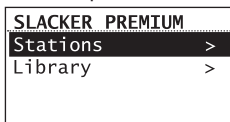

2. When **Station** is selected, press ▲ or ▼ to highlight a station genre and then press **SELECT**.
- When **Library** is selected, press ▲ or ▼ to highlight an artist and then press **SELECT** to further select a song from the selected artist.

**To store the current station as a preset:**

1. Select a station.
2. Press and hold **1, 2, 3, 4, 5** or **6** on top of the radio until a beep sound is heard to store the current station to that preset button.
 - To listen to a preset station, press **1-6**.
 - To edit a preset station, repeat the steps above to overwrite the previously stored station.
 - You can assign a preset station as the wake sound of the alarm, refer to page 17 for more information.

To mark a song as favorite:

Press while listening. The current song will be marked as favorite.

- The will illuminate if the same song is heard next time in the same Slacker station.
- Songs marked as favorites will appear in the playlist more often.
- To unmark the song as favorite, press while the same song is playing.

To create an artist station based on the current artist:

Press and hold while listening. A new artist station will be created using the currently playing artist.

- The new station will be named using the artist's name and the term **Radio**.
- The newly created artist station will begin playback.
- It is also possible to create an artist station by pressing and selecting from the tag menu.

To ban a song in the current station:

Press while listening. The current song will be marked as banned.

To ban an artist in the current station:

Press and hold while listening. The current artist will be marked as banned.

- To further manage your artist stations, unmark the banned songs or banned artists, please login your Slacker account (www.slacker.com) from your PC for advanced station management.
- Marking a song as favorite and creating station are available only to non-anonymous accounts.

Tag Options

Two options are available while you are listening to a Slacker Radio station as you press . Press or to highlight an option in the Tag Options menu and then press **SELECT** to proceed.



- **Create Station**
To create a new station using the currently playing artist as the seed song (this function is the same as pressing and holding while listening).
- **Send to Alarm**
To assign the station in general to be used as the alarm clock wake sound.

Pandora Radio

Pandora Radio is a premium, streaming content provider partner which offers "personalization" through the use of selectable "Thumbs Up" and "Thumbs Down" buttons. It also uses artist recommendation and related artists to further assist discovery of music and enjoyment of stations.

"Subscribers" who pay for their subscriptions do not hear any audio ads, while normal registered (free-account) users hear audio ads in between songs. For more information regarding Pandora Radio accounts, please visit www.pandora.com.

To use your Pandora account, the account information in the radio (refer to **Account Info** on page 30) must match your Pandora account information online.



Accessing Pandora Radio

- Press **SOURCE** repeatedly to select **Pandora Radio**.
- **OR**
- Press **▲** or **▼** to highlight **Pandora Radio** in the Source menu and then press **SELECT**.

Logging in to Pandora Radio

At first attempt to login to Pandora with empty credentials on the unit, the following screen will be displayed:



- Press **▲** or **▼** to select **Yes** if you have an existing account. The unit will then ask you to enter your account login information. Follow the on-screen instructions to complete entering your login information.
- Press **▲** or **▼** to select **No** if you do not have an existing account. The following message will be displayed:



- Press **SELECT** and use the displayed activation code to create your account online.
- Press **SELECT** after done and follow the on-screen instruction to enter your login information.

Note that Pandora may not be available in all countries. "Sorry, Pandora is not available in this country." will be displayed in this case.

Listening to Pandora Radio

To select a station:

1. Press **▲** or **▼** to highlight a station genre and then press **SELECT**.



- Some genres may contain sub-genres for selection.
2. While a station is highlighted, press **SELECT**. The selected station will start to play.

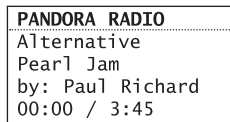

- Press **⏸** to pause or resume playback.

Audio ads cannot be skipped, thumbed up or down, bookmarked or tagged. "Not available for audio ads" will be displayed when attempting any of these.



3. Press **▶▶** to skip to the next song.
- Both free account and premium account limits to approximately 6 skips per hour per station while free account also limits to 12 skips per day. "Our music licenses limit the number of songs skipped per hour" will be shown when the hourly skip limit is reached.

To store the current station as a preset:

1. Select a station.
2. Press and hold **1**, **2**, **3**, **4**, **5** or **6** on top of the radio until a beep sound is heard to store the current station to that preset button.
- To listen to a preset station, press **1-6**.

- To edit a preset station, repeat the steps above to overwrite the previously stored station.
- You can assign a preset station as the wake sound of the alarm, refer to page 17 for more information.

To thumbs up a song:

Press ♥ while listening. The current song will be marked as favorite and the message "Ok, we'll play more songs like this one" will be shown.

- The blue LED will illuminate if the same song is heard next time in the same station.

To further manage your custom stations, unmark the thumbed down songs or thumbed down artists, please login your Pandora account (www.pandora.com) from your PC for advanced station management.



- Songs marked as favorites will appear in the playlist more often. For tracks from shared stations, pressing ♥ will show the message "Not available for this track".
- To unmark the song as favorite, visit www.pandora.com for station management.

To create a custom station based on the current song or artist

1. Press ⏸ to display the options menu.
2. Press ▼ to choose **Create Station**. Press ▲ or ▼ to choose **This Song** or **This Artist** and then press **SELECT**.
3. A new station will be created using the currently song title or artist name.
 - The newly created station will begin playback.
4. To access the created station, press ▲ or ▼ to highlight **My Stations** and then press **SELECT** when entering Pandora Radio. If no stations has been created, "Empty list. Use Create station or Genre stations to add new stations." will be shown. If number of stations reached 100, "Maximum number of stations reached" will be shown.

To bookmark current song or artist

1. Press ⏸ to display the options menu.
2. Press ▼ to choose **Bookmark Song** or **Bookmark artist** and press **SELECT**.

To thumb down a song in the current station

- Press ⊘ while listening. The current song will be marked as banned. For tracks from shared stations, pressing ⊘ will show the message "Not available for this track".

To delete a station

Press and hold ⊘ while listening. A confirmation screen will be displayed, press ▲ or ▼ to select **Yes** and press **SELECT** to confirm. The current station will be marked as banned.

Tag Options

Few options are available while you are listening to a Pandora Radio station as you press ⏸. Press ▲ or ▼ to highlight an option in the Tag Options menu and then press **SELECT** to proceed.

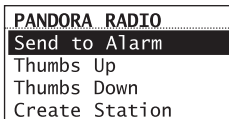

- **Send to Alarm**
To assign the station in general to be used as the alarm clock wake sound.
- **Thumbs Up (Not available for shared stations)**
To mark song as favorites.
- **Thumbs Down (Not available for shared stations)**
To ban song from the station.
- **Bookmark Song**
To bookmark a song. Visit www.pandora.com to view your bookmarks.
- **Bookmark Artist**
To bookmark an artist. Visit www.pandora.com to view your bookmarks.
- **Create Station**
To create a new station based on the current song or artist as the seed.
- **Why this song?**
To display explanation for why this song is playing.
- **Delete Station**
To delete the current station.

System Maintenance

When Pandora is performing system maintenance, thumb up/down a song, bookmark a song or artist, creating/deleting stations are not allowed. The message "Pandora is performing system maintenance. Try again later." will be displayed. However, listening to the Pandora radio can be continued.

Internet Radio

With Internet radio, you can listen to music, news, sports, weather or talk radio in other countries or from your home town. It offers the most music selections from around the world and most stations are free.

Accessing Internet Radio

- Press **SOURCE** repeatedly to select **Internet Radio**.
OR
- Press **▲** or **▼** to highlight **Internet Radio** in the Source menu and then press **SELECT**.

Listening to Internet Radio

To select a station:

Internet Radio stations are categorized according to music genre, talk nature and geographical location.

1. Press **▲** or **▼** to highlight a category or sub-category and then press **SELECT**.

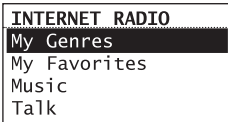

- **My Genres** – your favorite genres together in one place for easier navigation
 - **My Favorites** – a list of your favorite Internet Radio stations
 - **Music** – music stations categorized by genre and sub-genres (e.g. Blues, Hip Hop)
 - **Talk** – talk-specified stations categorized by talk natures (e.g. Business news, Religion)
 - **My Local Stations** – a list of local Internet radio stations selected according to the locale provided by the user
 - **By Region** – music stations categorized by geographical regions
2. While a station is highlighted, press **SELECT**. The selected station will start to play.

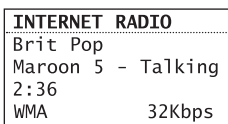

To store the current station as a preset:

1. Select a station.
2. Press and hold **1, 2, 3, 4, 5** or **6** on top of the radio until a beep sound is heard to store the current station to that preset button.
 - You can store up to 6 stations in each source.
 - To listen to a preset station, press **1-6**.
 - To edit a preset station, repeat the steps above to overwrite the previously stored station.
 - You can assign a preset station as the wake sound of the alarm, refer to page 17 for more information.

To store the current station as My Favorites:

Press **♥** while listening.

Alternatively:

1. Press **⌂**.
2. Press **▲** or **▼** to highlight **Add to Favorites** and then press **SELECT**.

To listen to a station in My Favorites:

Select a station from **My Favorites** in the main menu of Internet Radio and then press **SELECT** to start playback. (Read **To select a station** for more information).

To remove a station from My Favorites:

Press **⊗** while listening to a favorite station.

To assign the current station as the wake sound of the alarm clock:

1. Press **F**.
2. Press **▲** or **▼** to highlight **Send to Alarm** and then press **SELECT**.

Recording Internet Radio

Notice! Use of the recording feature is for personal use only. (Files cannot be transferred or moved from the internal memory.)

During recording, key functionality will be limited.



To record the current station:

1. Press **O** to start recording.

INTERNET RADIO
Brit Pop
Maroon 5 - Talking
2:36
● REC 00:00:34

2. Press **O** to stop recording.
 - Recording will be stored in the internal memory of the radio.
 - For playback, please refer to **Recordings** on page 26.
 - The radio names each recording as below:

Country	Format	For example
United States and Canada	<Station Name>_<Month-Day> HHMM	JazzMan_12-01 2245. HH is in 24-hour format.
Mexico	<Station Name>_<Day-Month> HHMM	JazzMan_01-12 2245. HH is in 24-hour format.

Adding Internet Radio stations

To add Internet Radio stations:

Please visit www.arinfiniteradio.com/portal and login to your user account to manually add new stations under **My Favorites**.

MP3tunes

MP3tunes is a Music Service Provider (MSP) and the home of MP3tunes Locker, a secure, online music space to allow unlimited listening. MP3tunes users can upload their own music collections to the MP3tunes Locker and listen through this radio when the computer is turned off.

The MP3tunes Locker is available in an ad-supported Free edition, along with the MP3tunes Premium Locker which permits larger music files, full access to album cover art and full customer support access.

For more information about MP3tunes, please visit www.mp3tunes.com.

MP3tunes Locker setup

1. Your MP3tunes account should have been created during your product activation, if you did not select this option during activation, please re-activate your unit, or select the MP3tunes source and follow the on screen prompts. You will be required to visit www.mp3tunes.com/infiniteradio to activate the account and then asked to input your username and password into the unit.
2. Upload your music collection to your MP3tunes Locker.
 - MP3tunes offers various methods to upload your music collection. Please refer to MP3tunes website for recommendations and instructions.
3. Make sure your MP3tunes account information in this radio is the same as your existing MP3tunes account.
 - To check or edit your MP3tunes account information, please refer to **Account Info** on page 30 of this user manual.

Accessing MP3tunes mode

- Press **SOURCE** repeatedly to select **MP3tunes**.
OR
- Press **▲** or **▼** to highlight **MP3tunes** in the Source menu and then press **SELECT**.

Listening to music in MP3tunes Locker

Your music files are categorized according to artists, albums and playlists.

1. Press **▲** or **▼** to highlight a category or sub-category and then press **SELECT**.

MP3TUNES	
Artist	>
Album	>
Playlists	>

2. Press **SELECT** or **▶II** to play back any music files from the selected artist, album or playlist.

MP3TUNES	
Sea of No Fears	
Greatest Hits	
2:12/3:48	
MP3	128Kbps

- To play back a specific music file, press **SELECT** to open the selected artist, album or playlist. Press **▲** or **▼** to highlight a specific file and then press **SELECT** or **▶II**.
3. Press **▶II** to pause or resume playback.
 4. Press **▶▶** to skip to the next file.
 5. Press **◀◀** within the beginning 3 seconds of the current file to skip to the previous file. Otherwise, you will return to the beginning of the current file.

FM/AM Tuner

FM/AM antenna

- For FM reception, uncoil the FM antenna at the back of the radio, ensuring it is fully extended (you may even want to tape it to the wall behind the radio if possible. The higher the better.)
- For AM reception, connect the AM antenna loop to the back of the radio. Rotate the AM loop antenna for better reception.

Accessing FM/AM Radio

- Press **SOURCE** repeatedly to select **FM Tuner** or **AM Tuner**.
OR
- Press **▲** or **▼** to highlight **FM Tuner** or **AM Tuner** in the Source menu and then press **SELECT**.

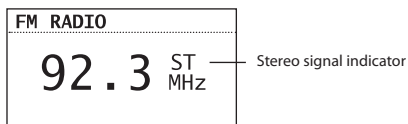

Listening to FM/AM Radio

To select a station:

1. Press **◀** or **▶** to adjust the frequency.
2. Press and hold **◀** or **▶** until the radio beeps to start searching through the frequency range. The radio stops searching when it detects the next station.

To store the current station as a preset:

1. Select a station.
 2. Press and hold **1**, **2**, **3**, **4**, **5** or **6** on top of the radio until a beep sound is heard to store the current station to that preset button.
- To listen to a preset station, press **1-6**.
 - To edit a preset station, repeat the steps above to overwrite the previously stored station.
 - You can assign a preset station as the wake sound of the alarm, refer to page 17 for more information.

To assign the current station as the wake sound of the alarm clock:

1. Press **☰**.
2. Press **▲** or **▼** to highlight **Send to Alarm** and then press **SELECT**.

Recording FM/AM Radio

Notice! Use of the recording feature is for personal use only. (Files cannot be transferred or moved from the internal memory.)

To record the current station:

1. Press **O** to start recording.

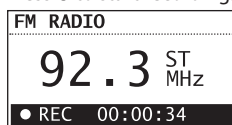

2. Press **O** to stop recording.
 - Recording will be stored in the internal memory of the radio.
 - For playback, please refer to **Recordings** on page 26.
 - The radio names each recording as below:

Country	Format	For example
United States and Canada	<Station Name>_<Month-Day> HHMM	JazzMan_12-01 2245. HH is in 24-hour format.
Mexico	<Station Name>_<Day-Month> HHMM	JazzMan_01-12 2245. HH is in 24-hour format.

Recordings

The radio's internal memory stores up to 10 hours of recordings from Internet Radio and FM/AM Tuner.

Accessing Recordings

- Press **SOURCE** repeatedly to select **Recordings**.
OR
- Press **▲** or **▼** to highlight **Recordings** in the Source menu and then press **SELECT**.

Listening to recordings

1. Press **▲** or **▼** to highlight a recording and then press **SELECT**.

Recordings		
FM99.5	1-21	124
AM1070	1-22	355
JazzMan	1-21	445
Slkr_Blues	1-16	34

2. Press **▲** or **▼** to highlight **Play** and then press **SELECT** to start playback.
3. Press **⏸** to pause or resume playback.
4. Press **⏭** to skip to the next recording.
5. Press **⏮** within the beginning 3 seconds of the current recording to skip to the previous recording. Otherwise, you will return to the beginning of the current recording.

Deleting recordings

1. Press **▲** or **▼** to highlight an unwanted recording and then press **SELECT**.
2. Press **▲** or **▼** to highlight **Delete** and then press **SELECT**.

Recordings		
FM99.5	1-21	124
Play		
Delete		

3. Press **▲** or **▼** to highlight **Yes** in the confirmation screen and then press **SELECT**.

To delete all recordings:

1. In the list of recordings, press **▲** or **▼** to highlight **DELETE ALL** and then press **SELECT**.

Recordings		
FM99.5	1-21	124
AM1070	1-22	355
JazzMan	1-21	445
DELETE ALL		

2. Select **Continue** in the confirmation screen and then press **SELECT**. Repeat this step to confirm delete all recordings.

USB Input

The radio can play back music files (mp3, wma and RealAudio (RA8 and G2) formats) stored on an external USB device connected to it. The USB connection port is located at the back of the radio.

Accessing USB Input mode

- Press **SOURCE** repeatedly to select **USB Input**.
OR
- Press **▲** or **▼** to highlight **USB Input** in the Source menu and then press **SELECT**.

Listening to audio files

1. Press **▲**, **▼**, **⏪** or **⏩** to browse through the directory of the USB device and select a music file by pressing **SELECT**.

USB INPUT	
01	Song1.mp3
02	Song2.mp3
03	Song3.mp3
04	Song4.mp3

- Press **⏩** or **SELECT** to enter a folder.
 - Press **⏪** to exit from a folder.
2. Press **▲** or **▼** to highlight a track.
 3. Press **▶||** to begin playback of highlighted track.
 4. Press **▶||** to pause or resume playback.
 5. Press **⏩** to skip to the next file.
 6. Press **⏪** within the beginning 3 seconds of the current file to skip to the previous file. Otherwise, you will return to the beginning of the current file.

Weather

Weather broadcast

Your radio includes a complimentary 4 year weather, on-demand subscription from WeatherBug®



A digital weather broadcast is available including:

- Text-to-speech reading of weather forecast for the ZIP code (US), Postal code (Canada) or City (Mexico) associated with the radio
- On screen display of conditions including current temperature, high and low temperatures of the day, current weather condition, humidity and wind conditions.
- Graphical display of weather conditions for 3-day forecast:

	Unknown
	Sunny/clear
	Mostly sunny
	Partly cloudy
	Mostly cloudy
	Cloudy
	Clear (night)
	Mostly clear (night)
	Partly cloudy (night)
	Mostly cloudy (night)
	Hazy
	Hazy (night)
	Rain
	Heavy rain

	Thunderstorms
	Severe thunderstorms
	Sleet
	Frozen mix
	Snow
	Heavy snow
	Windy
	Fog

To check the weather of current day:

Press **WEATHER** once.

For US:

WEATHER 20001
Temp: 20(31/17) °C
Mostly Sunny
Humidity: 77%
Wind: 0 mph

For Canada:

WEATHER K1A 0M5
Temp: 20(31/17) °F
Mostly Sunny
Humidity: 77%
Wind: 0 mph

For Mexico:

WEATHER
Temp: 20(31/17) °F
Mostly Sunny
Humidity: 77%
Wind: 0 mph



To check the 3-day weather forecast:

Press **WEATHER** twice to check weather forecast for current day and the next two days.



For US:

WEATHER 20001
Current: 20 °C
Today Sat Sun
31/17 31/17 31/18

For Canada:

WEATHER K1A 0M5		
Current: 20 °F		
Today	Sat	Sun
31/17	31/17	31/18
		

For Mexico:

WEATHER		
Current: 20 °F		
Today	Sat	Sun
31/17	31/17	31/18
		

To return to the previous audio source or playback screen:

Press **WEATHER** a third time.

Emergency Broadcast System alert

When an Emergency Broadcast System alert is received, the radio will:

- pause current audio playback,
- display the emergency warning text on the display,
- use text-to-speech to read the alert

If multiple alerts are active, the weather key allows you to toggle between them.





- Weather Alerts (Emergency Broadcast alerts) are checked for updates every 2 minutes.
- Emergency Broadcast System alert is not available in all locations.





Settings

Changing radio's settings

To change the radio settings:

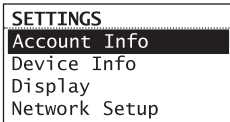
1. Press  to display the Source menu.
2. Press  or  to highlight **Settings** and then press **SELECT**.
3. Press  or  to highlight a setting and press **SELECT** to enter the sub-menu.



- Repeat this step to browse for more settings and sub-menus.
- 4. To change voice setting (only available for US and Canada), press  or  to highlight a desirable option and then press **SELECT** to confirm.

Account info

- To change the login information (username and password) sent by the radio when attempting to login to the Slacker, Pandora and MP3tunes services.
- To edit the locale for time and weather functions. The locale is used for clock time setting, weather forecast and searching local Internet radio stations in your area.

- If you have changed your account information through Slacker, Pandora or MP3tunes' website, please also edit the account information in this setting. The information here must match your account information online.
- If Disassociate Radio is selected in the Pandora Radio Account Info page, Pandora will stop playback. Username and password will also be deleted and you will have to set up the Pandora account when you try to log in again.



Device info

To show the firmware version, MAC address, PIN number of the radio. MAC address and PIN are necessary to activate your AR Infinite Radio accounts.

Display

To change brightness and contrast of the display.

Network setup

To change the network setting of the radio (wired or wireless). Refer to page 10 for more information.

Software updates

To check if newer firmware is available. Follow the instructions on the display for update.

Weather

- To turn on or off the text-to-speech reading (not available in all locations) when you press the **WEATHER** button.
- To select the gender and accent (US/UK) for the voice used for text-to-speech reading.
- To select the minimum level of emergency alerts to be notified of by the text-to-speech reading.

Advanced settings

- **Clock Sync Mode**
 - **Auto Sync** and **Manual**: to select between automatic and manual clock time update. If **Auto Sync** is selected, the clock accuracy will be verified online every 5 minutes.
- **Clock Format**: to select between 12-hour and 24-hour display modes.
- **Reset to defaults**: to reset menus to factory defaults. The following settings will be reset:
 - Slacker username, Slacker password, Pandora username, Pandora password, Display options, Language selection, Zip code entry, Network connection setup, Clock, Alarm, Weather alert level, Text-to-speech voice selections, Demonstration mode.
 - Recordings will NOT be erased but presets are reset.
- **Set Language**: to change the language of the display.

Some menus may require character input, refer to page 15 for tips on inputting characters.



Troubleshooting tips

The radio cannot be turned on.

- Plug the AC power adapter securely into the radio and a wall outlet.
- Check the power outlet by plugging in another device.
- Press and hold ON/STANDBY for 10 seconds to reboot the unit.

No sound.

- Increase the volume setting.
- Make sure the headphones are not plugged in.

The radio does not respond to key presses.

- The radio may temporarily cease to function if subjected to electrostatic disturbance. To resume normal operation, it may be necessary to reset the radio by unplugging and reconnecting the power or by removing and reinstalling the batteries in the base of the radio.

Cannot connect the radio to Internet.

- Check if your access point is turned on.
- Check if the wireless enabler is securely and correctly connected.
- Make sure a firewall is not blocking any outgoing ports.
- Make sure the access point does not restrict connections to specific MAC addresses.
- Make sure you have entered the correct password. Password is case sensitive.
- Your wireless Internet connection may exceed the maximum range for reception. Relocate the Internet Radio closer to the wireless access point.
- The network settings of the radio may be incorrect. Check the network settings in Network Setup in the Settings menu.
- If you are using WEP mode as the wireless security on the wireless router, please select OPEN system authentication mode.
- The Internet Radio does not support WEP shared key mode connection. WEP support WEP-40 (10 hex digits) and WEP-104 (26 hex digits) OPEN mode connection only.

Clock time is incorrect.

- Refer to Account Info in the Settings menu and make sure you have correctly input your ZIP code as reference for automatic clock time update.
- Make sure that Clock sync mode is not set to "Manual".

Weather information are incorrect.

- Refer to Account Info in the Settings menu and make sure you have correctly input your locale as reference for weather information.

Weather information and Emergency

Broadcast System alert are not read out loud.

- Refer to Weather in the Settings menu and make sure you have turned on the text-to-speech reading feature (not available in all locations).

The radio connects to the Internet but is unable to play a particular station.

- Check if the station is still broadcasting.
- The station may have reached the maximum number of simultaneous listeners.
- The link to the radio station may be out of date.
- The Internet connection between the radio station server and the radio may be too slow.

Intermittent audio.

- The bandwidth of your wireless LAN may be too low. Move the radio closer to the access point and make sure that there are no obstacles between them.
- The actual transmission speed of digital radio broadcast depends on the service provider (i.e. the Internet radio station).

Cannot skip to the next song while listening to Internet Radio.

- Skipping to the next song in Internet Radio is not available. (Slacker Radio and Pandora radio only)

Poor FM/AM Tuner reception.

- Check the antenna connection.
- Move antenna.
- Turn off nearby electrical appliances, such as hair dryer, vacuum cleaner and microwave.

Cannot record radio.

- Record feature is only available for Internet Radio, AM and FM Tuner.
- The internal memory of the radio may be full. Remove some of the old recordings.

Cannot play back music files on connected USB device.

- Make sure USB device is securely connected.
- Digital Right Management (DRM) type music files will not be played.
- The radio supports FAT12, 16 and 32 file systems only. Other file systems from Linux, MAC or NTFS are not supported.

Cannot stop the demonstration mode.

- To exit the demonstration, press and release in sequence the buttons on top of the radio: preset **1**, then **SLEEP/SNOOZE**, then preset **6**.

My question was not answered here.

- Visit www.arinfiniteradio.com for an up-to-date list of frequently asked questions.

Copyright warning

This player is for your personal use only. Unauthorized recording or duplication of copyrighted material may infringe upon the rights of third parties and may be contrary to copyright laws.

Check for updates

Visit www.arinfiniteradio.com for the latest news and firmware upgrades for our Wi-Fi Infinite Radio.

Product registration

Go to www.acoustic-research.com for online registration.

Technical specification

Product: Wi-Fi Internet Radio
Brand: Acoustic Research
Model: ARIR201
Electrical Consumption: 10 W

Electrical power source

External AC adapter for radio
Output: 5.0V DC 2.0A
Input: 100-240V ~ 50/60Hz 0.7A

Specifications

Hardware

- Dimensions: 212 mm H, 94 mm W, 154 mm D
- Unit Weight: 790 g (27.9oz) (without batteries)
- Standards: IEEE 802.11g and 802.11b
- Channels: 11 Wi-Fi Channels (US, Canada)
- Ethernet Port : 10/100 RJ-45 compatible
- Power: External 5.0V DC 2.0A
- Battery Backup: 3 X AAA Size Batteries
- Display: 2.7" Backlight LCD
- LEDs: On/Standby, two for navigation keys, Love it.
- Internal memory: 512 MB
- Stereo Headphones jack
- USB Connection Jack

AM Tuner section

- Tuning Range: 520KHz to 1710KHz

FM Tuner section

- Tuning Range: 87.5MHz to 107.9MHz

Amplifier section

- Output Power: 2W x 2
- Distortion @ 1KHz: <10% THD

Speakers

- Number: 2
- Size: 40mm (1.56")

For your records

Keep your sales receipt for proof of purchase to obtain warranty parts and service.

In the event that service should be required, you may need both the model number and the serial number. In the space below, record the date and place of purchase, and the serial number:

Model No.

Date of Purchase

Place of Purchase

Serial No.

Warranty information

12 Month Limited Warranty Applies to AR Internet Radios

AUDIOVOX ACCESSORIES CORP. (the Company) warrants to the original retail purchaser of this product that should this product or any part thereof, under normal use and conditions, be proven defective in material or workmanship within 12 months from the date of original purchase, such defect(s) will be repaired or replaced with reconditioned product (at the Company's option) without charge for parts and repair labor.

To obtain repair or replacement within the terms of this Warranty, the product is to be delivered with proof of warranty coverage (e.g. dated bill of sale), specification of defect(s), transportation prepaid, to the Company at the address shown below.

This Warranty does not extend to the elimination of externally generated static or noise, to correction of antenna problems, loss/interruptions of broadcast or internet service, to costs incurred for installation, removal or reinstallation of product, to corruptions caused by computer viruses, spyware or other malware, to loss of media, files, data or content, or to damage to tapes, discs, removable memory devices or cards, speakers, accessories, computers, computer peripherals, other media players, home networks or vehicle electrical systems.

This Warranty does not apply to any product or part thereof which, in the opinion of the Company, has suffered or been damaged through alteration, improper installation, mishandling, misuse, neglect, accident, or by removal or defacement of the factory serial number/bar code label(s). THE EXTENT OF THE COMPANY'S LIABILITY UNDER THIS WARRANTY IS LIMITED TO THE REPAIR OR REPLACEMENT PROVIDED ABOVE AND, IN NO EVENT, SHALL THE COMPANY'S LIABILITY EXCEED THE PURCHASE PRICE PAID BY PURCHASER FOR THE PRODUCT.

This Warranty is in lieu of all other express warranties or liabilities. ANY IMPLIED

WARRANTIES, INCLUDING ANY IMPLIED WARRANTY OF MERCHANTABILITY, SHALL BE LIMITED TO THE DURATION OF THIS WRITTEN WARRANTY. ANY ACTION FOR BREACH OF ANY WARRANTY HEREUNDER INCLUDING ANY IMPLIED WARRANTY OF MERCHANTABILITY MUST BE BROUGHT WITHIN A PERIOD OF 24 MONTHS FROM DATE OF ORIGINAL PURCHASE. IN NO CASE SHALL THE COMPANY BE LIABLE FOR ANY CONSEQUENTIAL OR INCIDENTAL DAMAGES FOR BREACH OF THIS OR ANY OTHER WARRANTY. No person or representative is authorized to assume for the Company any liability other than expressed herein in connection with the sale of this product.

Some states do not allow limitations on how long an implied warranty lasts or the exclusion or limitation of incidental or consequential damage so the above limitations or exclusions may not apply to you. This Warranty gives you specific legal rights and you may also have other rights which vary from state to state.

Recommendations before returning your product for a warranty claim:

- If your product is capable of storing content (such as an mp3 player, voice recorder, camcorder, digital photo frame, etc), it is recommended to make periodic backup copies of content stored on the product. If applicable, before shipping a product, make a back up copy of content or data stored on the device. Also, it is advisable to remove any personal content which you would not want exposed to others. IT IS LIKELY THAT CONTENTS AND DATA ON THE DEVICE WILL BE LOST DURING SERVICE AND REFORMATTING. AUDIOVOX ACCEPTS NO LIABILITY FOR LOST CONTENT OR DATA, OR FOR THE SECURITY OF ANY PERSONAL CONTENT OR DATA ON THE RETURNED DEVICE. Product will be returned with factory default settings, and without any pre-loaded content which may have been installed in the originally purchased products. Consumer will be responsible for reloading data and content. Consumer will be responsible to restore any personal preference settings.

- Properly pack your unit. Include any remotes, memory cards, cables, etc. which were originally provided with the product. However DO NOT return any removable batteries, even if batteries were included with the original purchase. We recommend using the original carton and packing materials.
Ship to

Audiovox Electronics Corp.
Attn: Service Department.
150 Marcus Blvd.
Hauppauge N.Y. 11788

1-800-645-4994

For Canada Customers, please ship to:

Audiovox Return Centre
c/o Genco
6685 Kennedy Road,
Unit#3, Door 16,
Mississauga, Ontario
L5T 3A5

Illustrations contained within this publication are for representation only and subject to change.

The descriptions and characteristics given in this document are given as a general indication and not as a guarantee. In order to provide the highest quality product possible, we reserve the right to make any improvement or modification without prior notice.

Visit <http://store.audiovox.com> to find the best accessories for your products.



For Customer Service
Visit Our Website At
www.arinfiniteradio.com
Product Information, Photos,
FAQ's, Owner's Manuals

© 2010 Audiovox Accessories Corporation
111 Congressional Blvd., Suite 350
Carmel, IN 46032
Trademark(s) ® Registered

v2.0 (1.0.2.0)