

OWNER'S INSTRUCTION MANUAL



Colleague TWO-LINE TYPE II CALLER ID

CORTELCO

**THANK YOU
FOR PURCHASING THE
COLLEAGUE CALLER ID TYPE II
TWO-LINE TELEPHONE**

We want you to know all about your new Colleague Telephone, how to install it, the features it provides, and the services you can expect from its use. We have included this information in your Owner's Instruction Manual

**PLEASE READ BEFORE INSTALLING
AND USING YOUR NEW TELEPHONE EQUIPMENT.**

TABLE OF CONTENTS

IMPORTANT SAFETY INSTRUCTIONS	2
USING YOUR TELEPHONE	4
SET UP/INSTALLATION	4
WALL MOUNT INSTRUCTIONS	5
FEATURES OF YOUR TELEPHONE	6
SETTING UP YOUR UNIT	7
FACTORY PRESETS	7
USING YOUR PHONE	9
RECEIVING A PHONE CALLS	9
PLACING A PHONE CALL	9
SPEAKERPHONE BUTTON	10
DURATION COUNTER	10
AUTOMATIC MEMORY	10
TO STORE A PHONE NUMBER IN MEMORY	10
TO DIAL A PHONE NUMBER IN MEMORY	11
VOLUME BUTTON	11
REDIAL BUTTON	11
PAUSE BUTTON	11
HOLD BUTTON	11
FLASH BUTTON	12
CALL WAITING DISPLAY	12
MUTE BUTTON	12
RINGER VOLUME	12
TONE BUTTON	13
CONFERENCE BUTTON	13
HEADSET COMPATIBLE	13
CONTRAST BUTTON	13
DATA PORT	13

USING THE DIRECTORY	13
STORE NEW NUMBER AND NAME INTO DIRECTORY	14
FINDING ITEMS IN THE DIRECTORY	14
EDITING IN THE DIRECTORY	14
DELETING ITEMS IN THE DIRECTORY	14
USING KEYPAD TO ENTER NAME	15
USING THE CALLER ID FUNCTION	16
MESSAGE LIGHT	16
MESSAGED WAITING	16
RECEIVING CALLS	17
REVIEWING CALLS	17
CALLER LIST	18
DELETING CALLS	18
CALLBACK...	19
DIAL OPTIONS BUTTON	19
MESSAGE ERROR	21
NO DATA SENT	21
PRIVATE CALLS	21
UNKNOWN CALLS	22
TELEPHONE SERVICE PROBLEMS	23
IN CASE OF POWER FAILURE	24
MAINTENANCE INFORMATION	24
REPAIR OF YOUR TELEPHONE	25
THE FCC WANTS YOU TO KNOW	26

IMPORTANT SAFETY INSTRUCTIONS

Always follow basic safety precautions when using your telephone equipment to reduce the risk of fire, electrical shock, and injury.

1. **Read and understand all instructions** in the Owner's Instruction Manual.
2. **Read all warnings** and follow all instructions marked on the product.
3. **Unplug this product from the wall outlet before cleaning.** Use a damp cloth for cleaning. Do not use liquid or aerosol cleaners.
4. **Do not use the telephone near water.** For example, do not use near a bathtub, wash bowl, kitchen sink, laundry tub, swimming pool, or in a wet basement.
5. **Do not place this product on an unstable cart or stand.** The product may fall causing serious damage to the product.
6. **Use only the type power source indicated on the label.** If you are not sure of the type power supply to your home, consult your dealer or local power company.
7. **Do not place any objects on the telephone line cord.** Do not locate the telephone where the line cord will be walked on.
8. **Do not block or cover ventilation slots and openings** in the bottom of the telephone. The openings should never be blocked by placing the telephone on a bed, sofa, rug, or other similar surfaces. This telephone should never be placed near or over a radiator or heat register. This telephone should never be placed in a built-in installation unless proper ventilation is provided.
9. **Never spill liquid on the telephone or push objects of any kind through ventilation slots.** Liquid or objects may touch dangerous voltage points or short out parts that could result in a risk of fire or electrical shock.

10. **Do not disassemble this product.** Opening or removing covers may expose you to dangerous voltages or other risks. Incorrect reassembly can cause electrical shock when the product is subsequently used.
11. **Do not overload outlets and extension cords.** Some telephones require AC power from an outlet, overloading the outlets can result in the risk of fire or electric shock.
12. **Avoid using a telephone during a local thunderstorm.** There may be a remote risk of electrical shock from lightning.
13. **Do not use a telephone in the vicinity of a gas leak** to report the leak, or otherwise.
14. **Unplug the telephone from the wall outlet and refer servicing to qualified service personnel** under the following conditions:
 - When the line cord is frayed or plugs damaged.
 - If liquid has been spilled into the telephone.
 - If the telephone has been exposed to rain or water.
 - If the telephone does not operate properly by following the operating instructions. (Adjust only those controls covered by the operating instructions. Improper adjustment of other controls may result in damage and will often require extensive work by a qualified technician to restore the product to normal operation.)
 - If the telephone has been dropped or the housing damaged.
 - If the telephone exhibits a distinct change in performance.
15. **In case of power failure, outgoing calls can only be made using DTMF dialing on Line 1.**

SAVE THESE INSTRUCTIONS

USING YOUR TELEPHONE

SET UP/INSTALLATION

1. Connect the adapter. Plug the large part of the adapter into the wall outlet and the adapter tip into the jack at the rear side of unit. (Use only 9V DC. 300mA, center positive Class 2 adapter.)
2. Connect the telephone line cord.
 - a. To connect without an answering machine.
 - Use the new line cord to connect the PHONE jack of your new caller ID phone to the modular wall jack.

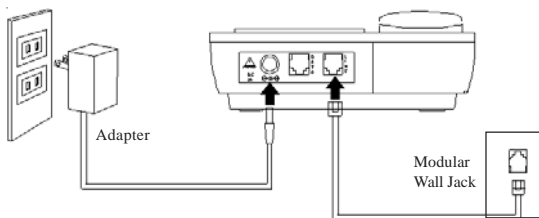

- b. To connect with an existing answering machine.
 - Use the existing line cord supplied to connect the LINE jack of your answering machine to the wall modular line jack.
 - Use the new line cord supplied to connect the telephone jack of your new Caller ID phone to the PHONE jack of your answering machine.
 - Set your answering machine to answer the phone after 2 or more rings.

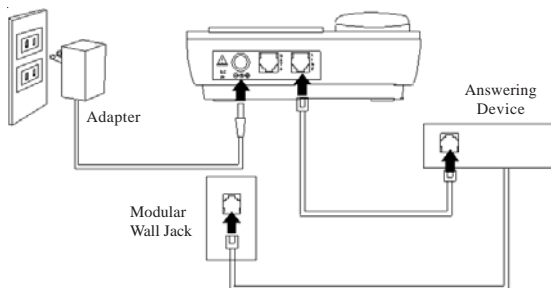

3. Follow the procedure [Setting Up Your Unit] to set up your unit.
4. Place the unit on a flat table or mount it on a wall. If you desire to place it on a wall, use the wall mount bracket and short line cord supplied to accomplish the wall mounting.

WALL MOUNT INSTRUCTIONS

1. Install wall mount bracket in wall mount position and route cords as shown in diagram below.
2. Connect the adapter and the line cord. See Steps 2 & 3 on preceding page for specific instructions.
3. Push out the handset hook and relocate it reversely to the wall mount position, plug the coiled cord into the handset, and then plug the other end of the cord into the case.
4. Place the handset on the base.

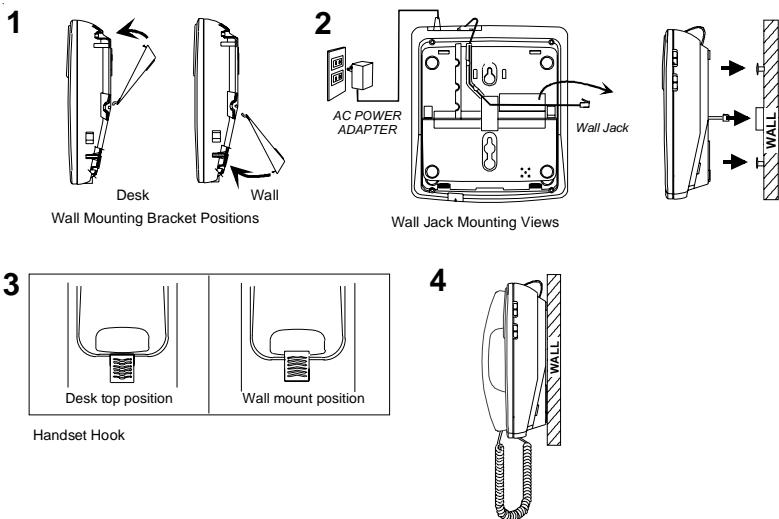

FEATURES OF YOUR TELEPHONE

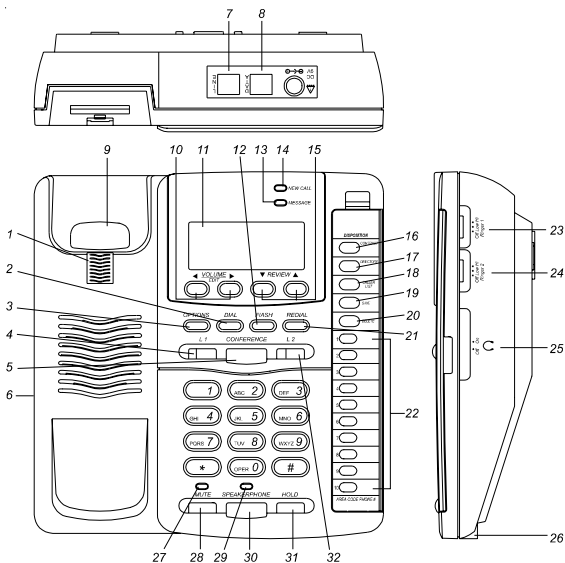

1	Handset Hook	17	Directory
2	Dial Button	18	Caller List
3	Options Button	19	Save
4	Line 1 Button	20	Delete
5	Conference Button	21	Redial Button
6	Handset Cord Jack	22	10 Auto Memory Button
7	Line Cord Jack	23	Ringer 1 Switch
8	Data Cord Jack	24	Ringer 2 Switch
9	Hook Switch	25	Headset Switch
10	Volume/Edit Button	26	Microphone
11	LCD Display	27	Mute LED
12	Flash Button	28	Mute Button
13	Green Message LED	29	Speakerphone LED
14	Red New Call LED	30	Speakerphone Button
15	Review Up/Down Button	31	Hold Button
16	Contrast	32	Line 2 Button

SETTING UP YOUR UNIT

FACTORY PRESETS

To ensure your telephone works properly, you must set the following options correctly before using your phone. To begin the setting sequence, press **OPTIONS** button.

The following table shows you the factory default settings for your unit:

<u>Display</u>	<u>Setting</u>
Language	English
Area Code	4 Area Codes, No Setting
Flash	600 ms
Line 1 / Line 2	Line 1
Tone / Pulse	Tone Dialing

After the adapter is connected, the display will show as indicated below for setting.

- [*SET LANGUAGE*] appears on the display. “**1. ENG**” and “**2. ESP**” will flash for you to choose to view your message in English or Spanish. This will only flash for a short time before going into standby mode.
 - Press 1 to select ENG (English), or press 2 to select ESP (Spanish).
A check mark moves to the selection you have made.
 - Press **DOWN** button to confirm the selection, and the screen will display the next setting option.

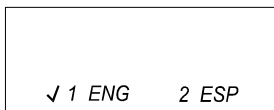
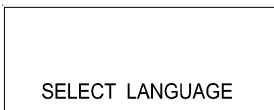

- This telephone has been specially designed to allow programming of up to four different area codes.
 - When [*SET AREA CODE*] appears, use the keypad 1-0 to enter the area code. After you finish all three digits, press **DOWN** button to confirm, and the “**ENTER 2ND CODE**” will be displayed for programming.
 - Use the same procedure as in step 1 to program the 2ND, 3RD and 4TH area codes.
 - The **DOWN** button can be used as a skip feature. For example, if there are only two area codes to be programmed, when “**ENTER 3RD CODE**” and “**ENTER 4TH CODE**” appear, press the **DOWN** button to confirm, and the screen will display the next setting option.

— — —
ENTER AREA CODE

— — —
ENTER 2ND CODE

— — —
ENTER 3RD CODE

— — —
ENTER 4TH CODE

3. When [*FLASH TIMER (MS)*] appears, press **EDIT** button to set the desired Flash Timer.
- (1) Use **LEFT** button to decrease the timer by 50 ms. (Min. 100 ms)
 - (2) Use **RIGHT** button to increase the timer by 50 ms. (Max. 1000 ms)
 - (3) Press **DOWN** button to confirm, and the screen will display the next setting option.

6 0 0
FLASH TIME (MS)

4. When [*SELECT LINE1/2?*] appears, “1. LINE 1” and “2. LINE 2” will flash and you may select line 1 or 2 as the prime line.
- (1) The default setting for prime line is Line 1. The prime line is the automatically selected when the handset is lifted, or handsfree is pressed.
 - (2) Press **1** button to select LINE 1, or Press **2** button to select LINE 2. The check mark moves to the selection you have made.
 - (3) Press **DOWN** button to confirm, and the screen will display the next setting option.

SELECT LINE1/2 ?

✓ 1.L_1 2.L_2

5. When [*DIAL MODE*] appears, 1. P (Pulse) and 2. T (Tone) will flash and you may select Tone or Pulse Dialing.
- (1) Press **1** button to select TONE, or Press **2** button to select PULSE. The check mark moves to the selection you have made.
 - (2) Press **DOWN** button to confirm, and the screen will display the next setting option, or press **OPTION** button to skip the programming.

Note: In order for the Caller ID callback to work (see Using the Caller ID Function), you must set the **PULSE/TONE** switch to the Tone position.

DIAL MODE

1.P ✓ 2.T

6. You have now completed the necessary programming. TOTAL:00 NEW:00" appears in the display. This is the initial standby screen. The Date/Time is set when a Caller ID call is received. This telephone will keep the current time accurately, and is updated each time a CID number is received. After you have set up the unit completely for the first time, use the **OPTIONS** button to review or reprogram the Language, Area Code, Flash Timer, Line Status or Dial Mode.

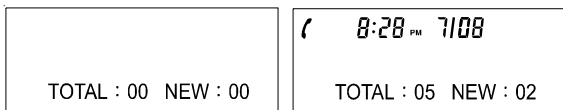

USING YOUR TELEPHONE

RECEIVING A PHONE CALL

1. Be sure the **RINGER** switch is set to the **HI** or **LOW** position.
2. When the phone rings and the callers information shows on the display window (refer to Using the Caller ID Function), lift the handset or press the **SPEAKERPHONE** button and begin your conversation.
3. Set the Ringer switch to the **OFF** position when you do not want to be interrupted by the phone ringing.

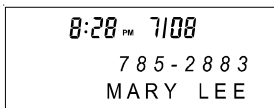

PLACING A PHONE CALL

1. Lift the handset or press the **SPEAKERPHONE** button and wait for a dial tone.
2. Dial the telephone number you wish to call. The number will appear on the display window.

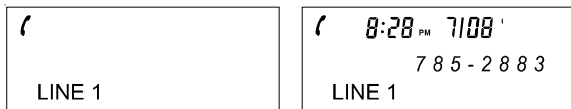

SPEAKERPHONE BUTTON

1. Receiving Incoming Calls
 - a. When the phone rings and the caller's information shows on the display window (refer to *Using the Caller ID Function*), press and release the Speakerphone button and talk normally into the built-in microphone from a distance of 5-6 inches.
 - b. You can adjust the volume of the caller's voice by pressing the **VOLUME** button to obtain the desired volume level.
 - c. After the conversation has finished, press the **SPEAKERPHONE** button to hang up.
2. To Make A Call
 - a. Press and release the **SPEAKERPHONE** button.
 - b. When you hear a dial tone, dial the number or press the auto memory button just as you would on any other push-button telephone. The number appears on the display window.
 - c. After the conversation has finished, press **SPEAKERPHONE** to hang up.

Note:

1. *If you wish to switch from handsfree to handset, simply lift the handset.*
2. *If you wish to switch from handset to handsfree, press and release **SPEAKERPHONE** and then hang up the handset.*

DURATION COUNTER

A built-in counter will start counting for your reference 6 seconds after you lift the handset or 6 seconds after you dial a telephone number.

AUTOMATIC MEMORY

To Store A Number In Memory: (Telephone must be on-hook)

1. Press and hold the **SAVE** button for more than 2 seconds. [**SAVE TO?**] appears display window.
2. Press the key (located on right-hand side of base) you want to store the number. Then [**ENTER NUMBER**] appears on the display window.
3. Enter the number you want to store. After you complete the number, press the **SAVE** button. Then [**ENTER NAME**] appears on the display window. Use the keypad to input the name associated with the number. (See page 15 for instructions.)
4. Press the **SAVE** button again.

SAVE TO ?

—
ENTER NUMBER>

7 8 5 - 2 8 8 3
ENTER NAME>

MEMORY STORING

To Dial A Phone Number In Memory

1. Lift the handset or press speakerphone and wait for a dial tone.
2. Press any memory location.
 - To dial an auto memory button (located on right-band side of base) - Press the desired auto memory button (1, 2, 3.... or 10).
3. The number will be displayed and dialed automatically.

VOLUME BUTTON

A built-in amplifier feature allows you to increase the listening volume when speaking with your party. When needed, press the **VOLUME** button to achieve different levels. The volume will go back to default after you hang up the handset. Default volume is mid-level.

REDIAL/PAUSE BUTTON

1. If the number you dialed is busy, or you want to call the last number dialed again, press and release the hookswitch for a new dial tone.
2. Press **REDIAL**. The number will appear on the display window.
3. The last number called will automatically be redialed.

The **PAUSE** button allows you to insert a 3.6-second pause in the dialing sequence. This is particularly useful if you are connected to a PABX system where you must dial an access code (usually the number 9) to obtain an outside line.

1. Press the **PAUSE** button once and release at any point in the dialing sequence where a pause is desired.
2. The **PAUSE** button can be pressed more than once to create a longer pause.

HOLD BUTTON

1. To place a call on hold, press the **HOLD** button. The Line LED will then flash. Press the Line button being used to release Hold.
2. To Answer a Call on the other line while speaking on one line. Place the current line on hold. Press the ringing Line button, Line 1 or Line 2. If you want the second call to join you in a three-way conference, press the **CONF**.
3. To Place both calls on hold press the Hold button and both lines will be on hold at the same time. The Line/Hold LEDs will light. To cancel hold for only one line press the desired line button (Line 1/2). The other line will remain on hold.

FLASH BUTTON

This telephone provides a break signal for a PABX service of Call Waiting from your local telephone company. The Flash time is programmable from 100ms to 1000ms, in 50ms increments. You can change the flash time in the setup procedure. The default Flash time is 600ms. If you have Call Waiting service, you can alternate the Call Waiting function per the following instructions.

1. While having a conversation, another party calls and you hear a tone.
2. Press the **FLASH** button once and release. The first conversation is placed on hold and the second call can be answered.
3. Press **FLASH** button again and release. The first caller can be spoken to again and the second call is placed on hold.

Note: *If you also have subscribed to Call Waiting Caller ID service, please see Call Waiting Display below*

CALL WAITING DISPLAY

In the past, if you had call-waiting service, a tone alerted you there was a new call coming while you were on an existing call. Now our Call Waiting Caller ID not only tells you there is another call waiting, but lets you know who the caller is before you answer it. The call waiting information is shown on the unit's display. The **CALL WAITING** (CW) symbol will flash for 16 seconds along with the telephone number and name of the person who is on call waiting. Press the FLASH button to put the existing call on hold and answer the new call.

No matter whether you answer the call or not, the Call Waiting Caller ID will store the call information for future reference.

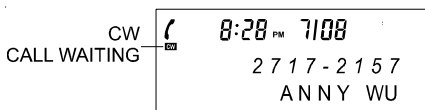

Note: *Make sure you have subscribed to both Call Waiting Caller ID and Caller ID service from your local telephone company. If you only have Caller ID service, the unit works for Caller ID only.*

MUTE BUTTON

Press **MUTE** to speak without the person on the phone hearing your conversation. The **MUTE** Indicator will light up and remain lighted until you resume your conversation. To resume your conversation, press **MUTE**. The **MUTE** indicator will go out and your call can continue.

RINGER VOLUME

Use the **Ringer Volume** controls located on the right side of the phone base to change ringer volume for Line 1 and Line 2. The 3-position switches are used to set ringer volume to Off, Low or Hi. Remember to set the Ringer switches to Hi or Low when you want to receive calls.

CONFERENCE BUTTON

1. To establish a three-way conference call, press HOLD while talking on one line. The first conference person is on Hold, the HOLD LED will light.
2. Press Line 1 or Line 2 whichever is not being used. Listen for dial tone. Dial the telephone number of the second person.
3. Press the conference button. You may now speak to the first and second person simultaneously. To place both calls on hold, press the hold button while in conference. To cancel hold for one line, press the desired line.
Note: The first person is automatically released from hold after pressing the conference button.
4. Replace the handset in the cradle to disconnect both lines. To stay connected to only one line, press the desired line. The other line will be disconnected.
5. After conference call, press Line 1 or Line 2 to cancel conference call.

TONE BUTTON (*)

If the PULSE/TONE switch is set to the PULSE position, and you want to make a tone dialing call after pulse dialing, press the TONE button on the dialing keypad, then dial the number. The number dialed out will be changed to tone dialing automatically without setting the PULSE/TONE to TONE position.

HEADSET COMPATIBLE

The slide switch must be located in the proper position for this feature to work. The headset can be turned on and off by using the handsfree button.

Note: Use the Slide Switch located on the right side of the phone base to set On or Off.

CONTRAST BUTTON

The preset value is 3. you can change it to your preference by pressing **CONTRAST** button to adjust to different levels of the display contrast.

DATA PORT

This is a connection which is in parallel with the telephone line. It allows the connection of a device such as a modem, caller ID, or an answering machine. The data port is across line 2.

USING THE DIRECTORY

This unit stores the numbers of up to 99 of your business associates, clients, contacts, and friends in your Directory. You can dial these numbers by selecting them. Names are sorted alphabetically starting with the first character. (If you want your Directory sorted by the last name, enter the last name first.)

TO STORE A NEW NUMBER AND NAME INTO THE DIRECTORY

1. Press and hold the **SAVE** button for more than 2 seconds. “**SAVE TO**” will appear on display.
2. Press **DIRECTORY**. Then “”**ENTER NUM**” will appear on display.
3. Enter the telephone number you want to store. After you complete the number, press **SAVE**. “**ENTER NAME**” will appear on display for two seconds. (See page 15 for instructions.)
4. Use the keypad to input the name associated with the number.
5. Press **SAVE** again to finish the store procedure.

FINDING ITEMS IN THE DIRECTORY

1. Press **DIRECTORY** to see the Directory List.
2. To move down and up the list, press **UP** or **DOWN**. Or you can press the appropriate dial key to see the listings that start with a particular letter. For example: 55 takes you to the first “JJ listing, the **DOWN** takes you to the next J listing. Pressing 555 takes you to the first “KK” listing.
3. To leave the Directory at any time, press **DIRECTORY**.

EDITING IN THE DIRECTORY

1. Find the item you want to edit in the Directory list.
2. Press **LEFT** to start editing. After you change the number, press **SAVE** again.
3. You can also change the name and press **SAVE** to finish the editing procedure.

DIALING TELEPHONE NUMBERS FROM MEMORY

1. Find the number you want to dial in the Directory list. (Telephone can be On or Off hook)
2. When the number shows on the display, press **DIAL** to start the dialing.

DELETING ITEMS IN THE DIRECTORY

Deleting individual item:

To delete an individual call, press the **DELETE** button twice. The display will be erased line by line and the remaining items will be re-sorted.

Deleting all items:

To delete all items stored in the directory, press **DIRECTORY** to see the Directory List heading, then press and hold the **DELETE** button for more than 4 seconds until “**DELETE ALL**” appears in the display. Press the **DELETE** button again to confirm that you want to delete all call records. “**NO RECORDS**” appears in the display confirming there are no call records stored in memory.

USING KEYPAD TO ENTER NAME

You can program names to correspond with numbers you enter into the DIRECTORY or memory locations. To program a name, find the dial pad key that has the first character of the name. Keep watching the display as you press the key until the desired character appears on the display. Press a different dial pad key or press the right **EDIT** button for the next character. If the next character is on the same key, please wait one second to accept the previous input. To insert a space, press the **RIGHT** edit button. To backspace and erase a mistake, press the **LEFT** edit button.

1: 1	2: 2ABC	3: 3DEF
4: 4GHI	5: 5JKL	6: 6MNO
7: 7OQRS	8: 8 TUV	9: 9WXYZ
*: *	0: 0	#: #

USING THE CALLER ID FUNCTION

MESSAGE LIGHT

An indicator marked **NEW CALL** will light and flash to let you know when there are new calls received.

If you have a voice mailbox service with your telephone company, another indicator marked **MESSAGE** will flash to alert you to dial your telephone company to check your new messages.

MESSAGE WAITING

This unit's **MESSAGE WAITING DETECTION** is for both FSK and Stutter Tone Systems.

IF YOUR SERVICE IS FSK:

1. If you have a voice mailbox service from the phone company, the **MESSAGE** indicator will flash and **[MESSAGE WAITING]** will appear on the display for 20 seconds when a message waiting signal (on) from the Central Office is received.



2. The **MESSAGE** indicator will go off and **[MSG WAITING OFF]** will appear for 20 seconds if the message waiting off signal is sent from the Central office.

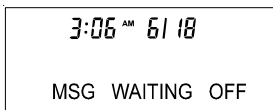

IF YOUR SERVICE IS A STUTTER TONE SYSTEM:

1. This unit will check your line for a stutter dial tone every time you hang up or each time a call goes unanswered. The **MESSAGE** indicator will flash when there is a message waiting.
2. You may experience some delay in seeing the **MESSAGE** indicator light up even though there are messages in your mail box. This delay is due to regulatory matters and does not indicate a problem with the unit.

This unit may not be activated or deactivated under certain conditions. For example, when you retrieve your message from an outside phone (not your own telephone number), the **MESSAGE** indicator may not be canceled when you return home. If you experience this situation, pick up the receiver and hang up. The **MESSAGE** indicator will cancel.

RECEIVING CALLS

1. When the telephone is not in use and a new call is received, the display will show the **NEW** symbol, the phone number, the caller's name, and time and date of the call for 20 seconds. The **REPEAT** symbol will appear if the call has come in more than once.
2. After 20 seconds with no activity, the display will default to the Stand-By screen and remain on until another call is received or a button is pressed. This will show you the total number of calls stored and how many new calls that have not been reviewed.



REVIEWING CALLS

1. When the **NEW** symbol is flashing on the Stand-By screen, you have new incoming calls. Next to the **NEW** symbol is the total number of new calls. Press **CALLER LIST** and the **REVIEW UP** or **REVIEW DOWN** button to review the incoming stored calls.
2. The **NEW** symbol attached to each call will be removed after you review the call.
3. If the **NEW** symbol is still flashing when the display goes back to the Stand-By screen, there are new calls that you have not yet reviewed.
4. The reviewed number can be stored into any of the auto memory buttons or keypad memory locations by pressing the **SAVE** button first, then one of the memory buttons. Press the **SAVE** button to confirm.

- When you have reached the end of the call records, the display will indicate [-END OF LIST-], confirming there are no more calls stored.

- END OF LIST -

Note: If the telephone number received is more than 10 digits, the unit will only store the first 10 digits into memory.

CALLER LIST

To store CID numbers into a Memory or Directory location, press the **Caller List** button to review calls.

- Select a CID number from the Caller List.
- Press and hold the **SAVE** button for more than 2 seconds. "**SAVE TO?**" and the CID number will appear on display.
- Press the memory key or directory location where you want to store the number "**ENTER NUM**" will appear on the display.
- You can modify the number if you want or just press the **SAVE** button once. "**ENTER NAME**" will appear on the display for two seconds. Then the CID name will show on the display.
- You can modify the name or just press **SAVE** to complete the procedure.

DELETING CALLS

- To delete an individual call: When reviewing calls, you can delete an individual call by pressing the **DELETE** button twice. The display will be erased line by line and the rest of the records will be renumbered.

8:28 PM 7108
205 - 785 - 2883
MARY LEE

- To delete all calls: When reviewing calls, you can delete all calls by pressing and holding **DELETE** for more than 4 seconds. Then [**DELETE ALL**] will appear. Press **DELETE** to confirm you really want to erase all records. [-**NO CALLS**-] appears on the display to show there are no calls stored in memory.

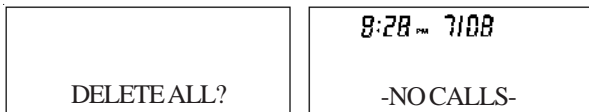

CALLBACK

When reviewing received calls, there are two ways to dial the telephone numbers shown on the display by pressing **DIAL**.

1. With the handset in its cradle (on-hook), press **DIAL**. The number will be dialed using handsfree operation.

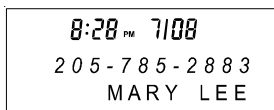

2. If you pick up the handset, review the calls, and press **DIAL**, the displayed number will be dialed immediately.

Note: The *HANDSET* symbol will light up in the upper left hand corner of the LCD display when the handset is picked up.

If a local call (a telephone number with the same area code as you set) is reviewed and its 7-digit number displayed, press **DIAL** to dial the number displayed.

If a long distance call (a telephone number with a different area code than you set) is reviewed and its 10-digit number (3-digit area code + 7-digit telephone number) is displayed, press **DIAL** to dial the number displayed.

DIAL OPTIONS BUTTON

The **DIAL OPTIONS** button allows you to change the format of the displayed number. The available format follows:

- | | |
|----------|---|
| 7-digit | 7-digit telephone number. |
| 10-digit | 3-digit area code + 7-digit telephone number. |
| 11-digit | Long distance code 1 + 3-digit area code + 7digit telephone number. |

If a local call, and its 7-digit number is displayed:

- Pressing **OPTIONS** once will change it to a 10-digit format (your area code + 7digit number).
- Pressing **OPTIONS** twice will change it to an 11-digit number (1 + your area code + 7-digit telephone number).
- Pressing **OPTIONS** three times will go back to the original 7-digit telephone number

Original
656-5756

Press Options Button Oncel
(914) 656-5756

Press Options Button Twicel
1+(914) 656-5756

8:20 PM 7102
6 5 6 - 5 7 5 6
J O N L E E

8:20 PM 7102
9 1 4 - 6 5 6 - 5 7 5 6
J O N L E E

8:20 PM 7102
1 9 1 4 - 6 5 6 - 5 7 5 6
J O N L E E

*The LCD can only display 10 digit telephone numbers, when you change the format to 11-digits, only the first 10 digits can be seen, but it will dial 11-digits after you press **DIAL**.*

If a long distance call, and its 10-digit number is displayed,

1. Pressing **OPTIONS** once will change it to an 11-digit number (1+ 3-digit area code + 7-digit telephone number).
2. Pressing **OPTIONS** twice will remove the 3-digit area code and change to display only the 7-digit telephone number.
3. Pressing **OPTIONS** three times will go back to the original 10-digit number
4. For example: your own area code is 205, and you are reviewing telephone number 914-656-5756.

When the desired format of the telephone number is reached, press **DIAL** to dial the displayed number.

Original
(914) 656-5756

Press Options Button Oncel
1+ (914) 656-5756

Press Options Button Twicel
656-5756

8:20 PM 7102
9 1 4 - 6 5 6 - 5 7 5 6
J O N L E E

8:20 PM 7102
1 9 1 4 - 6 5 6 - 5 7 5 6
J O N L E E

8:20 PM 7102
6 5 6 - 5 7 5 6
J O N L E E

MESSAGE ERROR

- The display indicates “[- MESSAGE ERROR -]”if your unit receives a call that has an error in the transmission or reception.

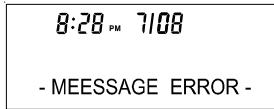

NO DATA SENT

1. [-NO DATA SENT-] will be displayed if there is no caller ID (CID) number sent from the telephone company while ringing.

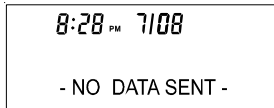

PRIVATE CALLS

- If the caller has exercised the option to block his number from being sent, [PRIVATE NUMBER] and his name will alternately display on the screen when this information is received.
- If the caller has exercised the option to block his name from being sent, [PRIVATE NAME] and his telephone number will be displayed on the screen.
- If the caller has exercised the option to block his name and number from being sent, then [PRIVATE CALLER] will be displayed on the screen.

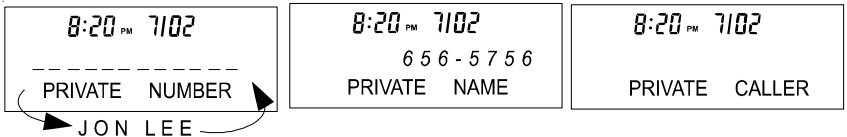

UNKNOWN CALLER

- When the telephone company is unable to provide information of the caller's telephone number, [UNKNOWN NUMBER] and his name will alternately display on the screen when this information is received.
- When the telephone company is unable to provide information of the caller's name, [UNKNOWN NAME] and his telephone number will be displayed on the screen.
- When the telephone company is unable to provide information of the caller's name and number, [UNKNOWN CALLER] will be displayed on the screen.

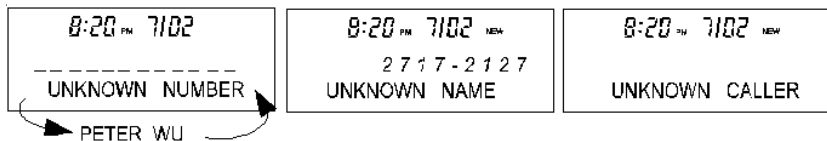

TELEPHONE SERVICE PROBLEMS

If you have any problems with your telephone equipment service, determine if the problem is with your unit or the telephone company lines. **BEFORE CALLING THE TELEPHONE COMPANY**, be aware that they may charge you for a service call if the problem is caused by your telephone equipment.

PHONE DOES NOT RING

1. **OFF/LOW/HI** ringer switch is set to **OFF** position
2. Line cord is disconnected at telephone outlet or at telephone end.
3. Phone is **OFF HOOK**. Make certain the hookswitch is depressed when the handset is in the cradle.
4. **SPEAKERPHONE** indicator is on. Turn off speakerphone.

NO DIAL TONE

Wire is disconnected at telephone jack or at wall jack. Test the telephone in a different wall jack. If it works, the first jack may be defective.

HAVE DIAL TONE BUT CANNOT DIAL OUT

Check if the **PULSE/TONE** switch is in the correct position.

REDIAL BUTTON DOES NOT FUNCTION

The telephone may have been momentarily disconnected from the telephone jack.

STATIC

Check to see if the coiled handset cord is loose. Try a different phone in the wall jack. If you still get static, the problem is in the line. Call the telephone company.

BLANK SCREEN

Check if the adapter is connected properly

CALLERS ARE NOT DISPLAYED ON THE SCREEN

1. Verify that you have subscribed to the appropriate service (Caller ID and Call Waiting Caller ID) from your telephone company. If you only subscribed to the Caller ID service this unit will not display the call waiting caller ID information.
2. Check if your answering machine is set to answer the call before 2 rings.

NO CALLER INFORMATION IS DISPLAYED WHEN HEARING THE CALL WAITING AUDIO SOUND

1. Verify that you have subscribed to the Call Waiting Caller ID service from your telephone company.

MESSAGE ERROR HAPPENS FREQUENTLY

1. Caller information was not transmitted properly. Check with your telephone company to see if there is a problem with your phone line.

Since our special design will always retain your stored call records, we encourage you to disconnect all the telephone cords and adapter; and then reinstall the unit step by step per this instruction manual before you ask for service.

SPECIAL NOTE: *The call records will not be erased when the adapter is disconnected. A special E2PROM design allows the unit to always retain your stored call records after you disconnect the adapter*

IN CASE OF POWER FAILURE

If AC Power is lost, outgoing calls can only be made using DTMF dialing on Line 1.

MAINTENANCE INFORMATION

Treat your telephone equipment with care for trouble-free performance. Avoid dropping the handset. Carefully place the handset on-hook after use.

Avoid putting near heating appliances and devices that generate electrical noise (for example, motors and florescent lamps).

Clean your telephone equipment with a damp cloth. Stains may be removed with a mild soap. Do not use liquid or aerosol detergents or cleaning agents.

Do not expose to direct sunlight or moisture.

Retain the original package in case you need to ship it at a later date.

REPAIR OF YOUR TELEPHONE

DO NOT ATTEMPT TO REPAIR THIS PRODUCT YOURSELF. Call Waiting Caller ID Telephones manufactured by CORTELCO must be returned to us for repair.

You can return your telephone to CORTELCO for repair or replacement in accordance with our LIMITED WARRANTY.

DATE-OF-PURCHASE CORTELCO warrants **THIS PRODUCT** against defects in material and workmanship in accordance with our LIMITED WARRANTY. If your telephone is returned for repair, include a copy of your sales receipt containing the date-of-purchase. **DO NOT INCLUDE THE ORIGINAL SALES RECEIPT.**

If date-of-purchase is not included, the factory date printed on the label on the bottom of your telephone will be used as the date-of-purchase. The factory date allows six months for distribution and sale of this product.

If you return your telephone for repair, the warranty period is not extended. The original date-of-purchase continues to apply to your warranty.

OUT-OF-WARRANTY REPAIR We will repair this product for a nominal fee after the LIMITED WARRANTY has expired if you send it to us in a complete and undamaged condition. The repaired Call Waiting ID will be shipped to you C.O.D., freight collect.

RETURN-FOR-REPAIR PACKAGING If you are returning a unit to us for repair, package it carefully, preferably in the original carton. Be sure to include your return address, a copy of the sales receipt showing date-of-purchase, and a note describing the problem you have with your Call Waiting Caller ID Telephone. Shipping must be prepaid. If the telephone is in warranty, it will be repaired or replaced, at our option, at no cost to you, and it will be returned shipping prepaid.

Ship your Call Waiting Caller ID (shipping prepaid) to:

CORTELCO
REPAIR CENTER
1703 SAWYER ROAD
CORINTH, MS 38834

THE FCC WANTS YOU TO KNOW

Part 68 is a Federal regulation which requires equipment to be tested and registered with the FCC prior to its connection to the network. This equipment complies with Part 68 of FCC rules. On the bottom of the telephone is a label that contains, among other information, the FCC Registration Number and the Ringer Equivalence Number (REN) for this equipment. You must, upon request, provide this information to your telephone company.

The **Ringer Equivalence Number**, which is used to determine the number of devices you may connect to your phone line, indicates the amount of power that your telephone draws from the telephone company line during ringing. If you have more than one telephone (or other terminal device) connected to the telephone company line, you should total the ringer equivalence numbers (REN s), and be sure that the total is not more than five. Your telephones may not ring if the total is more than five. Also, in some rural locations, your telephone may not ring if the REN total is more than three.

RESTRICTIONS You must not connect your telephone to coin-operated lines or party lines.

INSTALLATION This model telephone must be connected to the telephone company lines through a modular jack. The required USOC for the modular jack is RJ11C for desk mounting and RJ11W for wall mounting. The USOC number is printed on the label on the bottom of your telephone.

HEARING-AID COMPATIBILITY The handset on your telephone will work with magnetically-coupled hearing aids. You can use a hearing aid equipped with a T (Telephone) switch.

IN CASE OF TROUBLE If your telephone should cause problems on the telephone line, the telephone company can temporarily disconnect your service. The telephone company must then notify and allow you to correct the problem.

The telephone company may from time to time change its lines or equipment. They must notify you if planned changes will affect your telephone service, to allow you to take steps to prevent interruptions.

Part 15 regulates the electromagnetic energy emitted by equipment to minimize interference to radio, television, and other wireless devices. This telephone complies with Part 15 of the FCC Rules. In the unlikely event that interference occurs, move the telephone and/or radio, television, etc. to increase the separation distance.

LIMITED WARRANTY

If this product was purchased by you new in the U.S. or Puerto Rico, **CORTELCO** warrants it against defects in material and workmanship for a period of one (1) year from the date of original purchase. This warranty is in lieu of all other express warranties. During the warranty period, **CORTELCO** agrees to repair or, at its option, replace the defective product, or any part of it without charge for parts or labor. This is your exclusive remedy. This warranty does not cover damage resulting from accident, misuse, abuse, improper installation or operation, lack of reasonable care, the affixing of any attachment not provided by **CORTELCO** with the product and loss of parts. The warranty is voided in the event any unauthorized person alters or repairs the unit.

Telephone companies use different types of equipment and offer various types of services to customers. **CORTELCO does not warrant that this product is compatible with the type of equipment of any particular phone company or the services provided by it.**

CORTELCO DISCLAIMS ANY IMPLIED WARRANTY, INCLUDING THE WARRANTY OF MERCHANTABILITY AND THE WARRANTY OF FITNESS FOR A PARTICULAR PURPOSE, AS OF THE DATE ONE YEAR FROM THE ORIGINAL PURCHASE OF THE PRODUCT. **CORTELCO** ASSUMES NO RESPONSIBILITY FOR ANY SPECIAL, INCIDENTAL OR CONSEQUENTIAL DAMAGES.

THIS WARRANTY GIVES YOU SPECIFIC LEGAL RIGHTS, AND YOU MAY HAVE OTHER RIGHTS WHICH VARY FROM STATE TO STATE. SOME STATES DO NOT ALLOW THE EXCLUSION OR LIMITATION OF SPECIAL, INCIDENTAL OR CONSEQUENTIAL DAMAGES OR LIMITATIONS ON HOW LONG AN IMPLIED WARRANTY LASTS, SO THE ABOVE EXCLUSION AND LIMITATION MAY NOT APPLY TO YOU.

If failure occurs and your Call Waiting ID is in warranty, service shall be provided by returning it to **CORTELCO - Repair Center, 1703 Sawyer Road, Corinth, Mississippi 38834, shipping prepaid.** The product will be repaired or replaced if examination by us determines the product to be defective. Call Waiting IDs received damaged as a result of shipping will require you to file a claim with the carrier.