

ART-575W
Spectrum™ 575W

USER MANUAL

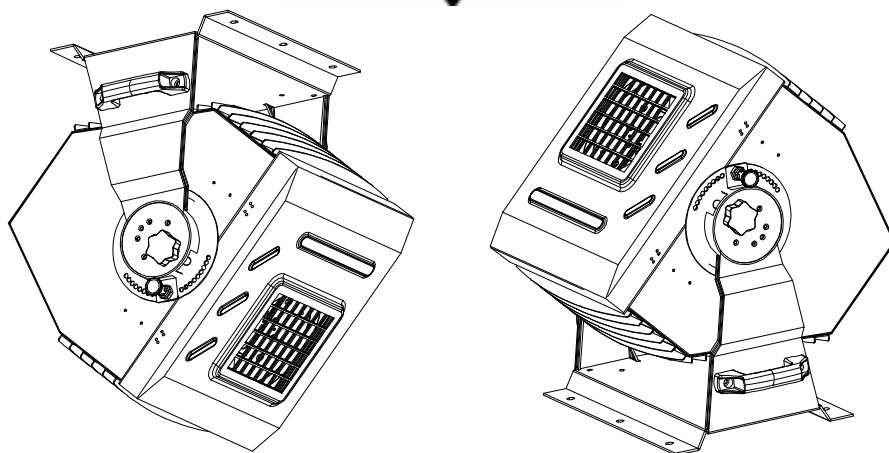

CHAUVET, 3000 N 29th Ct, Hollywood, FL 33020 U.S.A
(800) 762-1084 – (954) 929-1115
FAX (954) 929-5560
www.chauvetlighting.com

TABLE OF CONTENT

TABLE OF CONTENT	2
BEFORE YOU BEGIN	3
WHAT IS INCLUDED	3
UNPACKING INSTRUCTIONS	3
AC POWER	3
SAFETY INSTRUCTIONS	3
INTRODUCTION	4
TECHNICAL FEATURES	4
FEATURES	4
DMX CHANNEL SUMMARY	4
PRODUCT OVERVIEW	5
SETUP	6
LAMP	6
Lamp installation	6
Lamp Alignment How-To	7
POWER	7
INSTALLATION	8
Orientation	8
Floor Mounting	8
Truss Mounting	8
Power configuration	9
Wiring the connector	9
Data Cables & Linking	9
OPERATING INSTRUCTIONS	10
OPERATING MODES	10
Master/Slave & Stand-Alone	10
Accessing internal programs in Master mode	11
Built-in Programs chart	12
DMX Mode	13
Setting the starting address	13
APPENDIX	16
DMX PRIMER	16
Fixture Linking	16
DMX CHANNEL VALUES	17
PHOTO METRICS	18
DIPSWITCH LOCATION	19
MAINTENANCE	20
RETURNS PROCEDURE	20
CLAIMS	20
GENERAL TROUBLESHOOTING	21
TECHNICAL SPECIFICATIONS	22
TECHNICAL SUPPORT	22

BEFORE YOU BEGIN

What is included

- ART-575W – Spectrum™ 575W
- (1) HSR575 HID lamp
- Power cord attached with bare ends
- Warranty Card & Manual

Unpacking Instructions

Immediately upon receiving a fixture, carefully unpack the carton, check the contents to ensure that all parts are present, and have been received in good condition. Notify the shipper immediately and retain packing material for inspection if any parts appear damaged from shipping or the carton itself shows signs of mishandling. Save the carton and all packing materials. In the event that a fixture must be returned to the factory, it is important that the fixture be returned in the original factory box and packing.

AC Power

To determine the power requirements for a particular fixture, see the label affixed to the back plate of the fixture or refer to the fixture's specifications chart. A fixture's listed current rating is its average current draw under normal conditions. All fixtures must be powered directly off a switched circuit and cannot be run off a rheostat (variable resistor) or dimmer circuit, even if the rheostat or dimmer channel is used solely for a 0% to 100% switch. Before applying power to a fixture, check that the source voltage matches the fixture's requirement. Check the fixture or device carefully to make sure that if a voltage selection switch exists that it is set to the correct line voltage you will use.

Warning! *Verify that the internal multi-tap transformer is set to match the line voltage applied. All fixtures must be connected to circuits with a suitable Earth Ground.*

Safety Instructions



Please read these instructions carefully, which includes important information about the installation, usage and maintenance?



- Please keep this User Guide for future consultation. If you sell the unit to another user, be sure that they also receive this instruction booklet.
- Always make sure that you are connecting to the proper voltage and that the line voltage you are connecting to is not higher than that stated on decal or rear panel of the fixture.
- To prevent risk of fire or shock make sure there are no flammable materials close to the unit while operating.
- The unit must be installed in a location with adequate ventilation, at least 50cm from adjacent surfaces. Be sure that no ventilation slots are blocked.
- Always disconnect from power source before servicing or replacing lamp or fuse and be sure to replace with same lamp source.
- Secure fixture to fastening device using a safety chain. Never carry the fixture solely by its head. Use its carrying handles.
- Maximum ambient temperature is Ta: 50°. Do not operate fixture at temperatures higher than this.
- In the event of serious operating problem, stop using the unit immediately. Never try to repair the unit by yourself. Repairs carried out by unskilled people can lead to damage or malfunction. Please contact the nearest authorized technical assistance center. Always use the same type spare parts.
- Don't connect the device to a dimmer pack.
- Make sure power cord is never crimped or damaged.
- Never disconnect power cord by pulling or tugging on the cord.
- Avoid direct eye exposure to lamp while it is on.
- **Check your power cables carefully to ensure that there are no cuts or breach of integrity of the outer shell at any point. Moisture could be drawn up inside the cable due to a vacuum generated by heat inside the fixture.**
- **Protect connectors for both power and data lines in a weatherproof housing or a weatherproof junction box.**
- **If you don't hard wire the fixture to a weatherproof junction box, make sure to use an IP55 or better rated connector for both plugs and connectors.**
- **Do not connect to a dimmer system.**
- **For your protection, the fixture must be grounded and the AC mains supply must be outfitted with a circuit breaker and ground-fault protection.**

Caution! *There are no user serviceable parts inside the unit. Do not open the housing or attempt any repairs yourself. In the unlikely event your unit may require service, please contact CHAUVET.*

INTRODUCTION

Technical Features

- 8-channel DMX-512 exterior color wash
- CMY color mixing system
- Vectored movement of all color blades for super smooth and slow transitions
- 11 instantly selectable preset color macros
- Variable mechanical dimmer (0 ~ 100%)
- Variable mechanical zoom (7°~40°)
- 32 built in color change programs at varying speeds

Features

- Durable and weatherproof IP-54 rated housing
- Very low noise operation (convection cooled) <- look for a fan??
- No control necessary, Master/Slave operation
- Frosted lens diffuser
- Micro-stepping motors
- Thermal switch protection

DMX Channel Summary

CHANNEL	FUNCTION
1	Vector speed
2	Yellow
3	Magenta
4	Cyan
5	Color Macros
6	Dimmer
7	Zoom
8	Automatic

Product Overview

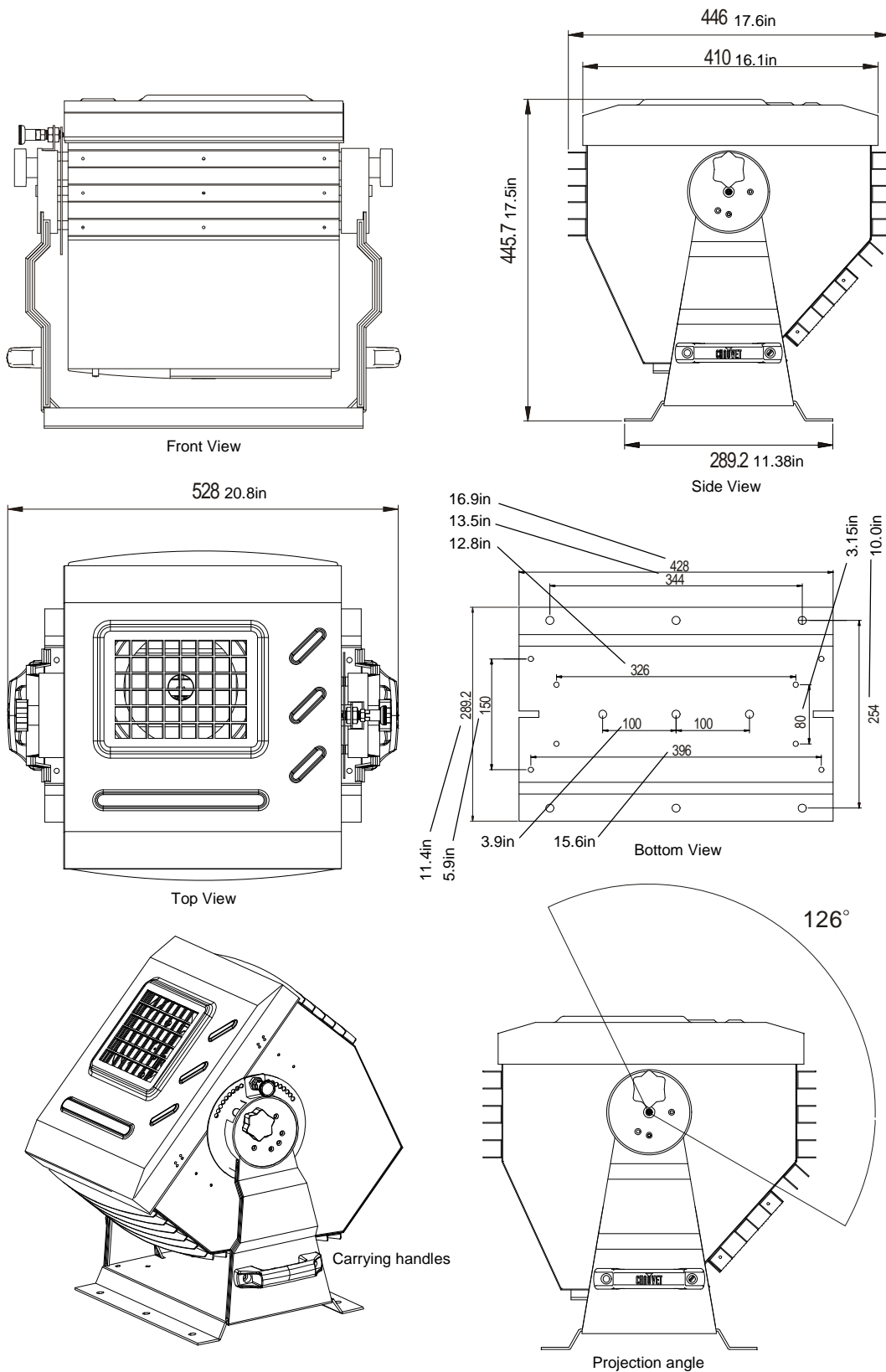

SETUP

Lamp

You will need to install a lamp prior to the initial operation of the fixture.

Warning! *When replacing the lamp, please wait 15 minutes after powering down to allow the unit to cool down! Always disconnect from main power prior to lamp replacement.*

Do not touch the envelope (glass area) of the bulb with bare hands. If this happens, clean the lamp with alcohol and wipe it with a lint free cloth before installation.

LAMP INSTALLATION

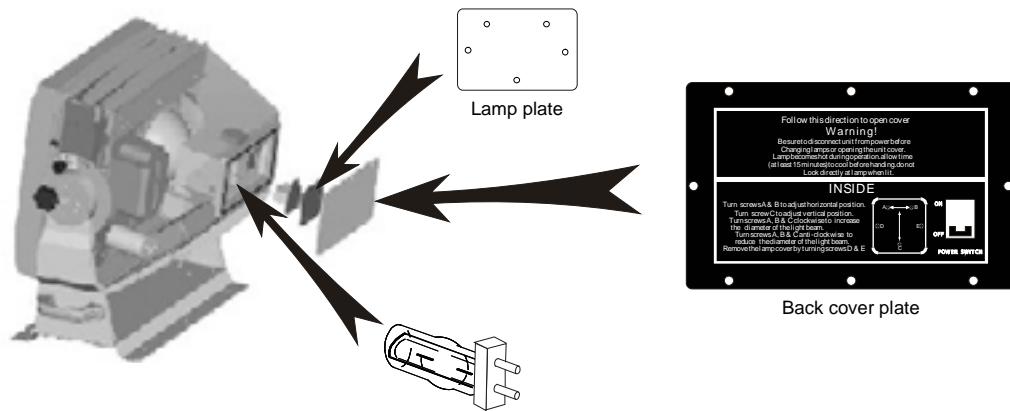

- 1) Remove the back cover plate by removing all 8 screws on the rear of the fixture.
- 2) Remove the screws (D) and (E) on the lamp plate. Pull out the lamp cover plate.
- 3) With lamp socket plate out and the lamp accessible, if replacing the lamp, remove old lamp first.
- 4) Holding the new lamp by its base, align the small pin on the lamp with the small hole in the socket and insert the lamp squarely until the retaining clips on the lamp socket secures the lamp tightly.
- 5) Clean the glass/envelope of the bulb with an alcohol wipe or equivalent.
- 6) Holding the lamp plate, insert the tip of the lamp into the fixture with extreme care. Navigate the lamp all the way until it reaches the reflector and the lamp base plate touches the bottom plate of the fixture.
- 7) Align the screw holes and fasten the screws back onto the lamp plate.
- 8) Turn the fixture on and adjust the lamp alignment screws until the brightest most even area of the beam is in the center of your spot. It may be necessary for you to use a controller in order to command the fixture to display a white beam. Visit the "Lamp Alignment How-To" section in this manual for further reading and tips on the subject.
- 9) Place the back cover plate back on the fixture and screw on securely.

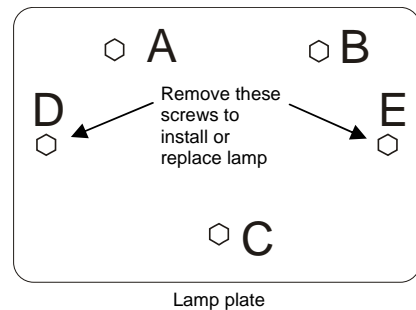

LAMP ALIGNMENT HOW-TO

Often, after a new installation of a lamp, you will find that there is an uneven field of light or what is referred to as a hot spot. This is due to the most intense point of the lamp source not being positioned optimally within the reflector.

There are three lamp alignment screws provided at the base of the projector head, behind the back cover plate. Turning these screws allow you to optimize the projection quality of the spot as well as the overall intensity of the beam.

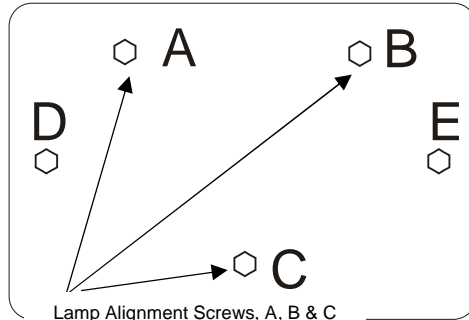

1. Project a white flood against any flat surface. Preferably the surface should be white or pastel in color.
2. Turning the lamp alignment screws, try to position the hot spot in the center of the beam as best as possible. This could require many attempts on your part.
3. Once the hot spot is in the center of the spot, do your best to turn all screws equally as to affect movement up or down within the reflector.
4. As you move in and out of optimum lamp focus, you will see the hot spot either gets wider or narrower. The goal is to either totally diminish the hot spot by having it widen and spread across the entire spot or moving the hot spot so that it covers as much of the beam spot area as possible.

Power

Warning! Verify that the internal multi-tap transformer is set to match the line voltage applied and that the proper fuse is installed for the appropriate voltage setting. All fixtures must be connected to circuits with a suitable Earth Ground.

CAUTION!

This lighting fixture comes from the factory with a 120V fuse pre-installed. To operate this fixture in 230V, please replace the external fuse with the supplied 230V fuse.

- To determine the power requirements for a particular fixture, see the label affixed to the back plate of the fixture or refer to the fixture's specifications chart.
- A fixture's listed current rating is its average current draw under normal conditions.
- All fixtures must be powered directly off a switched circuit and cannot be run off a rheostat (variable resistor) or dimmer circuit, even if the rheostat or dimmer channel is used solely for a 0% to 100% switch.
- Before applying power to a fixture, check that the source voltage matches the fixture's requirement.
- All fixtures must be connected to circuits with a suitable Earth Ground.

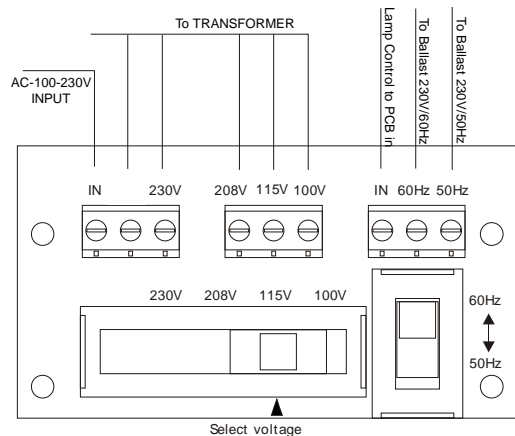

POWER CABLE	PIN	INTERNATIONAL
BROWN	Live	L
BLUE	Neutral	N
YELLOW/GREEN	Earth	EG (Ground)

OPERATING VOLTAGE	MUST USE CORRECT FUSE
120V	15A
230V	10A

CAUTION!

Voltage selector switch is accessible by removing the front cover of the fixture. Re-wiring of the transformer should be conducted by a certified electrician or lighting professional.

Installation

ORIENTATION

This fixture is designed to achieve an Ingress Protection Rating of 54 only when the fixture's base is attached to a level horizontal surface. The ART-575W can be mounted both upright and on a truss system.

Warning

It is important never to obstruct the fan or vents pathway.

- When selecting installation location, take into consideration lamp replacement access and routine maintenance.
- Safety cables should always be used.
- The fixture must have a minimum of 1 meter distance from combustible materials.

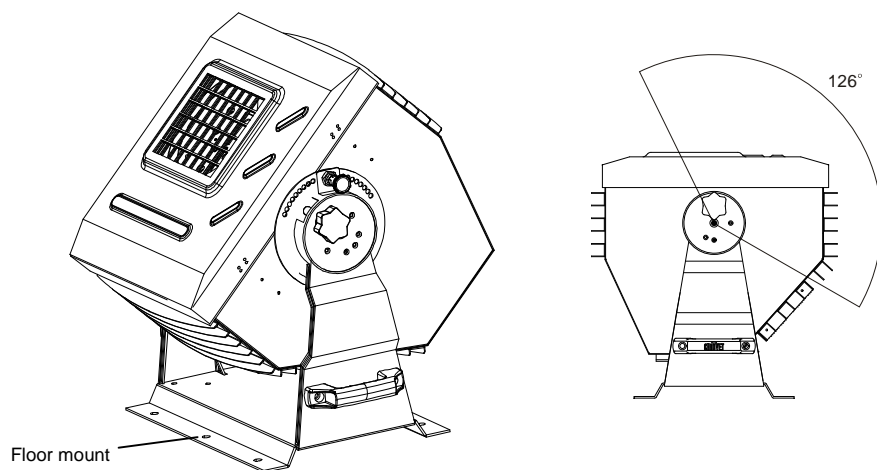

FLOOR MOUNTING

- 1) If connected, be sure to always disconnect from main power before installing fixture.
- 2) The ART-575W is constructed with mounting bracket/yoke.
- 3) Bolt fixture onto a leveled floor surface using floor mount holes and 3/8" diameter bolts.

TRUSS MOUNTING

The ART-575W includes 3 clamp mounting brackets to which half-coupler pipe clamps can be bolted.

- 1) Verify the structure can hold 10 times the weight of all fixtures to-be installed.
- 2) Attach a minimum of two to three clamps where illustrated.

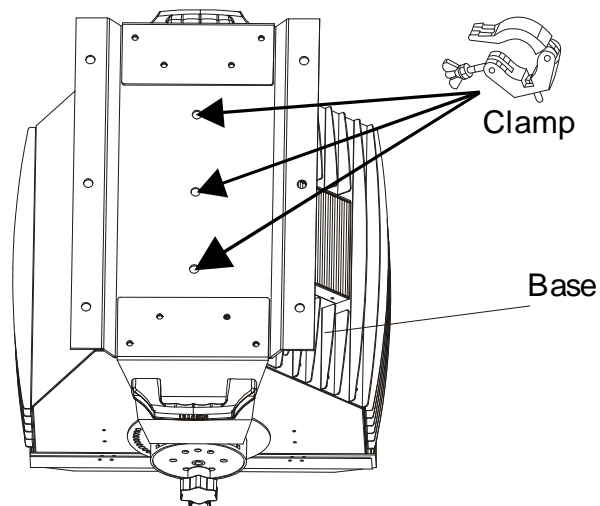

Power configuration

The factory power settings will be printed on the fixtures serial label. Make sure that your local AC voltage matches that required by the fixture.

115V / 50Hz AC
230V / 60Hz AC

The ART-575W is equipped with a 3-conductor electrical cable for connecting to an AC power supply. The cable enters the fixture through a cable gland that fits 5 to 10mm diameter cables. Because the ART-575W fixture is built for permanent exterior installations please adhere to the following safety and installation precautions.

SAFETY PRECAUTIONS!

- Check your power cables carefully to ensure that there are no cuts or breach of integrity of the outer shell at any point. Moisture could be drawn up inside the cable due to a vacuum generated by heat inside the fixture.
- Protect connectors for both power and data lines in a weatherproof housing or a weatherproof junction box.
- If you don't hard wire the fixture to a weatherproof junction box, make sure to use an IP54 or better rated connector for both plugs and connectors.
- Do not connect to a dimmer system.
- For your protection, the fixture must be grounded and the AC mains supply must be outfitted with a circuit breaker and ground-fault protection.

Wiring the connector

	Visible Markings	(USA) Wires	(EU) Wires	Connector
Live	"L"	Black	Brown	Yellow or brass
Neutral	"N"	White	Blue	Silver
Ground	"W"	Green	Yellow/Green	Green

Consult an electrician if you have any doubts about the proper wiring connection during your installation.

Data Cables & Linking

Data linking is required for synchronized operation as well as DMX controller operation. The ART-575W fixture is equipped with two 24 AWG data cables that exit the fixture through a cable gland. Both cables are equipped with XLR connectors. The locking 3-pin male is for data input and the 3-pin female is for data output. The "DMX Primer" in the Appendix section details more information about wiring. In short, a 3-pin connector is wired pin-1 to (ground), pin-2 to (signal) and pin-3 to (hot).

Use RS-485 data cables designed for outdoor use.
(24 AWG) for runs up to 1000 feet or 300 meters
(26 AWG) for runs up to 1640 feet (500 meters)

Currently, neither the data cables nor the power cable is weather rated. Consider changing these for exterior weather rated equivalents. In addition, follow the same "Safety Precautions" as listed in the section above "Power configuration".

Tips!

- Use shielded twisted-pair cable designed for RS-485 devices.
- Never use a "Y" connector to split the link. To split the serial link into branches use an Opto-Isolated signal splitter.
- Limit one universe of DMX-512 to no more than 32 devices.
- Use a terminator at the end of a run. A terminator can be made by soldering a 120ohm, 0.25 watt resistor between pins 2 and 3 of a male XLR connector.

OPERATING INSTRUCTIONS

Operating Modes

- Stand-Alone mode will allow the independent execution of programs and a Master/Slave mode will allow the command of up to as many units you want in a synchronized manner.
- DMX control mode will provide the greatest flexibility and creativity. You can create an unlimited range of chase patterns at any speeds

MASTER/SLAVE & STAND-ALONE

Stand-alone is an independent fixture operating state which basically means without the use of any controlling device. The Spectrum™ 575 Exterior Wash fixtures have 42 internal programs that can be manually selected using the fixture's dipswitches. Once set, every time the fixture is powered, the program selected will automatically execute. If you own multiple Spectrum™ fixtures, you can link them together so that they all follow one leader in synchrony called the (master). This operating state is called Master/Slave mode.

The Master/Slave mode allows you to link multiple units in a daisy chain fashion. In this mode, the first unit in the daisy chain will automatically command all other units following. Simply connect each fixture in a daisy like fashion using qualified 3 pin DMX cables and address master and slave fixtures as described below. The first unit in the chain will operate in a Stand-Alone mode and all units following will synchronize to the first unit.

- 1) Connect the (male) 3 pin connector side of the DMX cable to the output (female) 3 pin connector of the first fixture.
- 2) Connect the end of the cable coming from the first fixture which will have a (female) 3 pin connector to the input connector of the next fixture consisting of a (male) 3 pin connector. Then, proceed to connect from the output as stated above to the input of the following fixture and so on as illustrated below in "Daisy Chain Connection".

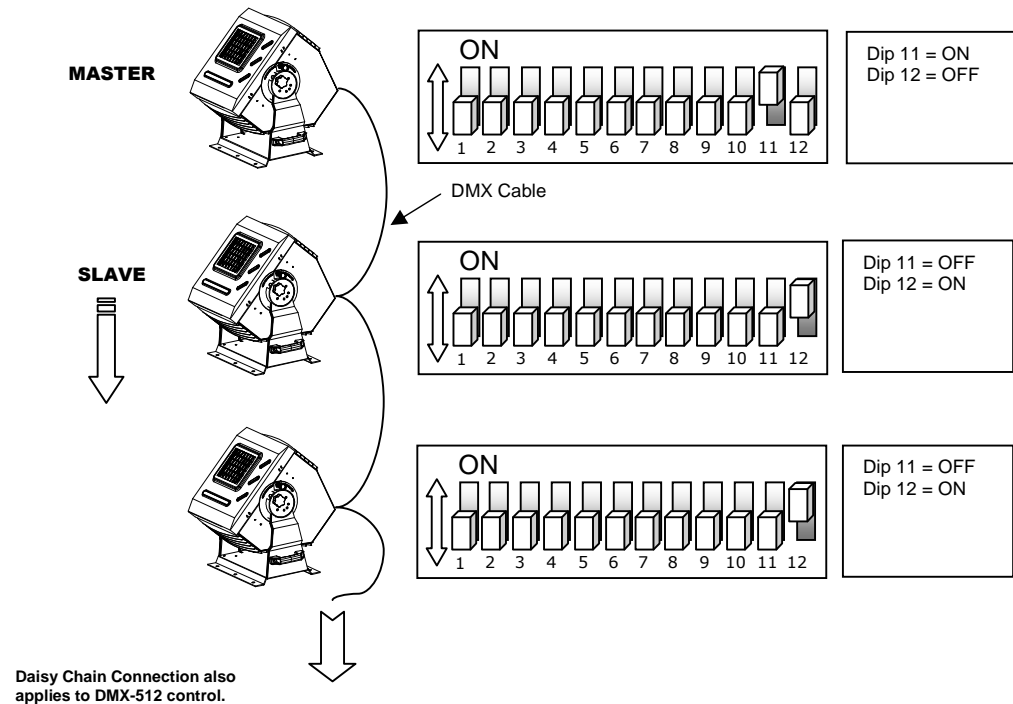

ACCESSING INTERNAL PROGRAMS IN MASTER MODE

The programs are available while the fixture is set to the **Master** mode which is dipswitch 11 to ON and 12 to OFF. The programs are assigned to the first 42 channels or numerical values which can be initialized using the dipswitches.

Each dipswitch has an associated value. These values are not printed on the fixture so it is very important that you read this section thoroughly. Adding the value of each switch in the ON position will provide the channel address. Determining which switches to toggle ON given a specific channel address can be accomplished in the following manner. By subtracting the largest switch value possible from the selected channel address which does not cause a negative number.

This is the exact method for computing DMX address values as well and this section will be repeated.

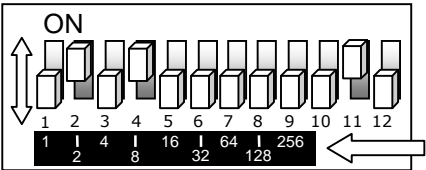
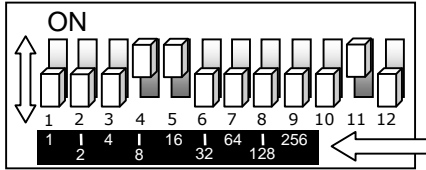
EXAMPLE CHANNEL ADDRESS	THE CHANNEL ADDRESSES WERE SELECTED AT RANDOM.																							
<p>CHANNEL 10 PIN # 4= 8 PIN # 2= 2 TOTAL = 10</p>		<p>Binary values</p>																						
<p>CHANNEL 24 PIN # 5= 16 PIN # 4= 8 TOTAL = 24</p>		<p>Binary values</p>																						
<p>RESOLVING ADDRESS USING SIMPLE MATH. ADDRESS 42</p>	<p>42 - (32) = 10, Turn ON Dip # 6 10 - (8) = 2, Turn ON Dip # 4 2 - (2) = 0, Turn ON Dip # 2</p>	<table border="1"> <thead> <tr> <th>DIP SWITCH</th> <th>(CH VALUE)</th> </tr> </thead> <tbody> <tr><td>1</td><td>1</td></tr> <tr><td>2</td><td>2</td></tr> <tr><td>3</td><td>4</td></tr> <tr><td>4</td><td>8</td></tr> <tr><td>5</td><td>16</td></tr> <tr><td>6</td><td>32</td></tr> <tr><td>7</td><td>64</td></tr> <tr><td>8</td><td>128</td></tr> <tr><td>9</td><td>256</td></tr> <tr><td>10</td><td></td></tr> </tbody> </table>	DIP SWITCH	(CH VALUE)	1	1	2	2	3	4	4	8	5	16	6	32	7	64	8	128	9	256	10	
DIP SWITCH	(CH VALUE)																							
1	1																							
2	2																							
3	4																							
4	8																							
5	16																							
6	32																							
7	64																							
8	128																							
9	256																							
10																								

The page following contains an itemized chart of the built-in programs and their associated channel address.

BUILT-IN PROGRAMS CHART

The channels address dipswitch settings for On and Off are displayed using binary numbers (1 and 0). 1 represents ON and 0 represent OFF. Remember that dipswitch 11 is also turned ON for Master mode.

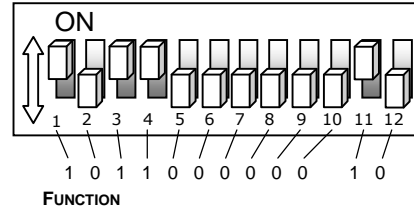

CHANNEL	DIPSWITCH 1-2-3-4-5-6-7-8-9-10	FUNCTION
0	0 0 0 0 0 0 0 0 0 0	Static Color: White
1	1 0 0 0 0 0 0 0 0 0	Static Color: Red
2	0 1 0 0 0 0 0 0 0 0	Static Color: Yellow (soft orange edge)
3	1 1 0 0 0 0 0 0 0 0	Static Color: Green
4	0 0 1 0 0 0 0 0 0 0	Static Color: Cyan
5	1 0 1 0 0 0 0 0 0 0	Static Color: Light Blue
6	0 1 1 0 0 0 0 0 0 0	Static Color: Blue
7	1 1 1 0 0 0 0 0 0 0	Static Color: Dark Blue
8	0 0 0 1 0 0 0 0 0 0	Static Color: Purple
9	1 0 0 1 0 0 0 0 0 0	Static Color: Magenta
10	0 1 0 1 0 0 0 0 0 0	Static Color: White (soft pink edge)
		Rapid Color Change; Red, Yellow, Green, Blue, Cyan, Magenta
11	1 1 0 1 0 0 0 0 0 0	Every 5 seconds
12	0 0 1 1 0 0 0 0 0 0	Every 10 seconds
13	1 0 1 1 0 0 0 0 0 0	Every 30 seconds
14	0 1 1 1 0 0 0 0 0 0	Every 60 seconds
		Smooth Color Change; Red, Yellow, Green, Blue, Cyan, Magenta
15	1 1 1 1 0 0 0 0 0 0	Every 5 seconds
16	0 0 0 0 1 0 0 0 0 0	Every 10 seconds
17	1 0 0 0 1 0 0 0 0 0	Every 30 seconds
18	0 1 0 0 1 0 0 0 0 0	Every 60 seconds
		Rapid Color Change; Red, Orange, Green, Cyan, Light Blue, Blue, UV Filter, Purple, Magenta, Auvergne
19	1 1 0 0 1 0 0 0 0 0	Every 5 seconds
20	0 0 1 0 1 0 0 0 0 0	Every 10 seconds
21	1 0 1 0 1 0 0 0 0 0	Every 30 seconds
22	0 1 1 0 1 0 0 0 0 0	Every 60 seconds
		Smooth Color Change; Red, Orange, Green, Cyan, Light Blue, Blue, UV Filter, Purple, Magenta, Auvergne
23	1 1 1 0 1 0 0 0 0 0	Every 5 seconds
24	0 0 0 1 1 0 0 0 0 0	Every 10 seconds
25	1 0 0 1 1 0 0 0 0 0	Every 30 seconds
26	0 1 0 1 1 0 0 0 0 0	Every 60 seconds
		Rapid Color Change; White, Red, Orange, Green, Blue, Light Blue, Magenta
27	1 1 0 1 1 0 0 0 0 0	Every 5 seconds
28	0 0 1 1 1 0 0 0 0 0	Every 10 seconds
29	1 0 1 1 1 0 0 0 0 0	Every 30 seconds
30	0 1 1 1 1 0 0 0 0 0	Every 60 seconds
		Smooth Color Change; White, Red, Orange, Green, Blue, Light Blue, Magenta
31	1 1 1 1 1 0 0 0 0 0	Every 5 seconds
32	0 0 0 0 1 0 0 0 0 0	Every 10 seconds
33	1 0 0 0 1 0 0 0 0 0	Every 30 seconds
34	0 1 0 0 1 0 0 0 0 0	Every 60 seconds
		Rapid Color Change; White, Red, Orange, Green, Cyan, Light Blue, Blue, UV Filter, Purple, Magenta, Auvergne
35	1 1 0 0 0 1 0 0 0 0	Every 5 seconds
36	0 0 1 0 0 1 0 0 0 0	Every 10 seconds
37	1 0 1 0 0 1 0 0 0 0	Every 30 seconds
38	0 1 1 0 0 1 0 0 0 0	Every 60 seconds
		Smooth Color Change; White, Red, Orange, Green, Cyan, Light Blue, Blue, UV Filter, Purple, Magenta, Auvergne
39	1 1 1 0 0 1 0 0 0 0	Every 5 seconds
40	0 0 0 1 0 1 0 0 0 0	Every 10 seconds
41	1 0 0 1 0 1 0 0 0 0	Every 30 seconds
42	0 1 0 1 0 1 0 0 0 0	Every 60 seconds

DMX MODE

Operating in a DMX Control mode environment gives the user the greatest flexibility when it comes to customizing or creating an environment. Simply address all fixtures sequentially and use any universal DMX controller.

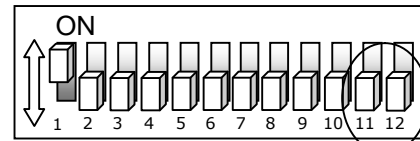

DMX Mode: Set Dipswitches 11 & 12 to Off

- 1) Create the serial data link by connecting all fixtures in a daisy chain.
- 2) Connect the (male) 3 pin connector side of the DMX cable to the output (female) 3 pin connector of the first fixture.
- 3) Connect the end of the cable coming from the first fixture which will have a (female) 3 pin connector to the input connector of the next fixture consisting of a (male) 3 pin connector. Then, proceed to connect from the output as stated above to the input of the following fixture and so on.

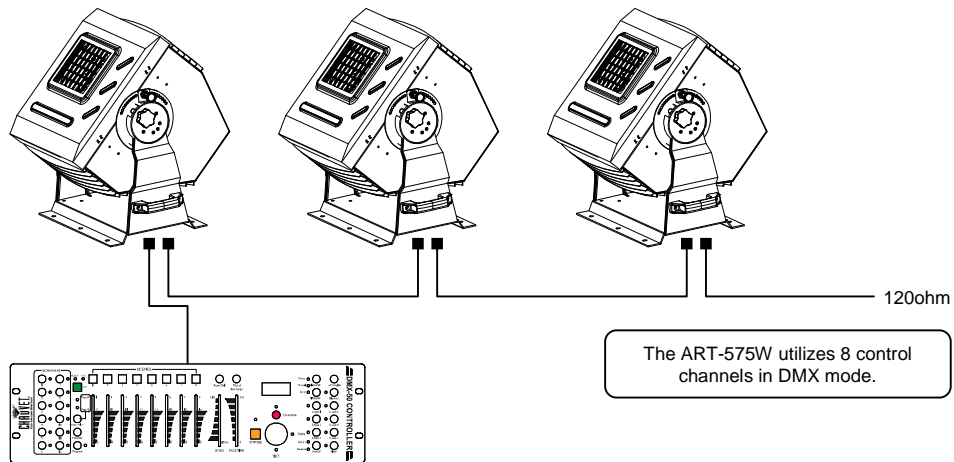

SETTING THE STARTING ADDRESS

This DMX mode enables the use of a universal DMX controller device. Each fixture requires a "start address" from 1 to 511. A fixture requiring one or more channels for control begins to read the data on the channel indicated by the start address. For example, a fixture that occupies or uses 6 channels of DMX and was addressed to start on DMX channel 100, would read data from channels: 100, 101, 102, 103, 104, and 105. Choose start addresses so that the channels used do not overlap and notate the start address selected for future reference.

If this is your first time addressing a fixture using the DMX-512 control protocol then I suggest jumping to the Appendix Section and read the heading "DMX Primer". It contains very useful information that will help you understand its use.

Set the start address using the group of dipswitches located underneath the top cover of the fixture illustrated in the **Appendix Section "Dipswitch Location"**. Each dipswitch has an associated value. Adding the value of each switch in the ON position will provide the start address. Determining which switches to toggle ON given a specific start address can be accomplished in the following manner. By subtracting the largest switch value possible from the selected start address which does not cause a negative number.

EXAMPLE DMX CHANNEL ADDRESS

THE DMX CHANNEL ADDRESSES WERE SELECTED AT RANDOM.

CHANNEL 10
PIN # 4= 8
PIN # 2= 2
TOTAL = 10

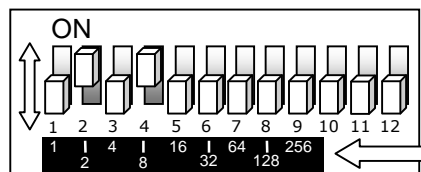

Binary values

CHANNEL 24
 PIN # 5= 16
 PIN # 4= 8
 TOTAL= 24

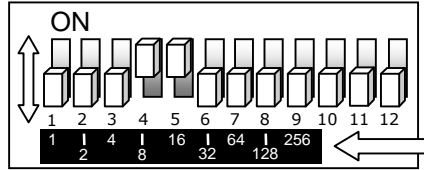

RESOLVING ADDRESS USING
 SIMPLE MATH.
 ADDRESS 42

42 - (32) = 10, Turn ON Dip # 6
 10 - (8) = 2, Turn ON Dip # 4
 2 - (2) = 0, Turn ON Dip # 2

DIP SWITCH	(DMX VALUE)
1	1
2	2
3	4
4	8
5	16
6	32
7	64
8	128
9	256
10	

The ART-575W utilizes 8 control channels to operate in DMX mode. Therefore, each fixture must be spaced and addressed in 8 channel increments as illustrated below.

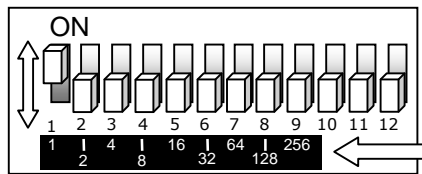
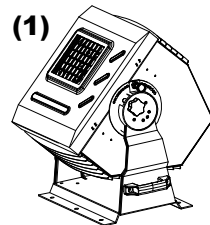

(1)
DMX 001

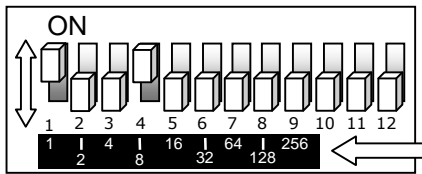
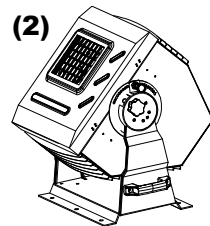

(2)
DMX 009

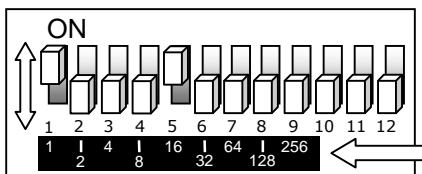
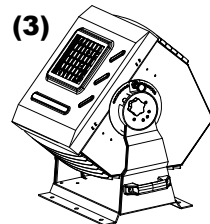

(3)
DMX 017

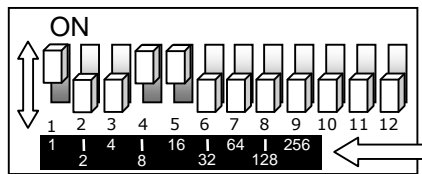
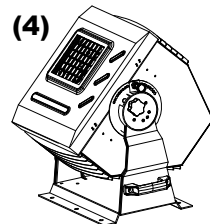

(4)
DMX 025

Notice that all fixtures are separated
 by 8 control channels.

The page following contains a cheat sheet which contains all possible DMX address values and associated dipswitch settings.

DMX Address Quick Reference Chart

Dip Switch Position

DMX DIP SWITCH SET					#9	0	0	0	0	0	0	0	0	1	1	1	1	1	1	1		
0=OFF					#8	0	0	0	0	1	1	1	1	0	0	0	0	1	1	1	1	
1=ON					#7	0	0	1	1	0	0	1	1	0	0	1	1	0	0	1	1	
X=OFF or ON					#6	0	1	0	1	0	1	0	1	0	1	0	1	0	1	0	1	1
#1	#2	#3	#4	#5																		
0	0	0	0	0		32	64	96	128	160	192	224	256	288	320	352	384	416	448	480		
1	0	0	0	0	1	33	65	97	129	161	193	225	257	289	321	353	385	417	449	481		
0	1	0	0	0	2	34	66	98	130	162	194	226	258	290	322	354	386	418	450	482		
1	1	0	0	0	3	35	67	99	131	163	195	227	259	291	323	355	387	419	451	483		
0	0	1	0	0	4	36	68	100	132	164	196	228	260	292	324	356	388	420	452	484		
1	0	1	0	0	5	37	69	101	133	165	197	229	261	293	325	357	389	421	453	485		
0	1	1	0	0	6	38	70	102	134	166	198	230	262	294	326	358	390	422	454	486		
1	1	1	0	0	7	39	71	103	135	167	199	231	263	295	327	359	391	423	455	487		
0	0	0	1	0	8	40	72	104	136	168	200	232	264	296	328	360	392	424	456	488		
1	0	0	1	0	9	41	73	105	137	169	201	233	265	297	329	361	393	425	457	489		
0	1	0	1	0	10	42	74	106	138	170	202	234	266	298	330	362	394	426	458	490		
1	1	0	1	0	11	43	75	107	139	171	203	235	267	299	331	363	395	427	459	491		
0	0	1	1	0	12	44	76	108	140	172	204	236	268	300	332	364	396	428	460	492		
1	0	1	1	0	13	45	77	109	141	173	205	237	269	301	333	365	397	429	461	493		
0	1	1	1	0	14	46	78	110	142	174	206	238	270	302	334	366	398	430	462	494		
1	1	1	1	0	15	47	79	111	143	175	207	239	271	303	335	367	399	431	463	495		
0	0	0	0	1	16	48	80	112	144	176	208	240	272	304	336	368	400	432	464	496		
1	0	0	0	1	17	49	81	113	145	177	209	241	273	305	337	369	401	433	465	497		
0	1	0	0	1	18	50	82	114	146	178	210	242	274	306	338	370	402	434	466	498		
1	1	0	0	1	19	51	83	115	147	179	211	243	275	307	339	371	403	435	467	499		
0	0	1	0	1	20	52	84	116	148	180	212	244	276	308	340	372	404	436	468	500		
1	0	1	0	1	21	53	85	117	149	181	213	245	277	309	341	373	405	437	469	501		
0	1	1	0	1	22	54	86	118	150	182	214	246	278	310	342	374	406	438	470	502		
1	1	1	0	1	23	55	87	119	151	183	215	247	279	311	343	375	407	439	471	503		
0	0	0	1	1	24	56	88	120	152	184	216	248	280	312	344	376	408	440	472	504		
1	0	0	1	1	25	57	89	121	153	185	217	249	281	313	345	377	409	441	473	505		
0	1	0	1	1	26	58	90	122	154	186	218	250	282	314	346	378	410	442	474	506		
1	1	0	1	1	27	59	91	123	155	187	219	251	283	315	347	379	411	443	475	507		
0	0	1	1	1	28	60	92	124	156	188	220	252	284	316	348	380	412	444	476	508		
1	0	1	1	1	29	61	93	125	157	189	221	253	285	317	349	381	413	445	477	509		
0	1	1	1	1	30	62	94	126	158	190	222	254	286	318	350	382	414	446	478	510		
1	1	1	1	1	31	63	95	127	159	191	223	255	287	319	351	383	415	447	479	511		

Dip Switch Position

DMX Address

APPENDIX

DMX Primer

There are 512 channels in a DMX-512 connection. Channels may be assigned in any manner. A fixture capable of receiving DMX-512 will require one or a number of sequential channels. The user must assign a starting address on the fixture that indicates the first channel reserved in the controller. There are many different types of DMX controllable fixtures and they all may vary in the total number of channels required. Choosing a start address should be planned in advance. Channels should never overlap. If they do, this will result in erratic operation of the fixtures whose starting address is set incorrectly. You can however, control multiple fixtures of the same type using the same starting address as long as the intended result is that of unison movement or operation. In other words, the fixtures will be slaved together and all respond exactly the same.

DMX fixtures are designed to receive data through a serial Daisy Chain. A Daisy Chain connection is where the DATA OUT of one fixture connects to the DATA IN of the next fixture. The order in which the fixtures are connected is not important and has no effect on how a controller communicates to each fixture. Use an order that provides for the easiest and most direct cabling. Connect fixtures using shielded two conductor twisted pair cable with three pin XLR male to female connectors. The shield connection is pin 1, while pin 2 is Data Negative (S-) and pin 3 is Data positive (S+). CHAUVET carries 3-pin XLR DMX compliant cables, DMX-10 (33'), DMX-4.5 (15') and DMX-1.5 (5')

FIXTURE LINKING

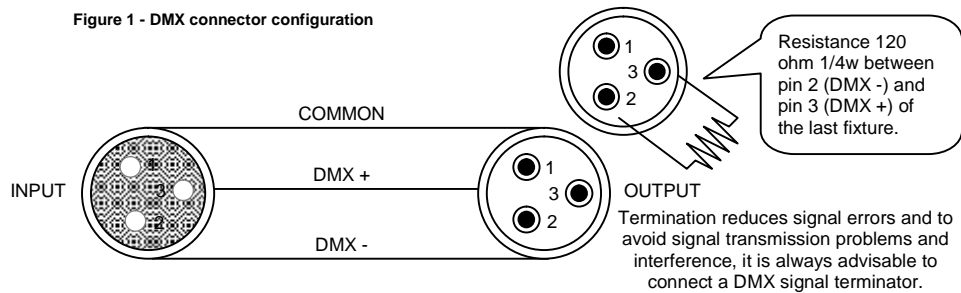

Note! *If you use a controller with a 5 pin DMX output connector, you will need to use a 5 pin to 3 pin adapter. CHAUVET Model No: DMX5M. The chart below details a proper cable conversion:*

3 PIN TO 5 PIN CONVERSION CHART

CONDUCTOR	3 Pin Female (output)	5 Pin Male (Input)
GROUND/SHIELD	Pin 1	Pin 1
DATA (-) SIGNAL	Pin 2	Pin 2
DATA (+) SIGNAL	Pin 3	Pin 3
DO NOT USE		Do not use
DO NOT USE		Do not use

DMX Channel Values

CHANNEL	VALUE	FUNCTION
1	000 ⇔ 255	Vector Control Speed for CMY and Dimmer 0 – 100%
2	000 ⇔ 255	Yellow 0 – 100%
3	000 ⇔ 255	Magenta 0 – 100%
4	000 ⇔ 255	Cyan 0 – 100%
5	000 ⇔ 255	Color Macros Red, Yellow (soft orange edge), Green, Cyan, Light Blue, Blue, Dark Blue, Purple, Magenta, White (soft pink edge)
6	000 ⇔ 255	Linear Dimmer 0 – 100%
7	000 ⇔ 255	Linear Zoom 7° – 40°
8	000 ⇔ 031	Programs Blackout
	032 ⇔ 038	Rapid Color Change: Red, Yellow, Green, Blue, Light Blue, Rose Red (5 seconds)
	039 ⇔ 045	(10 seconds)
	046 ⇔ 052	(30 seconds)
	053 ⇔ 059	(60 seconds)
	060 ⇔ 066	Smooth Color Change: Red, Yellow, Green, Blue, Light Blue, Rose Red (5 seconds)
	067 ⇔ 073	(10 seconds)
	074 ⇔ 080	(30 seconds)
	081 ⇔ 087	(60 seconds)
	088 ⇔ 094	Rapid Color Change; Red, Orange, Green, Sky Blue, Light Blue, Dark Blue, Purple, Rose Red, Pink (5 seconds)
	095 ⇔ 101	(10 seconds)
	102 ⇔ 108	(30 seconds)
	109 ⇔ 115	(60 seconds)
	116 ⇔ 122	Smooth Color Change; Red, Orange, Green, Sky Blue, Light Blue, Dark Blue, Purple, Rose Red, Pink (5 seconds)
	123 ⇔ 129	(10 seconds)
	130 ⇔ 136	(30 seconds)
	137 ⇔ 143	(60 seconds)
	144 ⇔ 150	Rapid Color Change; White, Red, Orange, Green, Blue, Light Blue, Rose Red (5 seconds)
	151 ⇔ 157	(10 seconds)
	158 ⇔ 164	(30 seconds)
	165 ⇔ 176	(60 seconds)
	177 ⇔ 183	Smooth Color Change; White, Red, Orange, Green, Blue, Light Blue, Rose Red (5 seconds)
	184 ⇔ 190	(10 seconds)
	191 ⇔ 197	(30 seconds)
	198 ⇔ 204	(60 seconds)
205 ⇔ 211	Rapid Color Change; White, Red, Orange, Green, Sky Blue, Light Blue, Blue, Dark Blue, Purple, Rose Red, Pink (5 seconds)	
212 ⇔ 218	(10 seconds)	
219 ⇔ 225	(30 seconds)	
226 ⇔ 232	(60 seconds)	
233 ⇔ 239	Smooth Color Change; White, Red, Orange, Green, Sky Blue, Light Blue, Blue, Dark Blue, Purple, Rose Red, Pink (5 seconds)	
240 ⇔ 246	(10 seconds)	
247 ⇔ 253	(30 seconds)	
254 ⇔ 255	(60 seconds)	

Photo Metrics

40° Beampath

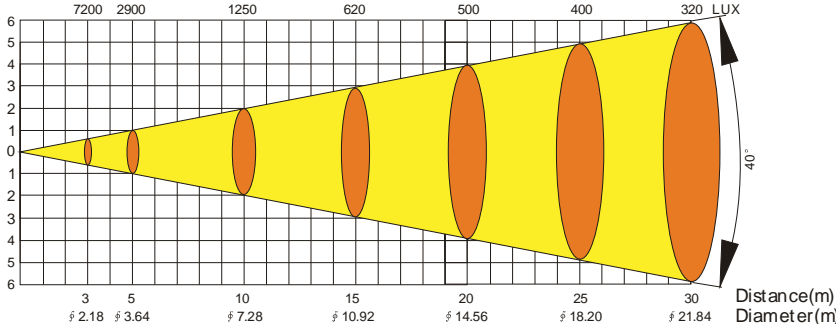

7° Beampath

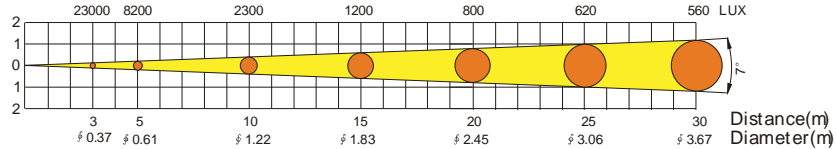

Dipswitch Location

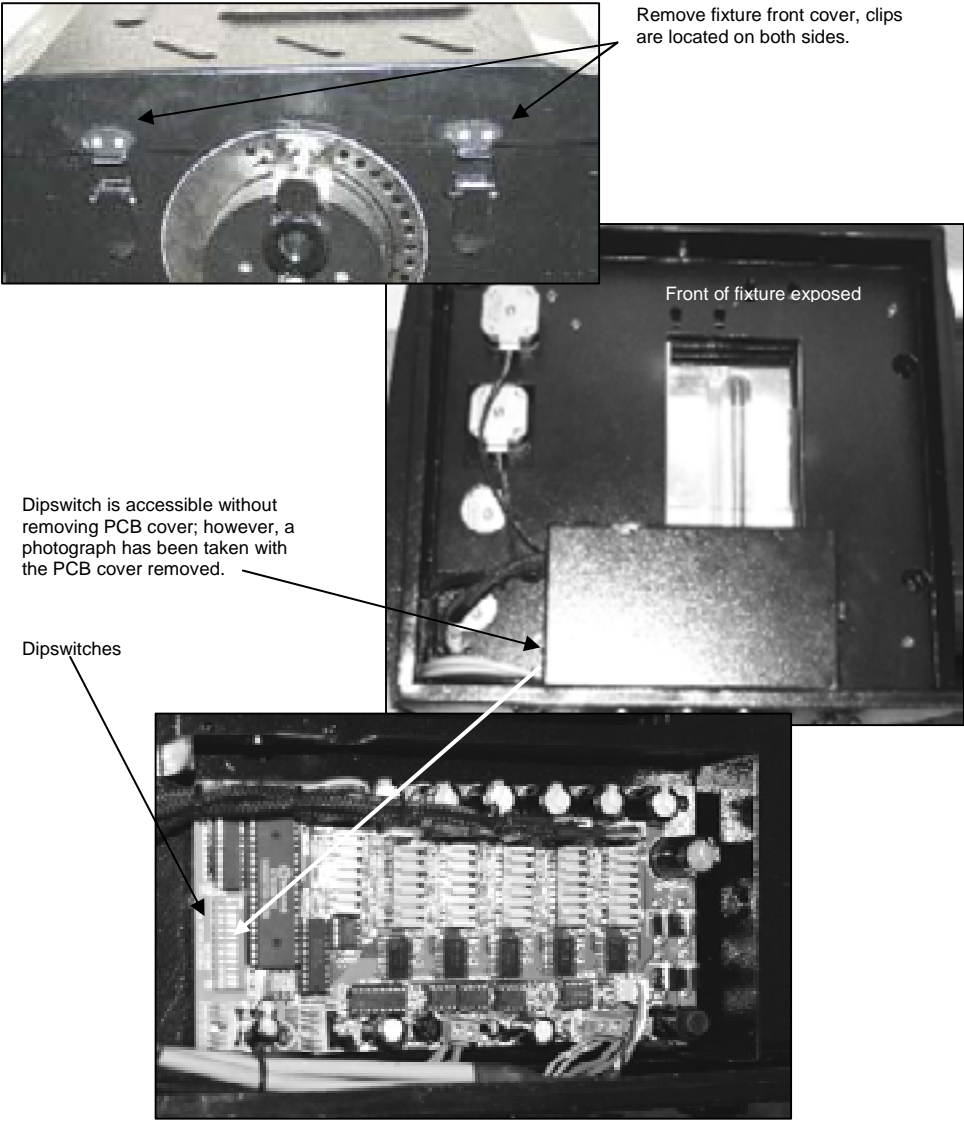

Maintenance

To maintain optimum performance and minimize wear fixtures should be cleaned frequently. Usage and environment are contributing factors in determining frequency. As a general rule, fixtures should be cleaned at least twice a month. Dust build up reduces light output performance and can cause overheating. This can lead to reduced lamp life and increased mechanical wear. Be sure to power off fixture before conducting maintenance.

Unplug fixture from power. Use a vacuum or air compressor and a soft brush to remove dust collected on external vents and internal components. Clean all glass when the fixture is cold with a mild solution of glass cleaner or Isopropyl Alcohol and a soft lint free cotton cloth or lens tissue. Apply solution to the cloth or tissue and drag dirt and grime to the outside of the lens. Gently polish optical surfaces until they are free of haze and lint. Do not touch the lamp glass when cleaning fixture. Oil and dirt can cause damage and premature aging of the lamp. In the event that the lamp is touched or becomes dirty, clean the lamps with an alcohol wipe.

The cleaning of internal and external optical lenses and/or mirrors must be carried out periodically to optimize light output. Cleaning frequency depends on the environment in which the fixture operates: damp, smoky or particularly dirty surrounding can cause greater accumulation of dirt on the unit's optics. Clean with soft cloth using normal glass cleaning fluid. - Always dry the parts carefully. - Clean the external optics at least every 20 days. Clean the internal optics at least every 30/60 days.

Returns Procedure

Returned merchandise must be sent prepaid and in the original packing, call tags will not be issued. Package must be clearly labeled with a Return Merchandise Authorization Number (RA #). Products returned without an RA # will be refused. Call CHAUVET and request RA # prior to shipping the fixture. Be prepared to provide the model number, serial number and a brief description of the cause for the return. Be sure to properly pack fixture, any shipping damage resulting from inadequate packaging is the customer's responsibility. CHAUVET reserves the right to use its own discretion to repair or replace product(s). As a suggestion, proper UPS packing or double-boxing is always a safe method to use.

Claims

Damage incurred in shipping is the responsibility of the shipper; therefore the damage must be reported to the carrier upon receipt of merchandise. It is the customer's responsibility to notify and submit claims with the shipper in the event that a fixture is damaged due to shipping. Any other claim for items such as missing component/part, damage not related to shipping, and concealed damage, must be made within seven (7) days of receiving merchandise.

General Troubleshooting

Symptom	Solution(s)	Applies to			
		Lights	Foggers & Snow	Controllers	Dimmers & Chaser
Auto shut off	Check fan thermal switch reset	✓			
Beam is very dim or not bright	Clean optical system or replace lamp Check 220/110v switch for proper setting	✓			
Breaker/Fuse keeps blowing	Check total load placed on device				✓
Chase is too slow	Check users manual for speed adjustment	✓		✓	✓
Device has no power	Check for power on Mains. Check device's fuse. (internal and/or external)	✓		✓	✓
Fixture is not responding	Check DMX Dip switch settings for correct addressing Check DMX cables Check polarity switch settings	✓			
Fixture is on but there is no movement to the audio	Make sure you have the correct audio mode on the control switches. If audio provided via ¼" jack, make sure a live audio signal exists Adjust sound sensitivity knob	✓		✓	✓
Lamps cuts off sporadically	Possible bad lamp or fixture is overheating. Lamp may be at end of its life.	✓			
Light will not come on after power failure	Some discharge lamps require a cooling off period before the electronics in the fixture can kick start it again, wait 5 to 10 minutes before powering up	✓			
Loss of signal	Use only DMX cables Install terminator Note: Keep DMX cables separated from power cables or black lights.	✓	✓	✓	✓
Motor movements are jerky or jumpy	Possible bad motor driver or sensors Check polarity switch on controller	✓		✓	
Moves slow	Check 220/110v switch for proper setting	✓			
No flash	Re-install bulb, may have shifted in shipping	✓			
No light output	Check slip ring & brushes for contact Install bulb Call service technician	✓			
Relay will not work	Check reset switch Check cable connections				✓
Remote does not work	Make sure connector is firmly connected to device	✓	✓		
Stand alone mode	All CHAUVET lighting fixtures featuring stand-alone functions do not require additional settings, simply power the fixture and it will automatically enter into this mode	✓			
Unit wobbles when rotating	Check for damages possibly incurred during shipping	✓			

Technical Specifications

WEIGHT & DIMENSIONS

Length..... 521 mm (20.5 in)
 Width..... 470 mm (18,5 in)
 Height 533 mm (21 in)
 Weight..... 43.68 Kg (96.30 lbs)

POWER

Power settings (internal tap)..... 115V 60 Hz or 230V 50 Hz
 AC input..... 3 prongs IEC 60320 C14
 European version..... 240V 50 Hz
 Current draw (peak 750W @ 120V)

LAMP

HSR575 1000 hr, 7200K, 575W

PHOTO OPTIC

Beam Angle 7° ~ 40°

THERMAL

Maximum ambient temperature..... 50° (122° F)

CIRCUIT PROTECTION

ART-575W Magnetic Circuit Breaker with GFI
 Fuse (120V) 20mm Glass 15A Fast Blow
 Fuse (230V) 20mm Glass 10A Fast Blow

CONTROL & PROGRAMMING

Data input locking 3-pin XLR male socket
 Data output locking 3-pin XLR female socket
 Data pin configuration pin 1 shield, pin 2 (-), pin 3 (+)
 Protocols..... DMX-512 USITT
 DMX Channels..... 8

ORDERING INFORMATION

Spectrum™ 575W ART-575W

Technical Support

Address: Service Dept.
 3000 N 29th Ct, Hollywood, FL 33020 (U.S.A.)
 Support (Email): tech@chauvetlighting.com
 Telephone: (954) 929-1115 - (Press 4)
 Fax: (954) 929-5560 - (Attention: Service)
 Website: <http://www.chauvetlighting.com>