

Sony VAIO Desktop User Guide

PCV-LX2

The VAIO logo is rendered in a blue, stylized font. The 'V' is a thick, wavy line that curves down and then up. The 'A' is a solid blue circle. The 'I' is a thick vertical bar with a small upward-pointing arrowhead at the top. The 'O' is a thick, solid blue circle.

Read this first

Notice

© 2002 Sony Corporation. All rights reserved.

This manual and the software described herein, in whole or in part, may not be reproduced, translated, or reduced to any machine-readable form without prior written approval.

Sony Corporation provides no warranty with regard to this manual, the software, or other information contained herein and hereby expressly disclaims any implied warranties or merchantability or fitness for any particular purpose with regard to this manual, the software or such other information. In no event shall Sony Corporation be liable for any incidental, consequential, or special damages, whether based on tort, contract, or otherwise, arising out of or in connection with this manual, the software, or other information contained herein or the use thereof.

Sony Corporation reserves the right to make any modification to this manual or the information contained herein at any time without notice. The software described herein is governed by the terms of a separate user license agreement.

Trademarks

Sony, DVgate, i.LINK™ and the i.LINK™ logo, ImageStation, PictureGear, Memory Stick™ and the Memory Stick™ logo, VAIO and the VAIO logo are trademarks of Sony Corporation.

i.LINK™ is a trademark of Sony used only to designate that a product contains an IEEE 1394-1995 connection.

Microsoft®, Windows® and the Windows® logo, Windows® Media and Outlook® are trademarks or registered trademarks of U.S. Microsoft® Corporation in the U.S. and other countries.

Adobe®, Adobe® Acrobat® Reader, Adobe® Premiere®, Adobe® Photoshop® Elements, Adobe® GoLive®, and Adobe® LiveMotion® are trademarks of Adobe Systems Incorporated.

QuickTime and the QuickTime logo are trademarks used under license. QuickTime is registered in the U.S. and other countries.

RealPlayer® is a trademark or registered trademark of RealNetworks, inc. in the U.S. and other countries.

Norton Antivirus is a trademark of Symantec.

All other names of systems, products and services are trademarks of their respective owners. In the manual, the ™ or ® marks are not specified.

Specifications are subject to change without notice.

ENERGY STAR®

As an ENERGY STAR® Partner, Sony has determined that this product meets the ENERGY STAR® guidelines for energy efficiency.

The International ENERGY STAR® Office Equipment Program is an international program that promotes energy saving through the use of computers and their office equipment. The program backs the development and dissemination of products with functions that effectively reduce energy consumption. It is an open system in which business proprietors can participate voluntarily. The targeted products are office equipment such as computers, displays, printers, facsimiles and copiers. Their standards and logos are uniform among participating nations.

ENERGY STAR is a U.S. registered mark.



Environmental information



Halogenated flame retardant is not used in cabinets

Cushions formed by corrugated board are used in packaging

Safety information

Owner's record

The model number and serial number are located on the back panel of your Sony VAIO desktop. Record the serial number in the space provided here. Refer to the model and serial number when you call VAIO-Link.

Serial number: _____

Model number: **PCV-LX2**

Warnings

General

- Opening the unit, for whatever reason, could lead to damages that are not covered by the guarantee.
- To avoid electrical shock, do not open the cabinet. Refer servicing to qualified personnel only.
- To prevent fire or shock hazard, do not expose your VAIO desktop to rain or moisture.
- If reporting a gas leak, do not use the modem or a telephone in the vicinity of the leak.
- Avoid using the modem during a severe electrical storm.
- The power socket outlet you are using must be installed near the equipment and must be easily accessible.
- The magnetic properties of some objects can have serious consequences for your hard disk drive. They can erase the data on the hard disk drive and cause the computer to malfunction. Do not place your computer near or on any objects, which emit magnetic fields, mainly:
 - TV sets
 - Speakers
 - Magnets
 - Magnetic bracelets.

Audio/video

- ❑ Audio and picture distortion may occur if this equipment is positioned in close proximity to any equipment emitting electromagnetic radiation.

Connectivity

- ❑ Never install modem or telephone wiring during a severe lightning storm.
- ❑ Never install telephone jacks in wet locations unless the jack is specifically designed for wet locations.
- ❑ Be cautious when installing or modifying telephone lines.
- ❑ To disconnect your VAIO desktop completely from the mains voltage, unplug the power cable.
- ❑ Make sure that the socket outlet is easily accessible.

Optical disc

The use of optical instruments can cause eye hazard. As the laser beam used in this product is harmful to the eyes, do not attempt any disassembling process. For servicing, refer to qualified personnel only.

There is visible and invisible radiation when the optical disc drive is open: avoid direct exposure to the laser beam. The optical disc drive is classified as a CLASS 1 LASER PRODUCT and complies with the Laser Product Safety Standard EN 60825-1. Repair and maintenance only by authorized Sony technicians. Improper repairs and use can create safety hazards.

**CLASS 1
LASER PRODUCT
TO EN 60825-1**

Regulatory information

Sony hereby declares that this product is in compliance with the essential requirements and other relevant provisions of the European Directive 1999/5/EC.



This product complies with EN 55022 Class B and EN 55024 for use in the following areas: residential, commercial and light-industrial.

This product has been tested and found compliant with the limits set out in the EMC Directive for using connection cables not longer than 3 metres (9.8 feet).

Disposing of batteries

Your Sony VAIO desktop is equipped with an internal back-up memory battery that should not have to be replaced during the lifetime of the product. If you want to replace the battery, please contact VAIO-Link:

<http://www.vaio-link.com>

- Keep away from children.
- Dispose of the battery properly at its end-of-life.

In some areas the disposal of non-hazardous batteries in household or business waste may be prohibited. Please use the public collection system.

Welcome

Congratulations on purchasing a Sony VAIO desktop. Sony has combined leading-edge technology in audio, video, computing and communications to provide you with state-of-the-art personal computing.

Here are the main features you will be able to enjoy:

- ❑ **Exceptional performance** - Your PC includes an Intel® processor, a Fast Ethernet interface, an internal modem and a fast CD-RW/DVD-ROM drive.
- ❑ **Sony audio and video quality** - A high-resolution LCD screen with built-in stereo speakers enables you to take advantage of today's advanced multimedia applications, games, and entertainment software.
- ❑ **Multimedia LCD display** - Select the perfect viewing angle: With its unique dual-hinge pedestal, the 15" display provides twice the flexibility of other screens.
- ❑ **Sony Memory Stick™ media slot** - The next generation in digital storage allows you to easily transfer images, sounds, data and text between cameras, computers, and more.
- ❑ **VAIO convertible keyboard** - Featuring power-on capabilities and programmable power keys to launch your favourite applications within seconds. The palm rest converts to a sleek keyboard cover to protect it when not in use.
- ❑ **Interconnectivity** - Your computer has Ethernet and i.LINK™ functionalities. i.LINK™ is a bi-directional digital interface for exchanging data with compatible devices, such as camcorders.
- ❑ **Windows® XP Professional** - Your system includes the latest consumer operating system from Microsoft.
- ❑ **Excellent customer support** - If you are experiencing any problems with your computer, please check the VAIO-Link website for a possible solution:
<http://www.vaio-link.com>
Before contacting VAIO-Link, please try to solve the problem by reading the User Guide or the manuals and help files for the peripherals or software.

Documentation pack

Your documentation pack contains printed user guides, as well as online user guides presented on a documentation CD-ROM.

Printed documentation

The printed part of your documentation pack contains the following:

- ❑ A **Getting Started** brochure, where you will find a brief description of the items in your box, some specifications of your VAIO desktop, and how to set up your computer;
- ❑ A **Customer Guide**, where you will find all the basic information to start using your VAIO desktop, as well as troubleshooting and VAIO-Link information;
- ❑ Your **Sony Guarantee conditions**.
- ❑ A **Safety Regulations Guide** for your information.
- ❑ A **Modem Regulations** flyer applying to the modem.

Online documentation

Preinstalled on your desktop are the following guides:

- 1 The **Sony VAIO Desktop User Guide**:
 - ❑ **Using your VAIO desktop** shows you how to use the standard components of your system. In this part of the manual you will also find out what you can do with a Memory Stick™.
 - ❑ **Connecting peripheral devices** explains how you can add functionality by connecting various peripherals.
 - ❑ **Getting help** explains the support options available to you, and offers basic troubleshooting tips.
 - ❑ **Precautions** provides facts and advice about using your VAIO desktop.
 - ❑ **Specifications** lists details on your computer, drivers and accessories.
 - ❑ **Glossary** refers to terms used in this manual.

2 The **Software Guide**:

- ❑ **About the Software** is a short description of the features of the software pre-installed on your system.
- ❑ **Using Video software** explains how to use Sony video software: DVgate, MovieShaker and Smart Capture.
- ❑ **Managing audio files with SonicStage** describes how to convert your existing MP3, WMA and WAV format audio files into ATRAC3 format.
- ❑ **Using Imaging software** gives you an idea what you can do with still images: creating a collection, slide show, screen saver or photo album.
- ❑ **Customizing your VAIO computer** explains how to set up your system's display and so on.
- ❑ **Installing and updating applications** details how to install, run or uninstall a software application.
- ❑ **Managing drivers** describes how to install, update or uninstall a driver.
- ❑ **Using the Product Recovery CD-ROMs** explains how to perform a system and application recovery.
- ❑ **Using partitioned drives** tells you what you can do with partitioned drives.
- ❑ Consult the **Online Help** files of the software you are using for detailed information on features and troubleshooting.
- ❑ Refer to the Microsoft **Quick Start** manual for more information on Windows®.

Your Sony VAIO desktop and its accessories

The following hardware items are in the box:

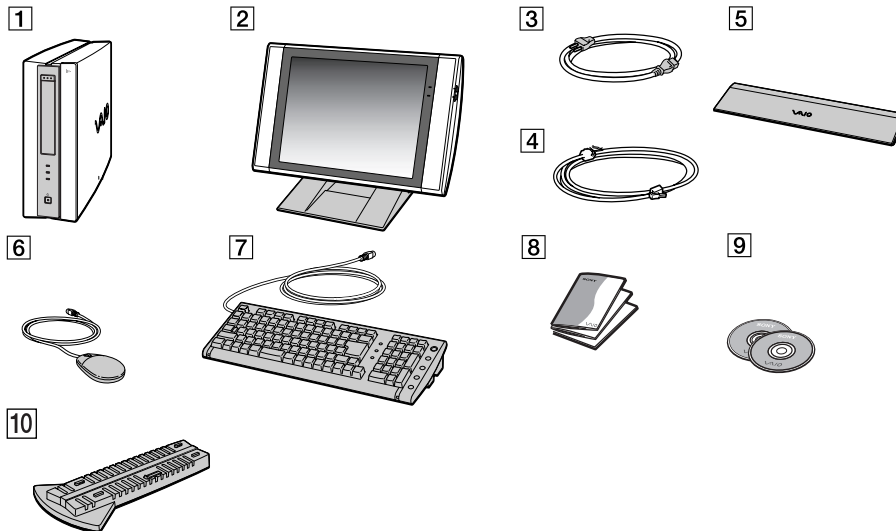

1	main unit	6	VAIO wheel mouse
2	LCD monitor	7	VAIO convertible keyboard
3	power cable	8	documentation pack
4	phone cable and plug*	9	product recovery CD-ROMs
5	palm rest	10	stand

*The phone cable is used to connect the internal modem. Please make sure the phone plug attached to the cable is specific to the country you are in. See **Using the correct phone plug (page 46)** for details.

Ergonomic considerations

Whenever possible, try and take into account the following ergonomic considerations when using your new computer, whether at home or in the office:

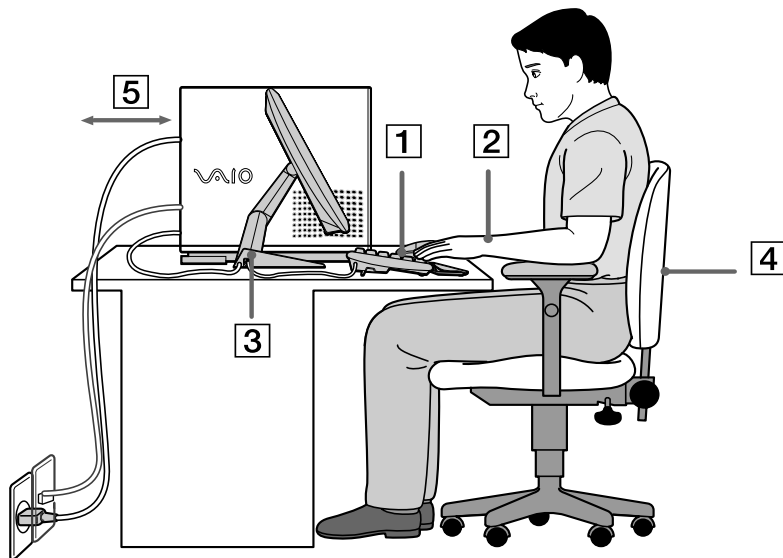

- ❑ **Position of the keyboard and mouse** – Place the keyboard directly in front of you (1). Keep your forearms horizontal, with your wrists in a neutral, comfortable position (2) while using the keyboard or mouse – not at an angle. Let your upper arms hang naturally at your sides. Use the palm rest only briefly, to relax your wrists when you are not typing. Place the mouse at the same level as the keyboard and use your whole arm to move it.

- ❑ **Position and viewing angle of the monitor** – Set the display at a comfortable viewing distance (3). Make sure the display screen is at eye level or slightly lower. Use the display's tilting feature to find the best position. You can reduce eye-strain and muscle-fatigue by adjusting the tilt of the display to the proper position. Remember to adjust the brightness setting of the display.
- ❑ **Furniture and posture** – Sit in a chair with good back support (4). Adjust the level of the chair so your feet are flat on the floor. A footrest may make you more comfortable. Sit in a relaxed, upright posture and avoid slouching forward or leaning too far backwards.
- ❑ **Lighting** – Choose a location where windows and lights do not create glare or reflection on the display. Use indirect lighting to avoid bright spots reflecting on the display. You can also purchase accessories for your display that help reduce glare. Proper lighting adds to your comfort and work effectiveness.
- ❑ **Ventilation** – Make sure you leave at least 25 cm of space behind and on the left of the main unit (5).
- ❑ **And finally** – Remember to have breaks during sessions with your computer. Excessive use of the computer may strain muscles or tendons.

Using your VAIO desktop

This section describes how to start using your computer and how to use your computer's internal and external devices.

Locating controls and connectors

Front panel

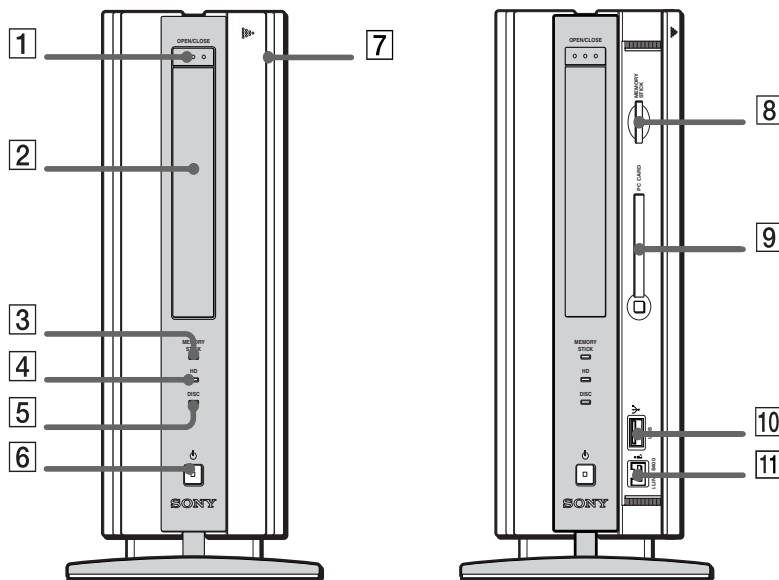

1	CD-RW/DVD-ROM eject button	(page 25)
2	CD-RW/DVD-ROM drive	(page 25)
3	Memory Stick™ indicator	(page 32)
4	hard disk drive indicator	-
5	CD-RW/DVD-ROM drive indicator	(page 25)
6	power switch and indicator	(page 16)
7	front panel cover	-
8	Memory Stick™ slot	(page 32)
9	PC Card slot	(page 29)
10	USB connector	(page 50)
11	i.LINK™ 4-pin connector	(page 51)

Back panel

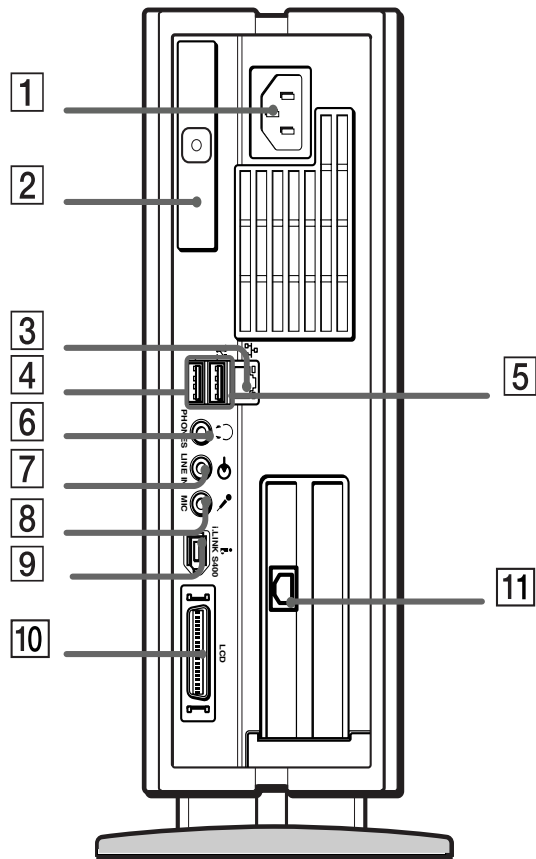

1	AC input connector	(page 16)
2	t-lever	(page 72)
3	Ethernet connector	(page 54)
4	USB connector	(page 50)
5	USB connector	(page 50)
6	headphones connector	(page 48)
7	line-in connector	-
8	microphone connector	(page 49)
9	i.LINK™ 6-pin connector	(page 51)
10	LCD monitor connector	(page 78)
11	phone connector	(page 45)

 The mains power cord and connector are hazardous voltage according to EN60950.

LCD overview

Your VAIO desktop is delivered with a 15" LCD (XGA TFT) monitor.

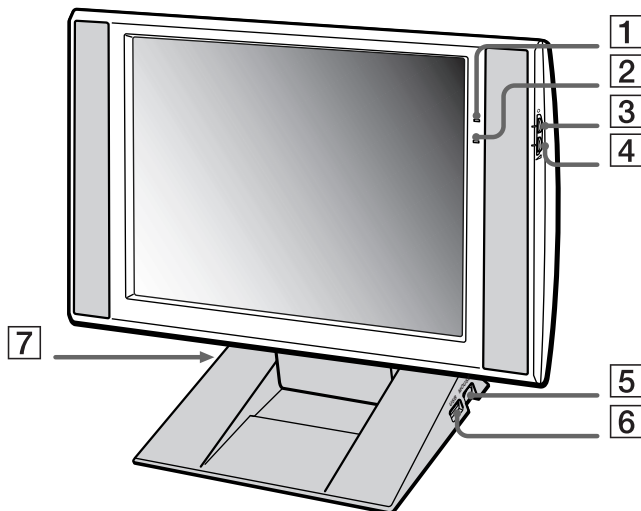

1	power indicator	(page 16)
2	information LED	-
3	brightness control	-
4	volume control	-
5	mouse connector	(page 24)
6	USB connector	(page 50)
7	keyboard connector	(page 18)

Adjusting the viewing angle

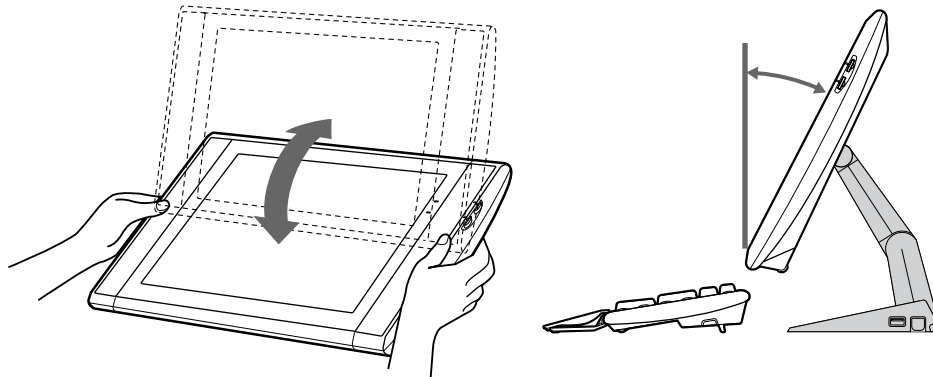

To adjust the height and viewing angle of the display, proceed as follows:

- 1 Hold both sides of the display, pull the display out towards you, and upwards.
- 2 Set the display height so it does not touch the keyboard, and adjust the viewing angle approximately 27 degrees from eye level to the center of the screen.

Starting your computer

To start your computer the first time, you can either:

Press the power button on the system unit until the green power indicator light turns on (1).

OR

Press the **Standby** button (2) above the numbered PPKs on the keyboard until the green power indicator light on the main unit turns on.

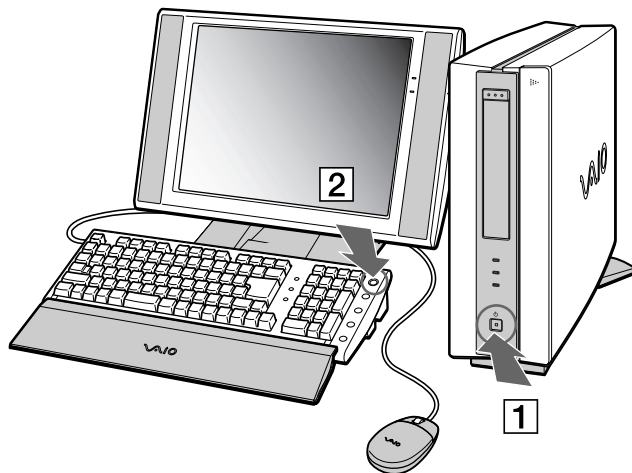

Once you have started using your computer, you can use the Programmable Power Keys (PPK) on the keyboard to start your system and launch your favourite application automatically.

 If you press the power button for more than four seconds, the computer will switch itself off.

Do not forget to turn on the monitor separately.

Shutting down your computer

It is important that you shut down your computer properly so as not to lose unsaved data.

To shut down your computer, proceed as follows:

- 1 Click the **Start** button on the Windows® taskbar.
- 2 Click **Turn Off Computer**.
The **Turn off computer** dialog box appears.
- 3 Select **Turn Off**.
- 4 Click **OK**.
- 5 Wait for your computer to turn off automatically.
The power indicator turns off.
- 6 Turn off any peripherals connected to your computer.

 Respond to any prompts warning you to save documents.

If you are unable to shut down your computer:

- Close all software in use.
- Remove the PC Card, if applicable. To do so, double-click the **Safely Remove Hardware** icon in the taskbar. Select the hardware you want to unplug and click **Stop**.
- Disconnect any USB devices.
- Press the <Alt>+<F4> keys at the same time and select **Turn Off** to turn the computer off.

If this does not work, you can press the power button for more than four seconds. This will shut down the computer. This operation may result in loss of data.

If you want to shut down the computer for a short period only, you can save power by using the **Standby** mode. Select **Stand By** from the **Turn off computer** window.

Using the keyboard

This section describes the features of the VAIO convertible keyboard.

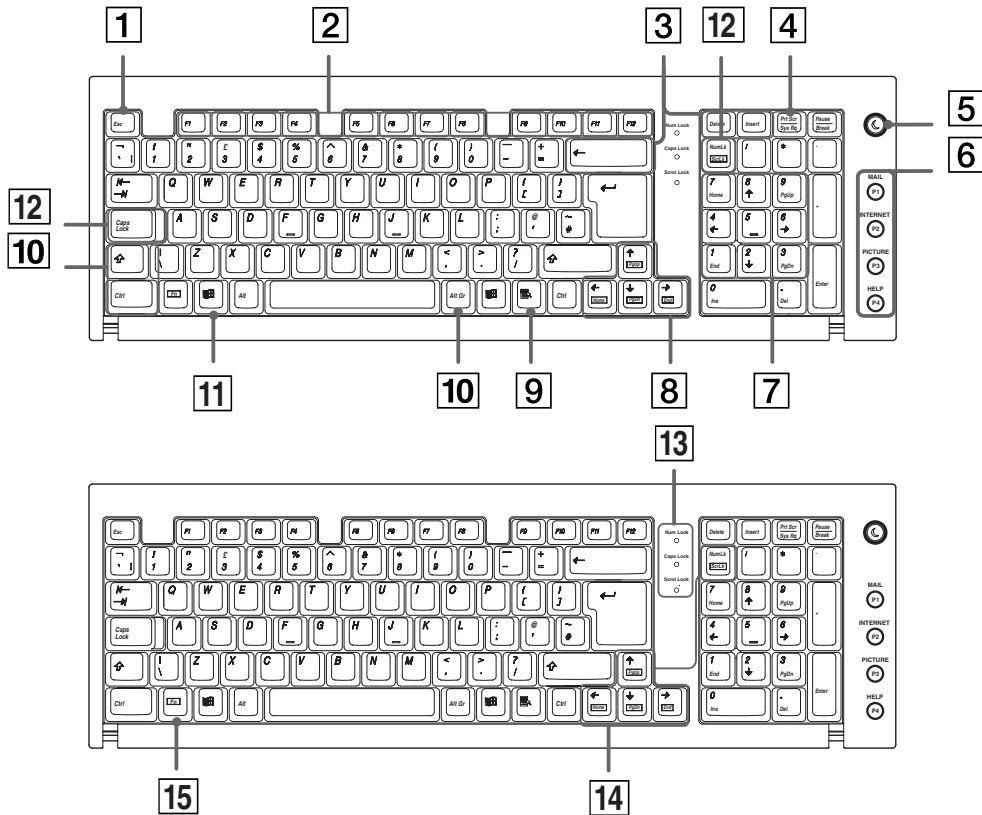

<i>Keys</i>	<i>Descriptions</i>
Escape key (1)	The <Esc> (Escape) key is used to cancel commands.
Function keys (2)	The twelve function keys along the top of the keyboard are used to perform designated tasks. For example, in many applications, <F1> is the Help key. The task associated with each function key may vary from one application to another.
Correction keys (3)	The <Insert> , <Back Space> and <Delete> keys enable you to make corrections when typing.
Print Screen key (4)	The <Prt Sc> key takes an electronic snapshot of the screen and moves it to the Windows® Clipboard. You can then paste the screenshot into a document and print it.
Standby button (5)	Press this button either to start up your computer, or to enter Standby mode, or to resume from a power saving mode.
Programmable Power Keys (PPK) (6)	You can use these buttons, numbered 1 to 4, to launch straight into assigned applications.
Numeric keypad area (7)	This contains the keys found on a typical calculator. Use the numeric keypad area to type numbers or to perform mathematical calculations such as addition and subtraction. Note that you must press the <Num Lock> key to activate the keypad.
Navigation keys (8)	These keys enable you to move the cursor on the screen.
Application key  (9)	The Application key displays a shortcut menu; pressing this key is equivalent to clicking the right mouse button.

Keys

Descriptions

Operator keys (10)	Several keys are used in combination with at least one other key: <Ctrl> , <Alt> and <Shift> . When held down at the same time as another key, the <Ctrl> (Control) and <Alt> (Alternate) keys offer another way to execute commands. For example, in many applications, instead of choosing the Save command from a menu, you can hold down <Ctrl> and press <S> (referred to as <Ctrl>+<S>). The <Shift> key is used to type capital letters or special symbols such as @ and \$.
Windows® key  (11)	The key with the Windows® logo displays the Windows® Start menu; it is equivalent to clicking the Start button on the taskbar.
Lock keys (12)	Press Caps Lock once to activate the uppercase characters. Use the Num Lock key to activate the numerical keypad.
Indicator LEDs (13)	A green light indicates whether the Caps Lock , Num Lock , and Scroll Lock functions are active.
Fn combination keys (14)	These keys are used in combination with the <Fn> key to execute the commands depicted within the box on the key.
Fn key (15)	The <Fn> key is used in combination with 5 other keys to execute certain commands.

Combinations and functions with the Windows® key

<i>Combinations</i>	<i>Function</i>
⊞ + F1	Displays Windows® Help and Support .
⊞ + Tab	Switches the selected button on the taskbar.
⊞ + E	Displays Windows Explorer .
⊞ + F	Displays the Search Results window to find a file or folder. This is equivalent to selecting Search and then For Files or Folders from the Start menu.
⊞ + Ctrl + F	Displays the Search Results - Computers window where you can locate other computers.
⊞ + M	Minimizes all displayed windows.
Shift + ⊞ + M	Returns all minimized windows to their previous size.
⊞ + R	Displays the Run window. This is the equivalent to selecting Run from the Start menu.

Combinations and functions with the Fn key

Combinations/ Feature Functions

Fn + PgUp	Moves the view to the next page up.
Fn + PgDn	Moves the view to the next page down.
Fn + Home	Moves the cursor to the beginning of the line.
Fn + End	Moves the cursor to the end of the line.
Fn + ScrLk	Changes the way in which you can scroll the screen, depending on the application.

Indicators

Light

On

Off

Num Lock	Turns on when the number keys in the numeric keypad are active.	Turns off when the alphanumeric character keys in the keypad area are active.
Caps Lock	Turns on when the letters appear in uppercase as you type. The <Shift> key lowers the case of typed letters when Caps Lock is on.	Turns off when the letters appear in lowercase as you type (unless you hold down the <Shift> key).
Scroll Lock	Turns on when the screen scrolls differently (not all applications support this function).	Turns off when the information moves across the display normally.

Using programmable power keys (PPK)

Press a programmable power key to start your favourite software without having to click the shortcuts on the desktop.

Use a programmable power key simply by pressing it.

Even when your computer is off, you can press a PPK to start the system and launch the appropriate application automatically.

If you want to, you can use VAIO Action Setup to change the functions of the PPKs.

The default settings for the PPK buttons are:

- ❑ **P1:** Starts Microsoft® Outlook® Express
- ❑ **P2:** Connects you to the Club VAIO website
- ❑ **P3:** Starts Sony's PictureGear
- ❑ **P4:** Starts VAIO Help

 These functions may vary.

Using the mouse

The VAIO wheel mouse allows you to control the cursor in a number of ways. You can point to, select, drag, and scroll objects on the screen using the buttons and the wheel.

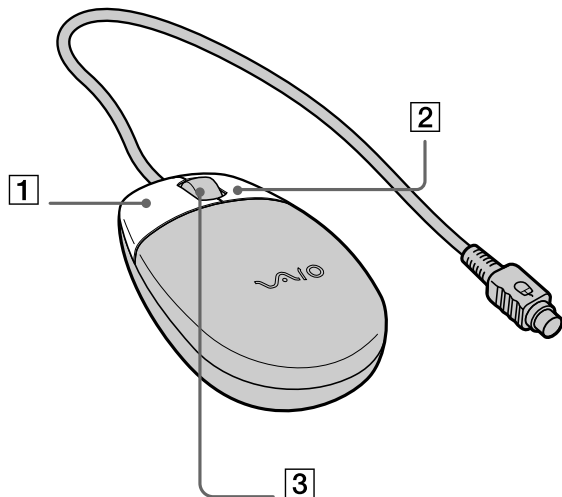

<i>Function</i>	<i>Action</i>
point	Move the entire mouse across a flat surface to place the pointer on an item or object.
click	Press the left button (1) once.
double-click	Press the left button twice.
right-click	Press the right button (2) once. In many applications, this action displays a context-sensitive shortcut menu.
drag and drop	Hold the left button down while sliding the mouse. Then release the button to drop the object.
scroll	Turn the central wheel (3) to scroll up or down a page. Or press the wheel once to lock the scroll action and control the movement by moving the entire mouse. (The scroll function is available only with applications that support a scroll feature.)

 You can set the mouse up for left-hand use. See the troubleshooting section for details.

Using the CD-RW/DVD-ROM drive

Your computer is equipped with a CD-RW/DVD-ROM drive.

To insert a disc, proceed as follows:

- 1 Turn on the computer.
- 2 Press the eject button to open the drive.
The tray slides out.

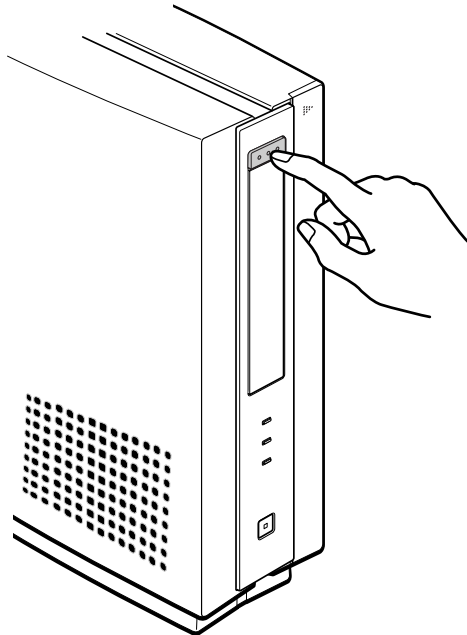

- 3 Place a CD-RW/DVD-ROM/CD-R/CD-ROM disc in the left-hand side of the tray with the label side facing outwards. Use the small hinges to secure the disc.

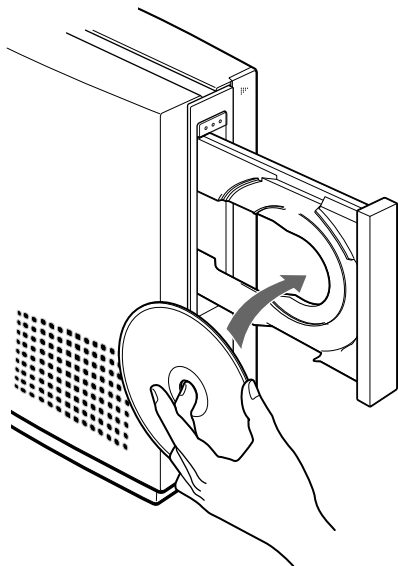

- 4 Close the tray by pushing it gently.



When the computer is in **Standby** or **Hibernate** mode, you cannot insert or remove a disc.

Make sure you seat the disc firmly under the drive hub hinges. If you do not seat the disc firmly, you could damage your disc drive and you may not be able to open the tray.

When you have finished using a disc, wait until the LED indicator turns off before pressing the eject button to remove the disc.

If the disc does not come out when you press the eject button, go to **My Computer**. Select the drive, click the right button of your mouse and select **Eject**.

Using the CD-RW function

Your computer is equipped with a CD-RW/DVD-ROM drive.

To burn CDs, you can use CD-RW and CD-R discs:

- ❑ The **CD-RW** (CD-ReWritable) disc is a data memory medium that can be used to write, erase and rewrite a program or other data.
- ❑ The **CD-R** (CD-Recordable) disc is a data memory medium that can be used to write a program or other data, but then no more than once.

To achieve optimum performance when writing data on a CD-RW disc, follow these recommendations :

- ❑ Before writing to a new CD-RW, you must first format the disc. If you do not format the disc, your computer will not recognize it.
- ❑ To make a CD-R's data readable on a CD-ROM drive, you need to close the session when you eject it. To complete this process, follow the instructions included with your software.
- ❑ Only use circular discs. Do not use discs with any other shape (star, heart, card, etc.), as this may damage the CD-RW drive.
- ❑ Do not strike or shake the computer while writing data to a disc.
- ❑ For optimal writing speed, deactivate the screensaver before writing data to a disc.
- ❑ Memory-resident disc utilities may cause unstable operation or data loss. Deactivate these utilities before writing data to a disc.
- ❑ When using a software application to burn CDs, make sure you exit and close all other applications.
- ❑ Exit anti-virus software before writing data to a disc.
- ❑ Never touch the surface of the disc. Fingerprints and dust on the surface of a disc may cause writing errors.

Using the DVD function

To achieve optimum performance when playing **DVD-ROM** discs, you should follow these recommendations.

- ❑ You can play DVDs using the CD-RW/DVD-ROM drive and the MediaBar DVD Player software.
- ❑ Close all open applications before playing a DVD-ROM movie.
- ❑ Do not switch power saving modes while playing a DVD video.
- ❑ If the virus checker is active, you need to disable it.
- ❑ Do not use resident disc utilities or resident utilities to speed up the access of discs, because they may cause the system to become unstable.
- ❑ Make sure that the screensaver is deactivated.
- ❑ Region codes indicators are labeled on the DVD discs to indicate in which region and on what type of player you can play the disc. Unless a '2' or 'all' is labeled on your DVD disc or on the packaging, you cannot play the disc on this player.
- ❑ Do not try to change the region code settings of the CD-RW/DVD-ROM drive. Any difficulties caused by changing the region code settings of the CD-RW/DVD-ROM drive are out of warranty.

Using PC Cards

Your VAIO computer has a PC Card slot that supports Type I or Type II PC Cards. PC Cards allow you to connect portable external devices.

Inserting a PC Card

To insert a PC Card, proceed as follows:

- 1 Slide the front panel cover in the direction of the arrow to open it.
- 2 Insert the PC Card gently into the PC Card slot, as shown.
The PC Card is automatically detected by your system.
The **Safely Remove Hardware** icon appears in the taskbar.

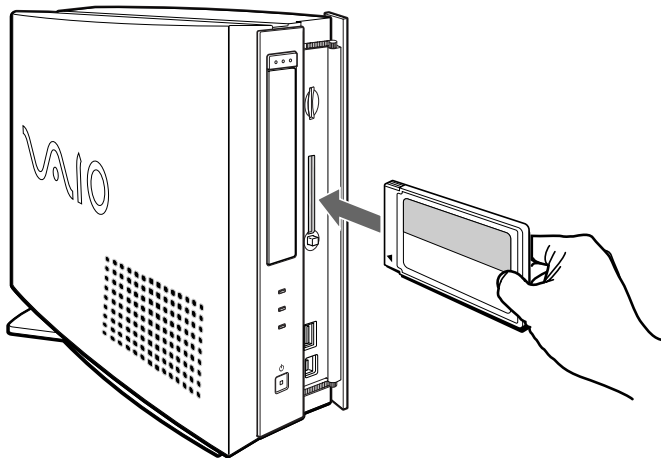

 You do not need to shut down your computer when inserting a PC Card.

Some PC Cards may require you to disable idle devices when using the PC Card.

You may not be able to use some PC Cards or some functions of the PC Card with this computer.

Make sure you use the most recent software driver provided by the PC Card manufacturer.

If an "!" mark appears on the **Device Manager** tab in the **System Properties** dialog box, remove the software driver and then reinstall it.

Do not force a PC Card into the slot. It may damage the connector pins. If you have difficulty inserting a PC Card, check that you are inserting the PC Card in the correct direction. See the manual supplied with your PC Card for more information on use.

For some PC Cards, if you alternate between **Normal** power operation and **Standby** or **Hibernate** power management modes while the card is inserted, you may find that a device connected to your system is not recognized. Reboot your system to correct the problem.

Removing a PC Card

Follow the steps below to remove the PC Card while your computer is on. If it is not removed properly, your system may not work. If you want to remove a PC Card when your computer is off, you can go straight to step 5.

To remove a PC Card, proceed as follows:

- 1 Double-click the **Safely Remove Hardware** icon in the taskbar.
The **Safely Remove Hardware** window appears.
- 2 Select the hardware you want to unplug and click **Stop**.
The **Stop a Hardware device** dialog box appears.
- 3 Make sure that the device is selected and click **OK**.
The **Safe to Remove Hardware** message appears, confirming the device can be safely removed from the system.
- 4 Click **Close** to close the **Safely Remove Hardware** dialog box.
- 5 Press the PC Card release button once so it is extended and ready for use.
- 6 Push the PC Card release button to eject the card.
- 7 Gently grasp the card and pull it out.
- 8 If the PC Card release button is still out, push it back in so you can close the front panel cover.

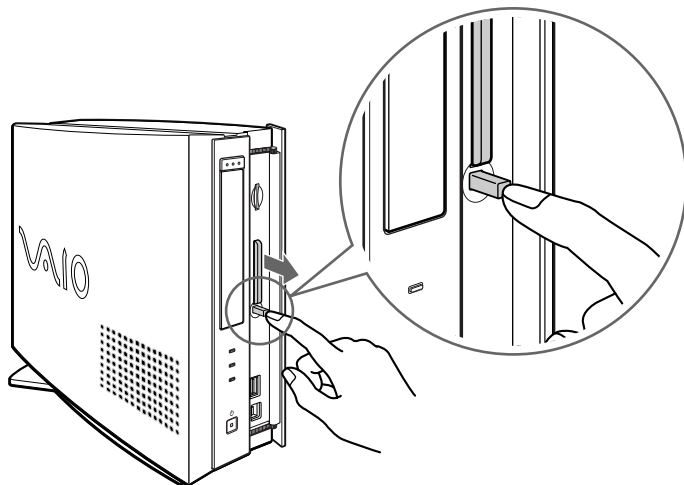

 If you unplug the PC Card from the computer when the power is still on without following these steps, your system might crash and unsaved data may be lost.

You may not be able to use some PC Cards or some functions within the PC Card with this computer.

Close all the applications that use the PC Card before removing the card. Otherwise, data may be lost.

Using Memory Stick™

Your VAIO computer is designed to support the Memory Stick™. The Memory Stick™ is a compact, portable, and versatile device especially designed for exchanging and sharing digital data with compatible products. Because it is removable, it can be used for external data storage.

Use the flash memory technology to download anything that can be converted into digital data, such as pictures, music, words, sounds, movies and photographs.

Foreseen as the universal data storage device of the future, the Memory Stick™ can already be used with an ever-increasing range of compatible products, including:

- ❑ Audio systems
- ❑ Visual devices
- ❑ VAIO products
- ❑ CLIE handhelds
- ❑ Mobile phones.

There are currently two different types of Memory Stick™:

- ❑ The generic Memory Stick™, coloured blue.
- ❑ The MagicGate Memory Stick™, coloured white.

 You can purchase Memory Sticks™ from the Sony Style website [www.sony style europe](http://www.sonystyleeurope.com), or from your local Sony dealer.

Why Memory Stick™?

Sony's vision is to expand the world of communication, promoting the portability of digital data. The Memory Stick™ is the resulting medium, through which digital devices can be instantly connected. With it, you can download data from any compatible device, then transfer it to another in a single and instant transfer.

The main advantages of the Memory Stick™ are its:

- ❑ **Compactness:** with dimensions of just 21.5 mm (W) x 2.8 mm (H) x 50 mm (D), compatible products can also be small, lightweight and attractive in their design.
- ❑ **Capacity:** Its data capacity far exceeds that of a floppy disk.
- ❑ **Security:** its lock option means you can protect your data from accidental erasure.
- ❑ **Versatility:** memory capacity ranges from 4MB up to 128MB (the equivalent capacity of 88 floppy disks).
- ❑ **Reliability:** by way of protecting the hardware and its contents, the number of terminals is reduced to only 10 pins. This, and the overall robust structure of the stick, gives it a longer lifespan than other storage devices.
- ❑ **Durability:** the same Memory Stick™ can be used tens of thousands of times.
- ❑ **Forward compatibility:** the Memory Stick's™ current format is designed to be compatible with future products and higher capacity Memory Sticks™.

The future of Memory Stick™

Memory Stick's™ potential is virtually unlimited, with the number of **compatible products** increasing rapidly in both personal and professional spheres.

The introduction of the 256 MB and 512 MB Memory Stick™ is anticipated in 2002, and a 1 gigabyte **capacity** Memory Stick™ is expected in 2003. Additionally, the native transfer speed of the Memory Stick™ will be increased to accommodate the increasing capacity. By the end of 2002, Memory Stick's™ **transfer speed** will be increased by eight times to a maximum of 20MB/sec.

Generic Memory Stick™

The original Memory Stick™, blue in colour, can be used to record image data taken with digital still cameras, etc. or data from the PC. With it, you can record, play back and transfer various kinds of data at any given time.



Because it is easy to remove and transport safely, you can use Memory Stick™ anywhere by inserting it into any compatible device to transfer and share the information you have saved.

For you, this means you can expand the capabilities of your VAIO computer in the following scenarios:

- ❑ With your still digital camera, share your holiday pictures instantly by e-mail.
- ❑ From your handycam to your VAIO, make the most of your captured moments with the VAIO's movie editing tools.
- ❑ Carry pictures on you by copying image files from the Internet to your VAIO to your CLIE handheld.
- ❑ With your voice recorder, add your voice to e-mails so your tone is never misunderstood.

The blue Memory Stick™ is currently available with a 4MB, 8MB, 16MB, 32MB, 64MB or a 128MB memory (the equivalent capacity of 88 floppy disks).

 Generic Memory Sticks™ cannot be used with the Memory Stick™ Walkman, or with data that is protected by copyright.

MagicGate Memory Stick™

As your LX2 computer is not designed to support this type of Memory Stick™, this section is for your interest only.

The MagicGate Memory Stick™, white in colour, records PC and image data just like its blue counterpart; the difference is it uses the MagicGate copyright protection technology.



With this type of Memory Stick™, also called the MG Memory Stick™, you can enjoy the following features:

- ❑ 32MB, 64MB and 128MB capacity versions.
- ❑ Storage of up to 120 minutes of audio data.
- ❑ Download and save:
 - ❑ digital music
 - ❑ pictures
 - ❑ movies, and more.
- ❑ Combine data files to add music to your home movies, for example.
- ❑ Transfer and share data between several digital products.
- ❑ MagicGate Copyright Protection Technology.
- ❑ SDMI (Secure Digital Music Initiative) Compliance.
- ❑ SonicStage software.

So that you further distinguish a MagicGate Memory Stick™ from a generic one, look for:

- ❑ the  logo printed on it
- ❑ a protruding dot located on the back.

 MagicGate is a copyright protection technology that complies with the standards set by SDMI (Secure Digital Music Initiative, an organization working to draw up industry standard specifications in order to protect copyrights of digital music).

The  logo indicates the copyright protection system devised by Sony. It is not meant to guarantee compatibility with other media.

MagicGate

MagicGate refers to the copyright protection technology used by the MagicGate Memory Stick™ and other MagicGate Memory Stick™ compatible devices.

The Memory Stick™ Walkman and MagicGate Memory Stick™ work together to check the data and ensure it complies with copyright protection.

If no problems are detected, the data is exchanged in encrypted form; if authentication is not passed, data cannot be exchanged or played back.

SonicStage

SonicStage uses copyright protection technology designed to manage the digital music content downloaded to the PC from CDs, the Internet and/or other sources.

Software installed on the PC records music content in encrypted form onto the hard disk. As well as allowing you to enjoy music on the PC, this technology protects against unauthorized distribution on the Internet.

Since it is compatible with MagicGate, you can use SonicStage to transfer music that you have downloaded onto your PC to your MG Memory Stick™, and playback on other Magic Gate-equipped devices and media.

Copyright protection

People who create artistic works such as music are entitled to a "copyright", meaning that they have exclusive rights to dictate how their work is used. When they are created, artistic works are automatically protected by a copyright without having to submit notification or registration, and may not be used without the permission of the person who created the work.

In the music world, however, illegal acts of distributing music without the permission of the artist, particularly on the Internet, have recently been on the increase. That is why the Recording Industry Association of America (RIAA) took the initiative to organize a forum called Secure Music Digital Initiative (SDMI) to study technology for protecting copyrights during the electronic distribution of music. Sony offers the MagicGate Memory Stick™ and Memory Stick™ Walkman with a copyright protection function that complies with SDMI standards, thereby providing an environment where individuals can record and enjoy third-party music data without worrying about copyright infringement.

 Literary works that are recorded by individuals are permitted for private usage only.

Compatible devices

There are nearly 80 Memory Stick™-enabled products on the market or announced for introduction worldwide, ranging from camcorders and portable music players to voice recorders and many other electronic devices.

You can currently use Memory Sticks™ with the following Sony products:

Visual:

- Cybershot digital camera
- Mavica digital camera
- PC, TRV and VX series digital video cameras
- LC data projector

Audio:

- MS Walkman
- MS Hi-fi system
- Network Walkmans
- Voice recorders

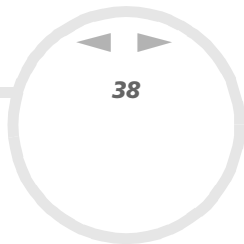

Other:

- ❑ VAIO notebooks
- ❑ VAIO desktops
- ❑ CLIE Handheld Entertainment Organiser
- ❑ Sony mobile phones
- ❑ Digital printers
- ❑ AIBO the Sony Entertainment Robot

To find out more about the products available in your country, go to:

<http://www.sonystyle-europe.com>

Inserting a Memory Stick™

To insert a Memory Stick™, proceed as follows:

- 1 Slide the front panel in the direction of the arrow to open it.
- 2 Once you have stored your data from your digital device, insert the Memory Stick™ into the Memory Stick™ media slot.
- 3 The Memory Stick™ is automatically detected by your system and appears in the **My Computer** window with its own drive.

When the system detects your Memory Stick™, it displays the **Safely Remove Hardware** icon in the taskbar.

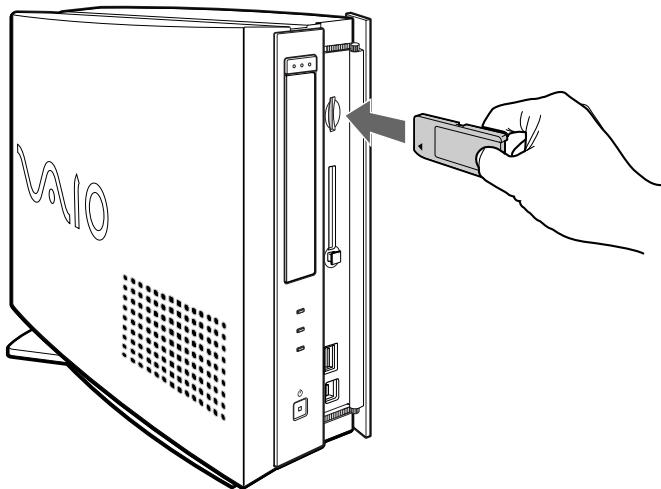



Hold the Memory Stick™ with the arrow pointing in the correct direction when you insert it into the slot. To avoid damaging the computer or the Memory Stick™, do not force the Memory Stick™ into the slot if it does not insert smoothly.

Removing a Memory Stick™

To remove a Memory Stick™, proceed as follows:

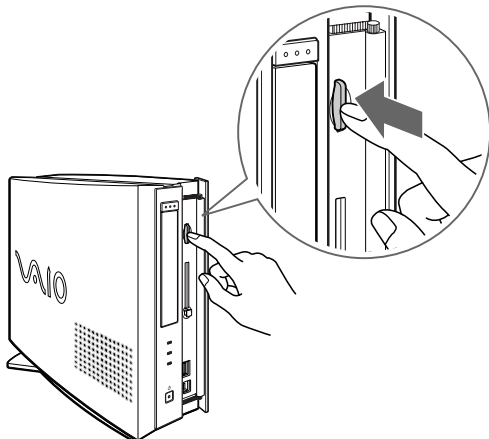
- 1 Double-click the **Safely Remove Hardware** icon in the taskbar. The dialog box **Safely Remove Hardware** appears.
- 2 Select the hardware you want to unplug.
- 3 Click **Stop**.
- 4 In the **Stop a Hardware Device** dialog box, confirm that the device can be safely removed from the system.
- 5 Click **OK**. You get the message that it is safe to remove the device.
- 6 Click **Close**.
- 7 Push the Memory Stick™ in to release it, and then pull it out.



 Always remove the Memory Stick™ gently, or it may pop out unexpectedly. You are recommended to remove the Memory Stick™ before shutting down the computer.

Write-protecting a Memory Stick™

Memory Sticks™ are designed with an erasure prevention switch to protect valuable data from accidental erasure or overwriting.

Move the tab to the right or left to set or release write-protection. On the 128 MB Memory Stick™, move the tab up or down. When the erasure prevention switch is off, data can be saved on the Memory Stick™. When the erasure prevention switch is on, data can be read from but not saved on the Memory Stick™.

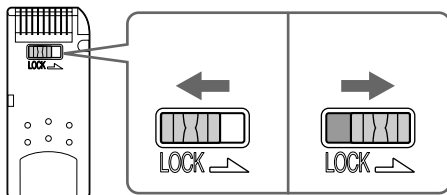

 This image does not apply to the 128 MB Memory Stick™, which has a vertical lock.

Using power saving modes

The color of the power indicator light on the main unit tells you which mode the computer is in.

Color *Mode*

Umber	Computer is in Standby mode
Green	Computer is in Normal mode
No color	Computer is turned off or in Hibernate mode

Using Standby mode

If you plan to stop using your computer for a short period of time (not overnight), you can put it into **Standby** mode instead of turning it off completely. Putting the computer into **Standby** mode saves energy and allows a quick return to normal computer use.

To set the timer for your computer to automatically enter **Standby** mode after a certain amount of time, go to **Control Panel** and choose **Power Options**.

To activate **Standby** mode manually, use one of these two methods:

Use the **Standby** button:

- 1 Save your work, close all applications and close your Internet connection, if applicable.
- 2 Press the **Standby**  button in the top right-hand corner of the keyboard. The computer goes into **Standby** mode, indicated by the amber light.

Use the Windows[®] taskbar:

- 1 Save your work, close all applications and close your Internet connection, if applicable.
- 2 From the **Start** menu on the Windows[®] taskbar, select **Turn Off Computer**.
- 3 Select **Stand By**.
- 4 Click **OK**.
The computer goes into **Standby** mode, indicated by the amber light.

To return to Normal mode, choose from the following:

- Press any key on the keyboard.
- Press the **Standby** button again.
- Press one of the PPK buttons on the keyboard.
- Quickly press the power button on your computer.



You can leave Windows® running when using **Standby**.

If you press the power button for more than four seconds, the computer will switch off automatically.

When the computer is in **Standby** mode, you cannot insert a disc.

Standby requires less time than **Hibernate**.

Standby uses more power than **Hibernate**.

Using Hibernate mode

When you are interrupted and need to leave your computer suddenly, you can put it into **Hibernate** mode. This power saving mode saves you the time of shutting down in the normal way.

When you put your computer into **Hibernate** mode:

- Everything in the memory is saved to the hard disk.
- The monitor and hard disk are turned off.
- The computer is turned off.
- The power indicator light turns off.

To set the timer for your computer to automatically enter **Hibernate** mode after a certain amount of time, go to **Control Panel** and select **Power Options**.

To activate **Hibernate** mode manually, use one of these two methods:

Use the Windows® taskbar:

- 1 Save your work.
- 2 From the **Start** menu on the Windows® taskbar, select **Turn Off Computer**.
- 3 In the **Turn off computer** window, hold down the **<Shift>** key.
Stand By turns to **Hibernate**.
- 4 Select **Hibernate**.
The computer goes into **Hibernate** mode, and the computer turns off.

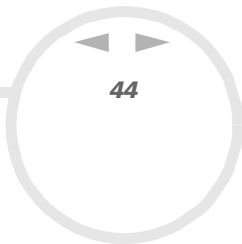

Use the power button:

- ❑ Quickly press the power button on the front of the main unit.
The computer goes into **Hibernate** mode, the computer turns off.

To return to Normal mode, choose from the following:

- ❑ Press the **Standby** button on the keyboard.
Operation returns to the same state as before.
- ❑ Press one of the PPK buttons on the keyboard and launch straight into your favorite application.
- ❑ Quickly press the power button on your computer.
Operation returns to the same state as before.

 You can leave Windows® running when using **Hibernate**.

If you press the power button for more than four seconds, the computer will switch off completely.

When the computer is in **Hibernate** mode, you cannot insert a disc.

Hibernate uses less power than **Standby**.

Hibernate requires more time than **Standby**.

Using the modem

Your VAIO desktop is equipped with an internal modem. You need to connect a phone line to take advantage of online services and the Internet, to register your computer and software online, and to contact VAIO-Link.

To connect a phone line, proceed as follows:

- 1 Plug one end of the phone cable into the phone connector on the back of the computer.
- 2 Plug the other end into the wall jack.

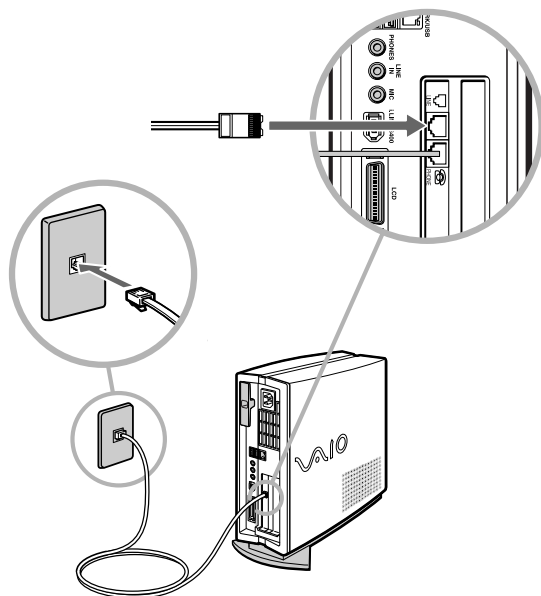

Before using your modem, it will be necessary to select the country where you are actually using it. The detailed procedure for selecting the actual country is explained in **Configuring your modem** in the Software User Guide.

 A country-specific phone plug is supplied with your VAIO desktop, allowing you to plug the phone line into the wall jack. We recommend you to use the supplied plug, because the usage of any other phone plug can decrease the connection quality.

Your computer cannot be connected to a coin-operated telephone, and may not work with multiple phone lines or a private branch exchange (PBX). If you connect the modem to a parallel connected phone line, the modem or the other connected device may not function properly. Some of these connections may result in excess electrical current and could cause a malfunction in the internal modem.

Only DTMF (Dual Tone Multi Frequency) signalling (tone dialling) is supported.

Using the correct phone plug

In the box you will find two phone plugs. Make sure you use the correct one for the country you are in, as follows:

UK:

Use the plug already attached to the phone cable. The connector can be identified by its cuboid shape and flat pins:

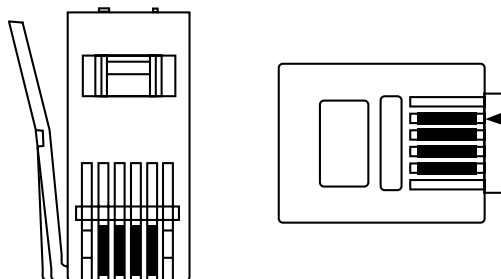

Netherlands:

Take the supplied plug adapter with the protruding pins and attach it to the phone cable:

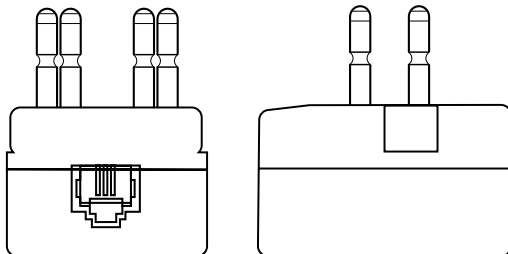

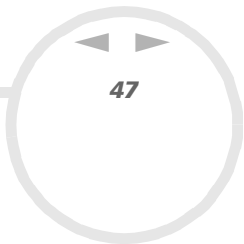

Connecting peripheral devices

You can add functionality to your computer by connecting any of these peripherals.

Connecting external speakers ([page 48](#))

Connecting an external microphone ([page 49](#))

Connecting a USB (Universal Serial Bus) device ([page 50](#))

Connecting an i.LINK™ device ([page 51](#))

Connecting to a network (LAN) ([page 54](#))

Before you connect a peripheral, turn off both the computer and the peripheral.

Connect the power cord only after connecting all cables.

Turn on the computer only after turning on all peripherals.

Hot plug and play devices (such as USB devices) should be plugged in when the computer is switched on. You do not need to shut down your computer before connecting these devices unless the manual supplied with the device states differently.

Connecting external speakers

You can enhance the sound quality of your computer by connecting external speakers.

To connect external speakers, proceed as follows:

- 1 Plug the speaker cable into the headphones connector on the back of the main unit, identified by the  symbol.
- 2 Turn down the volume of the speakers before you turn them on.

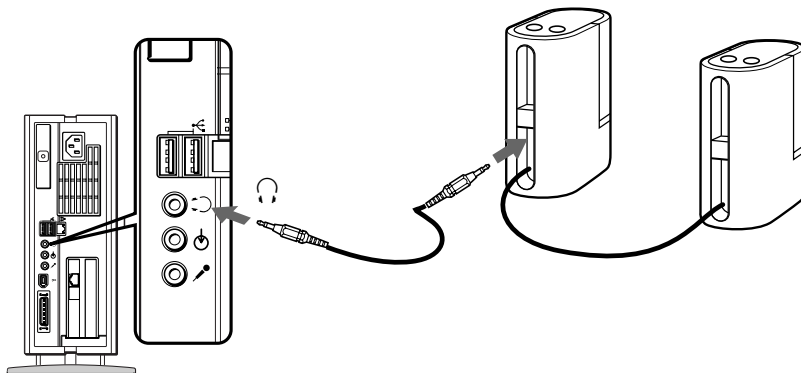

 Make sure your speakers are designed for computer use.

Do not place floppy disks on the speakers; their magnetic field may damage the data on the floppy disks.

Connecting an external microphone

Your VAIO desktop does not contain an internal microphone. If you need to use a sound input device, for example to chat on the Internet, you need to plug in an external microphone.

To connect an external microphone, proceed as follows:

- 1 Plug the microphone cable into the connector marked with the  symbol on the back of the main unit.

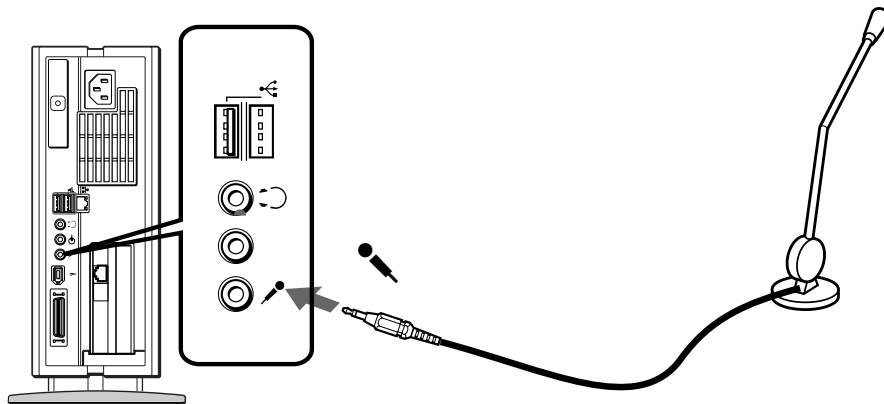

 Make sure your microphone is designed for computer use.

Connecting a USB (Universal Serial Bus) device

Use the USB ports to connect USB devices, such as a floppy disk drive or a printer.

Connecting a USB printer

To connect a printer using the USB connector, proceed as follows:

- 1 Plug a USB printer cable into one of the USB connectors on your computer (1). A USB connector is identified by the symbol Ψ .
- 2 Plug the printer power cord into an AC outlet (2).

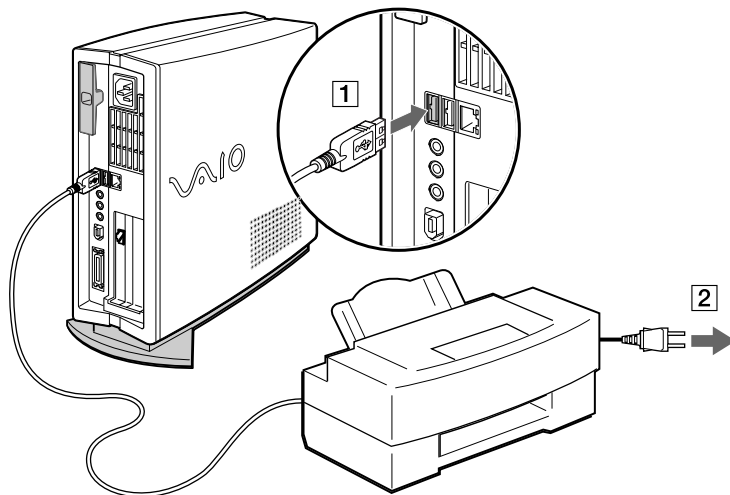

 Do not turn on the computer or the printer until all the connections are made.

This procedure does not apply to all printers. If you do not have a printer compatible to this procedure, please refer to the manufacturer's instructions on connecting and installing it.

Connecting an i.LINK™ device

Your computer includes two i.LINK™ (IEEE1394) connectors, which you can use to connect to an i.LINK™ device such as a digital video camera recorder or to connect two VAIO computers in order to copy, delete or edit files.

The 6-pin i.LINK™ connector on the back of your system can:

- ❑ Supply power from the computer to the connected device if the device has a 6-pin connector, and
- ❑ Supply 10V to 12V.

The 4-pin i.LINK™ connector on the front of the system cannot supply power to external devices.

The i.LINK™ connectors support transfer rates up to 400 Mbps; however, the actual transfer rate depends on the transfer rate of the external device.

The i.LINK™ features available may vary depending on the software applications you use. Refer to the documentation that came with your software for more information.

The i.LINK™ cables that are compatible with your VAIO desktop include cables with the following part numbers: VMC-IL4415, VMC-IL4435, VMC-IL4615, VMC-IL4635, VMC-IL6615, and VMC-IL6635. Sony computer supplies, accessories and peripherals can be purchased from your local retailer or from the Sony website: <http://www.sonystyle-europe.com>

 An i.LINK™ connection with other compatible devices is not fully guaranteed.

You are strongly advised to use only Sony i.LINK™ cables, as using other brands may cause problems with the i.LINK™ devices.

The i.LINK™ connection varies depending on the software applications, operating system and i.LINK™ compatible devices you use. Refer to the documentation that came with your software for more information.

Check the working conditions and OS compatibility of i.LINK™-compatible PC peripherals (HDD, CD-RW drive etc.) before you connect them to your VAIO desktop.

Connecting a digital video camera recorder

To connect a digital video camera recorder, proceed as follows:

- 1 Plug one end of the i.LINK™ cable into the i.LINK™ connector of the computer and the other end into the DV-Out connector on your digital video camera recorder.

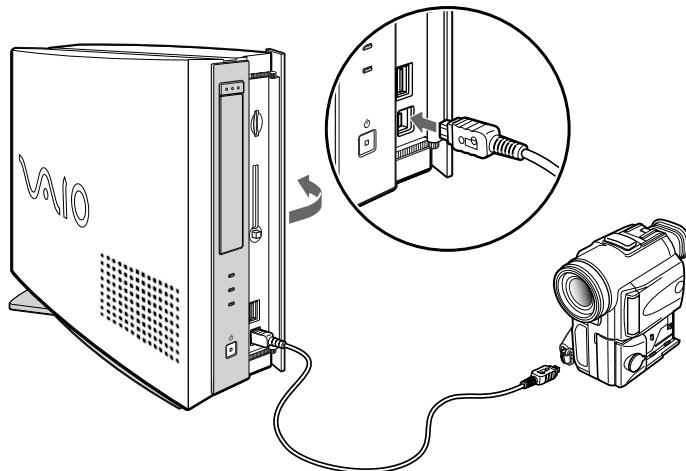

- 2 Launch the DVgate application.

 On Sony digital video cameras, connectors labelled **DV Out**, **DV In/Out** or **i.LINK™** are i.LINK™-compatible.

The Sony digital video camera recorder is an example; your digital video camera recorder may need to be connected differently.

If your digital video camera recorder includes a Memory Stick™ slot, you can copy images from it to your computer via a Memory Stick™. To do so, simply copy images on the Memory Stick™, then insert it into the Memory Stick™ slot of your computer.

Connecting two VAIO computers

You can connect your VAIO desktop to another VAIO computer using an i.LINK™ cable (not supplied). You can also print a document on a printer connected to another VAIO computer.

To connect your VAIO desktop to another VAIO computer, proceed as follows:

- 1 Insert one end of the i.LINK™ cable (not supplied) into one of the i.LINK™ connectors on the main unit of the VAIO desktop.
- 2 Connect the other end to the other VAIO computer.

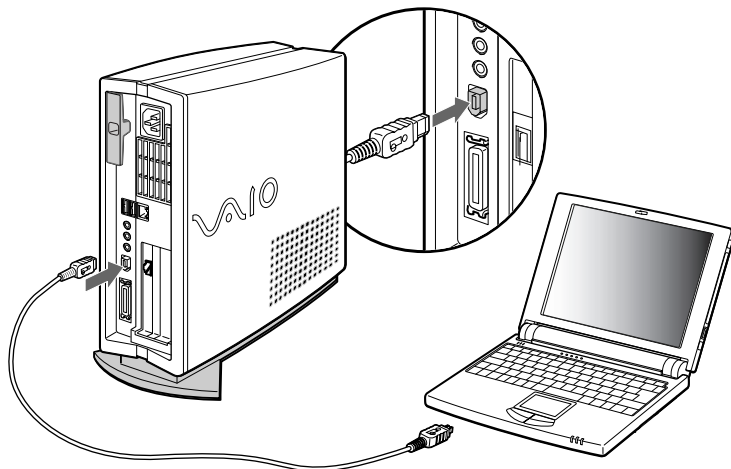

Connecting to a network (LAN)

Your computer comes with a preinstalled Ethernet interface.

To connect to a network, proceed as follows:

- 1 Right-click on **My Computer** in the **Start** menu and select **Properties**.
- 2 Click the **Hardware** tab and select **Device Manager**.
The **Device Manager** window appears, listing the devices.
- 3 Under **Network Adapters**, right-click on **RealTek RTL 8139/810X Family PCI Fast Ethernet NIL** and click **Properties**.
- 4 Under **Device Usage**, select **Use this device (enable)** and then click **OK**.
- 5 Click **OK** to close the **Properties** window.
The Ethernet connection is now enabled.

! Connect only 10BASE-T/100BASE-TX cables to the Ethernet port. Using other cables or a telephone cable may cause a malfunction, excessive heat or even fire in the port.

 For more information about connecting your VAIO desktop to the network, please consult the Hardware troubleshooting section of the VAIO-Link website:

[How to troubleshoot network problems.](#)

For help on connecting to a network, see your network administrator.

Getting help

This section describes how to get help and support from Sony, as well as troubleshooting tips for your computer.

Sony's support options

Sony provides several support options for your computer.

Printed documentation supplied with your VAIO desktop

The printed part of your documentation pack contains the following:

- ❑ A **Getting Started** brochure, where you will find a brief description of the items in your box, some specifications of your VAIO desktop, and how to set up your computer;
- ❑ A **Customer Guide**, where you will find all the basic information to start using your VAIO desktop, as well as troubleshooting and VAIO-Link information;
- ❑ Your **Sony Guarantee conditions**.
- ❑ A **Safety Regulations Guide** for your information.
- ❑ A **Modem Regulations** flyer applying to the modem.

Online user guides preinstalled on your computer

- ❑ The **Hardware Guide** explains how to use your computer and connect peripheral devices. It contains a list of specifications of your computer and accessories.
- ❑ The **Software Guide** lists the pre-installed software titles and explains how to use the utility programs and perform basic computer tasks.
- ❑ The **Customer Service Guide** gives you complete information on the VAIO-Link Services.

Other sources of information

- ❑ **VAIO-Link website**, which you can access if you have any problems with your computer:
<http://www.vaio-link.com>
- ❑ **VAIO-Link Response Centre**: Before contacting the VAIO-Link Response Centre, try to solve the problem by reading the user guides and help files supplied with the peripherals or software.

 You will need to set up and configure your VAIO's internal modem before you can make use of these communication features.

Troubleshooting

This section describes how to solve common problems you might encounter when using your VAIO desktop. Many problems have simple solutions. Please try these suggestions before contacting VAIO-Link or your local Sony dealer.

About the computer and software ([page 57](#))

About the display ([page 61](#))

About CDs and floppy disks ([page 63](#))

About sound ([page 66](#))

About the modem ([page 67](#))

About peripherals ([page 68](#))

About i.LINK™ devices ([page 71](#))

About the computer and software

My computer does not start

- ❑ Check that the computer is plugged into a power source and that it is turned on.
- ❑ Check that the power indicator on the front panel of the computer indicates that the power is on.
- ❑ Confirm that the power cord and all cables are connected firmly.
- ❑ If you have plugged the computer into an Uninterrupted Power Supply (UPS), make sure the UPS is turned on and works.
- ❑ Check that the monitor is properly connected to the main unit. Check that the brightness and contrast controls are adjusted correctly.
- ❑ Moisture condensation may have occurred. Wait at least an hour before turning the computer on.
- ❑ If the message **Press <F1> to continue, <F2> to enter setup** appears at the bottom of the display, you need to initialize the BIOS (see below).

The message 'Press <F1> to continue, <F2> to enter setup' appears at startup

If the message **Press <F1> to continue, <F2> to enter setup** appears at the bottom of the display, you need to initialize the BIOS.

To initialize the BIOS, proceed as follows:

- 1 Turn off the computer.
- 2 Remove any peripheral devices connected to the computer.
- 3 Turn on the computer and press **<F2>** when the Sony logo appears. The BIOS setup menu screen appears.
- 4 Use the arrow keys to select the **Exit** menu.

- 5 Press <F9> or use the arrow keys to select **Get Default Values**. The message **Load default configuration now?** appears.
- 6 Make sure that **Yes** is selected and then press <Enter>.
- 7 Press <F10> to exit, or use the arrow keys to select **Exit (Save Changes)**. The message **Save configuration changes and exit now?** appears.
- 8 Make sure that **Yes** is selected and then press <Enter>.

My computer does not shut down

It is recommended that you shut down your computer using the **Turn Off Computer** command on the Windows® **Start** menu. Using other methods, including those listed here, may result in loss of unsaved data.

If the **Turn Off Computer** command does not work properly, proceed as follows:

- 1 Shut down the computer by pressing <Alt>+<F4>. The **Turn off computer** window appears. Select **Turn Off**.
- 1 If this does not work, press <Ctrl>+<Alt>+<Delete>. If you have not changed to default settings, the **Task Manager** dialog box appears, where you can close a blocked application, shut down, or restart the computer.
- 2 If this does not work, press the power button and hold it for at least four seconds. This turns off the power.
- 3 Unplug the computer from the mains.

My system is running slowly

- ❑ The system response time varies, depending on the number of applications that are open and running. Close any application that you are not currently using.
- ❑ Increasing the system memory may also help. The computer has two memory slots. For memory upgrades, use only 3.3V PC-133 CL3 168pin SDRAM DIMM modules. For information on installing memory, please see the online manual, Adding and removing a memory module.

My computer locks up

- ❑ If you suspect an application is locking your system, you can try to stop it. To do this, press **<Ctrl>+<Alt>+<Delete>** once. If you have not changed the default settings, the **Task Manager** appears. Select the application that is locking your system, and then click **End Task**.
- ❑ If the above method does not work or you do not know which application is locking your system, restart the computer. On the Windows® taskbar, click the **Start** button then **Turn Off Computer**, select **Restart** in the list and click **OK**.
- ❑ If the above method does not work, press the power button and hold it for at least four seconds. This turns off the power.
- ❑ If your computer locks up while playing a CD-ROM or DVD-ROM, stop the CD, and shut down the computer by pressing **<Alt>+<F4>**, and then click **Turn Off**.

My computer or software program is not responding

To end the application that has stopped responding, proceed as follows:

- 1 Press **<Ctrl>+<Alt>+<Delete>**.
- 2 If you have not changed the default settings, the **Task Manager** appears. Scroll down until you locate the comment **Not responding** next to an application.
- 3 Select this application from the list and click **End Task**. Windows® will try to close the application. If it fails to do so, a second dialog box appears.
- 4 Select **End Task** again.

 If you are unable to unlock the application, repeat the above procedure, but select **Turn Off** from the **Task Manager** window.

If this still fails, proceed as follows:

- 1 If possible, save any unsaved work.
- 2 Press **<Alt>+<F4>**.
The **Turn off computer** box appears.
- 3 Select **Restart**.
- 4 Click **OK**.

 If none of the above solves the problem, you can restart the computer by pressing **<Ctrl>+<Alt>+<Delete>** twice, or by pressing the power button for longer than 4 seconds.

If the same application locks up regularly, contact the software publisher or the advertised technical support.

Windows® locks up during shutdown

There are many reasons why the Windows® operating system may not shut down properly, including incompatible or conflicting drivers, damaged files, or non-responsive hardware.

To search Windows® Help and Support for troubleshooting information, proceed as follows:

- 1 From the **Start** menu, select **Help and Support**.
- 2 Click **Troubleshooting**.
- 3 Click the subject on which you want the information, and then answer the questions that refer to your problem.

About the display

My LCD does not display anything

- Check that the computer is plugged into a power source and that it is turned on.
- Check that the power indicator on the main unit is on.
- Adjust the brightness of the LCD.
- The computer may be in display standby mode. Press any key to activate the display.

The window I have just closed is still on the screen

Press the **Windows®** key and **<D>** key twice to refresh the screen.

I cannot find the Windows® taskbar

- ❑ Check that the taskbar is not hidden or minimized.
- ❑ Move the cursor to each edge of the screen to retrieve the taskbar.

To change the default view of the taskbar and the start menu, proceed as follows:

- 1 Click **Start**, and select **Control Panel**.
- 2 Click **Appearance and Themes**, and then **Taskbar and Start Menu**.
The **Taskbar and Start Menu Properties** dialog box appears, where you can make the required settings.

I want to change the resolution of my display

To change the resolution of your display, proceed as follows:

- 1 From the **Start** menu, select **Appearance and Themes**, and then **Control Panel**.
- 2 Click the **Display** icon.
The **Display Properties** dialog box appears
- 3 Select the **Settings** tab.
- 4 Move the **Display area** slider to change the resolution.
- 5 Click **OK**.

About CDs and floppy disks

My CD-RW/DVD-ROM drive tray does not open

To open the CD-RW/DVD-ROM drive, proceed as follows:

With the eject button:

- 1 Make sure the power is turned on.
- 2 Press the eject button on the disc drive.

With the **My Computer** icon:

- 1 Double-click the **My Computer** icon on the Windows® desktop.
- 2 Right-click the **Compact Disc** icon.
- 3 Select the **Eject** option from the pop-up menu.

I cannot play a CD

- After inserting the CD, wait for a few seconds for the system to detect it before you try to access it.
- Make sure the label of the disc is facing outwards.
- If the disc requires software, make sure the software is installed according to the instructions of the program.
- Check the volume of your speakers.
- Clean the disc with an appropriate cleaner.
- Moisture condensation may have occurred. Leave the computer for at least 1 hour before turning it on.

I cannot play a DVD-ROM

- ❑ If a region code warning appears when you are using the DVD player, it could be that the DVD-ROM you are trying to play is incompatible with the CD-RW/DVD-ROM drive on your VAIO desktop. The region code is listed on the packaging of the disc.
 - ❑ Check your PG settings (Parental Guidance) in the DVD software as this might be preventing you from playing certain DVDs when it is activated.
 - ❑ If you hear sound but cannot see a picture, your computer's video resolution may be set too high. For best results, change the resolution in the Windows® **Control Panel – Appearance and Themes – Display – Settings** to 1024 x 768 using 32-bit colour.
 - ❑ If you see the video but cannot hear sound, check all of the following:
 - ❑ Make sure the mute setting is off in your DVD player software.
 - ❑ Check the master volume setting in the **Audio Mixer**. If you have connected external speakers, check the volume settings for your computer speakers and check the connections between your speakers and the computer.
 - ❑ In the **Device Manager**, check that the correct drivers are installed properly. To display the **Device Manager**, click **Start** and then **Control Panel**. Double-click the **System** icon. In the **System Properties** dialog box, click on the **Device Manager** tab.
 - ❑ A dirty or damaged disc may cause the computer to 'hang' while it tries to read the disc. If necessary, reboot the computer, remove the disc and then check that it is not dirty or damaged.
-  On your computer, the default DVD region code is 2, which is the region code for European DVDs. Do not change this setting using the Region Code Change function in Windows®, or any other software application. System malfunctions originating from the user changing the DVD region code are beyond the scope of your warranty and will result in service charges for repair.

My USB floppy disk drive cannot save to disk

- ❑ The floppy disk may be write-protected. Disable the write-protect feature or use a disk that is not write-protected.
- ❑ Check that the floppy disk is properly inserted into the USB drive.
- 🔧 The USB floppy disk drive is an optional accessory and can be purchased from your Sony dealer.

When I double-click an application icon, a message such as 'You must insert the application CD into your drive' appears and the software does not start

- ❑ Some titles require specific files that are located on the application CD-ROM. Insert the disc and try starting the program again.
- ❑ Make sure you place the disc in the tray with the label side facing outwards.

Why does my CD-RW drive not record at the highest speed?

You must use 8x CD-R or 4x CD-RW media to achieve optimum performance.

If you want to use other media and are having difficulty formatting non-8x CD-R and non-4x CD-RW discs, change the writing speed to a lower setting.

To change the writing speed from the default to a lower speed, proceed as follows:

- 1 Go to **My Computer** from the **Start** menu.
- 2 Right-click the disc drive icon.
- 3 Select **Properties**.
- 4 Select the **Settings** tab.
- 5 Change the **Current Write Speed** field to **4x**.
- 6 Click **OK**.

About sound

My speakers are not producing sound

- ❑ If you are using an application that has its own volume control, check that the volume is turned up.
- ❑ Check the volume controls in Windows® and in Windows® Media Player.
- ❑ If you are using external speakers, check that the speakers are plugged into the headphones connector and the volume is turned up. If the speakers have a mute button, make sure it is off. If batteries power the speakers, check that the batteries are inserted properly and that they are charged.

My microphone does not work

Check that your external microphone is plugged into the microphone connector correctly.

My microphone is too sensitive to background noise

If you find there is too much background noise when you record sound, you can adjust the microphone gain.

To adjust the microphone settings, proceed as follows:

- 1 In the **Control Panel**, choose **Sounds, Speech and Audio Devices**.
- 2 Click **Sounds and Audio Devices**.
The **Sounds and Audio Devices Properties** box appears.
- 3 Click the **Voice** tab.
- 4 Under **Voice recording**, click **Volume**.
The **Recording Control** dialog box appears.
- 5 In the **Options** menu, select **Properties**.
The **Properties** dialog box appears.
- 6 Change the setting in the **Adjust volume for** dialog box from **Playback** to **Recording**, and then click **OK**.

- 7 Reduce the microphone level by moving the slider control.
- 8 In the **Options** menu, select **Advanced Controls**, and then click the **Advanced** button under **Microphone - Balance**.
The **Advanced Controls for Microphone** dialog box appears.
- 9 Deselect the **Microphone Boost** check box, and then click **Close**.
- 10 Close the **Recording Control** dialog box.
The unwanted noise should now be cleared.

About the modem

My internal modem does not work

- Check that the phone line is plugged into your computer.
- Check that the phone line is working. You can check the line by plugging in an ordinary phone and listening for a dial tone.
- Check that the phone number the program is dialing, is correct.
- In the **Phone and Modem Options** dialog box (**Control Panel / Phone and Modem Options**), check that your modem is listed on the **Modems** tab, and that the location information is correct on the **Dialing Rules** tab.
- Each time you use your modem while travelling, make sure that the country of the active location defined in the **Phone and Modem Options** dialog box matches the country you are dialing from.

My modem cannot establish a connection

- The modem dialing mode may be incompatible with your telephone line.
- The modem may not work properly if you are behind a **Private Automatic Branch exchange** (PABX).
- Make sure that the modem is the only device connected to your telephone line.

My modem connection is slow

Many factors influence modem connection speed, including telephone line noise or compatibility with telephone equipment (such as fax machines or other modems). If you think your modem is not connecting properly to other PC-based modems, fax machines, or your Internet Service Provider, check the following:

- Have your phone company check that your phone line is free from any line noise.
- If your problem is fax-related, check that there are no problems with the fax machine you are calling and that it is compatible with fax modems.
- If you are having a problem connecting with your Internet Service Provider, check that the ISP is not experiencing technical problems.
- If you have a second phone line available, try connecting the modem to that line.

About peripherals

I cannot use DV devices. The message 'DV equipment seems to be disconnected or turned off' appears

- Check that the DV device is turned on and that the cables are properly connected.
- If you are using multiple i.LINK™ devices, the combination of the connected devices may cause unstable operation. If this is the case, turn off all connected devices and disconnect unused devices. Check the connection and then turn on the power again.
- You are strongly advised to use only Sony i.LINK™ cables, as using other brands may cause problems with the i.LINK™ devices.

My PC Card is not working

- Make sure the PC card is compatible with your version of Windows®.

I cannot print

- ❑ Check that all the cables of the printer are properly connected.
- ❑ Check that your printer is correctly configured and that you have up-to-date drivers. If necessary, contact your dealer.

My connected printer does not print after the computer resumes from a power saving mode

To reset the printer connection, proceed as follows:

- 1 Right-click **My Computer** in the **Start** menu, then select **Properties**.
- 2 Click the **Device Manager** tab.
- 3 Select **Refresh**, then click **OK**.
The printer should now function properly.

When I remove a Memory Stick™, an error message appears

Insert the Memory Stick™ into the slot again and press **<Enter>**. Wait until the active application finishes, then remove the Memory Stick™. If the message confirms the ejection of the Memory Stick™, click **OK**.

When I record images to a digital video device using DVgate, my system displays the message 'Recording to DV device failed. Check the power and cable connections to the DV devices and try the operation again'

Close all open applications and restart your computer. Frequently recording images to a digital video device while using DVgate sometimes causes this error.

My mouse does not work

- ❑ Check that the mouse is plugged into the mouse connector on the monitor.
- ❑ There may be dust or dirt inside the mouse mechanism.

To clean the mouse, proceed as follows:

- 1 Turn off the computer and turn the mouse upside down.
- 2 Remove the mouse ball cover by turning the ring clockwise as indicated by the arrows.
- 3 Turn the mouse upright and drop the mouse ball into your hand.
- 4 Using a piece of sticky tape, remove any dirt or dust on the mouse ball and inside the ball socket.
- 5 Put the mouse ball back into the socket and replace the cover.
Secure the cover by turning the ring anti-clockwise.

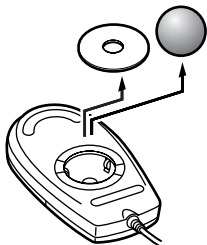

 This cleaning procedure does not apply to optical mouse devices.

My mouse needs to be set up for left-hand use

To set your mouse up for left-handed users, proceed as follows:

- 1 Go to **Control Panel**, then the **Printers and other hardware icon**.
- 2 Click the **Mouse** icon.
The **Mouse Properties** dialog box appears.
- 3 In the **Buttons** tab, select the option button next to **Switch primary and secondary buttons**.
- 4 Click **OK**.
The new mouse settings are now in place.

About i.LINK™ devices

The connected i.LINK™ device is not recognised

Disconnect the i.LINK™ device, then connect it again.

You are strongly advised to use only Sony i.LINK™ cables, as using other brands may cause problems with the i.LINK™ devices.

My i.LINK™ device does not appear on the desktop

To see the i.LINK™ device icon on the desktop, proceed as follows:

- 1 Turn off and disconnect your i.LINK™ device.
- 2 Reconnect your device.
- 3 Turn on the power on the device again.
The icon should now appear on the desktop.

I cannot establish an i.LINK™ connection between two VAIO computers

- ❑ Try disconnecting and reconnecting the i.LINK™ cable.
- ❑ If you still have no connection after waiting for a while, restart both computers.
- ❑ If either computer has just returned from a power saving mode, the connection may be affected. In this case, make sure you perform a full restart before connecting them.

Precautions

This section describes safety guidelines and precautions to help you protect your computer from potential damage.

Your VAIO desktop and memory modules use high precision components and electronic connectors technology. To avoid the invalidation of your guarantee by mishandling, it is recommended that:

- ❑ You contact your dealer to install a new memory module.
- ❑ You do not install memory modules yourself, if you are not familiar with upgrading memory on a computer.

Please contact VAIO-Link if you need assistance.

Adding and removing memory

In the future, you may want to install memory modules to expand the functionality of your computer. You can increase the memory by installing optional memory modules, although we recommend that you do not install them yourself, unless you are familiar with upgrading memory on a computer.

Be careful when adding memory. Mistakes on installation or removal of the memory module may cause a malfunction.

For memory upgrades, use only PC133 (CL3) SDRAM DIMM.

Electrostatic discharge can damage electronic components. Before touching a memory expansion board, remember the following:

- ❑ Handle the memory module gently.
- ❑ The procedures described in this document assume familiarity with the general terminology associated with personal computers and with the safety practices and regulatory compliance required for using and modifying electronic equipment.

- ❑ Disconnect the system from its power source and from any telecommunication links, networks, or modems before you open the system. Failure to do so may result in personal injury or equipment damage.
- ❑ Electrostatic Discharge (ESD) can damage memory modules and other components. Install the memory module only at an ESD workstation. If such a station is not available, do not work in a carpeted area, and do not handle materials that produce or hold static electricity (cellophane wrappers, for example). Ground yourself by maintaining contact with an unpainted metal portion of the chassis while performing the procedure.
- ❑ Do not open the memory module package until you are ready to install the module. The package protects the module from ESD.
- ! Use the special bag delivered with the memory module or wrap the module in aluminium foil to protect it from electrostatic discharge.
- ! Do not place the memory module in places subject to:
 - Heat sources such as radiators or air ducts,
 - Direct sunlight,
 - Excessive dust,
 - Mechanical vibration or shock,
 - Strong magnets or speakers that are not magnetically shielded,
 - Ambient temperature of more than +35°C or less than +5°C,
 - High humidity.

Removing a memory module

If you are not familiar with upgrading memory on a computer, we highly recommend that you contact your dealer.

To remove a memory module, proceed as follows:

- 1 Shut down your computer and disconnect all peripheral devices.
- 2 Unplug the computer from the mains.
- 3 Wait until the computer cools down.
The inside of the main unit becomes very hot during operation. Wait for about one hour for the computer to cool down before opening the unit.
- 4 Before you remove the memory module, touch a metal part of the computer to discharge any electricity accumulated on your body.
- 5 Position the main unit so the back panel is facing you. Use a screwdriver to take out the screw under the roof of the unit, just above the AC input connector (A).
- 6 Pull out the inner unit from its protective cabinet by holding the t-lever and pulling it slowly and firmly (B). You do not need to remove the unit entirely to access the memory module.
- 7 Place the unit on its left side.
- 8 Locate the memory module.
- 9 Push down one of the end levers of the module socket and gently lift the memory module up before taking it out completely (C).

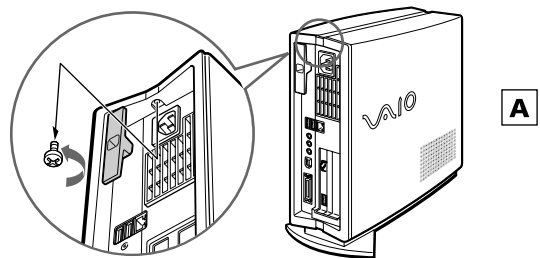

A

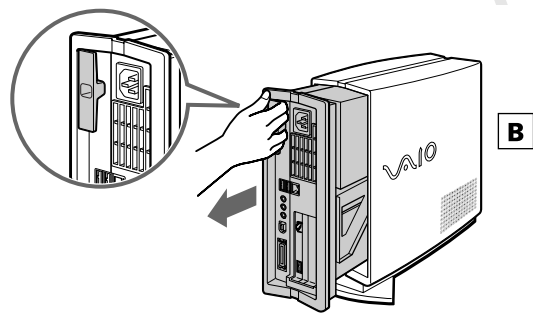

B

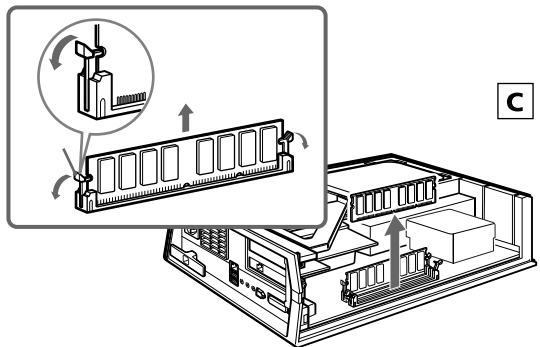

C

 Be sure to dispose of the memory module properly.

Adding or changing a memory module

If you are not familiar with upgrading memory on a computer, we highly recommend that you contact your dealer.

To add or change a memory module, proceed as follows:

- 1 Shut down your computer and disconnect all peripheral devices.
- 2 Unplug the computer from the mains.
- 3 Wait until the computer cools down.
The inside of the main unit becomes very hot during operation. Wait for about one hour for the computer to cool down before you open the unit.
- 4 Before you add or change the memory module, touch a metal part of the computer to discharge any static electricity accumulated on your body.
- 5 Remove the old memory module, if necessary (see Removing a memory module).
- 6 Slide the new memory module into the slot, making sure the release levers click into place and secure the memory card.
- 7 Slide the main unit back into its protective cabinet and replace the screw.
- 8 Turn on your computer.

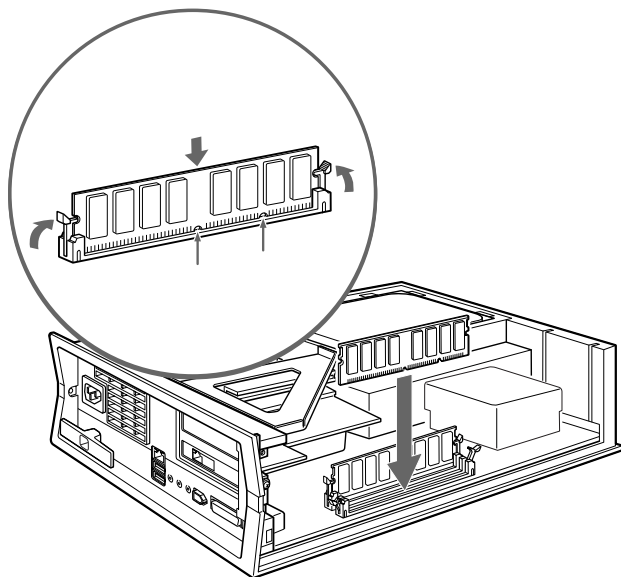

 There is only one correct way to insert the memory module. Make sure the rivets of the module are lined up with the connector.

Viewing the amount of memory

To view the amount of memory, proceed as follows:

- 1 Turn on the computer.
- 2 Click the **Start** button, point to **All Programs**, then **VAIO System Information**, and click **VAIO System Information** again.
You can view the amount of installed memory here.

Other precautions

On handling the hard disk

The hard disk has a high storage density and reads or writes data in a short time. However, it can be easily damaged by mechanical vibration, shock or dust.

Although the hard disk has the internal safety device to prevent losing data due to mechanical vibration, shock or dust, you should be careful when handling your computer.

To avoid damaging your hard disk:

- ❑ Do not subject your computer to sudden movements.
- ❑ Keep the computer away from magnets.
- ❑ Do not place your computer in a location subject to mechanical vibration or in an unstable position.
- ❑ Do not move your computer while the power is on.
- ❑ Do not turn off the power or restart the computer while reading or writing data to disk.
- ❑ Do not use your computer in a place subject to extreme changes in temperature.

 If the hard disk is damaged, the data cannot be restored.

On handling the LCD screen

- ❑ Do not leave the LCD facing the sun as it can damage the LCD. Be careful when using the computer near a window.
- ❑ Do not scratch the LCD or exert pressure on it. This could cause a malfunction.
- ❑ Using the computer in low temperature conditions may produce a residual image on the screen. This is not a malfunction. When the computer returns to normal temperature, the screen returns to normal.
- ❑ A residual image may appear on the screen if the same image is displayed for a lengthy period of time. The residual image disappears after a while. You can use a screensaver to prevent residual images.

- ❑ The screen becomes warm during operation. This is normal and does not indicate a malfunction.
- ❑ The LCD is manufactured using high-precision technology. You may, however, see tiny black points and/or bright spots (red, blue, or green) that continuously appear on the LCD. This is a normal result of the manufacturing process and does not indicate a malfunction.
- ❑ Avoid rubbing the LCD screen, as this can damage the screen. Use a soft, dry cloth to wipe the LCD screen.

On using the power source

- ❑ Your computer operates on 220V-240V (1.2A) AC 50/60 Hz.
- ❑ Do not share the AC outlet with other high power-consuming equipment, such as a photocopier or shredder.
- ❑ You can purchase a power strip with a surge protector. This device prevents damage to your computer caused by sudden power surges, in an electrical storm, for example.
- ❑ Do not place heavy objects on the power cord.
- ❑ To disconnect the cord, pull it out by the plug. Never pull the cord itself.
- ❑ Unplug your computer from the wall outlet if you will not be using the computer for a long time.

On handling your computer

- ❑ Clean the unit with a soft cloth, which is either dry or lightly moistened with a mild detergent solution. Do not use any type of abrasive pad, scouring powder, or solvent such as alcohol or benzene, as these may damage the finish of your computer.
- ❑ Should you drop a solid object or any liquid onto the computer, shut down your computer and then unplug it. You may want to have the computer checked by qualified personnel before operating it again.
- ❑ Do not drop the computer or place heavy objects on top of the computer.

- ❑ Do not place your computer in a location subject to:
 - ❑ Heat sources, such as radiators or air ducts
 - ❑ Direct sunlight
 - ❑ Excessive dust
 - ❑ Moisture or rain
 - ❑ Mechanical vibration or shock
 - ❑ Strong magnets or speakers that are not magnetically shielded
 - ❑ An ambient temperature of more than 35°C or less than 10°C
 - ❑ High humidity.
- ❑ Do not place electronic equipment near your computer. The electromagnetic field of your computer may cause a malfunction.
- ❑ Provide adequate air circulation to prevent internal heat from building up. Do not place your computer on porous surfaces such as rugs or blankets, or near material such as curtains or draperies that may block its ventilation slots. Always use the supplied VAIO desktop stand for the main unit.
- ❑ The computer uses high-frequency radio signals and may cause interference to radio or TV reception. Should this occur, relocate the computer a suitable distance away from the set.
- ❑ Use only specified peripheral equipment and interface cables; otherwise, problems may occur.
- ❑ Do not use cut or damaged connection cables.
- ❑ If the computer is brought directly from a cold location to a warm one, moisture may condense inside your computer. In this case, allow at least one hour before turning on your computer. If any problems occur, unplug your computer and contact VAIO-Link.
- ❑ Make sure you disconnect the power cord before cleaning the computer.
- ❑ As you may lose important data once your computer is damaged, you should back up your data regularly. Restore the original application programs from the Product Recovery CD-ROM.

On handling floppy disks

- ❑ Do not open the shutter manually or touch the surface of the floppy disk.
- ❑ Keep floppy disks away from magnets.
- ❑ Keep floppy disks away from direct sunlight and other sources of heat.

On handling compact discs

- ❑ Do not touch the surface of the disc.
- ❑ Do not drop or bend the disc.
- ❑ Fingerprints and dust on the surface of a disc may cause reading errors. Always hold the disc by its edge and central hole, as shown.

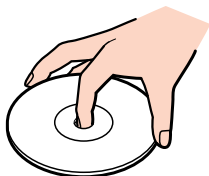

- ❑ Proper care of the disc is essential to its continuous reliability. Do not use solvents such as benzine, thinning agents, commercially available cleaners or anti-static spray, as they may cause damage to the disc.
- ❑ For normal cleaning, hold the disc by its edge and use a soft cloth to wipe the surface from the center out.
- ❑ If the disc is badly soiled, moisten a soft cloth with water, wring it out well, and use it to wipe the surface of the disc from the center out. Wipe off any remaining moisture with a dry soft cloth.

On handling the Memory Stick™

- ❑ Do not touch the Memory Stick™ connector with your finger or metallic objects.
- ❑ Use only the label supplied with the Memory Stick™ as a label.
- ❑ Do not bend, drop, or apply heavy shock to the Memory Stick™.
- ❑ Do not disassemble or modify Memory Sticks™.
- ❑ Do not let Memory Sticks™ get wet.
- ❑ Do not use or store Memory Sticks™ in a location subject to:
 - ❑ Extremely high temperatures, such as in a car parked in the sun
 - ❑ Direct sunlight
 - ❑ High humidity or near corrosive substances.
- ❑ Use the storage case supplied with the Memory Stick™.

Specifications

Model**PCV-LX2**

<i>Operating system</i>	Microsoft® Windows® XP Professional
<i>Processor</i>	Intel® Pentium® 4 1.70 GHz
<i>Hard disk drive</i>	80 GB
<i>Standard RAM</i>	256 MB
<i>Maximum RAM</i>	1 GB
<i>Cache</i>	256 KB
<i>LCD screen</i>	15" LCD XGA (1024x768) TFT
<i>MPEG</i>	MPEG 2 Digital Video Supports full-screen playback
<i>Graphics</i>	nVIDIA GeForce2 MX Ti (16MB)
<i>Internal modem</i>	Built-in modem V.90
<i>Sound capabilities</i>	16-bit CD-quality stereo sound

Model**PCV-LX2**

<i>CD-RW/DVD-ROM drive</i>	<p>32x max. CD-ROM reading speed 8x max. CD-R writing speed 32x max. CD-R reading speed 8x max. CD-RW writing speed 20x max. CD-RW reading speed 8 max. DVD-ROM reading speed</p> <p>Laser diode properties: Wave length: CD: 780nm - 790nm DVD: 635nm - 665nm Laser output(read): CD-ROM/R/RW 1.14mw, DVD-ROM 0.4mw Laser output(write): CD 40mw</p>
<i>Expansion capabilities</i>	Two PCI slots (one for modem card)
<i>Built-in capabilities</i>	stereo speakers
<i>Special buttons</i>	PPK (programmable power keys)
<i>Connection capabilities (Rear)</i>	2 USB ports, VAIO LCD display, Line-in, i.LINK™ (6-pin) port, 10BASE-T/100BASE-TX Fast Ethernet LAN connection (RJ-45), microphone, telephone connector, headphones
<i>Connection capabilities (Front)</i>	i.LINK™ (4-pin) port, USB port, Memory Stick™ slot, PC Card slot

Model	PCV-LX2
<i>Connection capabilities (LCD display)</i>	PS/2 [®] Mouse port, PS/2 [®] keyboard port, USB port
<i>Supplied accessories</i>	VAIO wheel mouse, VAIO convertible keyboard and palmrest, power cord, phone cord
<i>Power requirement</i>	220–240V 1.2A 50-60Hz
<i>Power management</i>	ACPI (Advanced Configuration & Power Interface)
<i>Dimensions Width x height x depth</i>	CPU: 107 mm x 370 mm x 280 mm Keyboard with palmrest: 435 mm x 51 mm x 205 mm LCD display: 435 mm x 357 mm x 163 mm
<i>Weight</i>	Desktop unit: 6.4 kg Keyboard: 1 kg Display: 5.1 kg
<i>Operating temperature</i>	+10°C to +35°C (temperature gradient less than 10°C/hour)
<i>Storage temperature</i>	-20°C to +60°C (temperature gradient less than 10°C/hour)
<i>Operating humidity</i>	20% to 80% (not condensed), provided that humidity is less than 65% at +35°C (hygrometer reading of less than 29°C)
<i>Storage humidity</i>	10% to 90% (not condensed), provided that humidity is less than 20% at +60°C (hygrometer reading of less than 35°C)

Specifications are subject to change without notice.

Glossary

This section refers to terms used in this manual. These terms and definitions have been compiled to provide you with a better understanding of your VAIO computer.

<i>Term</i>	<i>Definition</i>
<i><F1> key</i>	The <F1> key gives you access to the online help of most software.
<i>10BASE-T/100BASE-TX</i>	Ethernet system providing data transfer rates of 10 Mbps (megabits per second) and 100 Mbps. The 100BASE-TX is a very direct derivative of 10BASE-T. Its 100 Mbps speed is achieved by simply sending the signal 10 times faster.
<i>ACPI</i>	Short for Advanced Configuration and Power Interface, a power management specification. ACPI enables the operating system to turn peripherals on and off and to control the amount of power given to each device attached to the computer. With ACPI, a CD-ROM player can be turned off by the operating system if it is not in use.
<i>Application recovery</i>	A recovery process that enables you to recover any of the applications initially available on the computer. Performing an application recovery is useful when an individual application does not run properly or to reinstall a driver when a device does not work properly.
<i>Application recovery CD-ROM</i>	CD-ROM that enables a VAIO computer user to recover all the applications that were available when the computer was purchased. The CD-ROM is supplied with the computer.
<i>BIOS</i>	An acronym for Basic Input/Output System. The BIOS is a program that enables the computer to start when you turn it on. It monitors the data stream between the operating system and the computer's hardware devices.
<i>CardBus</i>	CardBus is the commercial name for an advanced PC Card. The CardBus technology allows computer users to enjoy higher performances as far as data transfer and operating speed are concerned. See PCMCIA.

<i>Term</i>	<i>Definition</i>
<i>CD-ROM</i>	Abbreviation for Compact Disc Read-Only Memory. A high-capacity optical disc, usually 650 MB in size, capable of being read from but not written to.
<i>CD-RW</i>	Short for Compact Disc-ReWriteable. Compact Disc that can be used to write or rewrite data to it. A CD-RW can be written to several times, a CD-R can only be written to once.
<i>CPU</i>	The CPU (Central Processing Unit) is the brains of the computer; it processes the instructions of your system's programs. The CPU is also known as the processor or microprocessor and can be found on the motherboard of your computer.
<i>DC In</i>	The Direct Current interface to which you connect your computer's AC adapter.
<i>Docking station</i>	An additional device that you can connect to your notebook. The docking station contains slots for expansion boards , bays for storage devices and ports for additional peripherals (such as printers or monitors).
<i>Driver</i>	A driver is software enabling you to use hardware devices. For example, in order for you to be able to use a printer, you must first install its driver. Many drivers, such as the mouse driver, come with the operating system.
<i>DVD-ROM</i>	Short for Digital Video Disc. A type of read-only CD with a minimum capacity of 4.7 GB (maximum capacity can reach 17 GB). This high storage power makes it the ideal medium for storing films.
<i>Ethernet</i>	Ethernet is the most widely implemented local area network (LAN) technology. The Ethernet system called 10BASE-T provides data transfer rates of 10 Mbps (megabits per second). A more recent version of Ethernet, called 100BASE-T, provides data transfer rates of 100 Mbps. Gigabit Ethernet supports data rates of 1 gigabit (1,000 megabits) per second.
<i>EULA</i>	EULA (End-User License Agreement) is the name given to a license governing the software on your computer. The EULA can be found in the Read this first section at the beginning of the software guide or directly on the VAIO desktop.

<i>Term</i>	<i>Definition</i>
<i>i.LINK™</i>	i.LINK™ is Sony's version of the IEEE 1394 standard for high-speed digital serial interface. The standard is regarded in the audio/video and IT industries as the most suitable interface for connecting computers and digital audio/video devices (such as digital cameras etc.).
<i>ISP</i>	An ISP (Internet Service Provider) is a company which provides you with a user name, password and telephone number in order to connect to the Internet.
<i>L2 cache memory</i>	Cache memory is RAM-like memory that enables quick access to data that has already been read by the computer. L1 and L2 are levels of cache memory in a computer.
<i>LAN</i>	A LAN (Local Area Network) is a group of computers connected together within a limited geographical area. It enables users to share devices (such as printers) and information using one processor or server.
<i>LCD</i>	Short for Liquid Crystal Display. Flat notebook display technology using liquid crystals (and light polarisation) to provide sharp, flicker-free images on a screen comprised of millions of tiny cells. Color can be produced by two basic techniques. Passive matrix is the less expensive of the two technologies. The active matrix technology (or TFT) produces better quality but is also more expensive.
<i>LED</i>	Short for Light-Emitting Diode. A semiconductor device that lights up when electricity passes through it.
<i>Lithium-ion battery</i>	A lithium-ion battery uses lithium cobalt oxide and carbon as electrodes and ions move from one electrode to the other during charge and discharge. Lithium-ion batteries are the first choice for notebooks because of their light weight, high energy density and because they have no memory effect. In addition they do not use heavy metals like lead, mercury or cadmium.
<i>MAPI</i>	Short for Messaging Application Program Interface. A Microsoft Windows interface enabling you to send e-mail messages. It allows e-mail access and distribution among applications. MAPI-compatible applications include a Send Mail or Send in the File menu of the application.

<i>Term</i>	<i>Definition</i>
<i>maximum RAM</i>	The maximum amount of RAM that your computer can contain. Once this amount is reached, you can no longer add additional RAM to your computer.
<i>Motherboard</i>	The motherboard is the main circuit board inside your computer. It holds the CPU, the BIOS, the memory and so on.
<i>MPEG</i>	MPEG or Moving Pictures Experts Group is a standard for audio-visual compression of video sequences. MPEG achieves high compression rates by storing only the changes from one frame to another. The decrease in data is generally imperceptible to the human eye. MPEG-1 was developed for digital storage of video and audio data on CD-ROM. MPEG-2 achieves better image and audio quality and is more targeted to TV broadcasting and DVD.
<i>Operating system</i>	The operating system is software that manages all the other programs in a computer. It defines how the computer reads and writes information to its disks (and other hardware). Windows 2000, Windows Millennium Edition, Windows XP Professional and Windows XP Home Edition are examples of operating systems found on VAIOs.
<i>Partition</i>	A partition is a logical division of a computer's hard disk. A two-partition hard drive would typically contain C: and D: drives. Partitioning is particularly useful if you run more than one operating system or to clearly separate your data files from your installed software.
<i>PBX</i>	A PBX (Private Branch Exchange) is a private telephone network within an enterprise. Under this system, the calls between the enterprise members are local and the phone numbers are made up of 3 or 4 digits. Companies generally choose this phone system for internal communication because it is less expensive than the regular network. The users can still share a number of outside lines for making calls external to the PBX.
<i>PC Card</i>	A PCMCIA card. The term PC Card is more widely used than PCMCIA. See PCMCIA.

<i>Term</i>	<i>Definition</i>
<i>PCMCIA</i>	PCMCIA (Personal Computer Memory Card International Association) is the name of the group that produced the specification for the credit card-sized plug-in boards for laptop computers. The cards used to be called PCMCIA cards, but as this was rather unpronounceable, these cards are now termed PC cards. An example of a PC card is a credit card-sized modem.
<i>Pixel</i>	A pixel (Picture Element) is a part of your screen. Your screen is made up of thousands of pixels, enabling you to see colours and pictures on it. The more pixels, the higher the resolution and the better the image quality.
<i>Port replicator</i>	An additional device that you can connect to your notebook. The port replicator contains ports that enable you to connect additional peripherals (such as a printer or a monitor) to your VAIO. A port replicator is similar to a docking station, but does not include additional slots for adding expansion boards or storage devices.
<i>Processor</i>	The processor is the brains of the computer; it processes the instructions of your system's programs. The processor is also known as the CPU or microprocessor and can be found on the motherboard (see this word) of your computer.
<i>Product recovery CD-ROM</i>	The product recovery CD-ROMs include the application recovery CD-ROM and the system recovery CD-ROM(s)
<i>PS/2</i>	A type of mouse or keyboard port.
<i>PSTN</i>	PSTN (Public Switched Telephone Network) refers to the plain old telephone service, the national telecommunication networks implementing voice transmission by using analog signals.
<i>RAM</i>	Short for Random Access Memory, the memory used to run programs and store data in current use. RAM is the fastest kind of memory to read from and write to. Information stored in RAM is lost when you turn off the computer. The higher the RAM capacity, the faster your current data can be processed.

<i>Term</i>	<i>Definition</i>
<i>Resolution</i>	The degree of sharpness and clarity of an image. Resolution is expressed in pixels. Frequent computer screen resolutions are 640 x 480 pixels (VGA resolution; appropriate for a 14-inch screen), 800 x 600 (appropriate for a 15-inch screen), 1,024 by 768 (appropriate for a 17-inch screen), and 1,280 by 1,024. LCD displays usually use a higher resolution than a CRT of the same size.
<i>RGB signal cable</i>	RGB stands for Red, Green, Blue. A cable that requires separate transmission types for the three colours on the display.
<i>SDRAM</i>	Synchronous DRAM is a kind of dynamic random access memory running at a much higher clock speed than regular memory.
<i>Standard RAM</i>	The amount of RAM that is available on your computer when you purchase it.
<i>System recovery</i>	A recovery process that enables you to recover the hard disk image initially available on the computer. Performing a system recovery is useful in the event of a serious system crash or if you want to modify the size of your partitions.
<i>System recovery CD-ROM</i>	CD-ROM that is supplied with your computer and that enables a VAIO computer user to recover the hard disk image that was available when the computer was purchased.
<i>TFT</i>	Short for Thin Film Transistor. Top-of-the-range notebook display for excellent picture quality. The TFT technology offers the sharpest resolution for flat displays; each pixel is supported by one to four transistors.
<i>UPS</i>	A UPS (Uninterruptible Power Supply) is a device including a battery that protects your computer from data loss in the event of a power failure. The battery takes over as soon as a power interruption is detected. If you are using the computer when the power failure occurs, you have time to save all unsaved data and to shut down your computer.
<i>USB</i>	USB (Universal Serial Bus) is a hardware interface for attaching devices (such as a keyboard, mouse, joystick, scanner or printer). You can connect up to 127 devices to a USB port. The USB standard is Hot Plug and Play.

<i>Term</i>	<i>Definition</i>
<i>VAIO</i>	Short for Video Audio Integrated Operation. Brand name covering Sony's PC products, peripherals, accessories and software. VAIO-branded items are all designed to make the best use of Sony's Audio-Video (AV) and Information Technology (IT) skills.
<i>WAN</i>	WAN (Wide Area Network) is a computer network connected together and covering a relatively large geographical area. This is in contrast to LAN, where the network is usually set up within one building or small geographical area. The largest existing WAN is the Internet.
<i>XGA</i>	Short for Extended Graphic Array, a graphics standard. An XGA board can provide up to 1,024 x 768 pixels and supports up to 65 thousand colours.