

Instruction Manual for the



E-SC 1102 Series



!Warning!

Read all instructions before beginning installation or use of this gate opener.

This operator exerts a high level of force.

Exercise caution at all times and stay clear of the system during operation.

Manufactured by

FAAC
An ISO 9001 Certified Company USA

CE DECLARATION OF CONFORMITY OF MACHINES

(Directive 89/392/EEC, Annex II, Part B)

Manufacturer: FAAC S.p.A.

Address: Via Benini, 1 – 40069 Zola Predosa Bologna – Italy

Declares that: Domolink A.K.A. Estate Swing (USA) mod operator

- Is built to be integrated into a machine or to be assembled with other machinery to create a machine under the provisions of Directive 89/392/EEC, and subsequent amendments 91/368/EEC, 93/44/EEC.
- Conforms to the essential safety requirements of the following EEC directives:
 - 73/23/EEC and subsequent amendment 93/68/EEC, 89/336/EEC and subsequent amendment 92/31/EEC and 93/68/EEC.
 - And also declares that it is prohibited to put into service the machinery until the machine in which it will be integrated or of which it will become a component has been identified and declared as conforming to the conditions of Directive 89/392/EEC and subsequent amendments assimilated under national laws under DPR #459 of July 24, 1996.

Bologna, January 1, 2002

Managing Director
A. Bassi



Warnings for the installer General safety obligations

1. Attention! To ensure the safety of people, it is important that you read all the following instructions. Incorrect installation or incorrect use of the product could cause serious harm to people.
2. Carefully read the instructions before beginning to install the product.
3. Store these instructions for future reference.
4. This product was designed and built strictly for the use indicated in the documentation. Any other use, not expressly indicated here, could compromise the good condition/operation of the product and/or be a source of danger.
5. FAAC declines all liability caused by improper use or use other than that for which automated system was intended.
6. Do not install the equipment in an explosive atmosphere; the presence of inflammable gas or fumes is a serious danger to safety.
7. The mechanical parts must conform to the provisions of Standards EN 12604 and EN 12605.

For non-EU countries, to obtain an adequate level of safety, the standards mentioned above must be observed, in addition to national legal regulations.

8. FAAC is not responsible for failure to observe Good Technique in the construction of the closing elements to be motorized, or for any deformation that may occur during use.
9. The installation must conform to Standards EN 12453 and EN 12445.

The safety level of the automated system must be C+D.

10. Before attempting any job on the system, cut out electrical power and disconnect the batteries.
11. The main power supply of the automated system must be fitted with an all-pole switch with contact opening distance of 3 mm or greater. Use of a 6A thermal breaker with all-pole circuit break is recommended.
12. Make sure that a differential switch with threshold of 0.03 A is fitted upstream of the system.
13. Make sure that the earthing system is perfectly constructed, and connect metal parts of the means of the closure to it.
14. The automated system is supplied with an intrinsic anti-crushing safety device consisting of a torque control. Nevertheless, its tripping threshold must be checked as specified in the Standards indicated at point 10.
15. The safety devices (EN 12978 standard) protect any danger areas against mechanical movement risks, such as crushing, dragging, and shearing.
16. Use of at least one indicator-light (e.g. FAACLIGHT 12VDC) is recommended for every system, as well as a warning sign adequately secured to the frame structure, in addition to the devices mentioned at point "15".
17. FAAC declines all liability as concerns safety and efficient operation of the automated system, if system components not produced by FAAC are used.
18. For maintenance, strictly use original parts by FAAC.
19. Do not in any way modify the components of the automated system.
20. The installer shall supply all information concerning manual operation of the system in case of an emergency, and shall hand over to the user the warnings handbook supplied with the product.
21. Do not allow children or adults to stay near the product while it is operating.
22. Keep remote controls or other pulse generators away from children, to prevent the automated system from being activated involuntarily.
23. Transit through the leaves is allowed only when the gate is fully open.
24. The user must not attempt any kind of repair or direct action whatever and contact qualified personnel only.
25. Do not short-circuit the poles of the batteries and do not try to recharge the batteries with power supply units other than Master or Slave cards.
26. Do not throw exhausted batteries into containers for other waste but dispose them in the appropriate containers to enable them to be recycled.
27. **Anything not expressly specified in these instructions is not permitted.**

Estate Swing Summary of Functions

The Estate Swing is only to be used for vehicular swing gates in a Class I setting.

Class I: A vehicular gate opener (or system) intended for use in a home of one-to-four single family dwelling, or a garage or parking area associated therewith.

The FAAC Estate Swing automated system was designed and built for controlling vehicle access. Do not use for any other purpose.

The EstateSwing automated system automates residential swing-leaf gates with leaves of up to 12' in length.

It consists of a locking electro-mechanical linear operator, powered by a 12V DC battery, coupled with control board recharging the battery. The SLAVE equipment is controlled by the MASTER equipment to which all accessories and pulse generators are connected. The MASTER card can be programmed and is used to set the following: function logics, work times (by self-learning) and pause times, leaf speed, and the sensitivity of the anti-crushing device.

The system will automatically lock when the motor is not operating. A release system enables the gate to be moved by hand in case of a system failure.

For Your Assistance

Keep this manual safely stored after installation.

Serial Number _____

Date of Purchase _____

Place of Purchase _____

Have this information on hand while handling all service and warranty issues.

The table of contents are listed to assist you locating a desired section. We do however strongly suggest studying every page of the instruction manual before attempting installation.

Table of Contents

	SECTION:	
• Review of specifications, warnings, parts, and tools	1	
⇒Specifications of the Estate Swing and Components	1.1	
⇒System Overview & Preliminary Checks	1.2	⚠
⇒Estate Swing Parts List	1.3	
⇒Tools Needed for Installation	1.4	
• Pre-installation charging	2	
⇒Control Board Layout	2.1	
⇒IMPORTANT: Charging Battery Prior to Use	2.2-3	⚠
• Basic Installation	3	
⇒IMPORTANT: Setback & Clearance	3.1	
⇒Installation of Mounting Hardware and Arm	3.2-3	
• Mounting Control Box	4	
⇒Finding Location and Mounting	4.1	⚠
• Pre-Learning Connections	5	
⇒Removable Terminal Strip	5.1	
⇒Installing temporary safety jumpers	5.2	
⇒Actuator Arm and Dual Power Connections	5.3	⚠
⇒Installing the Receiver and Transmitter	5.4	
⇒Power	5.5	⚠
• Basic Programming	6	
⇒Programming Gate Movement Variables i.e. auto close, speed, force, delays	6.1	
⇒Gate Movement Variables LED Chart	6.2	
⇒Complete Start/Stop Learning Process	6.3-5	

The table of contents are listed to assist you locating a desired section. We do however strongly suggest studying every page of the instruction manual before attempting installation.

Table of Contents

	SECTION:	
• Diagnostics & Troubleshooting	7	
⇒Simple Diagnostics	7.1	
⇒Trouble Shooting	7.2-4	
⇒Logic Summaries and Flow Charts	7.5-6	
• Accessories	8	
⇒Accessory Terminals	8.1-2	
⇒Photocell& Safety Device Guide	8.3-4	
⇒Installing Accessories	8.5	



Marks pages with opener or usage warnings. Although we have marked these as very important warnings, **please read the entire manual. Every step** is important to the correct installation of your gate opener.

Specifications

MODEL	Estate Swing
Power Supply	115V AC/ 12V DC
Rated Absorbed Power (W)	48
Max Static Force (N)	1700
Load-free angular speed (in./sec.)	1.25
Length of operator power cable (ft.)	2.3 CANNOT BE MODIFIED
Use frequency (cycles/hour)	~5
Consecutive cycles on charged battery	Max. 15
Battery recharge time	10 min. for each full cycle
Operating ambient temperature	-4 to 131 Deg F
Operator weight (lbs)	4.85
Protection class	IP 44
Gate leaf max length (ft.)	Up to 12
Gate leaf max weight (lbs.)	Up to 550
Operator overall dimensions LxHxD(in.)	See below



Length: 25"
 Height: 3 1/2"
 Widths: 1 1/2", 3", 5"



Standard System Overview and Safety Zones

The system display to the right is a recommended standard system. Other approved accessories can be installed. Photo sensors and a flashing light indicating gate movement is recommended for safety purposes.

- 1,2 Estate Swing Operator
- 3 Photocells (not included)
- 4 Master control board
- 5 Slave control board
- 6 Push button opening device (not included)
- 7 Receiver extension (not included)
- 8 12Vdc flashing lamp (not included)
- 9 Positive stop
- 10 AC transformer

Notes: 1) Do not extend operator connection cables
2) When laying electrical cables, use appropriate rigid and/or flexible tube
3) Do not run any wires in the same conduit as 110 AC power that may be in the area. This will cause unwanted interference

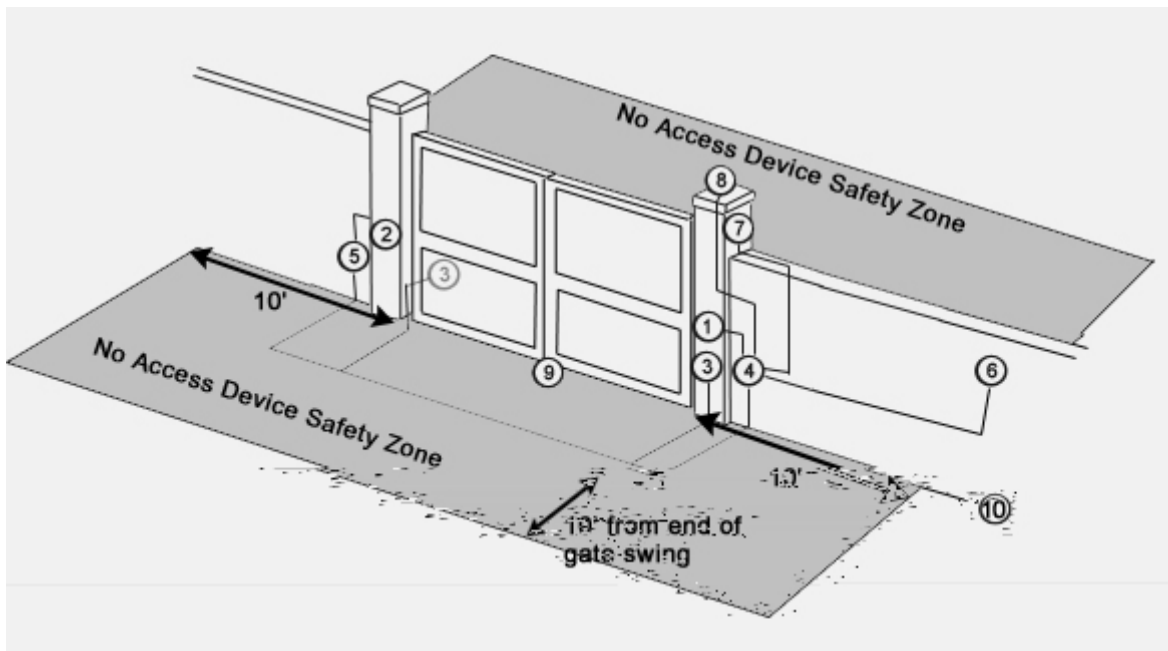

IMPORTANT Preliminary Checks:

To ensure safety and an efficiently operating automated system, make sure the following conditions are observed.

- The gate and column must be suitable for being automated. Check that the structure is sufficiently strong and rigid, and its dimensions and weights conform to those indicated on page 1.
- Make sure the leaves move smoothly without any irregular friction during entire travel.
- Make sure the hinges are in good condition. Ball bearing hinges are ideal for gates weighing over 200 lbs. or over 10' in length.
- Make sure the gate is plumb and level.
- The fence post must be secured in the ground with concrete. This will prevent alteration of alignments and leveling during installation and during cycles.

Estate Swing Parts List

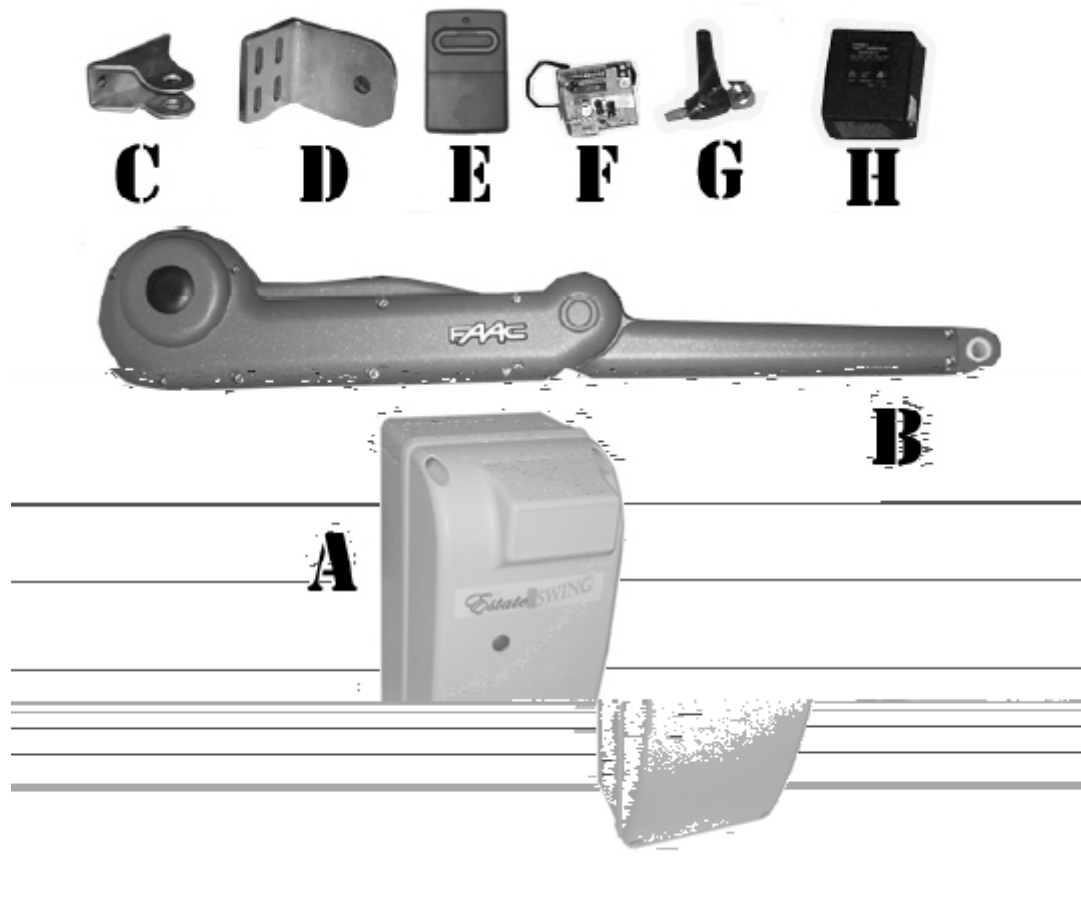

Master Operator

- A. Control Box
- B. Operator Arm
- C. Gate Mount Bracket
- D. Post Mount Brackets
- E. Transmitter
- F. Receiver
- G. Post Mounting nuts, Manual Release Key
- H. Transformer

Slave Operator

- A. Control Box
- B. Operator Arm
- C. Gate Mount Bracket
- D. Post Mount Brackets
- G. Post Mounting nuts, Manual Release Key
- 34' 2 conductor stranded direct burial wire

Tools Needed



Diagnostics



- Power Drill
- Crescent Wrench
- 5/16" Drill Bit
- Drill bit appropriate to the anchoring hardware used
- Flat Head Mini Screwdriver
- Phillips Head Screwdriver
- Tape Measure
- Level
- Wire Strippers
- C-clamps
- Carpenters Clamp

Other items that may be needed prior to commencing installation. ***Bolded items are necessary to all applications.***

- Start and stop post, bracket or door stop. Although the FAAC Estate swing features soft start/stop it is still recommended to have a closed stop post because having a start and stop point permanently in place may extend the life of the operator by absorbing some of the momentum of the gate during open and close cycles.
- **16 gauge 2 conductor stranded direct burial low voltage wire will be required to run power to your operator.** Length is determined by distance between transformer power supply and the control box.
- **8 - 5/16" Redheads, Lag Screws and shields, or other anchoring system will be needed to fasten the column brackets to the column.** Type will be determined by the type of column.
- **4 - 5/16" hex bolts** will be needed to attach the gate brackets to the gate leaves.
- Hardware to attach the control box to a post or fence.
- Watertight connectors for running wires into the control box.
- A voltage meter and digital camera may be necessary to run diagnostic checks.
- If your transformer is going to be plugged into an outdoor outlet you will need to weatherproof that outlet and transformer. Electrical boxes or plug covers can be obtained from a local hardware store to accommodate both the plug and transformer.

Control Board Layouts

ATTENTION: Study the control board and read this section thoroughly before attempting to operate your gate opener.

Warnings:

- Before attempting any job on the control board (connections, maintenance), turn off electrical power and unplug the support battery.
- Install a surge protector upstream of your opener, the opener is not power surge proof nor will power surge damage be covered under warrantee.
- Always separate power from control and safety cables (push-buttons, receivers, photocells, etc.). To avoid any electrical noise, use separate sheaths or a shielded cable (with earthed shield).

Layout of Master Control Board

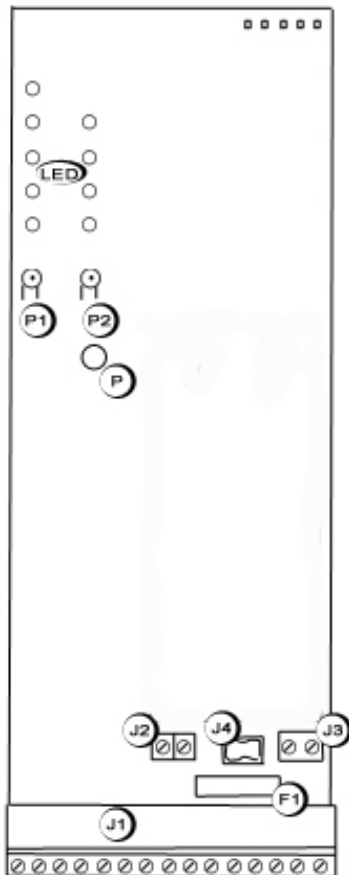

Layout of Slave Control Board

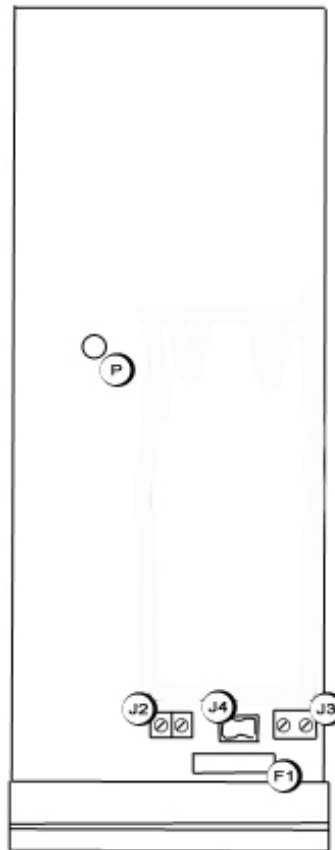

LED	Programming LEDs	P	Power ON and diagnostic LED
P	Power ON and diagnostics LED	F1	Battery and motor fuse - F15A
P1	“Function” programming push-button	J2	Bus connection terminal board
P2	“Value” programming push-button	J3	Motor connection terminal board
F1	Battery and motor fuse - F15A	J4	Battery connector
J1	Accessories Terminal board	J5	Minidec connector/RP receiver
J2	Transformer Terminal board		
J3	Motor connection terminal		
J4	Battery connector		
J5	Minidec connector/RP receiver		

IMPORTANT: Charging Battery Prior to Use

Before beginning any electrical stages of installation we highly recommend charging the battery on the control board for **12 hours**. This can be done anywhere there is an outlet available.

1. Plug the battery into the control board (fig 1). For r

3. Charge the slave board by wiring it to the master board terminal strip. [terminal 6 of the master *must* connect with the right side of J2 on the slave and terminal 15 of the master *must* connect with the left side of the slave] (fig 3)



NEVER CONNECT POWER FROM ANY SOURCE DIRECTLY TO THE SLAVE BOARD. The slave board may ONLY be connected to the Master control board.

Let the unit charge for 12 hours, after remove both the transformer power and the battery. You can now proceed with the installation process.

Fig 3

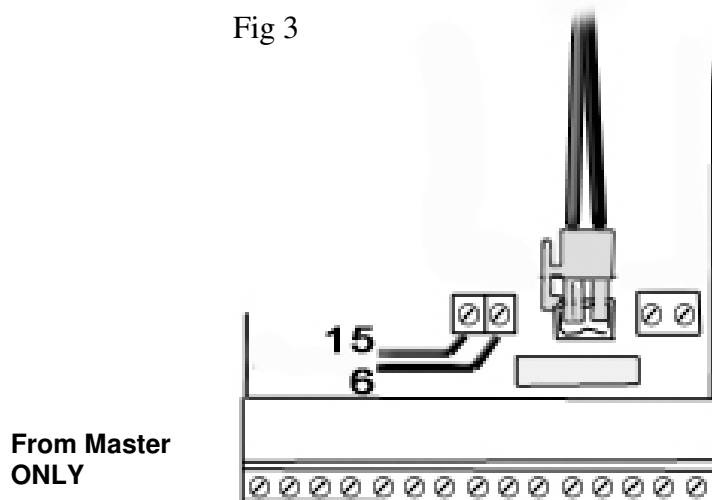

Slave Charging

IMPORTANT: Setback

The setback is a very important requirement to be aware of during installation of the post mounting bracket. The setback allows the operator arm to achieve appropriate and equal leverage during opening and closing cycles.

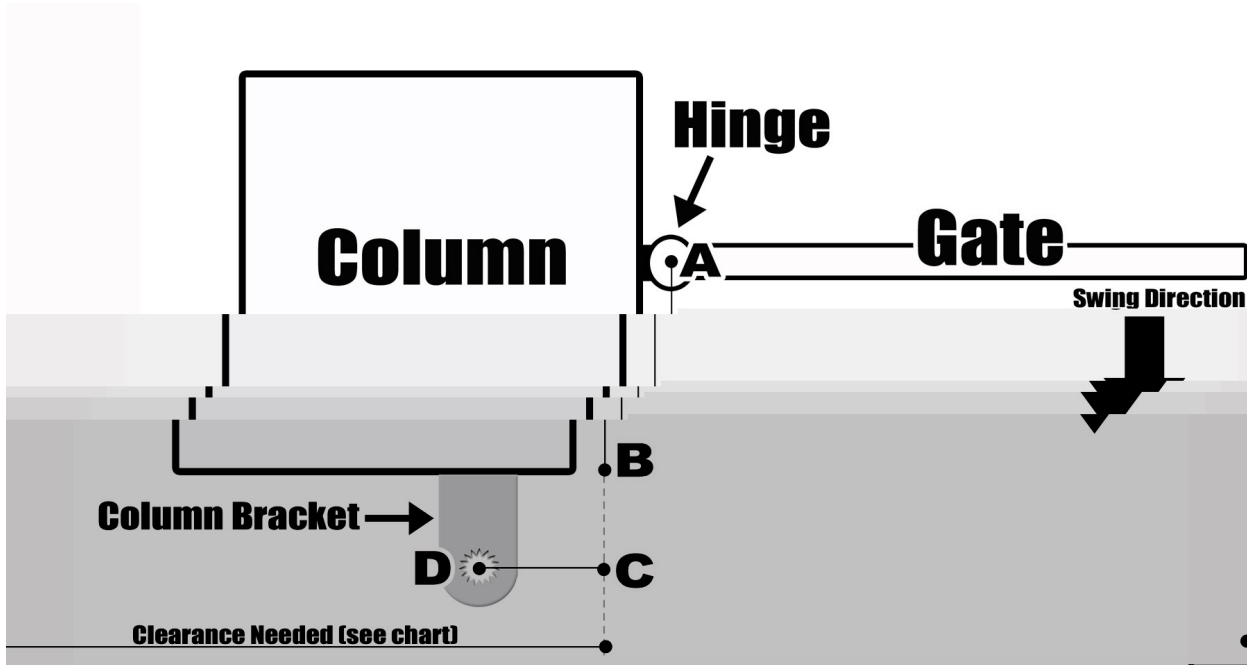

Distance - A to B	Distance - C to D	Degree of Opening	Clearance
1 1/4" - 6 1/3"	4" - 6 1/3"	90 degrees	16"
6 1/3" - 8"	4 1/3"	90 degrees	16"
1 1/4" - 3 1/4"	6 1/3" - 8"	110 degrees	20"
1 1/4" - 2"	7" - 8"	120 degrees	21"

The purpose of this page is to clarify and show examples of possible setbacks. Install the brackets according to the installation directions following this page.

Installation of Mounting Hardware and Arm

1. Set up closed stop points for your gates if you are choosing to use them. For a snug closing the master gate should close against the slave gate using an overlapping bracket as in the picture to the right. The closed stop on the ground is for an overall taugth closing point

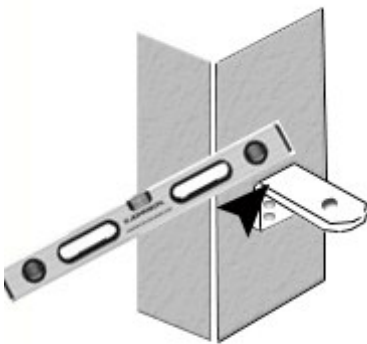
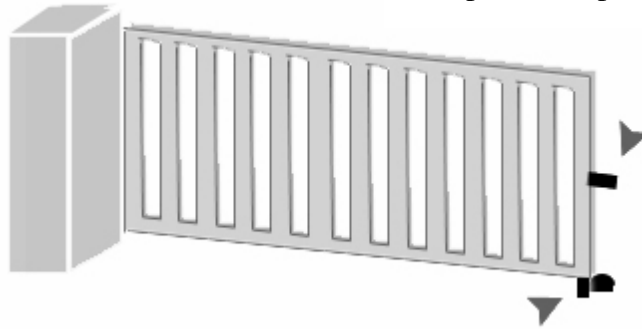

2. Position the column bracket to the dimensions from the previous page. In most installations the gate is already hung so the distance between A and B is going to dictate the opening degree and distance to set the bracket on the back of the column. Before securing the bracket, check for levelness.

3. Straighten the arm to it's full extended position as seen below. This will be the position the arm will be mounted in the closed position of the gate. See the following page before mounting the ate bracket.



----- (dashed line) is the fully closed position for the gates

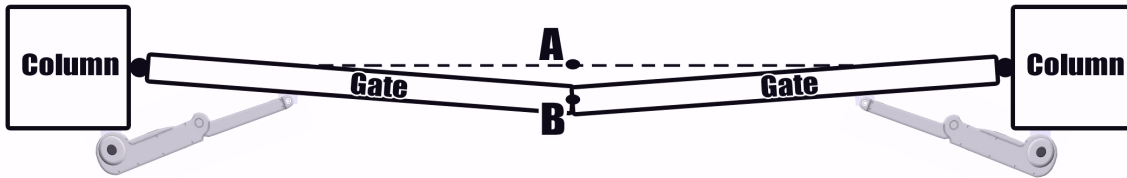

Distance between A and B is 1" (one inch).

4. Using a tape measure, snap line or something else straight, draw a line where the full closed point of the gates will be. Then from the center of that line measure in towards the property 1 inch. This will be where the arms in the fully extended position will mount to the gate. (Second example to the right)

NOTE: Why do this you may ask. This is because even though the arms have reached their full extension momentum of the gate will carry the gate an inch further by just turning the base gears of the operator.

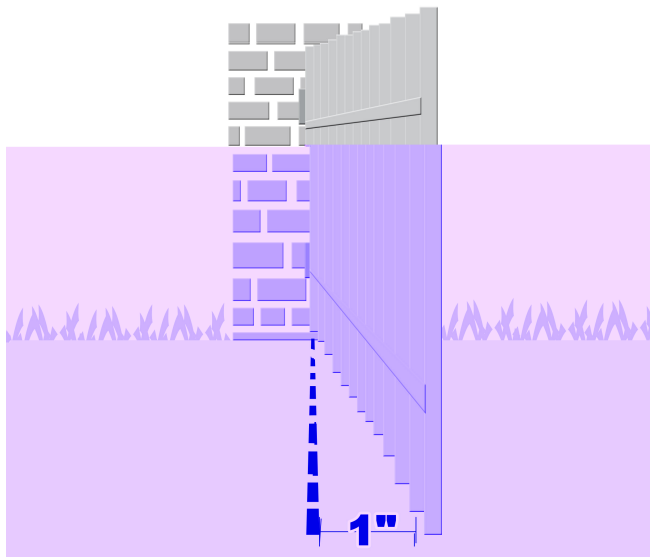

5. Manually release the opener arms. Do this by removing the black cap on the top, inserting the release key and turning it until the gears are free turning.



6. With the arms still fully extended attach the gate mounting bracket to the end of the arm using the provided nut and bolt. Insert the base of the opener in the column bracket and place the gate bracket against the gate while the gate is set at an inch open. This will be the correct mounting position for the gate bracket. After attaching the bracket, be sure to relock the operator arm for regular operation.

Finding Location and Mounting Control Box

1. The control box must be mounted near your actuator arm.



The wire on the back of the actuator arm cannot be shortened or lengthened.

Keep your control box in a location at least 3 feet off the ground to avoid water buildup.

2. Level your box and mark your mounting holes. The holes are located in four corners of the control box (fig 1).
3. After marking your holes drill them and attach the control box to the post.
4. There are three separate knockouts on the bottom of the control box. Find a water-tight connector at your local hardware store that will fit one of the knockout as well as fit all of your wires through it. Remove the necessary knockout in the bottom of the box and affix a watertight connection (fig 2).

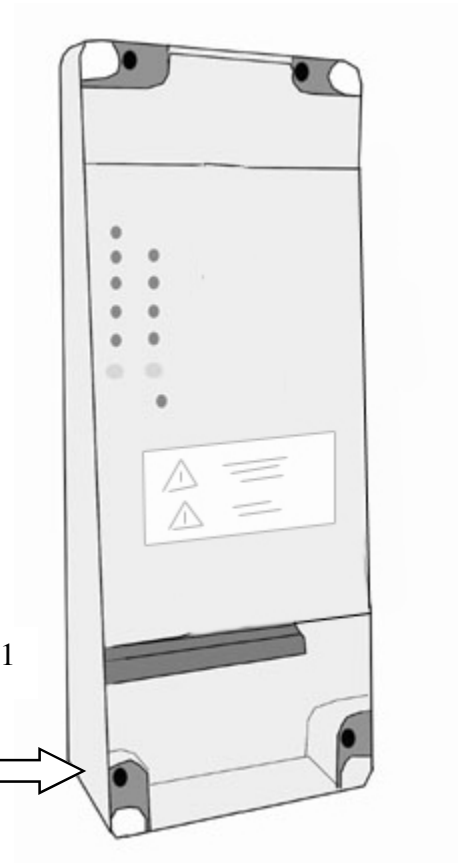

Fig 1

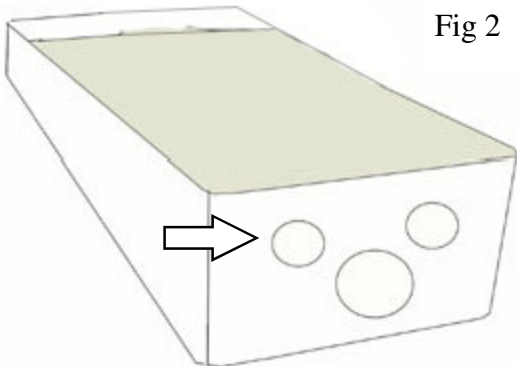

Fig 2



Your box must be kept water-tight. Moisture can damage your control board.

If you have trouble locating a water-tight connector contact Estate Swing 1-800-640-GATE for assistance.

For Your Convenience

The green numbered terminal strip at the bottom of the control board is easily removed for wiring. Simply pull straight down on the terminal strip to remove it from the board. It will slide right off. Slide it back on when you are finished with your wiring connections.

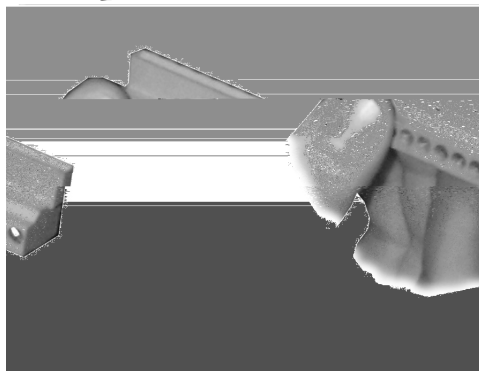

Installing temporary safety jumpers

For your opener to function properly a few connections must be made prior to the learning process. Accessories should **NOT** be installed until after the learning process is complete.

Actuator and Dual Power Connections



Caution! Do not reverse polarity of the wires connecting the Master and Slave board. This will cause permanent damage to both boards and void your warranty. **Caution!**

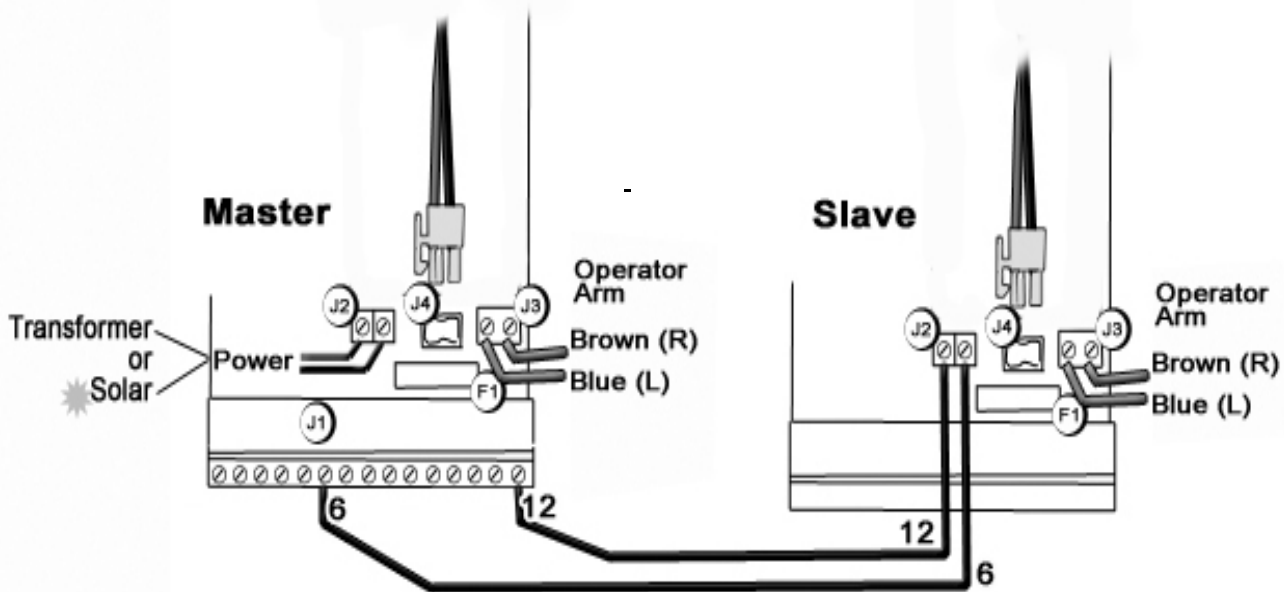

Slave Board Power—On the slave board it is used as communication with the master board and powering from the master board. **Connect the slave board to the master board using 16 gauge low voltage wire. This wire must be run across the driveway and can be up to 100 feet in length. Terminal 6 MUST connect with the RIGHT side of J2 on the Slave board, Terminal 15 MUST connect with the LEFT side of J2 on the Slave board.**



J3 - Actuator Connections—This terminal is used to connect the operator arm to the control board both on the master and slave side. **IMPORTANT: Follow the above chart for wire colors. DO NOT EXTEND OR SHORTEN THE OPERATOR ARM WIRES.**

Installing and Setting Transmitters and Receivers

Installing the Receiver

- 1) Locate the 5 Silver Pins on your **MASTER** Estate Swing board, located above the battery.
- 2) Locate the **white** connector on the receiver.
- 3) Push the **white** connector from the receiver on the 5 pins on your FAAC board with the dip switches of the receiver board facing away from the center of the Estate Swing board.

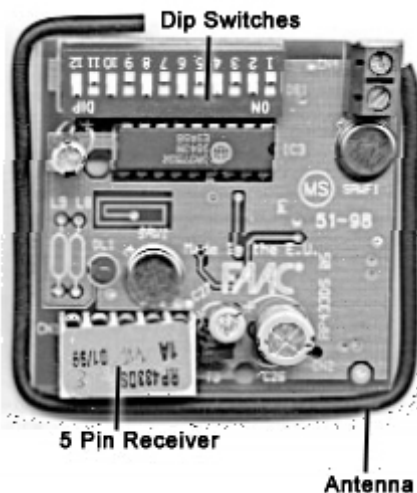

Setting the Dip Switches

- 1) Set the dip switches on the receiver by switching them in the up, down or center position.
Record this dip switch combination
- 2) Slide off the battery cover of the transmitter
(located at the bottom front cover)
- 3) Set the dip switches in the transmitter to the same settings as the dip switches on the receiver.
- 4) Repeat this for all of the transmitters.

Positioning the Antenna

Bend the antenna to go around the back of the receiver board and down the left side of the Estate Swing battery.



Dip switches are located under the battery lid.

Power

1. The Estate Swing (Master Unit if Dual Operator) comes with 1) AC transformer. The AC transformer supplied has 4 screw terminals, use the center 2 terminals to attach your low voltage wire (polarity is not relevant). You may locate the transformer up to **1000'** away from the control board with **16 gauge or larger direct burial low voltage wire**.
2. Insert the two wires into the power in section on the control board (J2) on the master board. The wires are interchangeable and do not have a positive and negative. The slave board receives power from the master board only, do not connect power directly to the slave side. **Do not splice the power cable wire.**



Never run 110VAC power directly to the Estate Swing. This will destroy the Estate Swing control board.

3. **Before plugging in your transformer**, plug the battery into the control board. The clear plastic clip gets clipped into J4 with the clip side on the left. The other side of the battery wire has a clear plastic disconnect that slides on the battery terminals. Red to Red, Black to Black. *Reversing the wires will blow the fuse.*

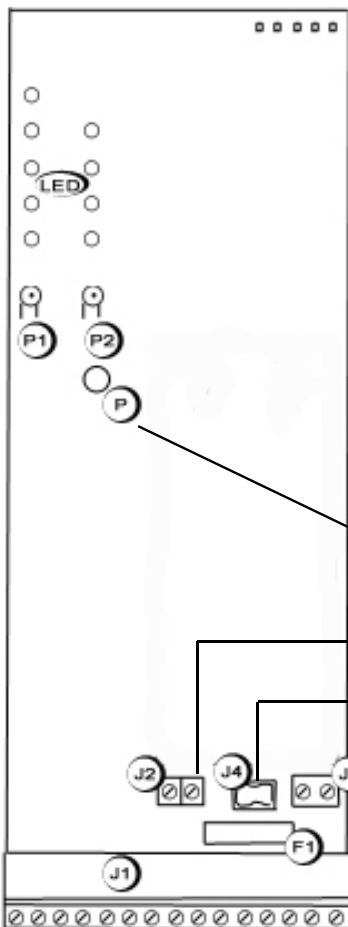

Never connect the power wire with the transformer plugged in. Contact between the two lead wires, even for a second, will destroy the transformer.

4. Plug the **transformer** into a 110 V AC outlet.
5. The transformer is not weather proof and must be kept in a covered area. *Plug covers are available from your dealer, contact 1-800-640-GATE for a dealer in your area.*
6. The power light (P) will be on if the power and battery are connected properly. If the power light is blinking slowly then only the battery is connected, check your power connections.

Programming Gate Movement Variables

Using the following procedures you can change factory settings such as auto close, speed, force, delays and more.

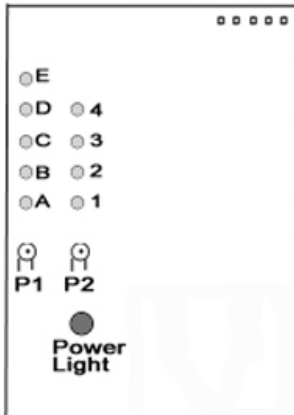

Begin the programming process by pressing **P1**. Pressing **P1** selects **A,B,C,D or E**. A, B, C, D and E correspond with the variables in the chart on the following page.

When you are on the desired variable you would like to change the setting of press **P2** to change the setting of that variable. **P2** will change the light to 1, 2, 3 or 4 which correspond with the settings on the chart below on the following page. Below is a list what each variable controls.

A: Switches between Function Logics. Function Logics are sets of actions that will occur when an accessory terminal connection is made or disrupted. Each set of actions is designed to give different results providing increased safety, convenience or other.

B: Switches between the amount of time the gate pauses before closing after reaching full open. By selecting Logic EP (4) all pause times will be void and the gate will remain open until an opening devices is triggered.

C: Switches between the amount of time the gate waits before beginning motion when an opening and closing is triggered or if dual gates are installed, pause time will only apply to one gate.

D: Switches between the amount of force the gate opener will exert before an obstruction is detected and the gate reverses directions.

E: Switches between the speed of the gate motion. This does not effect the soft start and stop.

See the following page for Gate Movement Variables LED Chart .

Controlling the Master Leaf with either the Master or Slave Control Board

With this function you can select the leaf you wish to move with the Master Control Board. Press and hold down **P1**, then press and hold down **P2**. LED A starts flashing. Using **P2** move from LED 1 to LED 2 according to the desired leaf control as described below:

LED 1 lit - Master controls leaf 1 (default)

LED 2 lit - Master controls leaf 2

NOTE: The operation of the Slave Control Board is automatically set according to the Master Control Board.

Gate Movement Variables LED Chart

Variable LED Definitions	
Function LED	Function
A	<p>Function Logic — Logic flow chart found on page 18,19</p> <p>1= A (Automatic - automatically closes the gate depending on the set pause time. It is the most common setting)</p> <p>2= S (Safety - designed for higher control and accelerated levels of safety, also automatically closes the gate)</p> <p>3= AP (Stepped Automatic - is very similar to automatic (A) but has a higher amount of safety. It has an increased amount of motion stop points.)</p> <p>4= EP (Stepped Semi-automatic - is designed to function similar to a garage door opener. Turns off the auto close setting.)</p>
B	<p>Pause Times</p> <p>1= 5 Seconds</p> <p>2= 10 Seconds</p> <p>3= 20 Seconds</p> <p>4= 30 Seconds</p>
C	<p>Master Opening / Closing Delays</p> <p>1= open 0 sec. / close 0 sec.</p> <p>2= open 2 sec. / close 2 sec.</p> <p>3= open 2 sec. / close 4 sec.</p> <p>4= open 2 sec. / close 8 sec.</p>
D	<p>Static Force</p> <p>1= Low</p> <p>2= Medium Low</p> <p>3= Medium High</p> <p>4= High</p>
E	<p>Speed</p> <p>1= Low</p> <p>2= Medium Low</p> <p>3= Medium High</p> <p>4= High</p>

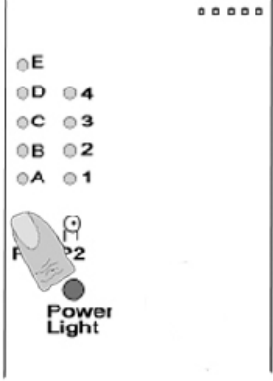

Pressing P1 moves you through the Letter LEDs

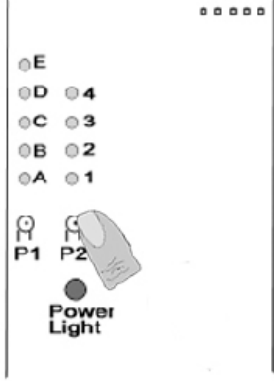

After switching to the desired Letter LED, Pressing P2 moves you through the Number LEDs

Complete Start/Stop Learning Process

Begin by pressing P1 6 times to light A-E simultaneously. While the 5 LEDs are lit steadily, hold down **P2** for about 3 seconds. The operator will start the maneuver process.

Using **P2**, **Briefly** press the button once for each of the following motion transitions:

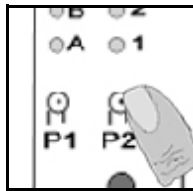
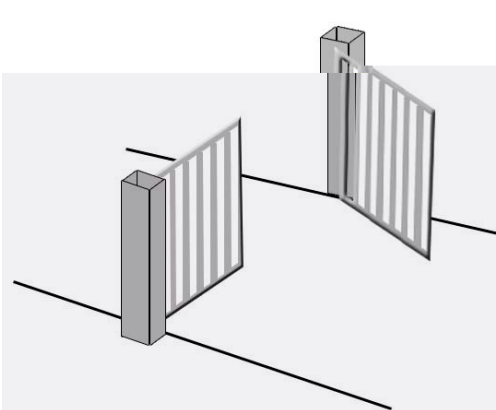
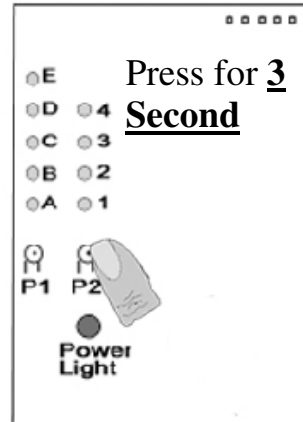

1) Press P2 to teach leaf 1 opening deceleration starting point.

With open stops, let the gate make contact, **don't** press P2

2) Let the leaf make contact with the full open stop point. The opener will then stop and leaf 2 will begin to open.

OR if not using open stops

2 alt.) Press P2 to stop the openers opening motion and leaf 2 will begin to open.

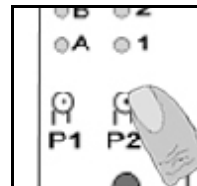
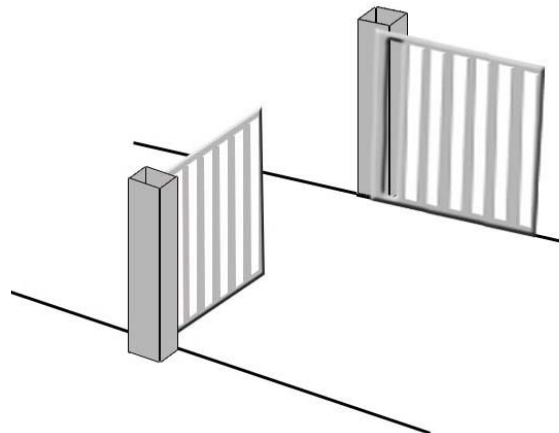

Without open stops, press P2

Estate Swing

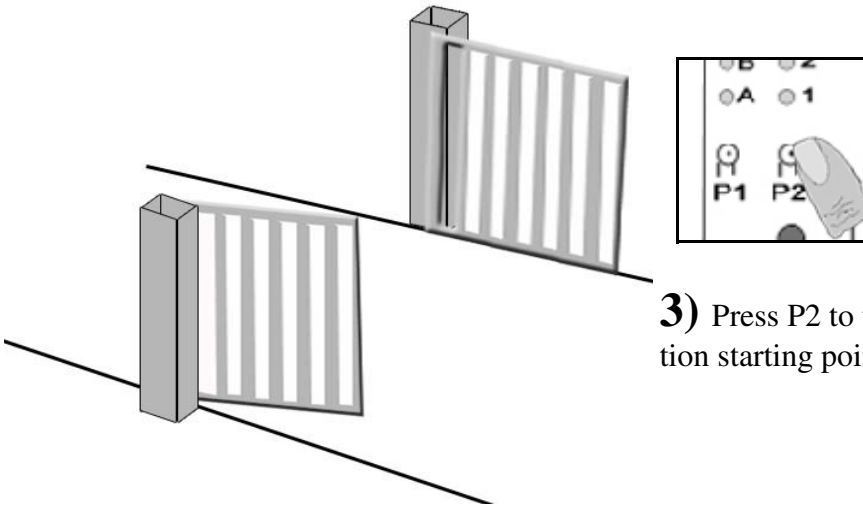

3) Press P2 to teach leaf 2 opening deceleration starting point.

4) Let the leaf make contact with the full open stop point. The opener will then stop and reverse directions.

With open stops, let the gate make contact, **don't** press P2

OR if not using open stops

4 alt.) Press P2 to stop the openers opening motion and reverse the motion of the gate.

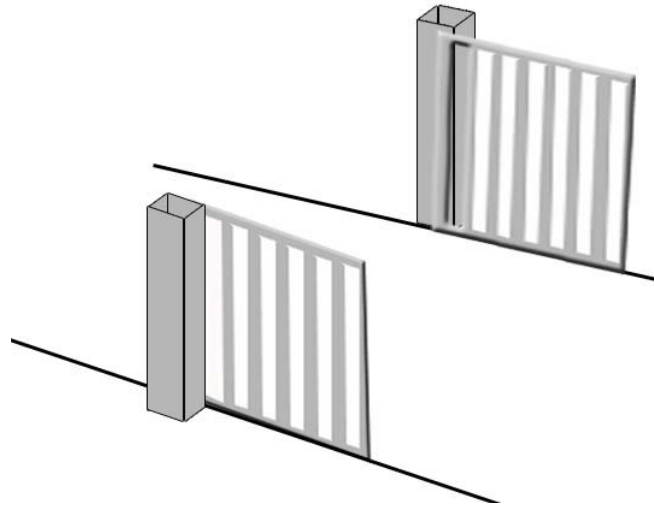
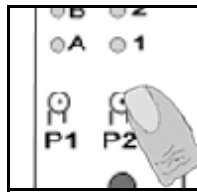

Without open stops, press P2

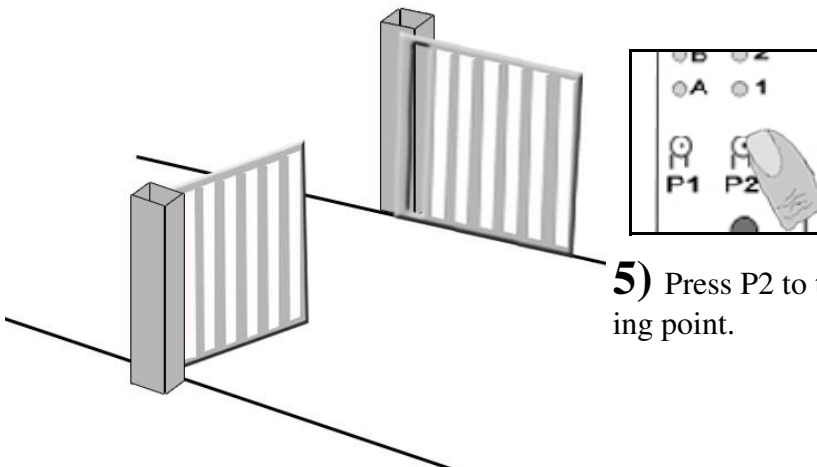

5) Press P2 to teach leaf 2 closing deceleration starting point.

6) Let the leaf 2 make contact with the full closed stop point or full closing point of arm. Leaf 1 will begin closing.

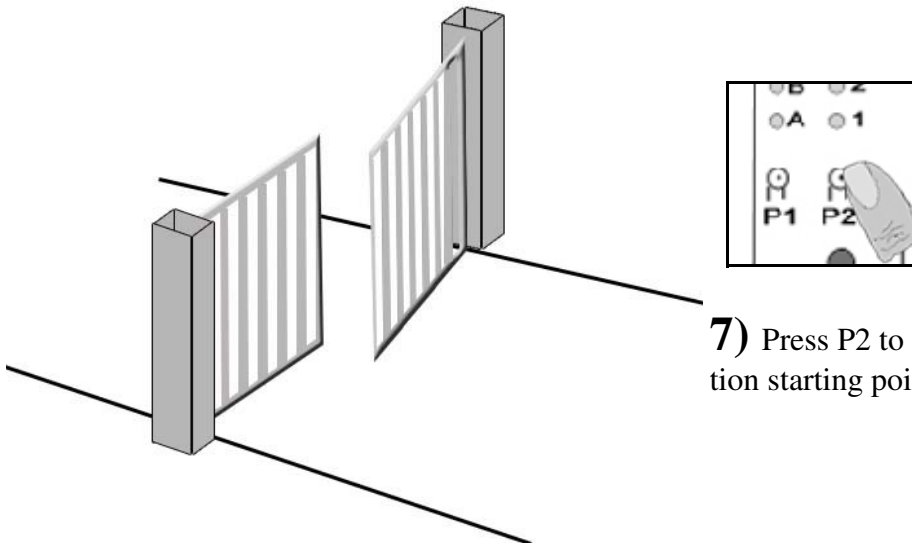
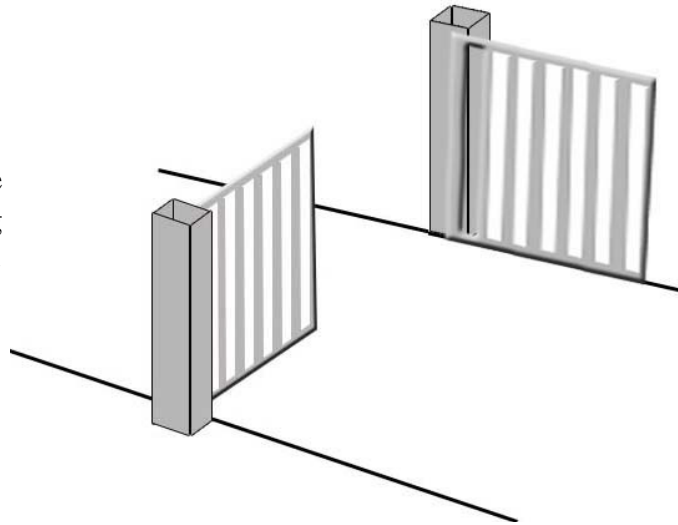

7) Press P2 to teach leaf 1 closing deceleration starting point.

8) Let the leaf 1 make contact with the full closed stop point or full closing point of arm.

Press P1 to exit the learning mode.

You may now test your gate opener with your transmitter.

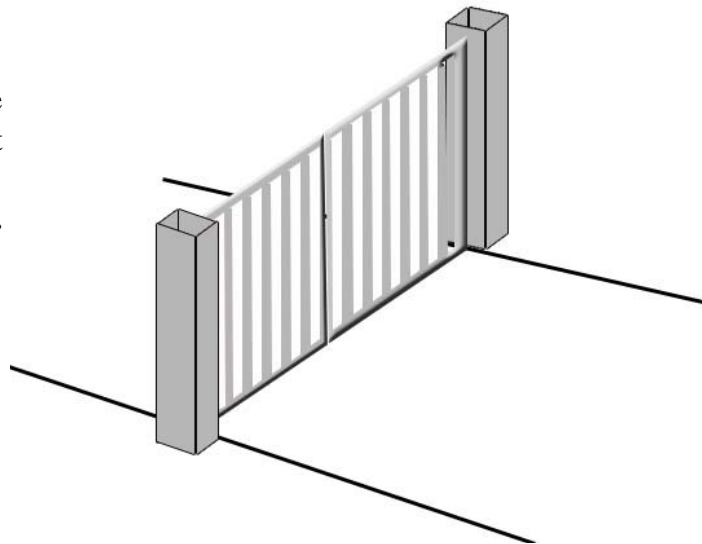

Simple Diagnostics

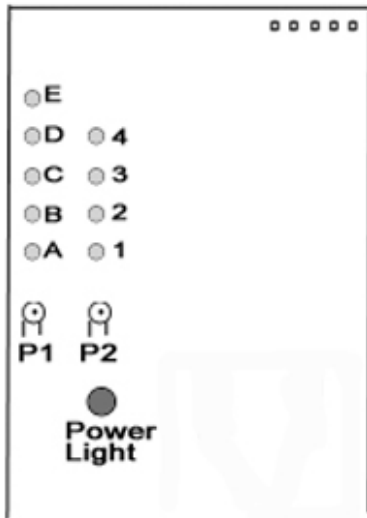

Diagnostics using the Power light on your Master Control Board.

The **P** light has a diagnostic function. There are 4 statuses.

1. Steady light indicating main power is ON and the battery is charged
2. Flashing slowly (lights every second) indicates no main power but the battery is charged.
3. Flashing quickly (lights every 1/4 of a second) indicates main power on but discharged battery
4. Light OFF indicates no main power and discharged battery.

Status of accessory inputs.

The Master Control Board has the ability to verify the status of the terminal board inputs. To access this function:

When all LEDs are off (both lettered and numbered) press **P2**. The statuses of the accessory terminals in the following chart will be shown in the lettered LEDs column.

LED ON = Closed Contact
LED OFF = Open Contact

When you have finished checking, press **P2** again to exit.

If you do not, the LED status check will stay active for 5 minutes and then the board returns to all LEDs OFF.

WARNING:
 When you access the input status

function all accessories are powered, even with the gate idle. **P1** is active and can be used to open and close the gate.

Normal Operation idle LED lights	LED	ON	OFF
A = OFF	A = Terminal 1, Open/close function	Opening/closing device is triggered.	Opening/Closing device is not triggered.
B = OFF	B = Terminal 2, Single leaf open/close	Opening/closing device is triggered.	Opening/Closing device is not triggered.
C = ON	C = Terminal 3, Stop Command	Motion stop device is in place and not triggered or jumper is in place..	Motion stop device has been triggered or is not connected.
D = ON	D = Terminal 4, Opening safety device	Motion stop device is in place and not triggered or jumper is in place..	Safety device has been triggered or is not connected.
E = ON	E = Terminal 5, Closing safety device	Motion stop device is in place and not triggered or jumper is in place..	Safety device has been triggered or is not connected.
1 = OFF if single ON if dual	1 = Terminal 6, Slave Board	Slave Board is connected.	Slave board is not connected.

Trouble Shooting

If your gate operator arm will not move.

- Be sure that all safety devices are connected. Safety device terminals work on normally closed connections so if terminals 3, 4, and 5 are not connected to negative terminals the gate opener will not function. Secondary safety devices **are always recommended by Gate Crafters and FAAC**, if you choose to only use the inherent obstruction sensing featured in the Estate Swing control board you must connect terminals 3, 4, 5 to a negative terminal (12, 13, 14, or 15).
- Be sure your arm is mounted correctly, **IF the setback is off there may be not enough leverage to move the gate.**
- Be sure the power LED is on steady. See page 27 for power LED interpretations. The battery supplied should be charged for 12 hours before beginning the learning process.
- Be sure that the polarity of the arm wiring is correct. For standard Pull-To-Open operation the **Blue** wire should be connected to the **left** and **Brown** wire connected to the **right**. **Reverse the polarity for Push-To-Open Operation.**
- Check the fuse to be sure the fuse is not blown. It can be tested visually or with a volt meter by checking for continuity between the two prongs of the fuse.
- Check the force setting, D variable. 4 is the highest. Try moving the force to high.
- Check the speed setting, E variable. If the gate is heavy and tries to move too quickly, sometimes the jerk of the gate at the beginning may set off the obstruction sensing. Move the speed setting down to 1.
- Try removing the opener arm from the gate mounting bracket. Run the cycle with the arm off the gate. If the opener moves, check your gate for levelness, greased hinges, and weight/length ratios. *Note: moving your gate from the end by hand may seem very easy. A true test would be moving the gate from the gate mounting bracket just as the operator would.*

If case won't close or the programming lights will not turn on.

- Be sure that the control board and the control board cover is fully lined up and snapped into place. During shipping some shifting may occur resulting in a board and cover that are not lined up., thus the activation buttons (P1, P2) will not line up.

If the power LED (P) is flashing slowly.

- This means your main power is not on, the battery is low and absorbing too much of the main power, or the main power was plugged in for less than 5 minutes. Be sure before installation the battery is charged for 12 hours. **A charged battery should read over 13V at idle without power connected. If your battery is reading under 13V it needs to continue to charge.**

Note: When a charging power source is removed from a battery the voltage reading will drop immediately after and then level out. Please wait for the voltage to level out to get an accurate reading of the battery's charge.

If the power LED (P) is flashing rapidly.

- The battery is discharged and does not have enough power to move your gate.
Note: Many times the power light will only flash rapidly for a few seconds during the cycle, at which time the gate will stop in motion. It may immediately go back to solid. The battery is still too low, but is closer to being ready to use. This means that the increased amperage pull from moving a gate is too much for the battery in it's current level of charge.

If the gate stops mid cycle.

- Check the force setting, D variable. 4 is the highest. Try moving the force to high.
- Check the speed setting, E variable. If the gate is heavy and moves too quickly, sometimes the jerk of the gate during certain parts of the cycle may set off the obstruction sensing. Move the speed setting down to 1.
- Try removing the opener arm from the gate mounting bracket. Run the cycle with the arm off the gate. If the opener no longer stops during cycle, check your gate for levelness, greased hinges, and weight/length ratios. *Note: moving your gate from the end by hand may seem very easy. A true test would be moving the gate from the gate mounting bracket just as the operator would.*
- Check the power lights, the flashing may only last a short time when the gate stops. If the light flashes let your operator charge.

If the gate stops after only a few inches of movement.

- **NOTE: The open and closed position is the most difficult for the opener because it is working without momentum and at the least leverage point.**
- Check the force setting, D variable. 4 is the highest. Try moving the force to high.
- Check the speed setting, E variable. If the gate is heavy and moves too quickly, sometimes the jerk of the gate during the beginning of the cycle may set off the obstruction sensing. Move the speed setting down to 1.

Estate Swing

- Try removing the opener arm from the gate mounting bracket. Run the cycle with the arm off the gate. If the opener no longer stops during cycle, check your gate for levelness, greased hinges, and weight/length ratios. *Note: moving your gate from the end by hand may seem very easy. A true test would be moving the gate from the gate mounting bracket just as the operator would.*
- Check the power lights, the flashing may only last a short time when the gate stops. If the light flashes let your operator charge.

Only the master opens.

- Check the power light on the slave side be sure the power light is on steady. *Note: The slave does not charge until the master light is steady, if you were recently charging the master and slave the master might have only gotten a chance to charge.*
- Check the diagnostic mode (Section 17). For dual openers CDE and 1 should be on. The rest off. If 1 is off then the slave is not communicating with the master, check your connection to the slave and the polarity of the connection (Section 9).
- If using an accessory to open the gate, see which terminals it is wired to. **Terminal 2 ONLY opens the master leaf, move your accessory to terminal 1.**
- Check the same information as the first trouble shooting topic “**If your gate operator arm will not move.**”

Only the slave will open.

- Check the same information as the first trouble shooting topic “**If your gate operator arm will not move.**”

If your gate is losing memory of slow down points.

- First reset your gate opener by unplug battery and transformer power for 10 minutes. Plug the power sources back in and wait for the power light to go steady. Re-program the gate in Complete Stop/Start Learning Process (Section 20).
- Check the setback. **This is very important for the memory process.**

For any technical assistance Estate Swing can be reached 9 AM to 5 PM, Monday - Friday. 1-800-640-GATE

Logic Summaries and Flow Charts

Logic A - Logic A (automatic) is the most common setting. It automatically closes the gate depending on the set pause time. This logic must be used in conjunction with the accessories: Free Exit Sensor and Gate Timer.

Gate Status	Result of Terminal 1 activation	Result of Terminal 2 activation	Result of Terminal 4 interruption	Result of Terminal 5 interruption	Result of Terminal 4&5 interrupted simultaneous
Closed	Opens leaf and re-closes after pause time		No effect		
Open and in pause before re-closing	Re-loads pause time		No effect	Re-loads pause time	
Closing	Re-opens leaf		No effect	Stops motion and reverses direction after interruption	
Opening	No effect		Reverses direction of motion	No effect	Reverses direction of motion
Stopped in mid cycle	Closes the leaf		No effect		

Logic S - Logic S (safety) is designed for higher control and accelerated levels of safety. By triggering an opening device (i.e. push button, transmitter) the gate reverses directions preventing foreseeable accidents.

Gate Status	Result of Terminal 1 activation	Result of Terminal 2 activation	Result of Terminal 4 interruption	Result of Terminal 5 interruption	Result of Terminal 4&5 interrupted simultaneous
Closed	Opens leaf and re-closes after pause time		No effect		
Open and in pause before re-closing	Re-closes the leaf		No effect	Closes after 5 seconds	
Closing	Re-opens the leaf		No effect	Reverses direction of motion	
Opening	Re-closes the leaf		Reverses direction of motion	No effect	Reverses direction of motion
Stopped in mid cycle	Closes the leaf		No effect		

Logic Summaries and Flow Charts (cont)

Logic AP - Logic AP (stepped automatic) is very similar to automatic (A) but has a higher amount of safety. It has an increased amount of motion stop points.

Gate Status	Result of Terminal 1 activation	Result of Terminal 2 activation	Result of Terminal 4 interruption	Result of Terminal 5 interruption	Result of Terminal 4&5 interrupted simultaneous
Closed	Opens leaf and re-closes after pause time		No effect		
Open and in pause before re-closing	Stops operation		No effect	Re-loads pause time	
Closing	Re-opens leaf		No effect	Reverses direction of motion	
Opening	Stops operation		Stops motion and reverses direction after interruption	No effect	Reverses direction of motion
Stopped in mid cycle	Closes the leaf		No effect		

Logic EP - Logic EP (stepped semi-automatic) is designed to function similar to a garage door opener. At full open the gate does not re-close after a pause time, it stays open until triggered to re-close. Logic EP over-rides any set pause time.

Gate Status	Result of Terminal 1 activation	Result of Terminal 2 activation	Result of Terminal 4 interruption	Result of Terminal 5 interruption	Result of Terminal 4&5 interrupted simultaneous
Closed	Opens leaf		No effect		
Open and in pause before re-closing	Re-closes the leaf		No effect		
Closing	Stops operation		No effect	Reverses direction of motion	
Opening	Stops operation		Reverses direction of motion	No effect	Reverses direction of motion
Stopped in mid cycle	Restarts motion in opposite direction the gate was previously moving before stopped in mid cycle		No effect		

Accessory Terminals

Normally Closed connections must be made for proper gate opener function. The full accessory board is only found on the master control board.

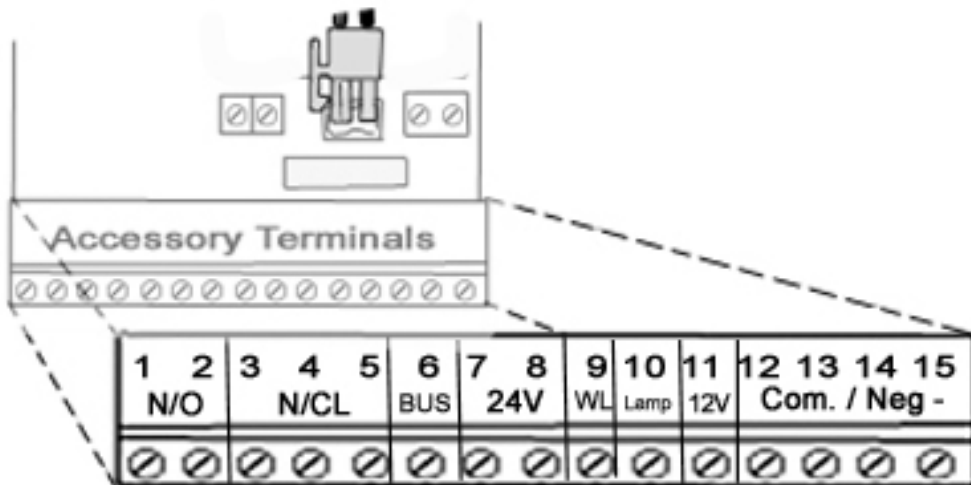

J1—Terminal Board for Master Card

Terminals

- 1 - “Open/Close Function” This is a normally open terminal where by any device (i.e. push button, keypad, receiver) which, by closing a contact, provides an opening and/or closing pulse for **both** gate leaves (if there is only one leaf, it will control the one leaf).
- 2 - “Single Leaf Open/Close Function” This is a normally open terminal where by any device (i.e. push button, keypad, receiver) which, by closing a contact, provides an opening and/or closing pulse for **only the gate leaf controlled by the master control board**.
- 3 - “Stop Command” This is a normally closed terminal where by any device (i.e. push button) which, by opening a contact, halts gate movement. **IMPORTANT:** *If a connection is not made from this terminal to one of the - (negative) terminals (i.e. 12, 13, 14, 15) gate motion will not commence.*
- 4 - “Opening Safety Device” This is a normally closed terminal where by any device (i.e. photocells, sensitive edge, magnetic loops) which, if there is an obstacle in the area they protect during opening, reverses gate direction to closing.
If the opening safety devices are tripped when the gate is closed, they prevent the leaf movement.
IMPORTANT: *If a connection is not made from this terminal to one of the - (negative) terminals (i.e. 12, 13, 14, 15) gate opening will not commence.*

J1—Terminal Board for Master Card (cont.)

Terminals (cont.)

5 - “Closing Safety Device” This is a normally closed terminal where by any device (i.e. photocells, sensitive edge, magnetic loops) which, if there is an obstacle in the area they protect during closing, reverses gate direction to opening. If the closing safety devices are tripped when the gate is open, they prevent the leaf movement.

IMPORTANT: *If a connection is not made from this terminal to one of the - (negative) terminals (i.e. 12, 13, 14, 15) gate closing will not commence..*

6 - “Slave Control Board Connection” This is a connection between the master and slave control board. It enables communication between the two equipment and supplies power to charge the battery on the slave side. **Use this in conjunction with terminal 15 - (negative). Terminal 6 must connect with the right side of J2 on the slave board, Terminal 15 must connect with the left side of J2 on the slave board.**



Caution! Do not reverse polarity of the wires connecting the master and slave board! This will cause permanent damage to both boards and will void the warranty. **Caution!**

7, 8 - “Positive (7) & (8) 24 Voltage” Positive 24V for powering accessories that are run by 24V DC power (i.e. locks, safety devices) while the gate is in motion.

9 - “Indicator Light” When used with terminal **11**, this terminal grounds the indicator light. **To avoid compromising correct operation of the system, do not exceed the indicated power (12V .5Wmax).** The indicator light is lit during open, opening and blocked. The indicator is flashing during closing.

10 - “Lamp” When used with terminal **11**, this terminal grounds the flashing lamp output. **To avoid compromising correct operation of the system, do not exceed the indicated power (12V 21Wmax).** When the gate is in motion, the lamp will flash.

11 - “Positive 12 Voltage” This is a 12V terminal used to power the indicator light, lamp (must be connected to the appropriate ground) and constantly powered accessory devices (when connected to a ground 12,13,14,15) controlled by 12V DC. **(12V 21Wmax)**

12, 13, 14 ,15 - “Negatives” Interchangeable negative terminals for use with powered accessories, safety devices and opening devices.

Photocell & Safety Device Guide

Before connecting the photocells (or other devices) we advise you to select the type of operation according to the movement zone to be protected.

Opening Safety Devices: They operate only during the gate opening movement and, therefore, they are suitable for protecting the zone between the opening leaves and fixed obstacles (walls, etc.) against the risk of impact and crushing.

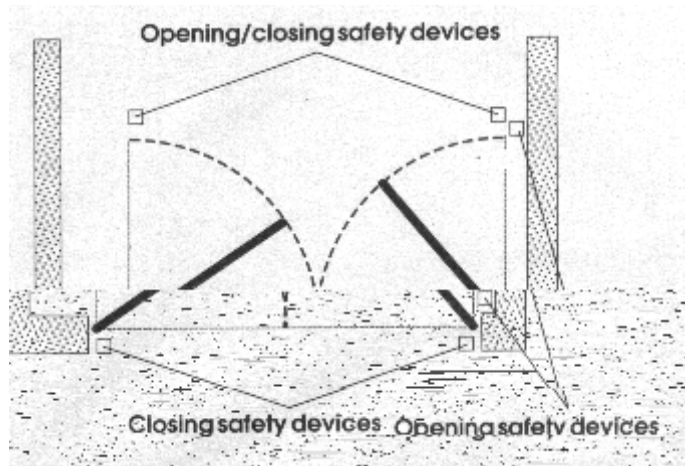

Closing Safety Devices: They operate only during the gate closing movement and, therefore, are suitable for protecting the closing zone against the risk of impact.

Opening/Closing Safety Devices: they operate during the gate opening and closing movements and, therefore, they are suitable for protecting the opening and closing zones against the risk of impact.

If one or more devices have the same function (opening or closing) they must be connected to each other in series. Normally Closed contacts on the accessories panel must be used.

Examples of common wiring layouts

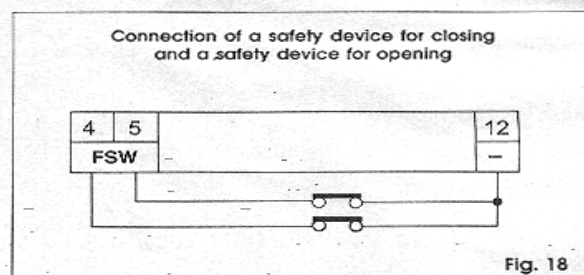
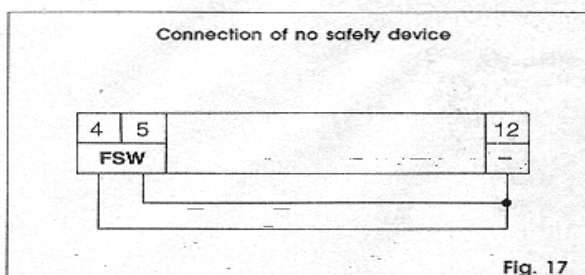

Connection of a pair of photocells, one for opening and the other for closing.

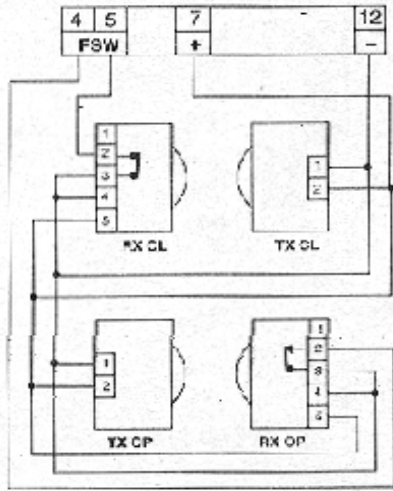

Fig. 19

Connection of a pair of photocells, one for closing and one for opening/closing.

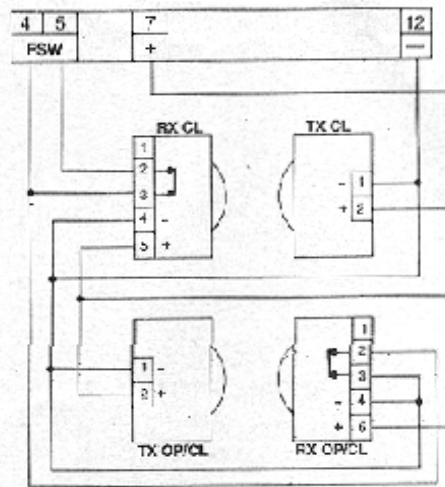

Fig. 20

Connection of 1 pair of photocells for closing.

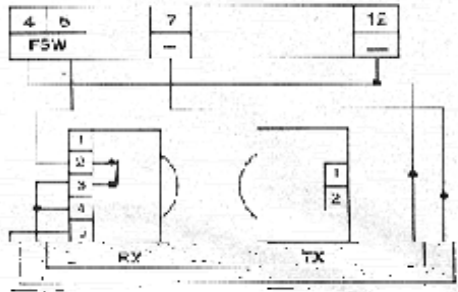

Fig. 21

Connection of 1 pair of photocells for opening.

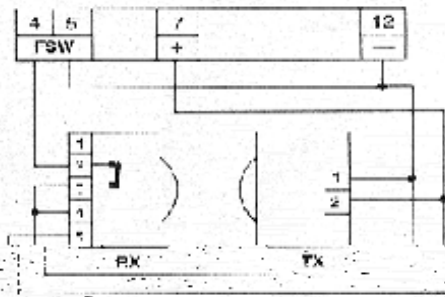

Fig. 22

Connection of 2 pairs of photocells for closing.

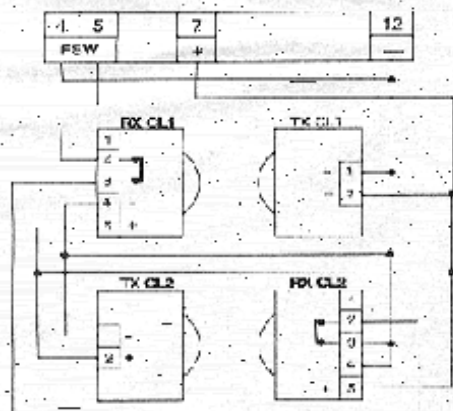

Fig. 23

Connection of a pair of closing photocells, one for opening and the other for opening/closing.

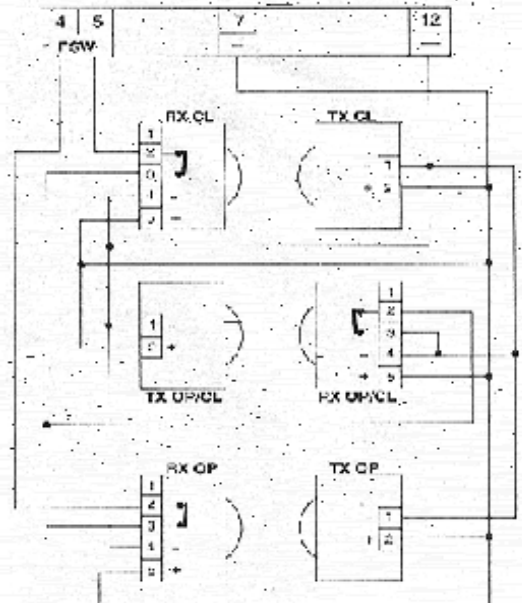

Fig. 25

Connection of 2 N.C. contacts in series (E.g. Photocells, Stop)



Fig. 24

Installing Accessories

Accessory manuals for most make and model accessories can be found on the web at:

www.EstateSwing.com/accessories

The accessory manuals you have or find at the above address may be written to coincide with that manufacturer's model of gate opener. To determine correct terminals on your Estate Swing operator, use the accessory terminal section of your Estate Swing manual. The following are some common terms and abbreviations found in manuals:

Normally Open – abbr. N/O – Indicates a circuit that is left open during normal operation of the gate operator. When a device closes this circuit it signals the operator to perform a function. This circuit is the main circuit for entry devices. (i.e. keypads, exit wands, push buttons, etc.)

Normally Closed – abbr. N/C – Indicates that in order for the gate opener to be active this circuit must be closed. When a device opens this circuit it stops the motion of the gate operator. This circuit is the main circuit for safety devices. (i.e. photo eyes, safety loops, etc.)

Common – abbr. COM – This is the matching terminal for both Normally Open and Normally Closed circuits to be connected to. Accessory wiring that begins in a N/O or N/C terminal must have a wire that ends in a Common terminal.

Ground – abbr. GND or GRD – Ground is sometimes also known as negative. Common terminals are the same as Ground terminals. Ground can also be the negative spade of the battery if it is being used in association with positive voltage.

If a device has both a N/O and a N/C wire, both are never used at the same time. Some devices can be used as either an opening device or a safety device (i.e. gate crafters exit wand, NIR photo eye, etc.) If being used as an opening device use the N/O and if being used as a safety device use the N/C terminals.