



**MITSUBISHI MOTORS
GENUINE ACCESSORIES**



PART NUMBER	APPLICABLE MODEL
MZ380465EX	OUTLANDER

**INSTALLATION MANUAL
REAR PARKING ASSIST SENSORS**

Thank you for purchasing MITSUBISHI genuine * PARKING SENSOR SYSTEM *. This manual explains the procedure for installing * PARKING SENSOR SYSTEM *. Read this manual thoroughly before installation to ensure proper work.

BILL OF MATERIALS:

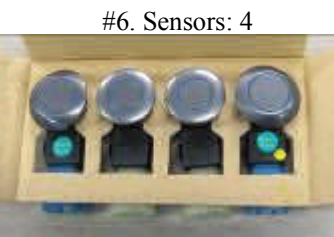

TOOLS



3mm
15mm



24mm
26mm

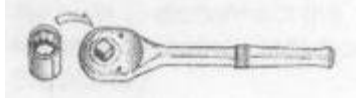
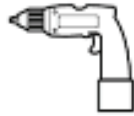

10mm



Before Installation

Please remove — wire from battery.

Parts installation

Use suitable tools

Pay attention not to biting wiring

pay attention to inside

Wiring

Do not leave wire loosening and shaking

Be sure to connect the joint together

Do not pull it with difficulty

Grasp joints firmly and take apart

Fix harness of a car with a bundle of straps

Dispose of harness to make sure that the car's can restore to its original condition.

Protect the connected location with tape

Carry out water-proof treatment

water-proof ok

crack

Nut OK

crack

crack

crack

When wiring from the direct line outgoing point, it is necessary to carry out water-proof treatment thoroughly

after finishing installation

Clip Tie

Please don't clip too tight.

Take care not to come into contact with the wiring

Cut off surplus parts

Bundle up wires and at the same time avoid the connecting wire to sound abnormally.

Be sure to restore parts to its original condition

crack

1

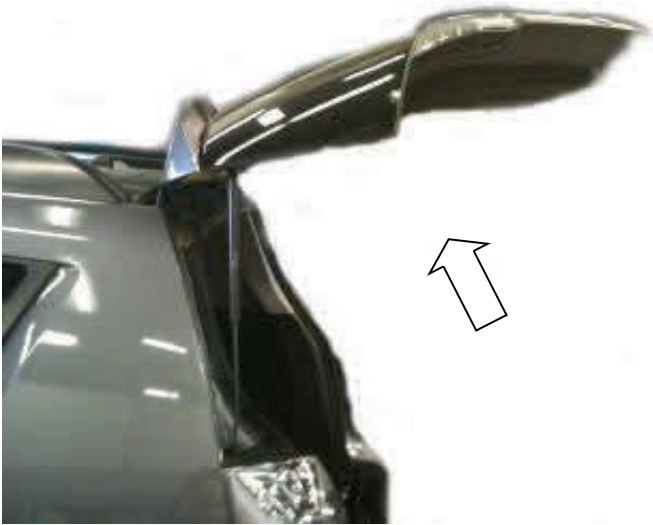

2

BEFORE INSTALLATION:
Disconnect NEGATIVE terminal



3



4

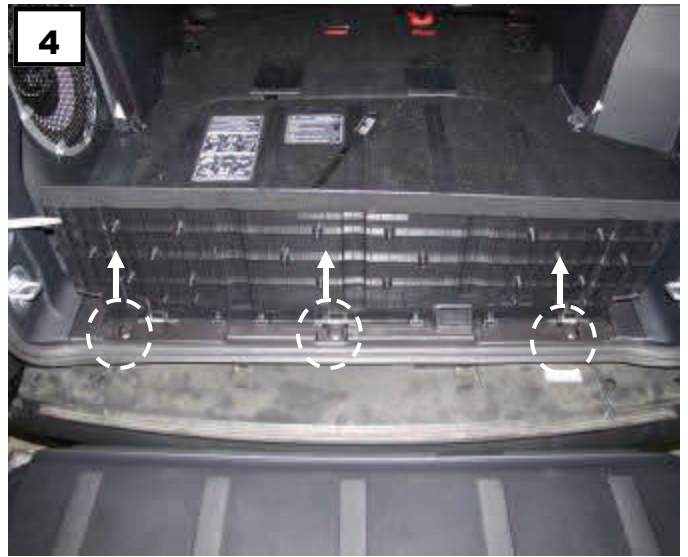

5



6



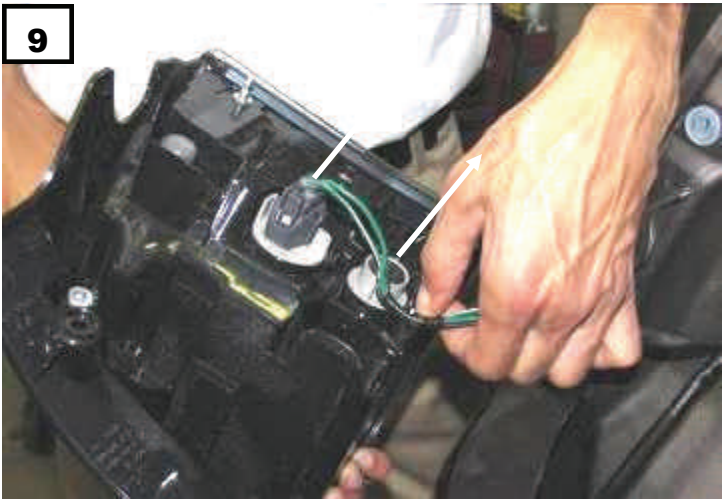
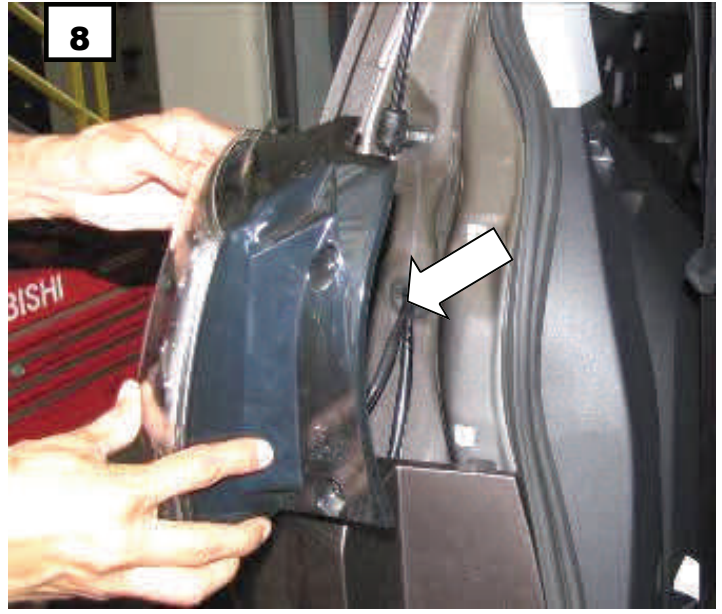

Repeat RH Side

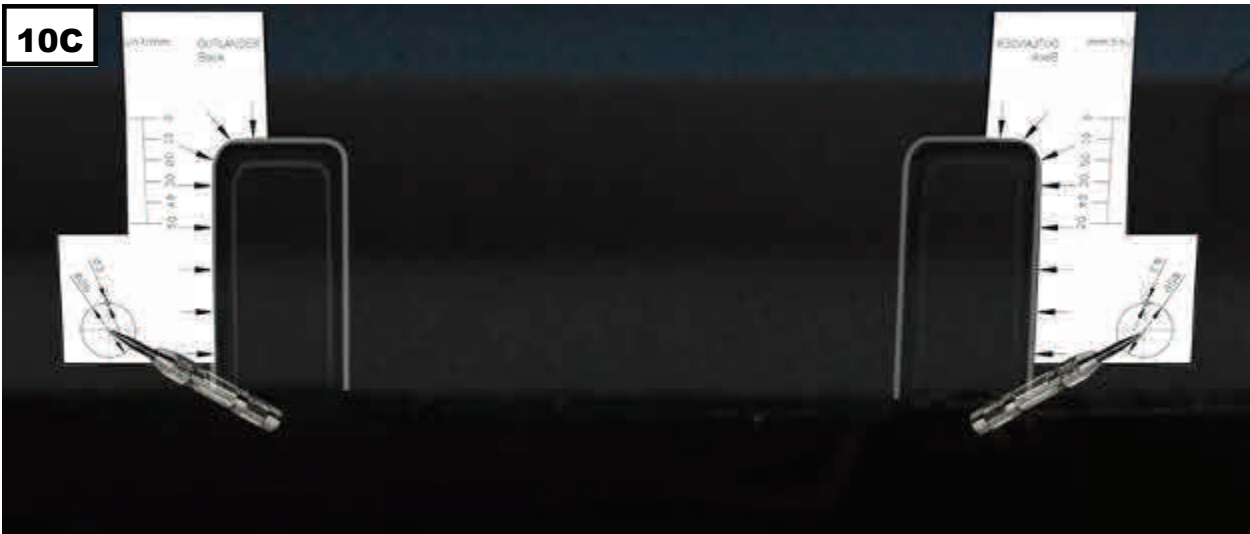
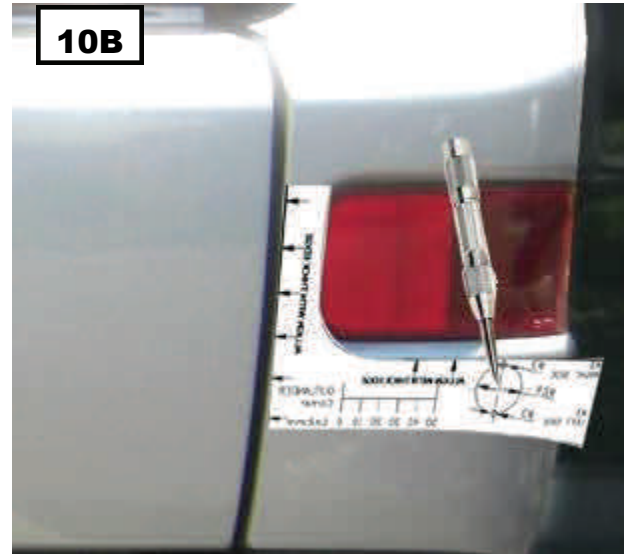
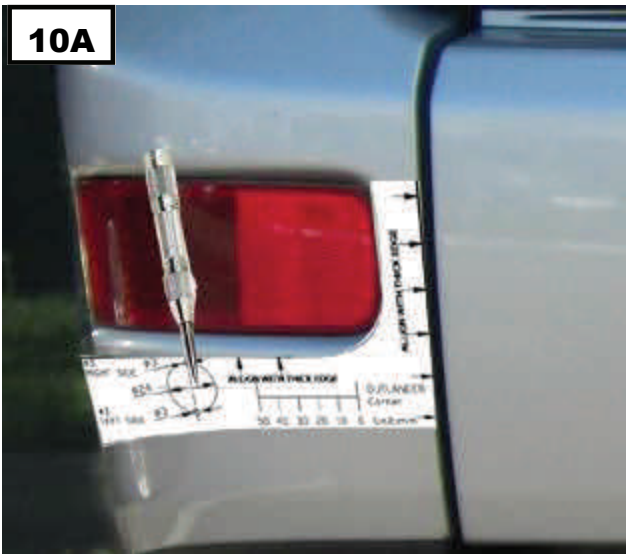
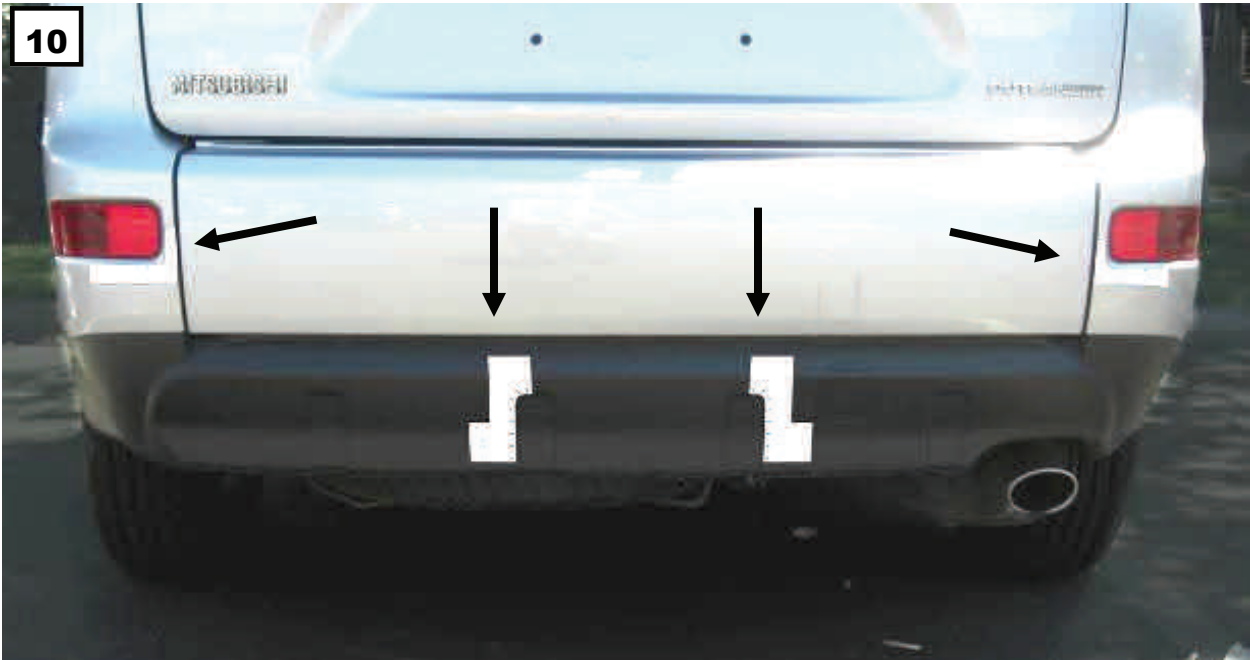

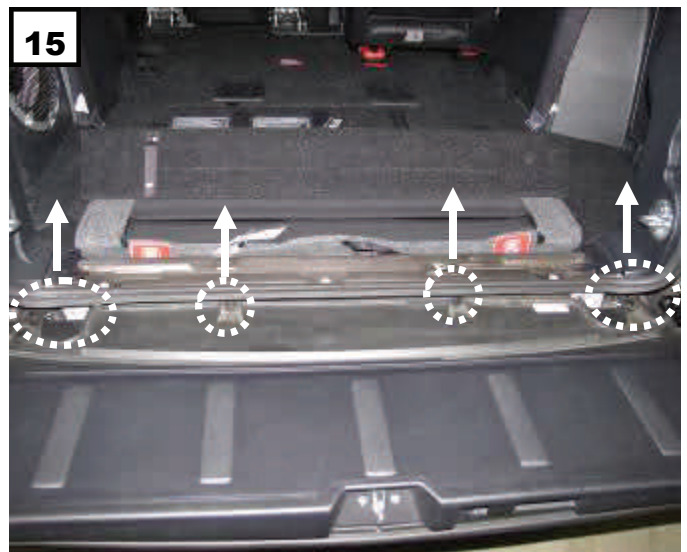
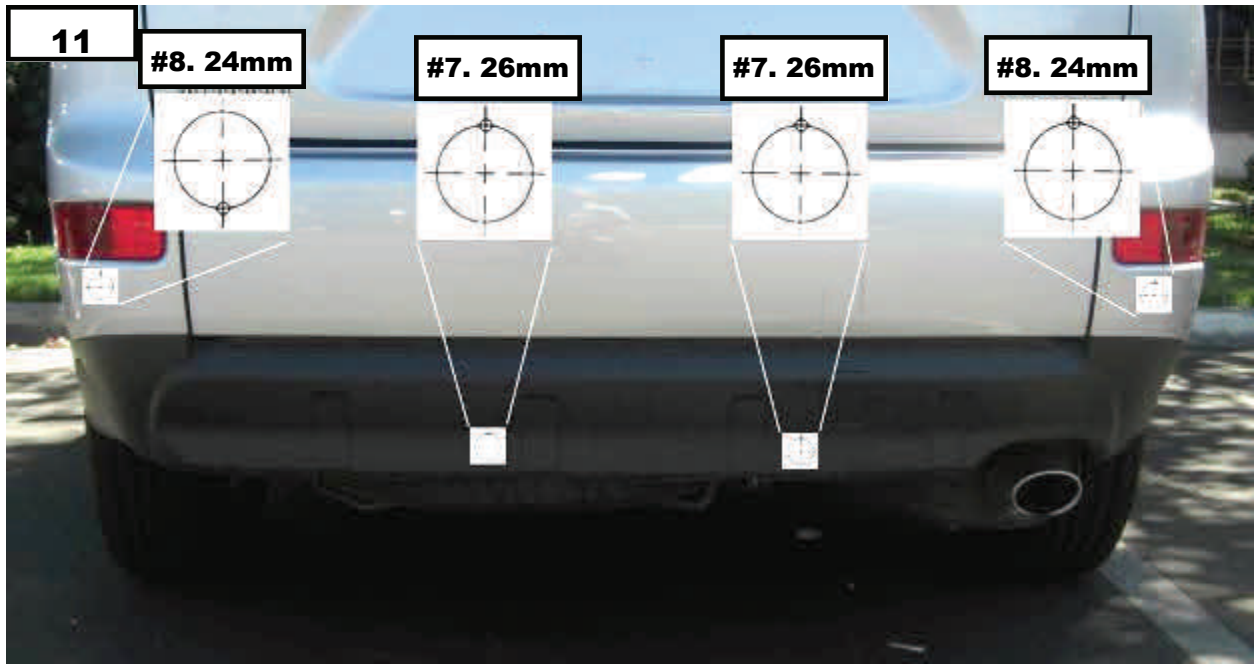

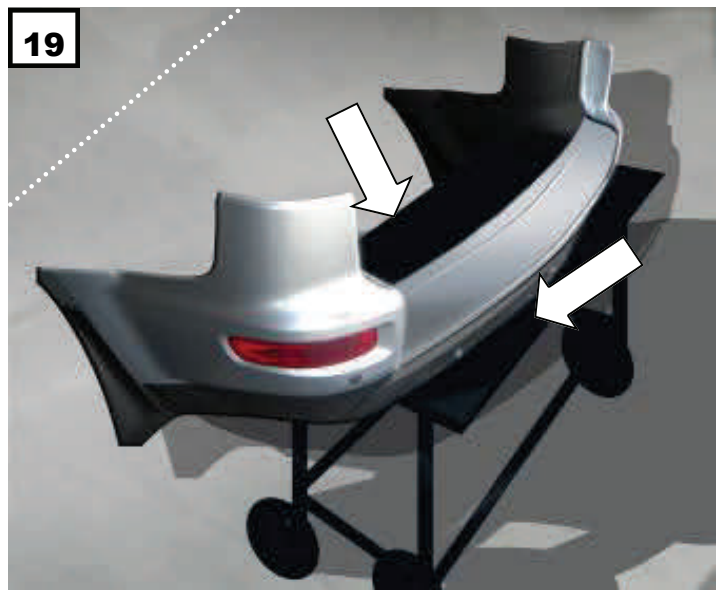
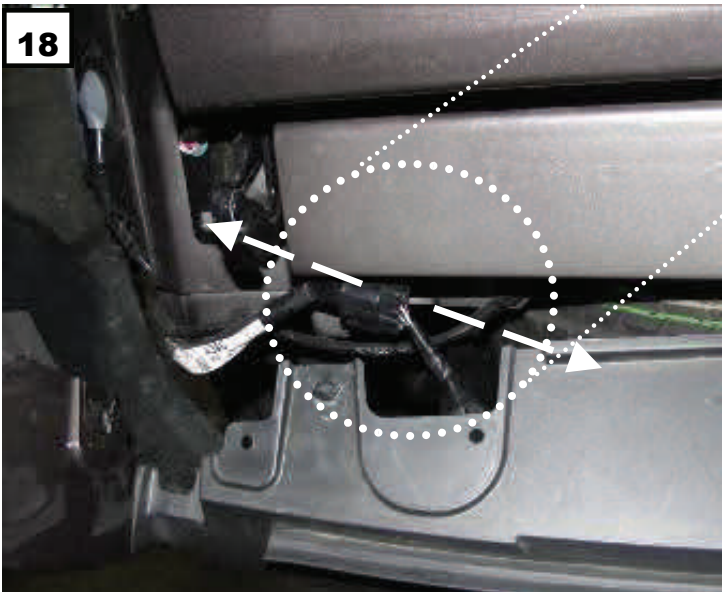
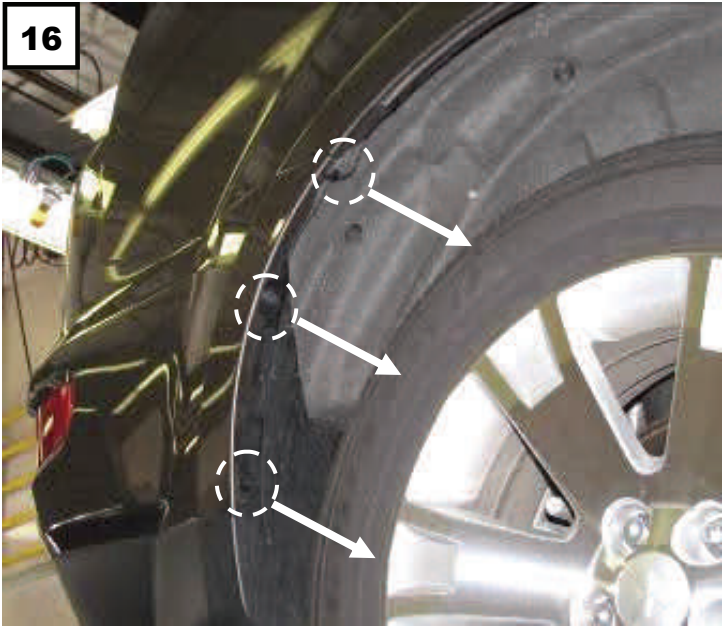

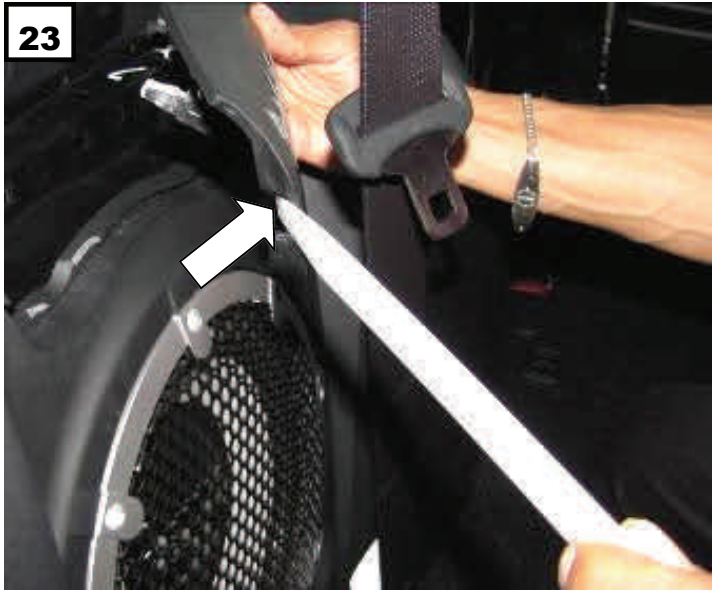

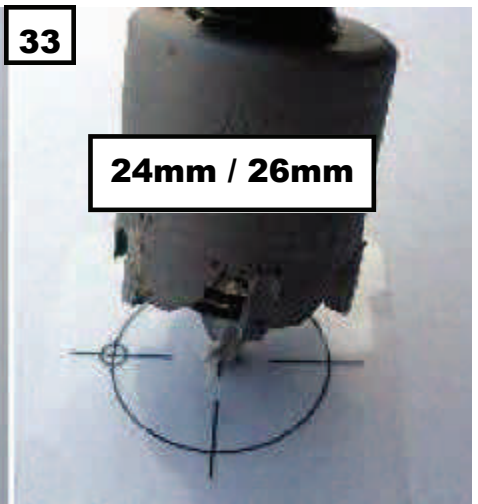
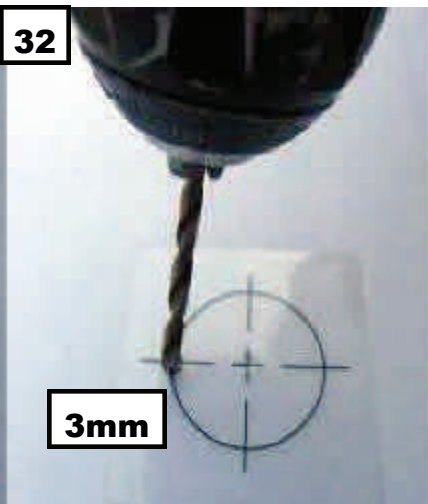
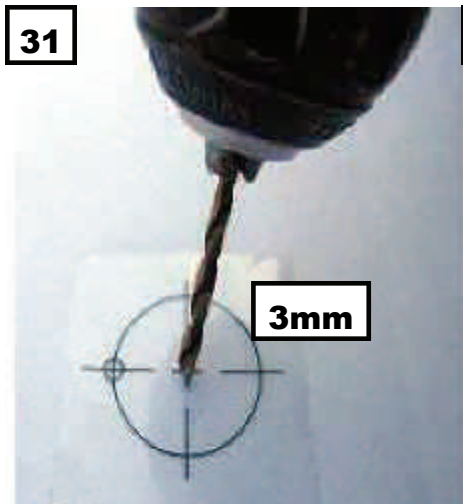
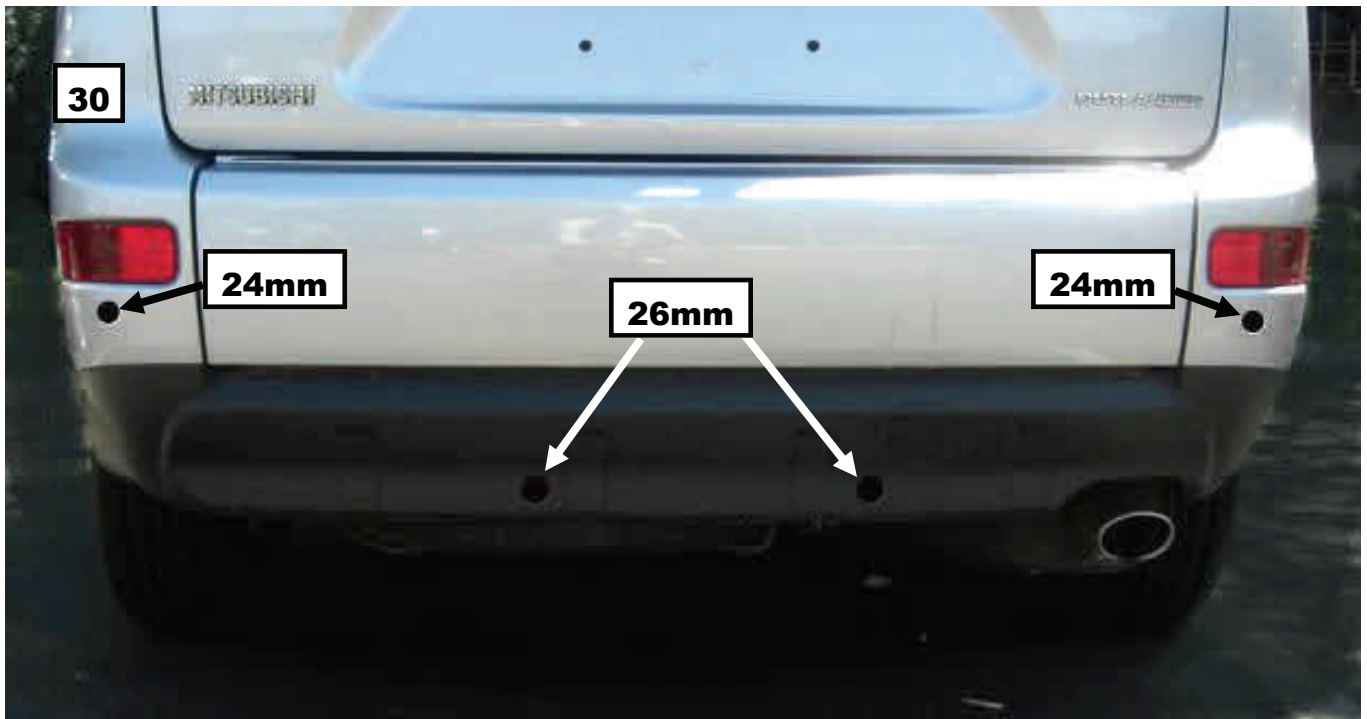
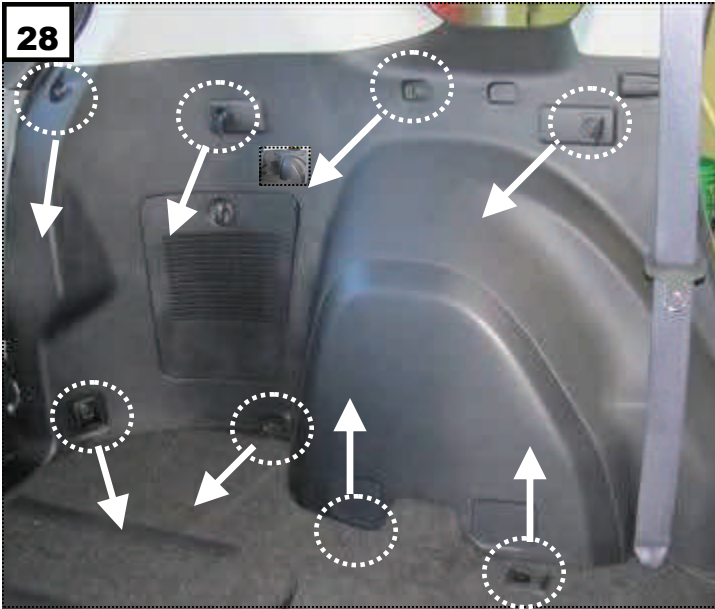

34

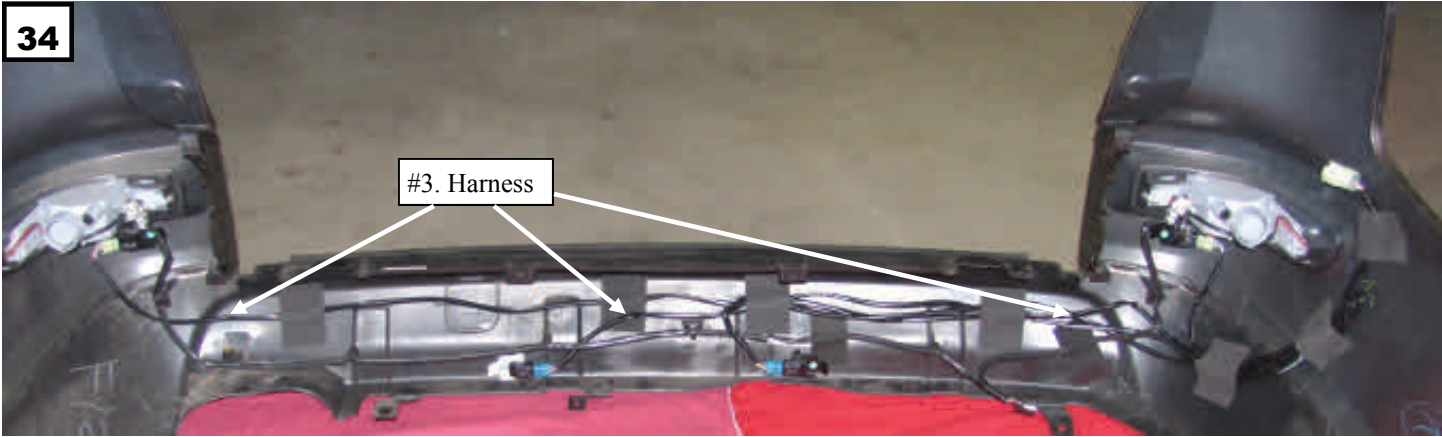

35

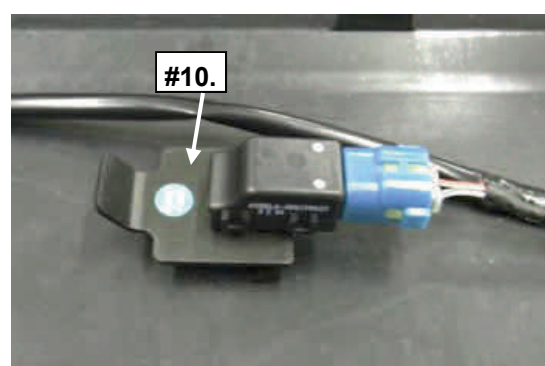
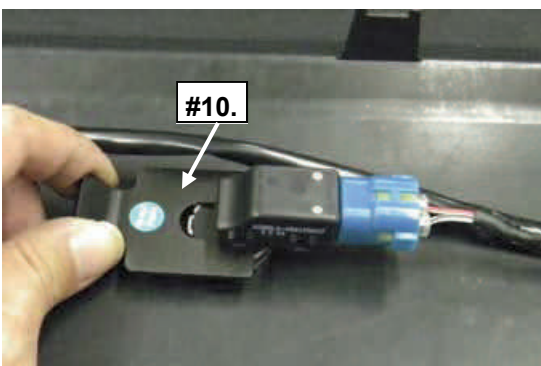
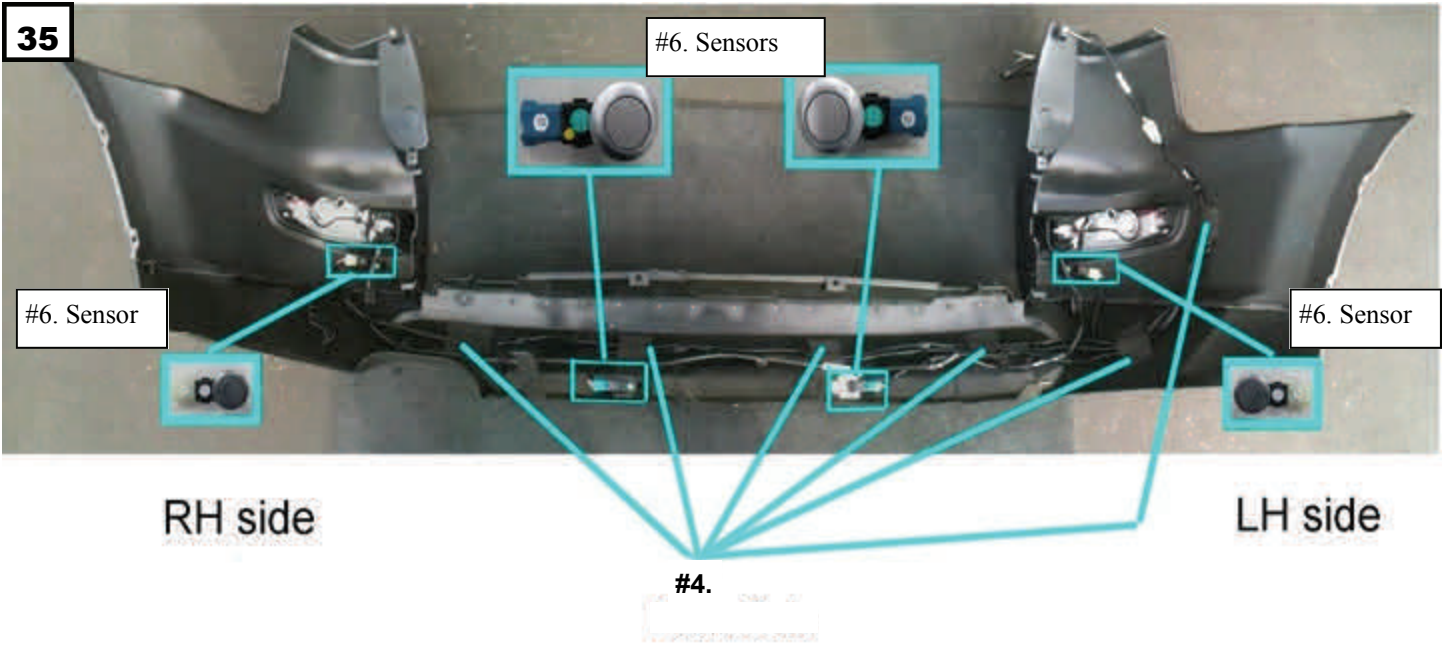

36

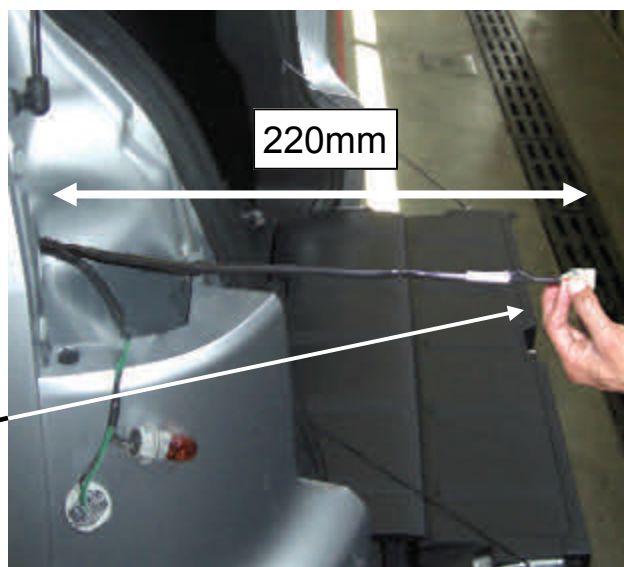
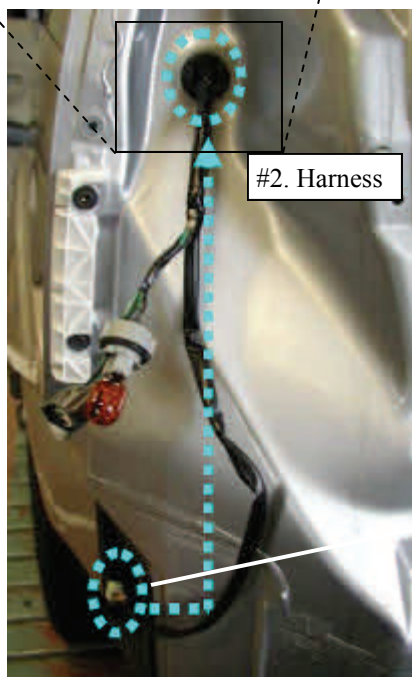

37

#1. Harness

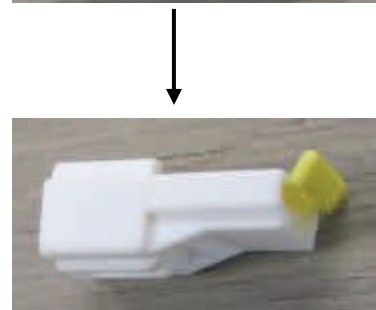
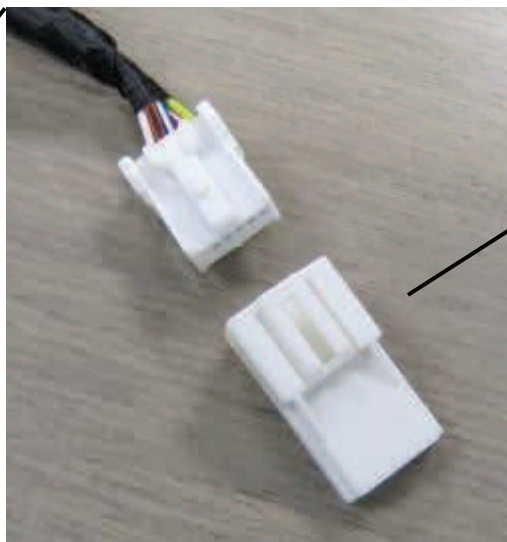
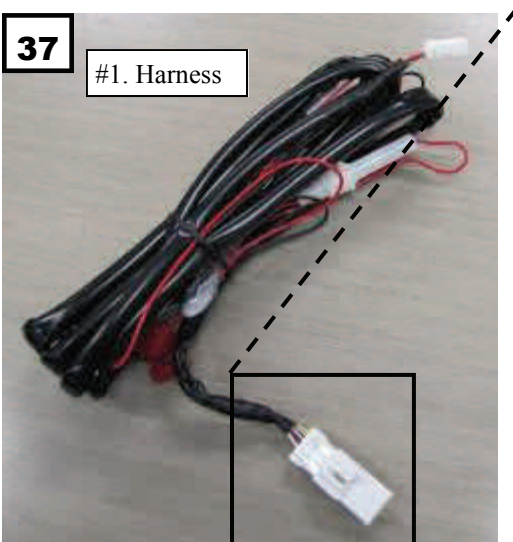

38

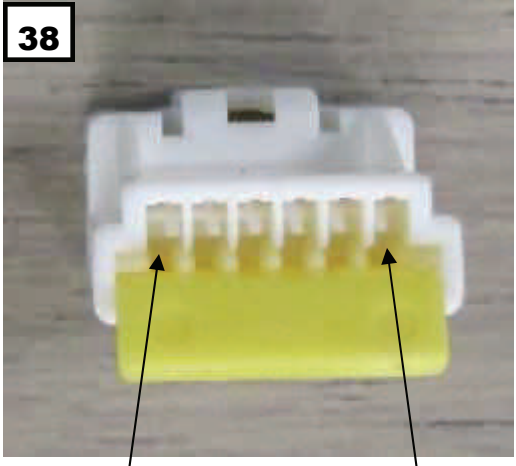

① ② ③ ④ ⑤ ⑥

LINE COLOR
1- None
2 -White/Black line
3 - Orange / Black Line
4 - Blue / White line
5 - Red / White line
6 - Yellow / Green Line

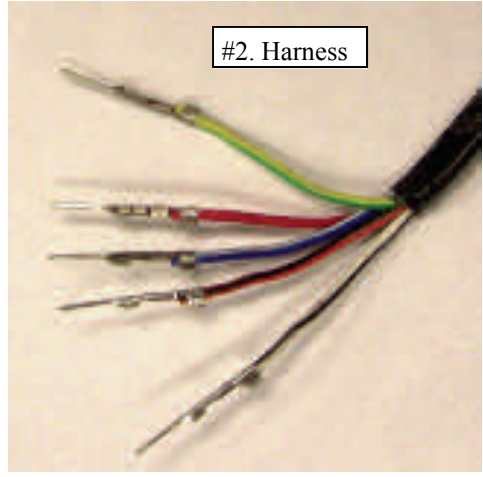

39

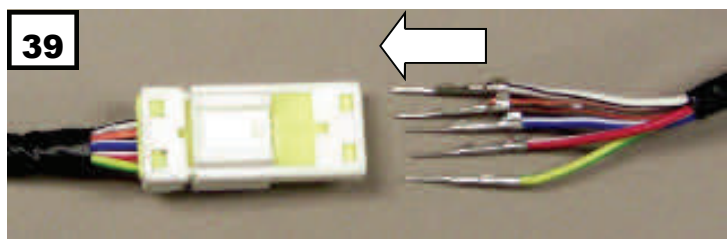

40

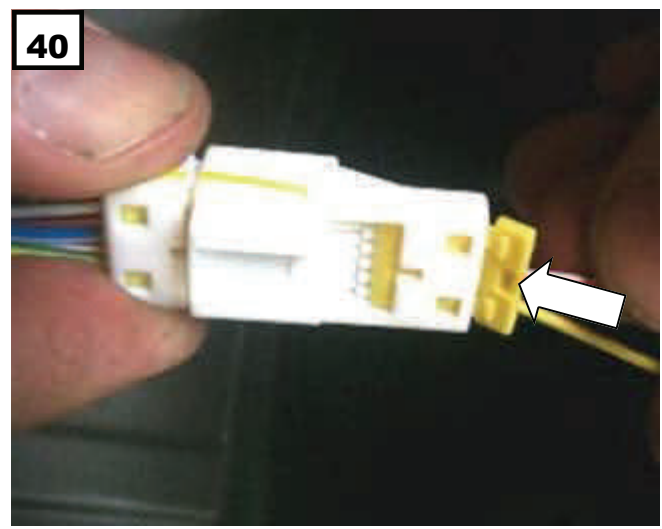

41

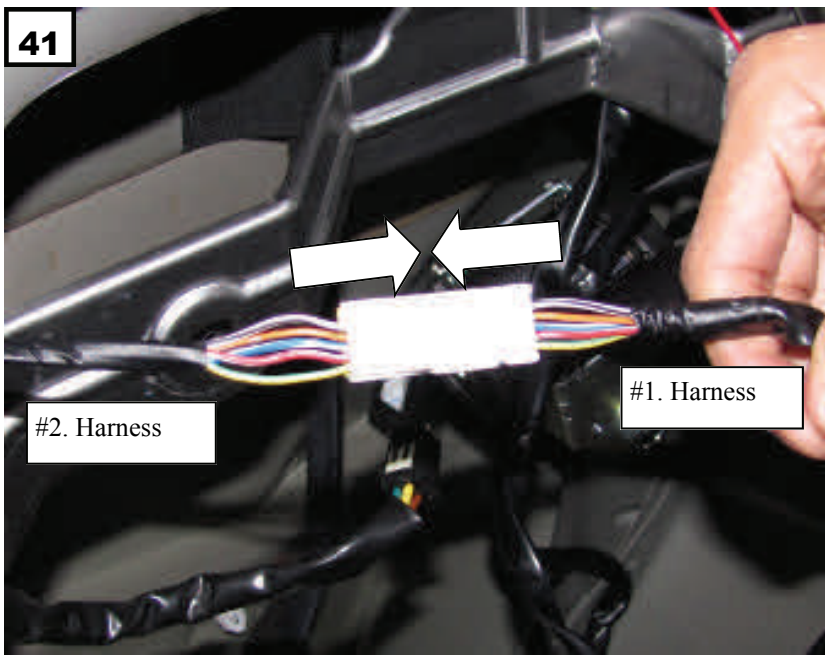

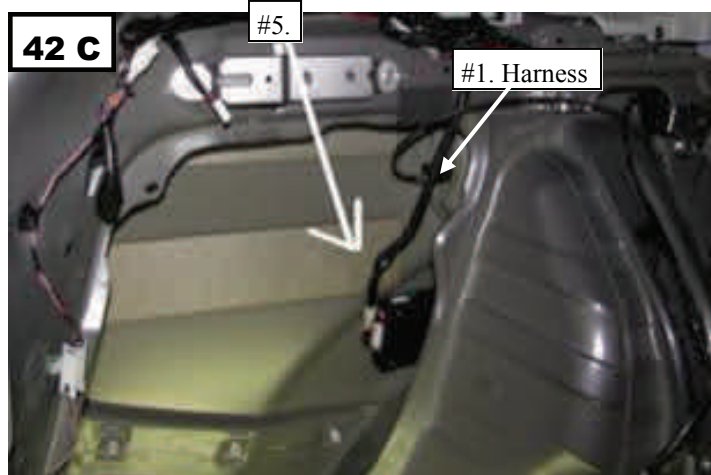
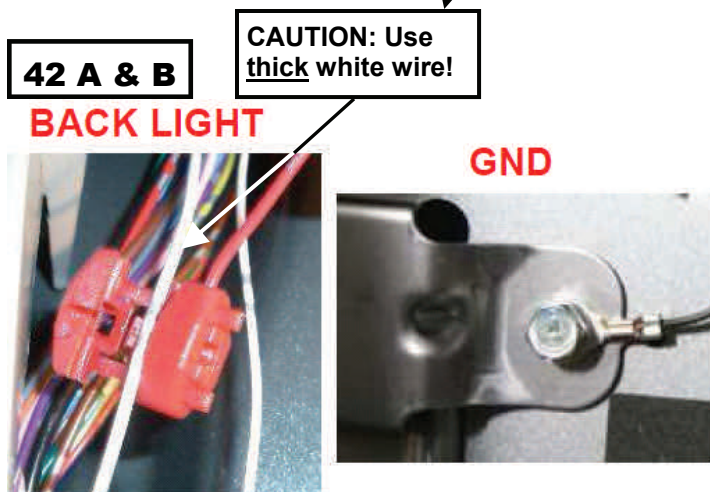
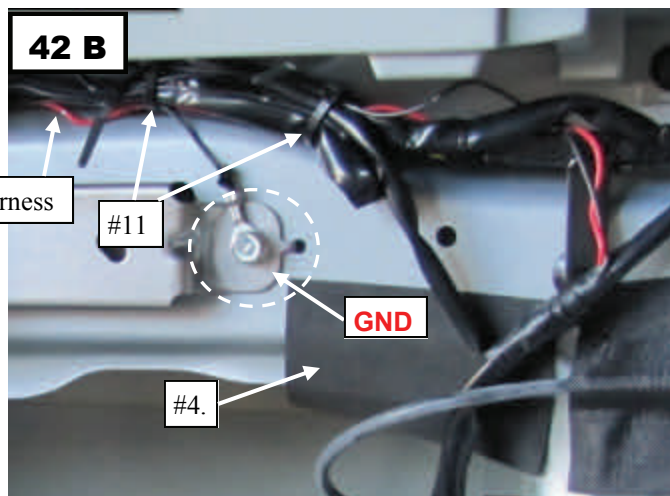
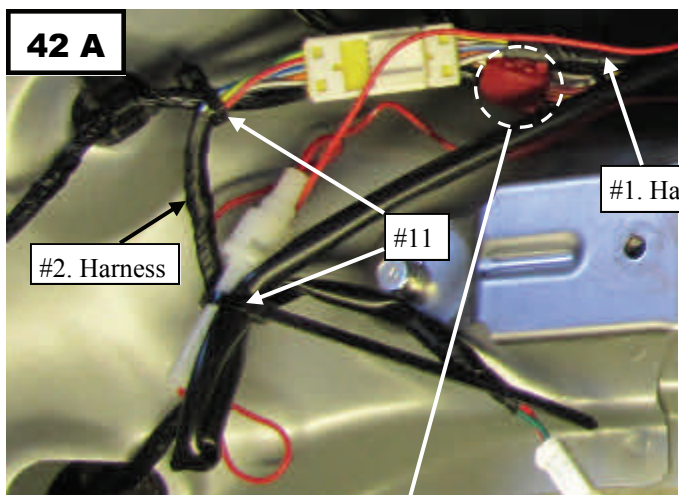
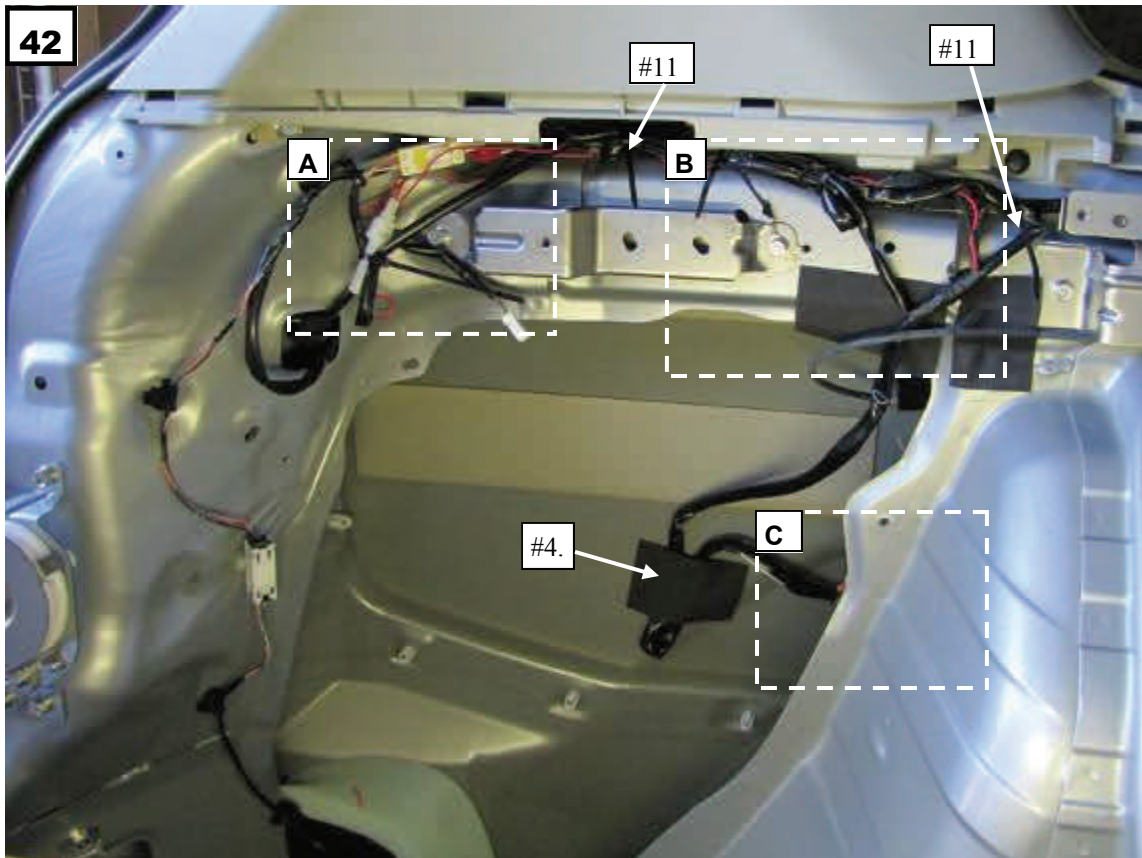

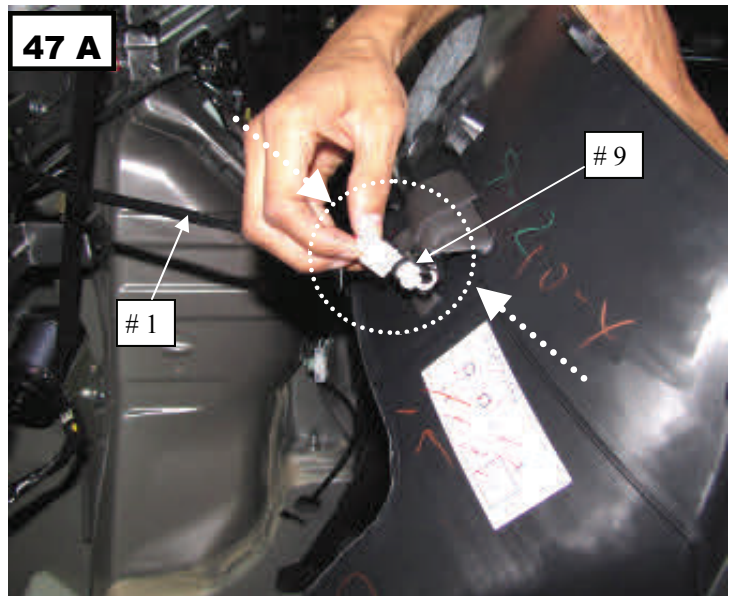
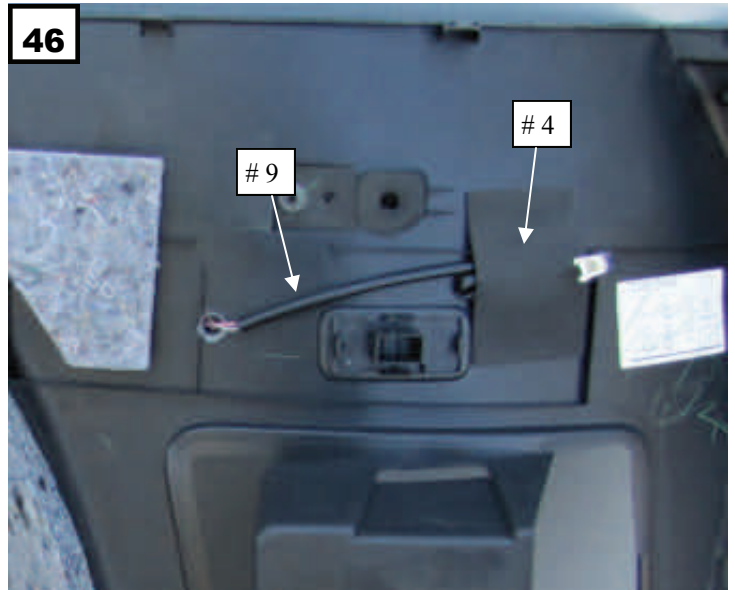
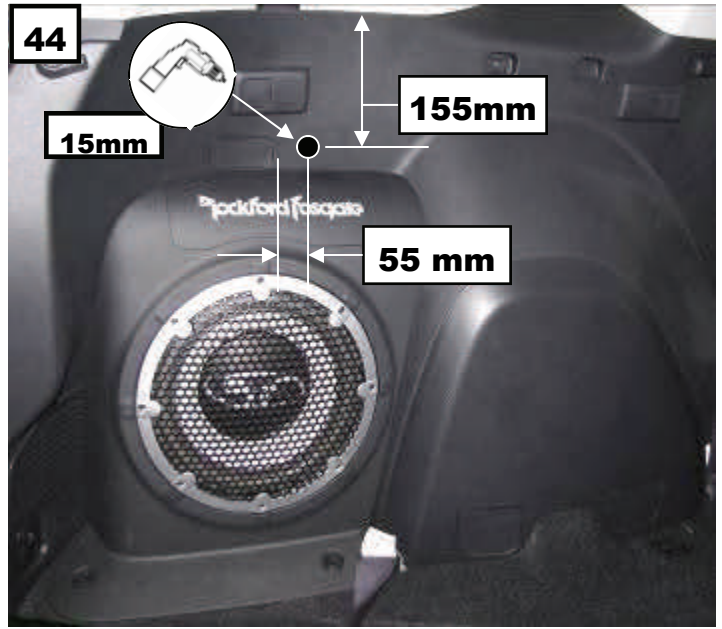
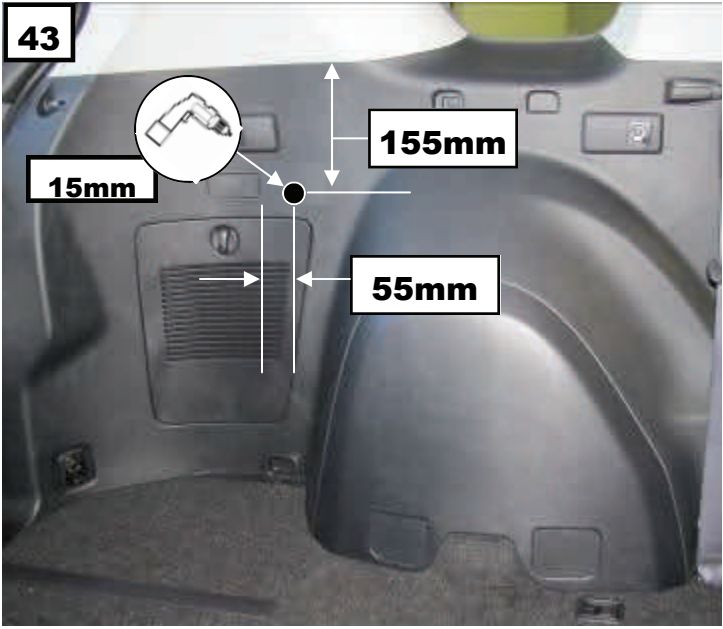

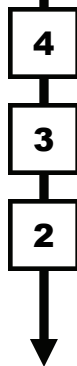
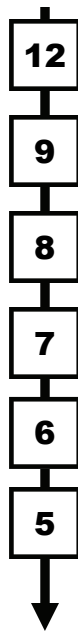
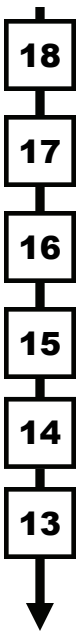
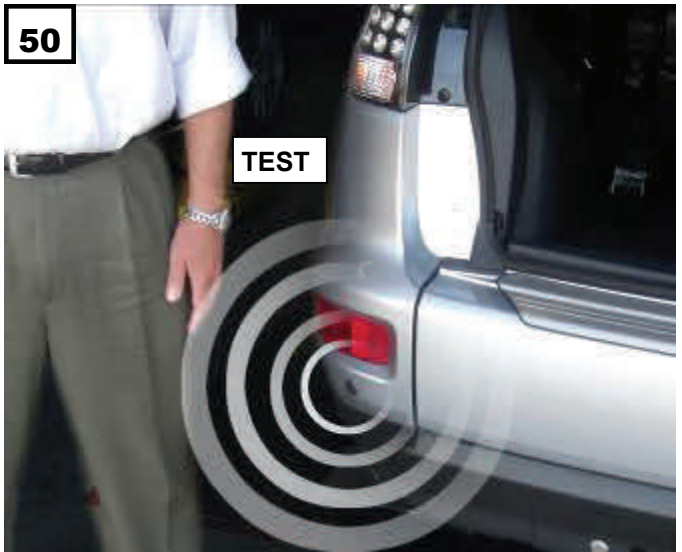
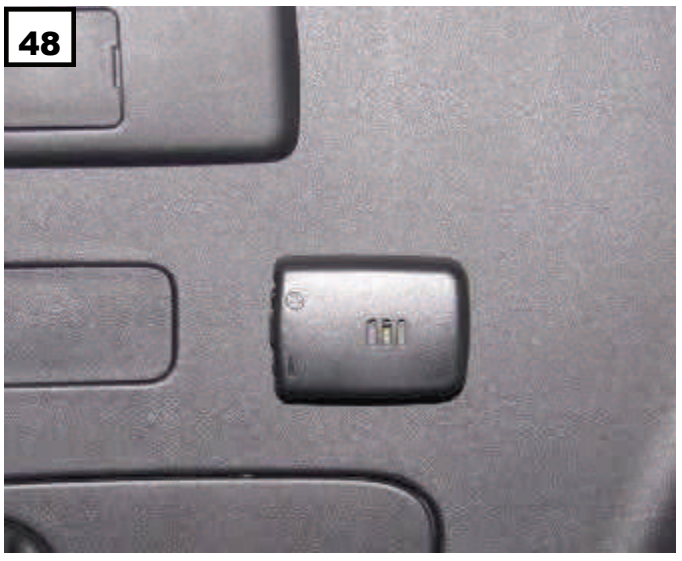
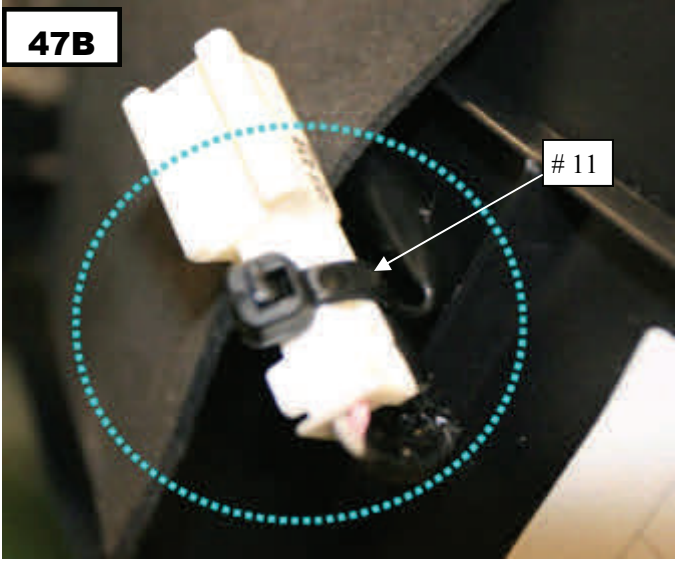

Function inspection- Troubleshooting

Symptom	Possible Cause	Confirmation Method	Solution
When the gear is shifted to "R", the alert does not beep.	The buzzer plug has not been inserted.	Confirm whether the buzzer plug is inserted.	Insert the buzzer plug correctly.
	Tail light power wire has not been spliced correctly.	Check if reverse lights are on or that the thick white wire has been spliced.	Splice the thick white wire.
	The fuse to the ECU may have blown.	Check whether the fuse has been blown.	Replace the fuse with a new one.
	ECU is damaged.	Confirm whether the ECU is damaged.	Replace ECU with a new one.
When the gear is shifted to "R", the alert beeps twice, not once.	One or more of the sensors is not connected properly.	Confirm whether the sensors are properly connected.	Connect the plug of each sensor properly.
	One of the sensors may be damaged.	Confirm whether each sensor functions properly.	Replace any damaged sensor with a new one.
When the gear is shifted to "R", the alert beeps three times.	Two of the sensors are not connected properly or may be damaged.	Confirm whether the sensors are properly connected and whether each sensor functions properly.	Connect the plug of each sensor properly and replace any damaged sensors with a new one.
When the gear is shifted to "R", the alert beeps four times.	Three or more of the sensors are not connected properly or may be damaged.	Confirm whether the sensors are properly connected and whether each sensor functions properly.	Connect the plug of each sensor properly and replace any damaged sensors with a new one.
	The sensor's harness has not been connected to the ECU.	Confirm whether the harness has been connected properly.	Connect the plug of the harness to the ECU.

<p>The gear is in “R” but the warning does not go off although there are objects behind the vehicle.</p>	<p>One of the sensors is damaged.</p>	<p>Confirm whether each sensor functions properly.</p>	<p>Replace any damaged sensor with a new one.</p>
	<p>The objects are outside the range of detection.</p>	<p>Refer to the service manual for the range of detection.</p>	<p>(The warning does not go off when objects are outside the detection area).</p>
	<p>ECU is damaged.</p>	<p>Confirm whether the ECU is damaged.</p>	<p>Replace ECU with a new one.</p>
<p>The gear is in “R” and the warning goes off for a while although there is no object behind the vehicle.</p>	<p>The sensor surface is covered with foreign materials such as mud, water drops, etc.</p>	<p>Confirm whether the sensor surface is covered with foreign materials.</p>	<p>Clean up the sensor surface and see if it functions normally.</p>
	<p>One of the sensors is damaged.</p>	<p>Confirm whether each sensor functions properly.</p>	<p>Replace any damaged sensor with a new one.</p>
<p>The gear is in “R”, and the warning goes off intermittently although there is no object behind the vehicle.</p>	<p>The sensors are not installed in the proper position.</p>	<p>Confirm whether the sensors are installed in the proper position.</p>	<p>Reinstall the sensors in the proper position.</p>
	<p>The sensors have detected harsh roads.</p>	<p>Confirm the road condition.</p>	<p>(Misdetection is possible when the system detects harsh roads or small objects on the road.)</p>
	<p>The vehicles posture is weighted heavily to one side.</p>	<p>Confirm the vehicles posture.</p>	<p>Misdetection may occur if the vehicle is heavily weighted in the rear or at the cusp of a steep incline. (Refer to service manual for figure.)</p>

Product specification

Items	Specification
Rated Voltage	DC 12.0V
Operation Voltage	DC 9.6V~ 16V
Operation Temp	-20°C~ 70°C
Storage Temp	-30°C~ 80°C

mitsubishi motors
GENUINE PARTS



SET PRINTER TO : "ACTUAL SIZE" or "NONE" NOT "SCALE

OUTLANDER

REAR PARK ASSIST TEMPLATES / MODEL YEARS 2007 ON
 REVERSE FOR RIGHT SIDE

