

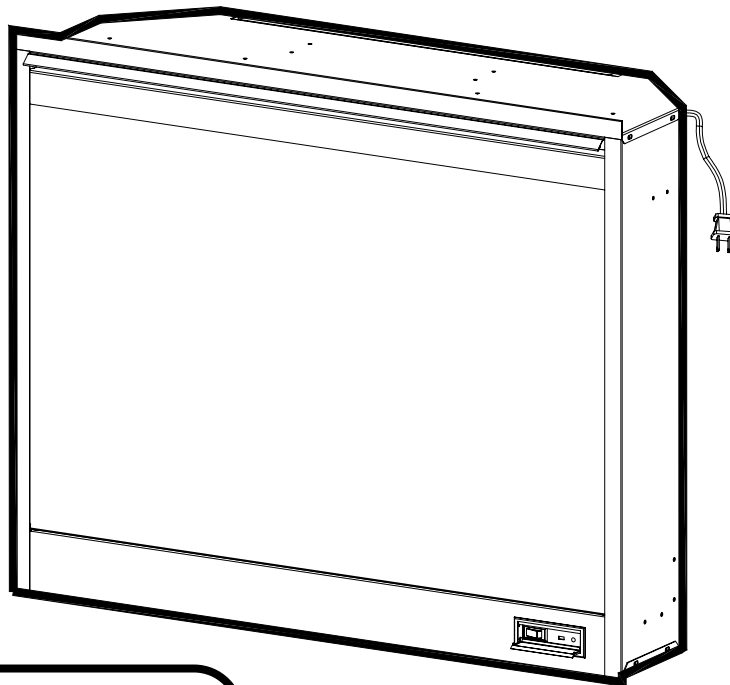

PRACTICAL USER'S GUIDE FOR THE DIMPLEX MULTIFIRE™ ELECTRIC FIREPLACE

MODEL NUMBER: DF3015



Serial Number _____

Model Number _____

CAT Number _____

Quality checked by:

Valued Customer,

We are pleased that you have chosen to purchase an electric fireplace manufactured by Dimplex North America Ltd. Over the years, valuable memories will occur around the warmth and comfort of your hearth. Thank you for allowing our product to be the backdrop for those special moments.

QUICK REFERENCE GUIDE FOR THE DIMPLEX ELECTRIC FIREPLACE

- 1. Prior to the first use of the fireplace verify the following:**
 - Are the circuit breakers for the socket the unit uses on?
 - Are the light bulbs in your fireplace loose? (to check, follow the instructions for replacing the light bulbs under the maintenance section of this manual)

 - 2. The heater on your fireplace may emit a slight, harmless odor when first used. This odor is a normal condition caused by the initial heating of internal heater parts and will not occur again.**

 - 3. The information regarding the model of your fireplace can be found on the rating plate. See Page 2 for location.**

 - 4. If you have any technical questions regarding the operation or service of your fireplace have your Model and Serial Number ready, and contact Dimplex North America technical support at 1-888-DIMPLEX (1-888-346-7539) before returning the product to the point of purchase.**
-

CONTENTS

PAGE 1	Important Instructions
PAGE 2	Model and Serial Number Information
PAGE 3	Site Selection and Preparation
PAGE 4	Fireplace Installation
PAGE 5	Operation
PAGE 13	Maintenance
PAGE 16	Warranty

IMPORTANT INSTRUCTIONS

SAVE THESE INSTRUCTIONS

PLEASE RETAIN THIS USER'S GUIDE FOR FUTURE REFERENCE

When using electrical appliances, basic precautions should always be followed to reduce the risk of fire, electric shock, and injury to persons, including the following:

1. Read all instructions before using the electric fireplace.
2. The heater is hot when in use. To avoid burns, do not let bare skin touch hot surfaces. The trim around the heater outlet becomes hot during heater operation. Keep combustible materials, such as furniture, pillows, bedding, papers, clothes, and curtains at least 3 feet (0.9m) from the front of the unit.
3. Extreme caution is necessary when any heater is used by or near children or invalids and whenever the unit is left operating and unattended.
4. Always unplug the electric fireplace when not in use.
5. Do not operate any unit with a damaged cord or plug, or if the heater has malfunctioned, or if the electric fireplace has been dropped or damaged in any manner. Return heater to authorized service facility for examination, electrical or mechanical adjustment, or repair.
6. Do not use outdoors.
7. The electric fireplace is not intended for use in bathrooms, laundry areas and similar indoor locations. Never locate heater where it may fall into a bathtub or other water container.
8. Do not run the cord under carpeting. Do not cover cord with throw rugs, runners, or the like. Arrange cord away from traffic area and where it will not be tripped over.
9. To disconnect the unit, turn the controls off, then remove the plug from the outlet.
10. Do not insert or allow foreign objects to enter any ventilation or exhaust opening as this may cause an electric shock or fire, or damage to the heater.
11. To prevent a possible fire, do not block air intake or exhaust in any manner. Do not use on soft surfaces, like a bed, where openings may become blocked.
12. All electrical heaters have hot and arcing or sparking parts inside. Do not use in areas where gasoline, paint, or flammable liquids are used or stored or where the unit will be exposed to flammable vapors.
13. Do not modify the electric fireplace. Use it only as described in this manual. Any other use not recommended by the manufacturer may cause fire, electric shock or injury to persons.
14. Avoid the use of an extension cord. Extension cords may overheat and cause a risk of fire. If you must use an extension cord, the cord must be No. 16 AWG minimum size and rated no less than 1875 watts.
15. Do not burn wood or other materials in the electric fireplace.
16. Do not strike the fireplace glass.
17. Always use a certified electrician should new circuits or outlets be required.
18. Always use properly grounded, fused and polarized outlets.
19. Disconnect all power supply before performing any cleaning, maintenance or relocation of the unit.
20. When transporting or storing the unit and cord, keep in a dry place, free from excessive vibration and store so as to avoid damage.

NOTE: Procedures and techniques that are considered important enough to emphasize.

CAUTION: Procedures and techniques which, if not carefully followed, will result in damage to the equipment.

WARNING: Procedures and techniques which, if not carefully followed, will expose the user to the risk of fire, serious injury, illness or death.

IMPORTANT INSTRUCTIONS

If you have any questions regarding our products please have the product model and serial numbers available upon calling Dimplex customer service or technical support. To locate the model and serial number labels see below. Record the Model number, Serial number, and CAT number on the front cover of this manual for future reference.

Model Number

Serial Number

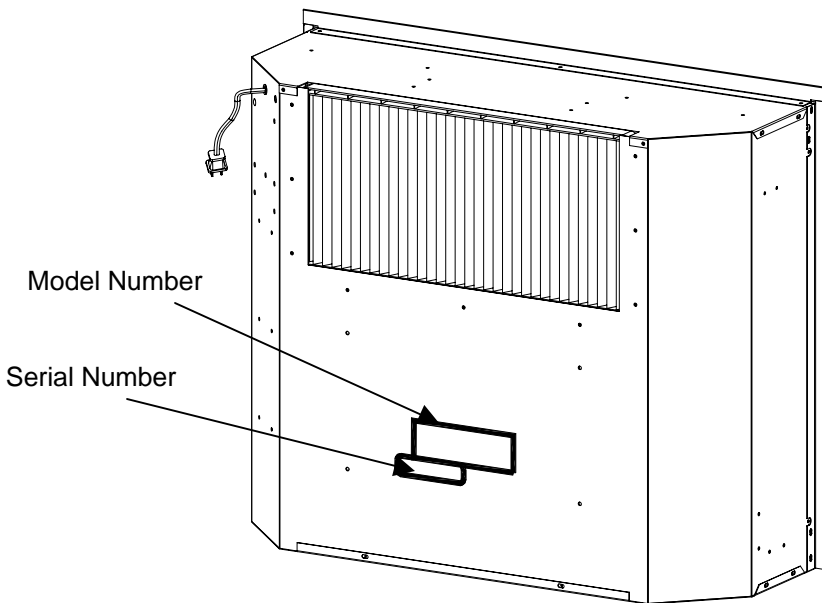
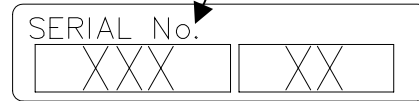
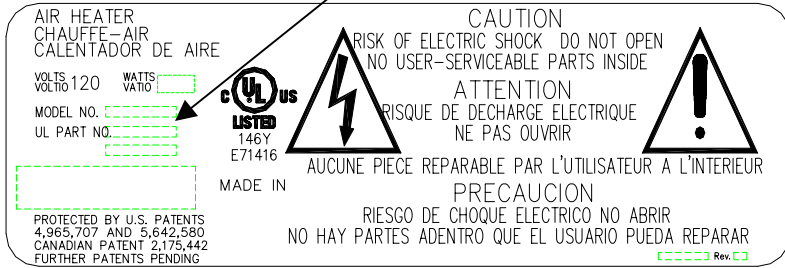

Firebox

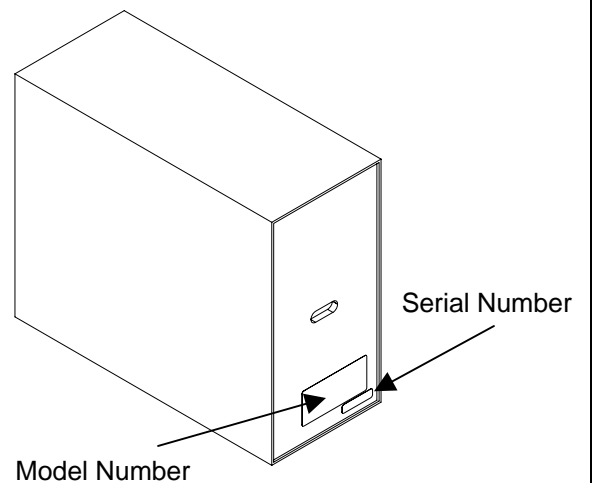

Carton

NOTE 1

A 15amp, 120 volt circuit is required. A dedicated circuit is preferred but not essential in all cases. A dedicated circuit will be required if, after installation, the circuit breaker trips or fuse blows on a regular basis when the heater is operating. Additional appliances on the same circuit may exceed the current rating of the circuit breaker.

WARNING

Ensure the power cord is not installed so that it is pinched or against a sharp edge and ensure that the power cord is stored or secured to avoid tripping or snagging to reduce the risk of fire, electric shock or injury to persons.

Construction and electrical outlet wiring must comply with local building codes and other applicable regulations to reduce the risk of fire, electric shock and injury to persons.

Do not attempt to wire your own new outlets or circuits. To reduce the risk of fire, electric shock or injury to persons, always use a licensed electrician.

SITE SELECTION AND PREPARATION

This section provides instructions for selecting a location and preparing the site to install the fireplace into your Dimplex mantel surround.

1. Select a suitable location that is not susceptible to moisture and is away from drapes, furniture and high traffic.
2. For ease of electrical hook up you may wish to locate the fireplace near an existing outlet. (refer to NOTE 1)
3. Store the fireplace in a safe dry and dust free location.

NOTE

The dimensions of the fireplace are 30 1/4"wide X 25 1/2" high X 10 1/2" deep. The viewing area is 30 1/8" wide and 20 1/8" high. The fireplace does not require any additional venting.

FIREPLACE INSTALLATION

1. Install the fireplace assembly into the mantel. (refer to mantel assembly instructions)

NOTE 1

A 15 AMP, 120 VOLT circuit is required. A dedicated circuit is preferred but not essential in all cases. A dedicated circuit will be required if, after installation, the circuit breaker trips or fuse blows on a regular basis when the heater is operating. Additional appliances on the same circuit may exceed the current rating of the circuit breaker.

IMPORTANT

If not using a Dimplex mantel, the fireplace must be installed in an enclosure with the following **MINIMUM** internal/opening dimensions.

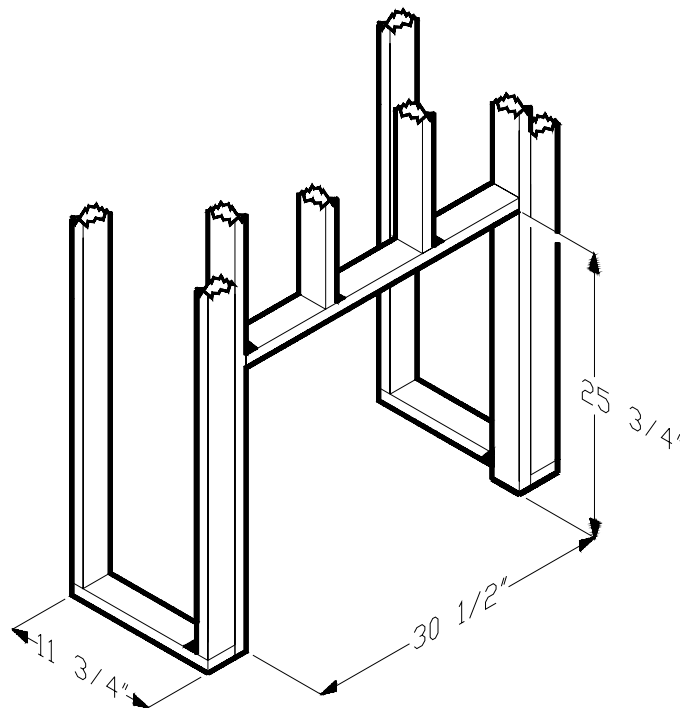

NEW WALL CONSTRUCTION

1. Select a suitable location that is not susceptible to moisture and is away from drapes, furniture and high traffic.
2. Place the fireplace in the desired location to see how it will look in the room.
3. Mark the desired location on the floor and store the fireplace in a safe, dry and dust free location.
4. Use studs to frame an opening of 30 1/2" wide X 25 3/4" high X 11 3/4" deep.

Option #1-The power cord can be lead from behind the trim and along the wall to an outlet near the fireplace.

Option #2-A new outlet can be installed inside the new frame construction.

Plug the unit into a 15Amp/120Volt outlet. If the cord does not reach, you may use an extension cord rated for a **minimum of 1875 watts**.

CAUTION

Clearance for air circulation beneath the fireplace insert is provided by three rubber feet. **DO NOT INSTALL THE FIREPLACE INSERT DIRECTLY ON CARPET OR SIMILAR SURFACES WHICH MAY RESTRICT AIR CIRCULATION.** If installing the fireplace in a carpeted area, place a one-piece, solid, flat surface under the fireplace insert. Ensure that all three of the insert's feet rest securely on this surface.

OPERATION

ELECTRIC FIREPLACE MANUAL CONTROL

The manual controls for the fireplace are located in the lower right hand corner.

A. Main On/Off Switch

Supplies power to the 3 position manual control switch.

B. 3 Position Manual Control Switch

Remote (right position): The unit is operated with the remote control.

Flame (center position): The flame effect is turned ON.

Flame & Heat (left position): The flame effect and heater are turned ON simultaneously. When the manual control is in the **Flame & Heat** position the heater does not run on the remote operated thermostat.

NOTE

When the manual control switch is in the **Flame** and **Flame & Heat** positions, the fireplace unit will not operate with the remote control.

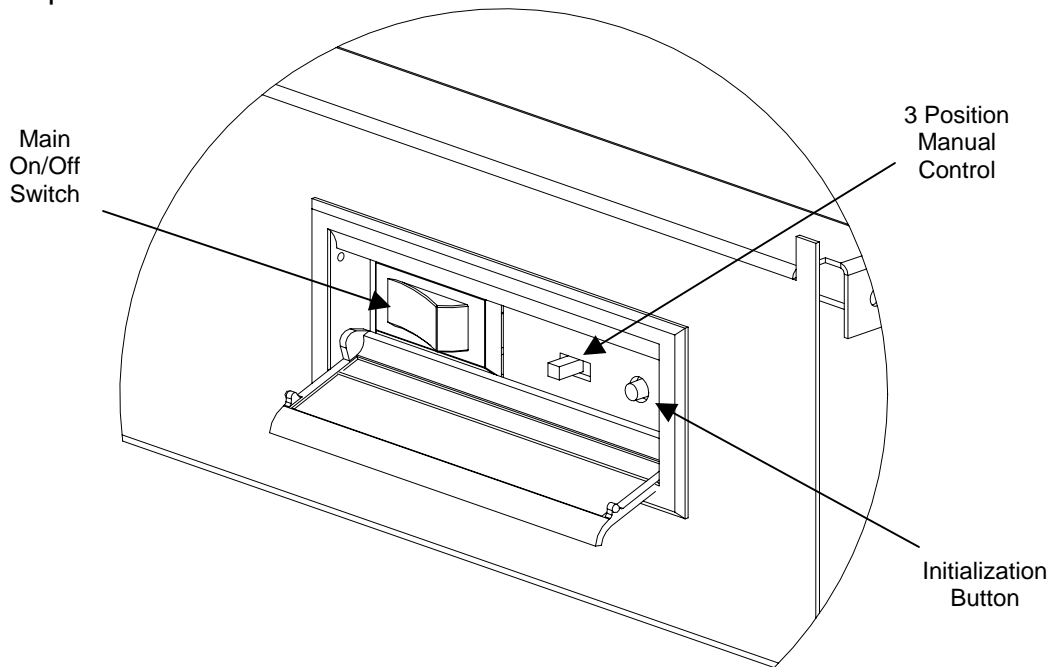

FIGURE 2

RESETTING THE TEMPERATURE CUTOFF SWITCH

Should the heater overheat, an automatic switch will turn the heater off and it will not come back on without being reset. The temperature cutoff switch can be reset by unplugging the unit, waiting 5 minutes and plugging the unit back in.

CAUTION

If you need to continuously reset the heater, unplug the unit and call Dimplex North America Limited at 1-800-668-6663 and press 4 for technical support. Please have your model and serial number ready when calling.

REMOTE CONTROL

The remote control has a range of approximately 50 ft. (15.25m), it does not have to be pointed at the fireplace and can pass through most obstacles (including walls). It is supplied with 243 independent frequencies to prevent interference with other units.

BATTERY INSTALLATION

1. Depress tab on the battery cover on the back of the remote transmitter and remove battery cover.
2. Install 2 AAA batteries into the remote control. (included)
3. Ensure child lock is in the “unlocked” position.
4. Replace the battery cover.

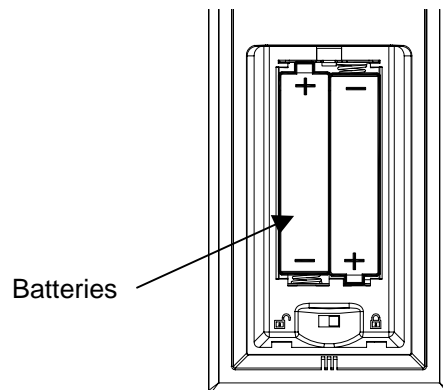





FIGURE 3

NOTE

When the “**BAT**” symbol is present on the remote control it is recommended to replace the batteries promptly, to maintain full functionality of the remote/fireplace. The remote transmitter has a battery backup time of only several hours.

INITIALIZING THE REMOTE CONTROL

1. Plug cord into 120 volt wall outlet.
2. Ensure the Main On/Off switch located in the switch box on the fireplace in the lower right hand corner is in the **ON** position.
3. Set the 3 position manual control to the **Remote** position (right position).
4. Press and hold the initialization button on the unit.
5. While holding the initialization button, press the flame/heat ON/OFF  button or the Purifire™ ON/OFF  button on the remote control transmitter.
6. Release the initialization button on the unit.
7. Press the Flame/Heat On/Off button  to turn the Flame/Heat function ON or press the Purifire™ On/Off button  to turn the Purifire™ function ON.

FREQUENCY INTERFERENCE

If the fireplace does not respond properly to the remote control, the remote operating frequency may have to be reset. The remote control can send another frequency code to the circuit board to eliminate interference.

1. Simultaneously press the “**SLEEP TIMER DOWN**” button and the “**PURIFIRE LOW SPEED**” button on the remote control.
2. “**COD**” will appear in place of the sleep timer digits.
3. Release the “**SLEEP TIMER DOWN**” button and the “**PURIFIRE LOW SPEED**” button.
4. Press the initialization button on the unit.
5. press the  button on the remote.

Your remote will now have a different frequency communicating with the fireplace.

REMOTE CONTROL FUNCTIONS

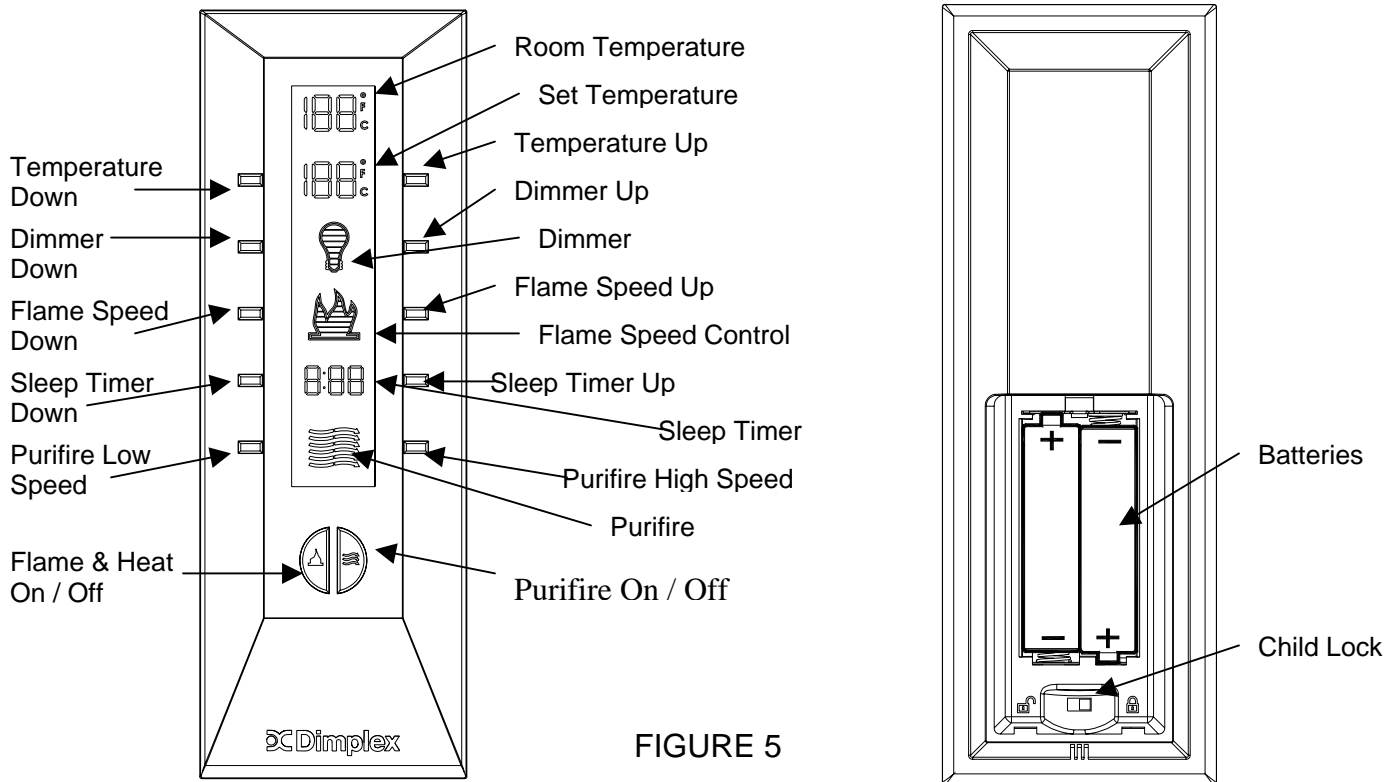



FIGURE 5

FLAME/HEAT ON/OFF BUTTON

Press the “**Flame/Heat On/Off**” button  to turn the Flame/Heat function **ON**. When the “**Set Temperature**” is higher than the “**Room Temperature**” the heat will come on. To turn the heat off, lower the “**Set Temperature**” so that its setting is lower than the “**Room Temperature**”. The default temperature setting is 72°F (22°C).

NOTE

When using the remote control the heater runs on a thermostat. Press the “**Temperature Up**” or “**Temperature Down**” button to adjust the set temperature. Once the desired set temperature is reached the heater will turn **OFF**. The heater will cycle **ON** and **OFF** to maintain the desired set temperature.

PURIFIRE ON/OFF BUTTON

Press the “**Purifire™ On/Off**” button  to turn the Purifire™ function **ON**. When the Purifire™ function is **ON** the Purifire™ symbol will flash. When off the symbol will be solid. The default setting for the Purifire™ is set at low speed. Press the “**Purifire™ On/Off**” button to turn the Purifire™ function **OFF**.

NOTE

To turn the Flame/Heat and Purifire™ **“OFF”** at the same time, press both  control buttons simultaneously.

SET TEMPERATURE

1. Press “**Flame Heat On/Off**” button to turn fireplace on.
2. Press “**Temperature Up**” to raise thermostat.
3. Press “**Temperature Down**” to lower thermostat.
4. Press both “**Temperature Up**” and **Temperature Down**” to change °F to °C.

FLAME SPEED

1. Press the “**Flame/Heat On/Off**” button  to turn the Flame/Heat **ON**.
2. Press the “**Flame Speed Up**” to increase the speed of the flame.
3. Press the “**Flame Speed Down**” to decrease the speed of the flame.

LIGHT DIMMER

1. Press the Flame/Heat button  to turn the Flame/Heat **ON**.
2. Repeatedly press the “**Light Dimmer Up**” or “**Light Dimmer Down**” button to decrease or increase the brightness of the upper lights.

CHILD LOCK

1. Depress tab on the battery cover on the back of the remote transmitter and remove the battery cover.
2. Move “**Child Lock**” tab to the right to lock the remote transmitter.
3. Move “**Child Lock**” tab back to the left to unlock the remote transmitter.
4. Replace the battery cover.

NOTE

To temporarily unlock the remote transmitter press (in order) “**Temperature Down**” then “**Temperature Up**” then “**Dimmer Down**”.

When the remote transmitter’s backlight is illuminated the “**Child Lock**” is bypassed. When the backlight is off the “**Child Lock**” is re-activated.

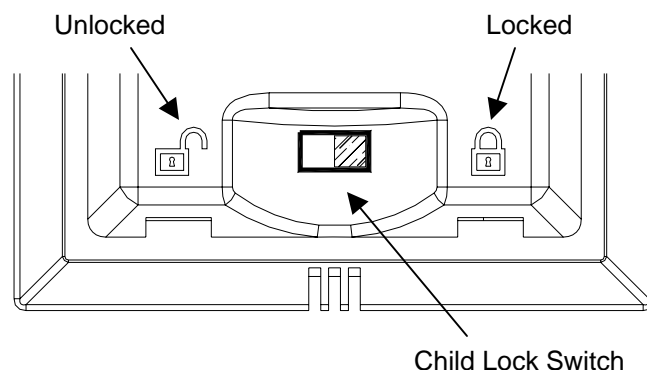





Figure 6

PURIFIRE™

The Purifire™ includes a high efficiency filter to help improve the quality of air.

1. Press the  button for the Purifire™ function.
2. Press the “**Purifire Low Speed**” button or the “**Purifire High Speed**” button to select LOW or HIGH.
3. Press the  button to turn the Purifire™ ON, press the  button to turn the Purifire™ OFF.

SLEEP TIMER

The Sleep Timer automatically shuts off the fireplace after a preset time (from 30 minutes to 8 hours).

1. Press the **Flame/Heat On/Off** button to turn the fireplace **ON**.
2. To set the sleep timer press the “**Sleep Timer Up**” button.
3. Set the timer from 30 minutes through 8 hours.
- 4.
5. The fireplace will automatically turn OFF when the sleep timer reaches 0 minutes.
6. The sleep timer can be cancelled at any time by pressing the “**Sleep Timer Down**” button repeatedly until the sleep timer displays “0”.

WARNING

Disconnect power before attempting any maintenance or cleaning to reduce the risk of fire, electric shock or damage to persons.

LIGHT BULB REPLACEMENT

Allow at least 5 minutes for light bulbs to cool before touching bulbs to avoid accidental burning of skin.

Light bulbs need to be replaced when you notice a dark section of the flame or when the clarity and detail of the log ember bed exterior disappears. There are four bulbs under the log set, which generate the flames and embers, and two bulbs above the log that illuminate the log exterior.

LOWER LIGHT BULB REQUIREMENTS

Quantity of 3 clear chandelier or candelabra bulbs with an E-12 (small) socket base, 60 watt rating. Example: GE 60BC or Philips 60 CTC.

DO NOT EXCEED 60 WATTS PER BULB

HELPFUL HINTS

It is a good idea to replace all light bulbs at one time if they are close to the end of their rated life. Group replacement will reduce the number of times you need to open the unit to replace light bulbs. Care must be taken when removing the logset as the logset contains LED's and wires.

To access the lower light bulb area:

NOTE

Figure 7

1. Slide fireplace out of mantel 2-3 inches.
2. Remove 4 Phillips screws from the right side of trim.
3. Slide glass to right side of fireplace to remove.
4. Pull the front edge of the plastic ember bed or plastic grate up and forward until the rear tab releases from the ledge located at the bottom of the mirror.

IMPORTANT

Only handle the logset by the emberbed.

NOTE

Logset fits tightly into firebox, some force may be necessary to remove.

5. Set logset in front of fireplace.
6. Disconnect the logset LED wire harness from unit.
7. Unscrew bulbs counter clockwise.
8. Insert new bulbs.
9. Reconnect the logset LED wire harness.
10. Replace the logset by inserting the front edge of the fireplace and push down on the rear edge of the emberbed until it snaps into place. (Figure 8)

NOTE

Ensure the logset is installed tightly under the back ledge to prevent light leakage.

11. Slide front glass back into position and attach trim.

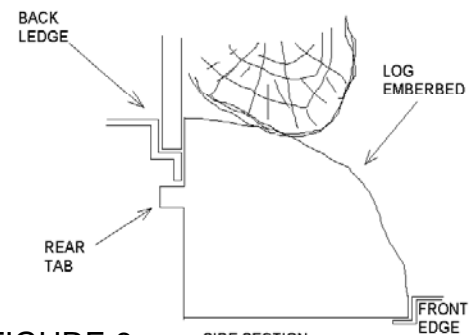
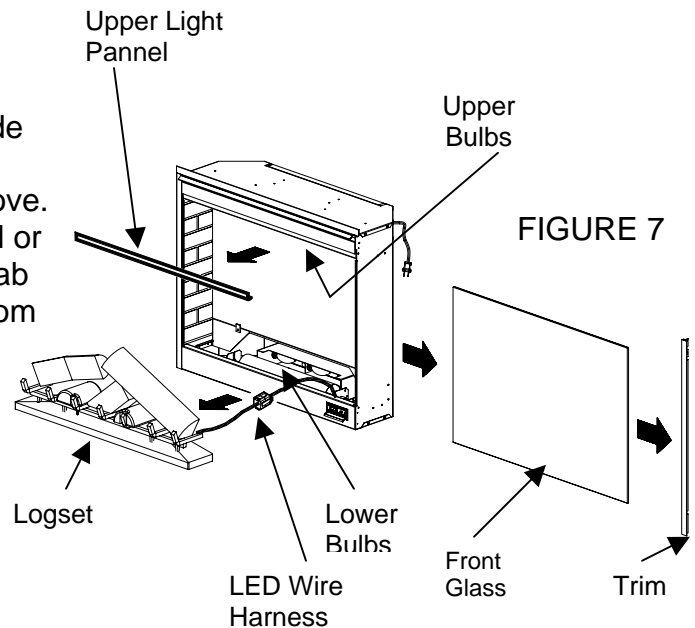

UPPER LIGHT BULB REQUIREMENTS

Quantity of 2 clear chandelier or candelabra bulbs with an E-12 (small) socket base, 25 watt rating.

DO NOT EXCEED 25 WATTS PER BULB

To access the upper light bulb area:

Figure 7

1. Slide fireplace out of mantel 2-3 inches.
2. Remove 4 Phillips screws from right side of trim.
3. Remove trim.
4. Slide glass to the right side of the fireplace to remove.
5. Remove upper light panel.
6. Upper bulbs located in the upper left and upper right corners of fireplace.
7. Unscrew bulbs counter clockwise.
Insert new bulbs.
8. Re-install upper light bracket.
Slide front glass back into position and attach trim.

PURIFIRE™ FILTER

The Purifire™ filter supplied in your fireplace is reusable and washable. The filter should be cleaned or replaced on average once a year. To clean the filter gently tap filter on a hard surface to dislodge any loose dirt or debris, and then clean with water. No soap or cleaning products are recommended. The filter size is 20" X 10" X 1" rated at MERV 10. If using an after market filter follow the manufacturers recommended replacement instructions.

To replace filter:

1. Remove fireplace from mantel.
2. Filter can be accessed from the top rear of the unit.
3. Grasp filter and slide filter straight up.
4. Replace or clean filter.

NOTE

If after market air filter is used ensure it is installed according to the manufacturers recommended instructions.

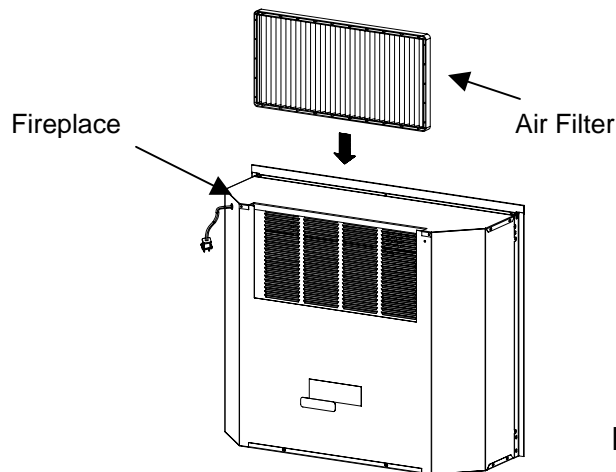

FIGURE 9

GLASS CLEANING

The glass is cleaned in the factory during the assembly operation. During shipment, installation, handling, etc., the glass may collect dust particles; these can be removed by dusting lightly with a clean dry cloth.

To remove fingerprints or other marks, the glass can be cleaned with a damp cloth. To prevent scratching, do not use abrasive cleaners or spray liquids on the glass surface.

FIREPLACE SURFACE CLEANING

Use a cloth dampened with warm water only to clean painted surfaces of the electric fireplace. Do not use abrasive cleaners.

FIVE YEAR LIMITED WARRANTY

Products to which this limited warranty applies

This limited warranty applies to the following model of your newly purchased Dimplex electric fireplace **DF3015** and to newly purchased Dimplex fireplace surrounds (mantels) and trims. This limited warranty applies only to purchases made in any province of Canada *except* for Yukon Territory, Nunavut, or Northwest Territories or in any of the 50 States of the USA (and the District of Columbia) *except* for Hawaii and Alaska. This limited warranty applies to the original purchaser of the product only and is not transferable.

Products excluded from this limited warranty

Light bulbs and Purifire™ filters are not covered by this limited warranty and are the sole responsibility of the owner/purchaser. Products purchased in Yukon Territory, Nunavut, Northwest Territories, Hawaii, or Alaska are not covered by this limited warranty. Products purchased in these States, provinces, or territories are sold AS IS without warranty or condition of any kind (including, without limitation, any implied warranties or conditions of merchantability or fitness for a particular purpose) and the entire risk of as to the quality and performance of the products is with the purchaser, and in the event of a defect the purchaser assumes the entire cost of all necessary servicing or repair.

What this limited warranty covers and for how long

Products, other than fireplace surrounds (mantels) and trims, covered by this limited warranty have been tested and inspected prior to shipment. Subject to the provisions of this warranty, Dimplex warrants such products to be free from defects in material and workmanship for a period of 5 years from the date of the first purchase of such products as follows: (a) a repair or replacement warranty on defective products or parts, including in-home services, for the first 2 years following the date of first purchase; and (b) thereafter, a replacement of parts warranty on defective products and parts (with no in-home services) for the 3 year period commencing on the second anniversary of first purchase and ending on the fifth anniversary of the date of first purchase.

Dimplex fireplace surrounds (mantels) and trims covered by this limited warranty have been tested and inspected prior to shipment and, subject to the provisions of this warranty, Dimplex warrants such products to be free from defects in material and workmanship for a period of 1 year from the date of first purchase of such products. Warranty services do not include in-home services.

The above section is a summary only of your warranty rights. Please review the remaining provisions of this warranty for your specific rights.

The limited 5 year warranty period for products other than fireplace surrounds (mantels) and trims and the limited 1 year warranty period for fireplace surrounds (mantels) and trims also applies to any implied warranties that may exist under applicable law. Some jurisdictions do not allow limitations on how long an implied warranty lasts, so the above limitation may not apply to the purchaser.

What this limited warranty does not cover

This limited warranty does not apply to products that have been repaired (except by Dimplex or its authorized service representatives) or otherwise altered. This limited warranty does further not apply to defects resulting from misuse, abuse, accident, neglect, incorrect installation, improper maintenance or handling, or operation with an incorrect power source.

What you must do to get service under this limited warranty

Defects must be brought to the attention of Dimplex Technical Service by contacting Dimplex at 1-888-[DIMPLEX](tel:1-888-DIMPLEX) (1-888-346-7539), or 1367 Industrial Road, Cambridge Ontario, Canada N1R 7G8. Please have proof of purchase, catalogue/model and serial numbers available when calling. Limited warranty service requires a proof of purchase of the product.

What Dimplex will do in the event of a defect

In the event a product or part covered by this limited warranty is proven to be defective in material or workmanship during (i) the 5 year limited warranty period for products other than fireplace surrounds (mantels) and trims, and (ii) the 1 year limited warranty period for surrounds (mantels) and trims, you have the following rights:

- Limited warranty service will be performed solely by dealers or service agents of Dimplex authorized to provide limited warranty services.
- **For products (other than surrounds (mantels) and trims) for the period ending at midnight on the second anniversary of the date of first purchase**, Dimplex will in its sole discretion either repair or replace such defective product or part without charge. If Dimplex is unable to repair or replace such product or part, or if repair or replacement is not commercially practicable or cannot be timely made, Dimplex may, in lieu of repair or replacement, choose to refund the purchase price for such product or part. *This limited warranty entitles the purchaser to on-site or in-home warranty services.* Accordingly, Dimplex will be responsible for all labour and transportation costs associated with the repair or replacement of the product or part except as follows: (i) charges may be levied for travel costs incurred to travel to the purchaser's site where the product is located if the purchaser's site is beyond 30 miles (48 km) from the closest service depot of Dimplex's dealer or service agent; and (ii) the purchaser is solely responsible for providing clear access to all serviceable parts of the product.
- **For products (other than surrounds (mantels) and trims) for the period commencing at 12:01 a.m. on the day after the second anniversary of the first purchase and ending at midnight on the fifth anniversary of the date of first purchase**, this limited warranty entitles the purchaser to replacement parts only without charge. If Dimplex is unable to replace such part, or if replacement is not commercially practicable or cannot be timely made, Dimplex may, in lieu of replacement, choose to refund the purchase price for such part. The purchaser shall not be entitled to on-site or in-home warranty services. The purchaser shall be responsible for all expenses incurred for the removal of the part and installation of the replacement part including, without limitation, all shipping costs and transportation costs to and from the authorized dealer's or service agent's place of business and all labour costs. Such costs shall not be the responsibility of Dimplex.

- **For surrounds (mantels) and trims for the period ending at midnight on the first anniversary of the date of first purchase,** Dimplex will in its sole discretion either repair or replace such defective surrounds (mantels) and trims or part thereof without charge. If Dimplex is unable to repair or replace such product or part, or if repair or replacement is not commercially practicable or cannot be timely made, Dimplex may, in lieu of repair or replacement, choose to refund the purchase price for such product or part. The purchaser shall not be entitled to on-site or in-house services. The purchaser is responsible for all expenses incurred for repair or replacement of such product or part including, without limitation, all shipping costs and transportation costs to and from the authorized dealer's or service agent's business and all labour costs. Such costs shall not be the responsibility of Dimplex.
- On-site or in-home services not provided under this warranty may be performed at the purchaser's specific request and expense at Dimplex's then-current rates for such services.

What Dimplex and its dealers and service agents are also not responsible for:

IN NO EVENT WILL DIMPLEX, OR ITS DIRECTORS, OFFICERS, OR AGENTS, BE LIABLE TO THE PURCHASER OR ANY THIRD PARTY, WHETHER IN CONTRACT, IN TORT, OR ON ANY OTHER BASIS, FOR ANY INDIRECT, SPECIAL, PUNITIVE, EXEMPLARY, CONSEQUENTIAL, OR INCIDENTAL LOSS, COST, OR DAMAGE ARISING OUT OF OR IN CONNECTION WITH THE SALE, MAINTENANCE, USE, OR INABILITY TO USE THE PRODUCT, EVEN IF DIMPLEX OR ITS DIRECTORS, OFFICERS, OR AGENTS HAVE BEEN ADVISED OF THE POSSIBILITY OF SUCH LOSSES, COSTS OR DAMAGES, OR IF SUCH LOSSES, COSTS, OR DAMAGES ARE FORESEEABLE. IN NO EVENT WILL DIMPLEX, OR ITS OFFICERS, DIRECTORS, OR AGENTS BE LIABLE FOR ANY DIRECT LOSSES, COSTS, OR DAMAGES THAT EXCEED THE PURCHASE PRICE OF THE PRODUCT.

SOME JURISDICTIONS DO NOT ALLOW THE EXCLUSION OR LIMITATION OF INCIDENTAL OR CONSEQUENTIAL DAMAGES, SO THE ABOVE LIMITATION OR EXCLUSION MAY NOT APPLY TO THE PURCHASER.

How State and Provincial law apply

This limited warranty gives you specific legal rights, and you may also have other rights which vary from jurisdiction to jurisdiction. The provisions of the United Nations Convention on Contracts for the Sale of Goods shall not apply to this limited warranty or the sale of products covered by this limited warranty.

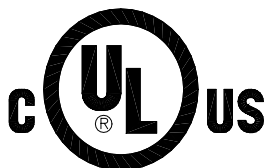

1-888-DIMPLEX
1-888-346-7539

Dimplex®

1367 Industrial Road
Cambridge, Ontario
Canada, N1R 7G8