



# Freshen up your air



---

VENTILATION  
CATALOGUE

# Benefits for

## building owners

Decreasing the energy costs of a building while, at the same time, maintaining or improving the air quality is our objective. We achieve this via high-efficiency heat recovery ventilation to reduce the loading on the air conditioning, combined with free cooling from the introduction of fresh outdoor air. Optional CO<sub>2</sub> sensors to ensure that over-ventilation does not occur while maintaining indoor comfort high.

## end users

High-quality air is essential for peak performance and pleasant environmental conditions. That means introducing fresh air with the correct level of humidity and necessary filtration to remove dust and other suspended particles which can cause respiratory issues or transmit odours. It also means ensuring the correct balance of CO<sub>2</sub> and oxygen guaranteed by the optional CO<sub>2</sub> sensors.

## design offices & consultants

Part of the Daikin 'Total Solution', all components are supplied by Daikin thus ensuring seamless integration and maximum flexibility. The wide range of units, from large air handling units to small ventilation ensure there is a perfect solution to meet the individual customer's needs.

## installers

As a result of the compact designs and modular assembly, shorter installation times are the norm. And, since all components of the system are supplied by Daikin, installers can be certain that all components will and work seamlessly together, reducing overall installation and configuration time.

# Ventilation and air purification

## Daikin ventilation and air purification

Fresh air is vital to our quality of life and well being. But as buildings become more airtight, fresh air circulation is much reduced. Daikin offers a variety of ventilation, air purification and large scale air handling solutions to help provide a fresh, healthy and comfortable environment in offices, hotels, stores and other commercial environments.

## Why we need fresh air in buildings

As building regulations raise standards in the energy efficient design of buildings, insulation levels become much higher, reducing the heating and cooling demand in buildings. However, stale air can remain trapped and cause:

- Need of oxygen
- Greater risk of allergies
- Odours lingering for longer
- Increased condensation causing mould

### Ventilation

Daikin commercial ventilation systems provide outdoor fresh air, remove stale air and balance the humidity within a building. This all helps to create a clean and comfortable environment that enhances the well-being of building users. Ventilation provides free cooling using fresh outside air. The option of heat recovery from within the building is also available to provide the highest levels of energy efficiency.

## Save energy with heat recovery

The beauty of Daikin commercial ventilation systems is that they can use heat reclaimed from the stale air being extracted from buildings to heat the incoming clean air to a comfortable temperature. This reduces the load on the air conditioning system, delivering 40% energy savings compared with introducing unheated fresh air into a building.

### Integrated ventilation

Ventilation can be integrated with Daikin's cooling and heating systems, for simplified control of the entire system. By including ventilation as part of a complete climate control solution, it is possible to manage up to 50% of a building's energy use - delivering huge potential savings in running costs and carbon emissions.

# Which system offers me the best solution?

Daikin offers a variety of solutions for the provision of fresh air ventilation to offices, hotels, stores and other commercial outlets – each one complementary to and as flexible as both Sky Air and VRV systems themselves.

## Heat Reclaim Ventilation

Proper ventilation is a key component of climate control in buildings, offices and shops. In its basic function, it ensures a flow of incoming fresh air and outgoing stale air. Our HRV (heat reclaim ventilation) solution can do much more. It can recover heat and **optimise the balance between indoor and outdoor temperature and humidity**, thus reducing the load on the air conditioning system up to 40% and increasing efficiency.

## Outdoor Air Processing in a single unit

Our FXMQ-MF air processing solution uses heat pump technology to **combine fresh air treatment and air conditioning in a single system**, thereby eliminating the usual design problems associated with balancing air supply and discharge. Total system cost is reduced and design flexibility enhanced because the indoor air conditioning fan coil units and an outdoor air treatment unit can be connected to the same refrigerant line.

## Daikin air handling units combined with condensing units

For small, medium and large commercial spaces, we offer a range of R-410A inverter condensing units that connect plug & play to our air handling units. This approach combines the high efficiency of our ERQ and VRV units with the fully customisable Daikin air handling units, resulting in a simple, reliable design for **optimum control of indoor air quality and maximum efficiency**.



# Overview ventilation range

## Ventilation

provision of fresh air

## Air processing

heats or cools incoming fresh air, maximising comfort and minimizing the load on the air conditioning installation

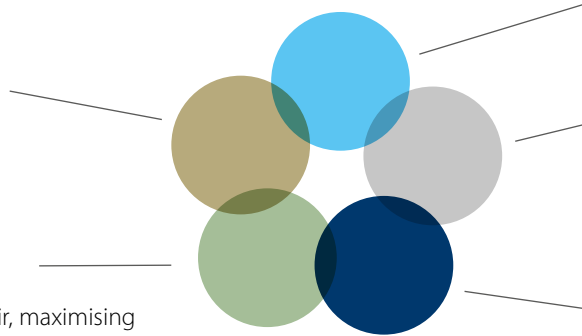

## Humidification

optimise the balance between indoor and outdoor humidity

## Heat recovery

recovers heat and moisture from the outgoing air to maximise comfort & efficiency

## Filtration

Removes dust, pollution and odours from the air

Type	name	Components of indoor air quality	Image	Air flow rate (m³/h)										
				0	200	400	600	800	1,000	1,500	2,000	4,000	6,000	8,000
HEAT RECLAIM VENTILATION	VAM-FA/FB	<ul style="list-style-type: none"> <li>› Ventilation</li> <li>› Heat recovery</li> </ul>		[Bar chart showing range from 0 to 2,000 m³/h]										
	VKM-GB	<ul style="list-style-type: none"> <li>› Ventilation</li> <li>› Heat recovery</li> <li>› Air processing</li> </ul>		[Bar chart showing range from 400 to 800 m³/h]										
	VKM-GBM	<ul style="list-style-type: none"> <li>› Ventilation</li> <li>› Heat recovery</li> <li>› Air processing</li> <li>› Humidification</li> </ul>		[Bar chart showing range from 400 to 800 m³/h]										
OUTDOOR AIR PROCESSING UNIT <sup>1</sup>	FXMQ-MF	<ul style="list-style-type: none"> <li>› Ventilation</li> <li>› Air processing</li> </ul>		[Bar chart showing range from 1,000 to 2,000 m³/h]										
AIR HANDLING UNITS	DX total fresh air package	<ul style="list-style-type: none"> <li>› Ventilation</li> <li>› Heat recovery</li> <li>› Air processing</li> <li>› Humidification</li> <li>› Filtration</li> </ul>		[Bar chart showing range from 1,500 to 4,000 m³/h]										
				[Bar chart showing range from 1,500 to 8,000 m³/h, with a yellow segment from 6,000 to 8,000 m³/h labeled (3)]										

<sup>1</sup> Not connectable to VRVIII-S (RXYSQ-PAV, RXYSQ-PAY)

<sup>2</sup> Air flow rate is a calculated indication only, based on the following values: heating capacity EKEXV-kit \* 200m³/h

<sup>3</sup> Daikin AHU connected to Daikin chiller solution

# Table of contents

<b>Introduction</b>	<b>2</b>
› Benefits	2
› Which system offers me the best solution?	4
› What's new?	7
<b>HRV - Heat reclaim ventilation</b>	<b>8</b>
› High efficiency - Benefits for building owners	10
› High quality indoor air - Benefits for end users	12
› Flexible installation - Benefits for design offices and consultants	15
› Benefits for installers	17
› Specifications	18
<b>FXMQ-MF - Outdoor Air Processing Unit</b>	<b>20</b>
› Benefits	22
› Connection conditions	22
› Specifications	23
<b>User friendly control systems</b>	<b>24</b>
› Overview of control systems	26
› Individual control systems	28
› Centralised control systems	30
<b>Daikin air handling units</b>	<b>32</b>
› Why use ERQ and VRV condensing units for connection to air handling units?	34
› Flexible control options	35
› VRV Air handling application (pair & multi)	36
› ERQ Air handling application (pair)	38
› Overview of expansion valves and control boxes	39
› Selection of air handling units	40
<b>Options &amp; accessories - Ventilation</b>	<b>42</b>

# What's new?

## All ventilation units fully eco design compliant

From 01/01/2013 all ventilation units with a fan from 125 W to 500 kW have to comply to the LOT 11 Eco design requirements. As market leader Daikin takes the step to comply with all ventilation units to this by adopting DC fan motors in all ventilation units in scope of this legislation, improving their energy efficiency even further.

### Heat reclaim ventilation VAM-FB - VKM-GB(M)

- Better efficiency with DC fan motor
- Optional CO<sub>2</sub> sensor saves energy while maintaining comfort
- Optional M6, F7 and F8 dust filters (for VAM-FB series only)
- Shorter installation time thanks to easy adjustment of nominal air flow rate

### Electrical heater for VAM

- Total solution for fresh air with Daikin supply of both VAM and electrical heater
- Increased comfort in low outdoor temperature thanks to the heated outdoor air
- Integrated electrical heater concept (no additional accessories required)
- Standard dual flow and temperature sensor
- Flexible setting with adjustable setpoint
- Increased safety with 2 cut-outs: manual & automatic
- BMS integration thanks to:
  - volt free relay for error indication
  - 0-10V DC input for setpoint control

### Daikin air handling units D-AHU professional/easy/energy

- Total solution with Daikin supply of R-410A inverter condensing units or Chillers
- Plug & play concept: factory mounted DDC controller, control box, expansion valve and all other components designed and configured for connecting Daikin ERQ or VRV condensing units
- Highly efficiency heat recovery AHU recovering up to 80% of heat
- Standard G4 filters and optional filters available up to class F7
- 5 pre-defined AHU packages (from 2,000 to 10,000m<sup>3</sup>/h) make selection quick and easy



**SEASONAL EFFICIENCY**  
Smart use of energy



# HRV

## Heat reclaim ventilation

### Create a high-quality indoor environment

The Daikin HRV (heat reclaim ventilation) unit recovers up to 80% of heat energy lost through ventilation and maintains a comfortable and clean indoor environment without changing the room's temperature.

### Save up to **40%** on running costs through integration

Integrating the HRV with Daikin's Sky Air and VRV air conditioning ensures that the system always operates in the most efficient and comfortable way. For example, the free cooling available via the ventilation unit will enable the air conditioning unit to be switched off and so saving running costs.

Thanks to heat recovery and integration, up to 40% of the total running costs can be saved!

### HRV by Daikin offers:

#### High efficiency

- 40% lower running costs using heat recovery and integration
- Free cooling overnight
- No over-ventilation with optional CO<sub>2</sub> sensor

#### High indoor air quality

- Perfect comfort thanks to temperature and humidity control
- Clean indoor air with optional medium and fine dust filters

#### Whisper quiet

- Low operation sound
- Integrate ventilation in a total Daikin solution
- Slim design
- Horizontal or vertical installation (for VAM only)
- High static pressure
- Total fresh air solution with Daikin's supply of VAM and electrical heater



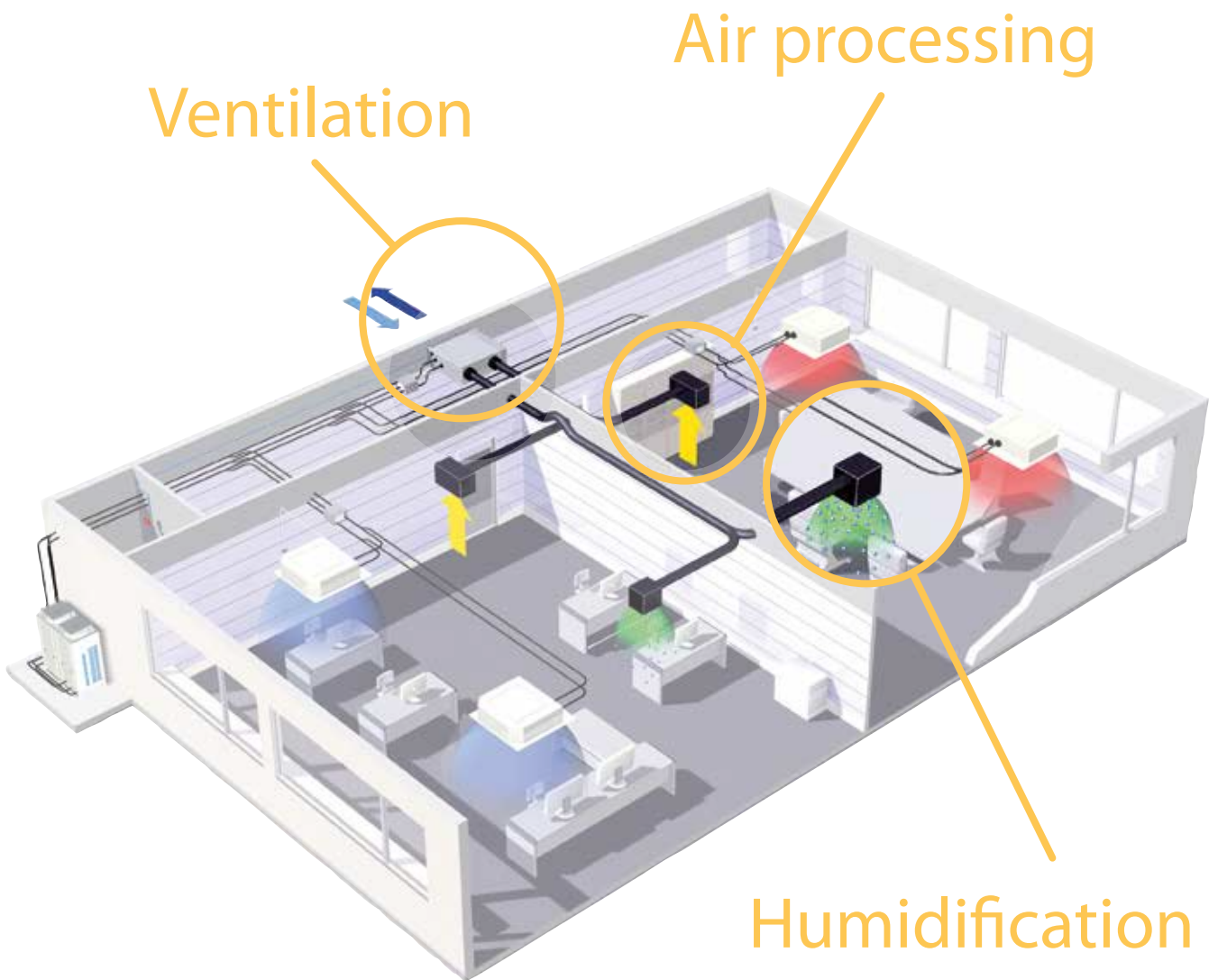

# High efficiency

## Benefits for building owners

### Energy saving ventilation via heat recovery of both heat and humidity

Buildings need ventilation, all year round. However, in traditional ventilation systems, conditioned air from the building is simply expelled, then new unheated air is brought into the building. So a large volume of air is heated up or cooled down unnecessarily, leading to a substantial waste of energy. Daikin's HRV solutions prevent energy being wasted by recovering up to 80% waste heat from the outgoing air, thus offering much greater levels of efficiency, while improving comfort levels too.



### Specially developed heat exchange element

The heat exchange element uses a high efficiency paper (HEP) possessing superior moisture absorption and humidifying properties. The heat exchange unit rapidly recovers heat contained in latent heat (vapour). The element is made of a material with flame resistant properties and is treated with an anti-moulding agent.

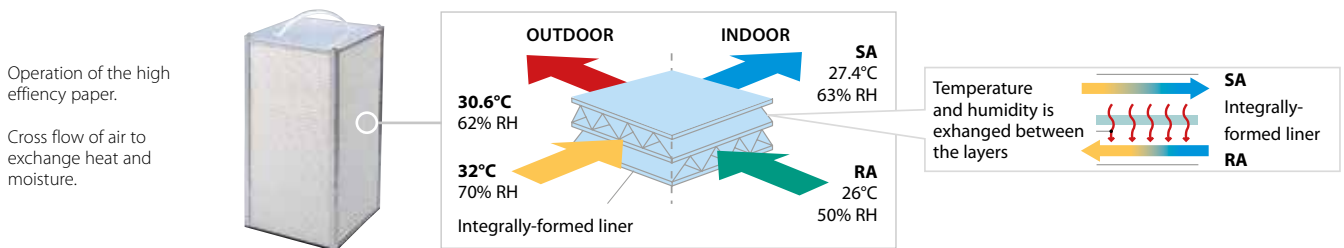

Thanks to the heat and moisture exchange the hot and humid outside air is brought to levels close to indoor conditions saving on the air conditioning running cost and maintaining comfort.

### Reduce the load on the air conditioning system by up to 40%

- 24% by using heat recovery ventilation (in comparison with normal ventilation fans)
- 6% by switching over to auto-ventilation mode
- 2% by using the pre-cool, pre-heat control (reduces air conditioning load by running the HRV until after the air conditioning is switched on)
- 5% by enabling the free cooling operation overnight
- 3% by preventing over-ventilation with the optional CO<sub>2</sub> sensor

### Advantages of integration of ventilation and air conditioning (automatic change over)

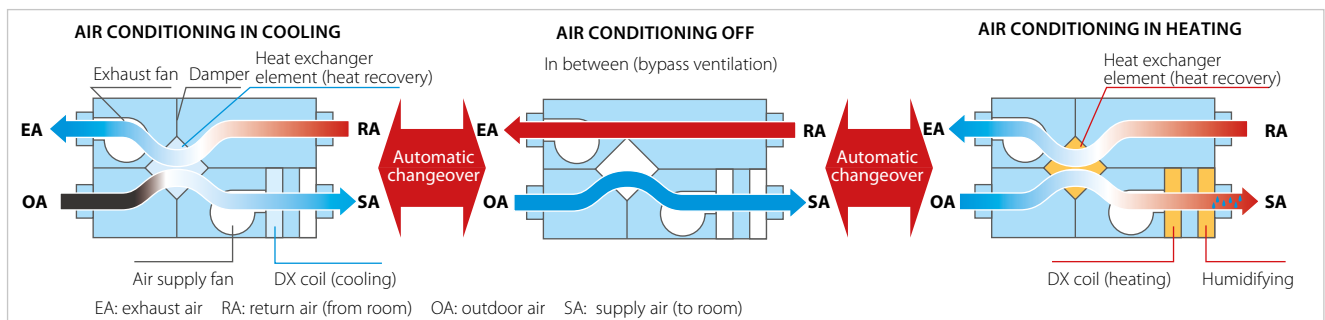

## Nighttime free cooling

Nighttime free cooling operation is **an energy saving function operating at night** when the air conditioning is switched off. By ventilating rooms containing office equipment that increases room temperature, night purge reduces the cooling load when air conditioning is switched on in the morning, reducing the daily running costs.

The new VAM-FB series can also perform nighttime free cooling in stand alone operation. The set temperature is a field setting at installation.

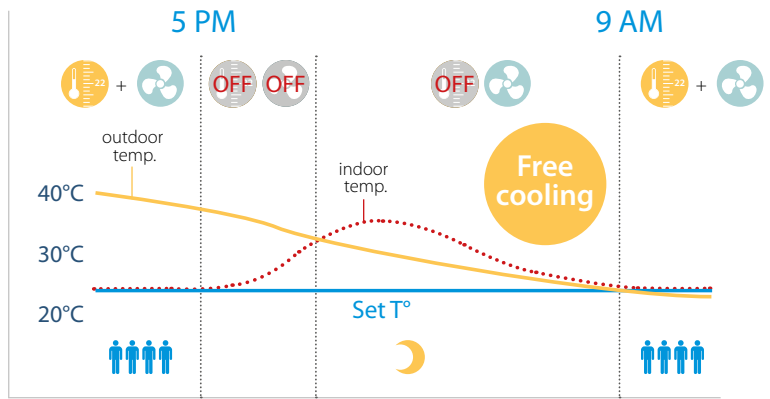

## Prevent energy losses from over ventilation with CO<sub>2</sub> sensor

Enough fresh air is needed to create an enjoyable environment, but ventilating constantly is leading to energy waste. Therefore an optional CO<sub>2</sub> sensor can be installed which switches off the ventilation system when there is enough fresh air in the room, thus saving energy.

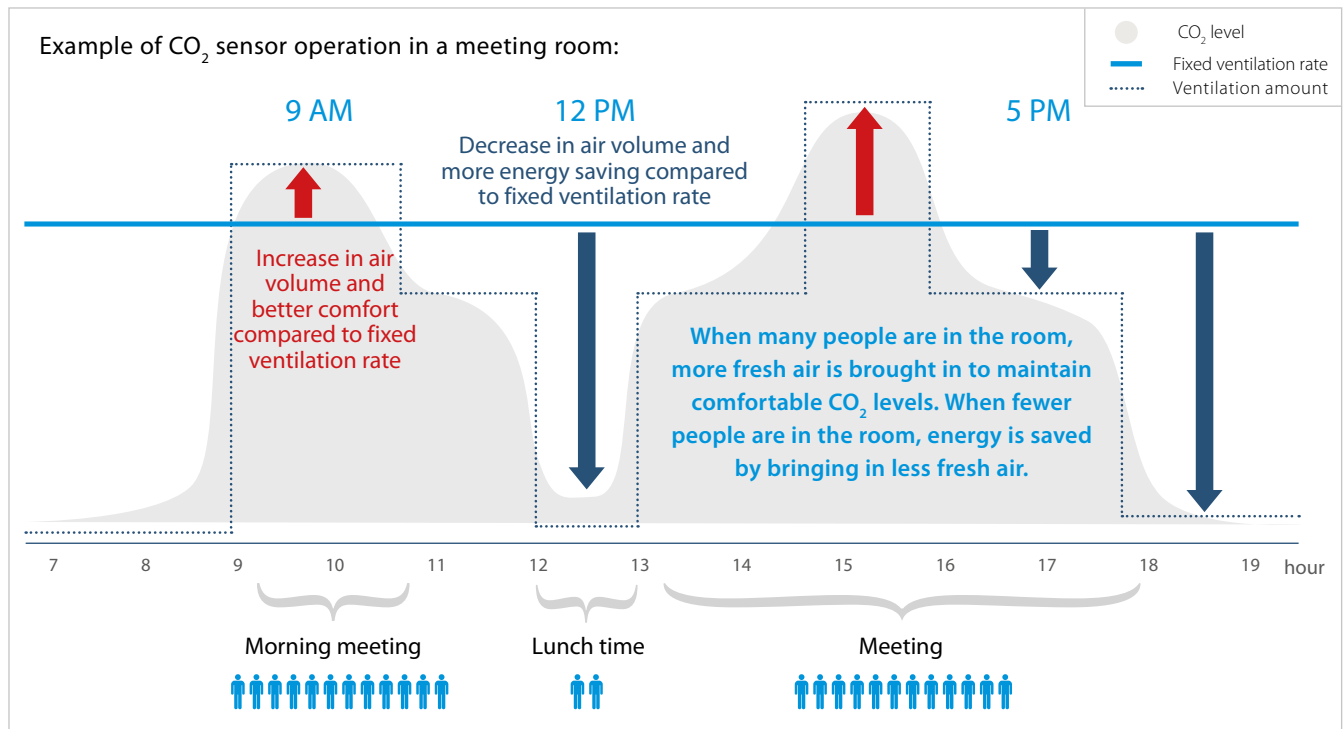

Using CO<sub>2</sub> sensors has the most energy-saving potential in buildings where occupancy fluctuates during a 24-hour period, is unpredictable and peaks at a high level. For example office buildings, government facilities, retail stores and shopping malls, movie theaters, auditoriums, schools, entertainment clubs and nightclubs. The ventilation unit's reaction to fluctuations in CO<sub>2</sub> can be easily adjusted by the customer.

## All ventilation units fully eco design compliant

From 01/01/2013 all ventilation units from 125 W to 500 kW have to comply to the LOT 11 Eco design requirements on fan motors. As market leader Daikin takes the step to comply with all ventilation units to this by adopting DC fan motors in all ventilation units in scope of this legislation, improving their energy efficiency even further.



## Ideal solution for shops, restaurants or offices requiring maximum floor space for furniture, decorations and fittings

Our HRV range of units are not only energy efficient, they also blend in any interior and leave all the maximum of usable floor space. The units are invisible to see and can be installed in service spaces, making service possible while the building is in operation.

# High quality indoor air

## Benefits for end users

### Creating a high quality environment

Maintain a comfortable indoor environment without fluctuations in room temperature.

How do the HRV units work?

In heating

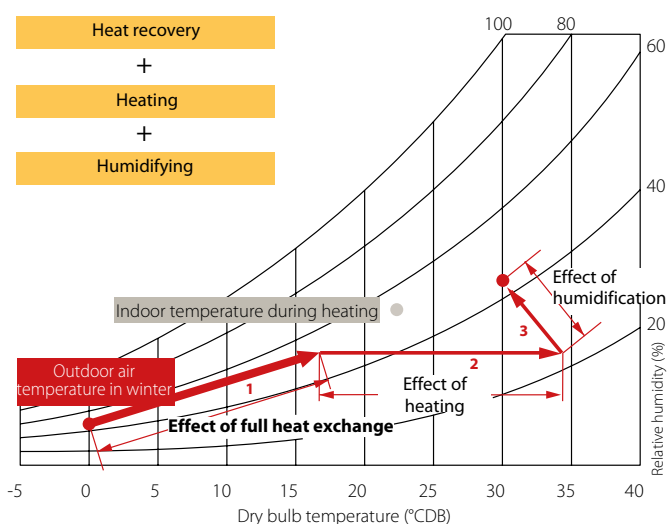

In cooling

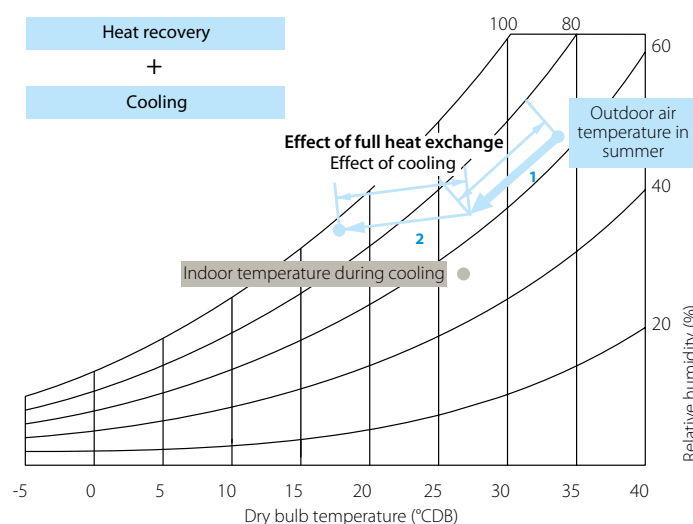

In heating we bring in cold outdoor fresh air and want to avoid cold draught and dry air.	In cooling we bring in hot outdoor fresh air and want to prevent additional load on the air conditioning system and too hot indoor temperatures.
<p><b>1.</b> Cold outside air is crossed with hot inside air.</p> <p>In the example the incoming air is heated up from 0 to 16°CDB while keeping the same relative humidity. This is the effect of the heat and moisture exchange.</p>	<p><b>1.</b> Hot outside air is crossed with cold inside air.</p> <p>In the example the incoming air is cooled down from 34 to 27°CDB while keeping the same relative humidity. This is the effect of the heat and moisture exchange.</p>
<p><b>2.</b> The DX coil further heats up the air to prevent cold draught.</p> <p>In the example the incoming air is further heated from 16 to 34°CDB. Because the air is heated up the relative humidity decreases.</p>	<p><b>2.</b> The DX coil further cools down the air to prevent hot indoor temperatures and reduce the load on the air conditioning system.</p> <p>In the example the incoming air is further cooled down from 27 to 18°CDB.</p>
<p><b>3.</b> To counter negative effects of dry air the air passes the humidifier which adds moisture in case needed.</p> <p>In the example the relative humidity rises from 22 to a comfortable 42%.</p>	<p><b>3.</b> No humidification is needed in cooling as the air is not dried out</p>
<b>The result is incoming fresh air with the same humidity and slightly higher temperature for perfect comfort.</b>	<b>The result is incoming fresh air with a slightly lower temperature for perfect comfort.</b>

## Operation of humidification and air processing in heating mode (VKM-GBM)

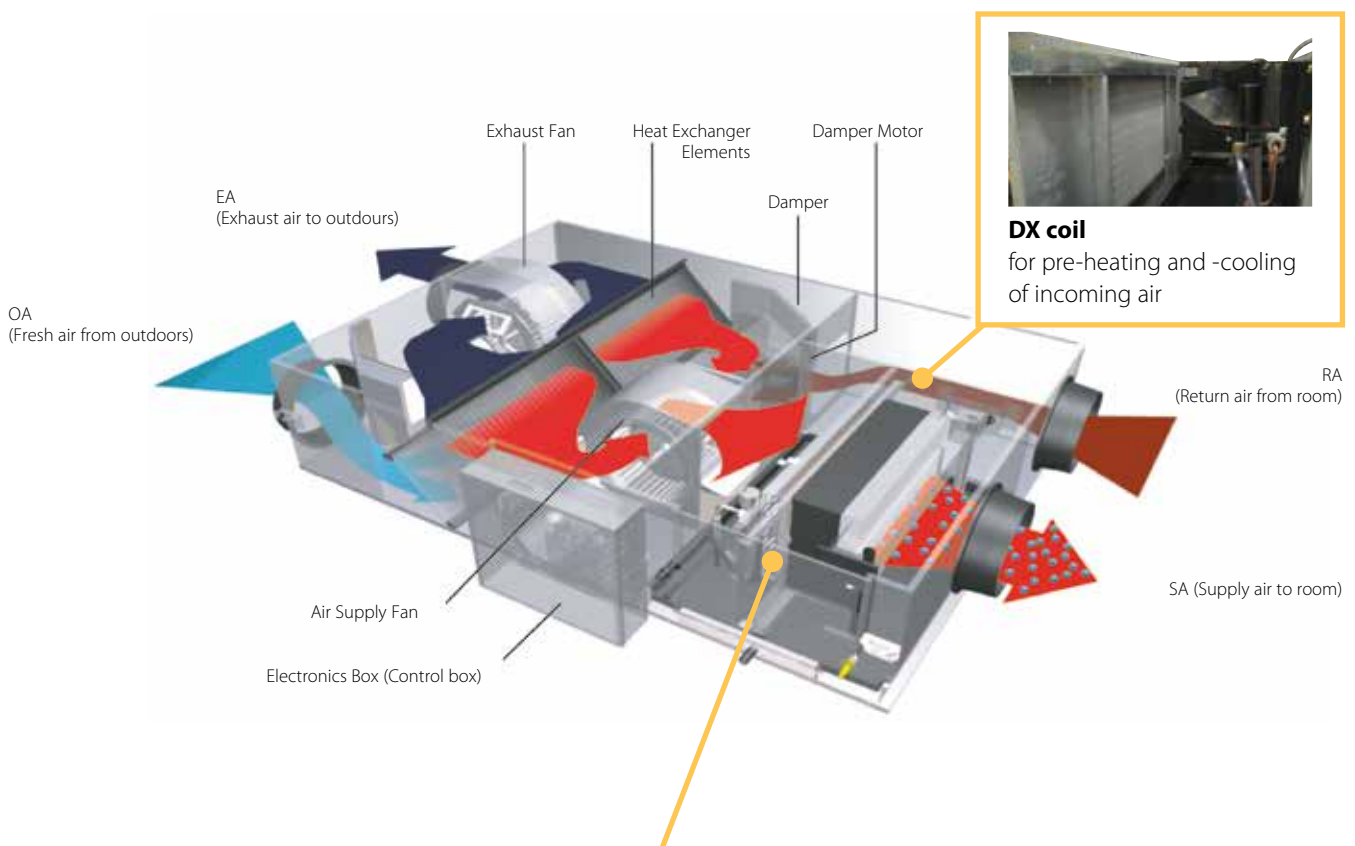

### Humidifier element:

Utilizing the principle of capillary action, water is permeated throughout the humidifier element. The heated air from the DX coil passes through the humidifier and absorbs the moisture.

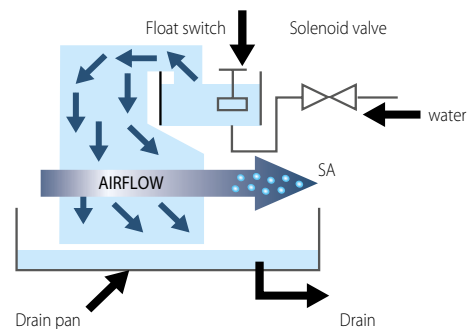

## Optional medium and fine dust filters available

M6, F7 and F8 filters are available on the VAM-FB models to meet your customer request or the local legislation.

As one has no control of the air quality in the building surroundings, you can rely on one of our dust filters to ensure the best indoor air quality possible.



The optional filter comply with  
**EN779:2012**

# Can operate in over and underpressure to prevent unpleasant odours

The user can select 2 fresh-up modes via the remote control for a more comfortable air environment.

## 1. Supply rich mode (overpressure):

A higher air supply than air exhaust maintains proper room pressure to prevent back-flow of toilet/kitchen odours or moisture inflow.

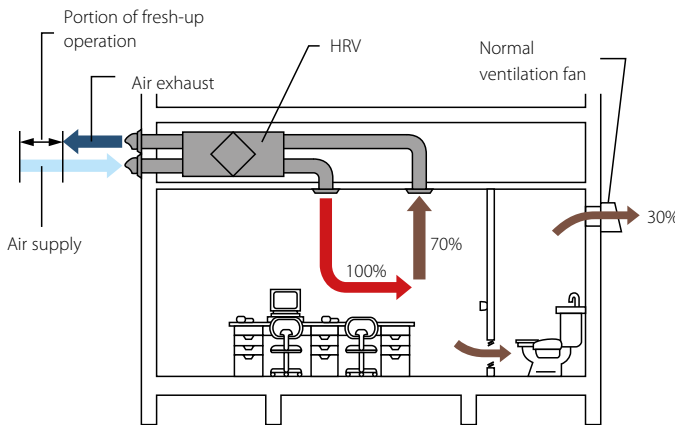

eg. Office  
Preventing that toilet odours flow to the office

## 2. Exhaust fresh-up (underpressure):

A higher exhaust air than air supply decreases room pressure to prevent the leaking of odours or floating bacteria into other rooms.

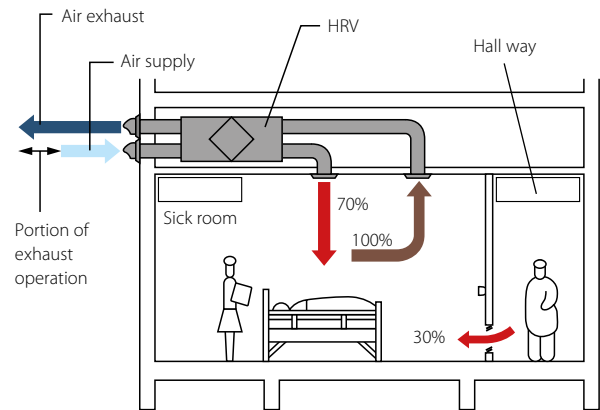

eg. Hospital  
No bacteria can flow from the sick room to the hall way

# Low operation sound level

Continues research by Daikin into reducing operation sound levels has resulted in sound pressure levels down to 20.5dBA (VAM150FA).

Daikin indoor units



DBA	PERCEIVED LOUDNESS	SOUND
0	Threshold of hearing	-
20	Extremely soft	Rustling leaves
40	Very soft	Quiet room
60	Moderately loud	Normal conversation
80	Very loud	City traffic noise
100	Extremely loud	Symphonic orchestra
120	Threshold of feeling	Jet taking off

# Maximum flexibility

## Benefits for design offices and consultants

One Stop shop

### Total solution concept - integrated ventilation

The integration of ventilation into a total building climate system, such as the VRV system, offers numerous advantages. Daikin supplies all components of the entire system, simplifying its design and presenting an ideal solution for the building itself and a 'one-stop' solution for the client.

As well as design benefits, it also simplifies project follow-up, installation and subsequent commissioning and maintenance since only one party is involved.

Finally, the end user benefits from 'interlocking' ventilation with air conditioner operation by virtue of greatly simplified overall system control.

Note: more information on integrated control can be found in the control systems chapter.

### Flexible installation

#### Slim Design

The slim design of the HRV unit enables it to be mounted in narrow ceiling voids and irregularly shaped spaces.



VAM250FA

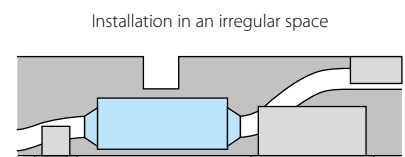
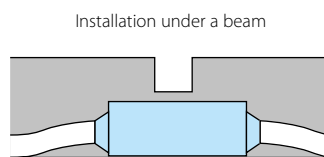
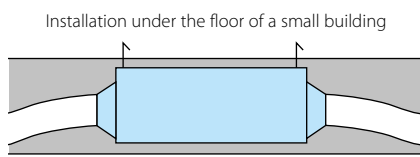

#### Horizontal or vertical installation

The VAM units can be installed horizontal in false ceilings for example. However if there are no false ceilings or the space is limited the unit can also be installed vertically in narrow service spaces or behind a wall. In this way the the consultant can focus fully on the design of the building.

## High Static Pressure

External static pressure (ESP) up to 157 Pa facilitates the use with flexible ducts of varying lengths.

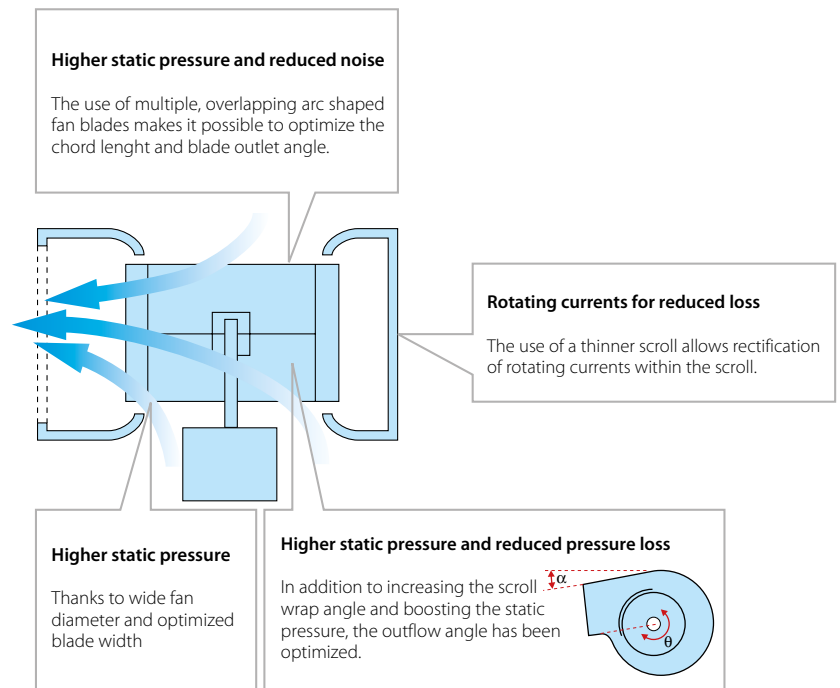

## Wide range of units

The wide Daikin range ensures correct equipment design and sizing.

## Wide operation range

The HRV unit can be installed practically anywhere.

The standard operation range (outdoor temperature) is from -15°C to 40°CDB (50°CDB for VAM units) and can be extended down if a Daikin pre-heater is installed.



<sup>1</sup> Contact your local dealer for more information and restrictions

Daikin's supplied electrical heater VH provides a total solution for fresh air and pre-heating.

- Integrated electrical heater concept (no additional accessories required)
- Standard dual flow and temperature sensor
- Flexible setting with adjustable setpoint
- Increased safety with 2 cut-outs: manual & automatic
- BMS integration thanks to:
  - volt free relay or error indication
  - 0-10V DC input for setpoint control

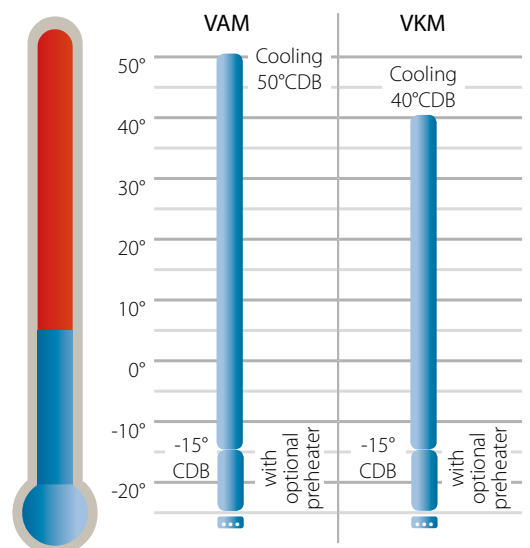



## Ensure the most efficient selection via the selection software

The selection software Daikin supplies enables you to make the most optimum selection in the shortest possible time. The software proposes the best suited unit based upon the climate, building and applied ducting and proposes any needed accessories (electrical heater, ...).

## Connection to field-supplied booster fan increases flexibility even more

- Allows the installation to be adapted exactly to the installation space, filters, comfort, sound requirements and energy use
- Longer ducting or use of central duct possible
- Overcomes actual field situation when ducting is different from calculation
- Lower cost by using the booster fan instead of replacing with a larger unit when the ESP is not matched
- Can solve limited mounting space for larger VAM1500-2000 units

Example when HRV ESP is not high enough or field situation differs from calculation

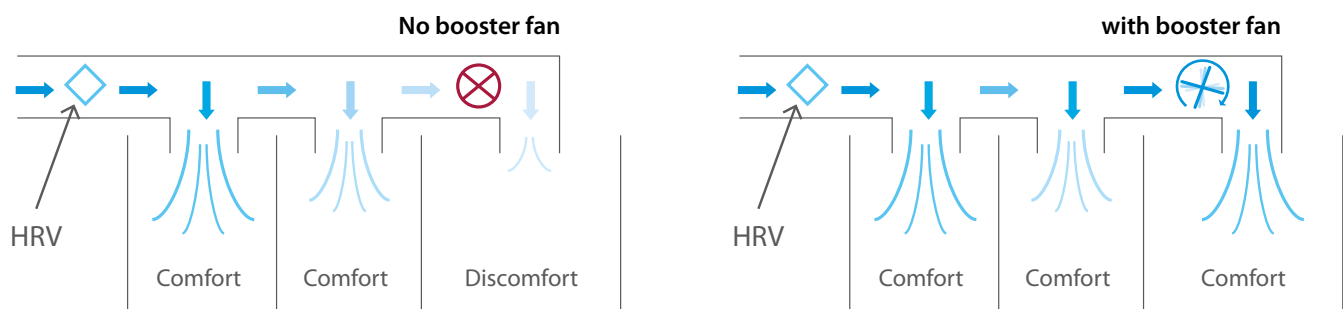

The furthest room is not well ventilated because the unit's ESP is too low for the actual field situation. This is overcome with the additional booster fan.

# Benefits for installers

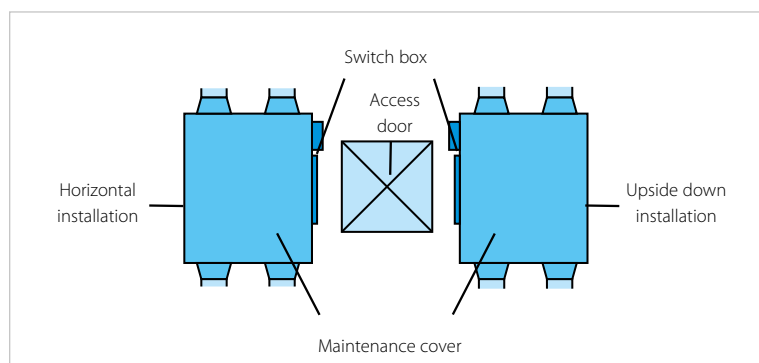

## Simple Design and Construction

The unit can be installed either horizontally or upside down always allowing easy access for inspection and maintenance.

A 450 mm square inspection hatch enables maintenance and heat exchange element replacement to be performed with ease.

## No drain needed

For the VAM-FA/FB models no drain piping is needed, meaning there additional flexibility for the installation of the units.



VAM800FB

## Specifications

VENTILATION				VAM150FA	VAM250FA	VAM350FB	VAM500FB	VAM650FB	VAM800FB	VAM1000FB	VAM1500FB	VAM2000FB		
Power input - 50Hz	Heat exchange mode	Nom.	Ultra high	kW	0.116	0.141	0.132	0.178	0.196	0.373	0.375	0.828	0.852	
	Bypass mode	Nom.	Ultra high	kW	0.116	0.141	0.132	0.178	0.196	0.373	0.375	0.828	0.852	
Temperature exchange efficiency - 50Hz	Ultra high/High/Low			%	74/74/79	72/72/77	75/75/80	74/74/77		74/74/76	75/75/76.5	75/75/78		
	Enthalpy exchange efficiency - 50Hz	Cooling	Ultra high/High/Low		%	58/58/64	58/58/62	61/61/67	58/58/63		60/60/62	61/61/63	61/61/64	61/61/66
Heating		Ultra high/High/Low		%	64/64/69	64/64/68	65/65/70	62/62/67	63/63/66	65/65/67	66/66/68		66/66/70	
Operation mode				Heat exchange mode / Bypass mode / Fresh-up mode										
Heat exchange system				Air to air cross flow total heat (sensible + latent heat) exchange										
Heat exchange element				Specially processed non-flammable paper										
Casing	Material			Galvanised steel plate										
Dimensions	Unit	HeightxWidthxDepth	mm	285x776x525			301x828x816			364x1,004x868		364x1,004x1,156	726x1,512x868	726x1,512x1,156
Weight	Unit			24			33			52	55	64	131	152
Fan-Air flow rate - 50Hz	Heat exchange mode	Ultra high	m³/h	150	250	350	500	650	800	1,000	1,500	2,000		
	Bypass mode	Ultra high	m³/h	150	250	350	500	650	800	1,000	1,500	2,000		
Fan-External static pressure - 50Hz	Ultra high		Pa	69	64	98		93	137	157	137			
Sound pressure level - 50Hz	Heat exchange mode	Ultra high	dBA	27 / 28.5	28 / 29	32	33	34.5	36		39.5	40		
	Bypass mode	Ultra high	dBA	27 / 28.5	28 / 29	32	33.5	34.5	36		40.5	40		
Operation range	Min.		°CDB	-15										
	Max.		°CDB	50										
	Relative humidity		%	80% or less										
Connection duct diameter	mm			100	150		200		250		350			
Air filter	Type			Multidirectional fibrous fleeces										
Power supply	Phase/Frequency/Voltage			1~/50/60/220-240/220										
Current	Maximum fuse amps (MFA)			15				16						

### Total solution for fresh air with Daikin supply of both VAM and electrical heaters

- › Increased comfort in low outdoor temperature thanks to the heated outdoor air
- › Integrated electrical heater concept (no additional accessories required)
- › Standard dual flow and temperature sensor
- › Flexible setting with adjustable setpoint
- › Increased safety with 2 cut-outs: manual & automatic
- › BMS integration thanks to:
  - Volt free relay for error indication
  - 0-10V DC input for setpoint control
- › Capacities ranging from 1 to 2.5 kW



VH Electrical heater for VAM



VKM80-100GB(M)

### Specifications

VENTILATION				HEAT RECLAIM VENTILATION, AIR PROCESSING AND HUMIDICATION			HEAT RECLAIM VENTILATION AND AIR PROCESSING			
				VKM50GBM	VKM80GBM	VKM100GBM	VKM50GB	VKM80GB	VKM100GB	
Power input - 50Hz	Heat exchange mode	Nom.	Ultra high	kW	0.270	0.330	0.410	0.270	0.330	0.410
	Bypass mode	Nom.	Ultra high	kW	0.270	0.330	0.410	0.270	0.330	0.410
Fresh air conditioning load	Cooling			kW	4.71 / 1.91 / 3.5	7.46 / 2.96 / 5.6	9.12 / 3.52 / 7.0	4.71 / 1.91 / 3.5	7.46 / 2.96 / 5.6	9.12 / 3.52 / 7.0
	Heating			kW	5.58 / 2.38 / 3.5	8.79 / 3.79 / 5.6	10.69 / 4.39 / 7.0	5.58 / 2.38 / 3.5	8.79 / 3.79 / 5.6	10.69 / 4.39 / 7.0
Temperature exchange efficiency - 50Hz	Ultra high/High/Low			%	76/76/77.5	78/78/79	74/74/76.5	76/76/77.5	78/78/79	74/74/76.5
Enthalpy exchange efficiency - 50Hz	Cooling		Ultra high/High/Low	%	64/64/67	66/66/68	62/62/66	64/64/67	66/66/68	62/62/66
	Heating		Ultra high/High/Low	%	67/67/69	71/71/73	65/65/69	67/67/69	71/71/73	65/65/69
Operation mode	Heat exchange mode / Bypass mode / Fresh-up mode									
Heat exchange system	Air to air cross flow total heat (sensible + latent heat) exchange									
Heat exchange element	Specially processed non-flammable paper									
Humidifier	System			Natural evaporating type						
Casing	Material			Galvanised steel plate						
Dimensions	Unit	HeightxWidthxDepth	mm	387x1,764x832	387x1,764x1,214		387x1,764x832	387x1,764x1,214		
Weight	Unit		kg	100	119	123	94	110	112	
Fan-Air flow rate - 50Hz	Heat exchange mode	Ultra high	m <sup>3</sup> /h	500	750	950	500	750	950	
	Bypass mode	Ultra high	m <sup>3</sup> /h	500	750	950	500	750	950	
Fan-External static pressure - 50Hz	Ultra high		Pa	200	205	110	210		150	
Sound pressure level - 50Hz	Heat exchange mode	Ultra high	dBA	38	40		39	41.5	41	
	Bypass mode	Ultra high	dBA	39	41		40	41.5	41	
Operation range	Around unit		°CDB							
	Supply air		°CDB							
	Return air		°CDB							
	On coil temperature		Cooling	Max.	°CDB					
		Heating	Min.	°CDB						
Refrigerant	Type			R-410A						
Connection duct diameter	mm			200	250		200	250		
Piping connections	Liquid	OD	mm	6.35						
	Gas	OD	mm	12.7						
	Water supply		mm	6.4			-			
	Drain			PT3/4 external thread						
Air filter	Type			Multidirectional fibrous fleeces						
Power supply	Phase/Frequency/Voltage			Hz/V						
Current	Maximum fuse amps (MFA)			A						
				15						

# FXMQ-MF

## Outdoor Air Processing Unit

### **Combined fresh air treatment and air conditioning via a single system**

Both fresh air treatment and air conditioning can be achieved successfully in a single system via heat pump technology. This without the usual design problems associated with balancing air supply and discharge. Air conditioning indoor units and an outdoor air processing units can be connected to the same refrigerant circuit, resulting in enhanced design flexibility and a significant reduction in total system costs.

# Ventilation & air processing

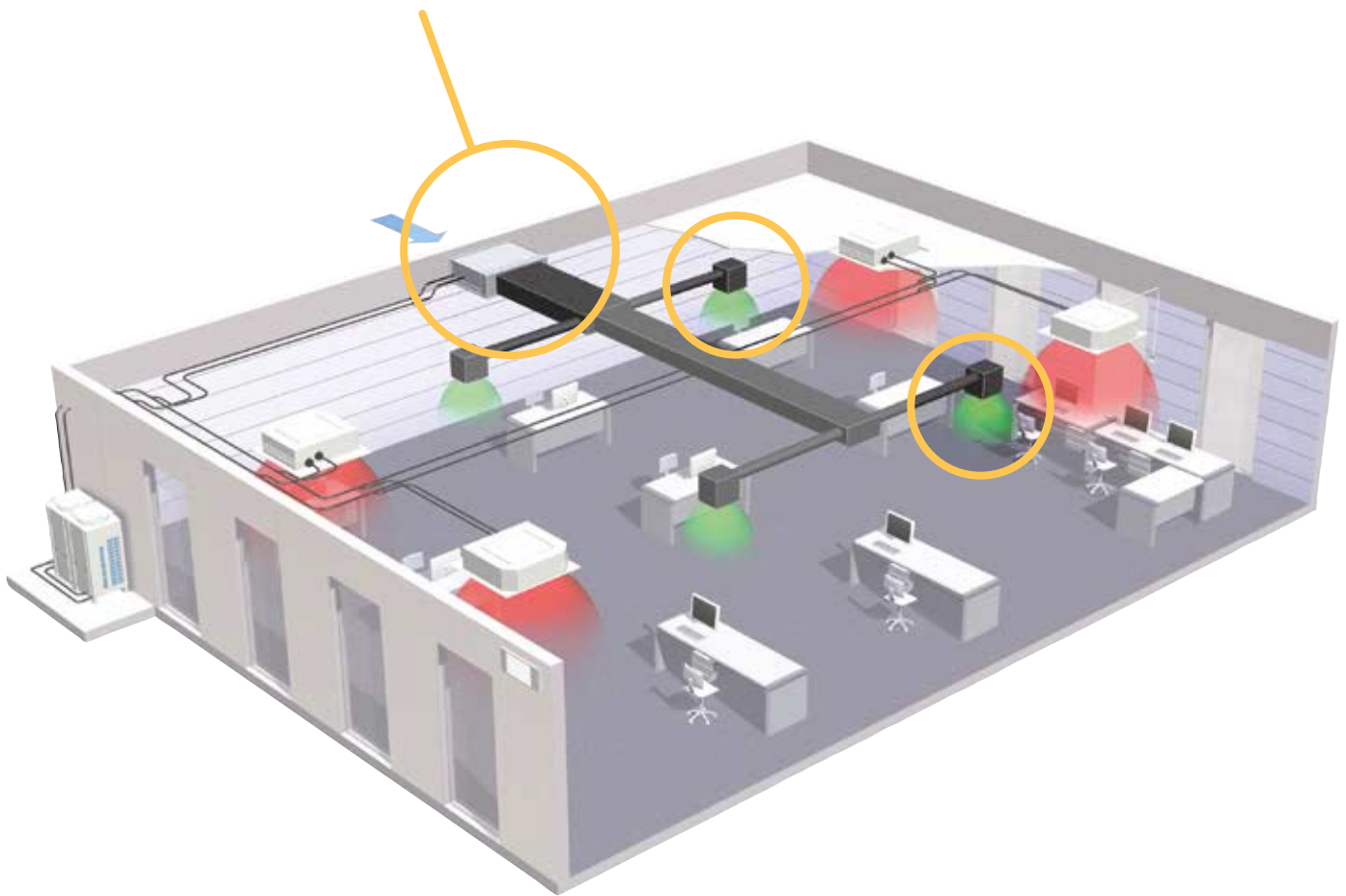

# Benefits

## 100% Fresh Air Intake Possible

Outdoor air processing units can be used exclusively to provide 100% fresh air into the building. Even if only partly used the system reduces the load on the air conditioner by adjusting the outdoor air temperature via fixed discharge temperature control.

## Leaving maximum floor and wall space for furniture, decoration and fittings

## Wide operation range

The outdoor air processing unit can be installed practically anywhere. The unit operates at outdoor ambients up to 43°C in cooling mode and down to -5°C in heating mode.

## High static pressure

External static pressure (ESP) up to 225 Pa allows the use of extensive ductwork runs and facilitates the use with flexible ducts of varying lengths. Ideal for use in large areas.

## Built-in drain pump

A drain pump kit increases the reliability of the drain system <sup>1</sup>

<sup>1</sup> Drain pump kit available as accessory

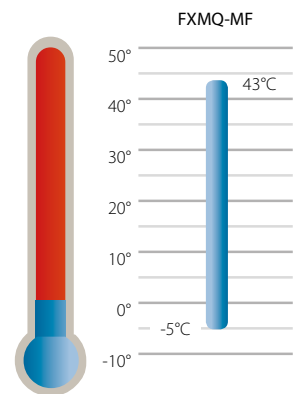

# Connection conditions

- › The total connected capacity of the standard indoor units and fresh air treatment units must be between 50% and 100% of the capacity of the air conditioning outdoor units. The connected capacity of the fresh air treatment units must not exceed 30% of the capacity of the air conditioning outdoor units.
- › A fresh air treatment unit can also be used exclusively. The connected capacity of the fresh air treatment unit must be between 50% and 100% of the capacity of the air conditioning outdoor unit.
- › Not connectable to VRVIII-S

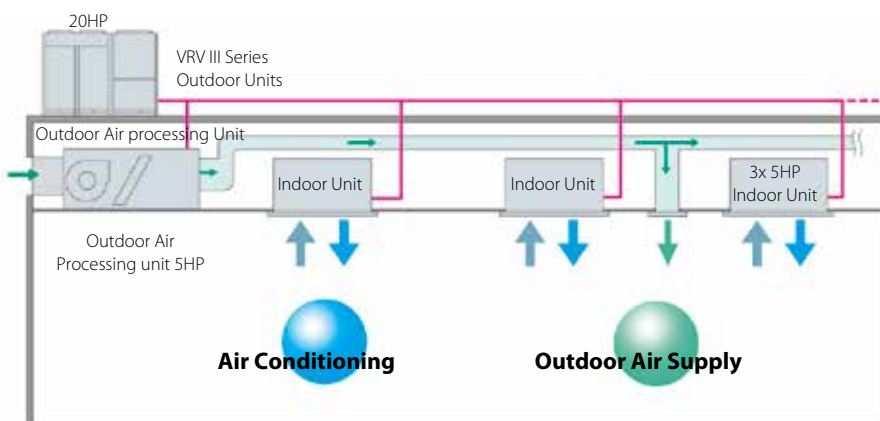

# FXMQ-MF

125, 200, 250

Outdoor air processing unit, ventilation and air processing



FXMQ200-250MF

## Specifications

VENTILATION & AIR PROCESSING				FXMQ125MF	FXMQ200MF	FXMQ250MF
Cooling capacity	Nom.		kW	14.0	22.4	28.0
Heating capacity	Nom.		kW	8.9	13.9	17.4
Power Input (50Hz)	Cooling	Nominal	kW	0.359	0.548	0.638
	Heating	Nominal	kW	0.359	0.548	0.638
Dimensions	Unit	HeightxWidthxDepth	mm	470x744x1,100		470x1,380x1,100
Weight	Unit		kg	86	123	
Air Flow Rate	Cooling		m <sup>3</sup> /min	18		35
	Heating		m <sup>3</sup> /min		-	
External Static Pressure	Standard		Pa	185	225	205
Refrigerant	Type			R-410A		
Sound Power	Cooling	Nominal	dB(A)		-	
Sound Pressure	Cooling	Nominal (220V)	dB(A)	42		47
Operation range	On coil temperature	Cooling	max. °CDB		43	
		Heating	min. °CDB		-5	
Piping connections	Liquid	OD	mm		9.52	
	Gas	OD	mm	15.9	19.1	22.2
	Drain				PS1B	
Power supply	Phase / Frequency / Voltage		Hz / V	1~ / 50 / 220-240		



User friendly

# control systems





## Interlock of the ventilation operation with the air conditioner operation

Interlock of the ventilation operation with the air conditioner operation greatly simplifies overall system control. The same remote control centralizes air conditioning and ventilation. Using a centralized remote control also frees the user to choose from a wide range of control systems that integrate air conditioning and ventilation. By incorporating a variety of centralized control equipment, the user can build a large, high grade centralized control system.

<sup>1</sup>Linked control of FXMQ-MF and HRV is not supported

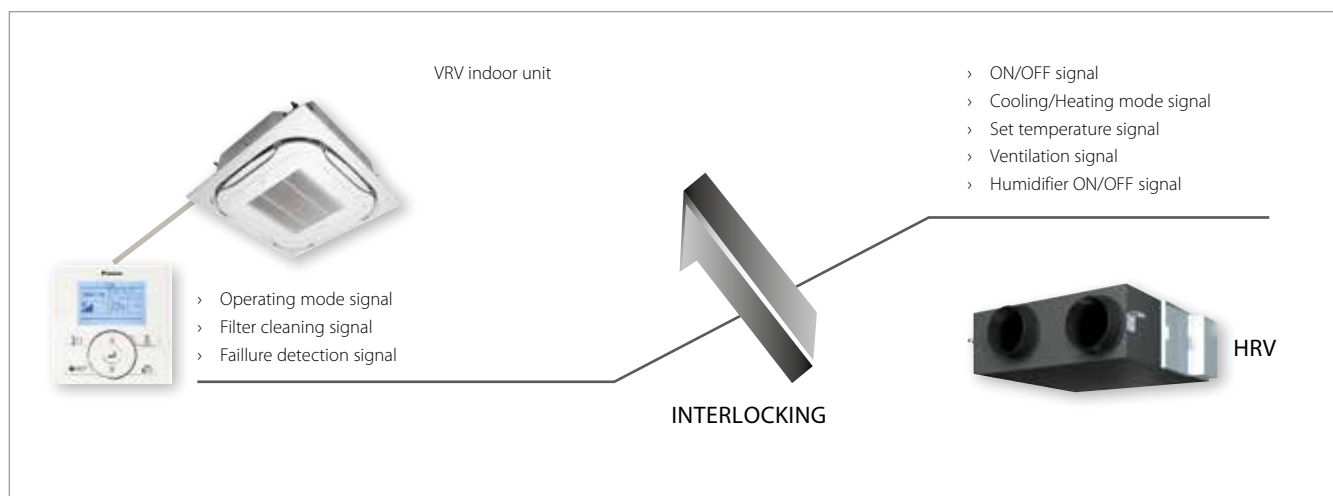

## “Super Wiring” System

A Super Wiring system is used to enable the shared use of wiring between indoor units, outdoor units and the centralised remote control.

This system makes it easy for the user to retrofit the existing system with a centralised remote control, simply by connecting it to the outdoor units.

Thanks to a non polarity wiring system, incorrect connections become impossible and installation time is reduced.

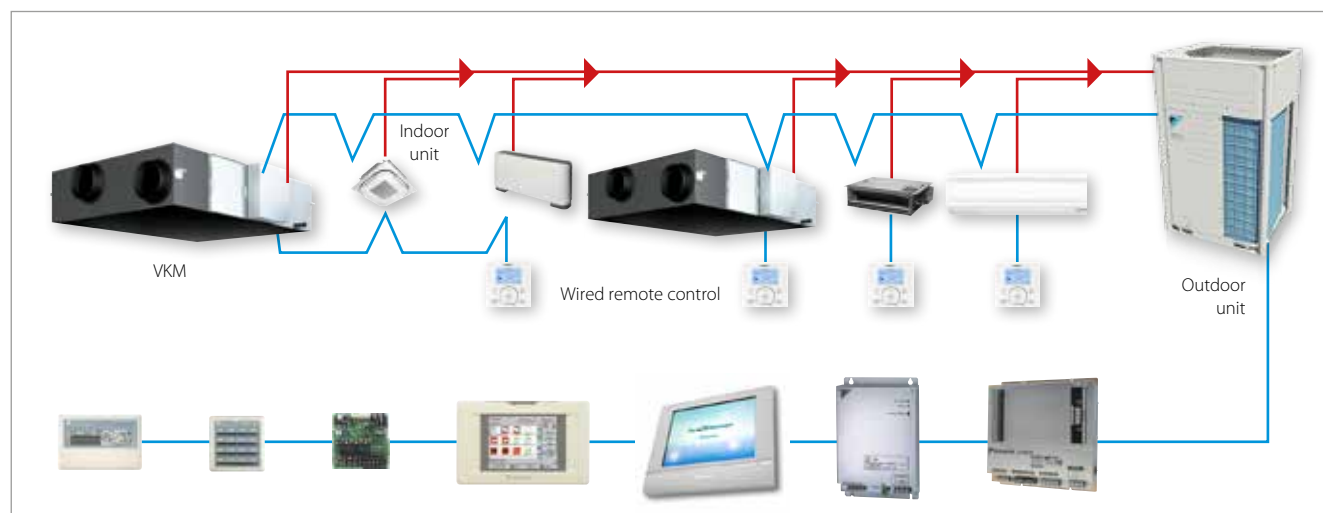

# Overview of control systems

## Individual Control Systems

5 individual control systems give the user control over the VRV system and the combined ventilation.

- › BRC1D52 and BRC1E52A/B are wired remote controllers, giving access to room temperature settings, schedule timer, ... Next to that they also have user friendly HRV functions.
- › BRC301B61 is a wired controller especially designed for VAM units.
- › BRC2C51 and BRC3A61 are compact, easy to use remote controllers, ideal for use in hotel bedrooms.



VAM remote control  
BRC301B61



Wired remote control  
BRC1E52A/B



Wired remote control  
BRC1D52

## Centralised control systems

By combining the (optional) centralised control equipment listed below, the user can achieve a wide range of comprehensive centralised control systems for air conditioning and ventilation.



Centralised remote control  
DCS302C51



Unified ON/OFF control  
DCS301B51



Schedule timer  
DST301B51



## Network solutions

HRV and the Outdoor Air Processing unit are connectable to all current Daikin network solutions:

### **DTA113B51**

Basic solution for control (Sky Air and VRV).

### **DCS601C51**



Allows detailed and easy monitoring and operation of VRV systems (maximum 2 x 64 control groups).

### **DCM601A51**



The ideal solution for full control and management of maximum 1,024 VRV indoor units.

### **DMS504B51**

#### **LonWorks Interface**

Open network integration of VRV monitoring and control functions into LonWorks networks.

### **DMS502A51**

#### **BACnet Interface**

Integrated control system for seamless connection between VRV and BMS systems.

## Other integration devices

Daikin's adapter PCB's provide simple solutions for unique requirements. They are a low-cost option to satisfy simple control requirements and can be used on single or multiple units.



Wiring adapter for electrical appendices

- Start and stop up to 16 indoor units remotely (1 group) (KRP2A\* via P1 P2)
- Alarm indication / fire shut-down
- Remote temperature set-point adjustment

KRP2A\*

For more information consult the Daikin controls systems brochure or contact your local dealer



# Individual control systems

- › Control up to 16 indoor units or 8 HRV units (1group)
- › Easy to use: all main functions directly accessible
- › Easy setup: improved graphical user interface for advanced menu settings
- › Simultaneous ON/OFF of HRV and air conditioner (BRC1D52/BRC1E52A/B)
- › Airflow rate switching (initial setting)
- › Ventilation mode switching (initial setting)
- › Self diagnostic functions
- › Filter sign display and reset
- › Timer settings, simultaneous control with air conditioner (BRC1D52/BRC1E52A/B)
- › ON/OFF of VAM (BRC301B61)
- › Independent operation of HRV
- › Timer settings (BRC301B61)
- › Fresh-up mode switching (HRV only) (Selectable: supply rich mode, exhaust rich mode; initial setting)

**Notes:**

The remote control wired to the FXMQ-MF cannot be set as master remote control. Otherwise, when set to 'auto', the operation mode will switch according to outdoor air conditions, regardless of indoor temperature.



BRC1E52A/B



BRC1D52



BRC301B61

A variety of units can be controlled using only the BRC1D52 or the BRC1E51A (HRV only)

› **Group Control**

One air conditioner remote control simultaneously controls up to 16 air conditioning and HRV units.

› **Control using 2 remote controls**

Allows control of air conditioning and HRV units from two locations by connecting two air conditioner remote controls. (group control is possible)

› **Long-distance Remote Control**

Remote operation control - from a distant control room for example - is possible thanks to wiring of up to 500 m. (2 remote controllers possible)

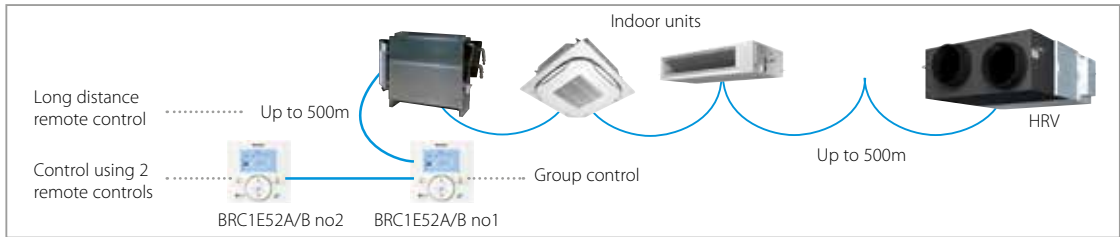

\*1: Count VKM unit as two air conditioner indoor units. For details, see below.

System construction (HRV only)		System Characteristics	Necessary Accessories																						
Air conditioning interlocked control (VRV, Sky Air) system	Independent Operation system	<ul style="list-style-type: none"> <li>› Independent operation of HRV is possible</li> <li>› Operation is possible using 2 remote controls</li> <li>› Multiple HRV units can be simultaneously controlled in batch. (Up to 8 HRV units can be connected)</li> <li>› Air conditioner remote control can be used</li> </ul>	BRC1D52 or BRC1E52A/B BRC301B61 *																						
	Standard system	<p>During group control operation, the VKM unit has a capacity equivalent to 2 standard indoor units. Up to 16 standard indoor units can be connected at the same time.</p> <table border="1"> <tr> <td>Connectable indoor units:</td> <td>VKM</td> <td>0</td> <td>1</td> <td>2</td> <td>3</td> <td>4</td> <td>5</td> <td>6</td> <td>7</td> <td>8</td> </tr> <tr> <td></td> <td>Max.no.of VRV</td> <td>16</td> <td>14</td> <td>12</td> <td>10</td> <td>8</td> <td>6</td> <td>4</td> <td>2</td> <td>0</td> </tr> </table> <p>Note: The VKM uses 2 remote controller addresses per unit. The number of units that can be group controlled is shown above.</p> <ul style="list-style-type: none"> <li>› Multiple VRV indoor units or HRV units can be connected and controlled in batches, with interlocked operation of HRV and air conditioners by using the air conditioner remote control.</li> <li>› The HRV unit can also be operated independently using the remote control for the indoor unit, even if the indoor unit is not in operation</li> </ul>	Connectable indoor units:	VKM	0	1	2	3	4	5	6	7	8		Max.no.of VRV	16	14	12	10	8	6	4	2	0	BRC1D52 or BRC1E52A/B
	Connectable indoor units:	VKM	0	1	2	3	4	5	6	7	8														
	Max.no.of VRV	16	14	12	10	8	6	4	2	0															
Multiple groups interlocked Operation system	<ul style="list-style-type: none"> <li>› Can control interlocked operation of multiple groups of VRV or Sky Air indoor units</li> <li>› When one of the multiple groups operates, HRV units are interlocked and operate simultaneously</li> </ul>	BRC1D52 or BRC1E52A/B																							

\* BRC301B61 only available for VAM-FA/FB

# Centralised control systems

By combining the (optional) centralised control equipment listed below, the user can achieve a wide range of comprehensive centralised control systems for air conditioning and ventilation.

## DCS302C51



### Centralised remote control - DCS302C51

- › A maximum of 64 groups (128 indoor units, max. 10 outdoor units) can be controlled
- › A maximum of 128 groups (128 indoor units, max. 10 outdoor units) can be controlled via 2 centralised remote controls in separate locations
- › Group control (up and down buttons are added for group selection)
- › Zone control
- › Malfunction code display
- › Max. wiring length 1,000 m (total : 2,000 m)
- › Combination with unified ON/OFF control, schedule timer and BMS system
- › Airflow volume and direction can be controlled individually for indoor units in each group operation.
- › Ventilation volume and mode can be controlled for Heat Reclaim Ventilation (VKM).
- › Up to 4 'operation/stop' pairs can be set per day by connecting a schedule timer.

## DCS301B51



### Unified on/off control - DCS301B51

Providing simultaneous and individual control on 16 groups of indoor units

- › A maximum of 16 groups (128 air conditioning indoor and HRV units) can be controlled
- › 2 remote controls in separate locations can be used
- › Centralised control indication
- › Maximum wiring length of 1,000m (total: 2,000m)

## DST301B51



### Schedule timer - DST301B51

Enabling 64 groups to be programmed

- › A maximum of 128 air conditioning indoor and HRV units can be controlled
- › 8 types of weekly schedule
- › A maximum of 48 hours back-up power supply
- › Maximum wiring length of 1,000m (total: 2,000m)

## Number of HRV units that can be connected per system

Centralised remote control	2 units
Unified on/off control	8 units
Schedule timer	1 unit

- Note:
- › Group control is not possible between FXMQ-MF and standard type indoor units. Connect remote controllers to each unit.
  - › Not all FXMQ-MF functions are available when using centralised control. Please refer to your local installer for detailed information.
  - › The remote control wired to the FXMQ-MF cannot be set as master remote control. Otherwise, when set to 'auto', the operation mode will switch according to outdoor air conditions, regardless of indoor temperature.
  - › Temperature setting and PPD are not possible, even when Intelligent Touch Controller or Intelligent Manager are installed.

Air Conditioning Interlocked Centralised Control System

Batch / Individual Control System

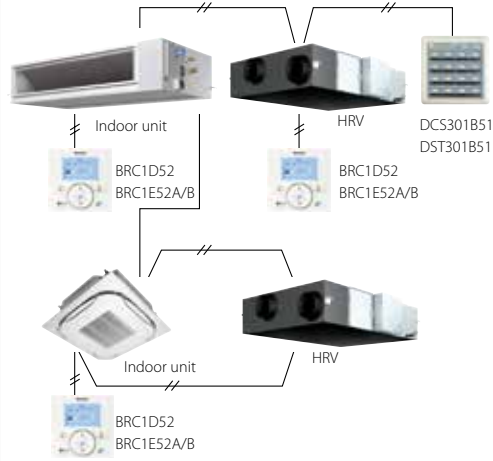

**Unified ON/OFF control - DCS301B51**

- › One controller can control the on/off operation of 16 groups of units collectively or individually
- › Up to 8 controllers can be installed in one centralised transmission line (in one system), which enables control of up to 128 groups. (16 groups x 8 = 128 groups)

**Schedule timer - DST301B51**

- › One schedule timer can control the weekly schedule of up to 128 units
- › HRV remote control can set the individual operation of each HRV unit
- › Control system can be expanded depending on its purposes by combining a variety of centralised control equipment

DCS301B51 or DST301B51, BRC1D52 or BRC1E52A/B  
If necessary: DCS302C51

Zone Control System

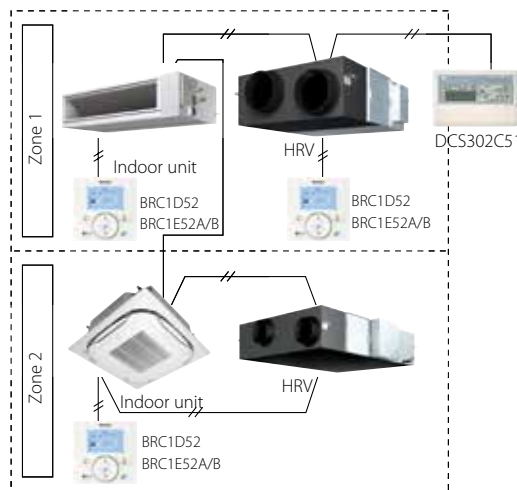

**Centralised remote control - DCS302C51**

- › The centralised remote control provides settings and monitoring functions and can control up to 128 VRV and HRV units. A special adapter is required to connect Sky Air to the centralised line.
- › Control is possible in 3 different patterns: individual, batch or zone
- › Multiple groups can be controlled within the same zone
- › Multiple HRV units can be operated independently
- › System without air conditioning or HRV remote controls can be constructed
- › Control system can be expanded depending on requirements by combining a variety of centralised control systems

DCS302C51, BRC1D52 or BRC1E52A/B  
If necessary: DCS301B51 or DST301B51

Combination with other types of air conditioners

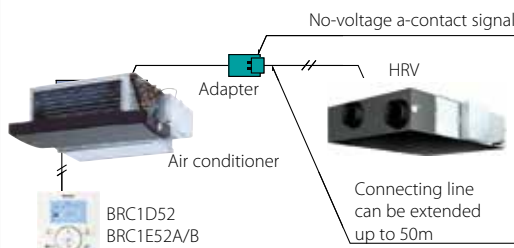

- › Simultaneous operation of HRVs and air conditioners is possible via BRC1D52/ BRC1E52A/B
- › Use of the HRV remote control enables to change settings or operate HRVs independently

Connection adapter (no-voltage-a-contact-signal)

# Daikin air handling units

For small to large commercial spaces Daikin offers a range of R-410A inverter condensing units for use in conjunction with air handling units. In situations where Daikin commercial range ventilation units cannot satisfy the ventilation requirement due to building constraints (large atriums, banquet halls etc), air handling units represent the ideal solution.

Air handling units provide large fresh air volumes (>1,000 m<sup>3</sup>/h) and high ESPs enabling the use of extensive ductwork runs.

An air handler or air handling unit provides a tailor-made solution for optimising air conditions throughout multiple spaces. An air handler can be customised to your building - with no installation restrictions or design limitations - as air handler units are based on a completely unique modular design, so they can be sized (in increments of 1 cm) to your exact requirements.

ASTRA is the powerful software that Daikin has developed to offer a quick and comprehensive service for the customer in order to make the technical choice and the economic valorization of each AHU. It is a complete tool that can configure any type of product and respond exactly to the strictest design needs. The result is a comprehensive economic offer including all the technical data and drawings, the psychrometric diagram with the relative air treatment and the fans' performance curves.

The ASTRA software features a specific DX heat pump coil section able to calculate cooling and heating performances with the automatic selection of the appropriate Daikin expansion valve.



## Wide range of air flows

In situations where the Daikin commercial range of ventilation units cannot satisfy the ventilation requirement due to building constraints (large atriums, banquet halls, etc) air handling units represent the ideal solution. Daikin's wide range of air handling systems handle air flow rates from 500 m<sup>3</sup>/h up to 140,000 m<sup>3</sup>/h. The air handler unit can be adapted to deliver whatever air flow you require, via the specific dimensions of flow section available at the installation.

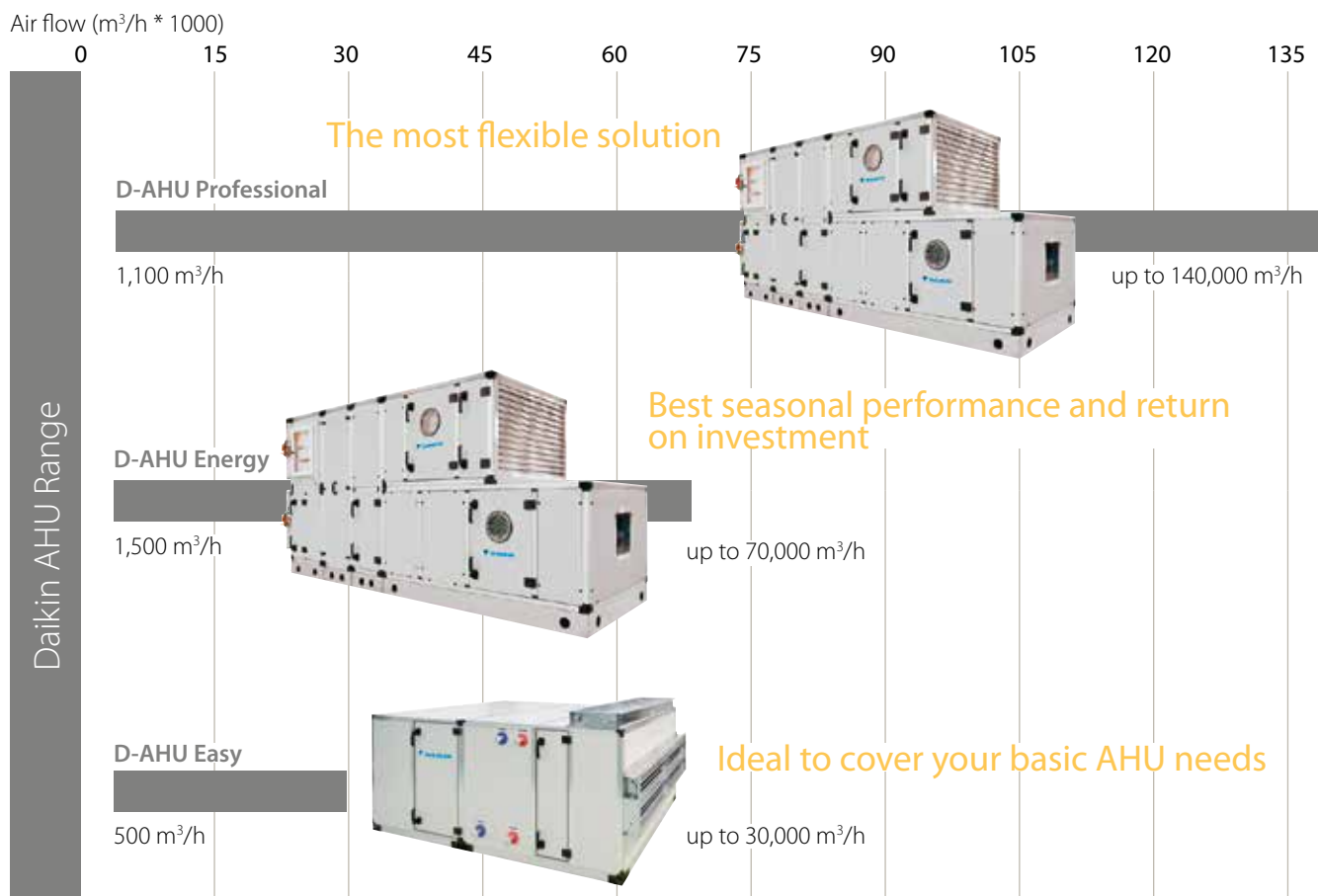

## Daikin fresh air package - plug & play

The D-AHU Professional and Energy series provide a complete solution including unit control (EKEXV, EKEQ, DDC controller) factory mounted and configured, plug & play with our ERQ and VRV condensing units.

The easiest solution as you save time and only have one point of contact!

## Return on investment

The air handling unit (AHU) is critical to an effective climate control system and, although the initial investment can appear high, the savings generated by our advanced designs and operating efficiencies guarantee a rapid return on the investment made. Our AHU Energy series has been designed to deliver exceptional performance thus driving down the energy consumed and so lowering energy

bills. Taken over the expected 15-year life-span of the equipment, this will result in a substantial saving, especially in a time of ever increasing energy prices.

## Pre-defined sizes

27 fixed sizes are available, optimized to reach the best compromise between competitiveness and manufacturing standardisation. However, Daikin's section by section design means that units can be sized by 1cm increments and assembled on site, without welding, to suit the space constraints of the installation.

## High efficiency components

All Daikin air handlers have been designed for optimum energy efficiency. Polyurethane or Mineral wool panels guarantee excellent thermal insulation performance. Filters are provided with a large choice of efficiency filtration class.

# Why use ERQ and VRV condensing units for connection to air handling units?

## High Efficiency

Daikin heat pumps are renowned for their high energy efficiency with COPs up to 4.56 in heating<sup>1</sup>. The VRV range offers both heat pump and heat recovery units with part load efficiencies as high as 9.02. Integrating the AHU with a heat recovery system is highly effective since an office system can frequently be in cooling mode while the outdoor air is too cold to be brought inside in an unconditioned state. In this case heat from the offices is merely transferred to heat up the cold incoming fresh air. In the absence of an AHU this 'free heating' of the incoming fresh air would not be possible.

<sup>1</sup> ERQ100AV1 heat pump

<sup>2</sup> REYQ8P8 50% cooling - 50% heating load. Conditions: outdoor temperature 11°CDB, indoor temperature 18°CWB, 22°CDB

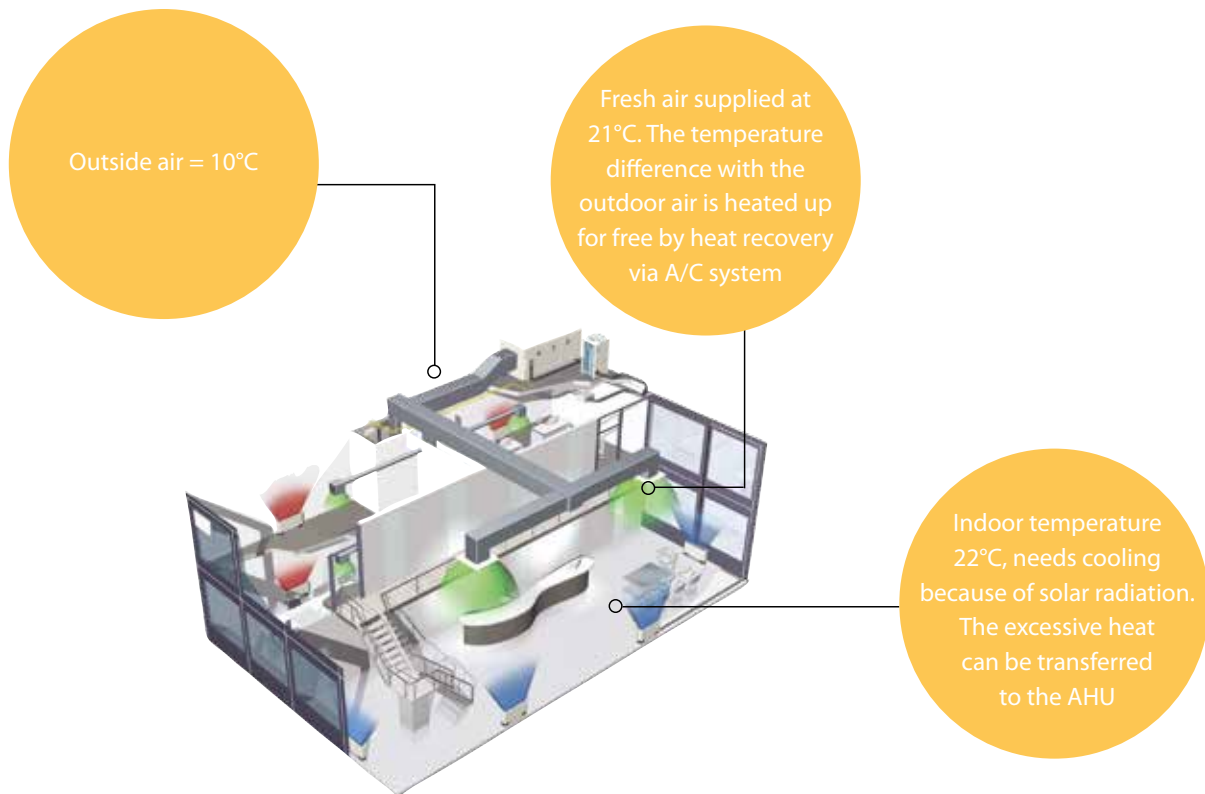

## High Comfort Levels

Daikin ERQ and VRV units respond rapidly to fluctuations in supply air temperature, resulting in a steady indoor temperature and resultant high comfort levels for the end user.

Daikin ERQ and VRV units respond rapidly to fluctuations in the supply air temperature, resulting in a steady indoor temperature, together with the dehumidification this results in high comfort levels for the end user. The ultimate is the VRV range which improves comfort even more by offering continuous heating, also during defrost.

## Easy Design and Installation

The system is easy to design and install since no additional water systems such as boilers, tanks and gas connections etc are required. This also reduces the total system cost.

# Flexible control options

In order to maximize installation flexibility, 3 types of control systems are offered.

**Control X:** Control of air temperature (discharge temperature, suction temperature, room temperature) via external device (DDC controller)

**Control Y:** Control of evaporating temperature via Daikin control (no DDC controller needed)

**Control Z:** Control of air temperature (suction temperature, room temperature) via Daikin control (no DDC controller needed)

## Possibility X (Td/Tr control):

### Air temperature control via DDC controller

Room temperature is controlled as a function of the air handling unit suction or discharge air (customer selection). The DDC controller is translating the temperature difference between set point and air suction temperature (or air discharge temperature or room temperature) into a reference voltage (0-10V) which is transferred to the Daikin control box (EKEQFCBA). This reference voltage will be used as the main input value for the compressor frequency control.

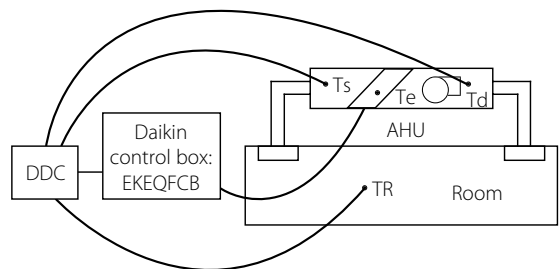

## Possibility Y (Te/Tc control):

### By fixed evaporating temperature

A fixed target evaporating temperature of between 3°C and 8°C can be set by the customer. In this case, room temperature is only indirectly controlled. The cooling load is determined from the actual evaporating temperature (i.e. load to the heat exchanger). A Daikin wired remote controller (BRC1D52 or BRC1E52A/B - optional) can be connected for error indication.

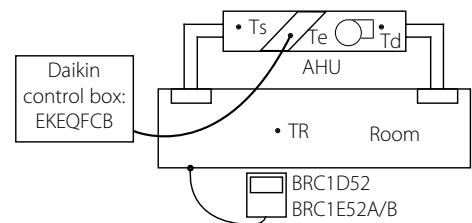

## Possibility Z (TS/Tr control):

### Using Daikin wired remote controller (BRC1D52 or BRC1E52A/B - optional)

Set point can be fixed via standard Daikin wired remote controller. Remote ON/OFF can be achieved by an optional adapter KRP4A51.

No external DDC controller should be connected. The cooling load is determined from the air suction temperature and set point on the Daikin controller.

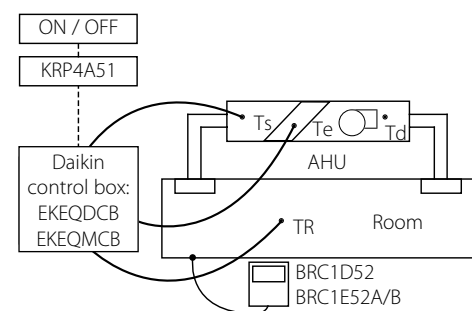

- Ts = Air suction temperature
- Td = Air discharge temperature
- Tr = Room temperature
- Te = Evaporating temperature
- AHU = Air Handling Unit
- DDC = Digital Display Controller

	OPTION KIT	FEATURES
Possibility x	EKEQFCB	DDC controller is required
Possibility y		Temperature control using air suction or air discharge temperature
Possibility z	EKEQDCB EKEQMCB*	Using Daikin wired remote controller BRC1D52 or BRC1E52A/B Temperature control using air suction temperature

\* EKEQMCB (for 'multi' application)

# VRV

## Air handling application (pair & multi)

A R-410A inverter condensing units range for multi application with air handling units.

- > Inverter controlled units
- > Large capacity range (from 8 to 54HP)
- > Heat recovery, heat pump
- > R-410A
- > Control of room temperature via Daikin control
- > Large range of expansion valve kits available
- > BRC1E52A/B is used to set the set point temperature (connected to the EKEQMCB).
- > Connectable to all VRV heat recovery and heat pump systems

### Different control possibilities

		VRV IV heat pump				VRV heat recovery	VRV III-S	VRV III-C	VRV-WIII
		R*YQ8-10T	R*YQ12-30T	4 x R*YQ8T 4 x R*YQ10T	R*YQ52-54T	REYHQ-P8/P9 REYHQ-P REYAQ-P REYQ-T	RXYSQ-PAV RXYSQ-PAY	RTSYQ-PA	RWEYQ-P RWEYQ-PR
<b>Control possibilities</b>	<b>X</b>	P	P <sup>1</sup>	P <sup>2</sup>	-	-	-	-	-
	<b>Y</b>	P	P <sup>1</sup>	P <sup>2</sup>	-	-	-	-	-
	<b>Z</b>	M	M	M	M	M	M	M	M

P = pair

M = multi

1 By use of split coil (interlaced)

2 Separate coil per outdoor unit



## X,Y control for VRV IV

R\*YQ8-10T

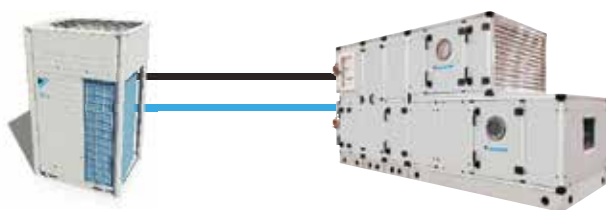

4 x R\*YQ8T  
4 x R\*YQ10T

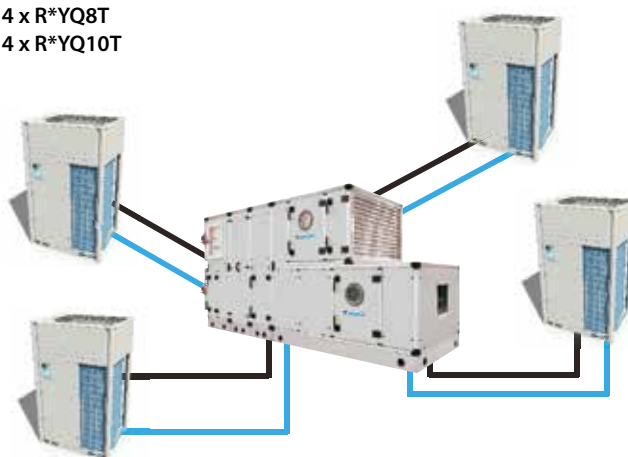

R\*YQ12-30T

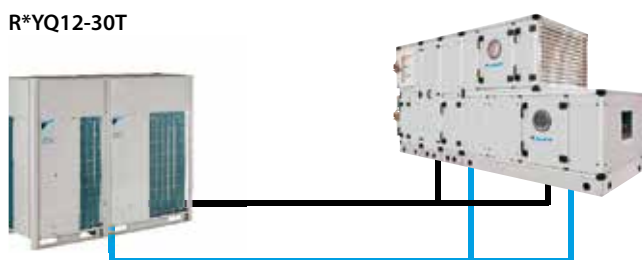

## Z control for all VRV outdoor units

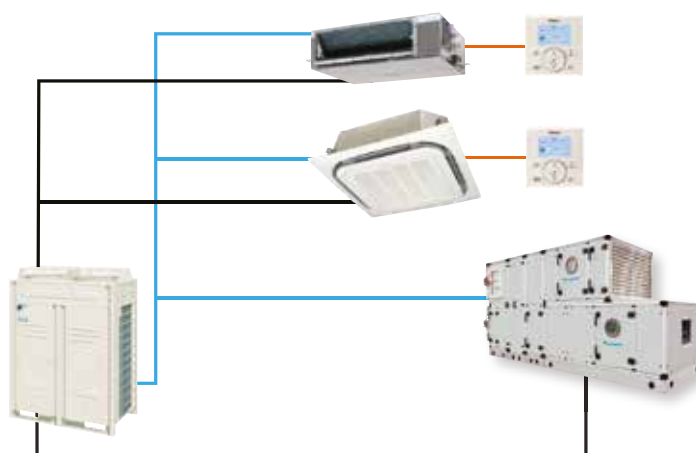

- Refrigerant piping
- F1-F2
- other communication



# ERQ

## Air handling application (pair)

A range of R-410A inverter condensing units for pair application with air handling units.

- › Inverter controlled units
- › Large capacity range (from 100 to 250 class)
- › Heat pump
- › R-410A
- › Wide range of expansion valve kits available
- › Up to 4 ERQ units can be connected to an interlaced coil in one air handling unit

The “Daikin Fresh Air Package” provides a complete Plug & Play Solution including AHU, ERQ or VRV Condensing Unit and all unit control (EKEQ, EKEX, DDC controller) factory mounted and configured. The easiest solution with only one point of contact.

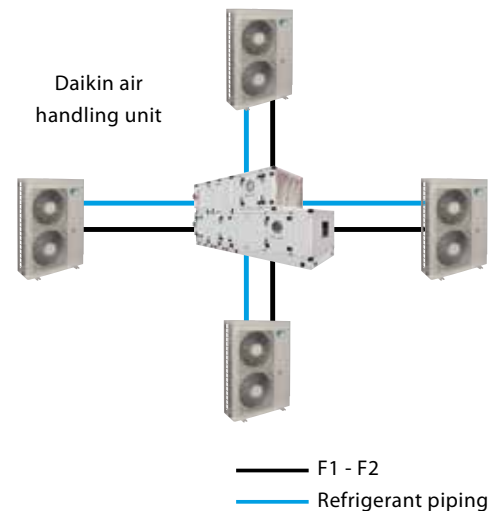

VENTILATION				ERQ100AV1	ERQ125AV1	ERQ140AV1	
Capacity range			HP	4	5	6	
Cooling capacity	Nom.		kW	11.2	14.0	15.5	
Heating capacity	Nom.		kW	12.5	16.0	18.0	
Power input	Cooling	Nom.	kW	2.81	3.51	4.53	
	Heating	Nom.	kW	2.74	3.86	4.57	
EER				3.99		3.42	
COP				4.56	4.15	3.94	
Dimensions	Unit	HeightxWidthxDepth	mm	1,345x900x320			
Weight	Unit		kg	120			
Fan-Air flow rate	Cooling	Nom.	m <sup>3</sup> /min	106			
	Heating	Nom.	m <sup>3</sup> /min	102	105		
Sound power level	Cooling	Nom.	dBA	66	67	69	
Sound pressure level	Cooling	Nom.	dBA	50	51	53	
	Heating	Nom.	dBA	52	53	55	
Operation range	Cooling	Min./Max.	°CDB	-5/46			
	Heating	Min./Max.	°CWB	-20/15.5			
	On coil temperature	Heating	Min.	°CDB	10		
		Cooling	Max.	°CDB	35		
Refrigerant	Type		R-410A				
Piping connections	Liquid	OD	mm	9.52			
	Gas	OD	mm	15.9	19.1		
	Drain	OD	mm	26x3			
Power supply	Phase/Frequency/Voltage		Hz/V	1N~/50/220-240			
Current	Maximum fuse amps (MFA)		A	32.0			

VENTILATION				ERQ125AW1	ERQ200AW1	ERQ250AW1	
Capacity range			HP	5	8	10	
Cooling capacity	Nom.		kW	14.0	22.4	28.0	
Heating capacity	Nom.		kW	16.0	25.0	31.5	
Power input	Cooling	Nom.	kW	3.52	5.22	7.42	
	Heating	Nom.	kW	4.00	5.56	7.70	
EER				3.98	4.29	3.77	
COP				4.00	4.50	4.09	
Dimensions	Unit	HeightxWidthxDepth	mm	1,680x635x765	1,680x930x765		
Weight	Unit		kg	159	187	240	
Fan-Air flow rate	Cooling	Nom.	m <sup>3</sup> /min	95	171	185	
	Heating	Nom.	m <sup>3</sup> /min	95	171	185	
Sound power level	Nom.		dBA	72	78		
Sound pressure level	Nom.		dBA	54	57	58	
Operation range	Cooling	Min./Max.	°CDB	-5/43			
	Heating	Min./Max.	°CWB	-20/15			
	On coil temperature	Heating	Min.	°CDB	10		
		Cooling	Max.	°CDB	35		
Refrigerant	Type		R-410A				
Piping connections	Liquid	OD	mm	9.52			
	Gas	OD	mm	15.9	19.1	22.2	
	Drain	OD	mm	26x3			
Power supply	Phase/Frequency/Voltage		Hz/V	3N~/50/400			
Current	Maximum fuse amps (MFA)		A	16	25		

# Overview

## of expansion valves and control boxes

Daikin also offers a range of expansion valve kits and control boxes to connect ERQ and VRV condensing units to third party air handling units.

### VRV combination table

EKEXV CLASS	ALLOWED HEAT EXCHANGER CAPACITY (KW)					
	COOLING (EVAPORATION TEMPERATURE 6°C)			HEATING (CONDENSING TEMPERATURE 46°C)		
	MINIMUM	STANDARD	MAXIMUM	MINIMUM	STANDARD	MAXIMUM
50	5.0	5.6	6.2	5.6	6.3	7.0
63	6.3	7.1	7.8	7.1	8.0	8.8
80	7.9	9.0	9.9	8.9	10.0	11.1
100	10.0	11.2	12.3	11.2	12.5	13.8
125	12.4	14.0	15.4	13.9	16.0	17.3
140	15.5	16.0	17.6	17.4	18.0	19.8
200	17.7	22.4	24.6	19.9	25.0	27.7
250	24.7	28.0	30.8	27.8	31.5	34.7

### ERQ combination table

OUTDOOR UNIT		EXPANSION VALVE KIT						
		CLASS 63	CLASS 80	CLASS 100	CLASS 125	CLASS 140	CLASS 200	CLASS 250
		EKEXV63	EKEXV80	EKEXV100	EKEXV125	EKEXV140	EKEXV200	EKEXV250
1~	ERQ100AV1	P	P	P	P	-	-	-
	ERQ125AV1	P	P	P	P	P	-	-
	ERQ140AV1	-	P	P	P	P	-	-
3~	ERQ125AW1	P	P	P	P	P	-	-
	ERQ200AW1	-	-	P	P	P	P	P
	ERQ250AW1	-	-	-	P	P	P	P

P: Pair. Combination depending on air handling units coils volume.



### EKEXV - Expansion valve kit for air handling applications

VENTILATION					EKEXV50	EKEXV63	EKEXV80	EKEXV100	EKEXV125	EKEXV140	EKEXV200	EKEXV250
Dimensions	Unit	HeightxWidthxDepth	mm		401x215x78							
Weight	Unit			kg	2.9							
Sound pressure level	Nom.			dB(A)	45							
Operation range	On coil temperature	Heating	Min.	°CDB	10 (1)							
		Cooling	Max.	°CDB	35 (2)							
Refrigerant	Type			R-410A								
Piping connections	Liquid	OD	mm	6.35						9.52		
	Gas	OD	mm	6.35						9.52		

(1) The temperature of the air entering the coil in heating mode can be reduced to -5°CDB. Contact your local dealer for more information. (2) 45% Relative humidity.



### EKEQ - Control box for air handling applications

VENTILATION					EKEQFCB		EKEQDCB		EKEQMCB	
Application					Pair		ERQ		Multi	
Outdoor unit					ERQ		VRV			
Dimensions	Unit	HeightxWidthxDepth	mm		132x400x200		132x400x200			
Weight	Unit			kg	3.9		3.6			
Power supply	Phase/Frequency/Voltage		Hz/V		1~/50/230		1~/50/230			

# Selection of air handling units

## Pair application

### Step 1: Select required capacity of AHU

Based on the required capacity of the AHU please select the expansion valve

EKEXV class	Allowed heat exchanger volume (dm <sup>3</sup> )		Step 1 Allowed heat exchanger capacity in cooling (kW)			Allowed heat exchanger capacity in heating (kW)		
	Minimum	Maximum	Minimum	Standard	Maximum	Minimum	Standard	Maximum
63	1.66	2.08	6.3	7.1	7.8	7.1	8.0	8.8
80	2.09	2.64	7.9	9.0	9.9	8.9	10.0	11.1
100	2.65	3.3	10	11.2	12.3	11.2	12.5	13.8
125 <	3.31	4.12	12.4	14.0	15.4	13.9	16.0	17.3
140	4.13	4.62	15.5	16.0	17.6	17.4	18.0	19.8
200	4.63	6.6	17.7	22.4	24.6	19.9	25.0	27.7
250	6.61	8.25	24.7	28.0	30.8	27.8	31.5	34.7

Heat exchanger capacity is defined under following conditions:  
 Saturated suction temperature (SST) = 6°C, Superheat (SH) = 5K  
 Subcool condensor (SC) = 3K  
 Air temperature = 27°CDB/19°CWB

Eg: If you need 14kW in cooling, you will require an expansion valve of 125class (EKEXV125).

The heat exchanger capacity has priority over the volume of the heat exchanger and is therefore the determining factor for the selection of the expansion valve. More information on the volume can be found in the data book and service manual.

### Step 2: Select outdoor unit

Pair combinations with ERQ outdoor units are possible based on the same principle as standard DX units. The capacity of the AHU unit is indicated by the capacity of the expansion valve and can be connected as indicated in below table.

OUTDOOR UNIT		CONTROL BOX		Step 2 EXPANSION VALVE KIT							
		Control z	Control x or y	Class 63	Class 80	Class 100	Class 125	Class 140	Class 200	Class 250	
		EKEQDCB	EKEQFCB	EKEV63	EKEV80	EKEV100	EKEV125	EKEV140	EKEV200	EKEV250	
ERQ	1~	ERQ100AV1	P	P	P	P	P	P	-	-	-
		ERQ125AV1	P	P	P	P	P	P	P	-	-
		ERQ140AV1	P	P	-	P	P	P	P	-	-
ERQ	3~	ERQ125AW1	P	P	P	P	P	P	P	-	-
		ERQ200AW1	P	P	-	-	P	P	P	P	P
		ERQ250AW1	P	P	-	-	-	P	P	P	P

P: Pair, combination depending on AHU coil volume and capacity

Eg: Based on above selected expansion valve, the EKEXV125 has a capacity of class 125. Therefore we can choose to connect it in pair with all outdoor units indicated in the table above with P.

### Step 3: Control box selection

Please make your selection of the control box based on your requirements. All the different control possibilities are mentioned on page 28.

More information on the selection is available in the service manual.



## Multi application

### Step 1: Select required capacity of AHU

Based on the required capacity of the AHU please select the expansion valve

EKEXV class	Allowed heat exchanger volume (dm <sup>3</sup> )		Step 1 Allowed heat exchanger capacity in cooling (kW)			Allowed heat exchanger capacity in heating (kW)		
	Minimum	Maximum	Minimum	Standard	Maximum	Minimum	Standard	Maximum
50	0.76	1.65	5.0	5.6	6.2	5.6	6.3	7.0
63 <	1.66	2.08	6.3	7.1	7.8	7.1	8.0	8.8
80	2.09	2.64	7.9	9.0	9.9	8.9	10.0	11.1
100	2.65	3.3	10	11.2	12.3	11.2	12.5	13.8
125	3.31	4.12	12.4	14.0	15.4	13.9	16.0	17.3
140	4.13	4.62	15.5	16.0	17.6	17.4	18.0	19.8
200	4.63	6.6	17.7	22.4	24.6	19.9	25.0	27.7
250	6.61	8.25	24.7	28.0	30.8	27.8	31.5	34.7

Eg: If the required capacity of the AHU is 6.9kW in cooling, which lies between 6.3 and 7.8, the EKEXV63 can be selected.

The heat exchanger capacity has priority over the volume of the heat exchanger and is therefore the determining factor for the selection of the expansion valve. More information on the volume can be found in the data book and service manual.

### Step 2: Select outdoor unit

Multiple AHU can be connected to a VRV system and the connection principle is similar as for ERQ. Connection of the full system can be up till 110% including at least 1 Daikin indoor unit (cassette, duct, ...) The capacity index of the AHU needs to be calculated based on the indicated capacity of the selected expansion valve and the actual capacity.

The AHU capacity index = capacity class (expansion valve) \* ratio (actual capacity AHU / standard capacity expansion valve)

Eg: AHU has a capacity requirement of 6.9kW and the selected expansion valve is the EKEXV63 with a standard capacity of 7.1kW. So the AHU capacity = 63 \* (6.9kW / 7.1kW) = 61 class

In case that in the system 2 FXSQ50 class are connected, the total sum of capacity would be 61 + 2\*50 = 161 class  
Based on the 161 class a 10 HP is required as outdoor unit.

<sup>1</sup> For detailed specifications of VRV outdoor units, refer to the VRV catalogue or databooks

### Step 3: Control box selection

EKEQMCB is the control box which is required to control the communication between the AHU and the VRV system beside the standard communication of the Daikin DX indoor units (cassette, duct, wall...).

More information on the selection is available in the service manual.

# Options & accessories

## Ventilation

OPTIONS		VAM150FA	VAM250FA	VAM350FB	VAM500FB	VAM650FB
Dust filters	EN779 Medium M6	-	-	EKAFV50F6	EKAFV50F6	EKAFV80F6
	EN779 Fine F7	-	-	EKAFV50F7	EKAFV50F7	EKAFV80F7
	EN779 Fine F8	-	-	EKAFV50F8	EKAFV50F8	EKAFV80F8
Silencer	Model name	-	-	-	-	KDDM24B100
	Nominal pipe Diameter (mm)	-	-	-	200	200
CO <sub>2</sub> sensor		-	-	BRYMA65	BRYMA65	BRYMA65
VH electrical heater for VAM		VH1B	VH2B	VH2B	VH3B	VH3B

INDIVIDUAL CONTROL SYSTEMS	VAM-FA/FB	VKM-GB(M)
Wired remote control	BRC1E52A/B / BRC1D52	BRC1E52A/B / BRC1D52
VAM wired remote control	BRC301B61	-

CENTRALISED CONTROL SYSTEMS	VAM-FA/FB	VKM-GB(M)
Centralised remote control	DCS302C51	DCS302C51
Unified ON/OFF control	DCS301B51	DCS301B51
Schedule timer	DST301B51	DST301B51

OTHERS	VAM150-250FA	VAM350-2000FB	VKM-GB(M)
Wiring adapter for electrical appendices (6)	KRP2A51 (6)	KRP2A51 (3)	BRP4A50A (4/5)
Adapter PCB for humidifier	KRP50-2	BRP4A50A (4/5)	BRP4A50A (4/5)
Adapter PCB for 3rd party heater	BRP4A50	BRP4A50A (4/5)	BRP4A50A (4/5)
Remote sensor	-	-	-

#### Notes

- (1) Cool/heat selector required for operation
- (2) Do not connect the system to DIII-net devices (Intelligent controller, Intelligent Manager, LonWorks interface, BACnet interface...)
- (3) Installation box KRP1BA101 needed for VAM350-2000FB
- (4) Fixing plate EKMPVAM additionally needed for VAM1500-2000FB
- (5) 3rd party heater and 3rd party humidifier cannot be combined
- (6) For external control and monitoring (ON/OFF control, operation signal, error indication)

VH ELECTRICAL HEATER FOR VAM	
Supply voltage	220/250V ac 50/60 Hz. +/-10%
Output current (maximum)	19A at 40°C (ambient)
Temperature sensor	5k ohms at 25°C (table 502 1T)
Temperature control range	0 to 40°C / (0-10V 0-100%)
Run on timer	Adjustable from 1 to 2 minutes (factory set at 1.5 minutes)
Control fuse	20 X5 mm 250 m A
LED indicators	Power ON - Yellow Heater ON - Red (solid or flashing, indicating pulsed control) Airflow fault - Red
Mounting holes	98mm X 181mm centres 5 mm ø holes
Maximum ambient adjacent to terminal box	35°C (during operation)
Auto high temp. cutout	100°C Pre-set
Man. reset high temp. cutout	125°C Pre-set
Run relay	1A 120V AC or 1A 24V DC
BMS setpoint input	0-10VDC

VH ELECTRICAL HEATER FOR VAM		VH1B	VH2B	VH3B	VH4B	VH4/AB	VH5B
Capacity	kW	1	1	1	1.5	2.5	2.5
Duct diameter	mm	100	150	200	250	250	350
Connectable VAM		VAM150FA	VAM250FA	VAM500FB	VAM800FB	VAM800FB	VAM1500FB
		-	VAM350FB	VAM650FB	VAM1000FB	VAM1000FB	VAM2000FB

VAM800FB	VAM1000FB	VAM1500FB	VAM2000FB	VKM50GB(M)	VKM80GB(M)	VKM100GB(M)
EKAFV80F6	EKAFV100F6	EKAFV80F6 x2	EKAFV100F6 x2	-	-	-
EKAFV80F7	EKAFV100F7	EKAFV80F7 x2	EKAFV100F7 x2	-	-	-
EKAFV80F8	EKAFV100F8	EKAFV80F8 x2	EKAFV100F8 x2	-	-	-
KDDM24B100	KDDM24B100	KDDM24B100 x2	KDDM24B100 x2	-	KDDM24B100	KDDM24B100
250	250	250	250	-	250	250
BRYMA100	BRYMA100	BRYMA200	BRYMA200	BRYMA65	BRYMA100	BRYMA200
VH4B / VH4/AB	VH4B / VH4/AB	VH5B	VH5B	-	-	-

FXMQ-MF	EKEQFCB (2)	EKEQDCB (2)	EKEQMCB (2)
BRC1E52A/B / BRC1D52	BRC1E52A/B / BRC1D52	BRC1E52A/B / BRC1D52 (1)	BRC1E52A/B / BRC1D52 (1)
-	-	-	-

FXMQ-MF	EKEQFCB (2)	EKEQDCB (2)	EKEQMCB (2)
DCS302C51	-	-	-
DCS301B51	-	-	-
DST301B51	-	-	-

FXMQ-MF	EKEQFCB (2)	EKEQDCB (2)	EKEQMCB (2)
-	-	-	-
-	-	-	-
-	-	-	-
-	-	KRCS01-1	-



The present leaflet is drawn up by way of information only and does not constitute an offer binding upon Daikin Europe N.V. Daikin Europe N.V. has compiled the content of this leaflet to the best of its knowledge. No express or implied warranty is given for the completeness, accuracy, reliability or fitness for particular purpose of its content and the products and services presented therein. Specifications are subject to change without prior notice. Daikin Europe N.V. explicitly rejects any liability for any direct or indirect damage, in the broadest sense, arising from or related to the use and/or interpretation of this leaflet. All content is copyrighted by Daikin Europe N.V.



FSC

ECPEN14-203

Daikin products are distributed by: