

M Series



Setup Guide

020-100011-05

M Series

Setup Guide

020-100011-05

NOTICES

COPYRIGHT AND TRADEMARKS

© 2011-2012 Christie Digital Systems USA, Inc. All rights reserved.

All brand names and product names are trademarks, registered trademarks or trade names of their respective holders.

REGULATORY

The product has been tested and found to comply with the limits for a Class A digital device, pursuant to Part 15 of the FCC Rules. These limits are designed to provide reasonable protection against harmful interference when the product is operated in a commercial environment. The product generates, uses, and can radiate radio frequency energy and, if not installed and used in accordance with the instruction manual, may cause harmful interference to radio communications. Operation of the product in a residential area is likely to cause harmful interference in which case the user will be required to correct the interference at the expense of the user.

This Class A digital apparatus complies with Canadian ICES-003.

Cet appareil numérique de la classe A est conforme à la norme NMB-003 du Canada.

이 기기는 업무용 (A 급) 으로 전자파적합등록을 한 기기이오니 판매자 또는 사용자는 이점을 주의하시기 바라며, 가정 외의 지역에서 사용하는 것을 목적으로 합니다.

GENERAL

Every effort has been made to ensure accuracy, however in some cases changes in the products or availability could occur which may not be reflected in this document. Christie reserves the right to make changes to specifications at any time without notice. Performance specifications are typical, but may vary depending on conditions beyond the control of Christie such as maintenance of the product in proper working conditions. Performance specifications are based on information available at the time of printing. Christie makes no warranty of any kind with regard to this material, including, but not limited to, implied warranties of fitness for a particular purpose. Christie will not be liable for errors contained herein or for incidental or consequential damages in connection with the performance or use of this material.



The product is designed and manufactured with high-quality materials and components that can be recycled and reused. This symbol means that electrical and electronic equipment, at their end-of-life, should be disposed of separately from regular waste. Please dispose of the product appropriately and according to local regulations. In the European Union, there are separate collection systems for used electrical and electronic products. Please help us to conserve the environment we live in!

Canadian manufacturing facility is ISO 9001 and 14001 certified.

GENERAL WARRANTY STATEMENTS

For complete information about the Christie limited warranty, please contact your Christie dealer. In addition to the other limitations that may be specified in the Christie limited warranty, the warranty does not cover:

- a. Damage occurring during shipment, in either direction.
- b. Projector lamps (See the separate Christie lamp program policy).
- c. Damage caused by use of a projector lamp beyond the recommended lamp life, or use of a lamp supplied by a supplier other than Christie.
- d. Problems caused by combination of the product with non-Christie equipment, such as distribution systems, cameras, video tape recorders, etc., or use of the product with any non-Christie interface device.
- e. Damage caused by misuse, improper power source, accident, fire, flood, lightning, earthquake or other natural disaster.
- f. Damage caused by improper installation/alignment, or by product modification, if by other than a Christie authorized repair service provider.
- g. For LCD projectors, the warranty period specified applies only where the LCD projector is in "normal use." "Normal use" means the LCD projector is not used more than 8 hours a day, 5 days a week. For any LCD projector where "normal use" is exceeded, warranty coverage under this warranty terminates after 6000 hours of operation.
- h. Failure due to normal wear and tear.

PREVENTATIVE MAINTENANCE

Preventative maintenance is an important part of the continued and proper operation of your product. Please see the Maintenance section for specific maintenance items as they relate to your product. Failure to perform maintenance as required, and in accordance with the maintenance schedule specified by Christie, will void the warranty.

1: Introduction

1.1 Purchase Record and Service Contacts 1-1
 1.1.1 List of Components 1-1
 1.1.2 Key Features 1-2
 1.2 Safety Warnings and Guidelines 1-3
 1.2.1 General Precautions 1-3
 1.2.2 AC /Power Precautions 1-3
 1.2.3 Lamp Precautions 1-4

2: Installation and Setup

2.1 Projector Quick Setup and Installation 2-1
 2.1.1 Install a Projection Lens 2-1
 2.1.2 Position the Projector 2-3
 2.1.3 Connect a Source 2-3
 2.1.4 Connect the Line Cord 2-3
 2.1.5 Power up 2-4
 2.1.6 Select a Source 2-4
 2.1.7 Adjust the Image 2-4
 2.2 Detailed Setup and Installation 2-4
 2.2.1 Mounting 2-4
 2.2.2 Stacking 2-5
 2.2.3 Basic Optical Alignment 2-7
 2.2.4 Advanced Optical Alignment 2-8
 2.2.5 Powering Down 2-9
 2.2.6 Projector Communications 2-10

3: Operation

3.1 How to Use the Remote Keypad or Built-In Keypad 3-1
 3.1.1 Guide to Keypads 3-1
 3.1.2 Remote Keypad 3-2
 3.1.3 Wired Remote 3-4
 3.1.4 Built-in Keypad 3-4
 3.1.5 Overview of LED and Key States 3-4
 3.1.6 Remote Keypad Commands 3-5
 3.2 Navigating the Menus 3-9
 3.3 Alarm Conditions 3-12
 3.4 SNMP and Email Notifications 3-13
 3.4.1 Controls 3-13
 3.4.2 Items 3-13
 3.4.3 Traps 3-14
 3.4.4 Email Notification 3-15

4: Maintenance

4.1 Filters 4-1

Table of Contents

5: Troubleshooting

5.1 Power	5-1
5.1.1 Projector Does Not Power ON	5-1
5.2 Lamp	5-1
5.2.1 Lamp Does Not Ignite	5-1
5.2.2 Lamp Suddenly Turns OFF	5-1
5.2.3 Flicker, Shadows Or Dimness	5-2
5.3 LCD	5-2
5.3.1 Blank Screen, No Menu Displaying	5-2
5.4 Remote Keypad	5-2
5.4.1 Remote Keypad Does Not Seem to Work	5-2
5.5 OSD	5-2
5.5.1 The OSD Menu does not display	5-2
5.6 Ethernet	5-3
5.6.1 Trouble Establishing Communication with Projector	5-3
5.7 Displays	5-3
5.7.1 The projector is on but there is no display	5-3
5.7.2 Severe Motion Artifacts	5-3
5.7.3 Image Appears ‘Squeezed’ or Vertically Stretched into Center of Screen	5-3
5.7.4 The Display is Jittery or Unstable	5-3
5.7.5 The Display is Faint	5-4
5.7.6 The Upper Portion of the Display is Waving, Tearing or Jittering	5-4
5.7.7 Portions of the Display are Cut Off or Warped to the Opposite edge	5-4
5.7.8 Display Appears Compressed (Vertically Stretched)	5-4
5.7.9 Data is Cropped from Edges	5-4
5.7.10 Display Quality Appears to Drift from Good to Bad, Bad to Good	5-4
5.7.11 Display has Suddenly Frozen	5-4
5.7.12 Colors in the Display are Inaccurate	5-4
5.7.13 Display is Not Rectangular	5-4
5.7.14 Display is “Noisy”	5-5
5.8 Web Interface	5-5
5.8.1 After upgrading the projector software, the Web pages do not display correctly	5-5
5.8.2 A backup or Interrogator file cannot be saved	5-5

6: Specifications

6.1 Feature Set	6-1
6.1.1 Air Filters (Optional)	6-1
6.1.2 Lamps	6-1
6.2 Input (Source Signal) Compatibility	6-1
6.3 Control Signal Compatibility	6-1
6.3.1 Projector Control	6-1
6.4 Power Requirements	6-2
6.4.1 Lamp Specification	6-2
6.5 Accessories and Service Components	6-3
6.6 Lens Throw Ratio	6-3

6.7 Regulatory 6-4

 6.7.1 Safety 6-4

 6.7.2 Electro-Magnetic Compatibility 6-4

 6.7.3 Environmental 6-4

 6.7.4 Marking 6-4

A: GPIO

A.1 GPIO Port A-1

 A.1.1 Configuring the GPIO A-2

1 Introduction

Every effort has been made to ensure the information in this document is accurate and reliable; however, due to constant research the information in this document is subject to change without notice.

1.1 Purchase Record and Service Contacts

Whether the projector is under warranty or the warranty has expired, Christie's highly trained and extensive factory and dealer service network is always available to quickly diagnose and correct projector malfunctions. Complete service manuals and updates are available for all projectors. Should a problem be encountered with any part of the projector, contact your dealer. In most cases, servicing is performed on site. If you have purchased the projector, fill out the information below and keep with your records.

Table 1.1

Dealer:
Dealer or Christie Sales/Service Contact Phone Number:
Projector Serial Number*:
Purchase Date:
Installation Date:

** The serial number can be found on the license label located on the back of the projector.*

Table 1.2 Ethernet Settings

Default Gateway:
DNS Server:
Projector DLP Address:
Projector Mgmt IP Address:
Subnet Mask:

1.1.1 List of Components

Ensure the following components were received with the projector:

- IR remote keypad (includes two, 1.5V AA batteries and an XLR to mini-stereo cable conversion to wired)
- Line cord
- Lens Mount Security Screw (M6x10mm long, Qty. 2)
- Lens Mount Security Screw (5mm Hex, Qty. 1)
- Warranty Card
- Web Registration Form

1.1.2 Key Features

- Up to 14,000 lumens
- HD (1080p) or SXGA+ , WUXGA, or WXGA resolution
- Dual Mercury lamp illumination with 200W, 350W and 450W options
- Dynamic Iris contrast aperture providing up to 10,000:1 contrast ratio
- Ultra-compact design and weighs less than 55lbs
- 10-bit image processor electronics with modular design
- Fully sealed optical system
- Active fan control for minimum noise level
- Selectable, motorized Yellow Notch Filter for expanded color gamut
- User interchangeable projection lenses with no-tool mounting
- PIP and seamless switching
- LiteLOC™ for constant brightness maintenance
- Intelligent Lens System (ILS)
- Motorized lens mount for all models
- Auto-setup feature
- Integrated ChristieNET
- Networking ability through RS-232 and RS-422 connectors
- Status LED display on built-in keypad for easy projector status monitoring
- Control with remote keypad, wired remote, or built-in keypad
- Four input slots for Optional Input Modules

See [Section 6 Specifications](#) for a complete list of technical specifications.

Table 1.3 M Series Projectors

MODEL NAME	PART NUMBER
HD14K-M	118-019101-XX
HD10K-M	118-011103-XX
HD6K-M	118-012104-XX
DS+14K-M	118-010113-XX
DS+10K-M	118-013105-XX
DS+6K-M	118-014106-XX
Roadster HD14K-M	118-029102-XX
Roadster HD10K-M	118-021104-XX
Roadster S+14K-M	118-020114-XX
Roadster S+10K-M	118-023106-XX
DLV1920-DL	118-042107-XX
DLV1400-DL	118-044109-XX
WU14K-M	118-011114-XX
WU12K-M	118-015107-XX
WU7K-M	118-016108-XX
Roadster WU14K-M	118-021115-XX

Table 1.3 M Series Projectors

MODEL NAME	PART NUMBER
Roadster WU12K-M	118-025108-XX
WX10K-M	118-017109-XX
WX7K-M	118-018100-XX

1.2 Safety Warnings and Guidelines

1.2.1 General Precautions



Do **NOT** look into the lens

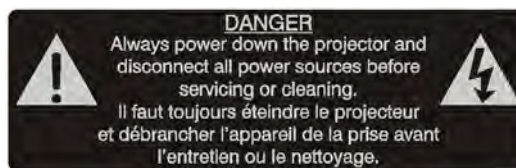

⚠ DANGER FIRE HAZARD. Keep hands, clothes and all combustible material away from the concentrated light beam of the projector. Position all cables where they cannot contact hot surfaces or be pulled or tripped over.

⚠ WARNING All installation and maintenance procedures must be performed by a Christie accredited service technician.

⚠ WARNING Projector must be operated in an environment that meets operating specifications, as listed in *Section 6 Specifications*.

1.2.2 AC /Power Precautions

⚠ WARNING Use only the AC power cord supplied. Do not attempt operation if the AC supply and cord are not within the specified voltage and power range. Refer to the license label on the back of the projector or *Section 6 Specifications* for rated voltage and power.

⚠ WARNING The projector is equipped with a 3-wire plug with a grounding pin. This is a safety feature. If you are unable to insert the plug into the outlet, contact an electrician to have the outlet replaced. **NEVER** defeat the safety purpose of the grounding-type plug.

⚠ WARNING Do not allow anything to rest on the power cord. Locate the power cord where persons walking on it or objects rolling over it cannot damage the cord.

1.2.3 Lamp Precautions



DANGER: LAMPS MAY EXPLODE-POSSIBLE BODILY HARM OR DEATH

The lamps are under pressure and may explode causing physical injury and/or property damage. Allow the lamps to cool before handling or unplugging the projector. Lamp replacement to be done by qualified service personnel; consult *User Manual* or lamp kit for instructions.

⚠ WARNING

Never attempt to access the lamp while the lamp is ON. After turning the lamp OFF, it is crucial that you wait at least 10 minutes before handling the lamp. This provides sufficient time for the lamp cooling fans to properly cool the lamp.

2 Installation and Setup

2.1 Projector Quick Setup and Installation

The following instructions are for those preferring a quick setup. Refer to the remaining subsections for detailed setup instructions.

⚠ WARNING Always power down the projector and disconnect all power sources before servicing or cleaning.

⚠ WARNING See the Safety Warnings and Guidelines in *1.2 Safety Warnings and Guidelines*.

2.1.1 Install a Projection Lens

The projection lens, shipped separately from the projector, must be installed prior to setting up the projector.

⚠ WARNING Remove the lens plug from the lens opening in the projector before installing the lens. Retain the lens plug for projector transportation to protect the optical components from dust and debris.

IMPORTANT! *The lens seals the projector, preventing contaminants from entering the interior of the projector. Never operate a projector without a lens. Remove the rear lens cap from the lens. Keep the front lens cap on the lens to protect it during installation.*

1. Rotate the lens clamp to the OPEN position, as shown.

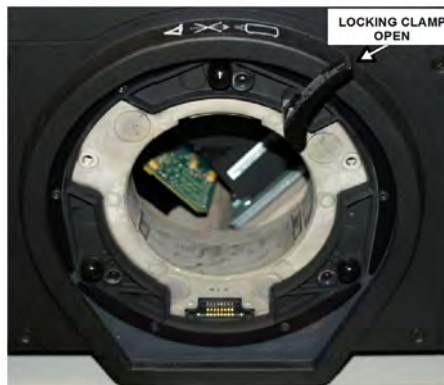

- Align the lens interface plate with the lens mount. Align the lens electrical connector with the mating connector on the lens mount. Fully insert the assembly straight into the lens mount opening without turning. Press using your hand as shown.

NOTE: When installing the lens, ensure that the lens is not inserted at an angle, as this can cause damage.



- While holding the lens flat against the lens mount, rotate the lens clamp clockwise to lock the lens assembly in place.

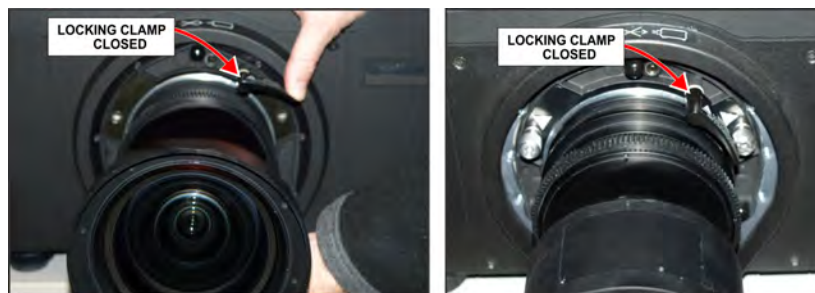

- Remove the front lens cap.
 - For added stability such as motion applications, fasten the security screws provided with the lens-mount.
- NOTE:** There are two types of lens plate models.

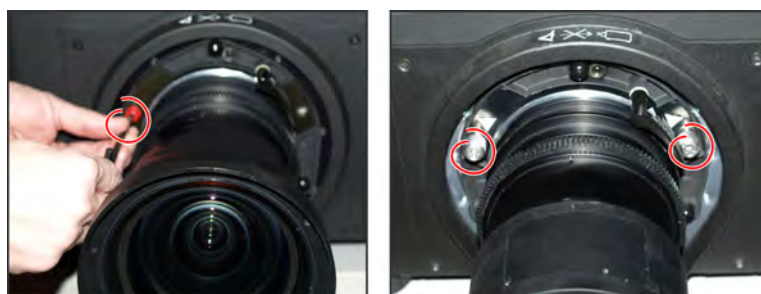

- Use a 5mm hex driver to fasten the red security screws provided with the lens mount, or hand tighten the lens retaining screws attached to the lens.
- NOTES:** **1)** Recommended for heaviest lenses such as 0.73:1 and 1.2:1. **2)** The red security screws **MUST** be installed when hoisting the projector overhead, or installing the projector in an overhead position.

⚠ WARNING Use of the lens red security screws or the lens retaining screws is required if the projector is hoisted or installed in an overhead position.

2.1.2 Position the Projector

⚠ WARNING 2 people are required to safely lift and install the projector.

Place the projector on a sturdy, level surface and position it so that it is perpendicular to the screen at a suitable distance. The further back the projector is positioned for the screen, the larger the image will be.

To level the projector adjust its 3 feet. With the projector positioned perpendicular to the screen the image will appear rectangular instead of keystone.

2.1.3 Connect a Source

The input panel where all source connections are made, is located at the back of the projector. Each input is clearly labeled for easy identification. Depending on the type of option card installed, connect your source using the appropriate cable(s), as follows:

- **Analog Input Card:** Connect 3-, 4-, or 5-wire RGB source to Red/Pr, Green/Y, Blue/Pb, H/C and V using 3, 4 or 5 BNC connectors as required.
- **Dual 3G/SD/HD - SDI Input Card:** Connect the SDI (Serial Digital Interface) cable to one of the two inputs, 1-IN or 2-IN. Both standard-definition (SD) and high-definition (HD) signals are accepted and automatically recognized on either input.
- **Dual Link DVI Input Card:** Connect a single or dual DVI video signal to the DVI-I connector, an analog video signal to the DVI-I connector or an analog video signal to the VGA connector. The DVI signal may contain HDCP (High-Bandwidth Digital Content Protection).
- **Twin HDMI Input Card:** Connect HDMI (High-Definition Multimedia Interface) cable to one of the two inputs, 1-IN or 2-IN.
- **Video Decoder Input Card:** Depending on the source you can apply the following;
 - Composite video source to 1-CVBS, using a BNC Cable. Same signal can be used on 4, 5 or 6 when input is selected as CVBS.
 - A component signal on Inputs 4(Pr), 5(Y), 6(Pb) using BNC Connectors.
 - S-Video to one of the two, 2-SVID or 3-SVID using S-Video cable.
 - S-Video using two BNC cables, with Luma (Y) connected to 4 (Sy) and Chroma (C) connected to 6 (Sc).
- **DMX512 Interface Card:** Has two 5pin XLR connectors - 1 (input) male and 1 (output) female. If there is active communications on the DMX512 Interface card the power LED will blink between low intensity and high intensity.

2.1.4 Connect the Line Cord

IMPORTANT! *Use the line cord provided with the projector, or ensure you are using a line cord, power plug and socket that meet the appropriate rating standards. Voltage and current requirements are listed on the license label, located at the back of the projector.*

Connect the projector line cord to the AC receptacle at the AC inlet of the projector, then push the wire clip over the plug to retain it. This prevents the line cord from inadvertent disconnection. Plug the 3-pronged plug end into a suitably rated grounded AC receptacle. Switch the projector ON. The switch is located just above the AC receptacle.

⚠ WARNING Do not attempt operation if the AC supply and cord is not within the specified ratings. On power down, wait 5-10 minutes for the fans to turn OFF before unplugging the projector. Always switch off the projector before unplugging the AC line cord.

2.1.5 Power up

After the AC Power has been switched on, the LCD display above the keypad indicates “Please wait” and the 4 LED status indicators on the top cover window switch on to amber. These indicate that the projector is changing its state from powered down to standby. The message “Standby Mode” appears in the display when the projector has completed its initialization and is ready for power up. The 2 lamp status LEDs will go off to indicate that the lamps are off. The Power status LED will show amber, indicating that the projector is in standby mode. The shutter LED will display amber, indicating the shutter is closed. Press and hold the power button on the keypad or remote for 2 seconds, or press twice quickly. The lamps will power on and the fans will come on. See [Section 3 Operation](#) for a full description of the status indicators.

NOTE: The default settings for the projector are to perform a lens calibration after the insertion of a new lens. If this is the first time the projector has been powered up with the lens, expect a short period (about 15 seconds) where the lens will move slightly.

2.1.6 Select a Source

Press one of the input keys on the remote, or on the built-in keypad to select and display the image for the connected source.

2.1.7 Adjust the Image

Adjust the image settings, such as Brightness, Contrast, Gamma, Focus, Zoom etc. using the direct keys on the remote, or on the built-in keypad. See [Section 3 Operation](#) for more details.

2.2 Detailed Setup and Installation

⚠ DANGER Always power down the projector and disconnect all power sources before servicing or cleaning.

⚠ WARNING See the Safety Warnings and Guidelines in [4 Maintenance](#). Switch the lamp off when the door is opened. The lamp doors are provided with clear windows to indicate when the lamps are on.

2.2.1 Mounting

There are several methods for mounting the projector. In typical front and rear screen installations the projector can be mounted to a secure and level surface, such as a table or cart. Carts are useful when the projector has to be moved often. To prevent accidental movement during a presentation, lock the wheels on the cart.

Ceiling Mount

The projector can be inverted and suspended from the ceiling using a specially designed ceiling mount fixture 118-100108-XX. This mounting is recommended for those that want the projector out of plain view or have limited amount of space for the projector. For more information, contact your dealer.

⚠ WARNING Use only the Christie approved ceiling mount kit designed for your projector.

Special Mounting

The projector can also be rotated (front-to-back) up to 360 degrees and fixed in a rotated position without affecting performance. However, the side-to-side tilt limit of the projector must not exceed +/-15 degrees, to ensure optimal performance of the projector.

2.2.2 Stacking

The M Series projectors can be stacked up to a maximum of 3 projectors high using the Christie stacking frame (118-100107-XX).

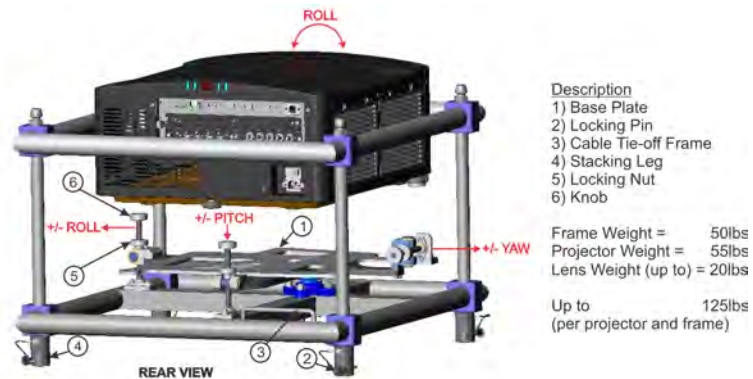

1. Turn the projector OFF and disconnect the AC power cord after the cooling fans have stopped.
2. Make sure the base plate is flat.
3. Place the projector into the stacking frame.
NOTE: *There are two ways of placing the projector into the stacking frame: from the top or from the front.*
4. Make sure the pitch is to its maximum, prior to placing the projector from the front.
5. Make sure the bottom base plate of the frame is aligned with the projector.
6. Use a 6 mm Allen key to tighten the (6) M8 bolts securing the base plate to the bottom of the projector.

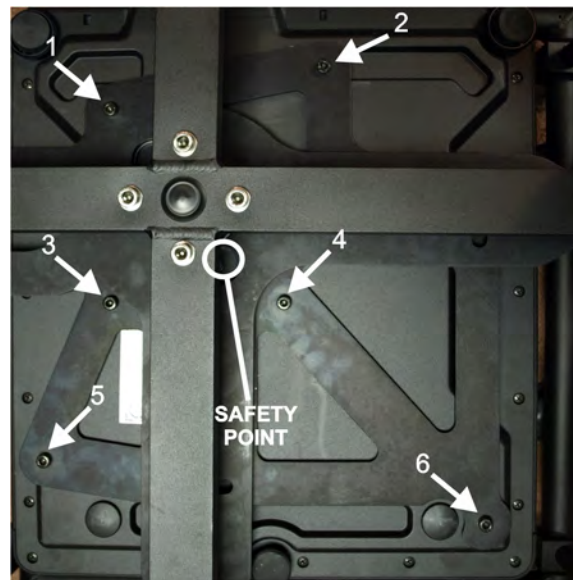
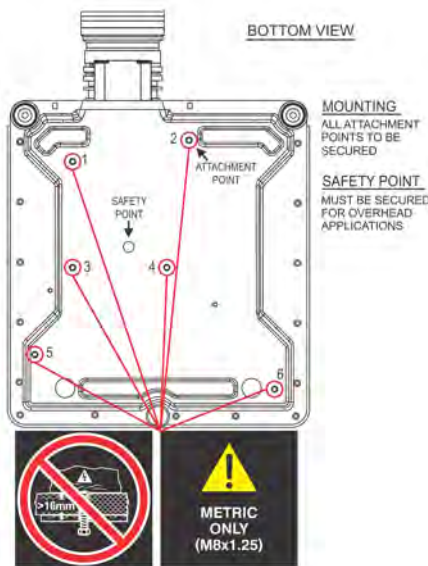

7. M8 safety point must be used when flying projectors overhead.

Stacking Multiple Projectors

NOTE: The projectors can be stacked and hoisted in either an upright or inverted positions.

1. With one person positioned on each side of the stacking frame, lift the top stacking frame onto the bottom stacking frame, aligning all four stacking legs between the frames.

NOTE: Remove the locking pin from each stacking leg prior to alignment and ensure the four stacking legs are fully seated on the lower stacking frame.

⚠ DANGER Step 2 is a critical safety procedure that **MUST** be observed. Failure to engage the locking pin may cause the projectors to separate, resulting in possible injury or death.

2. Insert the locking pin through the holes in the stacking legs. Make sure each pin is fully inserted.

NOTE: The steel ball on the end of the pin keeps the pin from releasing inadvertently.

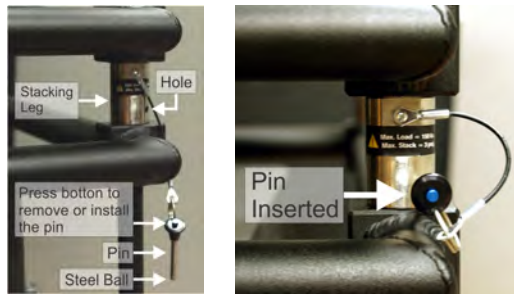
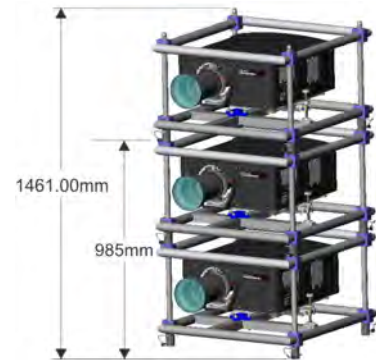

3. When required, repeat steps 1 and 2 for the third projector in the stack.

Stacking Alignment

Stacked projectors must be correctly aligned to one another so the resulting display is optimized. If hoisting the stack, do so first and then align. To align the image, use pitch, yaw, or roll. Prior to aligning the image, turn the locking nut to unlock then use the knob to adjust the image.

NOTE: Ensure to lock the locking nut to maintain the image adjustment.

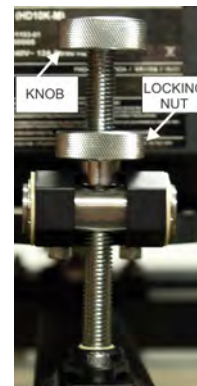
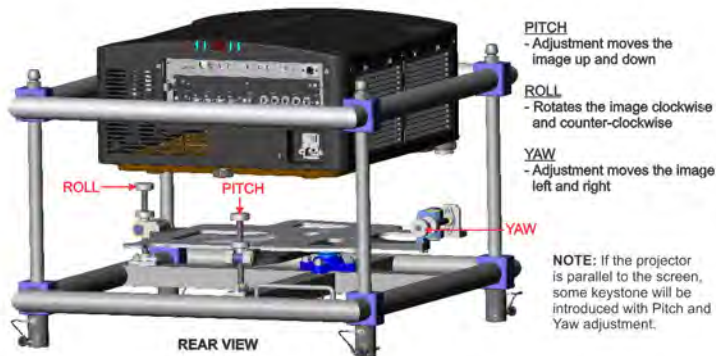

2.2.3 Basic Optical Alignment

Only perform image alignment once the projector is fully assembled and powered up in its final location. Basic image alignment ensures the image reflected from the DMDs is parallel and well-centered with the lens and screen. This initial optical alignment is the foundation for optimizing images on the screen and must be completed before final boresight adjustments. Before beginning, make sure the projector is properly positioned in relation to the screen.

Basic Optical Alignment Procedure

1. **Display a test pattern:** Appropriate for analyzing image focus and geometry, such as the “framing” test pattern showing the cross-hair centered across the image. Press the **TEST** key on the remote keypad or use the built-in keypad and press the soft key that displays Test on the LCD display.
2. **Course focus:** Do a quick preliminary focus and (if available) zoom adjustment with the primary lens. Do not worry about consistency across the image at this point, just center focus. It is good practice to have zoom adjustment color and focus adjustment color in the center of its range.
3. **Center the image in the lens:** Holding a piece of paper at the lens surface, adjust offsets as necessary until the image is centered within the lens perimeter. A full white field works best for this.
4. **Center the image on the screen:** If the projector is mounted off center to the screen axis, then offset the lens as much as required. Aim the projector over slightly towards the center of the screen, but use caution when doing so, as too much tilt will cause excessive keystone distortion. Lens offset will not.
5. **Verify side-to-side leveling:** With the framing pattern on screen, double-check projector leveling so the top edge of the image is parallel to the top edge of the screen.
6. **Throw Distance:** Ensure the projector is positioned in the throw distance range for the particular lens.

Folded Optics

In rear screen applications where space behind the projector is limited, a mirror may be used to fold the optical path. The position of the projector and mirror must be accurately set - if considering this type of installation call your dealer for assistance.

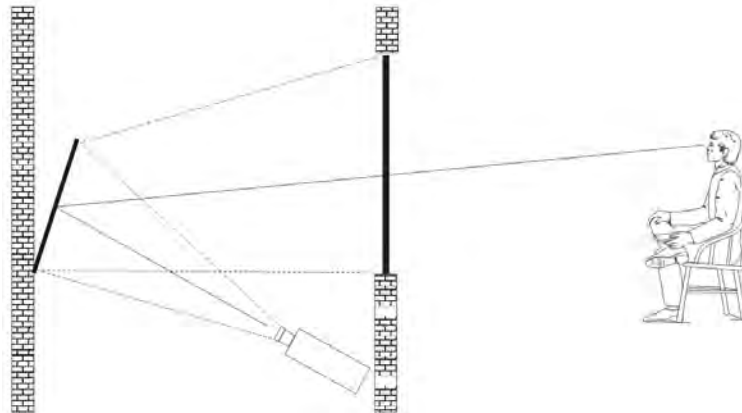

2.2.4 Advanced Optical Alignment

Boresight Alignment Procedure

1. Display the boresight test pattern by pressing the **TEST** key on the remote keypad or use the built-in keypad and press the soft key that displays “Test” on the LCD display. Press the **UP ARROW KEY** to cycle to Boresight, then Enter.

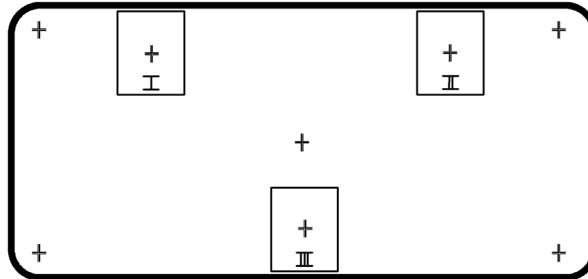

2. Focus the image on cross-hair image I. Evaluate the focus on cross-hair image II and III. If all 3 images are in focus, no further action is required. If boresight is required, continue to step 3.
3. See [Figure 2-1 Cross-Hair Pattern](#) to understand how the adjustment screws on the lens mount affect the corresponding cross-hairs on the test pattern.
NOTE: The cap screw, ([Figure 2-2 Screw Locations](#)) may be under a plastic cap. Remove and retain before adjusting.
4. Use a 5 mm hex driver to loosen 3 setscrews on the lens mount as shown in [Figure 2-2 Screw Locations](#).
NOTE: The setscrews must be backed out several turns to avoid contact with the inner lens mount plate.

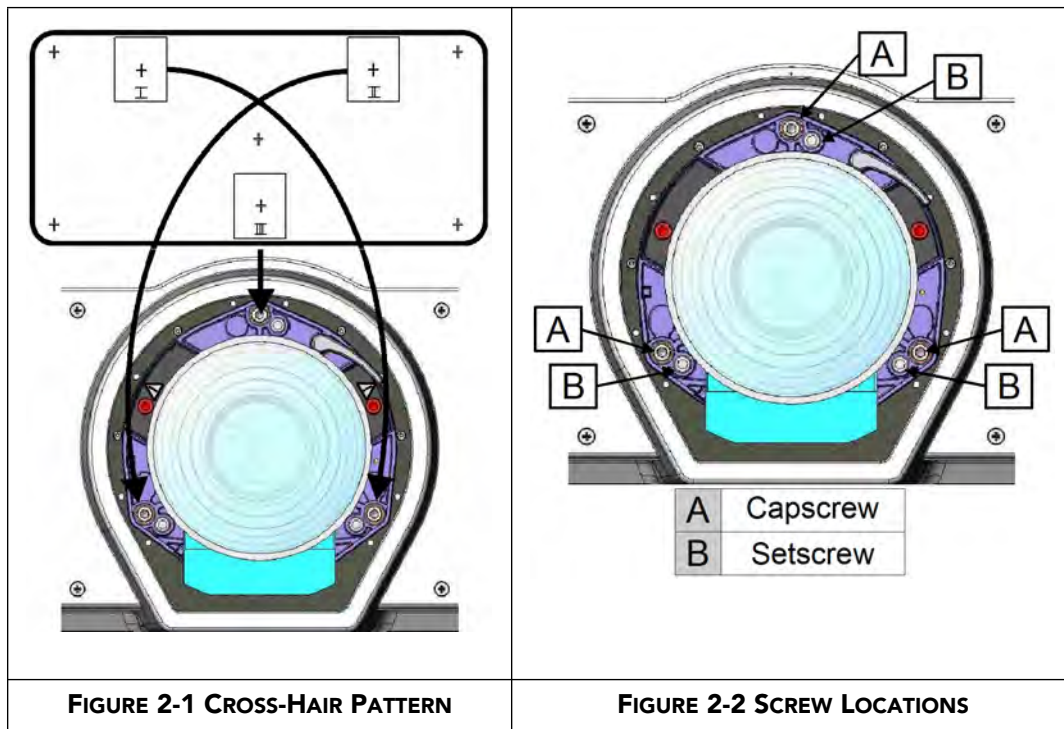

5. Fine tune the focus of cross-hair pattern I by adjusting the appropriate cap screw. Adjust until the cross-hair image is in focus with minimal flare.

6. Adjust cross-hair pattern II, by adjusting the appropriate cap screw. Adjust until the cross-hair image is in focus with minimal flare.
7. Adjust cross-hair pattern III, by adjusting the appropriate cap screw. Adjust until the cross-hair image is in focus with minimal flare.
8. Repeat step 5, 6, and 7 as required until all 3 cross-hair patterns are in equal sharp focus. If the boresight is acceptable, see step 11. If the boresight does not appear to be converging to an acceptable level of image quality, or if the lens will not focus over the correct range of throw distances, then the boresight requires coarse adjustment, see step 9.
9. The original factory boresight can be approximately recovered, by positioning the 3 setscrews flush with the front face of the lens mount plate, and in contact with the inner lens mount plate, see *Figure 2-3 Position Setscrew Flush*. This may require adjusting both setscrews and cap screws.
10. If further action is required. Repeat 2.
11. Lock the setscrews, and re-check the boresight quality. Tighten the setscrew enough to ensure they will not shift.

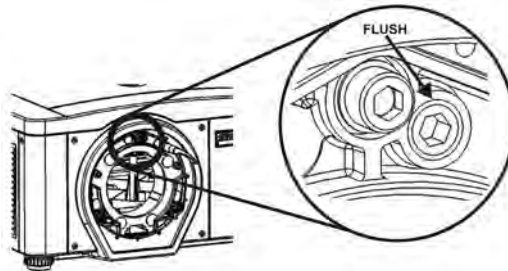

FIGURE 2-3 POSITION SETSCREW FLUSH

2.2.5 Powering Down

The projector can be powered down by using one of the following methods:

Remote Keypad/Built-In Keypad

- Press and hold **POWER**

-OR-

- Press **POWER** twice

-OR-

- Press **POWER** once, then immediately press the **DOWN** key.

NOTE: For Step 2 and 3, if the second key is not pressed immediately, a confirmation window will appear. The second key press must be pressed within 1 second of the window appearing.

After powering down, the Status LEDs cycle and the LCD displays the message “Cooling Down”, until cool down is complete.

Web User Interface (UI)

1. From the **Main** Tab, Select **Power > OFF**.
2. Select **Yes**.

2.2.6 Projector Communications

Status LEDs

Looking from the back of the projector, the LEDs represent, from left to right; Lamp 1, Lamp 2, Power, and Status. The LEDs will display the colors as shown below:

PROJECTOR STATE	LEDS	LED STATE
Hard Boot	All	All LEDs amber - means please wait
Standby Mode	Lamp 1 and 2	Off - lamps are off
	Power	Amber - AC is present but projector is off or standby
	Shutter	Green - shutter is open
Amber - shutter is closed		
Warm-up (Powering ON from standby)	All	LEDs cycle green from left to right
Normal Operation	Lamp 1 and 2	Amber - lamp time has expired and lamp should be replaced
	Power	Green - projector is powered up and operating normally
	Shutter	Green - shutter is open
Amber - shutter is closed		
Cool-down	All	LEDs cycle amber from left to right
Error	Lamp 1 and 2	Amber - lamp time has expired and lamp should be replaced
		Flashing Red - lamp has malfunctioned
	Power	Flashing Red - error has occurred. Details are displayed on the status display
Software Upgrade in progress	All	The pattern will alternate between: Amber and Off
Lamp Regeneration in progress	Lamp 1 and 2	Flashing Green - the lamp is being switched off for its regeneration period to extend lamp life (typically 15 minutes every 24 hours)
	Power	Green - on -OR- Amber - standby
	Shutter	Green - shutter is open
<p>NOTE: A condition occurs on the first power on after a software upgrade, and is indicated by all the following:</p> <ul style="list-style-type: none"> • The Status LEDs are cycling green • The LCD displays the warning “Image Processor Upgrading” • The LED on the Image Processor card flashes green • The Web page shows a warning that the Image processor card is upgrading. <p>When this occurs, the projector should not be AC power cycled and the Image Processor card should not be removed.</p>		

3 Operation

This section describes the controls and switches used for basic projector operation once it is properly installed, aligned and configured by a Christie accredited service technician.

⚠ WARNING See the **Safety Warnings and Guidelines** in *Section 4 Maintenance*.

3.1 How to Use the Remote Keypad or Built-In Keypad

The projector is typically controlled using one of the following keypads:

- **Remote Keypad:** For wired or wireless control up to 25 feet (8 m) away (includes cable for use as a wired remote). The remote keypad controls the projector by way of wireless communications from a battery-powered infrared (IR) transmitter. Use the remote keypad the same way you would use a remote keypad supplied with a TV or VCR. When pressing a function key, direct the keypad toward the projector's front or rear IR sensor. One of the two IR sensors on the projector will detect the signal and relay the commands for internal processing. A laser pointer is built into the remote keypad. See *Figure 3-1 Remote Keypad*.
- **Built-in Keypad:** Located at the side of the projector, see *Figure 3-2 Built-In Keypad*.

While each of the keypads provides complete control of the projector, they differ slightly in their arrangement of keys and in what functions can be accessed directly with a key press rather than requiring use of the menu system. You may find one keypad more convenient than another for your specific installation and application.

3.1.1 Guide to Keypads

Keep these guidelines (common to both keypads) in mind:

- Press keys one-at-a-time; there are no simultaneous key combinations required.
NOTE: Use **POWER**, **SHUTTER**, and **OSD FUNCTIONS** by doing one of the following: "press-and-hold" (2 seconds) or press twice quickly, followed by pressing either the **UP ARROW KEY** to switch on or the **DOWN ARROW KEY** to switch off once. See *Figure 3-1 Remote Keypad*.
- Arrow keys are held down for continuous adjustment/movement in the related key direction.
NOTE: In serial networks, pause briefly between adjustments to make sure that more distant projectors can "keep up" with the commands. If you press a key while the projector is still responding to the previous action, such as during power-up, the second key press may not take effect.

See *Table 3.1 M Series Key Commands* for the description of the keys provided for the remote keypad.

⚠ WARNING Laser radiation is emitted from the laser diode in the remote. **DO NOT** look directly into the beam of the laser.

3.1.2 Remote Keypad

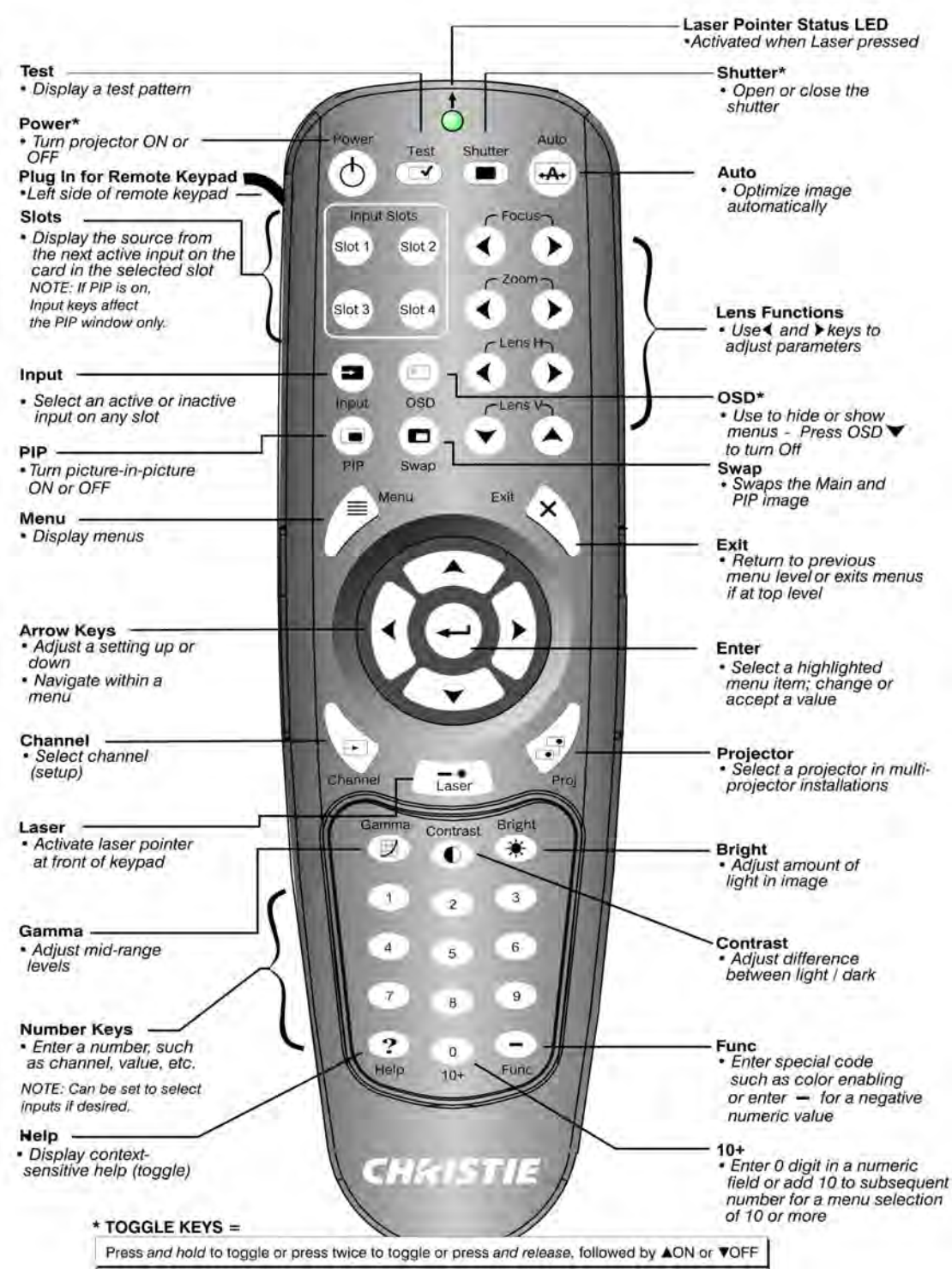

FIGURE 3-1 REMOTE KEYPAD

Table 3.1 M Series Key Commands

KEY	KEY DOWN VALUE	KEY UP VALUE
0	0	128
1	1	129
2	2	130
3	3	131
4	4	132
5	5	133
6	6	134
7	7	135
8	8	136
9	9	137
- (Func)	14	142
Help	63	191
Gamma	85	213
Contrast	41	169
Brightness	80	208
Channel	81	209
Proj	22	150
Arrow Down	59	187
Arrow Left	60	188
Arrow Right	62	190
Arrow Up	58	186
Enter	13	141
Menu	44	172
Exit	27	155
PIP	84	212
Swap	89	217
Input	64	192
OSD	47	175
Slot 1	65	193
Slot 2	66	194
Slot 3	67	195
Slot 4	68	196
Power	46	174
Test Pattern	82	210
Shutter	83	211
Auto	86	214
Focus In	74	202
Focus Out	73	201
Zoom In	72	200
Zoom Out	71	199
Lens Left	76	204
Lens Right	75	203
Lens Down	78	206
Lens Up	77	205

3.1.3 Wired Remote

You can convert the remote keypad into a wired remote keypad using the cable provided with the projector. Connect one end into the remote and the other to the XLR connector on the input panel labeled as wired keypad. The wired remote is recommended when:

- The built-in keypad is inaccessible
- The lighting conditions are unsuitable for proper IR transmission

NOTE: Leave the batteries in the wired remote for the laser pointer key to work.

3.1.4 Built-in Keypad

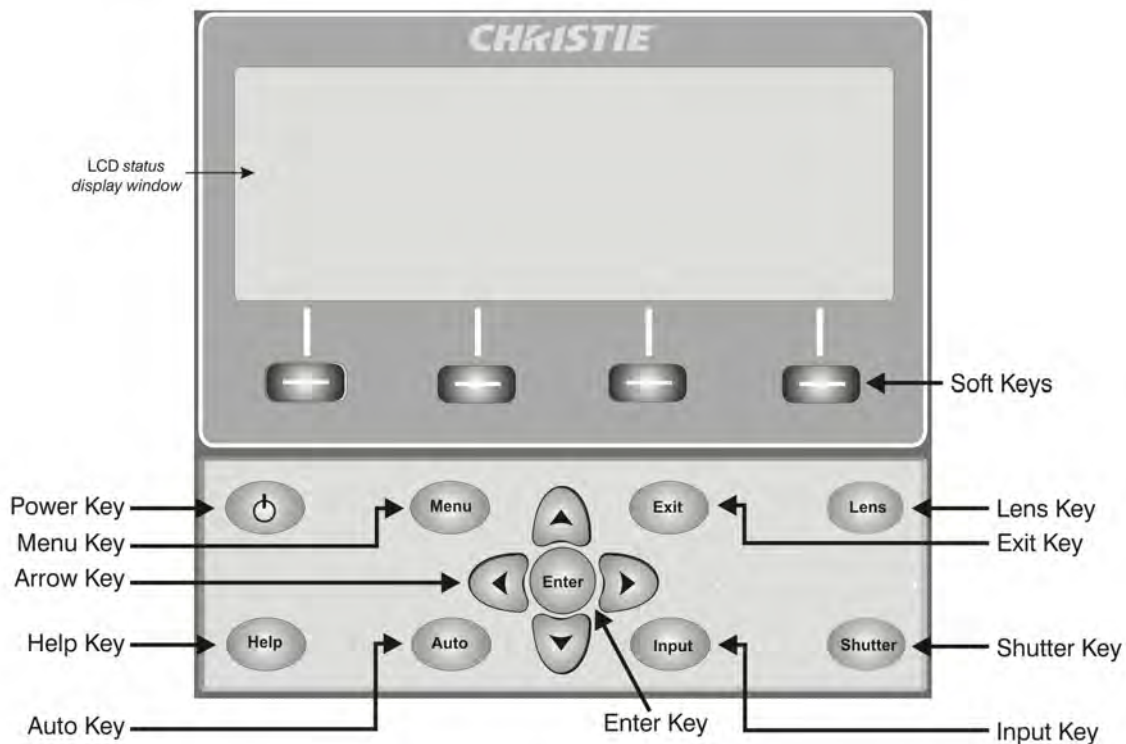

FIGURE 3-2 BUILT-IN KEYPAD

The built-in keypad has a LCD status display window which displays all states of the keypad controls. The LCD displays status information when the projector is powering up “Warm up: Lamp is warming up” and when the projector is cooling down “Cool down: Lamp is cooling down.” The display shows the state of the keys, menu structure, and menu items.

3.1.5 Overview of LED and Key States

The LED color of the keys indicates that the key is in one of these states:

- **Amber:** A functionality is available that will affect the displayed image of the projector
- **Blue:** A functionality is available that is relevant to the built-in LCD only and will not affect the displayed image from the projector
- **Off:** The key is disabled in the current context
- **Power Key:** Used to switch from Standby mode to ON, and from ON to Standby mode; LED always remains Amber

- **Help Key:** Only available in the On Screen Display (OSD) context; LED is Amber when the menu is being displayed on the projected image display; when no menu is being displayed, the Help key is still enabled if the OSD is enabled. It is only disabled when the entire OSD is set to OFF.
- **Auto Key:** Enabled state when the power is ON, and there are no test patterns on the screen. If the power is OFF or a test pattern displays, the Auto key is disabled.
- **Exit Key:** Is determined in the specific context of the screen being displayed.
- **Input Key:** Enabled when the power is ON. Disabled if the power is OFF.
- **Lens Key:** Enabled when the power is ON. Disabled if the power is OFF.
- **Shutter Key:** Enabled when the power is ON. Disabled if the power is OFF.
- **Menu Key:** Always remains in the enabled state when the power is ON. If the power is off the Menu key is disabled.
- **Soft Key:** Used to select an action indicated by text above the key on the LCD. If no text is shown, the associated key is disabled.

3.1.6 Remote Keypad Commands

Specific keypad commands are explained in *Table 3.1 M Series Key Commands*.

Power ON/OFF

Press and hold **POWER** for two seconds or press twice quickly to action the projector ON or OFF. Or press and release **POWER** followed immediately by the **UP ARROW KEY** (ON) or **DOWN ARROW KEY** (OFF) to guarantee the correct action (useful if you are unsure of the present state).

NOTES: 1) *After powering down, the lamp cooling fan remains on for approximately five minutes to cool the lamp. 2)* *Avoid turning the projector back on until it has been off for a few minutes. Hot re-strikes of the lamp will reduce lamp life and may cause the lamp to explode.*

Test

Steps forward through all internal test patterns. After stepping past the last test pattern, you will return to current input.

Press **TEST** and then cycle by using the **UP ARROW KEY** and **DOWN ARROW KEY** arrow keys, to cycle in either direction through the test patterns. Press **EXIT** to return to the current input.

Auto

Initiates an automated process in which the projector optimizes critical display parameters such as size, position, pixel tracking, etc., for the current source. These parameters are listed in the following table. An auto setup can save time in perfecting a display and you can modify the adjustments as desired.

Table 3.2 Auto Setup

OPTIMIZES	SETS TO DEFAULT
Pixel Tracking	Contrast
Pixel Phase	Brightness
Size and Blanking	Auto Input Level (off)
Vertical Stretch	Detail (if video source)
Position	Filter
Input Levels	Luma Delay

The best auto setup will be obtained under the following conditions:

- Input levels, it is best to have an image with saturated (very bright) colors.
- Phase, high contrast edges are needed.

To determine active window size:

- Video images should have whites and blacks in the image.
- Wide range video images should have content (including white) that extends to all edges of the image.

Channel

Select a specific source setup (channel) defined and stored in projector memory. Once you enter a two-digit channel number (or, if there is a list displayed, highlight it and press **ENTER**), the display will automatically change and update according to the numerous setup parameters defined for that channel.

NOTES: 1) A new channel is automatically created if you adjust an image from a new source. **2) CHANNEL** key behavior during a presentation depends on whether or not **Display Channel List** is enabled in the **Menu Preferences** menu. You can choose to use a scrolling list of channels when you press **CHANNEL**, or you may prefer to enter the desired channel number “blind”, i.e., without on-screen feedback.

Slot 1, 2, 3, 4

Press to display the next active input on the card in the slot.

Input

Displays all inputs in all slots, both active and inactive. Scroll through the list to select an input for the main image. Press Input again to show the list and select the picture-in-picture (PIP) image.

PIP

Turns picture-in-picture ON or OFF.

Swap

Swaps the main and PIP images.

Contrast

Changes the level of peak white in your images. Use **LEFT/RIGHT ARROW KEY** until you reach the desired level of contrast—for best results, start low and increase so that whites remain bright but are not distorted or tinted and that light areas do not become fully white (i.e., “crushed”). Conversely, low contrast causes dim images.

Bright

Increases or decreases the black level in the image. Use **LEFT/RIGHT ARROW KEY** until you reach the desired level of brightness. For best results, start high and decrease so that dark areas do not become fully black (i.e., “crushed”). Conversely, overly high brightness changes black to dark grey, causing washed-out images.

Gamma

Determines how grey shades are displayed between minimum input (black) and maximum input (white) for a given amount of signal. The proper setting helps maintain optimized blacks and whites while ensuring a smooth transition for the “in-between” values utilized in greys. Unlike brightness and contrast controls, the overall tone of an image can be lightened or darkened without changing the two extremes and your images will be more vibrant yet with good detail in dark areas when using the Gamma control.

The nominal setting for Gamma Correction of 0 is correct for most signals and conditions. If excess ambient light washes out the image and it becomes difficult or impossible to see details in dark areas, increase the gamma correction setting to compensate.

NOTE: *The range for this control has changed. After an upgrade from version 1.2 or earlier to version 1.3 or later, the setting for Gamma Correction must be set again.*

Number Keys

Press 1 to 9 to enter a value in a text box or to select a menu item.

10+

Press **0** before pressing another number to enter a number greater than 9, e.g. press **0** then **2** to enter the number 12 as a menu selection.

NOTE: *When entering numbers in a text field, this button acts as 0.*

Help

Press **HELP** to display context-sensitive help. Press **HELP** again to toggle the help window OFF.

Menu

Press **MENU** to enter or exit the projector menu system.

OSD (On-Screen Display)

Press **OSD** then the **DOWN ARROW** to hide the projector’s menu system during use. To see the menus again, do one of the following:

- Press and hold **OSD** for two seconds.
- Press and release **OSD** followed immediately by **UP ARROW**.
- Press **OSD, OSD**.

Invisible menus are fully functional, enabling “hidden” access to numbered features and image adjustments by entering the corresponding sequence of key presses on the keypad.

NOTE: *With OSD turned ON, you can still hide error messages and slide bars by disabling these options in the Menu Preferences menu.*

Shutter

Press and hold **SHUTTER** for two seconds to toggle the internal mechanical shutter blade closed or open with a single keystroke. Or press and release **SHUTTER** followed immediately by **UP ARROW KEY** (closed) or **DOWN ARROW KEY** (open) to guarantee the correct state (useful if you are unsure of the present state). Alternatively, press **SHUTTER, SHUTTER** to toggle from the present on/off state.

A closed shutter blanks the display (turns it to black). Close the shutter to block the displayed image while maintaining access to projector functions. Opening the shutter restores the image.

NOTES: **1)** *The LCD display shows the current state of the shutter.* **2)** *The shutter is open upon power-up.*

Function Key

Within A Numeric Field In A Menu: Use **FUNC** to enter a negative number.

Within A Text Field: Press **FUNC** followed by the **UP ARROW KEY** or **DOWN ARROW KEY** to convert between capital and lower case letters. Press **FUNC** followed by the **LEFT ARROW KEY** or **RIGHT ARROW KEY** to insert or delete a character. Press **FUNC** followed by **ENTER** to delete all characters.

Within A Presentation: Press **FUNC** followed by two numeric numbers to enable a specific color or colors in the display. For example,

will display only red, and will display green data. Eliminating one or more colors can help with certain diagnostics and setups, such as when accurately overlaying one image on top of another from stacked projectors.

NOTE: *Color enabling can also be implemented from numerous locations within the menu system.*

Press **FUNC** followed by **HELP** to disable **Keystone**, **Edge Blending** and **Brightness Uniformity** settings. This will disable the features without changing the settings associated with them.

	= White (all colors)
	= Red
	= Green
	= Blue
	= Yellow
	= Cyan
	= Magenta
	= White (all colors)
	= Invert 3D input

Projector

Press **PROJ** to access a specific projector within a group of projectors or to confirm if the local projector is listening. The number in the “Enter Number” window indicates which projector is currently listening to commands, and will match the projector number that has been defined in the **Menu Preferences** menu.

The **PROJ** check box (read-only) shows whether or not the projector physically connected to a keypad is listening to commands from that keypad. A check mark means that connected projector is listening; if there is no check mark, you are communicating with a different projector.

To control a specific projector with the keypad, press **PROJ** and then enter the three-digit number assigned to the projector you want to use. If you switch to a projector other than the one you are currently using, the check mark will disappear.

To broadcast to multiple projectors, press **PROJ** and then **PROJ** again without entering a projector number. Keypad commands will then effect all projectors present.

NOTES: 1) *There is no method of controlling a group of projectors within the same wired configuration using the wired keypad exclusively, since there is only one wired protocol available. 2)* *The projector’s address can be set in the **Configuration Menu > Communications Submenu**.*

Enter

Press **ENTER** to select a highlighted item, to toggle a check box, or to accept a parameter adjustment and return to the previous menu or image.

Exit

Press **EXIT** to return to the previous level, such as the previous menu.

NOTE: *EXIT does not save changes within text editing boxes (including number editing of a slide bar value) or within pull-down lists. In these cases, EXIT acts as a “cancel”.*

Arrow Keys

Use the **LEFT/RIGHT ARROW KEY** to change a slide bar value or to select a different option within a pull-down list without having to first scroll through options or navigate within a menu, pull-down list or text box.

Lens H and Lens V

When adjusting the image for focus, zoom or horizontal and vertical positioning, use the specific arrow keys (**LEFT/RIGHT ARROW KEY** or **UP/DOWN ARROW KEY**) related to each function. A small window will appear to indicate the type of adjustment taking place. For example,

- Use the **FOCUS** and the **LEFT ARROW** or **RIGHT ARROW KEY** to improve image clarity as desired.
- Use the **ZOOM** and the **LEFT ARROW** or **RIGHT ARROW KEY** to achieve a desired image size.
- Use the **LENS H** and the **LEFT ARROW** or **RIGHT ARROW KEY** to position the image horizontally.
- Use the **LENS V** and the **UP ARROW** or **DOWN ARROW KEY** to position the image vertically.

Press **EXIT** to return to a presentation level.

NOTE: Use the **LENS** key (built-in keypad) with the general **UP/DOWN ARROW KEY** to get the same effect as if using the arrow keys related to “Lens V” or “Lens H” on the Remote Keypad. All 4 lens settings can be adjusted by using the soft keys.

Laser

Press **LASER** to activate the laser pointer on the remote. Point the remote at the screen to highlight an area of your presentation.

NOTE: Leave batteries in the wired remote keypad for the **LASER** key to work.

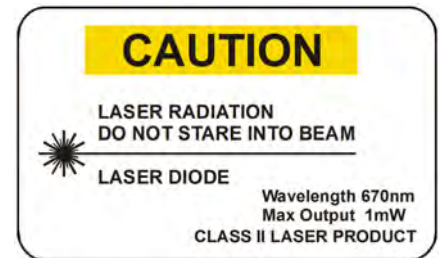

3.2 Navigating the Menus

Main Menu

Most of the projector controls are accessed from within the projector’s menu system. There are several groups of related *functions*, with each group selectable from the **Main** menu as shown at right. Press **MENU** at any time to display this **Main** menu.

On the remote keypad, enter the number corresponding to the function menu you wish to access, such as 2 for the **Image Settings** menu. Or use the **UP/DOWN ARROW KEY** on any keypad to highlight the desired option, then press **ENTER**. The corresponding function menu or pull-down list of further options will appear.

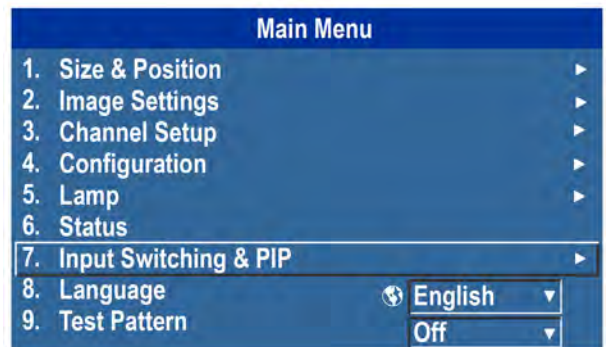

FIGURE 3-3 MAIN MENU

With a function menu displayed, enter a menu option number for any numbered option, or use the **UP/DOWN ARROW KEY** to highlight the desired option and then press **ENTER**. Long menus have a scroll bar on the right—use the arrow keys to access the remainder of the menu. Locked items or items that do not pertain to the current action or condition appear dimmed and cannot be selected.

When finished with a Function menu:

- Press **EXIT** to return to the previous screen.

-OR-

- Press **MENU** to leave the menu system and return to the presentation.

NOTES: **1)** If there is no signal present, all source-dependent adjustments are disabled. **2)** After 15 minutes of inactivity, the projector leaves the menu system and returns to the presentation. **3)** The **Status** menu is read-only.

On-line Help

Press HELP to display summary information about the current menu or highlighted option. Press HELP again to exit.

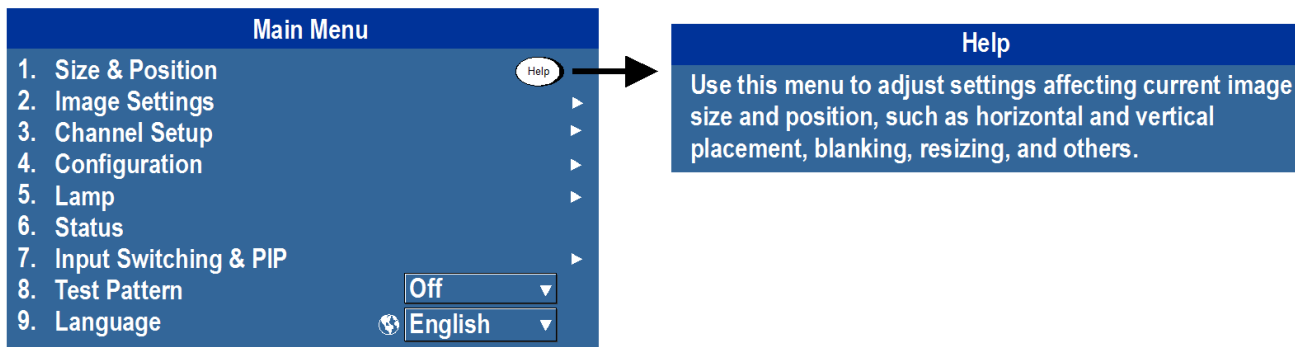

FIGURE 3-4 ON-LINE HELP

The Global Icon



Menu options that include this icon apply universally. Menu options without this icon apply to the selected channel only.

Using Slide bars and Other Controls

Most of the function menus allow you to change settings by using slide bars, checkboxes, and pull-down lists. Navigating options:

- Enter the menu option number corresponding to the setting you wish to change (for example, press MENU 1 3 to select “Vertical Stretch” in the **Size and Position** menu).
- Move the highlight to the option desired and press ENTER.
- Move the highlight to the option desired and press LEFT/RIGHT ARROW KEY to adjust immediately.
- You can bypass the menus entirely and use a single key to immediately access an adjustment during your presentation (applies only to options having their own key, such as Contrast, Brightness, Gamma, etc.).
- For “blind” access, hide the entire menu system (see OSD key, above) and access using the proper sequence of key presses.

Slide bars in menus – The current value for a given parameter, such as size or vertical stretch, appears to the left of its slide bar icon (adjustment window). This number often expresses a percentage, or it may have units associated with it (such as pixels), depending on the specific option. Press LEFT/RIGHT ARROW KEY to gradually adjust the setting up or down—both the number and the length of the bar change accordingly. Hold for continuous adjustment. Or press ENTER to activate a slide bar text box for specific number entry via the keypad and then press ENTER to save (or press EXIT to cancel).



FIGURE 3-5 EXAMPLE OF SLIDE BAR

“Direct” slide bars - For quick access, to Gamma, Brightness, and Contrast slide bars without traveling the menu system. Press Gamma, Brightness, or Contrast to display the contrast slide bar.

Use the arrow keys to adjust a direct slide bar, or press ENTER and enter a specific number from the keypad, then ENTER or LEFT ARROW KEY or RIGHT ARROW KEY to save (or EXIT to cancel). When you are done, press EXIT to save and return to your presentation.

NOTES: 1) You can still adjust a direct slide bar as usual if the display is turned off (see OSD or Menu Preferences menu) — the slide bar just won't be visible. **2)** A direct slide bar disappears if it is not used within five seconds.

Checkboxes - Conditions are present if its adjacent checkbox contains a checkmark. To toggle the checkbox, highlight and press ENTER, or highlight and use RIGHT ARROW KEY to check and LEFT ARROW KEY to uncheck. If a checkbox is numbered, enter its number to immediately toggle the checkbox.



FIGURE 3-6 EXAMPLE OF CHECKBOX

Pull-down lists – To see a pull-down list of options available for a given parameter:

- Highlight the list and press ENTER; or
- Enter the menu option number

Use the UP ARROW KEY or DOWN ARROW KEY to navigate up and down within the list. Press ENTER to choose an option from the list.

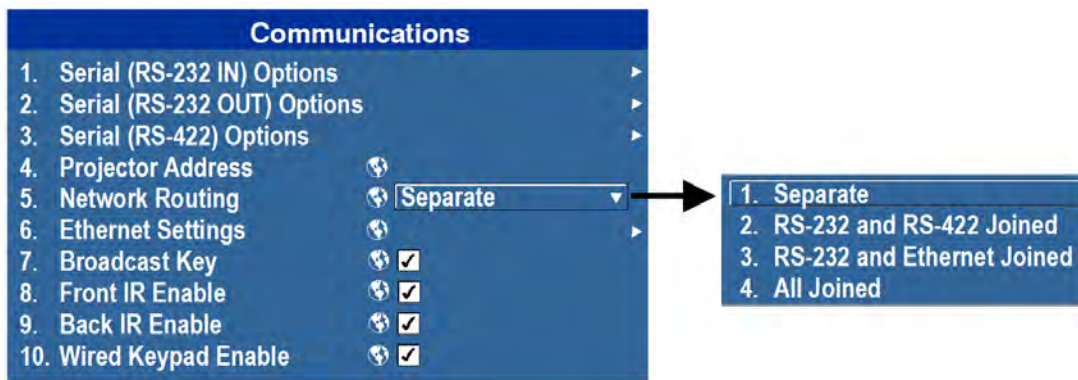

FIGURE 3-7 EXAMPLE OF PULL-DOWN LIST

If you prefer to quickly scroll through a list without first pulling it down, highlight the option and use LEFT ARROW KEY or RIGHT ARROW KEY. Press ENTER when the desired choice appears. **NOTES: 1)** Press LEFT ARROW KEY or RIGHT ARROW KEY to jump between pages in an extra long pull-down list. **2)** Press EXIT while in a pull-down list to **cancel** any change.

Editing Text

Activate the Edit Window: To enter or edit text, highlight the desired parameter (such as a channel name) and press ENTER to activate its adjacent edit window. Any previously entered text is displayed with its first character highlighted in a square cursor, signifying that this character is ready for editing.

Navigate Within the Edit Window: Press RIGHT ARROW KEY to move the cursor forward or LEFT ARROW KEY to move the cursor backwards as desired.

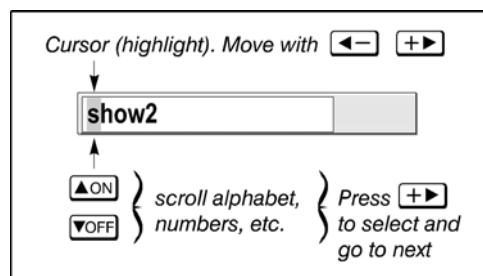

FIGURE 3-8 - ENTERING TEXT

Edit a character: To edit a highlighted character, use UP ARROW KEY and DOWN ARROW KEY to scroll through the alphabet, numbers, spaces and punctuation available. When the character you need appears, press RIGHT ARROW KEY to select it—the cursor will move to the next available character of current text. To convert a lower case letter into a capital letter, position the cursor on the letter and press FUNC followed by the UP ARROW KEY. To convert a capital letter into a lower case letter, position the cursor on the letter and press FUNC followed by the DOWN ARROW KEY. **NOTE:** *Also enter numbers directly from the keypad.*

To convert a lower case capital letter, position on the letter and press FUNC followed by the UP ARROW KEY, To convert a capital letter into a lower case letter, position on the letter and press FUNC followed by the DOWN ARROW KEY.

Add or Delete a Character or Space: To insert a space at the cursor location, press FUNC then the RIGHT ARROW KEY. To delete a highlighted character (or space), press FUNC then the LEFT ARROW KEY.

Delete all Characters: Press FUNC followed by ENTER.

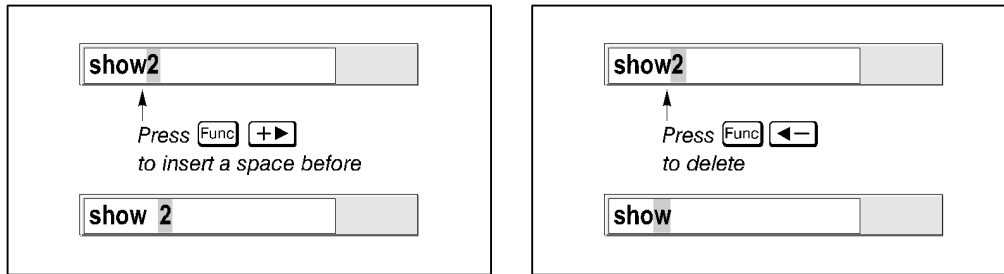

FIGURE 3-9 ADD/DELETE CHARACTER OR SPACE

Press Enter When Finished: To accept edits and leave the edit window, press ENTER.

NOTE: *Press EXIT at any time to cancel changes and return to the previously defined text.*

Edit numerical values:

Enter numbers directly from the keypad to specify numbers representing projectors channels (source setups), or slots. As each digit is entered, it is inserted on the right of the field, and the numbers already in the field are shifted on the left. The channel numbers are defined with two digits—for example, if you enter only a single digit (such as “7”) for a channel number, the channel will automatically be defined as “07”. Enter “07” to utilize this channel. If you press any non-numbered key, the number entered up to that point is accepted and updated as the new value. Press EXIT to cancel editing of numerical values.

3.3 Alarm Conditions

An alarm condition consists of a message that is on the LCD display located beside the built-in keypad.

There are two types of alarm conditions:

- Warning Alarm
- Critical Alarm



A warning alarm is shown when an error or a non-optimal condition has occurred. That will generally not prevent the projector from operating. An example is when a temperature is slightly elevated.

A critical alarm is shown when a condition occurs that could prevent the projector from operating and could cause damage to the projector. This may cause the projector to shut down automatically. An example would be a fan not running.

Both alarm types display:

- The item of alarm
- The status of the item

The item of the alarm can be either physical, i.e. fan or sensor, or the alarm can be a software issue, i.e. lamp driver. The LCD displays the status of the item and its units; if applicable. If the status of the item is out of normal range an alarm is created. When the status of the item is within normal range the alarm will clear.

NOTES: 1) When an alarm is displayed in the LCD display, the built-in keypad is disabled. To confirm the alarm, press the OK soft key to enable the built-in keypad. **2)** The alarm condition can also be viewed using the remote in the read only Status menu.

3.4 SNMP and Email Notifications

The M Series SNMP (Simple Network Management Protocol) interface provides network administrators with a common way to manage their network devices from a single remote location. SNMP allows an administrator to query a number of devices to see their current status/configuration. It also allows operators to change configuration values and configure trap notifications to be sent when certain events occur.

The **SNMP** menu can be accessed from:
Configuration > Communications > SNMP



3.4.1 Controls

Operators are able request the current state of the following controls:

- Power
- Main Input
- Channel
- Lamp Life
- Shutter
- Host Name
- IP Address

3.4.2 Items

Operators are able to request the following status items directly (for quick reference):

- Main software version
- Global alarm status
- Lamp 1 life (just “Lamp Life” if there is no second lamp)
- Lamp 2 life (if applicable)
- Lamp 1 status (just “Lamp Life” if there is no second lamp)
- Lamp 2 status (if applicable)

3.4.3 Traps

A trap is a condition that SNMP monitors on the projector. When the condition is met, a notification is sent via an SNMP notification or email message. Each traps condition can be set to **Disabled**, **SNMP Trap**, **Email** or **SNMP Trap + Email**. The traps are defined in a series of MIB files hosted directly on the projector. MIB files can be accessed from a windows explorer window, using the address `//<hostname>/MIBs`.

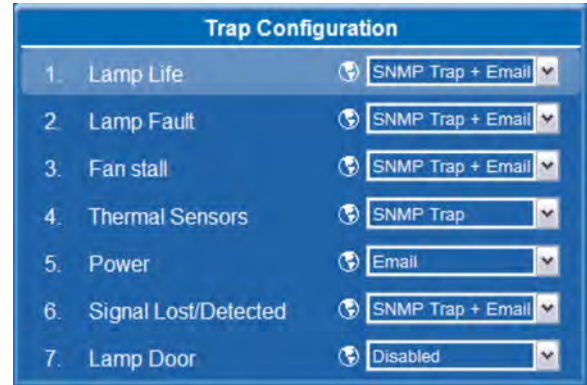

The **Trap Configuration** menu can be accessed from: **Configuration > Communications > SNMP > Trap Configuration**

Operators are able to select from the following trap events to receive up to 3 SNMP traps and 3 email notifications when they occur:

Table 3.3 Available Trap Events

EVENT	MESSAGE (EMAIL NOTIFICATION)	PARAMETERS	TRAP CONFIG. MENU TEXT	DEFAULT NOTIFICATION SETTING
Lamp end of life	Lamp has reached end of life	Lamp Number Lamp Hours Elapsed	Lamp Life	SNMP Trap + Email
Lamp end of life cleared	Lamp end of life cleared	Lamp Number		
Lamp fault	Lamp fault has occurred	Lamp Number Lamp Fault Description	Lamp Fault	
Lamp fault cleared	Lamp fault has been cleared	Lamp Number		
Fan stall	Fan stalled	Fan Name	Fan Stall	
Fan no longer stalled	Fan stall cleared			
Thermal sensor warning	Thermal sensor warning	Thermal Sensor Name Thermal Sensor Text	Thermal Sensors	
Thermal sensor error	Thermal sensor error			
Thermal sensor OK	Thermal sensor OK			
Projector powered on (Standby to Lamps On)	Projector turned on (lamps on)	None	Power	Disabled
Projector powered off (Lamps On to Standby)	Projector turned off (lamps off)			
No video input signal	No video input signal	Frequency	Signal Lost/Detected	
Video input signal detected	Video input signal detected			
Lamp door open	Lamp door has been opened	Lamp Number	Lamp Door	
Lamp door closed	Lamp door has been closed			

3.4.4 Email Notification

When a trap occurs while **Email Notification** is selected for the event, an individual email will be sent to each user defined email recipient. The SNMP menu allows up to 3 email address (up to 64 characters in length) to request notifications from the system during a trap event.

The resulting email will be in the following format:

From: <from@email.com>

To: <to@email.com>

Subject: Christie M Series Projector SNMP Notification

Message:

Projector Name: <projector name>

Location: <SNMP location>

IP Address: <IP address>

Description: <message from Table 3.3>

Parameters: <param 1 from Table 3.3> = <param 1 value>; <param 2 from Table 3.3> = <param 2 value>; ...

4 Maintenance

4.1 Filters

⚠ WARNING Use only special, high efficiency Christie approved filters.

⚠ WARNING This projector is not equipped with fan finger guards. Keep fingers away from the fan blades when replacing filter.

Dust Air Filter

Check projector air dust filters, at minimum, every month.

Dust air filters (if fitted), should be replaced whenever the lamp is replaced or between 200-500 hours, depending on use. A clogged air filter reduces air flow and can lead to overheating and failure of the projector. Check monthly by inspecting its color through the side vent grille with a flashlight. Replace grey colored filters. Leave the filters in their sealed packaging until ready for use.

Replace Filters:

1. Unscrew the 2 captive screws at the top of each filter door (*Figure 4-1 Replace Filter*). Allow the door to rest down and away from the projector.
2. Slide the air filter out and replace, vacuum or wash the filter. Wash using mild soap and water. **NOTE:** *Dry the filter before using.*
3. Insert the new or cleaned air filter(s).
4. Secure the filter door by tightening the 2 captive screws loosened in Step 1.

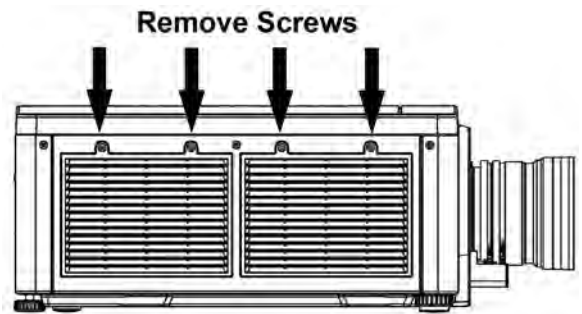

FIGURE 4-1 REPLACE FILTER

Fog Filter

Fog filters should be replaced after each use of the projector to a maximum of 20 hours. The life of the filter is approximately 20 hours based on environmental conditions. Leave the filters in their sealed packaging until ready for use. **NOTE:** *The fog filters cannot be re-used or they will clog up with oil and the projector will overheat and shutdown.*

Replace Filters:

1. Unscrew the 2 captive screws at the top of each filter door (*Figure 4-1 Replace Filter*). Allow the door to rest down, away from the projector.
2. Slide the filter (or dust air filter, if fitted) out.
3. Insert the new air fog filter with ensuring the white layer facing into the projector. **NOTE:** *Each filter is a two-stage filter; the black activated charcoal layer faces out, and the white layer faces the projector.*
4. Secure the filter door by tightening the 2 captive screws loosened in Step 1.

5 Troubleshooting

If the projector is not operating properly, note the symptoms and use this section as a guide to resolve the problem. If the problem cannot be resolved, contact your dealer for assistance. **NOTE:** *A Christie accredited service technician is required when opening an enclosure to diagnose any “probable cause”.*

5.1 Power

5.1.1 Projector Does Not Power ON

1. **Ensure projector is plugged in?** Check power switch above power cord is in the ON position.
2. **Check that the Status LEDs are ON.** While the projector is busy initializing, the LEDs should be cycling. When finished initializing, the Power and Shutter LEDs (the two on the right) should be on.
3. **Check the LCD display.** While the projector is busy initializing, the display should show “Please wait”. When finished initializing, the display should show “Standby mode”.
4. Check the LCD display for any warnings or errors.

5.2 Lamp

5.2.1 Lamp Does Not Ignite

1. **Is there an interlock failure?** Check the LCD display for an error. If the other lamp has ignited and an image can be seen, use the remote keypad and check the **Status** menu for any errors and for the Lamp door interlock status. If not lamp has ignited, use the Virtual OSD on the web interface to check these items. The interlock failure could be an open lamp door or a failed lamp fan.
2. Using the remote keypad or Virtual OSD as above, check the lamp mode in the **Lamp** menu. This may be set to a single lamp or dual lamp mode. Check in the **Status** menu what the reported mode is.
3. For suspected communication failures, power-down the projector and try again.
4. If the lamp does not ignite after the second attempt and after powering down and up again (complete AC power down, then replace the lamp.

5.2.2 Lamp Suddenly Turns OFF

1. Check lamp power through the remote keypad checking the **Lamp** menu or from the web user interface **Advanced: Lamp** menu. Try increasing lamp power.
2. Check for an alarm condition on the LCD keypad display.
3. Replace the lamp.

5.2.3 Flicker, Shadows Or Dimness

1. Check lamp power through the remote keypad checking the **Lamp** menu or from the web user interface **Advanced: Lamp** menu. Try increasing lamp power.
2. Replace the lamp.

5.3 LCD

5.3.1 Blank Screen, No Menu Displaying

1. Press any arrow key on the built-in keypad. The backlight on the LCD and the backlight for the built-in keypad should turn on. If the LCD is still blank, restart the projector.

5.4 Remote Keypad

5.4.1 Remote Keypad Does Not Seem to Work

1. Replace the batteries.
2. Check if IR signals are received by the projector. Pressing any key on the remote control towards the front or rear sensor, the Status LED will blink, regardless if any command is executed. If the LED does not blink, restart the projector.
3. Ensure the remote keypad is enabled. If the projector is powered, using the built-in keypad, open the OSD menu and go to the Main Menu>Configuration>Communication submenu and check the check boxes for Front IR Enabled and Rear IR Enabled are checked. Enable them if they were disabled and try again.
4. Projector is busy. If the projector is busy in a warm-up mode or in a cool-down mode, the commands from the remote keypad may be ignored. Wait until the projector reaches a stable state (Power ON or Stand By) and try again.
5. Press the PROJ key on the remote keypad. If this brings up a pop-up box on the OSD, ensure that the check box is marked to enable the projector.
6. Using the XLR connector, use the remote as a “wired” keypad. If it does work and all the IR sensors have been enabled, then there may be a problem with the IR sensors.

5.5 OSD

5.5.1 The OSD Menu does not display

1. Using the LCD, ensure that OSD menu is enabled, scroll-down until the item OSD appears. The LCD shows “OSD: off”. Press and hold the OSD soft key on the built-in keypad. The LCD now shows “OSD on” then press the menu key on the remote keypad.
OR
2. Press and hold the OSD key on the remote keypad for 2-3 seconds, then press the menu key.

5.6 Ethernet

5.6.1 Trouble Establishing Communication with Projector

1. Ensure any address changes have been saved, and reboot to implement. If you still have trouble establishing communications with a projector added to an existing Ethernet network, the projector's IP address is likely in conflict with another address already in use. Contact your network administrator.
2. Ensure Ethernet settings are valid for the site. All devices should have the same subnet mask yet unique IP addresses.

5.7 Displays

5.7.1 The projector is on but there is no display

1. Was a lens cover accidentally left on? Remove lens cover.
2. On the LCD display, check that the shutter is open. This will also be indicated by the shutter LED being green.
3. Is the correct input selected. Check cable connections.
4. Check if menus appear on the screen.
5. Can you access test pattern? Ensure a full black test pattern has not been selected for display, press Menu to access test patterns, then cycle patterns with keys. Check your source connections again.

5.7.2 Severe Motion Artifacts

1. Most likely there is a synchronization problem with reversed 3-2 pull-down in 60Hz-to-24Hz film-to-digital conversion in your source. Correct at the source.
2. Set the projector to run in Free run. Open OSD menu and go to Input Switching & PIP. Ensure that running mode is set to Free run not to Frame Lock.
3. Display a test pattern on the screen, pressing the Test button on the remote keypad. The test pattern should be displayed correctly. If not, contact your dealer for assistance.

5.7.3 Image Appears 'Squeezed' or Vertically Stretched into Center of Screen

1. Run auto setup, pressing Auto button on the remote keypad.
2. Check your Resizing selection.

5.7.4 The Display is Jittery or Unstable

1. If the display is jittery or blinking erratically, ensure that the source is properly connected and of adequate quality for detection. With poor quality or improperly connected source, the projector will repeatedly attempt to display an image, however briefly.
2. The horizontal and vertical scan frequency of the input signal may be out of range for the projector. See [Section 6 Specifications](#) for scan frequency ranges.
3. The sync signal may be inadequate. Correct the problem at the source.

5.7.5 The Display is Faint

1. Brightness and/or contrast and/or gamma may be set incorrectly.
2. The source may be double terminated. Ensure the source is terminated only once.
3. The source (if non-video) may need a different sync tip clamp location.

5.7.6 The Upper Portion of the Display is Waving, Tearing or Jittering

This can occur with video or VCR sources. Check your source.

5.7.7 Portions of the Display are Cut Off or Warped to the Opposite edge

Resizing may need adjustment. Adjust until entire image is visible and centered.

5.7.8 Display Appears Compressed (Vertically Stretched)

1. The frequency of the pixel sampling clock is incorrect for the current source.
2. Sizing and positioning options may be adjusted poorly for the incoming source signal.
3. Use an anamorphic lens for typical HDTV and anamorphic DVD sources that have been re-sized and vertically stretched, via 3rd-party software.

5.7.9 Data is Cropped from Edges

To display the missing material, reduce image size to fill the display area available in the projector, then stretch vertically to fill the screen from top to bottom. Add the anamorphic lens to regain image width.

5.7.10 Display Quality Appears to Drift from Good to Bad, Bad to Good

1. The source input signal may be of low quality.
2. The H or V frequency of the input may have changed at the source end.

5.7.11 Display has Suddenly Frozen

If the screen blacks out inexplicably, it is possible that excessive voltage noise on the AC or ground input has interrupted the projector's ability to lock on to a signal. Power down the projector and disconnect from AC. Then plug in again and power up as usual.

5.7.12 Colors in the Display are Inaccurate

1. The color, tint, color space and/or color temperature settings may require adjustment at your input source.
2. Try Auto Setup.
3. Ensure signal connections are correct.
4. Ensure the proper channel for this source is being used.

5.7.13 Display is Not Rectangular

1. Check leveling of the projector. Ensure the lens surface and screen are parallel to one another.
2. Is the vertical offset correct? Make the necessary adjustments to the vertical offset on the lens mount.

5.7.14 Display is "Noisy"

1. Display adjustment at the input source may be required. Adjust pixel tracking, phase and filter. Noise is particularly common on YPbPr signals from a DVD player.
2. Ensure the video input is terminated (75 ohms). If it is the last connection in a loop-through chain, the video input should be terminated at the last source input only.
3. The input signal and/or signal cables carrying the input signal may be of poor quality.
4. If the distance between the input source device and the projector is greater than 25 feet, signal amplification/conditioning may be required.
5. If the source is a VCR or off-air broadcast, detail may be set too high.

5.8 Web Interface

5.8.1 After upgrading the projector software, the Web pages do not display correctly

1. After upgrading, the temporary internet files and cookies must be cleared from the Web Internet Browser to ensure that Web UI changes can take effect.
2. Using the Internet Explorer menu bar, select **Tools>Internet Options**. Click **Delete** from the **Browsing history** option. Click **Delete files**. Once the Delete Files window displays, click **Yes**. Then click **Delete cookies**. Once the **Delete Cookies** window displays, click **Yes** then click Close. Click **OK** to close the **Internet Options** window.
3. Close the browser and re-open before connecting to the projector.

5.8.2 A backup or Interrogator file cannot be saved

After performing a backup of Interrogator, you may be prompted from a pop-up window before saving the file. If you have not specifically set Internet Explorer to automatically open/save the file without prompting, and if pop-up windows have been disabled (by enabling the pop-up blocker), then you will not be able to save the file.

Disable the pop-up blocker from **Main>Tools>Pop-up Blocker**. **NOTE:** *Different types of toolbars have the potential to block pop-ups.*

-OR-

1. Using the Internet Explorer menu bar, select **Tools>Internet Options** to open the Internet Options window.
2. Select **Internet**, then click **Custom Level** to open the **Security Settings-Internet Zone** window.
3. Scroll down the list until you see "Downloads" option setting. Ensure the "**Automatic prompting for file downloads**" and "**File Download**" options are **enabled**, then click **OK**. Once the **Warning** window displays, click **OK**.
4. Using the Internet Option window, select **Local intranet**, then click **Custom Level**. Repeat Step 3.
NOTE: *Other versions of Internet Explorer may display different options.*

6 Specifications

This section provides detailed M Series features; including inputs, lamp, and power requirements.

NOTE: *Due to continuing research, detailed features are subject to change without notice.*

6.1 Feature Set

6.1.1 Air Filters (Optional)

Filter media types	Coarse foam filter Fog filter
Filter access	Service-interchangeable via access panel

6.1.2 Lamps

Dual Mercury lamp system	Lamps are accessed from side of projector Lamps are individually swappable while the projector is running
--------------------------	--

6.2 Input (Source Signal) Compatibility

Analog (Only) Input
Twin HDMI Input
Dual Link DVI Input
Video Decoder Input
Dual 3G/SD/HD-SDI Input
DMX512 Interface

6.3 Control Signal Compatibility

6.3.1 Projector Control

Remote Control
RS-232
RS-422
Ethernet
USB 2.0 Device Port
GPIO
DMX512 Interface
Built-In Keypad and Display
AMX/Crestron Support

6.4 Power Requirements

Rated voltage	100 VAC – 240 VAC
Rated Current (dual lamp operation)	
450W 1080p / SXGA+ / WUXGA	15 A @ 100 VAC
370W 1080p / SXGA+ / WUXGA / WXGA	12 A @ 100 VAC
200W 1080p / SXGA+ / WUXGA / WXGA	9 A @ 100 VAC
Line frequency	50/60 Hz
AC Input Coupler	15 A, 250 VAC
Type of connector	IEC 320-C14 with wire cable clamp
Line Cord	14AWG type FT1 with plug, NEMA 5-15P, 15A
Inrush Current	60 A max
Maximum Power Consumption	Dual Lamp
1080p / SXGA+ / WUXGA	1500W (dual lamp) / 750W (single lamp)
1080p / SXGA+ / WUXGA / WXGA	1320W (dual lamp) / 831W (single lamp)
1080p / SXGA+ / WUXGA / WXGA	1267W (dual lamp) / 805W (single lamp)
1080p / SXGA+ / WUXGA / WXGA	1135W (dual lamp) / 739W (single lamp)
1080p / SXGA+ / WUXGA / WXGA	871W (dual lamp) / 607W (single lamp)
1080p / SXGA+ / WUXGA / WXGA	739W (dual lamp) / 541W (single lamp)

6.4.1 Lamp Specification

Type	Mercury Lamp (Hg)
Power	
450W HD / SX+ / WU	360W min, 462W max (software adjustable)
350W HD / SX+ / WU / WX	300W min, 370W max (software adjustable)
200W HD / SX+ / WU / WX	150W min, 200W max (software adjustable)
DLV Models (HD / SX+)	150W only, (not software adjustable)
450W Lamp rated lamp life to 50% brightness	1250 hrs typical @ 450W 1500 hrs typical @ 360W
350W Lamp rated lamp life to 50% brightness	1300 hrs typical @ 370W 1500 hrs typical @ 350W 2000 hrs typical @ 300W
200W Lamp rated lamp life to 50% brightness	2000 hrs typical @ 200W 3000 hrs typical @ 150W
Warm-up time (to full output)	5 minutes max
Operating position	±20 degrees max tilt of lamp axis from horizontal

6.5 Accessories and Service Components

PRODUCT NAME	PART NUMBER	SOLD WITH PRODUCT	SOLD SEPARATELY
Standard Image Processor	108-315101-XX	✓	✓
Dual Image Processor	108-316101-XX	✓	✓
Analog Input	108-309101-XX	✓	✓
Dual Link DVI Input	108-312101-XX	✓	✓
Video Decoder Input	108-310101-XX	✓	✓
Dual 3G/SD/HD-SDI Input	108-313101-XX	✓	✓
Twin HDMI Input	108-311101-XX	✓	✓
DMX512 Interface	108-314101-XX	✓	✓
Air Filter Dust	118-100104-XX	✓	✓
Air Filter Fog	118-100105-XX	✓	✓
Stacking Frame	118-100107-XX	✗	✓
Ceiling Mount	118-100108-XX	✗	✓
Lens ILS 0.73:1SX+/0.67:1HD	118-100110-XX	✗	✓
Lens ILS 1.25-1.6SX+/1.16-1.49HD	118-100111-XX	✗	✓
Lens ILS 1.5-2.0SX+/1.4-1.8HD	118-100112-XX	✗	✓
Lens ILS 2.0-2.8SX+/1.8-2.6HD	118-100113-XX	✗	✓
Lens ILS 2.8-4.5SX+/2.6-4.1HD	118-100114-XX	✗	✓
Lens ILS 4.5-7.5SX+/4.1-6.9HD	118-100115-XX	✗	✓
Lens ILS 7.5-11.2SX+/6.9-10.4HD	118-100116-XX	✗	✓
Lens ILS 1.2SX+/1.1HD	118-100117-XX	✗	✓
Lens ILS 1.2SX+/1.1HD	118-101103-XX	✗	✓
Portrait Adapter	118-116109-XX	✗	✓
Module IR Keypad w/Laser	002-100005-XX	✓	✓
HARN Wired Keypad External	001-100704-XX	✓	✓
User Manual	020-100009-XX	✓	✗
Service Manual	020-100010-XX	✗	✓
AutoSTACK	108-308101-XX	✗	✓

6.6 Lens Throw Ratio

	LENS DESCRIPTION	PART NUMBER	THROW RATIO			
			WXGA	SXGA+	HD	WUXGA
FIXED	Lens ILS 0.73:1SX+/0.67:1HD	118-100110-XX	0.75	0.73	0.67	0.67
	Lens ILS 1.2SX+/1.1HD	118-100117-XX	1.23	1.2	1.1	1.1
	Lens ILS 1.25-1.6SX+/1.16-1.49HD	118-100111-XX	1.28-1.64	1.25-1.6	1.16-1.49	1.16-1.49
	Lens ILS 1.5-2.0SX+/1.4-1.8HD	118-100112-XX	1.54-2.05	1.5-2.0	1.4-1.8	1.4-1.8
ZOOM	Lens ILS 2.0-2.8SX+/1.8-2.6HD	118-100113-XX	2.05-2.87	2.0-2.8	1.8-2.6	1.8-2.6
	Lens ILS 2.8-4.5SX+/2.6-4.1HD	118-100114-XX	2.87-4.61	2.8-4.5	2.6-4.1	2.6-4.1
	Lens ILS 4.5-7.5SX+/4.1-6.9HD	118-100115-XX	4.61-7.69	4.5-7.5	4.1-6.9	4.1-6.9
	Lens ILS 7.5-11.2SX+/6.9-10.4HD	118-100116-XX	7.69-11.48	7.5-11.2	6.9-10.4	6.9-10.4

6.7 Regulatory

6.7.1 Safety

- CAN/CSA C22.2 No. 60950-1-07 2nd Edition
- UL 60950-1, 2nd Edition
- IEC 60950-1:2005, 2nd Edition
- EN60950:2006 + A11:2009

6.7.2 Electro-Magnetic Compatibility

Emissions

- FCC CFR47, Part 15, Subpart B, Class A - Unintentional Radiators
- CISPR 22/EN55022 Class A - Information Technology Equipment

Immunity

- CISPR 24/EN55024 Class A - Information Technology Equipment

6.7.3 Environmental

The product must conform to:

- EU Directive (2002/95/EC) on the restriction of the use of certain hazardous substances (RoHS) in electrical and electronic equipment and the applicable official amendment(s).
- EU Regulation (EC) No. 1907/2006 on the registration, evaluation, authorization and restriction of chemicals (REACH) and the applicable official amendments.
- EU Directive (2002/96/EC) on waste and electrical and electronic equipment (WEEE) and the applicable official amendment(s).
- China Ministry of Information Industry Order No.39 (02/2006) on the control of pollution caused by electronic information products, the hazardous substances concentration limits (SJ/T11363-2006), and the applicable product marking requirement (SJ/T11364-2006).

6.7.4 Marking

This product shall conform to all relevant Canadian, US, and European directives, standards, safety, health and environmental concerns and bare the following markings at product launch:

- UL
- CE
- RoHS
- WEEE
- Future International Certifications to include: CCC, KC, PSE, c-tick, Gost-R, South Africa

International packaging recycling mark requirements:

- EU Directive (2002/96/EC) on waste and electrical and electronic equipment (WEEE);
- EU Directive (94/62/EC) on packaging and packaging waste;
- China packaging recycling mark standard (GB18455-2001).

Appendix A: GPIO

This section explains how to use a GPIO link from the projector to external equipment, such as devices for 3D synchronizing.

A.1 GPIO Port

The GPIO connector located on the input panel provides a flexible method of interfacing a wide range of external I/O devices to the projector. There are 7 GPIO pins available on the 9pin D-Sub GPIO connector, which are configurable via RS-232 commands. The other two pins are reserved for ground and power - see table below for pin identification.

NOTE: *The serial cable required for connecting the external device to the projector's GPIO connector, must be compatible with the external device.*

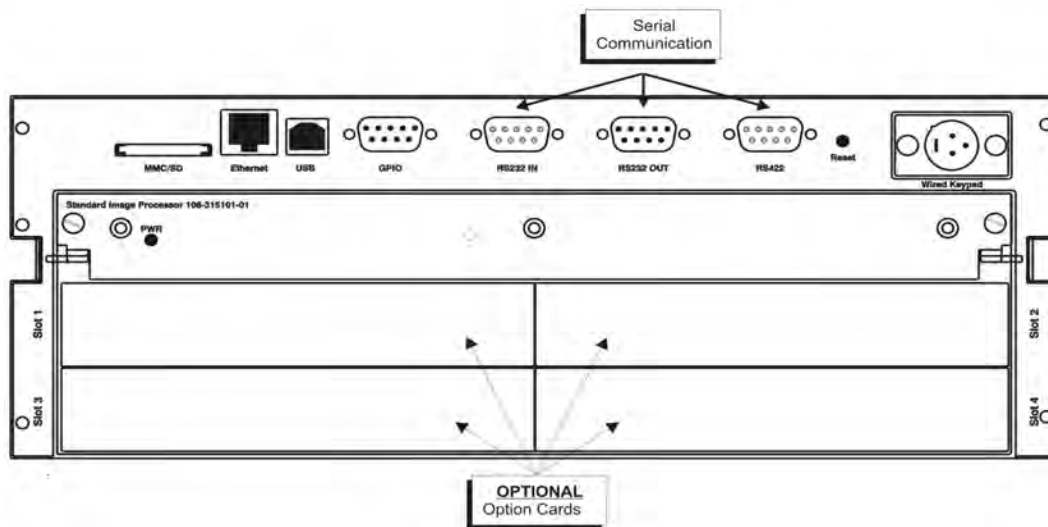
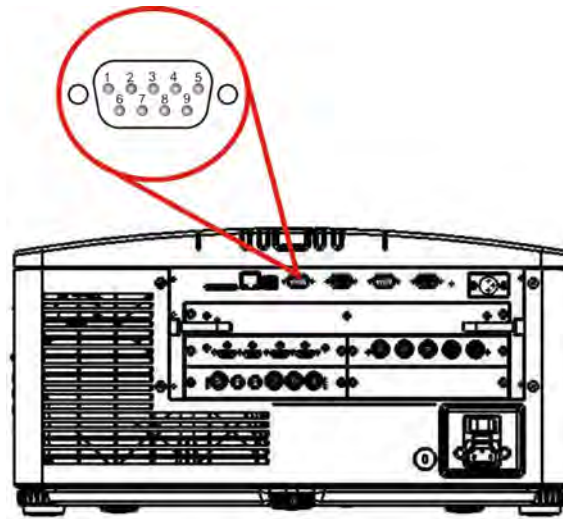

Table A.1 GPIO Pin

GPIO PINS	
PIN #	SIGNAL
Pin 1	+ 12V (200mA)
Pin 2	GPIO 2
Pin 3	GPIO 4
Pin 4	GPIO 6
Pin 5	Ground
Pin 6	GPIO 1
Pin 7	GPIO 3
Pin 8	GPIO 5
Pin 9	GPIO 7



A.1.1 Configuring the GPIO

The GPIO connector can be configured to automate any number of events using the serial command code **GIO**. Each Pin is defined as either an *input* or *output* depending on the desired outcome. Configure the pin as an input if you want the projector to respond to something the device does and as an output if you want the external device to respond to an action taken by the projector. For example, configure the pin as an output if you want the lighting in a room to automatically dim when the projector is turned on.

By using the GIO command, you can also set the state of each output pin as *high* or *low*. By default, the state of each pin is *high*. The voltage applied to pins in the high state is +3.3 V.

A low state (or value of 0) will be read on an input pin if the circuit attached to the pin is open. A high state (or value of 1) will be read on an input pin if the circuit attached to the pin is shorted to ground. This corresponds to a switch closing event.

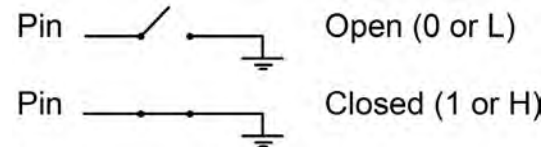

Example. Turn room lighting on when the projector is turned off (*Assumes a control/automation unit is configured to turn the lights on when pin 2 of its input goes high*).

- (GIO+CNFG “OOOIII”) Set pin #2, 3 and 4 configuration to output and pin 6, 7, 8 and 9 to input
- (GIO+STAT “HLXXXX”) Set pin #2 to high, pin 3 to low and the state of all other pins unchanged
- (GIO+STAT) Request the state of all pins
- (GIO+STAT “HLLHLLH”) Reply of pin states - H means pin is high, L means pin is low
- (GIO+CNFG) Request the configuration of all pins
- (GIO+CNFG “IIIOOOO”) Reply of pin configurations - pins 2, 3 and 4 are Inputs, pins 6, 7, 8 and 9 are Outputs

NOTE: The strings in the commands refer to pins 2, 3, 4, 6, 7, 8, 9 in order from left to right.

Corporate offices

USA – Cypress
ph: 714-236-8610
Canada – Kitchener
ph: 519-744-8005

Worldwide offices

United Kingdom
ph: +44 118 977 8000
France
ph: +33 (0) 1 41 21 00 36
Germany
ph: +49 2161 664540

Eastern Europe
ph: +36 (0) 1 47 48 100
Middle East
ph: +971 (0) 4 299 7575
Spain
ph: + 34 91 633 9990

Singapore
ph: +65 6877-8737
Beijing
ph: +86 10 6561 0240
Shanghai
ph: +86 21 6278 7708

Japan
ph: 81-3-3599-7481
South Korea
ph: +82 2 702 1601