

Caution: This document contains mixed page sizes (8.5 x 11 or 11 x 17), which may affect printing. Please adjust your printer settings according to the size of each page you wish to print.

Onan

**Service
Manual**

YHB

Generator

**YHB Generator
with Torque Match-II Regulator™**

Safety Precautions

The following symbols in this manual highlight conditions potentially dangerous to service personnel, or equipment. Read this manual carefully. Know when these conditions can exist. Then take necessary steps to protect personnel as well as equipment.

▲ DANGER *This symbol warns of immediate hazards which will result in severe personal injury or death.*

▲ WARNING *This symbol refers to a hazard or unsafe practice which can result in severe personal injury or death.*

▲ CAUTION *This symbol refers to a hazard or unsafe practice which can result in personal injury or product or property damage.*

PROTECT AGAINST MOVING PARTS

Avoid moving parts of the unit. Avoid use of loose jackets, shirts or sleeves due to danger of becoming caught in moving parts.

Make sure all nuts and bolts are secure. Keep power shields and guards in position.

If you must make adjustments while the unit is running, use extreme caution around hot manifolds, moving parts, etc.

Do not work on this equipment when mentally or physically fatigued.

GUARD AGAINST ELECTRIC SHOCK

Disconnect electric power before removing protective shields or touching electrical equipment. Use rubber insulative mats placed on dry wood platforms over floors that are metal or concrete when around electrical equipment. Do not wear damp clothing (particularly wet shoes) or allow skin surfaces to be damp when handling electrical equipment.

Disconnect batteries to prevent accidental engine start. Jewelry is a good conductor of electricity and should be removed before working on electrical equipment.

Use extreme caution when working on electrical components. High voltages cause injury or death.

Follow all state and local codes. To avoid possible personal injury or equipment damage, a qualified electrician or an authorized service representative must perform installation and all service.

▲ WARNING

EXHAUST GAS IS DEADLY!

Exhaust gases contain carbon monoxide, an odorless and colorless gas. Carbon monoxide is poisonous and can cause unconsciousness and death. Symptoms of carbon monoxide poisoning can include:

- Dizziness
- Nausea
- Headache
- Weakness and Sleepiness
- Throbbing in Temples
- Muscular Twitching
- Vomiting
- Inability to Think Coherently

IF YOU OR ANYONE ELSE EXPERIENCE ANY OF THESE SYMPTOMS, GET OUT INTO THE FRESH AIR IMMEDIATELY. If symptoms persist, seek medical attention. Shut down the unit and do not operate until it has been inspected and repaired.

Protection against carbon monoxide inhalation includes proper installation and regular, frequent visual and audible inspections of the complete exhaust system.

Table of Contents

SECTION	TITLE	PAGE
	SAFETY PRECAUTIONS	ii
1	INTRODUCTION	1-1
	About This Manual	1-1
	Test Equipment.....	1-1
	How to Obtain Service	1-1
2	GENERATOR AND VOLTAGE REGULATOR	2-1
	Generator Description	2-1
	Generator Operation	2-4
	Voltage Regulator Description.....	2-5
	Voltage Regulator Adjustments	2-5
3	GENERATOR/REGULATOR TROUBLESHOOTING	3-1
	Control Locations	3-1
	Preparation	3-1
	Troubleshooting Procedures	3-1
	Flow Chart A. No AC Output Voltage at Rated Engine Speed	3-2
	Flow Chart B. Unstable Voltage, Engine Speed Stable at Rated Speed	3-3
	Flow Chart C. Output Voltage Too High or Too Low	3-3
	Flow Chart D. Exciter Field Breaker Trips	3-4
	Flow Chart E. Unbalanced Generator Output Voltage	3-5
4	GENERATOR/REGULATOR TESTS/ADJUSTMENTS	4-1
	(A) Testing AC Residual Voltage	4-1
	(B) Flashing the Field	4-1
	(C) Voltage Regulator VRAS-2 Replacement	4-2
	(D) Testing Rotating Rectifiers (Diodes)	4-2
	(E) Testing Exciter Stator	4-3
	(F) Testing Exciter Rotor	4-3
	(G) Testing Generator Stator	4-4
	(H) Testing Generator Rotor	4-5
	(J) Wiring Harness Check	4-5
	(K) Voltage Regulator VRAS-2 Adjustment	4-5
	(L) Generator Voltage Adjust (R21)	4-6
5	GENERATOR DISASSEMBLY/ASSEMBLY	5-1
	Generator Disassembly	5-1
	Generator Assembly	5-4
6	WIRING DIAGRAMS	6-1

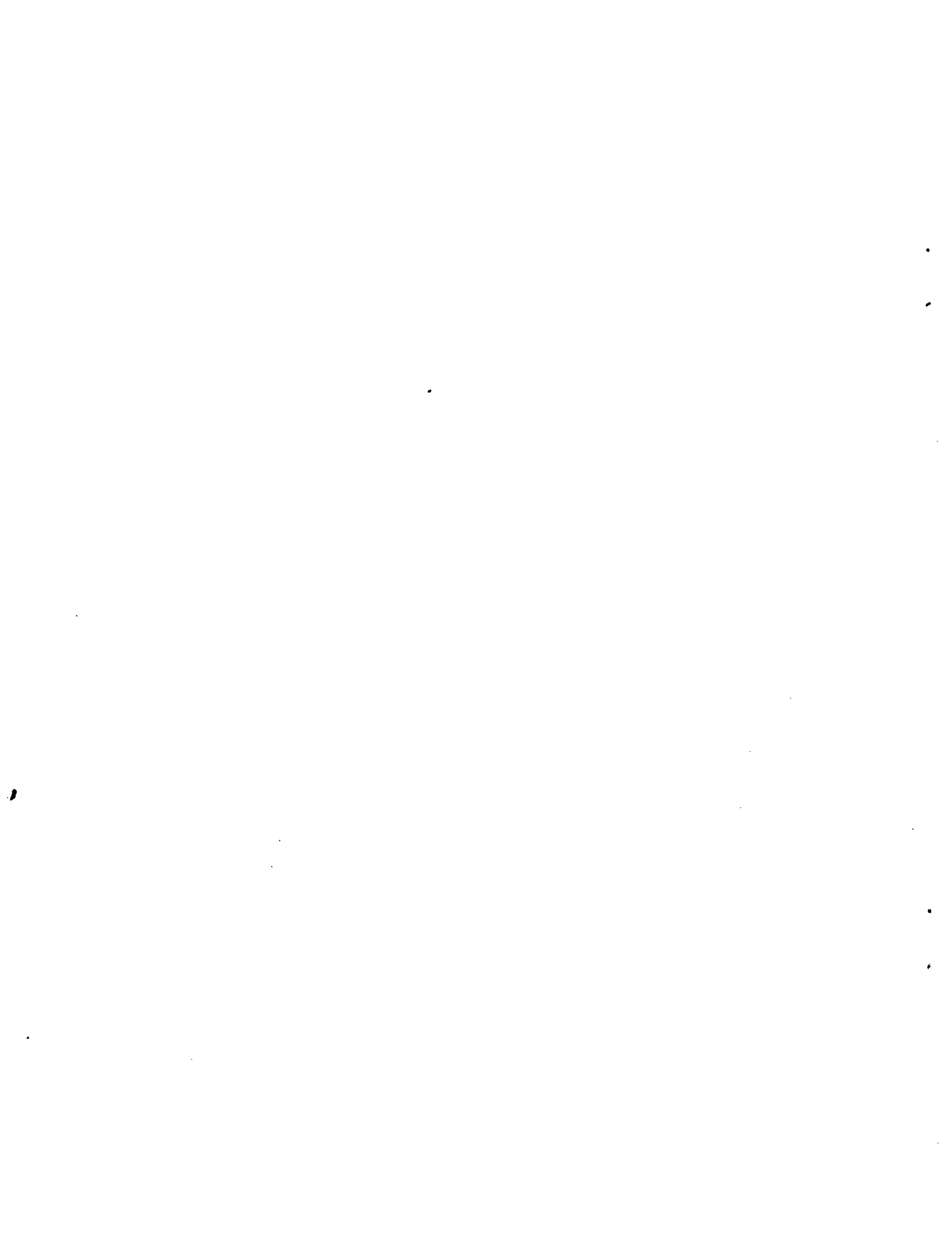

Section 1. Introduction

ABOUT THIS MANUAL

This manual provides troubleshooting and repair information regarding the Onan series YHB generator in connection with a Torque Match-II (VRAS-2) voltage regulator. For further operation, service, and troubleshooting information regarding engine or controller components, refer to support manuals specific to your generator set.

Study all manuals carefully and observe all warnings and cautions. Knowing your generator set, using it properly, and following a regular maintenance schedule will result in longer unit life, better performance, and safer operation.

Repair information in this manual for printed circuit board components other than fuses is not extensive as solid state printed circuit boards lend themselves more to replacement than repair. Application of meters or hot soldering irons to printed circuit boards by other than qualified personnel can cause unnecessary and expensive damage. Repair of the printed circuit boards is not recommended except by the factory.

CAUTION *High voltage testing or high potential (or Megger) testing of generator windings can cause damage to solid state components. Isolate these components before testing.*

TEST EQUIPMENT

Most of the test procedures in this manual can be performed with an AC-DC multimeter such as a Simpson Model 260 VOM or a digital VOM. Some other instruments to have available are:

- Onan Multitester
- Jumper Leads
- AC Voltmeter
- DC Voltmeter
- Wheatstone or Kelvin Bridge

See Onan Tool Catalog 900-0019.

HOW TO OBTAIN SERVICE

In the event the generator requires servicing beyond the scope of information contained in this manual, contact an Onan Distributor for assistance. Onan factory trained Parts and Service representatives are ready to handle all your service needs.

When contacting an Onan Distributor, always supply the complete Model number and Serial number as shown on the Onan nameplate. The Onan nameplate is located on the side of the generator control box.

Onan

Model No. _____

Serial No. _____

Important - Give above no.'s when ordering parts

Service Rating: _____

Hertz: _____ RPM: _____

Single Phase	kW	KVA				
Three Phase	kW	KVA				
Volts:	110/190	110/220	115/200	115/230	120/208	
Amps:						
	120/240	127/220	139/240	220/380	230/400	240/416
	240/480	254/440	277/480	347/600	115/230 10	120/240 10

For Elec Eqpt Only _____ PF: _____ Bat.: _____

Insul - NEMA Class **F** Amb 40°C

Onan Corp
Minneapolis Mn
55432 USA
Made in USA

99-103

M-1641

FIGURE 1-1. ONAN NAMEPLATE

WARNING

INCORRECT SERVICE OR REPLACEMENT OF PARTS CAN RESULT IN SEVERE PERSONAL INJURY AND/OR EQUIPMENT DAMAGE. SERVICE PERSONNEL MUST BE QUALIFIED TO PERFORM ELECTRICAL AND/OR MECHANICAL SERVICE.



Section 2. Generator and Voltage Regulator

GENERATOR DESCRIPTION

The YHB generator is a two pole, revolving field generator designed for 3000 (50 Hz) or 3600 (60 Hz) r/min operation. Excitation is provided with a brushless exciter mounted outboard of the generator. The generator rotor is directly coupled to the engine flywheel with a flexible drive disc. Engine speed determines generator output voltage and frequency. A centrifugal blower (on the drive disc) circulates discharged air through an outlet in the blower end. See Figure 2-1.

As specified in Voltage/Current Options, Table 2-1, Voltage Code 15 and 515 generators are reconnectable to provide the listed voltage options. Output rating is 0.8 PF. See Figure 2-2 and Table 2-1.

Five of the AC output leads extending from the stator housing are tapped with control wires (leads: 4,7,8,9 and 10). These control wires are routed into the control box and used for control input and metering, Figure 2-3.

The brushless exciter stator mounts in the end bell while the exciter rotor and its rotating rectifier assemblies mount on the generator rotor shaft. Within the endbell, leads F1+ and F2- from the exciter stator winding are connected to the output terminals of the voltage regulator, Figure 2-3.

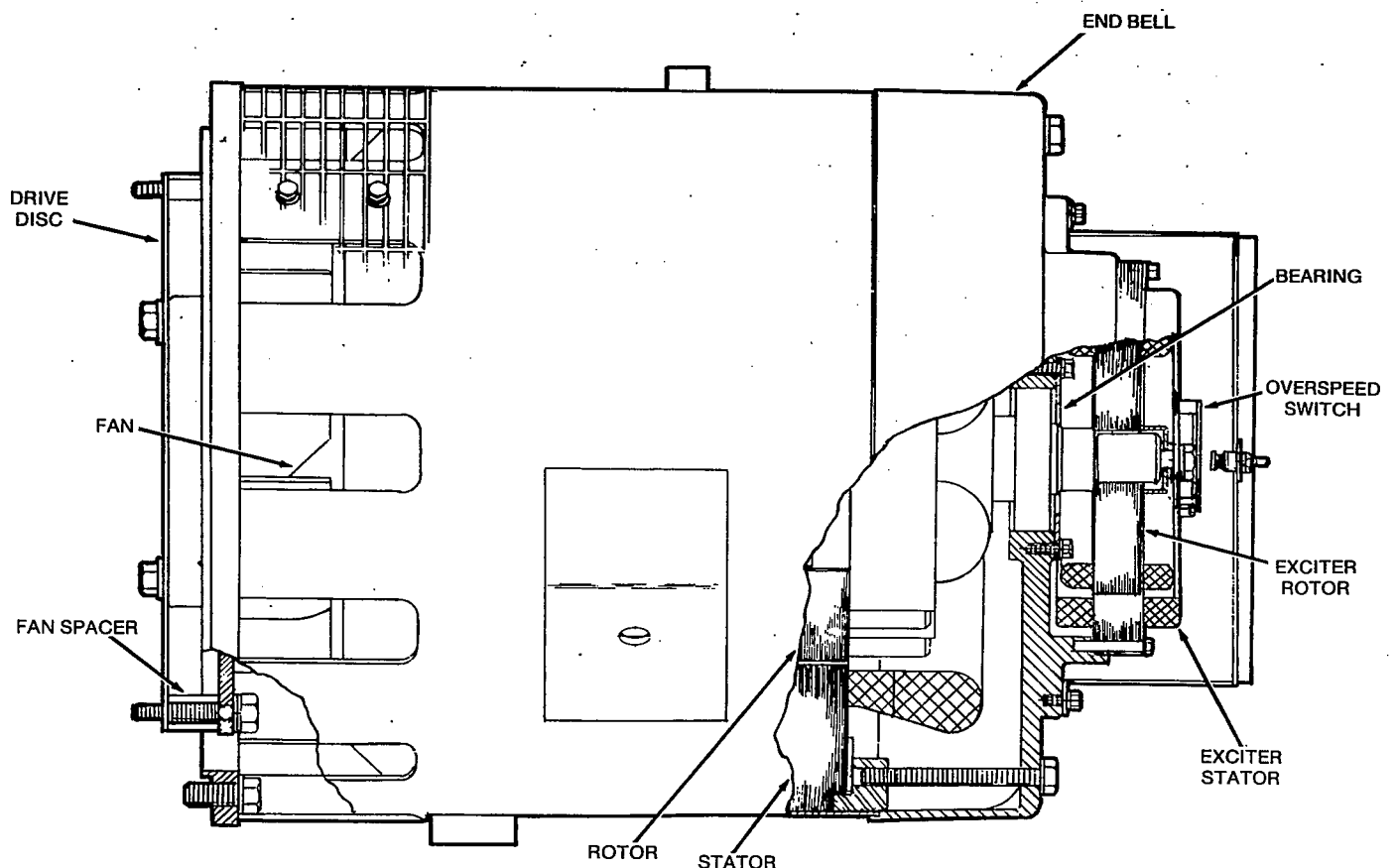
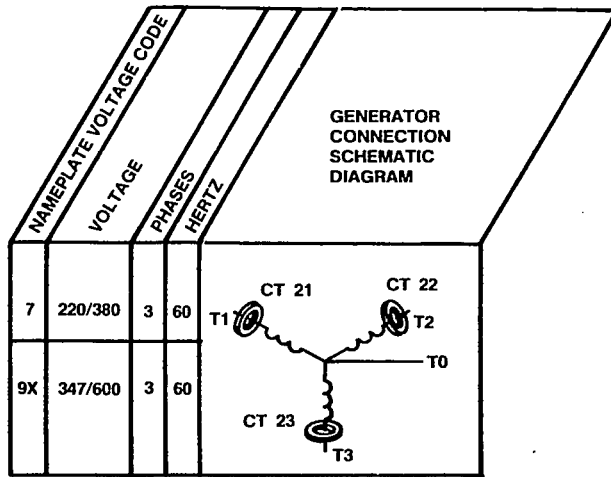

FIGURE 2-1. YHB GENERATOR

G-1159



THIS DIAGRAM APPLIES TO 12 LEAD GENERATORS ONLY

NAMEPLATE VOLTAGE CODE	VOLTAGE	PHASES	HERTZ	GENERATOR CONNECTION	GENERATOR CONNECTION SCHEMATIC DIAGRAM	GENERATOR CONNECTION WIRING DIAGRAM (WITH CURRENT TRANSFORMERS WHEN USED)
15	120/240	1	60	DOUBLE DELTA		
515	115/230	1	50			
	110/220	1	50			
15	120/240	3	60	SERIES DELTA		
515	115/230	3	50			
	110/220	3	50			
15	120/208	3	60	PARALLEL WYE		
515	127/220	3	60			
	139/240	3	60			
	110/190	3	50			
	115/200	3	50			
	120/208	3	50			
	127/220	3	50			
15	240/416	3	60	SERIES WYE		
515	254/440	3	60			
	277/480	3	60			
	220/380	3	50			
	230/400	3	50			
	240/416	3	50			
	254/440	3	50			

NOTE: This figure is for reference only. Refer to electrical schematic specific to your generator for further connection information.

FIGURE 2-2. GENERATOR VOLTAGE CONNECTIONS

TABLE 2-1. YHB VOLTAGE/CURRENT OPTIONS

Voltage	Freq.	Maximum Current (Amperes)				Parallel Wye	Series Wye	Series Delta
		30 kW	35 kW	45 kW	50 kW			
Code 515								
110/190	50 Hz	114	-	152	-	x		
115/200	50 Hz	108	-	145	-	x		
120/208	50 Hz	104	-	139	-	x		
127/220	50 Hz	99	-	131	-	x		
110/220	50 Hz	99	-	131	-			x
115/230	50 Hz	94	-	126	-			x
220/380	50 Hz	57	-	76	-		x	
230/400	50 Hz	54	-	72	-		x	
240/416	50 Hz	52	-	69	-		x	
254/440	50 Hz	49	-	66	-		x	
Code 15								
120/208	60 Hz	-	121	-	174	x		
127/220	60 Hz	-	115	-	164	x		
139/240	60 Hz	-	105	-	150	x		
120/240	60 Hz	-	105	-	150			x
240/416	60 Hz	-	61	-	86		x	
254/440	60 Hz	-	57	-	82		x	
227/480	60 Hz	-	53	-	76		x	
Code 7R*								
220/380	60 Hz	-	66	-	94		x	
Code 9XR*								
347/600	60 Hz	-	42	-	60		x	

* - Single-phase power can be taken in capacities up to full rated 3-phase kW at 1.0 PF. Broad range alternators have 12 leads brought out for user reconnect.

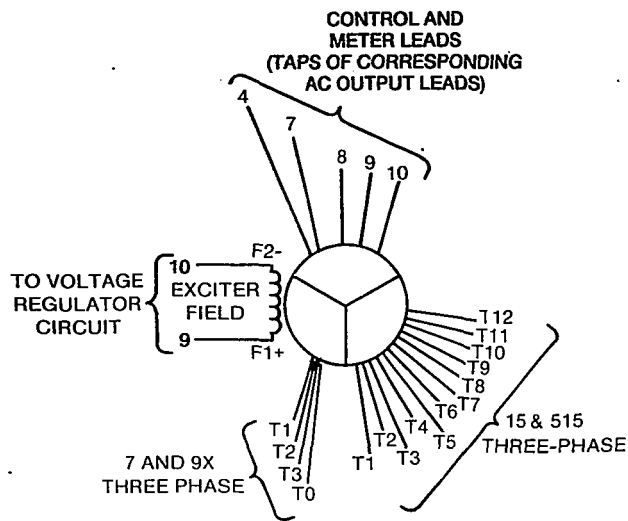

FIGURE 2-3. THREE-PHASE GENERATOR SCHEMATIC

Optional Circuit Breaker

Most Onan generator sets are installed for use with exterior circuit breakers and transfer switch equipment. But, depending on customer requirements, an optional generator output circuit breaker might be mounted on side of generator box housing, Figure 2-4. Review the installation specifications for information regarding the addition of this circuit breaker. If so equipped, be sure to add its actuation (ON and OFF) to your operating and troubleshooting procedures.

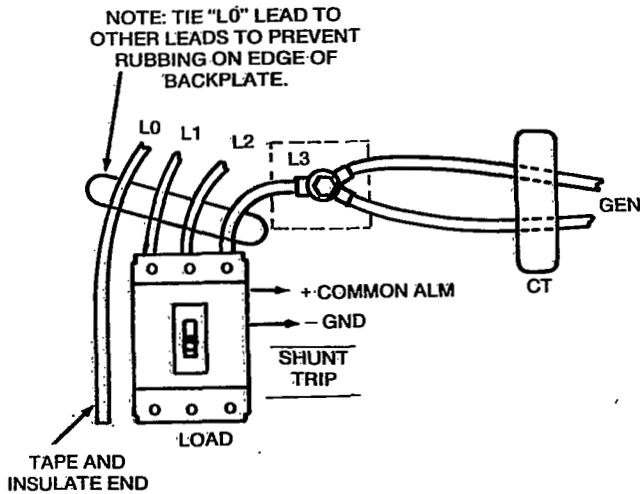

FIGURE 2-4. OPTIONAL CIRCUIT BREAKER

GENERATOR OPERATION

With the generator directly coupled to the engine fly-wheel, full rated output voltage is accomplished in a matter of seconds. The following briefly describes generator operation and voltage regulator interaction, in reference to Figure 2-5.

Refer to Voltage Regulation for further specifics regarding regulator operating modes.

1. Demand for power starts the engine, thereby turning the generator rotor.
2. Residual magnetism in the rotor's main field, induces voltage in the main stator.
3. Single-phase AC voltage is taken from the main stator winding and fed to the Torque Match-II Voltage Regulator (VRAS-2) as a reference voltage.
4. The voltage regulator compares the input with preset requirements, rectifies AC to DC, and sends a DC voltage to the exciter field.
5. The exciter stator field induces voltage in the exciter armature.
6. Three-phase AC voltage is tapped from the exciter and fed to the rotating full-wave bridge rectifiers.
7. DC voltage from the rotating rectifiers is fed to the main field of the generator rotor.
8. The main field continues to build until rated (or preset) voltage is reached.

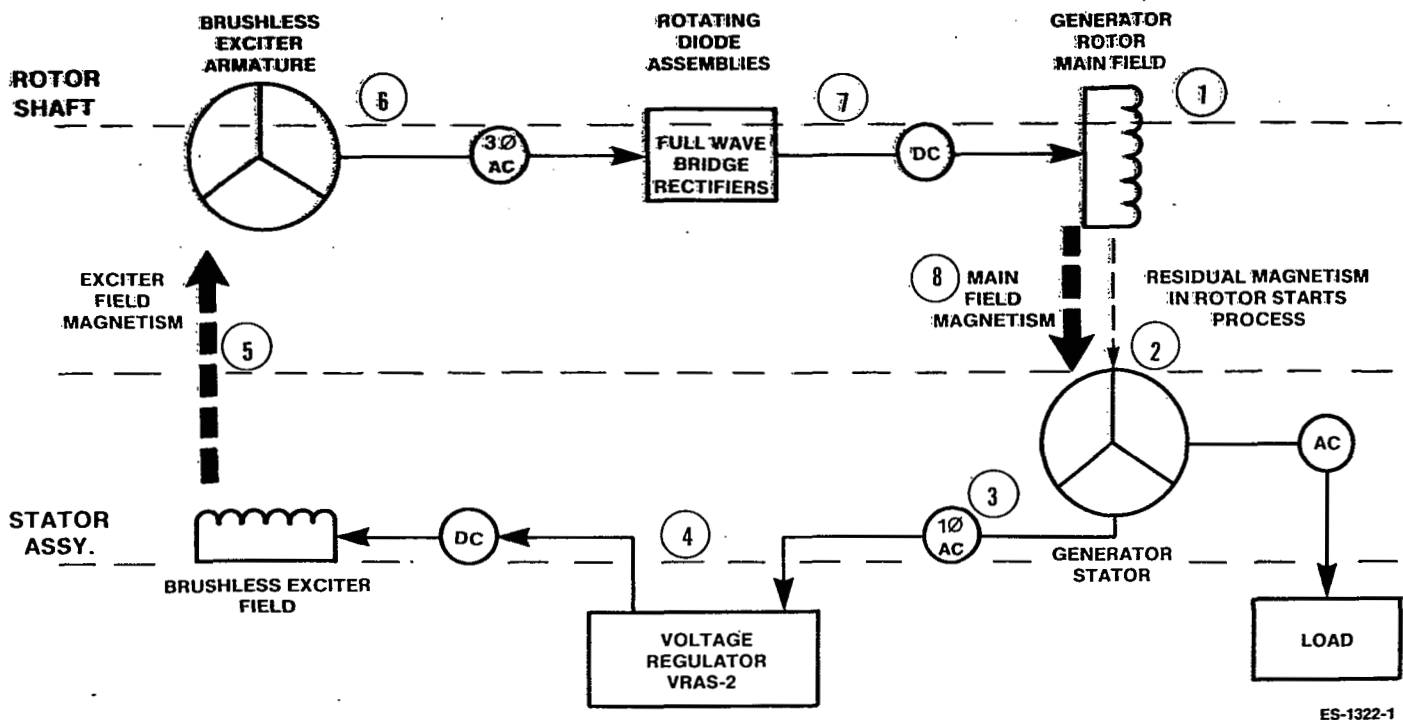

ES-1322-1

FIGURE 2-5. EXCITATION BLOCK DIAGRAM

VOLTAGE REGULATOR DESCRIPTION

The design of the Torque Match-II Voltage Regulator (VRAS-2) provides switch selections that alter its sensing and command signals in order to achieve maximum operating performance in a variety of generator sizes and applications. Review the following, then refer to Voltage Regulator Adjustments for switch locations and settings specific to your generator set model.

Operating Modes

Torque-Matching: In most applications, in order for the generator set to accept the application of a large momentary overload, such as motor starting, matching the torque characteristics of the engine and generator is required.

Because of the differences in engine characteristics, different torque matching may be used for various engine/generator combinations. The switch-selectable design of the VRAS-2 provides Onan the flexibility to test and set the torque-matching function to best suit each engine/generator configuration.

When set to the proper torque-matching switch settings, the VRAS-2 voltage regulator is able to maintain output voltage, within reasonable limits, by reducing the voltage just enough to take full advantage of the engine's full available power under transient conditions and prevent an unstable response.

Non-Torque-Matching: Even though the voltage regulator can also be switch-selected to a non-torque-matching constant voltage mode, independent of engine speed, this mode will not prevent the generator set from stalling during momentary overload conditions, and is not recommended for use. Consult an Onan service representative before selecting this voltage regulation mode to ensure that load demands specific to your installation would not cause an unstable operation of the generator set.

Operating Stability

Because of the differences in exciter and main field time constants, different gain compensation is required for the various generator sizes and applications. The VRAS-2 voltage regulator is switch-selectable to a kW range of operation that best suits the generator set application.

VOLTAGE REGULATOR ADJUSTMENTS

The VRAS-2 Voltage Regulator is shown in Figure 2-6. There are three switches that require actuation and two potentiometers on the voltage regulator as follows:

- Switch S1 - Selects the overall range of operation for the regulator. Refer to Table 2-2.
- Switches S2 and S3 - Determine the mode of regulation (Torque-Matched, or Non-Torque-Matched). Refer to Table 2-2.
- Potentiometer R32 - Provides adjustability to increase or decrease generator voltage to achieve proper setting.
- Potentiometer R34 - Is adjusted at the factory to set the frequency breakpoint, and does not require further adjustment.

TABLE 2-2. VRAS-2 SWITCH SETTINGS

GENSET MODEL	STABILITY RANGE		REGULATION MODE								
			60 HZ TORQUE-MATCHING			50 Hz TORQUE-MATCHING			NON-TORQUE-MATCHING		
	S1-1	S1-2	S2	S3-1	S3-2	S2	S3-1	S3-2	S2	S3-1	S3-2
SJB	OFF	OFF	POS 2	OFF	ON	POS 2	ON	ON	POS 2	OFF	OFF
SKB	OFF	ON	POS-2	OFF	ON	POS 2	ON	ON	POS 2	OFF	OFF

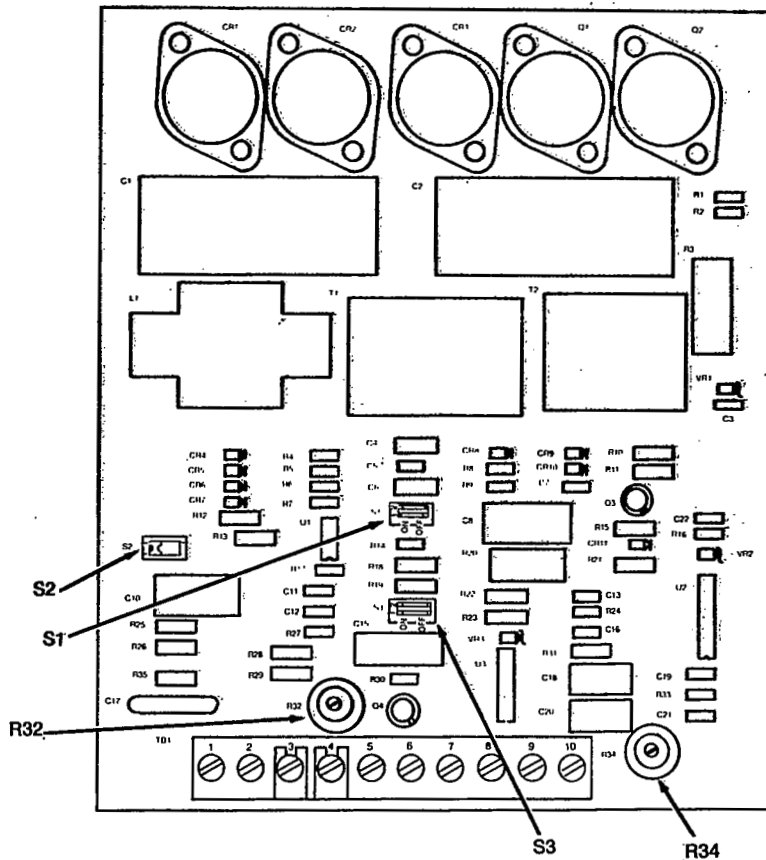

TB1-2, -3 AC INPUT VOLTS
 TB1-3, -4 CROSS-CURRENT COMPENSATION
 TB1-7, -8 VOLTAGE ADJUSTING RHEOSTAT
 TB1-9, -10 EXCITER FIELD
 F1 — TB1-9
 F2 — TB1-10

SC-1516-2

FIGURE 2-6. VOLTAGE REGULATOR

Section 3. Generator/Regulator Troubleshooting

CONTROL LOCATIONS

Review the following listing of component parts involved in generator troubleshooting. Because, the following Troubleshooting Flow Charts will only be calling them by name and not location.

Voltage Regulator - VRAS-2: Inside control box.

Terminal Board TB21: Inside control box.

Field Breaker CB21: On control box door.

Current Transformer CT21, 22, and 23: Inside housing, behind control box.

Rotating Rectifiers: Inside housing, beneath control box.

⚠ WARNING *Accidental generator set starting can result in severe personal injury or death during service procedures. Disconnect battery cable before performing any checks on generator.*

PREPARATION

A few simple checks and a proper troubleshooting procedure can locate the probable source of trouble and cut down service time.

1. Check all modifications, repairs, and replacements performed since the last satisfactory operation of the set to ensure that all generator leads are correctly connected. A loose wire connection overlooked when installing a replacement part could cause problems, as could an incorrect connection, an opened circuit breaker, or a loose connection on a printed circuit board. A thorough visual check can quickly eliminate these potential problems.
2. Visually inspect the components of Voltage Regulator VRAS-2. Look for dust, dirt, or moisture and cracks in the printed solder conductors. Burned resistors and arcing tracks are readily identifiable. Do not mark on PC boards with a pencil; graphite lines conduct and can cause leakage or short circuits between components.
3. Visually inspect the exciter rotor assembly for burned components, broken wires, loose connections, and carbon tracks caused by arcing between parts or between parts and ground. Also check for shorted paths between terminals caused by dust, dirt, and moisture.

Unless absolutely sure that panel instruments are accurate, use portable test meters for troubleshooting.

⚠ CAUTION *Ohmmeter checks must be made with the unit stopped to prevent meter damage.*

TROUBLESHOOTING PROCEDURES

The information in this section is divided into Troubleshooting Flow Charts as follows:

- A. No AC Output Voltage at Rated Engine Speed.
- B. Unstable Output Voltage, Engine Speed Stable at Rated Speed.
- C. Output Voltage Too High or Low.
- D. Exciter Field Breaker Trips.
- E. Unbalanced Generator Output Voltage.

To troubleshoot a problem, determine the problem and then refer to the appropriate troubleshooting flow chart. Start at the upper left-hand corner of chart, and answer all the questions with either a YES or NO. Follow the chart until the problem is found, performing the referenced Adjustment and Test Procedures following the flow charts.

The referenced components in the flow charts and in the Adjustment and Test Procedures can be found on the electrical schematic in Figure 3-1, and on assembly and wiring diagrams.

This figure is for reference only. Use electrical schematic specific to your application when troubleshooting.

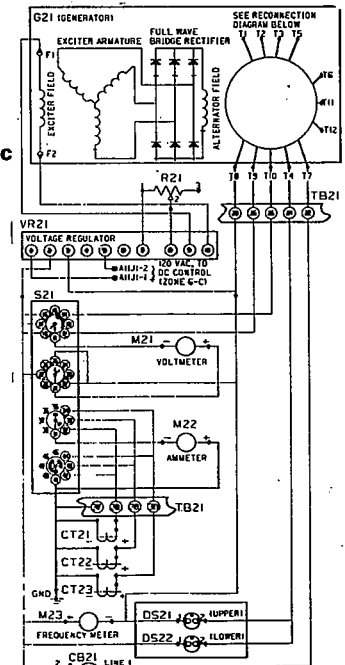
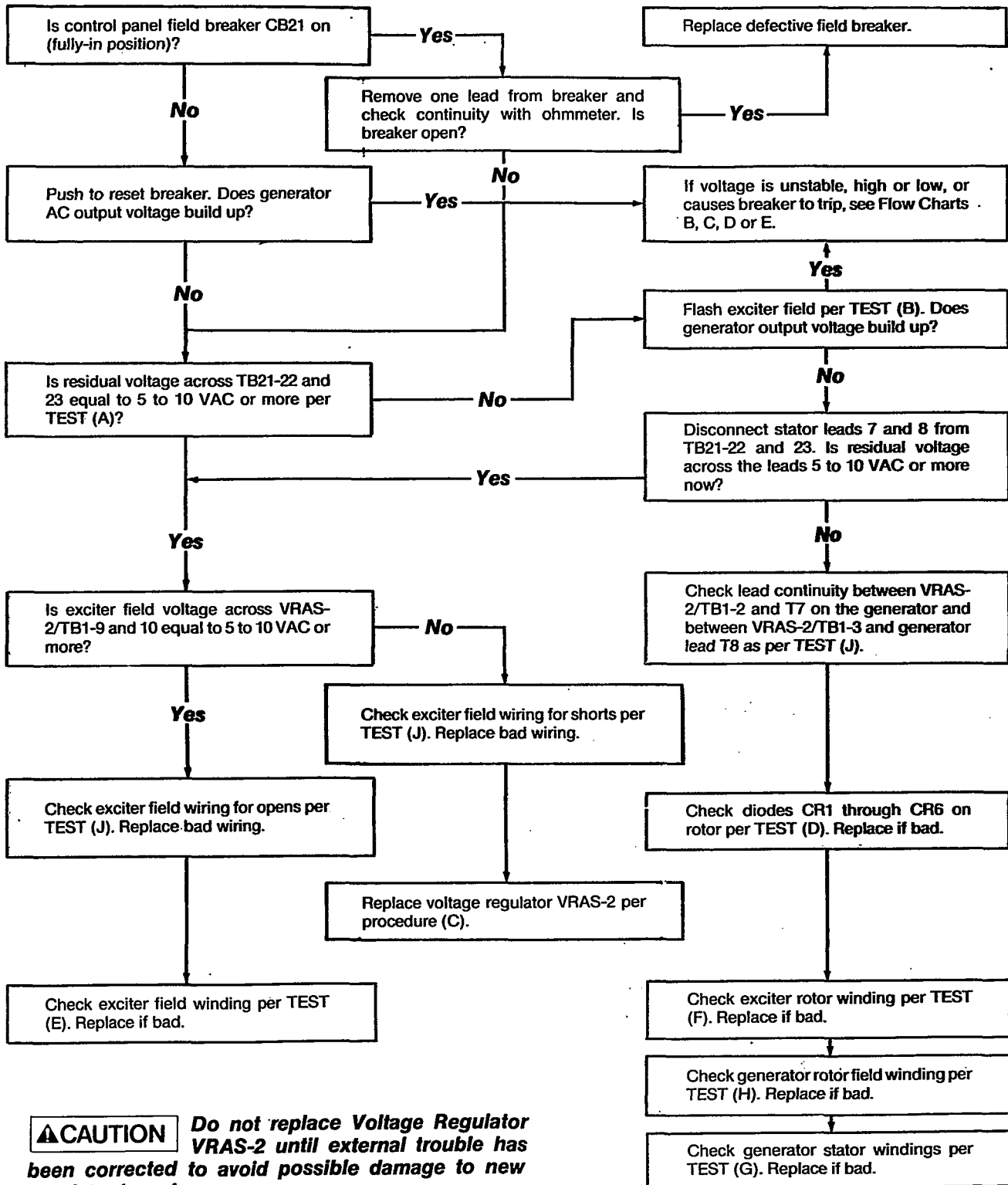

FIGURE 3-1. ELECTRICAL SCHEMATIC (Includes Detector AC Meter Option)

FLOW CHART A. NO AC OUTPUT VOLTAGE AT RATED ENGINE SPEED



⚠ CAUTION Do not replace Voltage Regulator VRAS-2 until external trouble has been corrected to avoid possible damage to new regulator board.

FLOW CHART B. UNSTABLE VOLTAGE, ENGINE SPEED STABLE AT RATED SPEED.

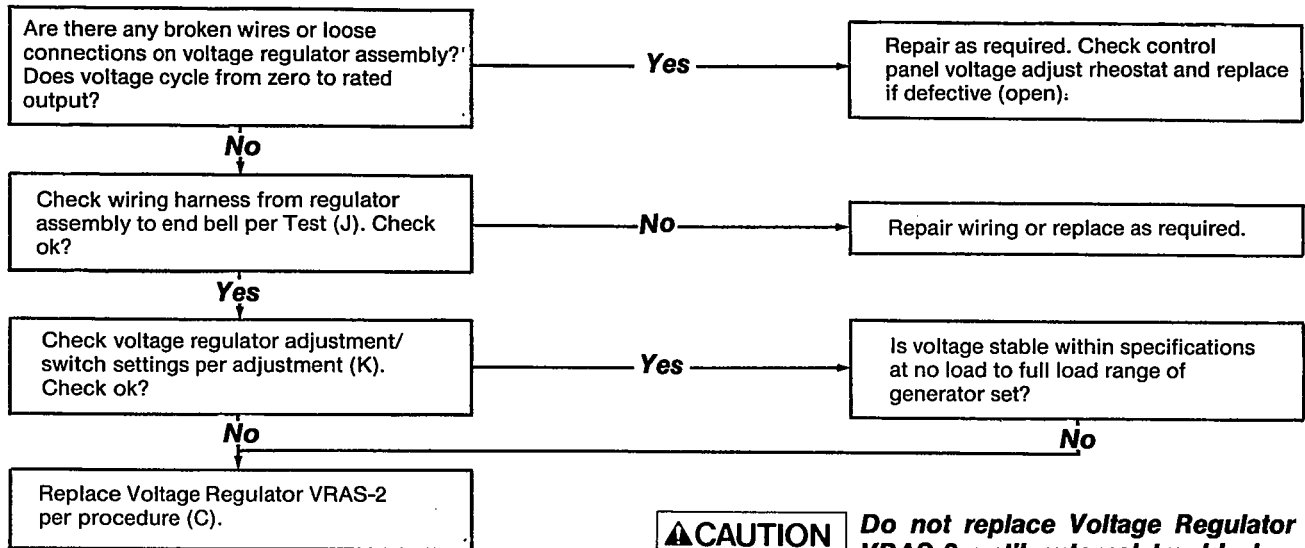

⚠ CAUTION Do not replace Voltage Regulator VRAS-2 until external trouble has been corrected to avoid possible damage to new regulator board.

FLOW CHART C. OUTPUT VOLTAGE TOO HIGH OR LOW.

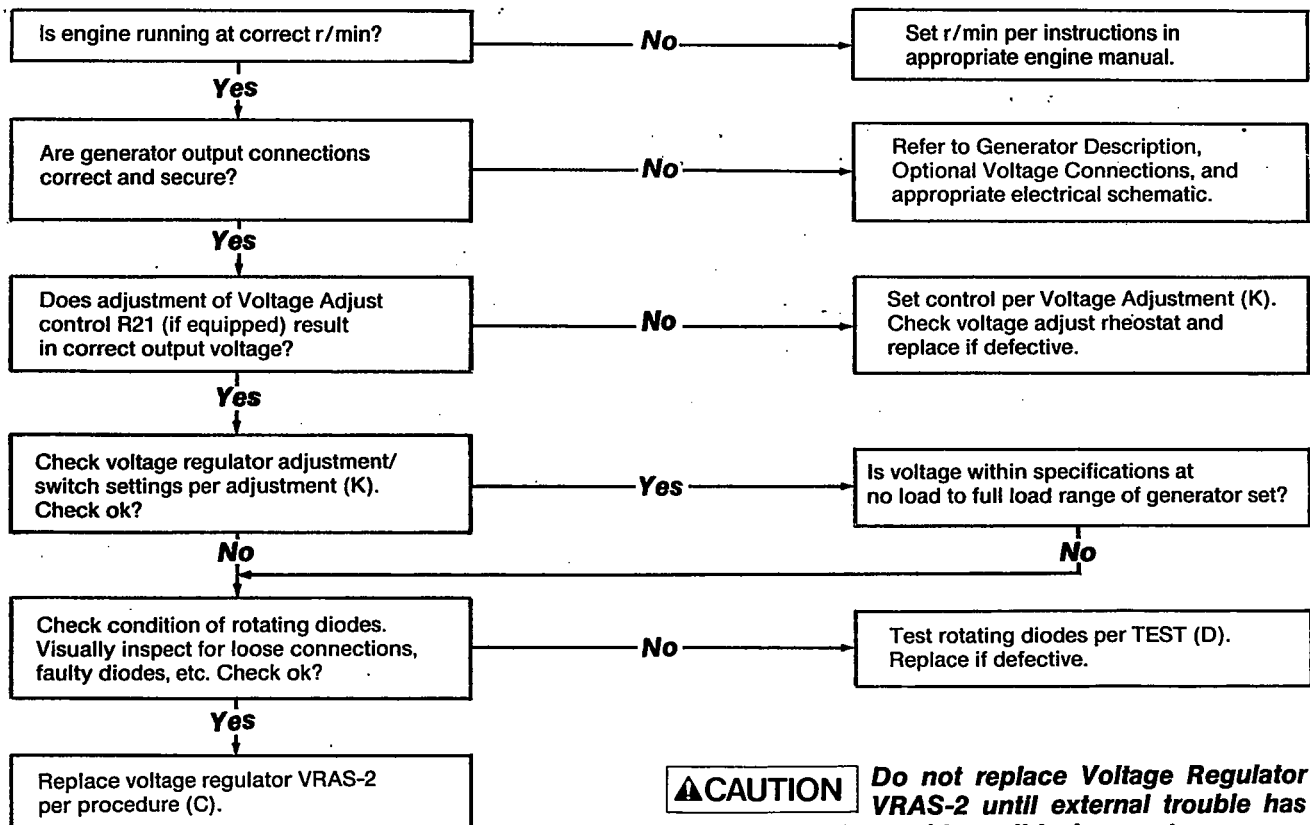

⚠ CAUTION Do not replace Voltage Regulator VRAS-2 until external trouble has been corrected to avoid possible damage to new regulator board.

FLOW CHART D. EXCITER FIELD BREAKER TRIPS.

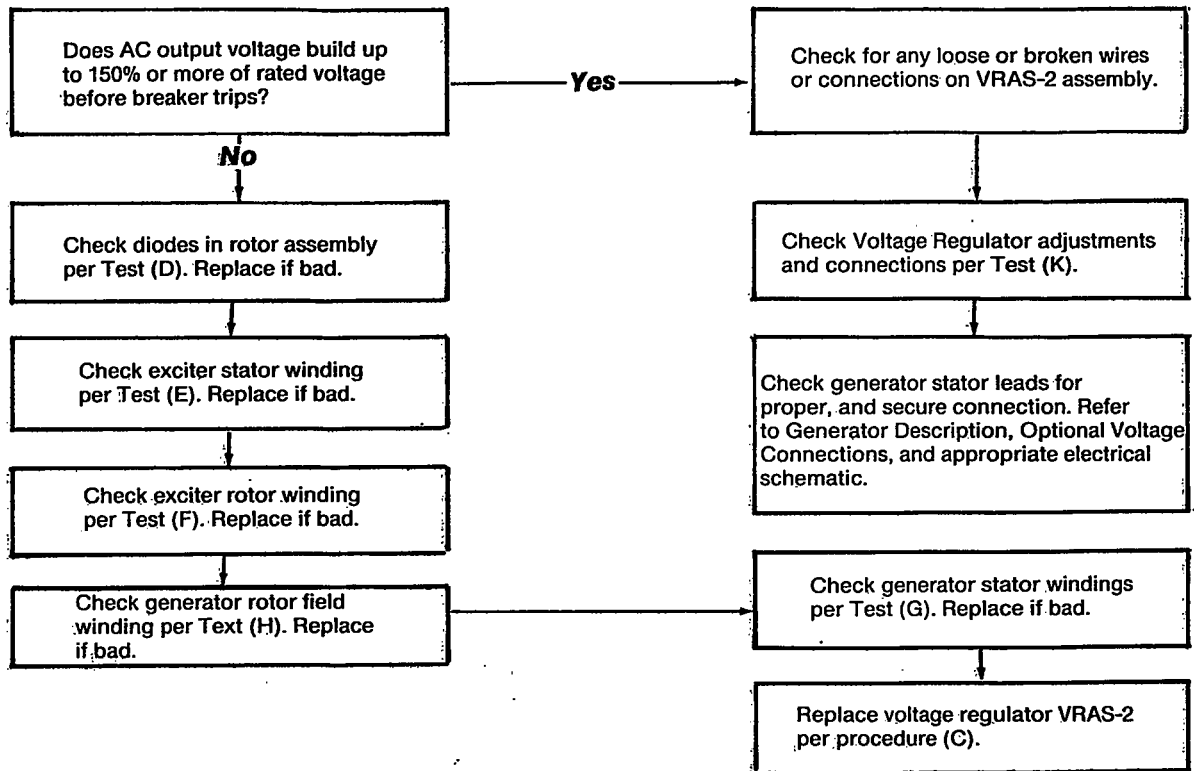

CAUTION Do not replace Voltage Regulator VRAS-2 until external trouble has been corrected to avoid possible damage to new regulator board.

FLOW CHART E. UNBALANCED GENERATOR OUTPUT VOLTAGE

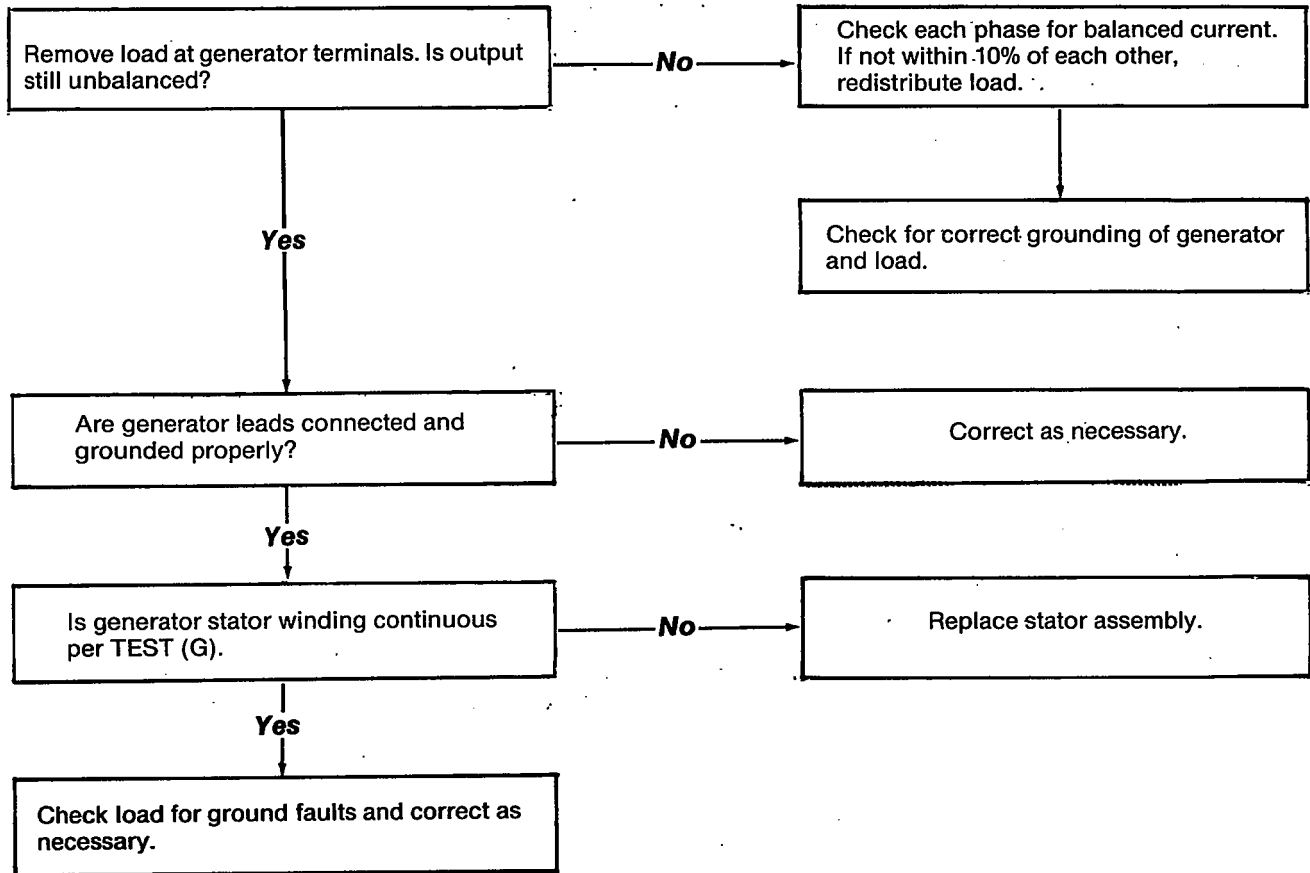



Section 4. Generator/Regulator Tests/Adjustments

All of the following adjustments and tests can be performed without disassembly of the generator. They should be used for testing generator and regulator components in conjunction with the troubleshooting flow charts. All ohmmeter tests must be made with the unit stopped to prevent meter damage.

(A)

TESTING AC RESIDUAL VOLTAGE

Generator residual AC voltage should be checked first if there is no AC power output. A good place to check is at terminal block TB21, across terminals 22 and 23. Residual voltage should be 5 to 10 VAC at normal operating r/min. If none, flash the field following the instructions in Test B.

If residual voltage is present at TB21, then check the continuity of circuit breaker CB21. If CB21 is okay, proceed to voltage regulator VRAS-2 and check for residual voltage between terminal numbers 2 and 3. If none, check continuity between these points with the generator set shut down.

(B)

FLASHING THE FIELD

If output voltage does not build up, it may be necessary to restore residual magnetism by flashing the field. This requires a 6-volt battery and a 12-ampere 300-volt diode wired as shown in Figure 4-1.

A 3-volt source will also work, as will a 12- or 24-volt source. However, if a 12- or 24-volt source is used, a 2-watt, 20- or 40-ohm resistor, respectively, must be in series with the diode to drop the voltage to 6-volts.

Flashing the field can be accomplished with generator set operating or not. Either of the following procedures should be sufficient to restore residual magnetism.

With Generator Set in Operation

1. Start the generator set and operate at normal r/min.
2. Touch the positive battery lead to TB1-9 of VRAS-2, and the negative lead to TB1-10. Hold the leads in place just long enough for the voltage to build up to the normal operating level, then remove the leads.

3. Check generator voltage, and shut down generator set. Restart generator set and run at no load. Unit must build up voltage without field flashing. If not, shut down generator set and perform continuity check of all related wiring.

With Generator Set Shut Down

1. Touch the positive battery lead to TB1-9 and the negative lead to TB1-10 of VRAS-2.
2. Hold the leads in place for no longer than 5 seconds.
3. Start generator and run at no load. Unit must build up voltage without field flashing. If it does not, shut down generator set and perform continuity check of all related wiring.

CAUTION *Incorrect field flashing procedures can damage regulator. Do not maintain field flash connection to exciter circuit longer than 5 seconds.*

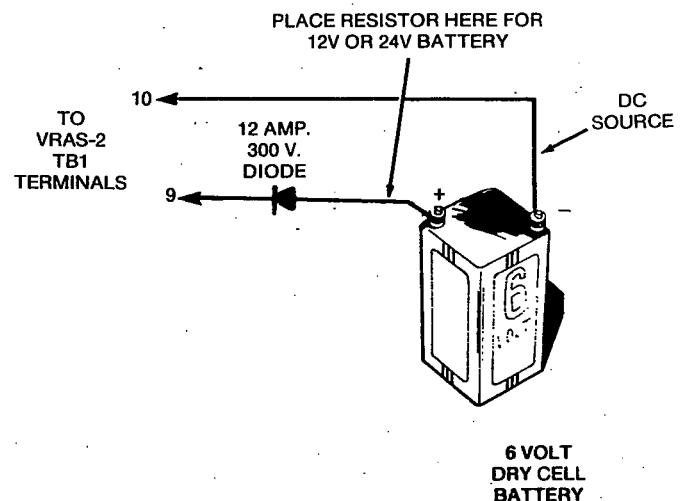

FIGURE 4-1. FIELD FLASHING CIRCUIT

(C)

VOLTAGE REGULATOR VRAS-2 REPLACEMENT

Use the following procedure for replacing the voltage regulator assembly:

1. Stop the engine, and disconnect starter batteries.
2. Disconnect, and if necessary label the wires from VRAS-2/TB1. Refer to AC control wiring diagram.
3. Remove the mounting screws, replace old VRAS-2 with new, and secure in place with mounting screws.
4. Reconnect wires removed in step 2 to proper terminals.
5. Perform voltage regulator adjustment/switch settings for specific voltage and method of regulation desired per procedure (K).

(D)

TESTING ROTATING RECTIFIERS (DIODES)

Two different rectifier assemblies make up the rotating rectifier bridge assembly, Figure 4-2. Using an accurate ohmmeter, test each CR using negative and positive polarities. Test rectifiers as follows:

1. Disconnect all leads from assembly to be tested.
2. Connect one lead to F1+ stud and connect other lead to CR1, CR2, and CR3 in turn; record resistance value of each rectifier.
3. Connect one lead to F2- stud and connect other lead to CR4, CR5, and CR6 in turn; record resistance value of each rectifier.
4. Reverse ohmmeter leads from steps 2 and 3 and record resistance value of each rectifier F1+ to CR1, CR2, and CR3 and F2- to CR4, CR5, and CR6.

5. All the resistance readings should be high in one test and low in the other test. If any reading is high or low in both tests, rectifier assembly is defective.
6. Replace defective rectifier assembly with new, identical part.

CAUTION Excessive dust or dirt on diodes and other components will cause overheating and eventually failure. Keep these assemblies clean!

Use 24 in.-lbs. (2.7 N•m) torque when replacing nuts of F1+ and F2-, CR1, CR2, CR3, CR4, CR5, and CR6.

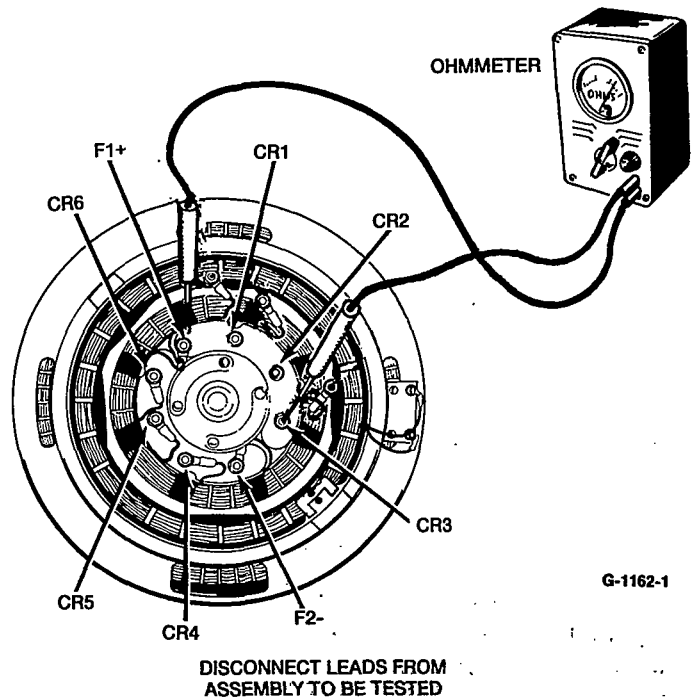

FIGURE 4-2. TESTING ROTATING RECTIFIERS

(E)

TESTING EXCITER STATOR

Testing for Grounds

Using an ohmmeter, R x 100 scale, measure the insulation resistance between either lead F1 or F2 and the laminations, Figure 4-3. A reading of less than infinity indicates a ground.

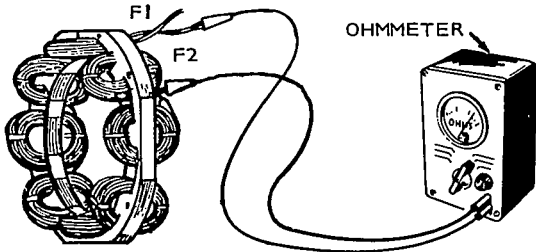

ES-1574

FIGURE 4-3. TESTING EXCITER FIELD

Testing Winding Resistance

Measure coil resistance between leads F1 and F2 with an ohmmeter scale R x 1. See Figure 4-4. Resistance should be 13.05 to 15.95 ohms at 25°C (77°F).

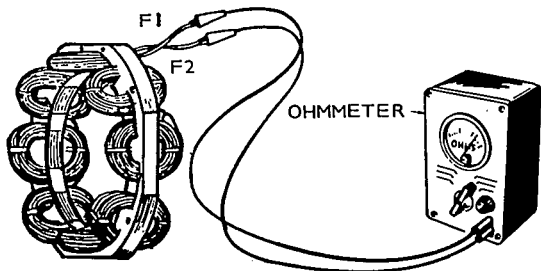

ES-1575

FIGURE 4-4. TESTING EXCITER FIELD

(F)

TESTING EXCITER ROTOR

Testing for Grounds

Connect leads of ohmmeter between each CR lead and exciter rotor laminations. Use an ohmmeter set at the highest resistance range. An ohmmeter reading less than one megohm (1,000,000 ohms) indicates defective ground insulation.

Testing for Open or Shorted Windings

Use a Wheatstone Bridge for this test. Disconnect main rotor field leads which connect to rotating rectifier assemblies at F1+ and F2-. Disconnect lead wires from diodes CR1, CR2, CR3, CR4, CR5 and CR6. Test between exciter lead pairs T1-T2, T2-T3 and T1-T3. Resistance should be 0.6 to 0.7 ohms at 68°F (20°C). See Figure 4-5.

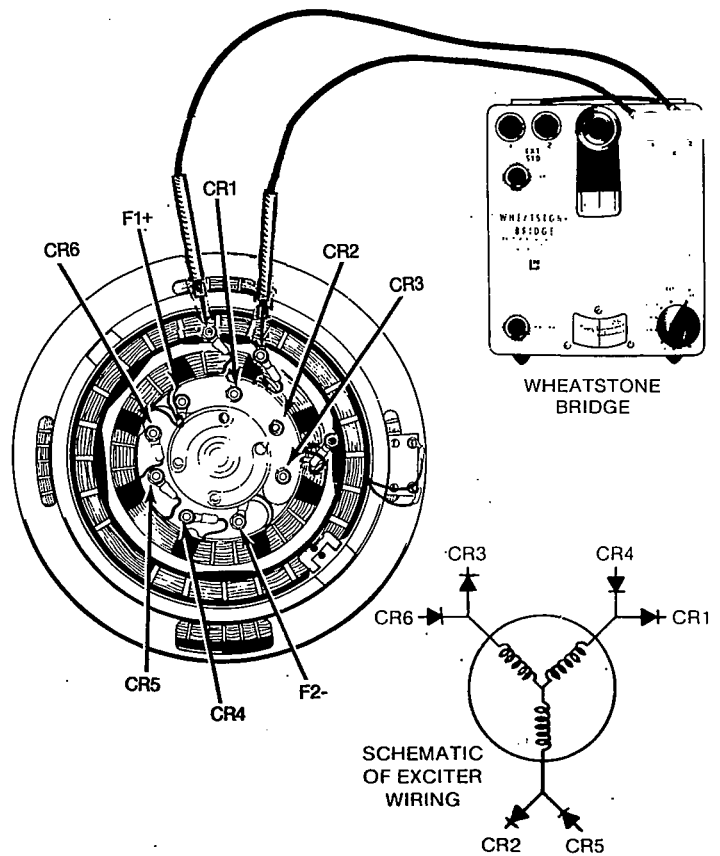

G-1163-1

FIGURE 4-5. TESTING EXCITER ROTOR

(G)

TESTING GENERATOR STATOR

Testing for Grounds

Before testing stator, disconnect control wire 4, 7, 8, 9, and 10 from TB21. Isolate from ground and each other.

Connect all stator output leads (T1-T12) together. Use an ohmmeter set on the R x 100 scale and measure the insulation resistance between these windings and the stator frame. A reading of less than infinity indicates a ground. Field circuit breaker can be either open or closed for this test.

Testing for Shorts

To check for shorts between individual windings, first refer to electrical schematic to determine individual coil lead wires (T1-T4, T7-T-10, etc.). Be sure to disconnect the instrumentation leads and stator leads T4, T7, T8, T9, and T10. Connect an ohmmeter, R x 100 scale, to one lead of a stator winding (leaving the other end of coil winding being tested open), and the other ohmmeter lead to all other stator leads connected together.

Example:

- Ohmmeter lead to: T1 coil winding lead.
- Ohmmeter lead to: T9,12,7,10,2,5,3,6,8, and 11 connected together.
- Coil windings lead T4: Open

A reading of less than infinity indicates a short. Repeat test for all six coils.

Measure resistance of windings using a Kelvin Bridge meter. Refer to Figure 4-6 and Table 4-1. If any windings are shorted, open, or grounded, replace the stator assembly. Before replacing the assembly, check the leads for broken wires or damaged insulation.

Stator output leads T4, T7, T8, T9 and T10 are interconnected (within the stator) to five stranded #10 aircraft control wires. These wires are labeled 4,7,8,9, and 10 respectively and terminate at TB21 (terminals 22-26).

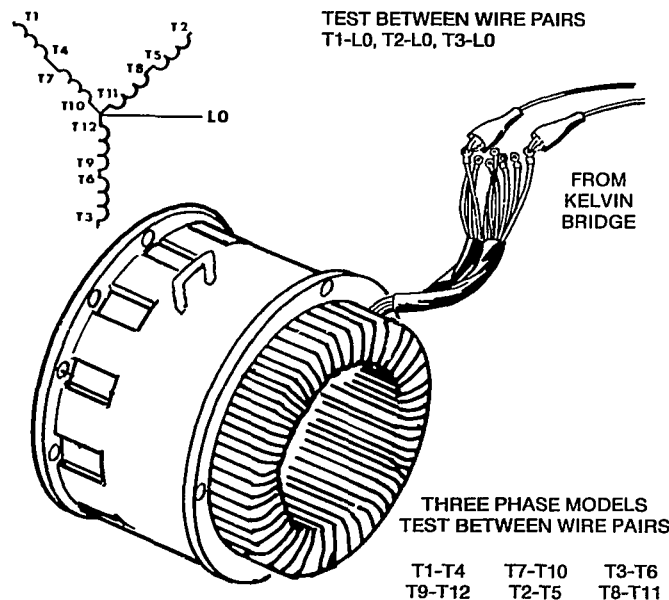

G-1165

FIGURE 4-6. TESTING STATOR WINDINGS

TABLE 4-1. RESISTANCE VALUES FOR STATORS

All resistances should be within the values shown at 25°C (77°F). Use an accurate instrument such as a Kelvin Bridge for this test. Test between the following coil leads.

kW RATING		RESISTANCE
50 Hz	60 Hz	Ohms @ 25°C (77°F)
30		0.083 ± 5%
	35	0.070 ± 5%
45		0.036 ± 5%
	55	0.030 ± 5%

(H)

TESTING GENERATOR ROTOR

Testing for Grounds

Use an ohmmeter (R x 100 scale) and measure as follows:

1. Disconnect F1 and F2 rotor leads from the rotating diodes.
2. Measure between either lead and the rotor shaft (Figure 4-7).
3. A reading of less than infinity indicates a ground.

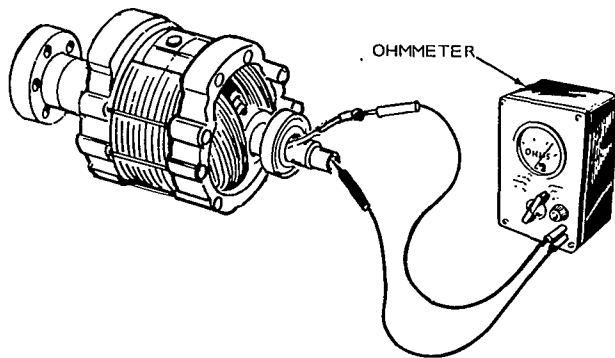

CONTACT ONE PROD TO EACH OF THE FIELD LEADS AND OTHER PROD TO ROTOR SHAFT. IF ROTOR IS GOOD, THERE WILL BE ONE MEGOHM OR GREATER RESISTANCE.

G-1166

FIGURE 4-7. TESTING ROTOR FOR GROUNDS

Testing for an Open Circuit

1. Disconnect and test between F1 and F2 leads (Figure 4-8).
2. Refer to resistance values given in the following table.

TABLE 4-2. ROTOR RESISTANCES

kW RATING		RESISTANCE
50 Hz	60 Hz	Ohms
30	35	2.9
45	55	3.1

3. Replace the rotor if it is grounded or has an open or short.

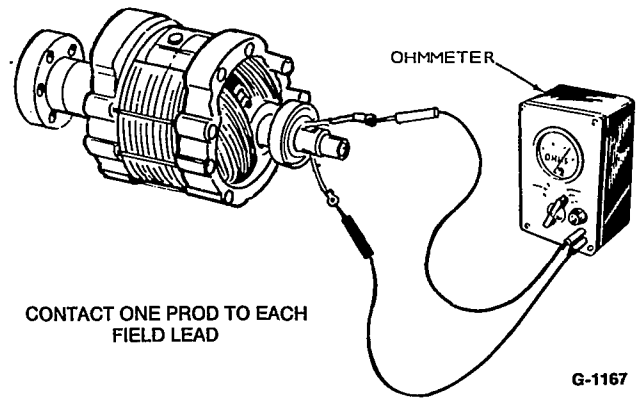

CONTACT ONE PROD TO EACH FIELD LEAD

G-1167

FIGURE 4-8. TESTING ROTOR FOR AN OPEN CIRCUIT

(J)

WIRING HARNESS CHECK

Carefully check wiring harnesses as follows:

1. Inspect all wires for breaks, loose connections, and reversed connections. Refer to applicable wiring diagram.
2. Remove wires from terminals at each end and using an ohmmeter, check wire end to end for continuity or opens.
3. Using an ohmmeter, check each wire against each of the other wires for possible shorts or insulation breaks under areas covered by wrapping material.
4. Reconnect or replace wires according to applicable wiring diagram.

(K)

VOLTAGE REGULATOR (VRAS-2) ADJUSTMENT

After replacement, voltage regulator VRAS-2 adjustment is performed as follows:

1. Loosen locking nut of Voltage Adjust potentiometer, R21. Locate adjustment screw to mid-position and retighten locking nut.
2. Open controller panel doors.

▲WARNING *High voltages in the control present an electrical shock hazard which can cause severe personal injury or death. Proceed with care!*

3. Refer to Figure 2-6 Voltage Regulator for proper Stability Range (S1) and Mode Selection (S2 and S3) switch settings.
4. Ensure that all connections are proper and secure.

5. **Controller with Detector AC meter option:** Refer also to adjustment (L).

Controller without Detector AC meter option: Connect an accurate voltmeter to VRAS/TB1-2 and -3 terminals.

6. Start generator set.
7. Using a screwdriver, turn R32 potentiometer on printed circuit board VRAS-2 to increase or decrease the voltage as required to achieve proper setting. Observe voltmeter while making adjustment. Set voltage with no load connected to generator. (Example: For a 120/240 volt connection, set at no-load voltage for approximately 246 volts). If voltage is unstable or tends to hunt, refer to troubleshooting section.
8. Stop generator set, and prepare all installation and generator set controls for operation readiness.

Regulator Specifications

Input Power

Input voltage across terminals 2 and 4: 208 to 240 volts RMS +/-10%, depending on wiring configuration.

Input frequency: 45 to 65 Hz

Maximum burden: 800 VA

Output Power

Continuous Rating: 3.0A

One minute rating: 6.5A (in current limit)

Current limit: 6.5A +/-0.75A

Minimum Field Resistance

0.6 ohms @ 25°C copper winding exciter

Regulator Sensing

Single-phase average voltage directly proportional to generator frequency to breakpoint. Independent of frequency after breakpoint. Nominally set to 59 Hz (49 Hz for 50 Hz sets).

Operating Temperature

-40°C to +80°C

(L)

GENERATOR VOLTAGE ADJUST (R21)

The following procedure pertains to generator sets equipped with Detector AC option only.

1. Start generator set.
2. Prepare installation equipment for Test Without Load.
3. Operate Phase Selector switch to read generator output current and voltage, while performing the following steps:
 - A. Insert a screwdriver into the Voltage Adjust control on the front of the generator set control and carefully loosen the locking nut.
 - B. Slowly turn the screwdriver clockwise to increase voltage, or counterclockwise to decrease voltage.
 - C. When set at correct voltage, tighten the locking nut. Be careful not to change adjustment.

If correct voltage cannot be attained by R21 adjustment, refer to VRAS-2 adjustment, procedure (K).

Observe that ammeter does not register any output current. If output current is observed on the ammeter, contact an Onan representative.

4. Move the Phase Selector switch to the Off position.
5. Stop generator set, and prepare all installation and generator set controls for operation readiness.

Section 5. Generator Disassembly/Assembly

GENERATOR DISASSEMBLY

If generator testing determines that the generator needs repair, remove and disassemble as follows:

1. Disconnect the negative (-) battery cable to prevent accidental starting of the generator set while servicing.

▲WARNING *Accidental starting of the generator set during this procedure presents the hazard of severe personal injury or death. Make sure to disconnect the negative battery cable before beginning.*

2. Remove the generator output box cover, Figure 5-1.
3. Disconnect the stator lead wires from the load wires.
4. Disconnect lead wires from control box. Check wire markings for legibility to ease assembly. Arrange leads so they can be easily withdrawn from the control box.

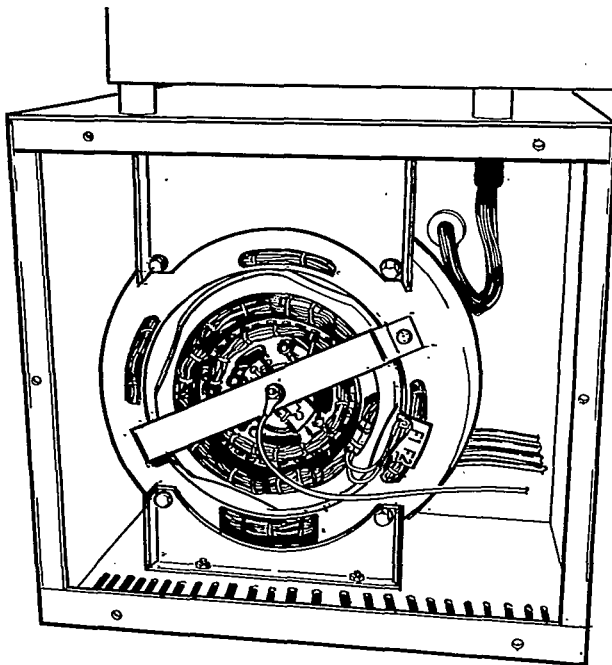

SC-1441

FIGURE 5-1. OUTPUT BOX AND CONTROL

Disconnect all engine and generator control wire leads from inside control box as follows:

DC Wiring

- A11/TB1-8,-10, and terminals -1 through -7 as required.
- Unplug A11/J1,J2,J3, and J4.

AC Wiring

- VRAS-2/TB1-1,-5,-9, and -10.
- TB21-22 to -30.

5. Remove overspeed switch assembly, Figure 5-2.
6. Use a hoist or similar lifting device to support the output box and control assembly.

▲WARNING *To prevent personal injury, use adequate lifting devices to support heavy components. Keep hands and feet clear while lifting.*

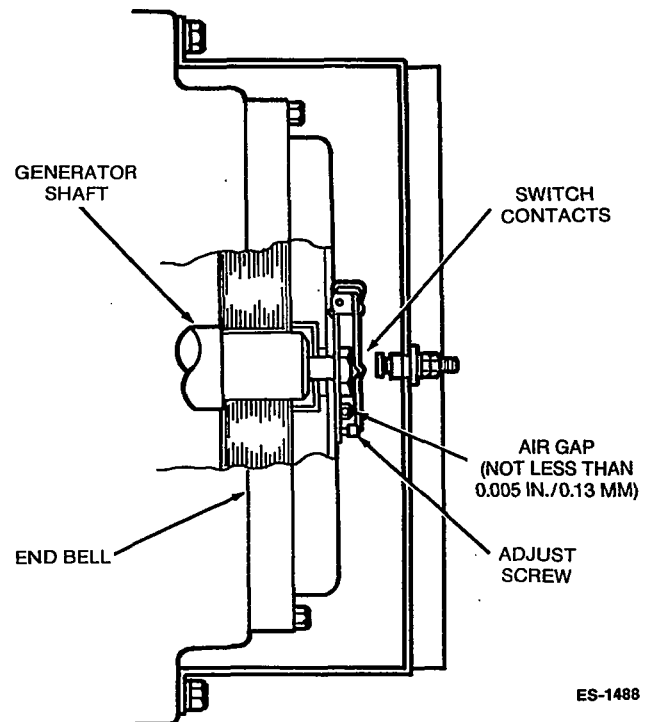

ES-1488

FIGURE 5-2. OVERSPEED SWITCH

7. Remove the endbell capscrews that secure the output box support brackets to the endbell; and remove the output box and control box as an assembly.

Refer to Figure 5-4 during generator disassembly to identify and locate components.

8. Disconnect the exciter stator lead wires (F1 and F2) from the terminal block on the endbell. Loosen the four screws that secure the exciter stator to the endbell and remove the exciter stator.
9. Remove the rotor shaft capscrew, lock washer, overspeed switch, flat washers, and spacer from the end of the rotor shaft.
10. Disconnect the generator lead wires from terminals F1 and F2 on the exciter rotor, and remove the exciter rotor from the rotor shaft.
11. Remove the bearing retainer capscrews and bearing retainer from the endbell.
12. Remove the remaining capscrews that secure the endbell to the stator housing, and remove endbell from stator. It might be necessary to tap around the joint to separate the endbell assembly.
13. Remove the center capscrew, lock washer, and flat washer from the two generator vibration isolators.
14. Using an adequate lifting device, lift the generator until the mounting brackets clear the vibration isolators.
15. Block the rear of the engine in place by supporting the flywheel housing. A length of steel channel and wooden blocking is required to support the rear of the engine. Place the channel and blocking under the flywheel housing. Lower the generator until most of the set weight is supported by the blocking.
16. Remove the protective screening from the generator air discharge openings and disconnect the grounding strap from the flywheel housing.
17. Verify that the stator is adequately supported and then carefully remove the capscrews from the stator attachment ring.

18. Remove the stator assembly, being careful not to drag the windings on the rotor. Place stator on its side in the horizontal position.
19. Using a hoist and sling to support the rotor, carefully remove the capscrews that secure the drive disc to the flywheel.
20. Remove the rotor assembly and place it on wood blocks in the horizontal position. To avoid possible distortion, do not allow the drive disc and fan to rest on anything.
21. Remove the capscrews that hold the drive disc to the rotor shaft, and remove the drive disc, spacer, and rotor fan.
22. Use a gear puller to remove the end bearing from the rotor shaft, Figure 5-3.

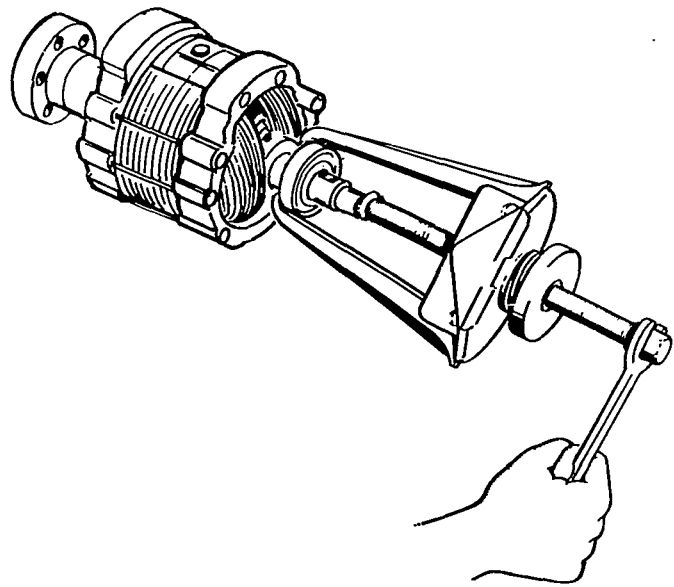

G-1161

FIGURE 5-3. END BEARING REMOVAL

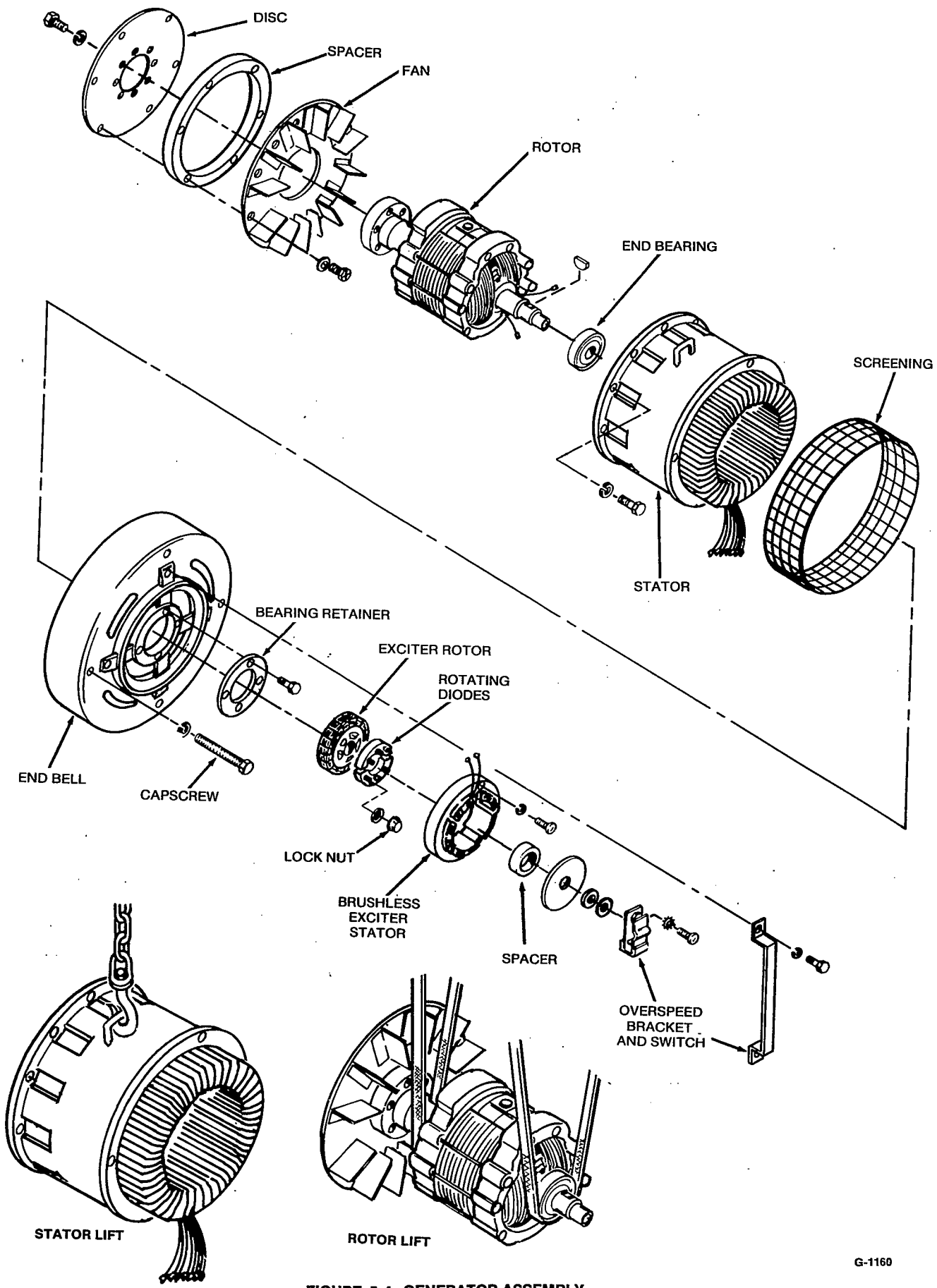

FIGURE 5-4. GENERATOR ASSEMBLY

GENERATOR ASSEMBLY

Generator assembly is the reverse of disassembly procedure, refer to Figure 5-4.

1. Always replace bearing with a new one. Apply a layer of Molykote grease, Onan part #524-0118, to the inside diameter of the end bearing. Press bearing on to rotor shaft, applying force to the inner face of the bearing.
2. Place the rotor fan and spacer in position on the rotor shaft.
3. Install the drive disc on the rotor shaft, placing the chamfered edge on the flywheel side. Install the eight capscrews and flat washers and tighten to 68 ft-lbs. (92 N•m) torque.
4. Using a hoist and sling to support the rotor, align the holes in the drive disc, fan spacer, and fan with the corresponding holes in the flywheel.
5. Secure the rotor assembly to the flywheel using eight capscrews and flat washers. Tighten to 35 ft-lbs. (48 N•m) torque.
6. Using an adequate lifting device, carefully move the stator into position over the rotor assembly. The stator leads should be in the 3 o'clock position when viewed from the endbell.
7. Align the holes in the stator attachment ring with the holes in the flywheel housing and install the thirteen capscrews and lock washers. Tighten to 35 ft-lbs. (48 N•m) torque.
8. Using an adequate lifting device, slightly raise the generator so that the wooden blocking and steel channel can be removed from under the flywheel housing; then lower the generator so the full weight is resting on the rear vibration isolators.
9. Place the protective screening over the generator air discharge openings and fasten securely.
10. Connect the grounding strap to the flywheel housing using a capscrew and EIT locking washer; and tighten securely.
11. Install the capscrew, locking washer, and flat washer in each vibration isolator; and tighten securely.
12. Apply a thin film of Molykote grease or equivalent to the mating surfaces of the end bearing and the endbell bearing hole.
13. Install endbell on the stator, placing the opening for the stator leads in the 3 o'clock position. Fasten endbell using the four capscrews and lock washers but do not tighten.
14. Install the bearing retainer on the endbell and secure using four capscrews and lock washers. Tighten to 4.5 ft-lbs. (6 N•m) torque.
15. Install the exciter rotor on the rotor shaft. Connect the generator lead wires to terminals F1 and F2 on the exciter rotor.
16. Install the exciter stator on the endbell and secure using four socket head capscrews and lock washers. Tighten to 4.5 ft-lbs. (6 N•m) torque.
17. Connect the exciter stator lead wires to terminals F1 and F2 on the endbell terminal block.
18. Refer to Figure 5-2. Mount and adjust Mechanical Overspeed Switch.
When installing the overspeed switch assembly (capscrew, lock washer, switch, small flat washers, large flat washer, and spacer) on the rotor shaft, tighten to 53 ft-lbs. (72 N•m) torque.
Install the overspeed switch assembly bracket and secure using two capscrews and lock washers. Tighten to 4.5 ft-lbs. (6 N•m) torque. Refer to Figure 5-2, and set to proper gap.
19. Connect overspeed switch lead wire to terminal on overspeed switch bracket.
20. Remove the four capscrews and lock washers from the endbell. Use an adequate lifting device to hold the output box in position for mounting to the endbell. Replace the capscrews and lock washers and tighten to 20 ft-lbs. (27 N•m) torque.
21. Connect the wires using the proper generator set wiring diagram, and voltage connections, Figure 2-2.
22. Verify that all connections are proper and secure and then install the output box cover.
23. Connect the negative (-) battery cable and test the generator set for operation.

Section 6. Wiring Diagrams

GenSet AC Control (612-6268)

GenSet AC Control (612-6267)

6-2

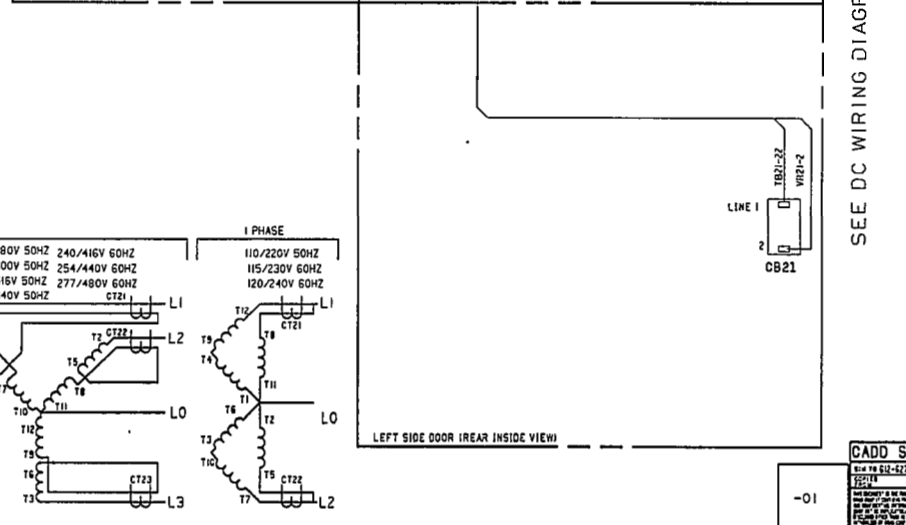
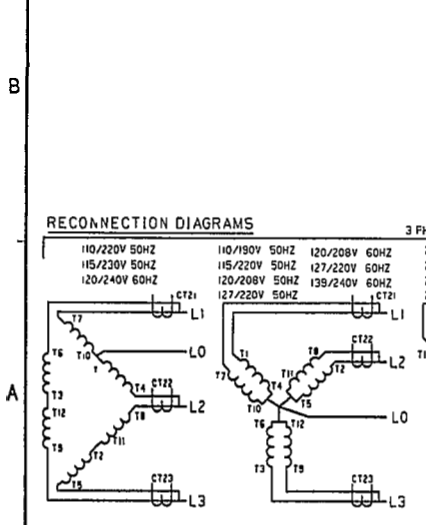
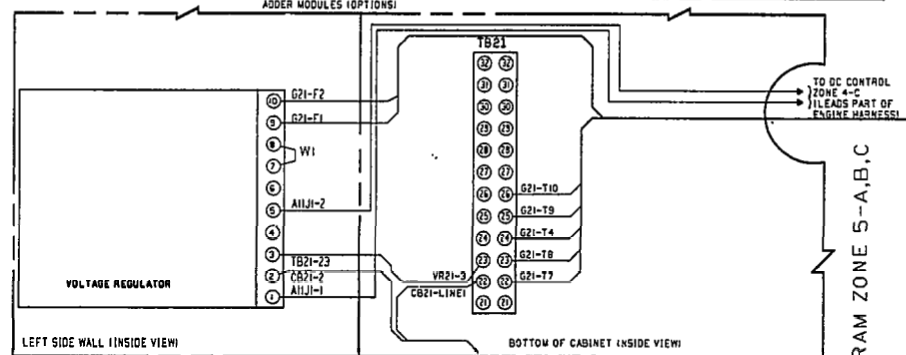
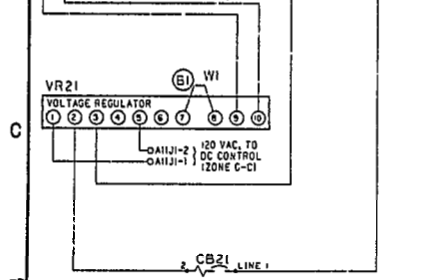
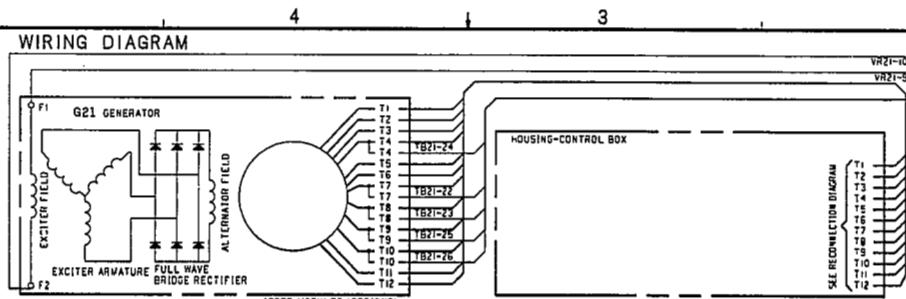
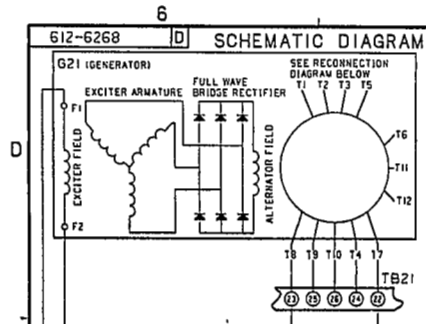

NO.	REF.	DES.	PART NO.	QTY.	DESCRIPTION	DASH	
1			30-8617	1	COVER W/DWT-CONTROL	-0	
2			402-0527	B	ISOLATOR-VIBRATION	-0	
6			15CB-005	A	GROUND MET 27	-0	
7			405-0332	A	RECEPTACLE-FASTENER	-0	
8			405-0333	A	STUD-FASTENER	-0	
5			405-0394	A	WASHER-STUD RTWR	-0	
10			332-0032	P	CLIP-WIRE 15/8"	-0	
1			1070-03	-	NUT-WIRE W/ET 1 0-32	-0	
4			337-0048	A	CORD STRAP	-0	
6			182-0016	-	NUT-EX 15/8-18	-0	
7			1856-0008	-	WASHER-EIT 1/4-15/8	-0	
8			915-0044	-	SCREW-RH SDC W/IT 1/4-32 X 7/16	-0	
9			182-0008	-	SCREW-LH 1/4-32 X 3/8	-0	
10			182-0024	-	SCREW-LH 1/4-32 X 5/8	-0	
2			301-151-02	B	DOOR W/DWT-CONTROL LHM	-0	
22			98-537	C	SILKSCREEN-PN FR AC-DR12	-0	
23			98-530	C	SILKSCREEN-PN REAR AC-DR12	-0	
24			301-18614	D	TRAY-CONTROL RHM	-0	
25			338-1855	B	HARNES-AC-DR12,BSC	-0	
28			320-112	B	CIRCUIT BREAKER-WAS FIELD	-0	
29			G21	REF	GENERATOR	-0	
30			TB21	REF	PART OF AC HARNESS L1-L5 #25	-0	
4			332-2723	A	MARKER STRIP	-0	
42			912-0065	-	SCREW-RH 5-32 X 5/8	-0	
43			VR21	REF	VOLTAGE REGULATOR	-0	
44			WI	332-2605	P	JUMPER-TERM	-0

NOTES:

- ALL COMPONENTS SHOWN IN THE DE-ENERGIZED POSITION.
- ILLUSTRATION NUMBERS REFER TO DRAWING 539-3740 .01

CADD SYSTEM DWG

DATE: 5-24-54

NAME: WALTER E. WARR

SCALE: 1" = 1"

PROJECT: 100-GEN SET AC CONT

NO. 62-6268

50-250KW (150 & 60 HZ)

62-6268

01

612-6267 SCHEMATIC DIAGRAM

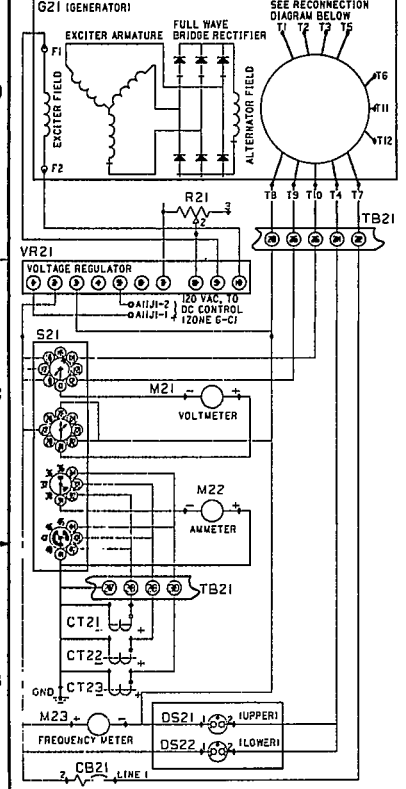

WIRING DIAGRAM

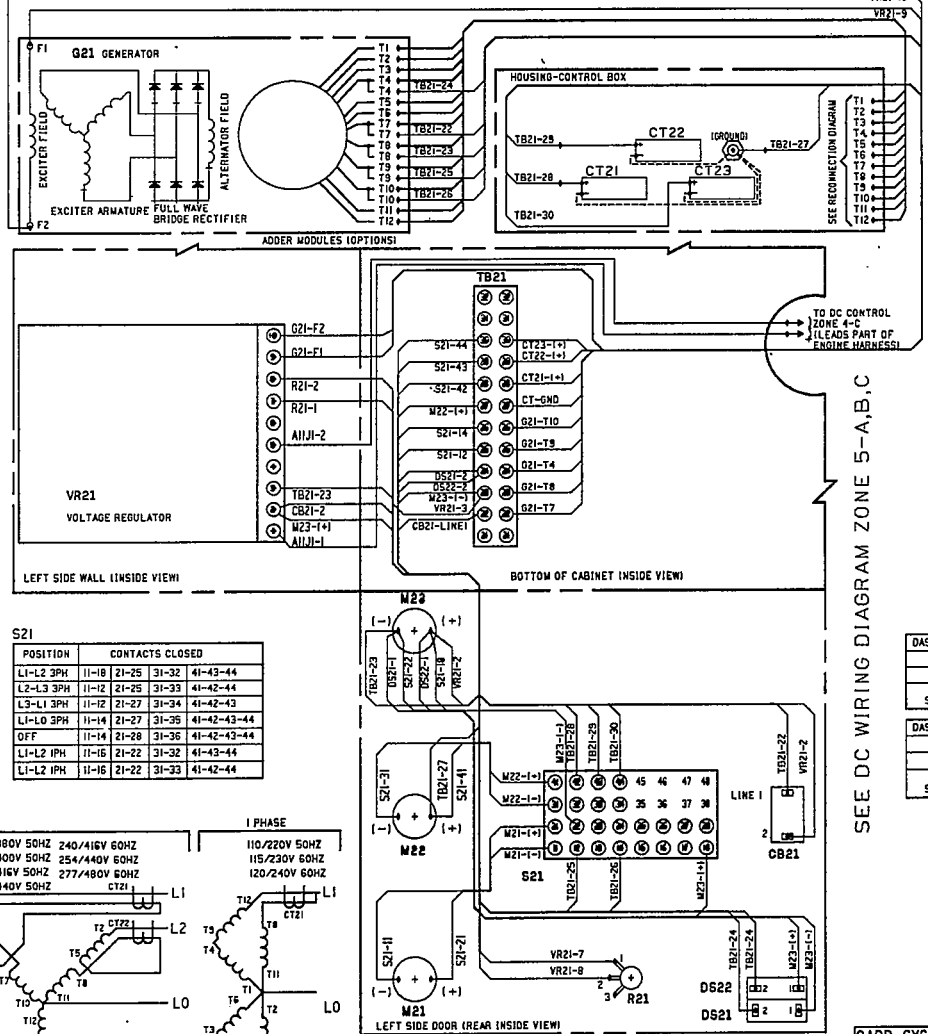

S21

POSITION	CONTACTS CLOSED
L1-L2 3PH	11-18 21-25 31-32 41-43-44
L2-L3 3PH	11-12 21-25 31-33 41-42-44
L3-L1 3PH	11-12 21-27 31-34 41-42-43
L1-L0 3PH	11-14 21-27 31-35 41-42-43-44
OFF	11-14 21-28 31-35 41-42-43-44
L1-L2 1PH	11-16 21-22 31-32 41-43-44
L1-L2 1PH	11-16 21-22 31-33 41-42-44

RECONNECTION DIAGRAMS

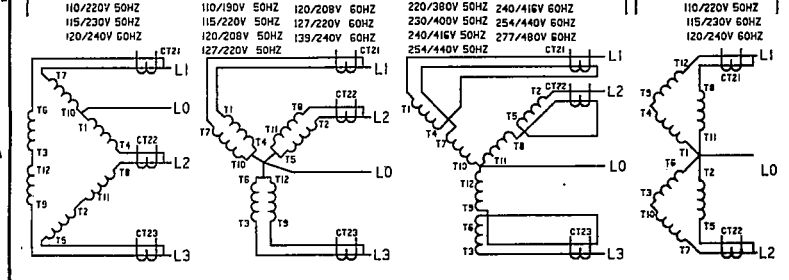

PARTS LIST

QTY	REF DESG	PART NO	INT	QTY	DESCRIPTION	DASH #
1		301-8617	C	1	COVER WLDMT-CONTROL	ALL
2		402-0527	B	4	ISOLATOR-VIBRATION	ALL
6		509-0051	A	1	GRDMMET (2")	ALL
7		405-0332	A	1	RECEPTACLE-FASTENER	ALL
8		405-0333	A	1	STUD-FASTENER	ALL
9		405-0334	A	1	WASHER-STUD RTR	ALL
10		332-0052	P	1	CLIP-WIRE 15/8" T	ALL
11		970-0131	-	1	NUT-HEX W/ET 1/0-32I	ALL
14		337-0049	A	1	BOND STRAP	ALL
16		862-0015	-	1	NUT-HEX 15/16-18I	ALL
17		856-0008	-	1	WASHER-EIT LX 15/16I	ALL
18		815-0544	-	6	SCREW-RHW XREC W/IT 16-32 X 1/2I	ALL
19		821-0009	-	2	SCREW-LXH 11/4-20 X 3/8I	ALL
20		821-0004	-	6	SCREW-LX W 1/0-32 X 5/8I	ALL
21		301-8511-03	B	1	DOOR WLDMT-CONTROL LH	ALL
22		98-5300	C	1	SILKSCREEN-PNL FR IAC(HORIZ)	ALL
23		98-5301	C	1	SILKSCREEN-PNL REAR IAC(HORIZ)	ALL
24		301-8614	D	1	TRAY-CONTROL LH	ALL
25		338-1854	D	1	HARNES-AC IHORIZI	ALL
29		CB21	320-1021	B	CIRCUIT BREAKER-WAG I(FIELD)	ALL
30		CT21-23	322-0361	B	TRANSFORMER ASSY-CUR	ALL
30		CT21-22	322-0363	P	LAMP ASSY UPPER/LOWER SCALE	ALL
		G21	REF		GENERATOR	ALL
31		M21	302-1148	B	VOLTMETER-AC 100-300, 0-600I	ALL
32		M22	SEE CHART	C	AMMETER-AC (SEE CHART)	ALL
33		M23	302-1720	B	METER-FREQUENCY 145-65 HZ	ALL
38		R21	303-0261	P	RHEOSTAT VOLTS ADJUSTI	ALL
39		S21	303-0032	A	KNOB-RHEOSTAT	ALL
40		S21	508-0284	B	SWITCH-ROTARY I(VOLT & AMMETER)	ALL
41		TB21	REF		PART OF AC HARNES (ILLUS #25)	ALL
41			332-2723	A	MARKER STRIP	ALL
42			812-0065	-	2 SCREW-RHW 16-32 X 5/8I	ALL
43		VR21	REF		VOLTAGE REGULATOR	ALL

NOTES:
 1. ALL COMPONENTS SHOWN IN THE DE-ENERGIZED POSITION.
 2. ILLUSTRATION NUMBERS REFER TO DRAWING 539-0740 (DI)

DASH NUMBERS	-01	-02	-03	-04
CT21-23	302-1770	302-1769	302-1772	302-1773
M22	302-1473	302-1147	302-1683	302-1684
AMMETER SCALE (M22)	(0-50.0-100)	(0-75.0-150)	(0-100.0-200)	(0-150.0-300)

DASH NUMBERS	-05	-06	-07
CT21-23	302-1771	302-	302-
M22	302-1685	302-1724	302-1725
AMMETER SCALE (M22)	(0-200.0-400)	(0-250.0-500)	(0-375.0-750)

SEE DC WIRING DIAGRAM ZONE 5-A,B,C

CADD SYSTEM DWG

DATE	12-23-72	BY	MAUREEN C. WALK	DATE	6-1-84	BY	L. NELSON
DATE	12-23-72	BY	L. NELSON	DATE	6-7-84	BY	MAUREEN C. WALK
DATE	12-23-72	BY	MAUREEN C. WALK	DATE	6-7-84	BY	L. NELSON

ONAN CORPORATION
 MINNEAPOLIS, MINNESOTA

612-6267

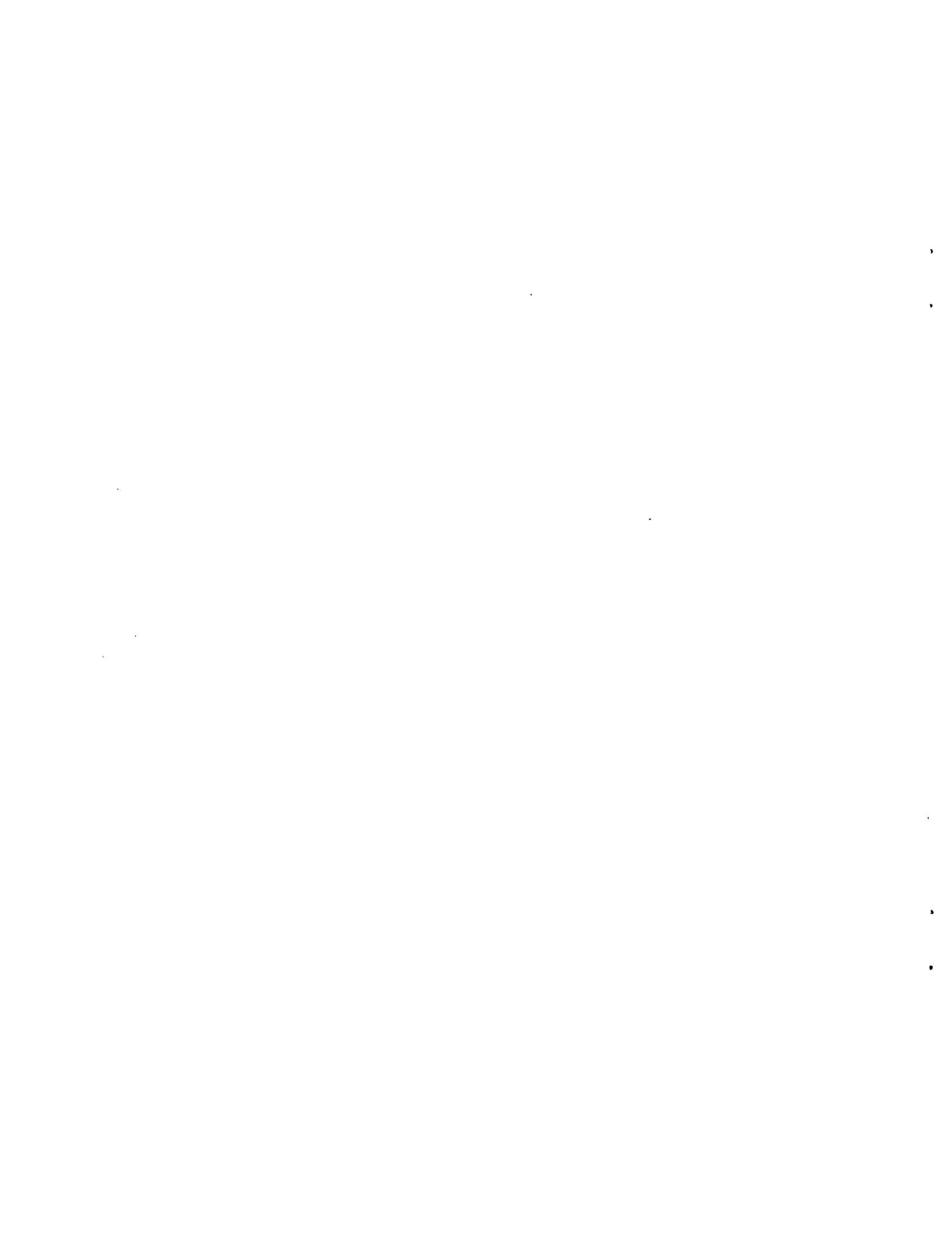

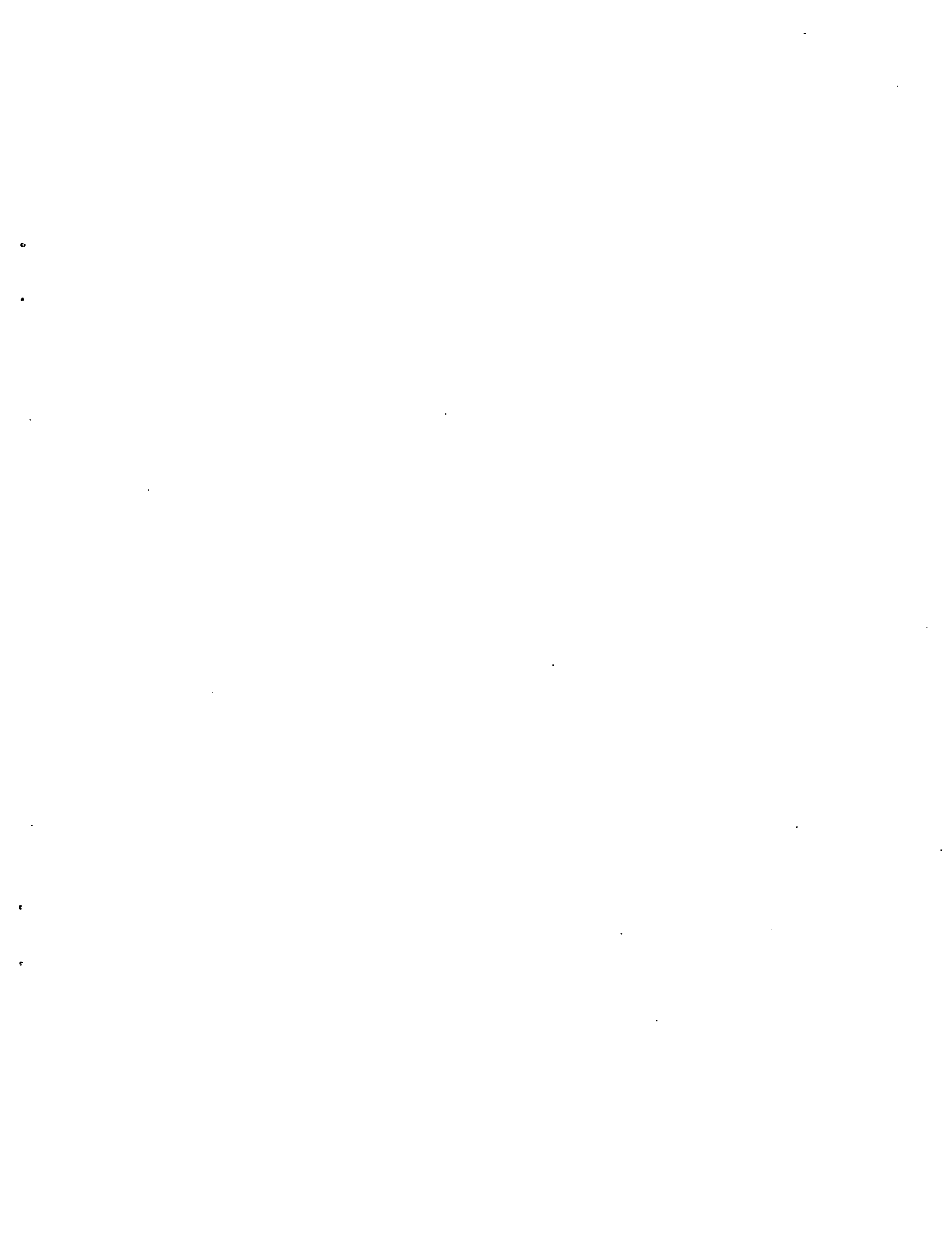

Onan

**Onan Corporation
1400 73rd Avenue N.E.
Minneapolis, MN 55432
1-800-888-ONAN
612-574-5000 International Use
Telex: 275477
Fax: 612-574-8087**

Onan is a registered trademark of Onan Corporation