



Models: MO18M, MO24M

Installation Instructions



Installation and service of this appliance should be performed by qualified personnel. CFM suggests NFI certified or factory-trained professionals, or technicians supervised by an NFI certified professional.



Majestic Burner/Hearth and Log Kits For Natural Gas Use Only

Intended for use in all CFM Corporation factory built fireplaces

Check with your local building code agency before you begin installation to ensure compliance with local codes, including the need for permits and follow-up inspections. If you encounter any problems regarding code approvals, or if you need clarification of any of the instructions contained here, contact the Technical Services Dept.,

CAUTION



DO NOT DISCARD THIS MANUAL

- Important operating and maintenance instructions included.
- Read, understand and follow these instructions for safe installation and operation.
- Leave this manual with party responsible for use and operation.



⚠ WARNING



If the information in these instructions is not followed exactly, a fire may result causing property damage, personal injury, or death.

- Do not store or use gasoline or other flammable vapors and liquids in the vicinity of this or any other appliance.
- **What to do if you smell gas:**
 - Do not try to light any appliance.
 - Do not touch any electrical switch. Do not use any phone in your building.
 - Immediately call your gas supplier from a neighbor's phone. Follow the gas supplier's instructions.
 - If you cannot reach your gas supplier, call the fire department.
- Installation and service must be performed by a qualified installer, service agency, or the gas supplier.

⚠ WARNING



HOT! DO NOT TOUCH. SEVERE BURNS MAY RESULT. CLOTHING IGNITION MAY RESULT.



Glass and other surfaces are hot during operation and cool down.

- Keep children away.
- CAREFULLY SUPERVISE children in same room as appliance.
- Alert children and adults to hazards of high temperatures.
- Keep clothing, furniture, draperies and other combustibles away.

In the Commonwealth of Massachusetts:

- This appliance must be installed by a licensed plumber or gas fitter.
- The chimney flue damper, when used with gas logs, will be welded open or completely removed.
- A CO detector shall be installed in the room where the appliance is installed.

**Read this manual before installing or operating this appliance.
Please retain this owner's manual for future reference.**

Congratulations

Congratulations on selecting a CFM gas log set—an elegant and clean alternative to burning wood. The CFM gas log set you have selected is designed to provide the utmost in safety, reliability, and efficiency.

As the owner of this new gas log set, you'll want to read and carefully follow all of the instructions contained in this owner's manual. Pay special attention to all cautions and warnings.

This owner's manual should be retained for future reference. We suggest you keep it with your other important documents and product manuals.

The information contained in this owner's manual, unless noted otherwise, applies to all models and gas control systems.

Your new gas log set will give you years of durable use and trouble-free enjoyment.

Homeowner Reference Information	<i>We recommend that you record the following pertinent information about your gas log set:</i>
Model Name: _____	Date purchased/installed: _____
Serial Number: _____	Location on appliance: _____
Dealership purchased from: _____	Dealer phone: _____
Notes: _____	

Listing Label Information/Location

The model information regarding your specific gas log set can be found on the rating plate.

CFM Majestic	
Decorative Gas Logs	
	
Complies with RGA2-72	
NOTE: TO BE USED IN A WOOD-BURNING FIRE PLACE ONLY. KEEP DAMPER WIDE OPEN WHEN IN USE.	
FOR YOUR SAFETY	
Do not store or use gasoline or other flammable vapors and liquids in the vicinity of this or any other appliance	
MODEL NUMBER	<input type="text"/>
SERIAL NUMBER	<input type="text"/>
INPUT RATING	<input type="text"/>
GAS TYPE	<input type="text"/>
MANIFOLD PRESS.	<input type="text"/> In water column
Manufacture: CFM Corporation - Decatur, GA 30035	

Table of Contents

1	Listing and Code Approvals	
	A. Appliance Certification	4
	B. Table 1	4
2	Getting Started	
	A. Size of Firebox	5
	B. Negative Pressure	5
	C. Tools and Supplies Needed	5
	D. Inspect the Appliance and Components	5
	E. Components of the Gas Hearth Kit	6
3	Appliance Preparation	
	A. Gas Supply Connection	7
	B. Convert to Left Side Gas Piping	7
	C. Gas Pressure	8
4	Installation Instructions	
	A. Install the Damper Stop	9
	B. Install the Burner/Pan Assembly	10
	C. Install the Grate	10
	D. Place Sand and Rockwool	10
	E. Install the Logs	11
	F. Adjust the Burner Flame	11
	G. Inspect the Venting System	11
5	Operating Instructions	
	A. Lighting Instructions	12
	B. Glass Doors	13
	C. Important Safeguards	13
6	Maintaining and Servicing the Appliance	
	A. Servicing Your Appliance	14
	B. Cleaning Your Appliance	14
	C. Annual Inspection	14
	D. Troubleshooting	14
7	Reference Materials	
	A. Replacement Parts	15
	B. Owner Registration/Warranty	17

1 Listing and Code Approvals



A. Appliance Certification

The Gas Log Hearth Kits have been tested and listed in the U.S. in accordance with **ANSI Z21.84-2003** (Gas Log Set). They have been listed by OMNI Test Labs for installation and operation in the United States and Canada as described in these Installation and Operating Instructions. All components are UL, OMNI or CSA safety certified.

Check with your local building code agency prior to installing this appliance to ensure compliance with local codes, including the need for permits and follow-up inspections. In the absence of local codes, comply with the **National Fuel Gas Code, ANSI Z223.1-Latest Edition** in the U.S. If any assistance is required during installation, please contact your local dealer.

B. Table 1

 WARNING
Improper installation, adjustment, alteration, service or maintenance can cause injury or property damage. Refer to the owner's information manual provided with this appliance. For assistance or additional information consult a qualified installer, service agency or the gas supplier.

 WARNING
  <p>Fire Risk Exhaust Fumes Risk</p> <ul style="list-style-type: none"> Do NOT use this appliance as a "vent-free heater." <p>The flue must be permanently open. Refer to Table 1.</p>

Product		18"	24"
Inlet BTU	Nat.	67,000	68,000
Max. Inlet Pressure IN. WC / KPa	Nat.	10.0 / .052	10 / .052
Min. Inlet Pressure IN. WC / KPa	Nat.	3.5 / .018	3.5 / .018
Orifice Size In.	Nat.	(#28)	(#26)
Minimum Fireplace Opening Size In. / cm	Front	33	38
	Rear	20	26
	Depth	15	15
	Height	21	21
Min. Vent Opening in Square In. / cm		39 / 251.6	48 / 309.7

These Hearth/Log Kits are for use with all CFM Factory built fireplaces.

2 Getting Started

A. Size of Firebox

See Table 1 in Section 1.B.

B. Negative Pressure

Negative pressure results from the imbalance of air available for the fireplace to operate properly. Causes for this imbalance include:

- Exhaust fans (kitchen, bath, etc.).
- Range hoods.
- Combustion air requirements for furnaces, water heaters and other combustion appliances.
- Clothes dryers.
- Location of return-air vents to furnace or air conditioning.
- Imbalances of the HVAC air handling system.
- Upper level air leaks: recessed lighting, attic hatch opening, duct leaks.

C. Tools and Supplies Needed

Tools and supplies normally required for installation:

- Pliers
- Phillips screwdriver
- Tape measure
- Crescent wrenches
- Gas shutoff valve
- Non-corrosive leak check solution
- 3/4 in. wrench, 7/16 in. wrench

D. Inspect the Appliance and Components

- Remove the contents from the carton. Attached to the burner are tags identifying the manufacturer name, serial number, model number (including gas log size), BTU ratings, gas type, etc.
- Review the attached tags before proceeding. Ensure that all minimum fireplace dimension requirements are achieved using Table 1 in Section 1.B. Ensure the gas type provided in the fireplace coincide with the gas type marked on the tag.

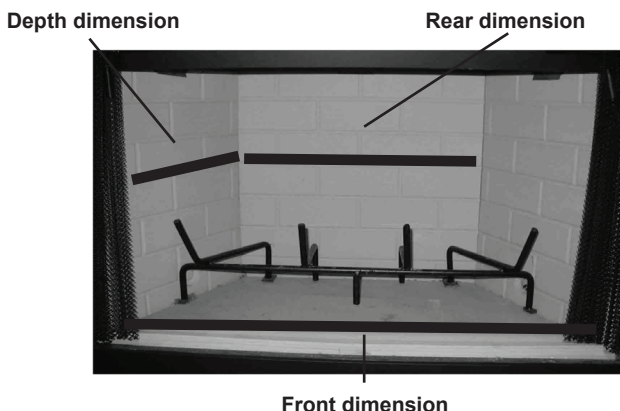

CAUTION



Sharp Edges

- Wear protective gloves and safety glasses during installation.



WARNING



Asphyxiation Risk

This appliance produces carbon monoxide (CO).

- The free opening areas (in square inches) of the chimney damper as shown in the tables must be met.
- User must make sure damper is locked open.
- The installer is responsible to ensure proper ventilation of flue gases before appliance is used.

Fire needs to draft properly for safe operation.



WARNING





CFM disclaims any responsibility for, and the warranty will be voided by, the following actions:

- Installation and use of any damaged appliance or vent system component.
- Modification of the appliance or vent system.
- Installation other than as instructed by CFM• Improper positioning of the gas logs or the glass door.
- Installation and/or use of any component part not approved by CFM.

Any such action may cause a fire hazard.

	⚠ WARNING
	<p>Inspect appliance and components for damage. Damaged parts may impair safe operation.</p> <ul style="list-style-type: none"> • Do NOT install damaged components. • Do NOT install incomplete components. • Do NOT install substitute components. <p>Report damaged parts to dealer.</p>
	



	⚠ WARNING	
	<p>Keep appliance dry.</p> <ul style="list-style-type: none"> • Mold or rust may cause odors. • Water may damage controls. 	

E. Components of the Gas Hearth and Log Kit

The Burner/Hearth Kit consists of the following:

- Burner/Pan Assembly
- Grate Assembly
- Glowing Embers
- Sand
- Lava Rock
- Damper Stop
- Aluminum Tubing Assembly
- Brass Elbow Connector
- Brass Orifice & Cap
- Log Set

⚠ WARNING
<p>Do NOT use this appliance if any part has been under water. Immediately call a qualified service technician to inspect the appliance and to replace any part of the control system and any gas control which has been under water.</p>

⚠ WARNING
<div style="display: flex; flex-direction: column; align-items: flex-start;"> <div style="margin-bottom: 10px;"></div> <div style="margin-bottom: 10px;"></div> </div> <p>Shock Risk Fire Risk</p> <p>Use ONLY optional accessories approved for this appliance.</p> <ul style="list-style-type: none"> • Using non-listed accessories voids warranty. • Using non-listed accessories may result in a safety hazard. • Only CFM approved accessories may be used safely.



3 Appliance Preparation





Note: Have the gas supply line installed in accordance with local building codes, if any. If not, follow **ANSI 223.1**. Installation should be done by a qualified installer approved and/or licensed as required by the locality. (In the Commonwealth of Massachusetts installation must be performed by a licensed plumber or gas fitter.)

A. Gas Supply Connection

Ensure fittings are of the appropriate size and type on the gas line connection. If the tubing has to be cut to length be sure to use the proper cutting and flaring tool. Also, be careful not to crimp the tubing while bending. If the tubing becomes crimped, do not use for installation.

Certified joint compound or Teflon tape must be used on all threaded male connections to ensure a tight seal.



 WARNING	
	Gas Leak Risk
	<ul style="list-style-type: none">• Support control when attaching pipe to prevent bending gas line.

 WARNING		
	Fire Risk Explosion Risk Personal Injury Risk	
	An explosion could occur if a connection is made directly to an unregulated propane (LP) tank.	

Note: An individual manual shutoff valve (not supplied) is required when installing this appliance. Check local codes for location of shut off valve.

Note: A listed (and Commonwealth of Massachusetts approved) 1/2 in. (13 mm) T-handle manual shut-off valve and flexible gas connector are connected to the 1/2 in. (13 mm) control valve inlet.

- **If substituting for these components, please consult local codes for compliance.**



 WARNING	
	Fire Risk Explosion Risk
	Verify inlet pressures. <ul style="list-style-type: none">• High pressure may cause overfire condition.• Low pressure may cause explosion. Install regulator upstream of valve if line pressure is greater than 1/2 psig.

B. Convert to Left Side Gas Piping

- Remove the brass elbow from the right side.
- Remove the cap from the left side.



Note: Prior to installing the fittings, use Teflon tape or joint compound on the male threads.





- Replace the cap on the opposite end of the burner tube.
- Install the brass elbow on the left side of the burner.

 WARNING	
	Fire Risk Explosion Risk
	<ul style="list-style-type: none">• Gas build-up during line purge may ignite.• Purge should be performed by qualified technician.• Ensure adequate ventilation.• Ensure there are no ignition sources such as sparks or open flames.

C. Gas Pressure

Proper input pressures are required for optimum appliance performance. Gas line sizing requirements need to be made following **NFPA54** and **CSA B-149**.

	WARNING
	Fire Risk
	Explosion Risk
	High pressure will damage valve.
	<ul style="list-style-type: none">• Disconnect gas supply piping BEFORE pressure testing gas line at test pressures above 1/2 psig.• Close the manual shutoff valve BEFORE pressure testing gas line at test pressures equal to or less than 1/2 psig.

	WARNING
	CHECK FOR GAS LEAKS
	Fire Risk
	Explosion Risk
	Asphyxiation Risk
	<ul style="list-style-type: none">• Check all fittings and connections.• Do not use open flame.• After the gas line installation is complete, all connections must be tightened and checked for leaks with a commercially available, non-corrosive leak check solution. Be sure to rinse off all leak check solution following testing.
	Fittings and connections may have loosened during shipping and handling.

High Altitude Derate
In the USA, input BTU shall be derated 4% (one orifice size) per 1000 feet for altitudes above 2000 feet. In Canada, input BTU shall be derated 10% (two orifice sizes) at altitudes from 2000-4500 feet.

- Gas Supply Pressure: Minimum inlet gas supply pressure must be 3.5 in. W.C. for the purpose of input adjustment. Maximum inlet gas pressure must not exceed 10.0 in. W.C. The gas line supplying the appliance must be sufficient size to furnish the appropriate supply pressure to the appliance while operating in the “High” setting.
- Gas Line Pressure Test: Perform pressure test according to state and local code (if pressure exceeds 1/2 in. psi [3.5 kPa]) before appliance is connected. Be sure to release air pressure from the gas line before connection is made to the appliance.
- Gas Leak Test: Make sure the gas connections are tight. Turn on the gas and coat each joint with a non-corrosive gas leak check solution. Always check for gas leaks with a mild soap and water solution applied with a brush no larger than 1” (25mm). Never apply soap and water solution with a spray bottle. Air bubbles will form indicating any leaks. **DO NOT USE A FLAME OR ANY TYPE OF IGNITION SOURCE TO CHECK FOR LEAKS.** All leaks must be corrected before proceeding with installation.
- The appliance must only be installed in a solid-fuel burning fireplace *with the flue damper clamped open*. The fireplace must be constructed of non-combustible material.
- The minimum permanent free opening (in square inches) that must be provided by the fireplace chimney or damper to vent the flue gases is provided in Table 1. If the free opening is smaller than the specified area, do not use this appliance.
- The damper must be removed or fixed in a manner in which will secure it open. Some jurisdictions require the damper to be removed or permanently welded fully open. Check with state and local codes.
- Be sure that the chimney is completely unobstructed to ensure proper ventilation of flue gases including carbon monoxide (CO). CO (a poisonous gas) is tasteless, odorless, colorless and undetectable without proper equipment.

4 Installation Instructions

A. Damper Stop:

For Use with BR, BC, SR, SC, TF and TL Series CFM Corporation Fireplaces

This Damper Stop is designed to work on all CFM Corporation BR, BC, SR, TF and TL series fireplaces. For all other fireplaces, refer to note below.

When installing a decorative gas appliance in a fireplace, some local codes require this Damper Stop to be used so the Damper will not close completely. To install the Damper Stop:

The Damper Locking Bracket is already installed on all BR, BC, SR, TF and TL fireplaces. Locate the Damper Locking Bracket on the left side of the fireplace's Combustion Dome. (Fig. 1)

With the Damper open, align the two slots on either side of the cut-out on the Damper Stop with the two small holes on the angled portion of the Damper Locking Bracket. Attach the Damper Stop with the Screws provided, as shown in Figure 2.

NOTE: Some of the early fireplace units may not have the holes in the end of the Damper Locking Bracket. If this is the case, use the Damper Stop as a template to drill two (2) 1/8" holes in the Damper Locking Bracket to mount the Damper Stop.

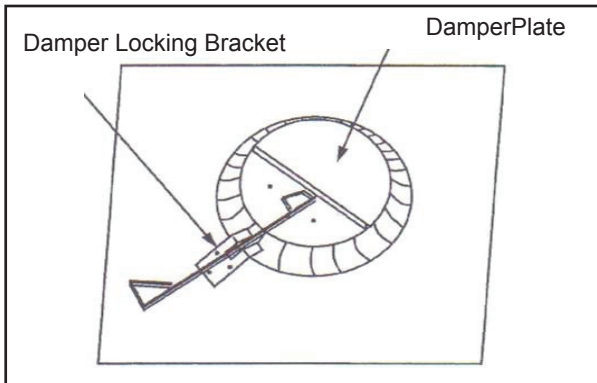

Figure 1

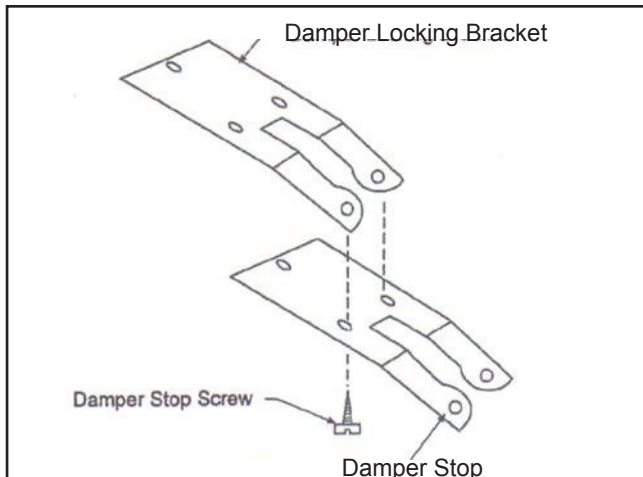

Figure 2

For Use With All Other Fireplaces

The Damper Clamp provided keeps your damper from accidentally closing during operation of your set. This Damper Clamp must be installed onto your Damper at all times. NOTE: The damper clamp is designed to hold the damper plate open 3 inches. However, the damper must be fully open when the log set is in operation.

Install the Damper Clamp onto the edge of the damper plate. Attach by securing the bolt provided to the damper plate with an adjustable wrench. (Fig. 3)

If the Damper Clamp does not fit, drill a 1/4" hole onto the damper plate and install an anchor bolt with a nut, at a 90 degree angle, so that the damper plate will remain fully open.

The proper finished installation of the Damper Clamp is shown in Figure 4. If the bolt fails to block the damper in an open position, the damper should be removed from the chimney.

To check your vent for proper drafting: Light a tightly rolled newspaper on one end and place it at the inside front edge of the fireplace. Observe the smoke and be sure the vent is properly drawing it up the chimney. If the smoke is drawn back into the room, extinguish the flame and remove any obstruction until proper venting is achieved. If that fails, check with a qualified chimney sweep.

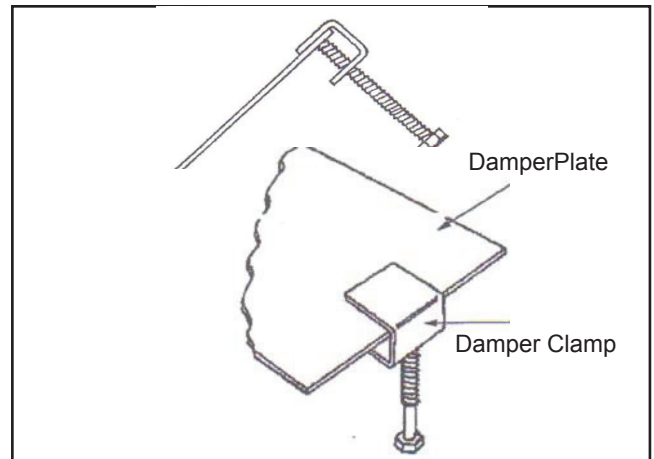

Figure 3

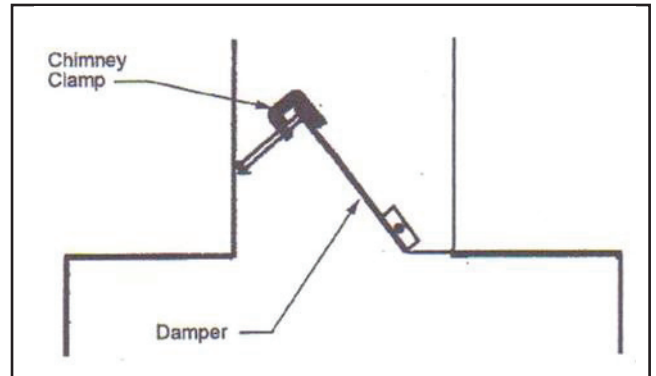

Figure 4

20012914 7/05 Rev. 0

B. Install the Burner/Pan Assembly

The burner/pan assembly is shipped ready for right-hand gas connection. See Section 3.B. for left-hand connection.

- Remove the existing cap or gas jet assembly from the gas stub in your fireplace. Clean the threads using a wire brush or steel wool. Apply Teflon tape or pipe dope to the steel fitting and attach the provided brass adapter to the stub.
- Place the burner/pan assembly in the fireplace. The pan should be centered both front to back and side to side.
- Bend the provided gas connector to facilitate its installation between the burner and the gas stub.
- Attach one end of the gas connector to the brass elbow or safety pilot fitting. Attach the other end to the brass adapter at the gas tube.

C. Grate

- The grate, supplied with the firebox will be centered within the firebox. Refer to Figure 4.2.



Figure 4.2 Center Grate Over Burner Pan

D. Place Sand and Rockwool

- Pour the sand into the burner pan. Sand should follow the slope of pan, covering it and the burner tube completely.
- Allow the sand to spill out the front of the pan and over the sides onto the fireplace floor.
- Lightly place dime-sized pieces of rockwool evenly on top of the sand.
- The gas burns at the point of the least resistance. In case of an uneven flame pattern it may be necessary to adjust the materials in the pans (using an object such as a long screwdriver) to achieve the desired effect.







WARNING

Explosion Risk

- Follow rockwool placement instructions in this manual.
 - Replace rockwool material annually.
- Improperly placed rockwool interferes with proper burner operation.

Note: For best results, do not pack down the rock wool. The placement of rock wool can have an effect on flame pattern and may need to be adjusted to achieve a desired appearance.

E. Install the Logs

	WARNING	
	<p>Fire Risk Explosion Risk Personal Injury Risk</p>	
	<p>Failure to position the parts in accordance with the diagrams provided with the log packages or failure to use only parts approved with this appliance may result in property damage or personal injury.</p>	

- Install the logs using the installation instructions included with them.
- Light the burner as outlined in the operating section. Allow the flame pattern to stabilize. If you are satisfied with the flame pattern go to the next step. If you want more or less flame around the front log, turn off the gas and move the burner pan backward or forward.
- Once you are satisfied, turn on the gas and go on to the next step.
- Arrange the top logs as shown in your log set up instructions. Light the burner as outlined in the operating instructions and allow the flame to stabilize.
- Spread the lava rock around the outside of the burner pan on the floor of the fireplace. If possible, cover the gas connector with the cinders.

MO18



Step 1



Step 2



Step 3

MO24



Step 1



Step 2



Step 3

F. Adjust the Burner Flame

- The burner flame can be adjusted at the manual shutoff valve beside the fireplace to obtain the desired flame appearance.
- The flame color will stabilize after ten minutes of operation.

G. Inspect the Venting System

The fireplace venting system is designed and constructed to develop a positive flow adequate to remove flue gases to the outside atmosphere. See fireplace installation instructions.

A spillage test must be made before the installed appliance is left with the consumer



- Close all doors and windows in the home.
- Light the log set.
- After three minutes, test with a smoke match, smoke candle, stick incense or cigarette one inch below the top of the opening (lintel) moving across the full width. If spillage (smoke drawn into the room) occurs, it will most likely be near the top, outside corners.

Possible Cures if Spilling Occurs

- The damper should be fully open.
- The fireplace opening needs to be reduced by adding a drop panel across the top under the lintel.
- The air supply from outdoors needs to be increased. Open the outside air kit if the appliance is so equipped, or crack open a door or window.
- If necessary, seek expert advice. Do not operate this appliance.

Cleaning

- Periodic examination and cleaning of the venting system of the fireplace should be done before initial use and at least annually by a qualified agency.

	WARNING
	<p>Fire Risk Explosion Risk Inspect external vent cap regularly.</p>
	<ul style="list-style-type: none"> • Ensure no debris blocks cap. • Combustible materials blocking cap may ignite. • Restricted air flow affects burner operation.

5 Operating Instructions

A. Lighting Instructions

FOR YOUR SAFETY READ BEFORE LIGHTING

WARNING! IF THESE INSTRUCTIONS ARE NOT FOLLOWED EXACTLY, A FIRE OR EXPLOSION MAY RESULT CAUSING PROPERTY DAMAGE, PERSONAL INJURY OR LOSS OF LIFE.

- A. This appliance has a manually lighted burner and must be lit by hand. When lighting the burner, follow these instructions exactly.
- B. **BEFORE LIGHTING** smell all around the appliance area for gas. Be sure to smell next to the floor because some gas will settle on the floor.
WHAT TO DO IF YOU SMELL GAS
 - Do not try to light any appliance.
 - Do not touch any electrical switch; do not use any phone in your building.
 - Immediately call your gas supplier from a neighbor's phone. Follow the gas supplier's instructions.
 - If you cannot reach your gas supplier, call the fire department.
- C. Do not use this appliance if any part has been under water. Immediately call a qualified service technician to inspect the appliance and to replace any part of the control system and any gas control that has been under water.
- D. Use only your hand to push in or turn the gas control handle. Never use tools. If the handle will not push in or turn by hand, do not try to repair it. Call a qualified service technician. Force or attempted repair may result in fire or explosion.

LIGHTING INSTRUCTIONS

1. **STOP!** Read the safety information previously listed above.
2. Turn gas control manual valve to the full "OFF" position.
3. Wait 5 minutes to clear out any gas. Then smell for gas, including near the floor. If you smell gas, **STOP!** Follow "3" in the safety information above on this label. If you can't smell gas go to the next step.
4. Place a lit match on the surface of the burning embers. Do not hold match in hand.
5. Turn gas control manual valve to the full "ON" position.
6. If appliance will not operate, follow the instructions "TO TURN OFF GAS TO APPLIANCE" and call your service technician or gas supplier.

TO TURN OFF GAS TO APPLIANCE

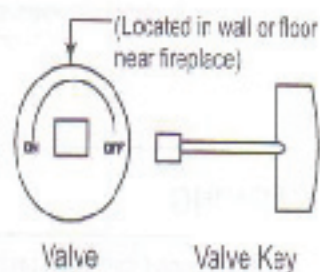

Turn manual gas control handle to "OFF" position. Do not force.



B. Glass Doors

If your fireplace is equipped with glass doors:

- Glass doors should be in fully open position when appliance is operating.
- Operating in the closed position will block the radiant heat output and may cause incomplete combustion of the gas and increase overheating of the system.

	WARNING
	Fire Risk
	Explosion Risk
	Do not close the glass doors during appliance operation.
	<ul style="list-style-type: none">• Could cause incomplete combustion of the gas.



- Glass doors may be closed when the hearth kit is not being used.

C. Important Safeguards

- Other Fuels
 - Although your gas log set is very realistic in appearance, it is not a real woodburning fire and must not be used for burning any fuel other than natural gas.
 - To avoid irreparable damage to the appliance and/or personal injury, wood, matches, paper, garbage or any other material must not be placed or thrown on top of the logs.
- Appliance Safety
 - To avoid personal injury, do not touch hot surfaces when the appliance is operating.
 - Always ensure that the fireplace screen is closed when the appliance is operating.
 - Close supervision is necessary when the appliance is being used near children.
- Do not remove any of the attached metal plates, which contain important safety and operating information.
- Keep the appliance area clear and free of all combustible materials, gasoline and other flammable vapors and liquids.

	WARNING
Do NOT use this appliance if any part has been under water. Immediately call a qualified service technician to inspect the appliance and to replace any part of the control system and any gas control which has been under water.	

- **A qualified service technician must perform installation and repair.** The appliance should be inspected and cleaned annually by a qualified service technician. More frequent cleaning may be required due to excessive lint, dust, pet hair, etc. It is imperative that the control compartments, burners and air passageways are unobstructed during operation.
 - Review proper placement of logs, rockwool, lava rock and sand.
 - Ensure there are no gas leaks.
 - Ensure the flow of combustion and ventilation air is not obstructed (front grilles and vent caps).
- Before installing into a solid fuel burning fireplace, the chimney and firebox should be inspected and cleaned to remove soot, creosote, ashes, paint, bird nests etc.
- Annual examination of the chimney must be performed by a qualified agency to ensure proper ventilation of flue gases created by this appliance.
- Have the chimney and adjacent structure inspected and cleaned by qualified professionals. Hearth & Home Technologies recommends that NFI certified professionals, or technicians under the direction of certified professionals, conduct a minimum of an **NFPA 211 Level 2** inspection of the chimney.
- Replace component parts of the chimney and fireplace as specified by the professionals.
- Ensure all joints are properly engaged and the chimney is properly secured.
- Do not allow fans to blow directly into the fireplace. Avoid any drafts that alter burner flame pattern.
- Do not use a blower insert, heat exchanger insert or other accessories not approved for use with this appliance. Solid fuels shall not be burned in a fireplace where a decorative appliance is installed.
- If glass doors are present, the **glass doors must be fully opened** while appliance is in operation.

	WARNING
	Fire Risk
	High Temperatures
	Keep combustible household items away from appliance.
	Do NOT obstruct combustion and ventilation air.
	<ul style="list-style-type: none">• Do NOT place combustible items on top of or in front of appliance.• Keep furniture, draperies away from appliance.

6 Maintaining and Servicing the Appliance

A. Servicing Your Appliance

 **WARNING**

Risk of injury or property damage

Before servicing:

- Turn off gas.
- Turn off electricity to appliance.
- Disable remote control, if one is present.
- Ensure appliance is completely cooled.

After Servicing:

- Replace any screen or barrier that was removed.
- Reseal and reinstall any venting removed for servicing.

- Repair and replacement work should be done by a qualified service technician.
- Always shut off the gas supply and make sure the appliance is cool before beginning any service operation.
- Always check for gas leaks after servicing.
- Always check for proper venting.

B. Cleaning Your Appliance

Your gas logs require little care. Keep the burner assembly, logs and burner area surrounding the logs clean by vacuuming or brushing with a dry paint brush at least twice a year.

- The logs become fragile after burning. Take care in handling.
- Always turn off the gas before cleaning. For relighting, refer to lighting instructions located in Section 5.A. of these instructions.
- Always keep the appliance clear and free from combustible materials, gasoline, and other flammable vapors and liquids.
- Never obstruct the flow of combustion and ventilation air. Keep the front of the appliance clear of all obstacles and materials.
- Leave clearance of at least 36 in. from the front of the fireplace.
- The air shutter should not be blocked.

 **CAUTION**

- Logs can get very hot. Handle only when they are cool.

C. Annual Inspection

 **WARNING**



Annual inspection by qualified technician recommended.

Check:

- Condition of doors, surrounds and fronts.
- Obstructions of combustion and ventilation air.
- Condition of logs.
- Condition of firebox.
- Gas connections and fittings.
- Obstructions of termination cap.

Clean:

- Glass.
- Logs.
- Burner, burner ports.

Risk of:

- Fire
- Delayed ignition or explosion
- Exposure to combustion fumes
- Odors

D. Troubleshooting

With proper installation and maintenance, your new decorative gas appliance should provide years of trouble-free service. If you do experience a problem, refer to the troubleshooting guide below. This guide will assist you or a qualified service technician in the diagnosis of problems and the corrective action to be taken.

Symptoms	Possible Causes	Corrective Action
1. A match will not light the main burner; no gas to the main burner	A. Main gas shutoff valve is closed	1. Make sure the shutoff valve located on the incoming gas line is open.
	B. There is air in the gas line.	1. Bleed air from the gas line; wait five minutes and attempt to relight the main burner.
	C. No gas supply to the appliance.	1. Check the plumbing to ensure the appliance has been hooked up to the gas supply line.
	D. A blockage is preventing gas flow.	1. Inspect the burner orifice for obstruction. Call a qualified service technician.

7 Reference Materials

A. Replacement Parts

Replacement Parts

CFM HEARTH KITS

Exploded Parts Diagram

1 - Burner Pan Assembly



2 - Grate Assembly

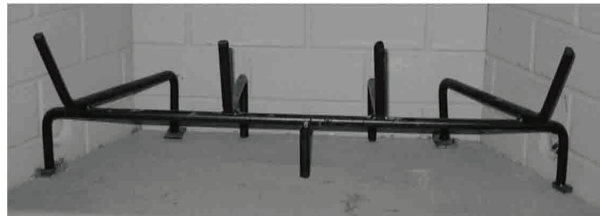

3 - Hearth Kit Assembly

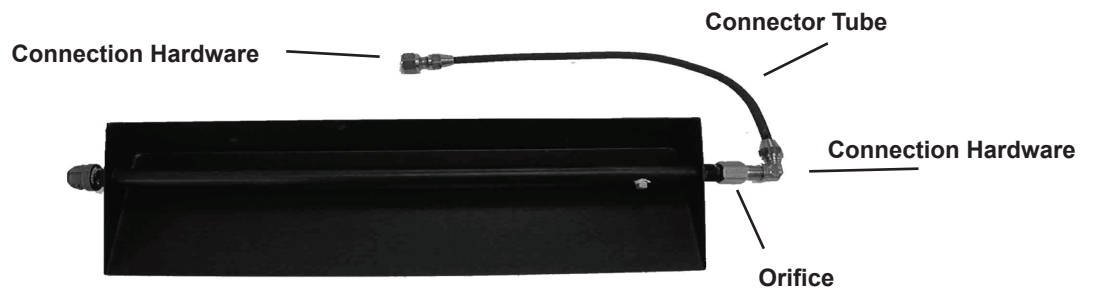

Service Parts List

Description of Part		MO18M	MO24M	Qty.
	Damper Stop Assy	4304045	4304045	1
	Burner Pan Assy	20013012	20013013	1
	Orifice	20013017	20013018	1
	Connector Tube	20013023	20013023	1
	Sand	4310006	4310006	1
	Lava Rock	4310010	4310010	1
	Glowing Embers	4310001	4310001	1
	Damper Stop for BR/BC, SR/SC, TF/TL only	3030176	3030176	1
	Damper Stop Screws	7521901	7521901	2

Description of Log Parts		MO18M	MO24M	Qty.
	Log 1	20013043	20013048	1
	Log 2	20013044	20013049	1
	Log 3	20013045	20013050	1
	Log 4	20013046	20013051	1
	Log 5	20013047	20013052	1



Log 1



Log 2



Log 1



Log 2



Log 3



Log 4



Log 3



Log 4



Log 5



Log 5

B. Optional Components

Safety Pilot Burner/Hearth Kits	
20013010	Hearth ember burner for 18 in. hearth kits
20013011	Hearth ember burner for 24 in. hearth kits

Remote Ready Burner/Hearth Kits	
20013019	Hearth ember burner for 18 in. hearth kits
20013020	Hearth ember burner for 24 in. hearth kits
20013021	on/off remote control
20013022	Wall switch (on/off only)
20013025	Switch in Log

B. Owner Registration/Warranty

Please complete and return your owner registration card to ensure proper warranty coverage. If you wish to communicate with the factory, write to

LIMITED ONE YEAR WARRANTY

For CFM Corporation Decorative Gas Appliances

CFM Corporation extends the warranties specified in paragraphs A and B below with respect to its Vermont Castings Decorative Appliances (the "Gas Appliance"), including CFM Corporation supplied accessories and components referred to in those paragraphs, subject to the following conditions and limitations:

(1) These warranties extended only the the Gas Appliance installed in the continental United States, including Alaska, and Canada; only if and so long as the accordance with the installation and operating instructions furnished therewith; and only if and so long as Gas Appliance is not removed from its original installation.

(2) These warranties are limited to only the component parts manufactured and supplied by CFM Corporation. The use of components manufactured by others with the Gas Appliance (except for a listed Type B venting system and defined in the installation instructions) could create serious safety hazard, may result in the denial of certification by recognized national safety agencies, and could be in violation of local building codes.

(3) The Gas Appliance must be operated at all times in accordance with the operating instruction furnished therewith. The Gas Appliance is designed to burn either natural or propane gas only. Burning conventional fireplace fuels such as wood, coal, or any other solid fuel will cause damage to the Gas Appliance, will produce excessive temperatures and will result in fire hazard.

(4) These warranties are limited to repair, replacement or furnishing a replacement for sale, as specified in Paragraphs A and B, for a part found to CFM Corporation satisfaction, after examination, to be defective in materials or workmanship under normal conditions, use and service.

(5) All obligations with respect to these warranties may be fully discharged by CFM Corporation refunding the wholesale price of a defective part.

(6) Except as otherwise expressly specified in Paragraphs A and B. NONE OF THESE WARRANTIES COVER AND CFM CORPORATION SHALL NOT BE RESPONSIBLE FOR, ANY CONSTRUCTION, INSTALLATION, LABOR, TRANSPORTATION OR OTHER COSTS OR EXPENSES ARISING FROM A DEFECTIVE PART, ITS REPAIR OR REPLACEMENT OR OTHERWISE, NOR SHALL CFM CORPORATION IN ANY EVENT BE RESPONSIBLE FOR ANY INDIRECT, INCIDENTAL OR CONSEQUENTIAL DAMAGES, EXCEPT TO THE EXTENT PROVIDED BY LAW. THERE ARE NO IMPLIED WARRANTIES WITH RESPECT TO THE GAS APPLIANCE, ITS COMPONENTS AND ACCESSORIES (INCLUDING IMPLIED WARRANTIES OF MERCHANTABILITY OR FITNESS FOR A PARTICULAR PURPOSE), ALL OF WHICH ARE HEREBY EXPRESSLY INCLUDED.

IN NO EVENT SHALL ANY IMPLIED WARRANTY PRESCRIBED BY LAW (NOTWITHSTANDING THE FOREGOING EXPRESS EXCLUSION) REMAIN IN EFFECT AFTER EXPIRATIONS OF WARRANTIES SET FORTH IN PARAGRAPHS A AND B.

A. Gas Appliances, electrical and manual components, glass panels, all sealants or adhesives and optional accessories (exclusive of CFM Corporation supplied decorative logs which are covered by a separate warranty under paragraph B below):

Within one year from the date of manufacture of the gas appliance, CFM Corporation will repair, or replace (at our option) a defective part without charge.

B. Cement or ceramic fiber log components:

Within one year from the date of manufacture of the gas appliance, CFM Corporation will replace a defective part without charge. Within one year from the date of manufacture of the gas appliance, CFM Corporation will provide a replacement for a defective part to the homeowner, but assumes no liability for incurred labor cost.

The foregoing warranties gives you specific legal rights and you may also have other rights which vary from state to state. Some states do not allow limitations on how long an implied warranty may last, so the limitation specified above on the duration of any implied warranty prescribed by law may not apply to you. Similarly, some states do not permit the exclusion or limitation of incidental or consequential damages, so the above exclusion of such damages may not apply to you.

In order to obtain performance of any of the above warranty obligations, write to the CFM Corporation at this address:

CFM Corporation
410 Admiral Blvd.
Mississauga, Ontario Canada L5T 2 N6
Attention: Manager of Warranty Services

Since local building requirements may vary greatly throughout the country, users of CFM Corporation products should determine in advance whether there are any building code restrictions on the use of a specified product. CFM CORPORATION MAKES NO REPRESENTATION OR WARRANTY REGARDING, AND SHALL NOT BE RESPONSIBLE FOR, ANY BUILDING CODE COMPLIANCE. The foregoing warranties give you specific legal rights and you may also have other rights which vary from state to state.