



MX60

PV MPPT Charge Controller



INSTALLATION AND USER'S MANUAL

Please read this entire manual prior to installing and using the MX60.

Introduction

Your OutBack PV MX60 Maximum Power Point Tracking (MPPT) charge controller enables your PV system to achieve its highest possible performance.

Rated for up to 60 amps of DC output current, your MX60 can be used with battery systems from 12 to 60 vdc with PV open circuit voltage as high as 125 vdc. The MX60's setpoints are fully adjustable to allow use with virtually any battery type, chemistry and charging profile.

Your MX60 allows you to use a higher output voltage PV array with a lower voltage battery - such as charging a 24 vdc battery with a 48 vdc PV array. This reduces wire size and power loss from the PV array to the battery/inverter location and can maximize the performance of your PV system.

Your MX60 comes standard with an easy to use and understand display of the PV system's performance. The four line, 80 character, backlit LCD display is also used for programming and monitoring of the system's operation.

Your MX60 can also be connected to the OutBack MATE system controller and display to allow monitoring of up to eight MX60 controllers from a distant location - up to 300 feet away. The MATE also includes an opto-isolated RS232 port for connection to a PC computer for data logging and system monitoring.

A built-in Auxiliary Output Control System can be used to control a secondary control circuit, relay or contactor. It can be used to control a diversion load, low battery disconnect, load management power shedding, or other functions.

Important Safety Instructions

A. SAVE THESE INSTRUCTIONS - This manual contains important instructions for the MX60 PV MPPT Charge Controller that shall be followed during installation and maintenance of the charge controller.

B. Torque the terminal block and ground terminals to 30 inch pounds / 4Nm

C. Use a minimum of 6AWG copper conductors only suitable for a minimum of 75 degrees C. The terminal block will accept up to 4 AWG conductors. The ground terminal will accept up to 2 AWG conductors.

D. This symbol is used to identify chassis ground.



E. This charge controller is intended to charge lead acid battery systems, sealed or vented with nominal voltages of 12, 24, 32, 36, 48, 54 or 60 volts DC. For other battery chemistries, contact the battery manufacturer for specific charge control settings and methodology.

F. The MX60 PV MMPT Charge Controller is for indoor use only.

Installation

The MX60 is designed to be mounted in a variety of ways. One of the more common methods of mounting is on an OutBack charge controller bracket (CCB), attached to an OutBack PSDC enclosure. Each MX60 comes with three #10 stainless steel sheet metal screws for this purpose. Under the wiring compartment cover are holes through the mounting feet for attachment to the CCB. There is also a mounting tab at the top of the MX60. When mounted to the OutBack CCB the left side knockout will line up with knockouts in the PSDC. A standard $\frac{3}{4}$ " or 1" plastic snap-in bushing will offer protection from chafing between the two boxes. Note that there are two placement options on the CCB that can be used to match with knockouts in the PSDC. Mounting holes and knockouts are compatible with C40 controllers to help set an industry standard. Two MX60 controllers may be installed on the CCB. Note the placement shown in Figure 1.



Figure 1 Two MX60 Charge Controllers mounted on a CCB

Mounting the MX60

Up to three MX60's can also be mounted on top of a PSDC. Below is a view from the top of the PSDC enclosure. The MX60 will mount using 1" TSC threaded nipples to the 2" spacings. One knockout is provided and one pilot hole for the second hole. The 1.83" spacings are for two Solar Boost controllers.

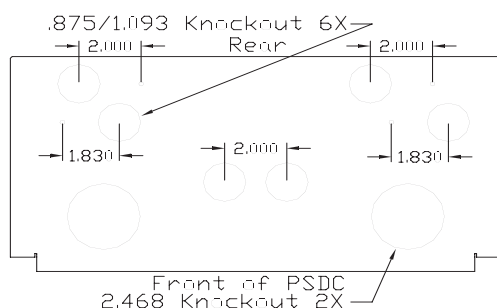

Figure 2 MX60 mounting options on the top of an OutBack PSDC, DC Disconnect Enclosure

Two 1" TSC threaded nipples may be used to secure the controller to the PSDC top for many installations. All of the wires will fit through one knockout so the second can be used as a means of attachment. If two nipples are used for wiring, then drill and through bolt to the PSDC top using a couple #10 (5mm) screws, lockwashers and nuts. Plastic snap in bushings may be substituted for metal nipples if the two boxes are screwed together. The use of a 7/8 inch spacer behind the MX60 when installed in either of the two rear positions will allow the mounting foot holes to be used to secure the chassis back to the wall.

When mounting the MX in a confined space, be careful not to block the fan opening or the air inlet holes towards the bottom of the chassis on either side. One side may be blocked, but not both. Although this will not damage the controller, it will decrease efficiency and may cause it to shut off due to an overtemperature error.

Wire and Disconnect Sizing

When wiring the MX60 note that there is a current limit on the output at 60 amps and that the unit is listed to operate continuously at 60 amps. There is no 80% derating as required by the NEC for fuses, conductors, and most circuit breakers.

The MX60 is a buck type converter and does not boost the output current when the PV array peak power point voltage is below the battery voltage as may happen on hot days in 24VDC PV and a 24VDC battery system or a 48VDC PV and a 48VDC battery system.

This unit can supply up to 60 amps output depending on the nominal PV array voltage and the nominal battery voltage. The output is current limited to 60 amps. To meet minimum NEC requirements, the output conductor should have an ampacity after any temperature and conduit fill corrections of $1.25 \times 60 = 75$ amps (NEC 310.15, 690.8,9). This would normally indicate that the output conductors would be 4 AWG, but a larger size may be required if there are temperature and/or conduit fill corrections required. With an output conductor rated at 75 amps (1.25 time continuous output current), a circuit breaker ratted for continous 100% duty at 60 amps (continuous output) like the Outback OBDC-60 breaker may be used to provide the code-required output circuit overcurrent protection and disconnect.

The PV array output connected to the MX60 input may be as high 60 amps, but at this current level, there is no current boosting or maximum power-point tracking due to the 60-amp output current limit. Additionally, the input current may exceed 60 amps on bright sunny days and any excess power would be lost. The size and ampacity of the input conductors must be selected to handle 1.56 times the short-circuit current of the PV array. Any disconnect or circuit breaker connected to the input conductors must also be rated at 1.56 times the short-circuit current for the PV array unless it the breaker rated for 100% duty in its enclosure. If that is the case, the circuit breaker may be rated at 1.25 times the PV array short-circuit current.

In terms of NEC compliance and the 60-amp output rating on the MX60, the largest PV array that can be connected to the MX60 should have a rated short-circuit current of 48 amps. This will meet NEC requirements and allow the MX60 to perform maximum power-point tracking functions. The following charts show maximum distance in feet of various guage two conductor copper wire from the PV array to the MX60 MPPT PV charge controller with a 2% maximum voltage drop. Temperature and conduit fill corrections may be required.

12 Volt PV Array

**Distance in Feet (Two Wires)
2% Voltage Drop
12 Volt Battery**

Amps	#8	#6	#4	#2	#1/0	#2/0	#4/0
8	22	35	57	90	145	180	290
10	18	28	45	72	115	145	230
15	12	19	30	48	76	96	150
20	9	14	22	36	57	72	116
30	6	9	15	24	38	48	77
40	4	7	11	18	29	36	56
50	3	5	9	14	23	29	46
60	3	4	7	12	19	24	38

24 Volt PV Array

**Distance in Feet (Two Wires)
2% Voltage Drop
12 or 24 Volt Battery System**

Amps	#8	#6	#4	#2	#1/0	#2/0	#4/0
8	45	71	114	180	290	360	580
10	36	57	91	145	230	290	460
15	24	38	60	96	153	192	300
20	18	29	45	72	115	145	232
30	12	19	30	48	77	97	154
40	9	14	23	36	58	72	112
50	7	11	18	29	46	58	86
60	6	9	15	24	38	48	77

48 Volt PV Array

**Distance in Feet (Two Wires)
2% Voltage Drop
12, 24 or 48 Volt Battery System**

Amps	#8	#6	#4	#2	#1/0	#2/0	#4/0
8	90	142	228	360	580	720	1160
10	72	114	182	290	460	580	920
15	48	76	120	192	306	384	600
20	36	58	90	144	230	290	464
30	24	38	60	96	154	194	308
40	18	28	46	72	116	144	224
50	14	22	36	58	92	116	172
60	12	19	30	48	77	97	154

60 Volt PV Array

**Distance in Feet (Two Wires)
2% Voltage Drop
12, 24 or 48 Volt Battery System**

Amps	#8	#6	#4	#2	#1/0	#2/0	#4/0
8	112	177	285	450	725	900	1450
10	90	142	227	362	575	725	1150
15	60	95	150	240	382	480	750
20	45	72	112	180	287	362	580
30	30	47	75	120	192	230	385
40	22.5	35	57	90	145	180	280
50	17.5	27	45	72	115	145	215
60	15	23	37	60	96	121	192

Surge Protection

Since PV Arrays are usually mounted on a roof or other elevated structure, protection from lightning induced power surges and other transient power disturbances between the PV array and the MX60 charge controller using a surge protection device on the input side of the MX60 is highly recommended. If the connection from the MX60 to the battery string is over 15 feet or if it is routed adjacent to other wiring or sources of power, surge protection on the battery side of the MX60 is also recommended.

Surge protection on both the input and output of the MX60 is required for extended warranty protection.

Connections

The wiring terminals for the MX60 charge controller are shown in Figure 3. There is no required connection sequence.

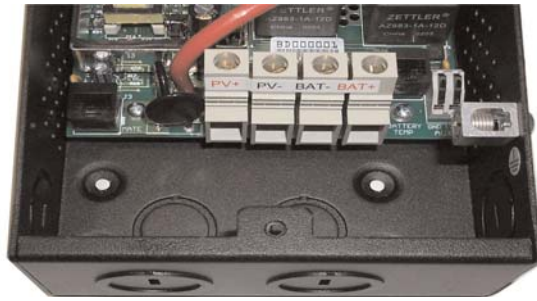

Figure 3 MX60 wiring area and wiring terminals

The large terminal block in the center is for PV+, PV-, BAT- and BAT+. The aluminum terminal on the right side of the chassis is the equipment ground. The equipment-grounding terminal can be mounted on the outside of the enclosure if desired, although normally the equipment-grounding conductors will be routed in the same conduits with the input and output circuit conductors. If the equipment grounding terminal is moved to the outside, make sure that the star washer is re-used. This washer is used to penetrate through the paint, thus grounding the chassis. NEC requires the use of an array disconnect and a battery disconnect. The MX60 can use a 60 amp 125VDC breaker such as the OBDC60 breaker.

All of the large terminals should be torqued to 30 inch pounds. The PV /BAT terminal will accept up to 4AWG wire. The equipment ground takes up to 2AWG.

An optional MX60 remote battery temperature sensor is connected to the right of the BAT+ terminal in a RJ11 marked "Battery Temp". This sensor is mounted on one of the batteries using the double back tape included. Battery manufacturers recommended charging voltages are based on 25°C / 77°F. Batteries cannot be properly charged without a remote sensor unless the batteries remain at 70°F. The OutBack Temp sensor will automatically change voltage up or down depending on the sensor's temperature. This is especially important in very hot or very cold climates. This is a highly recommended option.

To the right of the temp sense jack is a small two position terminal block marked AUX. The terminals are marked Ground and +12V. The terminals are programmable to accomplish an assortment of functions such as load diversion or alarms. The output current available on this terminal block is 200 milliamps. This is enough to power the coil of a relay or for a small piezo buzzer or LED indicator. The AUX output is protected internally by an automatic resetting poly fuse.

To the left of the PV+ terminal is an RJ45 jack marked MATE. The MATE is the OutBack remote display panel. Most of the status that is available on the MX60 is available at the Mate as well. Some triggered events can be accomplished at the MATE also.



Figure 4 The MATE System Management and Remote Control

CAUTION: It is normal for the PV input voltage to rise up to a level close to the battery voltage when the battery is connected and the PV array is disconnected. This is a normal condition for the MX60. The MX60 is designed for PV input only and will not function properly with other power sources or combinations of PV and other power sources or in parallel with other charge controllers.

Operation Status

The MX60 Charge Controller has a 4 line, 80 character LCD display and four “soft key” buttons to allow the user to adjust battery charging parameters and access other information. The MX60 has an adjustment screen lockout that requires an access code to make any changes.

The MX60 is factory preconfigured for a 12V battery system. All of the default settings are multiples of 12V nominal settings. The default bulk setting is for 14.3 VDC. The float setting is 13.15 VDC. The controller will process up to 60 amps of output current. It is recommended to install up to a maximum of 48 amps of PV to give the controller some room to boost the PV current.

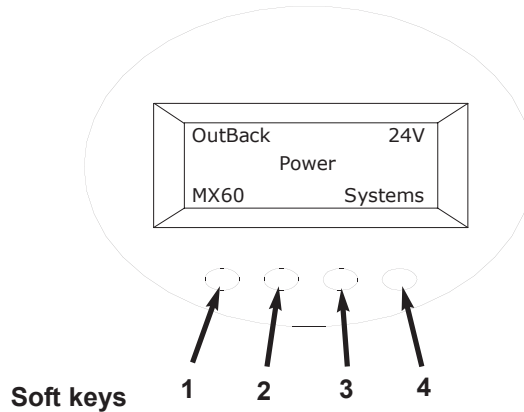

Figure 5 MX60 Start-up Screen. Note that the selected nominal battery system voltage is shown in the upper right corner.

Figure 6 shows the Main Status Screen. This default screen shows the following information:

Top Line	PV array voltage	Battery system voltage
Second Line	Current in from PV array	Current out to battery system
Third Line	Instantaneous output watts	Aux relay status
Fourth Line	Daily KWH produced	Mode of operation

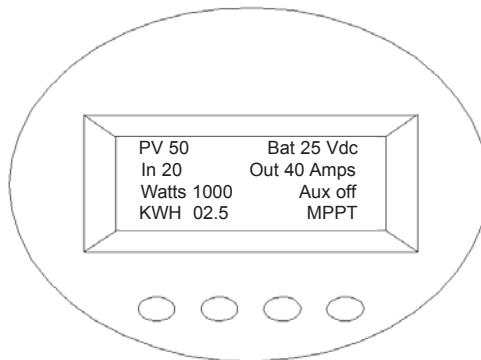

Figure 6 MX60 Main Status Screen

Software Version Check: Hold button No.2 down to show the software version.

Modes of Operation

The modes of operation will change occasionally during the day based on PV array output and battery system state of charge.

Sleeping: PV output voltage is below minimum operating levels. The MX60 is not producing any power.

Wakeup: As the PV open circuit (Voc) rises above the battery system voltage, the MX60 prepares to deliver power to the batteries. During this 5 second period the MX is calculating PWM duty cycles, turning on power supply voltages in the proper sequences, making internal calibrations and performing an initial PV IV (Amps / Volts) sweep. At the end of the wake up period the MX60 closes its relays and produces power. At dusk and dawn this will happen many times until there is not enough power from the PV array to keep going. Upon closing the relays, if it is determined that it is just still too early (or too late), the MX will display **Lolite** for a few seconds and then display **Snoozing** for 5 minutes. Think of it as if the MX has just hit the snooze button on an alarm clock and is taking a short nap.

MPPT: The MX60 is in maximum power point tracking mode and is maximizing the performance of the PV array.

Voc Err: This is an indication that the open circuit voltage of the PV is significantly above the last stored measurement. The MX60 will automatically restart after one minute. No intervention is required.

Re-cal: There are certain abnormal conditions that can confuse the current measuring method in the MX. When and if this happens, the artificial intelligence built into the MX will take a few seconds to re-calibrate the current monitoring circuit.

Bat Tmp Err: The temperature sensor is damaged. The MX60 will stop operating unless the sensor is removed.

User Configuration

Many MX60 factory set parameters can be changed by the user. Pressing the button under "NEXT" selects which parameter you are going to change. The one that is presently selected will have a * in front of it. Pressing the button under "EXIT" will store the value in non-volatile memory. Disconnecting the MX60 from the battery will not require re-programming.

SET BATTERY SYSTEM VOLTAGE FIRST !

Battery System Voltage: The nominal battery system voltage can be changed from the default of a 12 volt battery to match your particular battery system. Only the battery system voltage needs to be set, the MX60 automatically senses the nominal PV array voltage and finds the maximum power point during operation.

Setting the nominal battery system voltage will require entering an access code to access the change screens. The following access code is required for this unit: **141**

Use the following procedure to change parameters:

1. Battery switched off
2. Hold down push buttons #1 and #3. (Left to right buttons are: #1 #2 #3 #4)
3. Turn battery switch on while holding buttons #1 and #3 down.
4. Release buttons as soon as "OutBack Power Systems" appears on the LCD screen.
5. You will see the message " MX60 has been reset / pick a configuration"
6. It will ask what mode to run. Push button #1 (MPPT) then push "NEXT".
7. You will now be at the password screen. Push "DOWN" until the number reaches your access code. Press the button below the word "ENTER".
8. Hit the button below "NEXT" to select the nominal battery voltage, then press "ENTER". The MX60 will ask "ARE YOU SURE?". When you push the "YES" button, the unit will reset and then displays the **Main Status Screen**.

To reset these parameters to the factory defaults, repeat steps 1 through 4 above. The actual Absorb and Float voltages will be modified automatically with the use of the external temperature sensor. You can view the compensated voltages in **Miscellaneous Screen No 3**. The amount of compensation the temp sensor provides is 30 millivolts per degree Celsius for a 12 volt system. This compensation is multiplied by 2 for a 24 volt system, etc.

Charger Parameters The charger parameters that are automatically adjusted when the nominal battery system voltage is set can be modified. The default ABSORB Volts and FLOAT Volts setpoints are based on average lead acid battery systems. The default charger current limit is 60 Amps. If the manufacturer of the batteries you are using recommends different ABSORB Volts and FLOAT Volts setpoints you can change the default setpoints using the **Charger Set-Up Screen** shown in Figure 7. If your system requires current limiting other than 60 Amps due to breaker or wire rating you can change the current limit setpoint using this screen.

Enter the **Charger Set-Up Screen** from the **Main Status Screen** (Figure 6) by pushing button #1 (Button under KWh). Pressing "NEXT" selects which parameter you are going to increase or decrease. The one that is presently selected will have a * in front of it. You may need to re-enter your access code for this set-up screen.

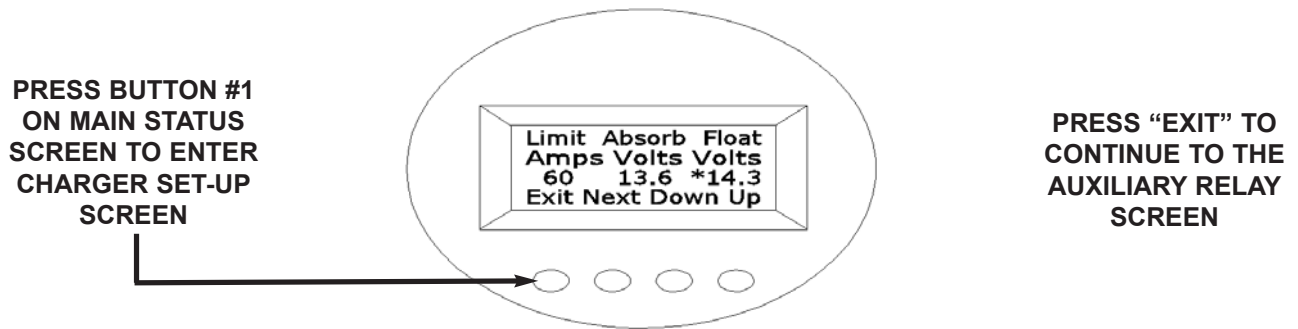

Figure 7 Charger Set-up Screen

Auxiliary Output The user can set the function for this secondary control circuit. Pressing "NEXT" selects which parameter you are going to increase or decrease. The choices are: Manual, Disabled, Diversion, Low Battery Disconnect, and External. The terminal marked "Aux" supplies a 12 VDC at 200 milliamp max output. This output can be used to power the coil of a contactor or relay. It can also directly drive a small piezo buzzer or a small 12V LED indicator.

Manual Mode: You can turn on and off the AUX output manually from the MX60 keypad.

Disabled: The AUX output terminals have no output.

Diversion Mode: Used when a wind or hydro generator is connected directly to the batteries and excess power needs to be diverted when the battery is full. This mode can also be used to turn on a fan for battery box ventilation. The AUX output terminal will become active (produce 12VDC) when the battery voltage reaches ABSORB or FLOAT voltage minus an adjustable value. The value is adjustable in tenths of a volt from 0.1 to 5.0 volts. There is a fixed minimum time period of 15 seconds for the AUX output terminals to be energized.

Low Battery Disconnect Mode / Load Management Power Shedding: The Aux output terminals are energize when the battery voltage drops below a low battery set point for a time delay period. The time period is adjustable from 0 - 254 minutes.

Remote Control: A MATE can control the operation of the Aux output in the MX controller. Only one MX or FX device's Aux control output can be controlled by the MATE.

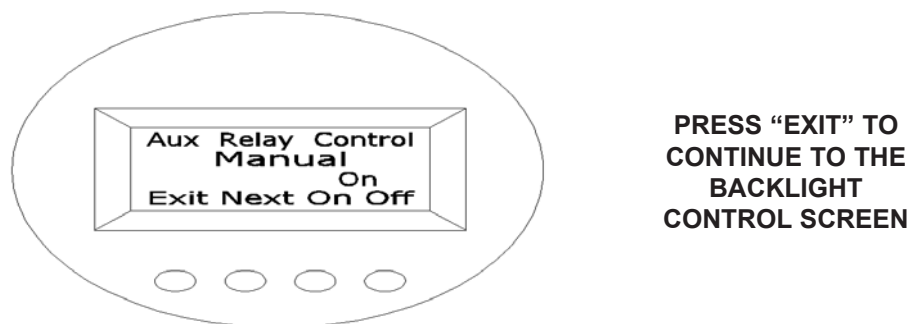
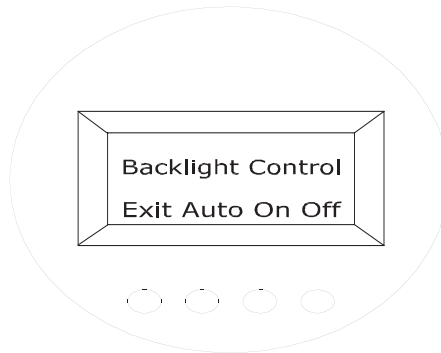

Figure 8 Auxiliary Output Set-up Screen

Backlight Control: The back lighting of the LCD screen and the buttons consumes about ¼ watt. The user can control backlight options using the setup screen shown in Figure 9. Depending on your energy production, you may elect to leave the lighting off or on. There is also a third option called Auto. Tapping any key quickly while in Auto mode will turn the lights on for 30 seconds. This first key tap to turn on the backlight will not change any of the settings.



**PRESS "EXIT" TO
CONTINUE TO THE
BATTERY
EQUALIZATION
VOLTAGE SET-UP
SCREEN**

Figure 9 Backlight Control Set-up Screen

Battery Equalization: Flooded electrolyte batteries should occasionally be subjected to an equalization process to convert sulfation from the lead plates. This process can be dangerous, so make sure you understand it completely before equalizing your batteries! The default EQ setting are: equalize voltage set to absorb volts and equalize time set to one hour. The screens shown in Figures 10 through 12 allows the user to change the equalization voltage and process.

NOTE: VALVE REGULATED LEAD ACID (VLRA) OR SEALED BATTERIES SHOULD NEVER BE EQUALIZED UNLESS SPECIFICALLY RECOMMENDED BY THE MANUFACTURER.

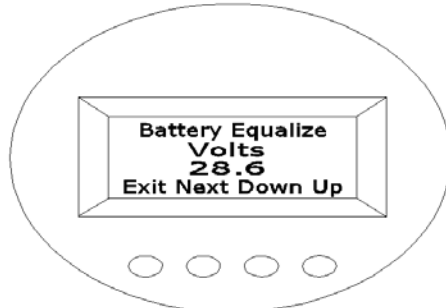

**PRESS "NEXT" TO
CONTINUE TO THE
BATTERY
EQUALIZATION
TIME SET-UP
SCREEN**

Figure 10 Battery Equalization Voltage Set-up Screen

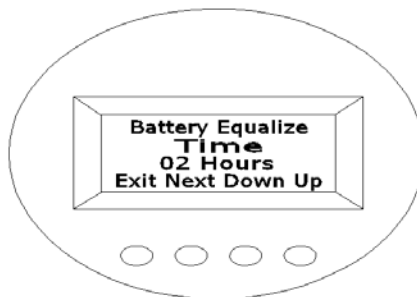

**PRESS "NEXT" TO
CONTINUE TO THE
BATTERY
EQUALIZATION
START SCREEN**

Figure 11 Battery Equalization Time Set-up Screen

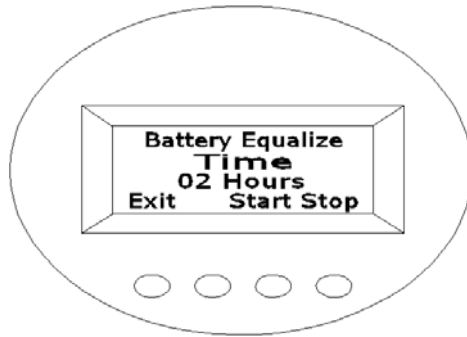

Figure 12 Battery Equalization Start Screen

USER CONFIGURATION COMPLETE

PRESS "STOP" TO RETURN TO THE MAIN STATUS SCREEN

OR

PRESS "EXIT" TO CONTINUE TO THE MISCELLANEOUS SCREEN NO. 1

The Battery equalization process must be started manually. The screen shown in Figure 12 is used to start the equalization process. The EQ process is automatically terminated once the EQ time period has occurred. Pressing "Stop" will over-ride the timed EQ charge.

Miscellaneous Screens: The screens shown in Figures 13, 14 and 15 are primarily for engineers, technicians, and customer service personnel who need to access technical information. The following is a brief description of the contents of these screens:

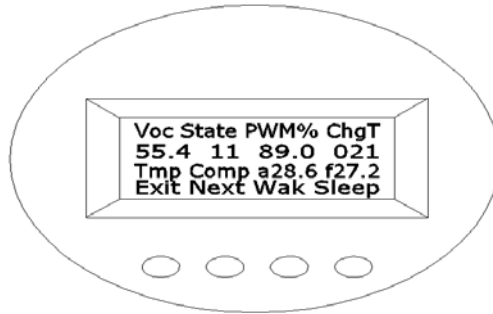
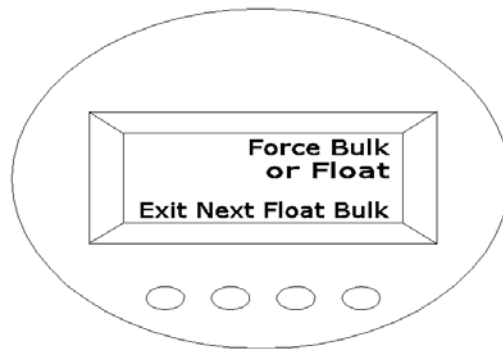

Figure 13 Miscellaneous Screen 1

PRESS "NEXT" TO CONTINUE TO THE MISCELLANEOUS SCREEN NO. 2

- Voc: This is the open circuit voltage of the PV panels measured at the last wakeup cycle.
- State: The MX60 has thousands of lines of code. Each operation is called a State. This number is useful for troubleshooting.
- PWM%: This is the duty cycle of the buck converter.
- ChgT: This is the minute counter for the Absorption and EQ cycle. It counts up from zero (000) while in the Bulk cycle and then counts down from a maximum of 120 minutes in the Absorption cycle. This allows the MX60 to enter the Float stage sooner when the controller starts the charging process with a full battery. It is not used.
- Temp Comp: Battery temperature compensated absorb and float setpoints. The setpoints will rise when the battery is cold and will be lowered when the battery is hot.
- Wak: Allows manual startup of the MX60 after it has entered the snoozing stage.
- Rstrt: Forces the MX60 to restart from sleep mode or to re-establish the maximum power point of the PV array.



**PRESS "NEXT" TO
CONTINUE TO THE
MISCELLANEOUS
SCREEN NO. 3**

Figure 14 Miscellaneous Screen 2

Force Bulk or Float: Pushing the button under FLOAT or BULK will force the charger into that charge state.

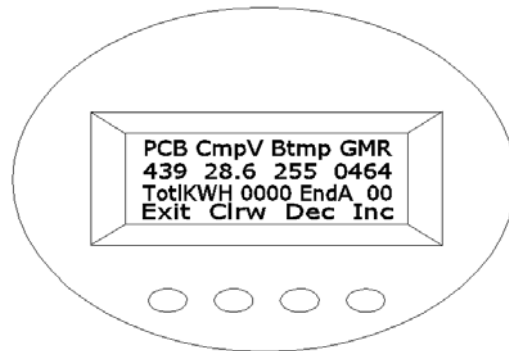

**PRESS "EXIT" TO
RETURN TO THE
MAIN STATUS SCREEN**

Figure 15 Miscellaneous Screen 3

- PCB:** Temperature measurement value used to control the cooling fan's operation and overtemperature protection. The temperature measurement is not the actual internal temperature but as a reference value.
- CmpV:** Compensated voltage that the controller is using as a target for voltage regulation.
- Btmp:** Battery temperature sensor reference value used to compensate the charging process. This is an arbitrary between 0 and 255 and is not the actual temperature.
- GMR:** Output value of the current sensor used to calculate output amps, watts, and track the PV array.
- Totlkwh:** Total kW hours accumulated every night from daily KWh. Pressing and holding "Clrw" for 3 seconds clears this value. The daily KWH are added to the counter at the end of each day.
- EndA:** Normally an absorb charge cycle is timed. Decreasing (Dec) or increasing (Inc) sets the optional end current level in Amps. While the controller is regulating the charging process in the absorption stage and the end current level is reached before the charge timer has reached zero (ChgT in Figure 13), the MX60 will switch to float charge mode. This is an optional setpoint and is not required to be adjusted in most installations.

Specifications:

Output Current Rating:	60 Amps
Nominal Battery Voltage:	12, 24, 36, 48 or 60VDC (programmable)
PV open circuit voltage:	120VDC Maximum
Standby power consumption:	Less than 1 watt typical
Charging regulation methods:	Five stage: Bulk, Absorption, Float, Silent, Equalization
Voltage regulation setpoints:	13-80VDC
Equalization Voltage:	Adjustable 1.0 to 5.0VDC above Bulk setpoint
Temperature compensation:	With optional sensor 5millivolts per degree C per 2V cell
Voltage step down capability:	Can down-convert from any PV array voltage within PV VOC limits of 120V to battery system voltage. Examples: 48V array to 24V ; 60V array to 48V
any	
Digital Display:	4 line 20 character backlit LCD display
Remote Interface:	RJ45 modular connector Cat 5 cable 8 wire
Operating Temperature Range:	-40° to 60° C derated above 25° C
Environmental Rating:	Indoor type 1
Conduit knockouts:	Two 1/2-3/4" on the back; one 3/4-1" on each side; two 3/4-1" on the bottom
Warranty:	Two years parts and labor, optional extended warranty available
Dimensions:	Unit: 14.5"H x 5.75"W x 5.75"D Boxed: 17.8"H x 10W x 7"D
Weight:	Unit 12 pounds Boxed 15 pounds

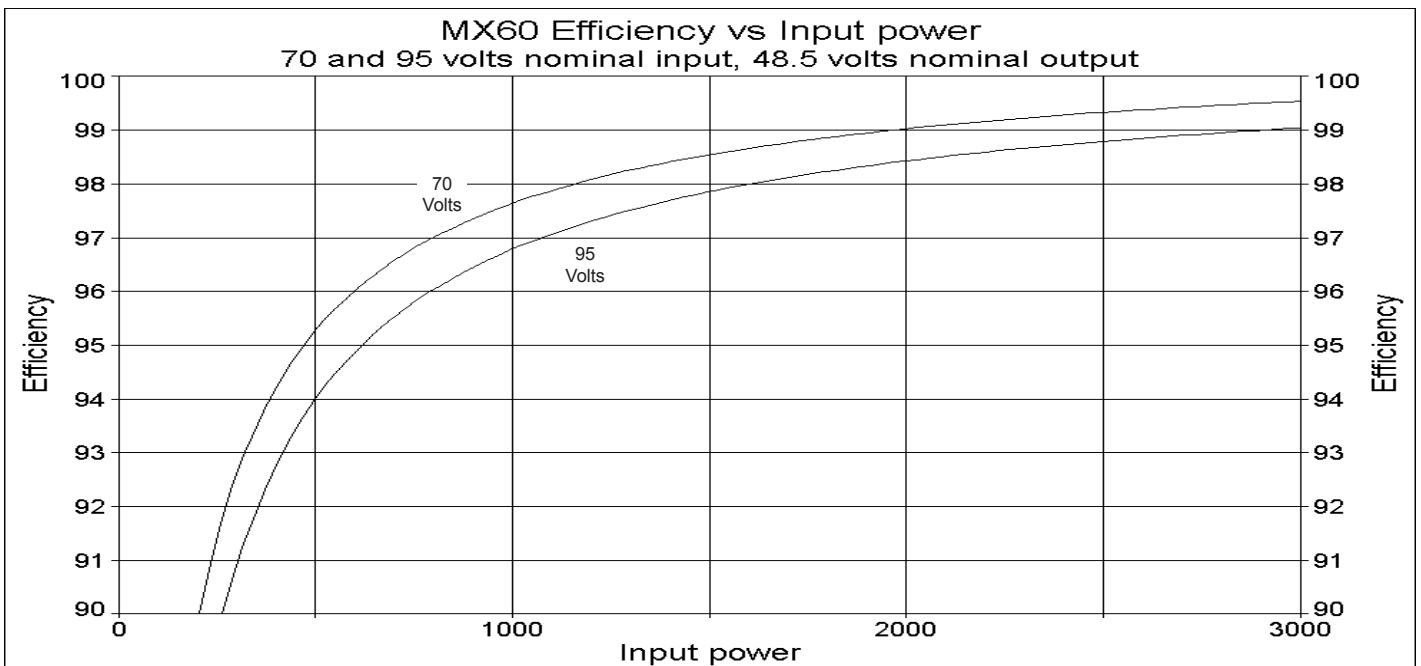
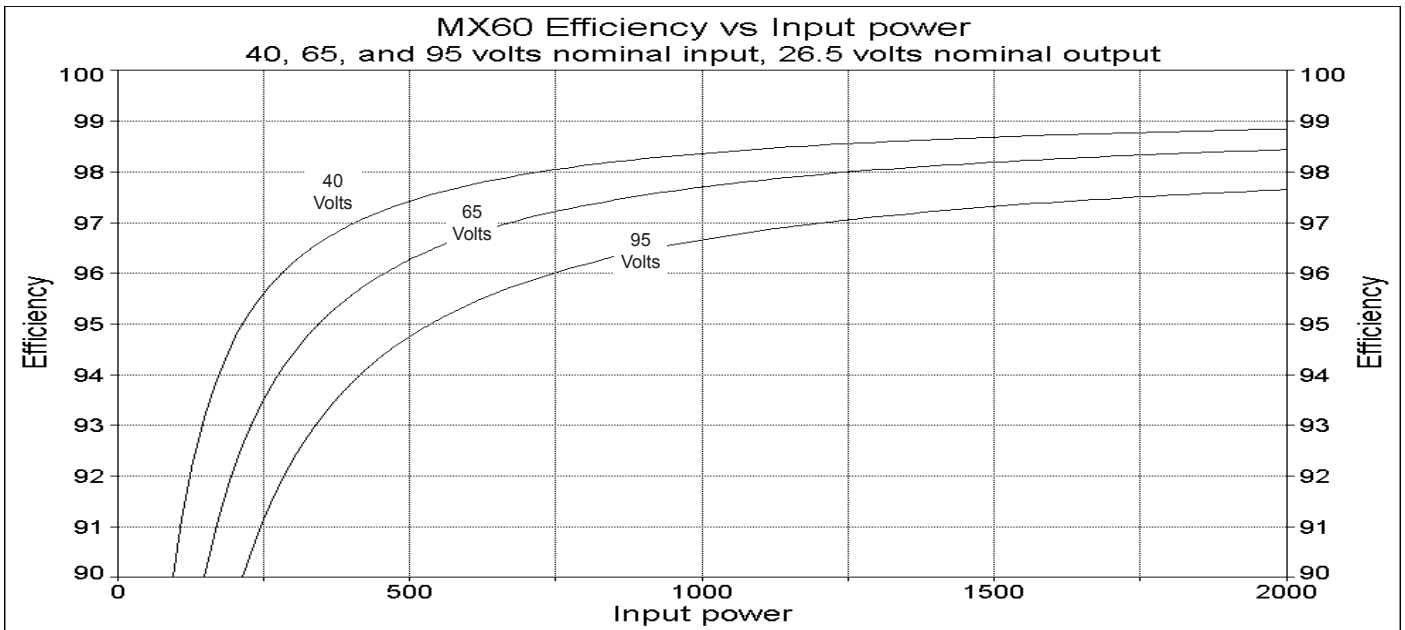

OutBack Power Systems Two Year Limited Warranty

OutBack Power Systems Inc. warrants that the products it manufactures will be free from defects in materials and workmanship for a period of two (2) years subject to the conditions set forth below.

The limited warranty is extended to the original user and is transferable. The limited warranty term begins on the date of invoice to the original user of the product. The limited warranty does not apply to any product or part thereof damaged by a) alteration or disassembly, b) accident or abuse, c) corrosion, d) lightning, e) reverse polarity, f) repair or service provided by an unauthorized repair facility, g) operation or installation contrary to instructions pertaining to the product. OutBack Power Systems' liability for any defective product or any part thereof shall be limited to the repair or replacement of the product, at OutBack Power Systems' discretion. OutBack Power Systems does not warrant or guarantee the workmanship performed by any person or firm installing its products.

THIS LIMITED WARRANTY GIVES YOU SPECIFIC LEGAL RIGHTS, AND YOU MAY ALSO HAVE OTHER RIGHTS THAT VARY FROM STATE TO STATE (OR JURISDICTION TO JURISDICTION). OUTBACK POWER SYSTEMS' RESPONSIBILITY FOR MALFUNCTIONS AND DEFECTS IN HARDWARE IS LIMITED TO REPAIR AND REPLACEMENT AS SET FORTH IN THIS LIMITED WARRANTY STATEMENT. ALL EXPRESS AND IMPLIED WARRANTIES FOR THE PRODUCT, INCLUDING BUT NOT LIMITED TO ANY IMPLIED WARRANTIES OF AND CONDITIONS OF MERCHANTABILITY AND FITNESS FOR A PARTICULAR PURPOSE, ARE LIMITED IN DURATION TO THE LIMITED WARRANTY PERIOD SET FORTH ABOVE AND NO WARRANTIES, WHETHER EXPRESS OR IMPLIED, WILL APPLY AFTER SUCH PERIOD. SOME STATES (OR JURISDICTIONS) DO NOT ALLOW LIMITATIONS ON HOW LONG AN IMPLIED WARRANTY LASTS, SO THE ABOVE LIMITATION MAY NOT APPLY TO YOU.

OUTBACK POWER SYSTEMS DOES NOT ACCEPT LIABILITY BEYOND THE REMEDIES SET FORTH IN THIS LIMITED WARRANTY STATEMENT OR LIABILITY FOR INCIDENTAL OR CONSEQUENTIAL DAMAGES, INCLUDING WITHOUT LIMITATION ANY LIABILITY FOR PRODUCTS NOT BEING AVAILABLE FOR USE. SOME STATES (OR JURISDICTIONS) DO NOT ALLOW THE EXCLUSION OR LIMITATION OF INCIDENTAL OR CONSEQUENTIAL DAMAGES, SO THE ABOVE EXCLUSION OR LIMITATION MAY NOT APPLY TO YOU.

During the two year period beginning on the invoice date, OutBack Power Systems will repair or replace products covered under this limited warranty that are returned to OutBack Power Systems' facility or to an OutBack Power Systems authorized repair facility, or that are repaired on site by an OutBack Power Systems authorized repair technician. To request limited warranty service, you must contact OutBack Power Systems at 360-435-6030 within the limited warranty period. If limited warranty service is required, OutBack Power Systems will issue a Return Material Authorization (RMA) Number. Mark the outside of the package with the RMA number and include a copy of the purchase invoice in the package. You must ship the products back to OutBack Power Systems in their original or equivalent packaging, prepay shipping charges, and insure the shipment or accept the risk of loss or damage during shipment. OutBack Power Systems will ship the repaired or replacement products to you freight prepaid if you use an address in the continental United States, where applicable. Shipments to other locations will be made freight collect.

REGISTER YOUR PRODUCTS

Your purchase of an OutBack Power Systems product is an important investment. Registering your products will help us maintain the standard of excellence you expect from us in terms of performance, quality and reliability.

Please take a moment to register and provide us with some important information.

Name: _____
 Address: _____
 City, State, Zip Code: _____
 Country: _____
 Telephone Number: _____
 E-mail: _____

Sold by: _____
 Installer: _____
 Purchase Date: _____

Model Number: MX60 _____
 Serial Number: _____

Check all that apply:

- Off-Grid Installation
- Grid-Tie Installation
- Residential Installation
- Commercial Installation

This registration form can be removed from the MX60 Manual, folded, and mailed using the address on the reverse side.

EXTENDED WARRANTY APPLICATION

OutBack Power Systems offers an optional three year extension to the standard two year limited warranty. Purchase of extended warranty coverage is available on products listed below provided conditions shown are met. Extended warranty coverage must be purchased within 90 days of the original sale of the product covered.

PRODUCT	REQUIRED SURGE PROTECTION	EXTENDED WARRANTY COST
FX2024	AC Input; AC Output, DC Input	\$300.00
FX2048	AC Input; AC Output, DC Input	\$300.00
MX60	DC Input; DC Output	\$100.00
MATE	NA	\$50.00
HUB 4	NA	\$35.00
HUB 10	NA	\$50.00

Products Covered	Serial Number	Extended Warranty Cost

Total

Send check or money order payable to OutBack Power Systems. Include a completed copy of this application and send to:

OutBack Power Systems
Extended Warranty Program
 19009 62nd Ave NE
 Arlington WA 98223 USA

FROM

Postage
Required

**OutBack Power Systems, Inc
19009 62nd Ave NE
Arlington WA 98223**