



## CARE AND OPERATION INSTRUCTIONS

### DIRECT VENT SLDVT-35/40 SERIES

DIRECT-VENT GAS FIREPLACE HEATERS

P/N 506010-01 REV. N/C 08/2008


#### MODELS

##### Millivolt Models

SLDVT-35NM  
SLDVT-35PM  
SLDVT-40NM  
SLDVT-40PM


##### Electronic Models

SLDVT-35NE  
SLDVT-40NE



**! WARNINGS**

- **Hot! Do not touch!** The glass and surfaces of this appliance will be hot during operation and will retain heat for a while after shutting off the appliance. Severe burns may result.
- **Carefully supervise children** in the same room as appliance.



- **If small children are present in the home, it is recommended that this appliance be fitted with a screen door or screen panel kit. See Pages 13 & 14 for ordering information.**

**WARNING: IF THE INFORMATION IN THIS MANUAL IS NOT FOLLOWED EXACTLY, A FIRE OR EXPLOSION MAY RESULT CAUSING PROPERTY DAMAGE, PERSONAL INJURY OR LOSS OF LIFE.**

Do not store or use gasoline or other flammable vapors or liquids in the vicinity of this or any other appliance.

#### WHAT TO DO IF YOU SMELL GAS:

- Do not light any appliance.
- Do not touch any electrical switch; do not use any phone in your building.
- Immediately call your gas supplier from a neighbor's phone. Follow your gas supplier's instructions.
- If your gas supplier cannot be reached, call the fire department.

Installation and service must be performed by a qualified installer, service agency or the gas supplier.

Tested & Listed By



Portland Oregon USA

OTL Report No. 116-F-50-5

OMNI-Test Laboratories, Inc.

A French manual is available upon request. Order P/N 506010-01CF

Ce manuel d'installation est disponible en français, simplement en faire la demande. Numéro de la pièce 506010-01CF

**INSTALLER:** Leave this manual with the appliance.  
**CONSUMER:** Retain this manual for future reference.

**AVERTISSEMENT: ASSUREZ-VOUS DE BIEN SUIVRE LES INSTRUCTIONS DONNÉ DANS CETTE NOTICE POUR RÉDUIRE AU MINIMUM LE RISQUE D'INCENDIE OU POUR ÉVITER TOUT DOMMAGE MATÉRIEL, TOUTE BLESSURE OU LA MORT.**

**POUR VOTRE SÉCURITÉ:** Ne pas entreposer ni utiliser d'essence ni d'autre vapeurs ou liquides inflammables dans le voisinage de cet appareil ou de tout autre appareil.

**POUR VOTRE SÉCURITÉ:** Que faire si vous sentez une odeur de gaz:

- Ne pas tenter d'allumer d'appareil.
- Ne touchez à aucun interrupteur. Ne pas vous servir des téléphones se trouvant dans le bâtiment où vous vous trouvez.
- Evacuez la pièce, le bâtiment ou la zone.
- Appelez immédiatement votre fournisseur de gaz depuis un voisin. Suivez les instructions du fournisseur.
- Si vous ne pouvez rejoindre le fournisseur de gaz, appelez le service des incendies.

L'installation et service doit être exécuté par un qualifié installateur, agence de service ou le fournisseur de gaz.

## CONGRATULATIONS!

In selecting this LENNOX Direct-Vent Gas Appliance you have chosen the finest and most dependable fireplace to be found anywhere. Its a beautiful, prestigious alternative to a wood burning fireplace. Welcome to a Family of tens of thousands of satisfied LENNOX Fireplace Owners.

Please carefully read and follow all of the instructions found in this manual. Please pay special attention to the safety instructions provided in this manual. The Care and Operation Instructions included here will assure that you have many years of dependable and enjoyable service from your LENNOX product.

## TABLE OF CONTENTS

Introduction .....	Page 2
General Information .....	Page 2
Gas Controls Access .....	Page 3
Operation/Care of Your Appliance .....	Page 3
Variable Flame Adjustment.....	Page 4
Maintenance.....	Page 5
Front Glass Enclosure Panel, Removal and Installation.....	Page 6
Install Volcanic Stone, Embers & Logs .....	Page 7
Burner Flame Appearance & Sooting	Page 10
Burner Flame Adjustments.....	Page 10
Millivolt Appliance Checkout .....	Page 11
Electronic Appliance Checkout .....	Page 11
Product Reference Information .....	Page 11
Warranty .....	Page 11
Wiring Diagrams .....	Page 12
Accessory Components .....	Page 13
Lighting Instructions – Millivolt .....	Page 16
Lighting Instructions – Electronic .....	Page 18
Maintenance Schedule .....	Page 20
Troubleshooting Guide – Millivolt.....	Page 21
Troubleshooting Guide – Electronic .....	Page 22
Replacement Parts List .....	Page 23

This manual is part of a set of two supporting this product. Refer to manual 506009-01 for Installation Instructions.

## INTRODUCTION

The Fireplace models covered in this manual are Direct-Vent sealed combustion gas fireplace heaters designed for residential application. Direct-Vent appliances operate with the combustion chamber completely isolated from the indoor environment.

All air for combustion is brought in from the outside and exhaust gases are vented through the same direct vent, co-axial (intake/exhaust) vent system.

The Millivolt appliances have a millivolt gas control valve with piezo ignition system provides safe, efficient operation. If any optional accessories which require electrical power are being installed, the electrical power must be provided at the time of appliance installation.

The Electronic appliances have a battery backed up electronic intermittent pilot system that provides safe, efficient operation. No external electrical power is required to operate these appliances.

These appliances comply with National Safety Standards and are tested and listed by Omni-Test Laboratories (Report No. 116-F-50-5) to ANSI Z221.88 (in Canada, CSA-2.33), and CAN/CGA-2.17-M91 in both USA and Canada, as vented gas fireplace heaters.

The Installation must conform to local codes or, in the absence of local codes, with the National Fuel Gas Code, ANSI Z223.1/NFPA 54-latest edition, or the Natural Gas and Propane Installation Code, CSA B149.1-latest edition. The appliance, when installed, must be electrically grounded in accordance with local codes or, in the absence of local codes, the latest edition of the National Electrical Code, ANSI/NFPA 70, or the Canadian Electrical Code, CSA C22.1 - latest editions.

## GENERAL INFORMATION

**Note:** Installation and repair should be performed by a qualified service person. The appliance should be inspected annually by a qualified professional service technician. More frequent inspections and cleanings may be required due to excessive lint from carpeting, bedding material, etc.

*It is imperative that the control compartment, burners and circulating air passage ways of appliance be kept clean. See Maintenance instructions on Page 5.*

*S'assurer que le brûleur et le compartiment des commandes sont propres. Voir les instructions d'installation et d'utilisation qui accompagnent l'appareil.*

Provide adequate clearances around air openings and adequate accessibility clearance for service and proper operation. Never obstruct the front openings of the appliance.

Due to high temperatures the appliance should be located out of traffic and away from furniture and draperies. Locate furniture and window coverings accordingly.

These fireplaces are designed as supplemental heaters. Therefore, it is advisable to have an alternate heat source when installed in a dwelling.

**These appliances are designed to operate on natural gas or propane gas only. The use of other fuels or combination of fuels will degrade the performance of this system and may be dangerous.**

### Millivolt Models - BTU Input

Millivolt models come standard with the manually-modulated gas valve; flame appearance and heat output can be controlled at the gas valve. The BTU Input for millivolt models is shown in **Tables 1 & 2**.

Input (BTU) Manually-Modulated Gas Valves (millivolt models)	
NATURAL GAS	
Models	Input Rate (BTU / HR)
SLDVT-35NM	*16,000 high 12,750 low
SLDVT-40NM	*20,000 high 15,500 low
<b>Table 1</b> * Electronic Models Fixed	

Input (BTU) Manually-Modulated Gas Valves (millivolt models)	
PROPANE GAS	
Models	Input Rate (BTU / HR)
SLDVT-35PM	*15,000 high 11,400 low
SLDVT-40PM	*18,000 high 14,000 low
<b>Table 2</b> * Electronic Models Fixed	

### Gas Pressure -

**Tables 3, 4 and 5** show the appliances' gas pressure requirements.

Inlet Gas Supply Pressure (all models)		
Fuel #	Minimum	Maximum
Natural Gas	4.5" WC (1.24 kPa)	10.5" WC (2.61 kPa)
Propane	11.0" WC (2.74 kPa)	13.0" WC (3.23 kPa)
<b>Table 3</b>		

Manifold Gas Supply Pressure (millivolt models)		
Fuel #	Low	High
Natural Gas	(Lo) 2.2" WC (0.55 kPa)	(Hi) 3.5" WC (0.87 kPa)
Propane	(Lo) 6.3" WC (1.57 kPa)	(Hi) 10.0" WC (2.49 kPa)

**Table 4**

Manifold Gas Supply Pressure (electronic models)		
Fuel #	Low	High
Natural Gas	(Lo) 2.2" WC (0.55 kPa)	(Hi) 3.5" WC (0.87 kPa)
Propane	(Lo) 6.3" WC (1.57 kPa)	(Hi) 10.0" WC (2.49 kPa)

**Table 5**

Burner Orifice Sizes Elevation 0-4500 feet (0-1372 meters)		
Model Series	Nat. Gas drill size (inches)	Propane drill size (inches)
SLDVT-35	#49 (0.0730") * 21L82 •	0.045" * 75L10 •
SLDVT-40	#44 (0.0860") * 60J80 •	0.048" * 99K78 •

**Table 6** \* Standard size installed at factory  
• Part/Cat. Number

Test gauge connections are provided on the front of the millivolt gas control valve, identified IN for the inlet and OUT for the manifold side (see **Figure 3** on **Page 4**). A 1/8" NPT Test gauge connection is provided at the inlet and outlet (manifold) ports on the electronic gas control valve (see **Figure 4** on **Page 4**).

These appliances must be isolated from the gas supply piping system (*by closing their individual manual shut-off valve*) during any pressure testing of the gas supply piping system at test pressures equal to or **less than** 1/2 psig (3.5 kPa).

These appliances and their individual shut-off valves *must be disconnected* from the gas supply piping system during any pressure testing of that system at pressures **greater than** 1/2 psig (3.5 kPa).

### Orifice Sizes - Sea Level to High Altitude

**(All Models):** These appliances are tested and approved for installations at elevations of 0-4500 feet (0-1372 meters) above sea level using the standard burner orifice sizes (marked with an "\*" in **Table 7**).

At the time of installation, it must be determined if the appliance needs to be derated. Contact your local gas supplier for deration requirements for your area.

**Deration** - At higher elevations, the amount of BTU fuel value delivered must be reduced by either using gas that has been derated by the gas company or by changing the burner orifice to a smaller size as regulated by the local authorities having jurisdiction and by the (USA) National Fuel Gas Code NFPA 54/ANSI Z223.1 - latest edition or, in Canada, the CAN1-B149.1 and .2 codes - latest edition.

### Burn-in Period

During the first few fires of this appliance there will be some odor due to the curing of the paint and burning off of lubricants used in the manufacturing process.

Depending on your use, the burn-in period may take a few hours or a few days.

**KEEP YOUR HOUSE WELL VENTILATED DURING THE CURING PROCESS. THE ODOR AND HAZE EMITTED DURING THE CURING PROCESS CAN BE QUITE NOTICEABLE AND MAY SET OFF A SMOKE DETECTOR.**

If an optional blower is installed, Do Not turn it on during the Burn-In period.

A white film may develop on the glass front during the first few fires as part of the curing process. The glass should be kept clean during the first two weeks of use to prevent the film from baking on (making it very difficult to remove). See **Cleaning Glass** on **Page 5**.

### Gas Controls/Control Compartment Access

The gas controls can be found behind the control compartment access door.

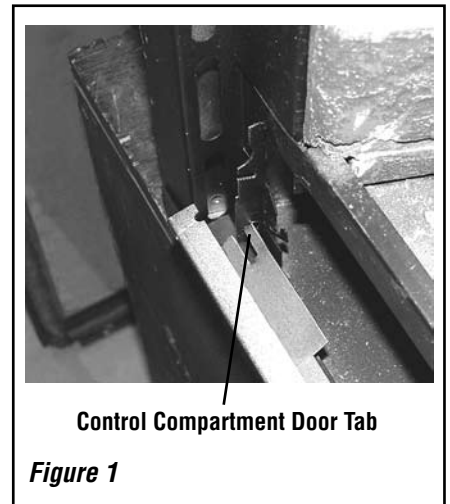
### Removing Control Compartment Door:

Open the panel by gently lifting it upward and forwards. Slide the door, first to one side and then the other, so the tabs clear both of the locating holes.

On millivolt systems, the piezo igniter, HI/LO flame adjustment knob, and pilot and main gas OFF/ON control knob are located below the glass panel enclosure. The gas valve for electronic systems is also located below the glass enclosure panel. See **Figure 1**.

### Reinstalling Control Compartment Door:

To reinstall, insert the tabs on each side of the door into the corresponding holes in the control compartment opening, one side first then the other. To close, pull the door gently up and close by pushing forward and pushing the top edge down into the grooves at the brackets until it locks in place.



**Figure 1**

### OPERATION AND CARE OF YOUR APPLIANCE

The standard controls for appliance operation are located behind the panel below the appliance front glass enclosure panel (see **Figure 1**). Optional control switches are also available (see **Page 13** - *Remote Wall Switch, Remote Control or Wall Thermostat*).

Operation of millivolt and electronic gas control systems are different. Before lighting and operating your appliance determine if you have a millivolt or electronic appliance. Familiarize yourself with the gas control valve that your appliance uses. Refer to **Figure 1** for access to the gas control valve.

**Millivolt Appliances** - Appliances with Millivolt systems will be fitted with the gas control valve shown in **Figure 3**.

**Electronic Appliances** - Appliances with electronic systems will be fitted with the electronic valve shown in **Figure 4**.

**Millivolt Appliances** - To light millivolt appliances refer to **Figure 2**. Detailed lighting instructions are found on **Pages 18 & 19**. **Millivolt appliance lighting instructions may also be found on the pull out lighting instruction labels attached to the gas control valve.**

Once the pilot is lit, the main burner may be turned ON and OFF using wall switch, remote control, optional on unit rocker switch (FRS), or wall thermostat. To operate: Toggle the switch between its ON and OFF positions.

If your millivolt appliance is equipped with an optional remote switch kit (wall switch, remote control, rocker switch, or wall thermostat) and the pilot is lit, the appliance main burner may be turned on and off using the optional switch.

**Note:** To prevent excessive resistance in burner circuit (which can cause burner operation problems), only one burner control switch should be wired to valve.

**Electronic Appliances -**

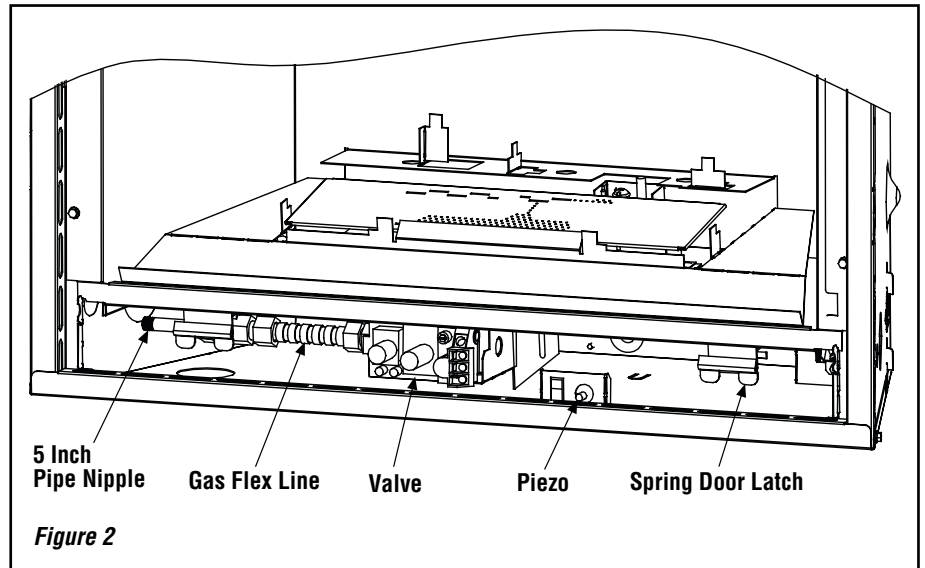
To light electronic appliances refer to the detailed lighting instructions found on **Pages 20 & 21** of these instructions. Electronic appliance lighting instructions may also be found on the pull out lighting instruction labels attached to the gas control valve.

If your electronic appliance is equipped with an optional remote wall switch or remote control kit the appliance main burner may be turned on and off with the wall switch or remote control.

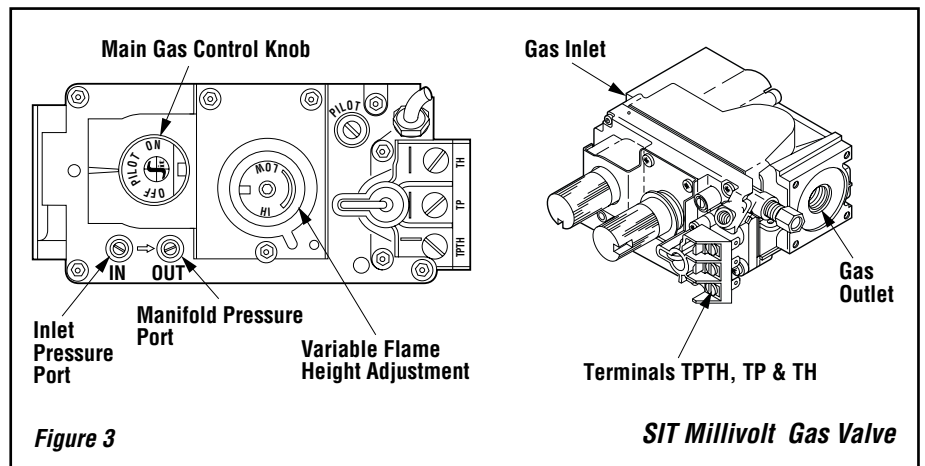
If your electronic appliance is not equipped with a wall switch or remote control, the main burner must be turned off and on with a gas control switch located in some other location by the installer. Contact the installer for directions.

**Variable Flame Height Adjustment**

1. All millivolt appliances are equipped with a variable gas control valve. Flame height for these models may be adjusted through a range between fixed low and high settings while the appliance is in operation. Adjust the flame height as desired after lighting the appliance by rotating the variable adjustment control knob (HI/LO) located on the front of the valve (refer to **Figures 3 & 4**).

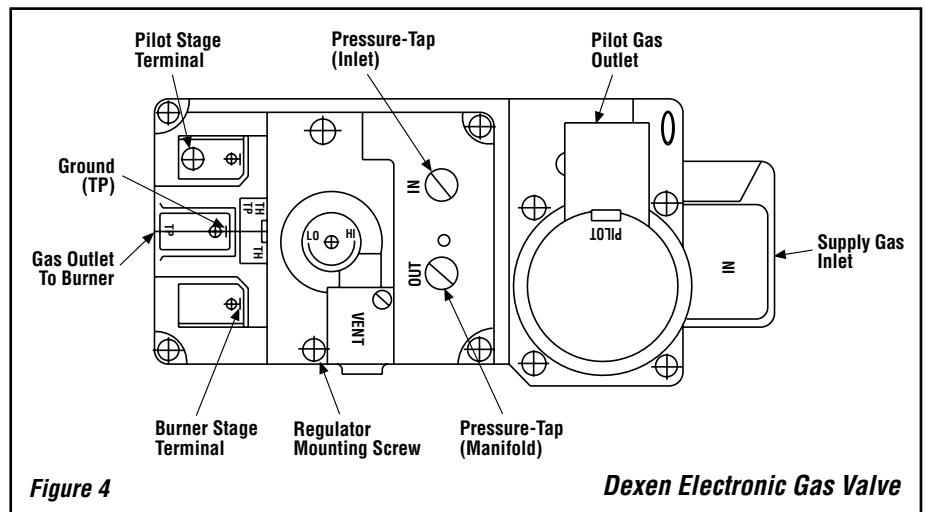


**Figure 2**



**Figure 3**

**SIT Millivolt Gas Valve**



**Figure 4**

**Dexen Electronic Gas Valve**

NOTE: DIAGRAMS & ILLUSTRATIONS ARE NOT TO SCALE.

2. During the first initial burns of these appliances, there will be some odor emitted (see *Burn-In Period* on **Page 3**).
3. Keep the lower control compartment clean by vacuuming or brushing at least twice a year. More frequent cleaning may be required due to excessive lint from carpeting, bedding materials, pet hair, etc. **It is very important that control compartments, burners, circulating air passageways and air venturi on the appliance are NOT obstructed in any way.**
4. Always turn off gas to the pilot (millivolt appliances) and let the appliance cool down before cleaning. Before re-lighting, refer to the lighting instructions in this manual. Lighting instructions may also be found on the pull out lighting instruction labels attached to the gas control valve.
5. Always keep the appliance area clear and free from combustible materials, gasoline and other flammable liquids.
6. Remember, Millivolt appliances have a continuous burning pilot flame. Exercise caution when using products with combustible vapors.

## MAINTENANCE

### (See Maintenance Schedule, Page 22)

Refer to the maintenance schedule for maintenance tasks, procedures, periodicity and by whom they should be performed. Always verify proper operation of the appliance after servicing.

**WARNING: Turn off gas and electrical power before servicing the appliance.**

**CAUTION: Wear gloves and safety Glasses for protection while doing required maintenance.**

**IMPORTANT: Always verify proper operation after servicing.**

**Before re-lighting the fireplace, refer to the lighting instructions in this manual. Instructions are also found on pull-out panels located below the glass door in the control compartment.**

## Inspect Venting System

The appliance and venting system should be thoroughly inspected before initial use and at least annually by a qualified service technician (inspection should include ensuring that exhaust or intake passages are unobstructed and vent components are properly assembled and not damaged).

If the venting system is disassembled for any reason, a qualified service technician should follow vent installation instructions for proper reassembly and proper sealing of the venting system components. However, more frequent periodic inspections and cleanings should be performed by the homeowner.

## Cleaning Glass

(see *Front Glass Enclosure Panel, Removal and Installation* on **Page 6**)

**Note:** Clean glass after first two weeks of operation (after Burn-In period is over) and then only when necessary and when the fireplace is cool. Wipe surface with clean, dampened, soft cloth. Follow with dry, soft towel as desired. Take care not to scratch the glass surface.

The viewing glass should be cleaned periodically to remove any build-up caused from the following:

**IMPORTANT: Do not use abrasive cleaners on glass. Never clean the glass when it is hot.**

- During start-up, it is normal for condensation to form on the inside of the glass (this condensation and fog will usually disappear in a few minutes). The moisture can cause lint, dust and other airborne particles to cling to the glass surface.
- Initial curing of the high temperature paint and burning off of lubricants used in the manufacturing process may result in a film on the glass.
- A white coating may form on the glass as a result of impurities and minerals in the fuel.

It is recommended that the glass be cleaned two or three times during each heating season, depending on the circumstances present. The following cleaning solutions are approved for use to clean glass:

- Non-ammonia based household cleaner
- 50%-50% mix of white vinegar & water
- Gas fireplace/stove glass cleaner

**Inspect Glass Gasket** - Visually inspect the gasket on the backside of the glass enclosure panels. The gasket surface must be clean, free of irregularities and seated firmly.

## Clean Logs And Burner

Carefully remove the logs (use care when handling the fiber logs, as they become quite fragile after curing). Vacuum out any foreign matter (lint, carbon, etc.) on the burner. Ensure the burner ports are "open." Remove any carbon deposits from the under side of the logs using a vacuum cleaner, or a soft bristled brush (i.e. paint brush). Note: Improper positioning of logs can create carbon build-up and will alter the performance of the appliance.

## Replacing Logs -

If the logs become damaged by accident or improper handling and need replacement, use only the proper replacement logs from manufacturer (see **Pages 26 & 27** for ordering information).

**Re-Install Embers and Logs** - Carefully follow placement instructions on **Pages 7 to 9**). All logs should fit onto corresponding pins and/or log stoppers. This will ensure a proper flame and safe combustion.

## Inspect Wiring

Refer to wiring diagrams on **Page 12**.

**WARNING: Label all wires prior to disconnection when servicing controls. Wiring errors can cause improper and dangerous operation. Verify proper operation after servicing.**

Inspect and clean all wire connections. Ensure that there is no melting or damage. Inspection should include:

- Terminals at the Valve
- OFF/ON Switch
- (Optional Control Switch) Wall Thermostat, Remote Control or Remote Wall Switch Kit

## Inspect Burner Flame Appearance

Ensure that the burner flame appearance resembles the flame shown in **Figures 9 & 10** and as described in *Flame Appearance and Sooting* on **Page 10**. The Homeowner must contact a qualified service technician at once if any abnormal condition is observed.

## Small Area Paint Touch-up

The finish of the appliance is a high-quality powdercoat. Only use factory supplied powdercoat paint kit for touch-ups. Paint is available at your local authorized Lennox Hearth Products dealer. Never attempt to paint a hot fireplace.

Do not attempt to repaint the appliance until the finish is completely cured (see *Burn-In Period* on **Page 3**). If the surface later becomes stained or marred, it may be lightly sanded and touched up with spray paint.

## Front Glass Enclosure Panel, Removal and Installation

**WARNING:** Do not operate appliance with the glass front removed, cracked or broken. Replacement of the glass should be done by a licensed or qualified service technician.

**WARNING:** Do not attempt to substitute the materials used on this door, or replace cracked or broken glass with any materials other than those provided by the appliance manufacturer.

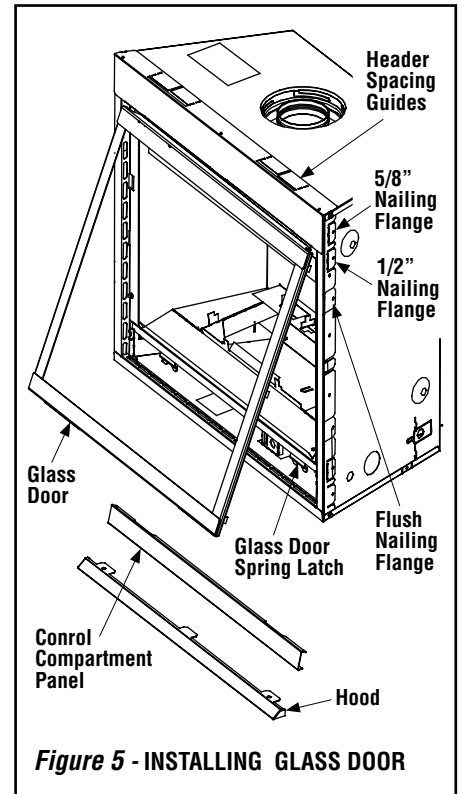
**WARNING:** Handle this glass with extreme care! Tempered glass is susceptible to damage – do not scratch or handle roughly while reinstalling the glass door frame.

**WARNING:** The glass door of this appliance must only be replaced as a complete unit as provided by the manufacturer. Do not attempt to replace broken, cracked or chipped glass separately.

**WARNING:** Do not attempt to touch the front enclosure glass with your hands while the fireplace is in use.

## Removing Glass Enclosure Panels (see *Figure 5*)

1. To access the glass door securing latches, first open the lower control compartment door (*Figure 5*) by lifting and pulling the bottom panel forward.
2. Pull the latches forward and down to release them from the door channel.
3. Pull the bottom of the door out a few inches and grasp it on the right and left. Gently lift to release the door from its channel above the door. Pull the door forward.
4. Retrieve the glass door. Visually inspect the gasket on the backside of the frame. Gasket surface must be clean, free of irregularities and seated firmly.
5. Position the door in front of the firebox opening with the bottom of the door held away from the fireplace (*Figure 5*). Hook the top flange of the door frame over the top of the firebox frame.
6. Let the bottom of the door frame swing gently in towards the fireplace ensuring that the gasket seats evenly as the door frame draws shut. Fasten the two latches located underneath the firebox floor to the door's vee-flange. Close both the latches securely.
7. If desired, install the optional hood. Note the location of the three clips inside the top air channel above the door. The clips are equally spaced on the top surface of the air channel opening. Use a screwdriver to open the clips slightly if needed. Engage the back edge of the eyebrow into the clips to secure.

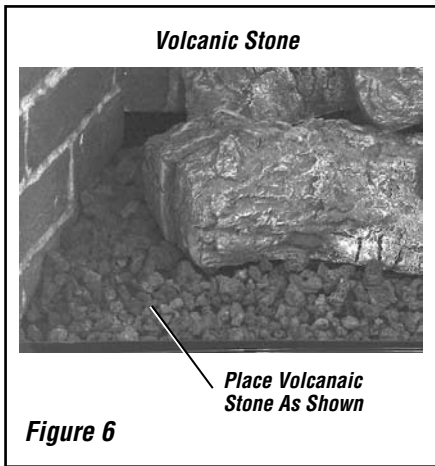


**INSTALL VOLCANIC STONE, GLOWING EMBERS AND LOGS**

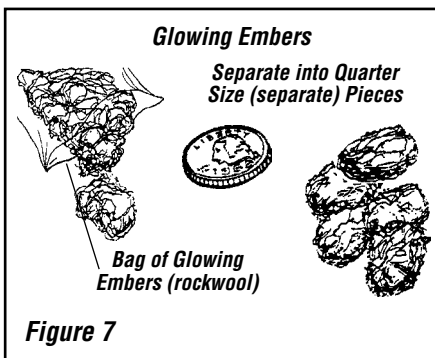
**1. Remove the front glass enclosure panel** (see *Removing Glass Enclosure Panels on Page 6* ).

**2. Remove log set box from firebox.** Next, remove embers and vermiculite from control compartment. **Handle logs carefully to prevent breakage.**

**3. Install decorative volcanic stone** - Sprinkle the decorative volcanic stone in a pleasing pattern (see *Figure 6*). The volcanic stone should be placed directly on top of the firebox bottom, along the slope and to the back at the right and left sides of the burner. Position any ceramic fiber liners before placing the stone. Logs can be positioned after the volcanic stone.



**4. Placement of Glowing Embers** - Separate the Embers (rockwool) into pieces about the size of a quarter (see *Figure 7*). Keep the pieces fluffed up, not matted. Distribute these pieces over the surface of the burner, as shown in *Figures 8 & 9*. Do not use more than is necessary. Ensure that the main burner slots remain uncovered by the ember material. Position the embers on the small holes of the ember bed area.



*Note: This appliance is provided with enough Glowing Embers for several applications, do not use all that is in a new bag at one time. For best glowing effect, replace the ember material annually.*

**5. Placement of Logs** -

All logs that have locating notches or slots to help ensure that they are properly positioned. All top logs that rest on lower logs, do so over notches, indents or nubs. Proper log placement is critical to prevent sooting. Logs should be placed in the gaps between the flame peaks and should be positioned so they do not impinge the flames.

**SLDVT-35 - Install the four logs as Follows**

Carefully position the ceramic fiber logs over the burner as shown in *Figure 8*. Logs should be placed in the order shown and per the following instructions.

1. Place the left front log (1) as shown. Position it on the two left front log brackets.
2. Place the right front log (2) as shown. Position it on the two right front log brackets.
3. Place the left rear log (3) as shown. Position it on the upper and lower left rear log brackets.
4. Place the right rear log (4) as shown. Position it on the right rear log bracket. Note that the hole on the bottom of the right rear log rests over the "Nub" on the right front log.

**SLDVT-40 - Install the four logs as Follows**

Carefully position the ceramic fiber logs and twigs over the burner as shown in *Figure 9*. Logs should be placed in the order shown and per the following instructions.

1. Place the ember chunk (1) over the tab on the rear log support as shown.
2. Place the left front log (2) as shown. Position it on the two left front log brackets.
3. Place the right front log (3) as shown. Position it on the two right front log brackets.
4. Place the left rear log (4) as shown. Position it on the left rear log bracket.
5. Place the right rear log (5) as shown. Position it on the right rear log bracket. Note that the hole on the bottom of the right rear log rests over the "Nub" on the right front log.

**WARNING: DO NOT attempt to install the logs until the appliance installation has been completed, the gas line connected and tested for leaks and the initial burner operation has been checked out.**

**WARNING: The size and position of the log set was engineered to give the appliance a safe, reliable and attractive flame pattern. Any attempt to use a different log set in the fireplace will void the warranty and will result in incomplete combustion, sooting, and poor flame quality.**

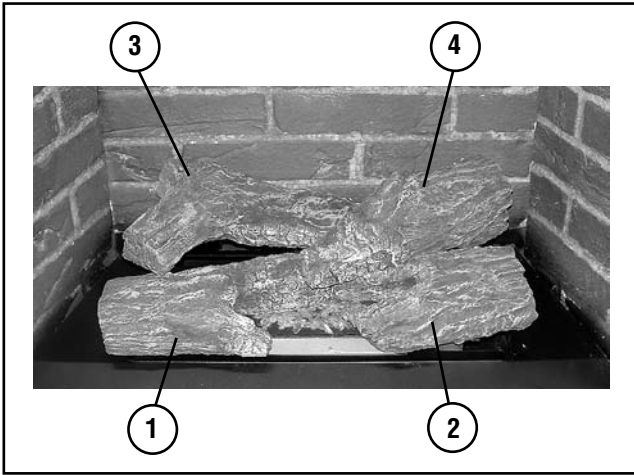
**WARNING: This appliance is not designed to burn wood. Any attempt to do so could cause irreparable damage to appliance and prove hazardous to your safety.**

**WARNINGS: If logs are not installed according to the log installation instructions, flame impingement and improper combustion could occur and result in soot and/or excessive production of carbon monoxide (CO), a colorless, odorless, toxic gas.**

REFERENCE Firebox Accessories / Parts		
Cat. No.	Model No.	Description
88L53	FGE	Bag of Glowing Embers (1 oz. rockwool)
80L42	FDVS	Bag of Decorative Volcanic Stone

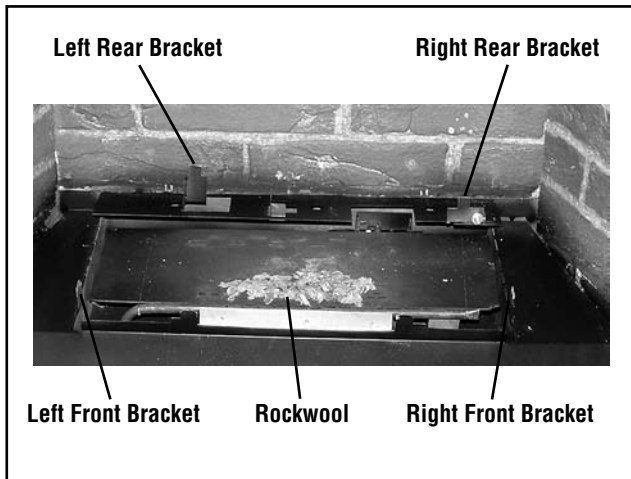
**Table 8**

## SLDVT-35 LOG PLACEMENT

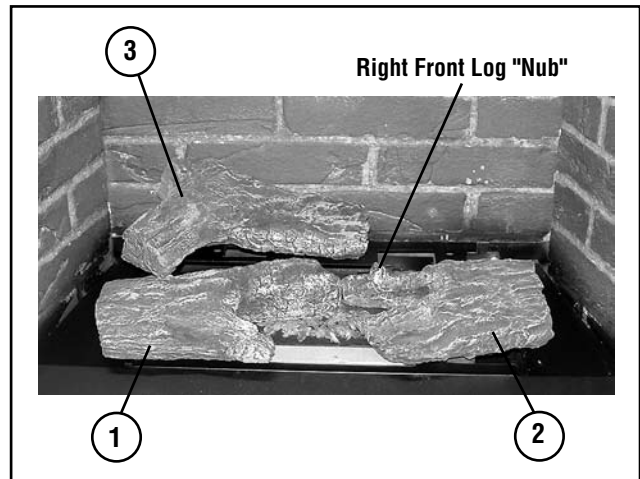


Log Number	Description
1	Left Front Log
2	Right Front Log
3	Left Rear Log
4	Right Rear Log

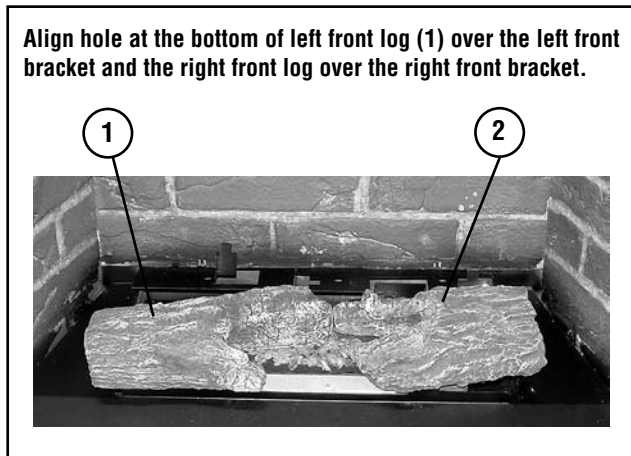
**Catalog Number for the entire log set: H7244**



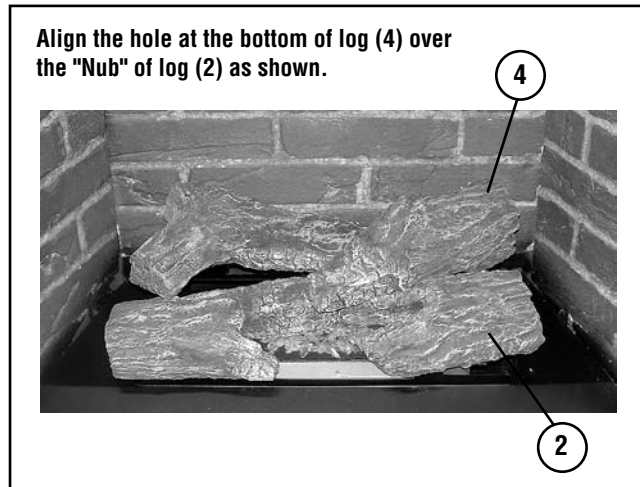
**Step 1**



**Step 3**



**Step 2**

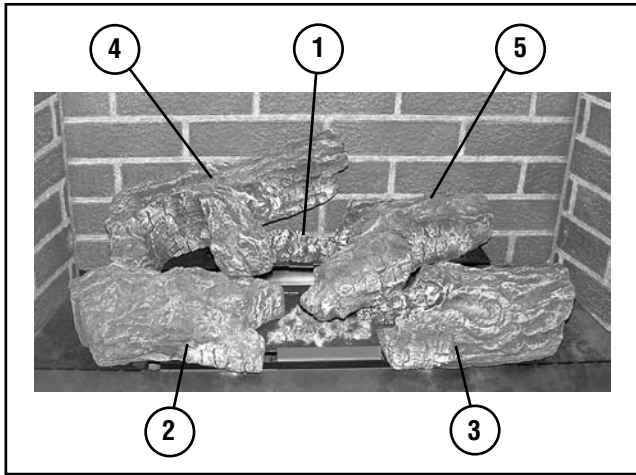


**Step 4**

**Figure 8**

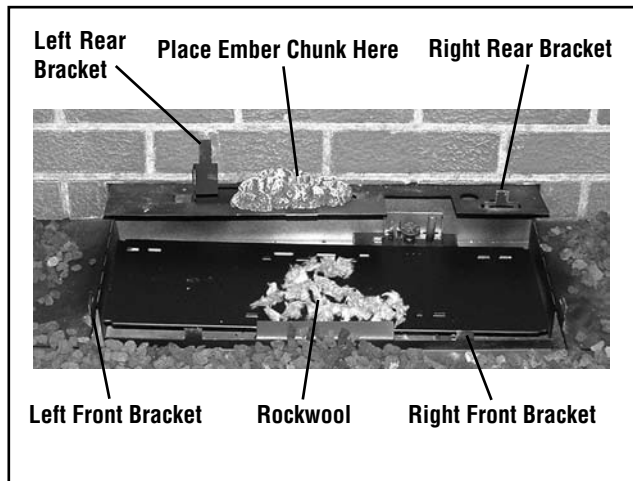


## SLDVT-40 LOG PLACEMENT

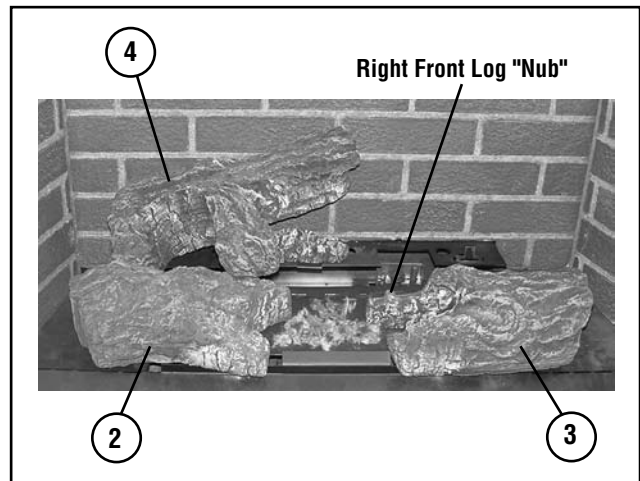


Log Number	Description
1	Ember Chunk
2	Left Front Log
3	Right Front Log
4	Left Rear Log
5	Right Rear Log

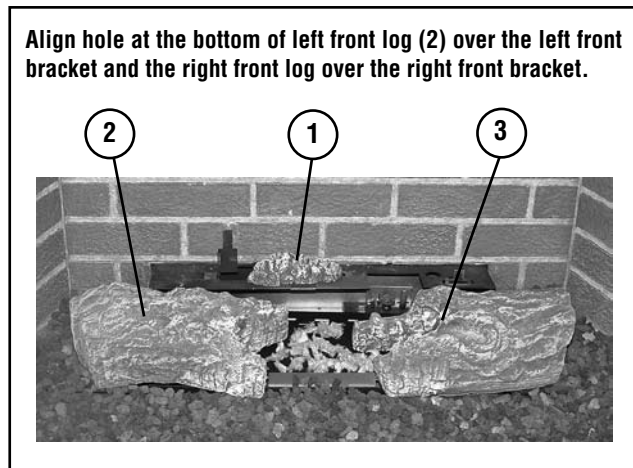
Catalog Number for the entire log set: H7245



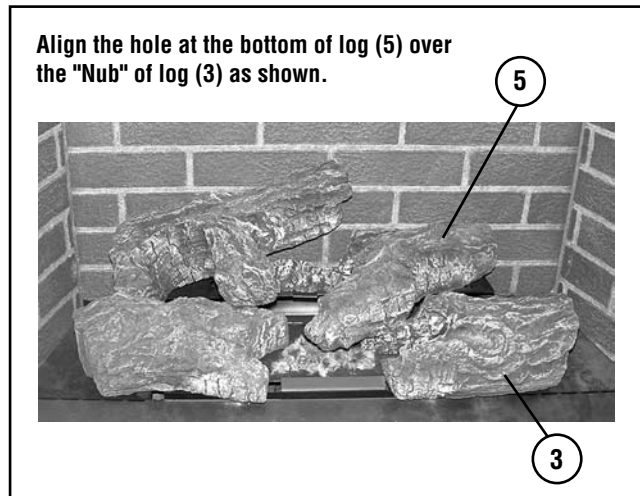
Step 1



Step 3



Step 2



Step 4

Figure 9

## BURNER ADJUSTMENTS (QUALIFIED TECHNICIANS ONLY)

### Flame Appearance and sooting

Proper flame appearance is a flame which is blue at the base and becomes yellowish-orange in the body of the flame. When the appliance is first lit, the entire flame may be blue and will gradually turn yellowish-orange during the first 15 minutes of operation. If after a short period the flame stays lowered blue, or if the flame is orange with evidence of sooting (black tip), the air shutter opening may need to be adjusted.

If the air shutter openings closed too far, sooting may develop. Sooting is indicated by black puffs developing at the tips of very long orange flames. Sooting results in black deposits forming on the logs, appliance inside surfaces and on exterior surfaces adjacent to the vent termination. Sooting is caused by incomplete combustion in the flames and lack of combustion air entering the air shutter opening. To achieve a warm yellowish-orange flame with an orange body that does not soot, the shutter opening must be adjusted between these two extremes.

### Air Shutter Adjustment Guidelines

- If there is smoke or soot present, first check the log set positioning to ensure that the flames are not impinging on any of the logs. If the log set is properly positioned and a sooting condition still exists, then the air shutter opening should be increased.
- The more offsets in the vent system, the larger the air shutter opening will need to be.
- An appliance operated with the air shutter opened too far, may have flames that appear blue and transparent. These weak, blue and transparent flames are termed anemic.
- Propane models may exhibit flames which candle or appear stringy. If this is present and persists, adjust the air shutter to a more open position, then operate the appliance for a few more minutes to ensure that the flame normalizes and the flames do not appear sooty.

The following chart is provided to aid you in achieving the correct air shutter adjustment for your installation.

Air Shutter Adjustment Guidelines:		
Amount of Primary Air	Flame Color	Air Shutter Adjustment
If air shutter is closed too far →	Flame will be orange →	Air shutter gap should be increased
If air shutter is open too far →	Flame will be blue →	Air shutter gap should be decreased



Figure 9 - Burner Flame Appearance Model SLDVT-35



Figure 10 - Burner Flame Appearance Model SLDVT-40

### Burner Air Shutter Adjustment Procedure

1. Locate adjustment rod and adjust air shutter to the standard setting as shown in **Figure 11** (adjustment rod is located in the lower control compartment). **Note:** Rotating the adjustment rod clockwise decreases air and counterclockwise increases air.
2. Light appliance (follow lighting procedure on lighting label in control compartment or see homeowners manual).
3. Allow the burner to operate for at least 15 minutes while observing the flame continuously to ensure that the proper flame appearance has been achieved (see **Figure 9 or 10**). If the following conditions are present, adjust accordingly.

- If flame appears weak or sooty, adjust the air shutter, incrementally, to a more open position until the proper flame appearance is achieved.
- If flame stays lowered blue, adjust the air shutter, incrementally, to a more closed position until the proper flame appearance is achieved.

4. Leave the control knob (off/pilot/on) in the ON position and the burner OFF/ON switch OFF (& remote switches, if applicable).
5. When satisfied that the burner flame appearance is normal, close the lower control compartment door.

**WARNING: Air shutter adjustment should only be performed by a qualified professional service technician.**

**WARNING: Ensure front glass panel is in place and sealed during adjustment.**

**CAUTION: The air shutter door and nearby appliance surfaces are hot. Exercise caution to avoid injury while adjusting flame appearance.**

**CAUTION:** Carbon will be produced if the air shutter is closed too much. Any damage due to carboning resulting from improperly setting the air shutter is not covered under the warranty.

**Burner Air Shutter Adjustment**

Ref. Air shutter Patent: U.S. Pat. 5,553,603

Main Burner Factory Air Shutter Opening Setting - Inches (millimeter)		
Model	Natural Gas	Propane Gas
SLDVT-35	1/32" (0.795 mm)	3/16" (4.763 mm)
SLDVT-40	1/32" (0.795 mm)	3/16" (4.763 mm)

**Figure 11**

**Millivolt Appliance Checkout**

The pilot flame should be steady, not lifting or floating. Flame should be blue in color with traces of orange at the outer edge.

The top 3/8" (10 mm) at the pilot generator (thermopile) and the top 1/8" minimum (tip) of the quick drop out thermocouple should be engulfed in the pilot flame. The flame should project 1" (25 mm) beyond the hood at all three ports. See **Figures 12 or 13**.

To light the burner, refer to the lighting instructions on **Pages 18 & 19**.

**SIT MILLIVOLT PILOT ASSEMBLY**  
**Proper Pilot Flame Appearance**

**Figure 12**

**Electronic Appliance Checkout**

To light the burner, refer to the lighting instructions on **Pages 20 & 21**. Ensure the igniter lights the pilot. The pilot flame should engulf the flame sensor as shown in **Figure 13**.

**ELECTRONIC PILOT ASSEMBLY**

**Note: If the igniter is damaged, a replacement kit is available, order Catalog Number 87L54.**

**Figure 13**

**WARRANTY**

Your gas appliance is covered by a limited twenty year warranty. You will find a copy of the warranty accompanying this manual. Please read the warranty to be familiar with its coverage.

Retain this manual. File it with your other documents for future reference.

**PRODUCT REFERENCE INFORMATION**

We recommend that you record the following important information about your fireplace. Please contact your Lennox dealer for any questions or concerns. For the number of your nearest Lennox dealer, please call 1-800-9-LENNOX

**REPLACEMENT PARTS**

A complete parts list is found at the end of this manual. Use only parts supplied from the manufacturer.

With proper care and maintenance, your appliance will provide many years of enjoyment. If you should experience any problem, first refer to the troubleshooting guide in this manual. If problem persists, contact your Lennox distributor.

Normally, all parts should be ordered through your Lennox distributor or dealer. Parts will be shipped at prevailing prices at time of order.

When ordering repair parts, always give the following information:

1. The model number of the appliance.
2. The serial number of the appliance.
3. The part number.
4. The description of the part.
5. The quantity required.
6. The installation date of the appliance.

If you encounter any problems or have any questions concerning the installation or application of this system, please contact your distributor, or Lennox directly:

**LENNOX HEARTH PRODUCTS**  
**1110 West Taft Avenue**  
**Orange, CA 92865**  
**visit us at [www.Lennox.com](http://www.Lennox.com)**

Your Fireplace's Model Number \_\_\_\_\_

Your Fireplace's Serial Number \_\_\_\_\_

The Date On Which Your Fireplace Was Installed \_\_\_\_\_

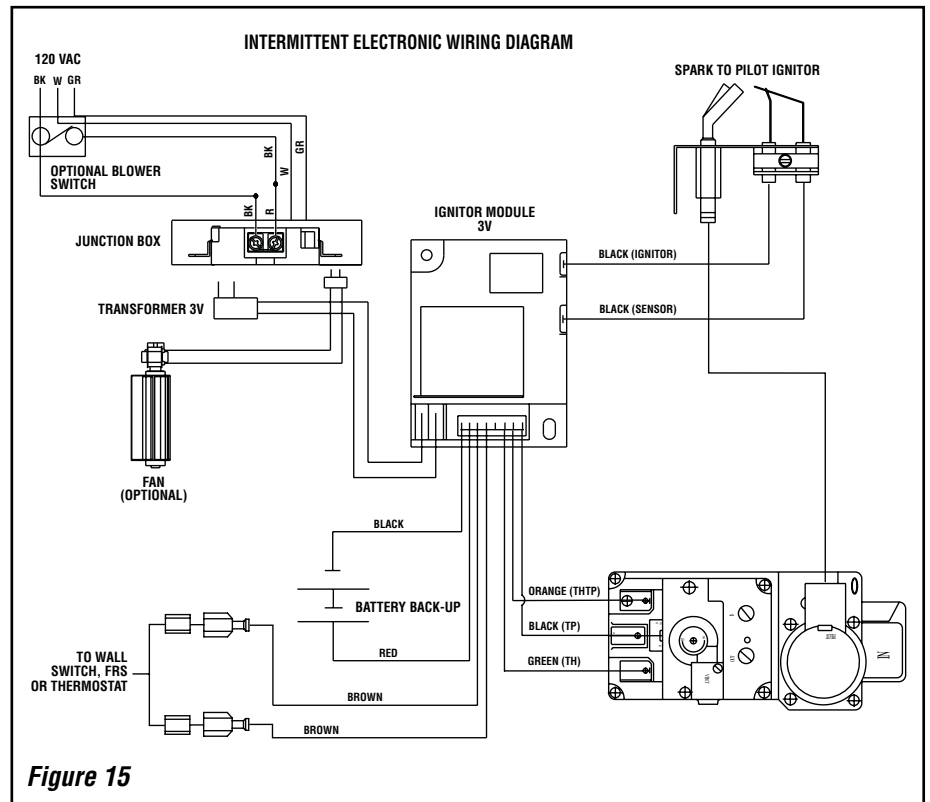
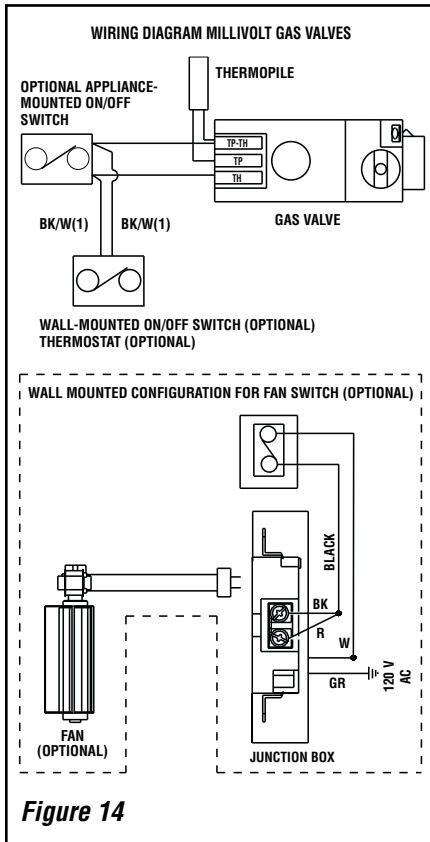
The Type of Gas Your Fireplace Uses \_\_\_\_\_

Your Dealer's Name \_\_\_\_\_

## WIRING DIAGRAMS

Wiring diagrams are provided here for reference purposes only. This information is also provided on schematics attached directly to the appliance on a pullout panel located within the control compartment.

**CAUTION: Label all wires prior to disconnection when servicing controls. Wiring errors can cause improper and dangerous appliance operation.**



## ACCESSORY COMPONENTS

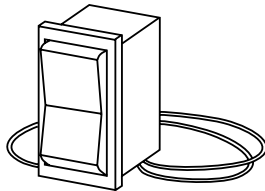
Product Reference Information			
Cat. No.	Model	Ship. Weight	Ship. Volume
H3319	SLDVT-35NM	113 lb.	15.75 cu. ft.
H3320	SLDVT-35PM	113 lb.	15.75 cu. ft.
H3321	SLDVT-35NE	113 lb.	15.75 cu. ft.
H3322	SLDVT-40NM	147 lb.	20.18 cu. ft.
H3323	SLDVT-40PM	147 lb.	20.18 cu. ft.
H3324	SLDVT-40NE	147 lb.	20.18 cu. ft.



### Digital Wall Thermostat

The wall thermostat kit provides temperature control for optimum comfort.

Wall Thermostat, Millivolt		
Cat. No.	Model No.	Description
H4635	DWTK	Wall Thermostat Kit, White



### Unit-Mountable Rocker Switch

This rocker switch kit can be installed directly in the gas valve mounting bracket (millivolt gas valve equipped fireplaces) to provide On/Off operation in lieu of a wall switch.

Rocker Switch Kit		
Cat. No.	Model No.	Description
80L41	FRS	Rocker Switch Kit

(ref. Form # 750,037M)



### Standard Remote Control System

The Model RCL (Standard) Remote Control System, features a simplistic OFF/ON control function for the fireplace. This model includes a hand-held transmitter, a remote receiver with wall-mount cover plate and all hardware required to install the unit. The remote receiver can be wall or hearth mounted.

The transmitter has ON and OFF functions that are activated by pressing either button on the face of the transmitter. When a button on the transmitter is pressed, a signal light illuminates briefly to verify that a signal has been sent.

The Model RCL is designed to operate with all millivolt ignition systems, as well as electronic ignition systems. It may be installed with use for either natural gas or propane gas appliances. The RCL offers ease of installation and allows you to execute on-off commands to the fireplace effortlessly with one simple motion.

The Model RCL comes complete with detailed operating instructions.

Remote Control Kit, Standard		
Cat. No.	Model No.	Description
H0249	RCL	Remote Control System (Standard)

(ref. Form # 750,127M)



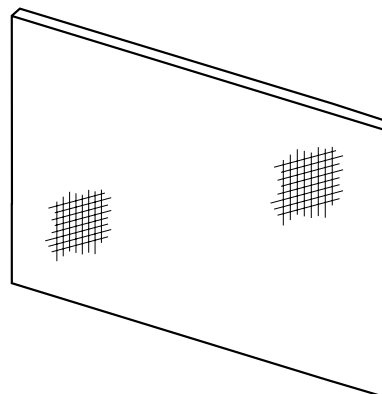
### Deluxe Remote Control System

The Model RCL-T (Deluxe) Remote Control System has all of the features of the standard system along with an added easy to read LCD screen which presents access to many enhancements, including; battery power level indicator, timer, mode of operation, thermostatic display including room temperature in either metric or English units, flame indicator and clock. Fully programmable, the Model RCL-T allows for virtual command over nearly all operational and temperature variables, using the hand held remote control transmitter.

The Model RCL-T (Deluxe) remote control system is installed in the same manner as the standard system, may be operated with electronic and millivolt systems with either natural gas or propane gas. The RCL-T comes complete with detailed operating instructions.

Remote Control Kit, Deluxe		
Cat. No.	Model No.	Description
H0251	RCL-STAT	Remote Control System (Deluxe)

(ref. Form # 750,129M)



### Barrier Screen Panel Kit

This easy to install optional screen panel installs over the standard glass enclosure panel and provides a barrier to prevent direct contact with the hot glass surface. These screen panels cannot be used in conjunction with the arch door kits or door frame kits.

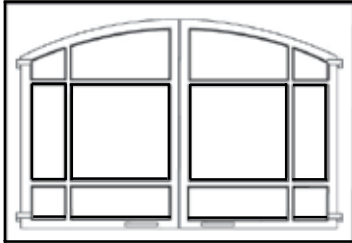
Screen Panel Kits		
Cat. No.	Model No.	Models Where Used
H6095	35MSPK	SLDVT-35
H3989	40LSPK	SLDVT-40

(ref. Form # 750,101M)

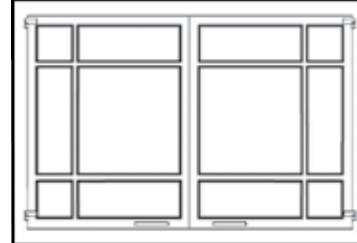
## ACCESSORY COMPONENTS CONTINUED

### Style View Screen Doors -

These Style View doors are easy to install and will not require hardware to attach them to the standard glass door frame. The Style View door installs over the standard glass enclosure panel and provides a barrier to prevent direct contact with the hot glass surface. The door includes heavy duty magnet door latches and functional twin-pane screen doors.



Arch Pane Design

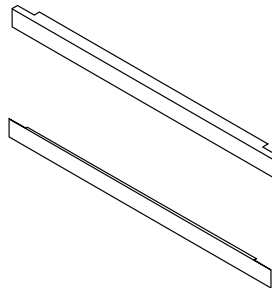


Square Pane Design

ARCH PANE DESIGN KITS			
Cat. No.	Model	Description	Model Series
H6106	APDML35C	35 Arch Pane Door, Charcoal	SLDVT-35
H6107	APDML35SP	35 Arch Pane Door, Satin Pewter	
H6108	APDML40C	40 Arch Pane Door, Charcoal	SLDVT-40
H6109	APDML40SP	40 Arch Pane Door, Satin Pewter	

SQUARE PANE DESIGN KITS			
Cat. No.	Model	Description	Model Series
H6098	SPDML35C	35 Square Pane Door, Charcoal	SLDVT-35
H6099	SPDML35SP	35 Square Pane Door, Satin Pewter	
H6100	SPDML40C	40 Square Pane Door, Charcoal	SLDVT-40
H6101	SPDML40SP	40 Square Pane Door, Satin Pewter	

2- Piece Door Frame Kits				
Polished Brass		Brushed Stainless		Models Where Used
Cat. #	Model	Cat. #	Model	
26M88	2DFK35PB	26M91	2DFK35BS	SLDVT-35
26M89	2DFK40PB	26M92	2DFK40BS	SLDVT-40

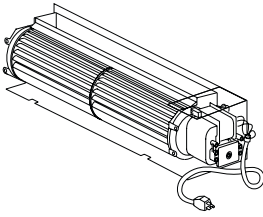


(ref. Form # 750,098M)

### Polished Brass & Brushed Stainless 2-Piece Door Frame Kits

These kits are designed to attach directly to the front face of the appliance at the glass enclosure panel's top and bottom edges.

## ACCESSORY COMPONENTS CONTINUED

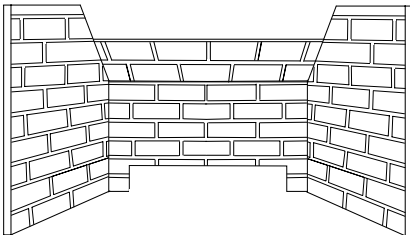


Forced Air Blower Kits		
Cat. No.	Model No.	Description
80L84	FBK-100	Blower, Standard (single speed)
80L85	FBK-200	Blower, Variable Speed (w/wall-mounted switch)

(ref. Form # 750,028M & 750,029M)

### Forced Air Kit

The FBK-100 blower provides constant velocity forced air circulation. The FBK-200 assembly with variable speed, wall-mountable switch provides variable speed forced air circulation.

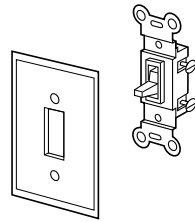


Brickaded Wall Liner Kits		
Cat. No.	Model No.	Description
H0913	MBLK-35	Brick Liner Kit, Top/Rear, SLDVT-35
H0914	MBLK-40	Brick Liner Kit, Top/Rear, SLDVT-40

(ref. Form # 750,160M)

### Brickaded Panel Liner Kit

The brickaded liner kits include ceramic panels as shown here. The panels have brick-like features in relief.



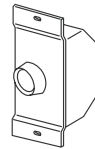
White Wall Switch Kit		
Cat. No.	Model No.	Description
85L87	FWSK	OFF/ON Wall Switch Kit

### OFF/ON Wall Switch Kit

The OFF/ON wall switch kit may be used to control the operation of the fireplace burner. Install the OFF/ON wall switch in a convenient location near the fireplace.

### Variable Speed Wall Switch

Provides variable speed control if optional blower kit is purchased.



Variable Speed Wall Switch		
Cat. No.	Model No.	Description
045571H	VSWS	Rocker Switch Kit

### Bag of Glowing Embers Bag of Volcanic Stone

Replacement ember materials or volcanic stone are available for use with these appliances. Order kits as part of the periodic maintenance of the appliance.



Decorative Firebox Accessories (all models)		
Cat. No.	Model No.	Description
88L53	FGE	Bag of Glowing Embers (1 oz. rockwool)
80L42	FDVS	Bag of Decorative Volcanic Stone

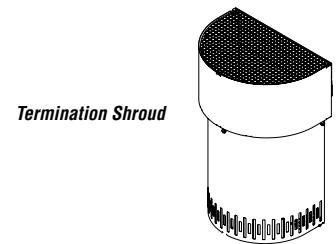
(FDVS ref. Form #750,010M)



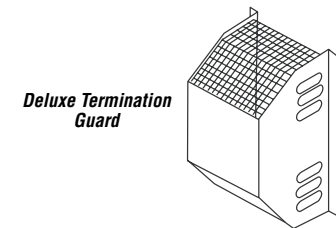
### Touch-Up Paint Kit

Repair of minor scratches and discoloration of the appliance charcoal painted surfaces may be accomplished with the touch-up paint kit.

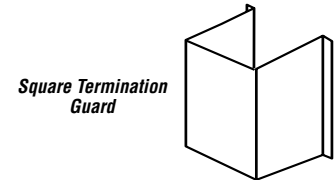
Touch-Up Paint Kits (all models)		
Cat. No.	Model No.	Description
90L74	TPK-B	Touch-Up Paint (Black)



Termination Shroud



Deluxe Termination Guard



Square Termination Guard

Termination Guard Kits (all models)		
Cat. No.	Model No.	Description
H5820	4.5HTSK	Termination Shroud
87L02	SV4.5HGS	Termination Guard, Deluxe
17M52	SV4.5HGS-1	Termination Guard, Square

Ref. 750,109M Ref. 750,055M

### Termination Guard Kits

The vent termination guards may be used to cover the vent termination on the exterior of the home to minimize exposure to the hot surface of the termination.

## LIGHTING INSTRUCTIONS – MILLIVOLT GAS VALVE

### FOR YOUR SAFETY READ BEFORE LIGHTING

**WARNING: IF YOU DO NOT FOLLOW THESE INSTRUCTIONS EXACTLY, A FIRE OR EXPLOSION MAY RESULT CAUSING PROPERTY DAMAGE, PERSONAL INJURY OR LOSS OF LIFE.**

- A.** This appliance has a pilot which must be lighted with a piezo ignitor. When lighting the pilot, follow these instructions exactly.
- B. BEFORE OPERATING** smell all around the appliance area for gas. Be sure to smell next to the floor because some gas is heavier than air and will settle on the floor.

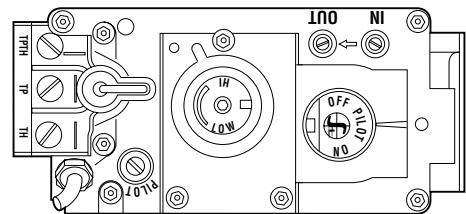
#### WHAT TO DO IF YOU SMELL GAS

- Extinguish any open flame.
- Open windows.
- Do not light any appliance.
- Do not touch any electrical switches.


- Do not use any phone in your building.
  - Immediately call your gas supplier from a neighbor's phone.
  - If your gas supplier cannot be reached, call the fire department.
- C.** Use only your hand to push in or turn the gas control knob. Never use tools. If the knob will not push in or turn by hand, do not try to repair it, call a qualified service technician. Force or attempted repair may result in a fire or an explosion.
- D.** Do not use this appliance if any part has been under water. Immediately call a qualified service technician to inspect the appliance and to replace any part of the control system and any gas control which has been under water.

## LIGHTING INSTRUCTIONS

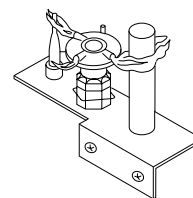
1. **STOP!** Read the safety information above on this page.
2. Access the lower control compartment.
3. Turn remote wall switch to "OFF."
4. Verify main line shut-off valve is open.
5. Push in gas control knob slightly and turn clockwise to "OFF."




**Note:** Knob cannot be turned from "PILOT" to "OFF" unless the knob is pushed in slightly. Do not force.


6. Wait five (5) minutes to clear out any gas. If you then smell gas, STOP! Follow "B" in the safety information above on this page. If you do not smell gas, go to the next step.
  7. Push in gas control knob slightly and turn counterclockwise to "PILOT."
- 
8. Push in control knob all the way and hold in. Immediately light the pilot by triggering the spark ignitor (pushing the button) until pilot lights. Continue to hold the control knob in for about 1 1/2 minutes after the pilot is lit. Release knob and it will pop back up. Pilot should remain lit. If it goes out, repeat steps 5 through 8.

- If knob does not pop up when released, stop and immediately call your service technician or gas supplier.
- If pilot will not stay lit after several tries, turn the control knob to "OFF" and call your service technician or gas supplier.



9. Turn gas control knob counterclockwise to "ON."
- 
10. Close lower control compartment.

## TO TURN OFF GAS TO APPLIANCE

1. Turn remote wall switch "OFF." The pilot will remain lit for normal service.
  2. For complete shutdown, turn remote wall switch to "OFF."
  3. Access the lower control compartment.
  4. Depress gas control knob slightly and turn clockwise to "OFF." Do not force.
- 
5. Close lower control compartment.



## INSTRUCTIONS D'ALLUMAGE – VANNE GAZ MILLIVOLT

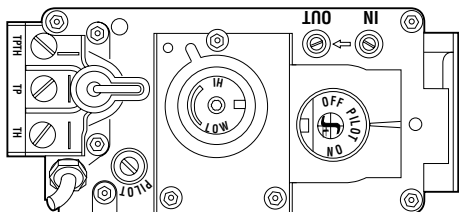
### POUR VOTRE SÉCURITÉ, LISEZ CES INSTRUCTIONS AVANT L'ALLUMAGE

**AVERTISSEMENT : SI VOUS NE SUIVEZ PAS CES INSTRUCTIONS À LA LETTRE, IL POURRAIT S'EN SUIVRE UN INCENDIE OU UNE EXPLOSION CAUSANT DES DOMMAGES MATÉRIELS, DES BLESSURES CORPORELLES OU MÊME DES PERTES DE VIE.**

- A.** Cet appareil est muni d'une veilleuse qui doit être allumée avec un allumeur piézo-électrique. Lorsque vous allumez la veilleuse, suivre exactement ces instructions.
- B. AVANT L'ALLUMAGE:** Assurez-vous que vous ne détectez aucune odeur de gaz autour de l'appareil ainsi que près du sol; certains gaz, étant plus lourds que l'air, descendent au niveau du sol.  
**VOICI CE QUE VOUS DEVEZ FAIRE SI VOUS DÉCELEZ UNE ODEUR DE GAZ:**
- Éteignez toute flamme visible.
  - Ouvrez les fenêtres.
  - N'allumez aucun appareil.
  - Ne touchez à aucun commutateur électrique.
  - Ne vous servez d'aucun téléphone dans votre édifice.
- Appelez immédiatement votre compagnie de gaz en utilisant le téléphone du voisin.
  - S'il vous est impossible de contacter votre compagnie de gaz, appelez le service des incendies.
- C.** N'utilisez que votre main pour manipuler le bouton de réglage du gaz. N'utilisez jamais d'outils. Si le bouton refuse de tourner ou de bouger, n'essayez pas de le réparer. Communiquez immédiatement avec un technicien de service qualifié. Toute tentative pour le forcer ou le réparer, risquerait de provoquer un incendie ou une explosion.
- D.** Ne vous servez pas de cet appareil si l'un de ses éléments a été immergé dans l'eau. Appelez immédiatement un technicien compétent pour faire inspecter l'appareil et remplacer toute pièce du système de réglage ou commande du gaz qui a été sous l'eau.

### INSTRUCTIONS D'ALLUMAGE

- 1. ARRÊTEZ!** Lisez les consignes de sécurité au verso de cette plaque.
- Ouvrez le compartiment de contrôle du bas.
- Tournez l'interrupteur mural à la position d'arrêt "OFF".
- Assurez-vous que la soupape d'arrêt de la canalisation principale est ouverte.
- Enfoncez légèrement le bouton de réglage du gaz et tournez-le dans le sens des aiguilles d'une montre jusqu'à la position d'arrêt "OFF".



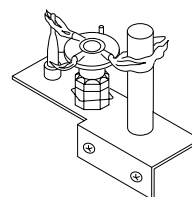
**Remarque:** Il est impossible de tourner le bouton de "PILOT" à "OFF" à moins qu'il ne soit légèrement enfoncé. Ne le forcez pas.

- 6.** Attendez cinq (5) minutes pour l'évacuation du gaz. Si vous décelez une odeur de gaz, ARRÊTEZ ! Retournez au point "B" des consignes de sécurité au verso de cette plaque. Si vous ne remarquez aucune odeur de gaz, passez à l'étape suivante.
- 7.** Enfoncez légèrement le bouton de réglage du gaz et tournez-le en sens inverse des aiguilles d'une montre jusqu'à la position de veilleuse "PILOT".

- 8.** Enfoncez le bouton de réglage jusqu'au fond et gardez-le enfoncé. Allumez immédiatement la veilleuse en déclenchant l'allume-gaz à étincelle (en poussant le bouton) jusqu'à ce que la veilleuse s'enflamme. Continuez de tenir le bouton de réglage enfoncé pendant environ 90 secondes après l'allumage de la veilleuse. Relâchez le bouton et il sortira subitement. La veilleuse devrait rester allumée. Si elle s'éteint, répétez les étapes 5 à 8 inclusivement.

- Si le bouton ne sort pas automatiquement après avoir été relâché, arrêtez immédiatement et téléphonez à votre technicien de service ou à votre fournisseur de gaz.

- Si la veilleuse refuse de rester allumée après plusieurs tentatives, tournez le bouton de réglage jusqu'à sa position d'arrêt "OFF" et téléphonez à votre technicien de service ou à votre fournisseur de gaz.



- 9.** Tournez le bouton de réglage du gaz en sens inverse des aiguilles d'une montre jusqu'à sa position de marche "ON".
- 10.** Fermez le compartiment de contrôle du bas.
- 11.** Au besoin, rebrancher l'appareil au courant électrique et remettre l'interrupteur du brûleur principal à la position "ON" ou régler le thermostat à la température désirée.
- 12.** Si l'appareil ne fonctionne pas, suivre les instructions intitulées "Pour fermer le gaz qui alimente l'appareil" et appeler un technicien ou le fournisseur de gaz.

### POUR FERMER LE GAZ QUI ALIMENTE L'APPAREIL

- 1.** Tournez l'interrupteur mural à la position d'arrêt "OFF". La veilleuse restera allumée jusqu'au retour du service normal.
- 2.** Pour une fermeture complète, tournez l'interrupteur mural à la position d'arrêt "OFF".
- 3.** Ouvrez le compartiment de contrôle du bas.
- 4.** Enfoncez légèrement le bouton de réglage du gaz et tournez-le dans le sens des aiguilles d'une montre jusqu'à la position d'arrêt "OFF". Ne forcez pas le bouton.
- 5.** Fermez le compartiment de contrôle du bas.

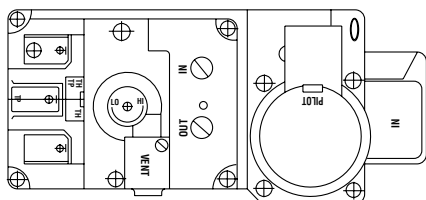
## LIGHTING INSTRUCTIONS — ELECTRONIC

### FOR YOUR SAFETY READ BEFORE LIGHTING

**WARNING: IF YOU DO NOT FOLLOW THESE INSTRUCTIONS EXACTLY, A FIRE OR EXPLOSION MAY RESULT CAUSING PROPERTY DAMAGE, PERSONAL INJURY OR LOSS OF LIFE.**

- A.** When lighting the appliance, follow these instructions exactly.
- B. BEFORE OPERATING** smell all around the appliance area for gas. Be sure to smell next to the floor because some gas is heavier than air and will settle on the floor.
- WHAT TO DO IF YOU SMELL GAS**
- Extinguish any open flame.
  - Open windows.
  - Do not light any appliance.
  - Do not touch any electrical switches.
  - Do not use any phone in your building.
- Immediately call your gas supplier from a neighbor's phone.
  - If your gas supplier cannot be reached, call the fire department.
- C.** Use only your hand to turn the gas control lever. Never use tools. If the lever will not turn by hand, do not try to repair it, call a qualified service technician. Force or attempted repair may result in a fire or an explosion.
- D.** Do not use this appliance if any part has been under water. Immediately call a qualified service technician to inspect the appliance and to replace any part of the control system and any gas control which has been under water.

## LIGHTING INSTRUCTIONS

- 1. STOP!** Read the safety information above on this page.
  - Turn remote wall switch to "OFF" or set wall thermostat to lowest setting. If used, remove the batteries from the battery holder.
  - This appliance is equipped with an ignition device which automatically lights the pilot. Do not try to light the pilot by hand.
  - Push the unit mounted "ON/OFF" switch to the "OFF" position.
- 
- Allow sufficient length of time (minimum 5 minutes) for any gas in the combustion chamber to escape. If you still smell gas, STOP! Follow "B" in the safety information above on this page. If you do not smell gas, go to the next step.
  - Push the unit mounted "ON/OFF" switch back to the "ON" position. (The "ON/OFF" switch may include a wall switch if so equipped). Replace the batteries in the battery holder, if used. If the burner does not light or stay lit after several tries, turn the unit mounted "ON/OFF" switch to the "OFF" position and call your service technician or gas supplier. NOTE: Sufficient time must be allowed for air to escape from lines if the unit is being lit for the first time.
  - Turn HI-LO burner control knob to desired setting and close control door.
  - Set thermostat to desired setting if applicable.
  - If the appliance will not operate, follow the instructions "To Turn Off Gas To Appliance" and call your service technician or gas supplier.

### TO SHUT OFF

- Turn off all electrical power to the appliance (remote wall switch) or set the thermostat to the lowest setting, if applicable. Or remove batteries, if used.

## TO TURN OFF GAS TO APPLIANCE

- For complete shut-down, turn remote wall switch to "OFF" or set the thermostat to the lowest setting, if applicable.
- Turn the ON/OFF switch to "OFF". If step 1 is not applicable.
- Turn off all electric power to the appliance and remove backup batteries if service is to be performed or for extended shutdown.

## INSTRUCTIONS D'ALLUMAGE — ELECTRONIC

### POUR VOTRE SÉCURITÉ, LISEZ CES INSTRUCTIONS AVANT L'ALLUMAGE

**AVERTISSEMENT: SI VOUS NE SUIVEZ PAS CES INSTRUCTIONS À LA LETTRE, IL POURRAIT S'EN SUIVRE UN INCENDIE OU UNE EXPLOSION CAUSANT DES DOMMAGES MATÉRIELS, DES BLESSURES CORPORELLES OU MÊME DES PERTES DE VIE.**

**A.** Lorsque vous allumez l'appareil, suivez exactement ces instructions.

**B. AVANT L'ALLUMAGE:** Assurez-vous que vous ne détectez aucune odeur de gaz autour de l'appareil ainsi que près du sol; certains gaz, étant plus lourds que l'air, descendent au niveau du sol.

#### VOICI CE QUE VOUS DEVEZ FAIRE SI VOUS DÉCELEZ UNE ODEUR DE GAZ

- Éteignez toute flamme visible.
- Ouvrez les fenêtres.
- N'allumez aucun appareil.
- Ne touchez à aucun commutateur électrique.
- Ne vous servez d'aucun téléphone dans votre édifice.

- Appelez immédiatement votre compagnie de gaz en utilisant le téléphone du voisin.
- S'il vous est impossible de contacter votre compagnie de gaz, appelez le service des incendies.

**C.** N'utilisez que votre main pour manipuler l'interrupteur "ON/OFF" de la valve à gaz. N'utilisez jamais d'outils. Si l'interrupteur ne bouge pas manuellement, n'essayez pas de le réparer. Communiquez immédiatement avec un technicien de service qualifié. Toute tentative pour forcer l'interrupteur ou le réparer, risquerait de provoquer un incendie ou une explosion.

**D.** Ne vous servez pas de cet appareil si l'un de ses éléments a été immergé dans l'eau. Appelez immédiatement un technicien compétent pour faire inspecter l'appareil et remplacer toute pièce du système de réglage ou commande du gaz qui a été sous l'eau.

### INSTRUCTIONS D'ALLUMAGE

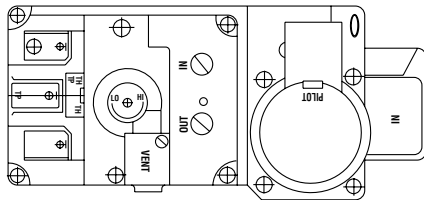
**1. ARRÊTEZ !** Lisez les consignes de sécurité au verso de cette plaque.

**2.** Tournez l'interrupteur mural à la position d'arrêt "OFF".

**3.** Ouvrez la porte du compartiment de contrôle du bas.

**4.** Assurez-vous que la soupape d'arrêt de la canalisation principale est ouverte.

**5.** Tournez la manette de réglage du gaz à la position d'arrêt "OFF".



**6.** Attendez cinq (5) minutes pour l'évacuation du gaz. Si vous décelez une odeur de gaz ARRÊTEZ ! Retournez au point "B" des consignes de sécurité au verso de cette plaque. Si vous ne remarquez aucune odeur de gaz, passez à l'étape suivante.

**7.** Tournez la manette de réglage du gaz jusqu'à la position de marche "ON". Ne la forcez pas.

**8.** Ouvrez le courant électrique ("ON") qui alimente l'appareil (interrupteur mural).

**9.** Fermez la porte du compartiment de contrôle du bas.

**10.** Au besoin, rebrancher l'appareil au courant électrique et remettre l'interrupteur principal du brûleur à la position "ON" ou régler le thermostat à la température désirée.

**11.** Si l'appareil ne se met pas en marche, suivre les instructions intitulées "Pour fermer le gaz qui alimente l'appareil" et appeler un technicien ou le fournisseur de gaz.

#### POUR ÉTEINDRE L'APPAREIL

**1.** Coupez tout le courant électrique qui alimente l'appareil (interrupteur mural).

### POUR FERMER LE GAZ QUI ALIMENTE L'APPAREIL

**1.** Pour une fermeture complète, tournez l'interrupteur mural à la position d'arrêt "OFF".

**2.** Ouvrez la porte du compartiment de contrôle du bas.

**3.** Tournez la manette de réglage du gaz à la position d'arrêt "OFF". Ne la forcez pas.

**4.** Fermez la soupape d'arrêt de la canalisation principale.

**5.** Fermez la porte du compartiment de contrôle du bas.

## MAINTENANCE SCHEDULE

### Annually (Before the onset of the Burning Season)

MAINTENANCE TASK	ACCOMPLISHING PERSON	PROCEDURE
Inspecting/Cleaning Burner, Logs and Controls	Qualified Service Technician	Inspect valve and ensure it is properly operating. Check piping for leaks. Vacuum the control compartment, fireplace logs and burner area.
Check Flame Patterns and Flame Height	Qualified Service Technician	Refer to <b>Figure 9 (SLDVT-35) or Figure 10 (SLDVT-40) on Page 10</b> and verify the flame pattern and height displayed by the appliance conforms to the picture. Flames must not impinge on the logs. Ensure flames are steady (not lifting or floating).
Inspecting/Cleaning Pilot and Burner	Qualified Service Technician	Refer to <b>Figure 12 (SIT Millivolt) or Figure 13 (Electronic) on Page 11</b> . Remove any surface build-up on pilot and burner assembly. Wipe the pilot nozzles, igniter/flame rod and hood. Ensure the pilot flame engulfs the flame sensor as shown.
Checking Vent System	Qualified Service Technician	Inspect the vent system at the top and at the base (within the firebox) for signs of blockage or obstruction. Look for any signs of dislocation or deterioration of the vent components. <b>Note:</b> Excessive condensation can cause corrosion of caps, pipe & fittings (excessive condensation can be caused by long lateral runs, too many elbows and/or exterior portions of the system being exposed to cold weather). Also inspect wall straps or plumbers's tape to ensure it is secure and in place.
Appliance Checkout	Qualified Service Technician	Perform the appropriate appliance checkout procedure detailed in this manual.
Replacing Rockwool Ember Materials	Homeowner/Qualified Service Technician	Remove old ember materials (rockwool) and vacuum the ember placement area. Place new embers as described and shown in <b>Figures 7 &amp; 8</b> .

### Periodically (After the Burning Season)

MAINTENANCE TASK	ACCOMPLISHING PERSON	PROCEDURE
Cleaning Firebox Interior	Homeowner	Carefully remove logs, rockwool, volcanic stone and vermiculite. Vacuum out interior of the firebox. Clean firebox walls and log grate. Replace logs, rockwool, vermiculite and volcanic stone as detailed in this manual.
Check Flame Patterns and Flame Height	Homeowner	Refer to <b>Figure 9 (SLDVT-35) or 10 (SLDVT-40) on Page 10</b> and verify the flame pattern and height displayed by the appliance conforms to the picture. Flames must not impinge on the logs.
Checking Vent System	Homeowner	Inspect the vent system at the top and at the base (within the firebox) for signs of blockage or obstruction. Look for any signs of dislocation of the vent components.
Cleaning Front Glass Enclosure Panel	Homeowner	Clean as necessary following the directions provided in this manual. <b>DO NOT TOUCH OR ATTEMPT TO CLEAN GLASS WHILE HOT.</b>

## TROUBLESHOOTING

**Note:** Before troubleshooting the gas control system, Ensure external gas shut off valve, located at gas supply inlet, (and wall switch, iff applicable), is in the "ON" position.

**Important:** Valve system troubleshooting should only be accomplished by a qualified service technician.

### TROUBLESHOOTING GUIDE - MILLIVOLT GAS CONTROL SYSTEM

SYMPTOM	POSSIBLE CAUSES	CORRECTIVE ACTION
<p>1. Spark igniter will not light pilot after repeated triggering of igniter button.</p> <p><b>WARNING: if the pilot will not light after 1 minute of attempting, wait for at least 5 minutes for gas to clear before attempting again.</b></p>	A. Defective igniter (no spark at electrode).	Check for spark at electrode and pilot; if no spark and electrode wire is properly connected, replace igniter.
	B. Defective or misaligned electrode at pilot (spark at electrode).	Using a match, light pilot. If pilot lights, turn off pilot and trigger the igniter button again. If pilot lights, an improper gas mixture caused the bad lighting and a longer purge period is recommended. If pilot will not light—check gap at electrode and pilot—should be 1/8" to have a strong spark. If gap measures 1/8", replace pilot (see <b>Figures 12 or 13 on Page 11</b> ).
	C. Gas supply pressure errant.	Check inlet gas pressure. It should be within the limits as marked on the rating plate.
	D. Pilot orifice plugged.	Clean or replace pilot orifice.
<p>2. Pilot will not stay lit after carefully following the lighting instructions.</p>	A. Defective pilot generator (thermocouple).	Check pilot flame, it must impinge on thermocouple (see <b>Figures 12 or 13 on Page 11</b> ). Clean and/or adjust pilot for maximum flame impingement on thermocouple. Ensure that the connection between the valve and thermocouple are tight and secure.
<p>3. Pilot burning, no gas to burner, Valve knob "ON," and the (standard) burner OFF/ON switch is "ON." Read important note below.</p> <p><b>IMPORTANT NOTE: If an optional *remote switch is used for burner operation, if the standard burner OFF/ON switch is still installed on appliance it must be in the "OFF" position.</b></p> <p><b>* Optional remote switch kits - wall switch, wall thermostat or remote control.</b></p>	A. Wall switch or wires defective.	Check wall switch and wires for proper connections. Jumper wire across terminals at wall switch, if burner comes on, replace defective wall switch. If okay, jumper wires across wall switch wires at valve, if burner comes on, wires are faulty or connections are bad.
	B. Thermopile may not be generating sufficient millivolts.	Check thermopile with millivolt meter. Take reading at thermopile terminals of gas valve. Should read 325 millivolts minimum with optional wall switch "OFF." Replace faulty thermopile if reading is below specified minimum.
	C. Plugged burner orifice.	Check burner orifice for blockage and remove.
	D. OFF/ON Switch & *Remote Switch are in the "ON" position resulting in excessive resistance.	When turning on the burner using a *remote switch, ensure that the standard OFF/ON switch is in the "OFF" position. If both switches are in the ON position, it may result in excessive resistance (& millivolt drainage) and the burner may not come on.
<p>4. Frequent pilot/burner outage problem.</p>	A. Pilot flame may be too low or blowing (high) causing the pilot/valve safety to drop out.	Clean and/or adjust pilot flame for maximum flame impingement on thermocouple (see <b>Figures 12 or 13 on Page 12</b> ).

### TROUBLESHOOTING GUIDE - ELECTRONIC IGNITION SYSTEM

SYMPTOM	POSSIBLE CAUSES	CORRECTIVE ACTION
<p>1. Burner will not light.</p>	A. Faulty Valve System.	See Below.
	B. "OFF/ON" or wall switch defective.	Disconnect the two black wires from the wire nuts. Test switch(s) for continuity with a multimeter. If continuity is not indicated, switch(s) is defective and must be replaced.  <b>Note:</b> Before replacing "OFF/ON" switch, Ensure to check wiring for loose connections or broken wires and repair as needed.
<p>2. Burners come "ON," then turns "OFF."</p>	A. Burner orifice plugged.	Check main burner orifice(s) for blockage. Clean or replace.
	B. Obstructed vent system.	Check vent system for obstructions.

# TROUBLESHOOTING THE ELECTRONIC IGNITION SYSTEM

**Note:** Before troubleshooting, be sure that the appliance main line gas shut-off valve, the gas control valve and the wall switch are in the "ON" position.

**Important:** Valve system troubleshooting should only be accomplished by a qualified service technician.

SYMPTOM	POSSIBLE CAUSES	CORRECTIVE ACTION
1. Nothing happens when ON/OFF switch is turned on (pilot does not spark).	A. Low voltage/or bad lead wires.	Check voltage on AC terminals of module an/or batteries. The value should be around 2.7 to 3.2 VAC. Confirm that wire connections are secure.
	B. Damaged igniter wire.	Check for visible cracked casing, cuts, etc.
	C. Damaged pilot assembly.	Check pilot assembly for visibly broken spark electrode, etc.
	D. Batteries Low	Check voltage on D.C. terminal of batteries. The value should be around 3.0V
2. The main burner does not light and the igniter is sparking.	A. No fuel supply.	Ensure that the gas supply is turned on.
	B. Loose sensor wire.	Ensure sensor wire connection is secure.
	C. Lose wires to valve.	Ensure black, green and orange wires connection is secure to valve.
	D. Loose wires to ignition module.	Ensure black sensor wire (S) and black igniter wire (I) is secure to ignition module.
	E. Air in the gas line.	Purge gas line of air.
	F. Low voltage.	Test voltage at AC terminals of module and/or batteries. It should be around 2.7 to 3.2 VAC.
3. The main burner come "ON" but then go "OFF".	A. Gas supply is turned "OFF".	Turned gas supply to "ON".
	B. Loose wire connection on valve or ignition module.	Check wire connection.
	C. Flame does not engulf flame sensor.	Check location of sensor.
	D. Obstructed vent system.	Check vent system for obstructions.
4. The log and glass soot.	A. Flame impingement on the log.	Check for proper log placement.
	B. Improper air shutter opening.	Check for proper air shutter openings.

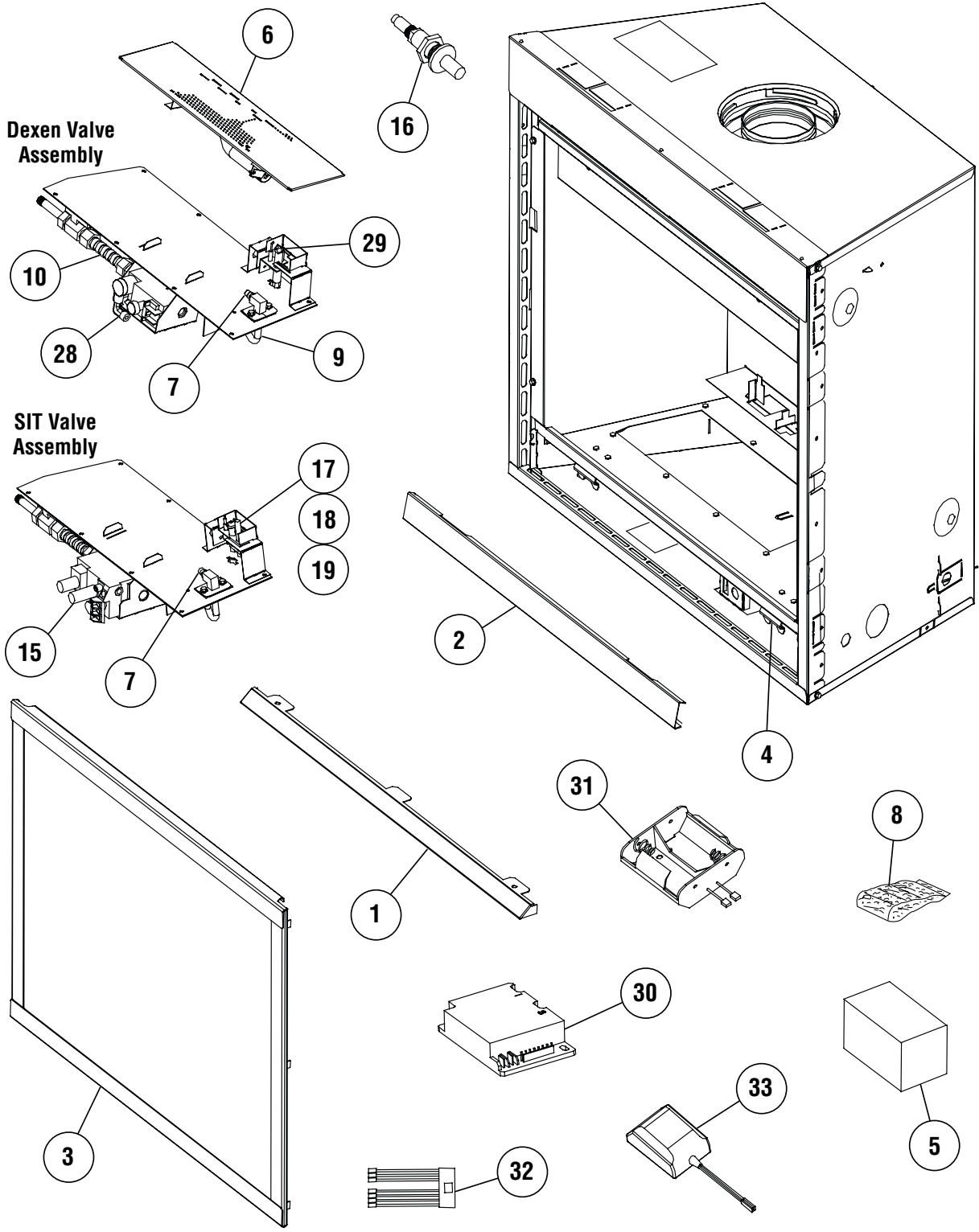
## REPLACEMENT PARTS LIST

Item No.	Description	SLDVT-35		SLDVT-40	
		Part No.	Qty.	Part No.	Qty.
1	Hood	H7266	1	H7267	1
2	Lower Control Compartment Panel	H7262	1	H7263	1
3	Enclosure, Glass Front (Complete)	H7264	1	H7265	1
4	Door Latch Spring	H6135	2	H6135	2
5	Log Set (Complete)	H7244	1	H7245	1
6	Burner Assembly	H7258	1	H7259	1
7	Orifice, Main Burner - Natural Gas	21L82	1	60J80	1
7	Orifice, Main Burner - Propane Gas	75L10	1	99K78	1
8	Bag of Glowing Embers (Rockwool)	88L53	1	88L53	1
8	Bag of Decorative Volcanic Stone	80L42	1	80L42	1
9	Orifice Holder	H7257	1	H7257	1
10	Gas Line Flexible Connector	93L32	1	93L32	1

Gas Controls - SIT Millivolt					
Item No.	Description	Natural Gas		Propane Gas	
		Part No.	Qty.	Part No.	Qty.
15	Gas Valve, SIT	H4307	1	88J53	1
16	Piezo Igniter	10K86	1	10K86	1
17	Pilot Assembly	69L17	1	69L18	1
18	Pilot Generator	60J79	1	60J79	1
19	Thermocouple	74L57	1	74L57	1
20	Pilot Tube	74L56	1	74L56	1
21	Electrode and Cable	74L58	1	74L58	1

Gas Controls - Dexen Electronic			
Item No.	Description	Natural Gas	
		Part No.	Qty.
28	Gas Valve, Dexen	H4681	1
29	Pilot Assembly	H4673	1
30	Ignitor Module	H4674	1
31	Battery Holder	H4675	1
32	Wire Harness	H4676	1
33	Adapter	H4677	1

# REPLACEMENT PARTS



NOTE: DIAGRAMS & ILLUSTRATIONS ARE NOT TO SCALE.

The manufacturer reserves the right to make changes at any time, without notice, in design, materials, specifications, prices and also to discontinue colors, styles and products. Consult your local distributor for fireplace code information.