



User Manual

Solar-Log⁵⁰⁰

MAXIMIZED SUNPOWER

Contents

1	General information	6
2	Operation using the web browser in your own network	7
2.1	Requirements	7
2.2	Overview	8
2.2.1	Navigation overview	8
2.2.2	Homepage	9
2.3	Calling up yield data	10
2.3.1	How to navigate within the overviews	10
2.3.2	What the values in the overviews mean	11
2.3.3	Day overview	12
2.3.4	Month overview	14
2.3.5	Year overview	15
2.3.6	Total overview	16
2.4	Calling up yield data on a mobile computer	18
2.4.1	Day	19
2.4.2	Month	19
2.4.3	Year	20
2.5	Calling up the diagnosis function	21
2.5.1	Calling up and filtering the event log	22
2.5.2	Displaying the decrease in output for your plant	24
2.6	Changing settings in the configuration menu	26
3	Showing performance data on the display	27
4	Using Solar-Log WEB	28
4.1	Register with Solar-Log™ WEB "Classic 2nd Edition"	28
4.2	Calling up plant data	31
4.3	Calling up yield data	35
4.3.1	How to navigate within the overviews	35
4.3.2	What the values in the overviews mean	35
4.3.3	Day overview	35
4.3.4	Month overview	37
4.3.5	Year overview	38

4.3.6	Overview of all years	40
4.3.7	Calling up and filtering the event log	41
5	Using the Solar-Log™ APP for iPhone	43
5.1	Installing the app	43
5.2	Adding plants	44
5.3	Calling up yield data	47
5.3.1	How to navigate within the overviews	48
5.3.2	What the values in the overviews mean	48
5.3.3	Day overview	48
5.3.4	Month overview	50
5.3.5	Year overview	50
5.3.6	Total overview	51
5.4	Calling up data	52
5.5	Calling up CO ₂ savings	53
5.6	The yield data as a slide show	54
6	Cleaning and care	56
6.1	Cleaning tips	56
6.2	Care tips	56
7	Malfunctions	57
7.1	Status display for the LEDs	57
7.2	Remedying faults yourself	58
7.2.1	Obtaining information from the internet	60
7.2.2	Informing a specialist technician	60
8	Disposal	61
9	Technical data	62
	Glossary	63

1 General information

This user manual is intended to assist you in the operation of the Solar-Log⁵⁰⁰. The yield data for the Solar-Log⁵⁰⁰ can be displayed in several ways:

- via a web browser in a local network ([↗page 7](#)) or
- via the internet ([↗page 27](#)) or
- via the Solar-Log™ APP for iPhone ([↗page 43](#)).

2 Operation using the web browser in your own network

2.1 Requirements



Information

For faster access, enter "solar-log" in the address line of the browser and create a bookmark.

In the local network

To operate the Solar-Log⁵⁰⁰ using a web browser you will need to be on a computer that is connected to the same local network as the Solar-Log⁵⁰⁰. This computer will also need to have a modern web browser installed on it.

You are also able to operate the Solar-Log⁵⁰⁰ on a mobile device such as a tablet, smartphone. This device must also be connected to the same local network as the Solar-Log⁵⁰⁰. It must also have a modern web browser installed on it.

Via the internet

In addition to the computer or mobile computer with a web browser you need an active internet connection as well as a user account on a server.

- ▶ To set up a user account please contact your solar technician or find out more on our homepage under

<http://www.solar-log.com/en/products-solutions/solar-log-web.html>

2.2 Overview

2.2.1 Navigation overview

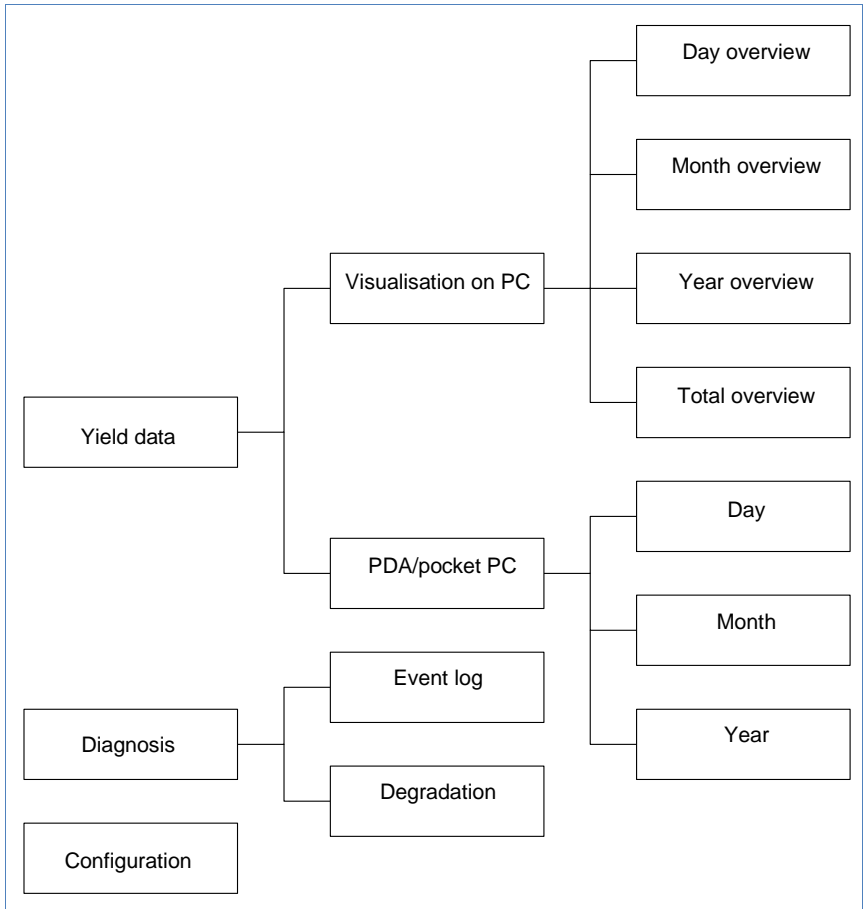

2.2.2 Homepage

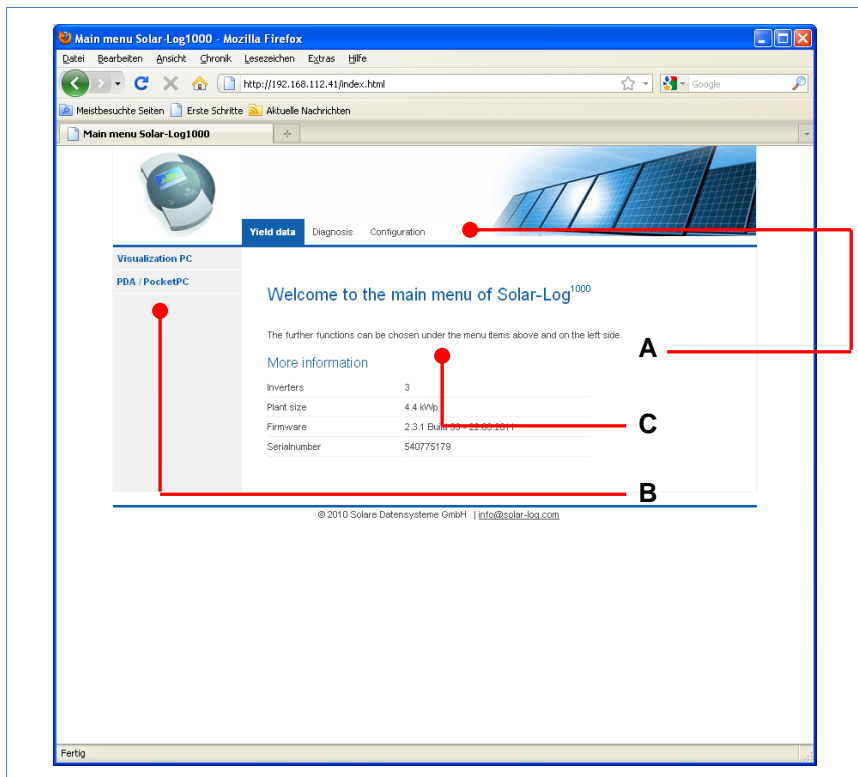

The homepage contains the following areas:

- Main navigation menu (A)
- Navigation bar (B)
- Information field (C)

Main navigation menu

The main navigation menu contains three main operating groups:

- **Yield data:** Here you will find the yield information within certain periods of time such as day, month, year and the total yield to date of your plant.

- **Diagnosis:** Here you can call up the fault and process reports as well as filter according to desired criteria.
- **Configuration:** Here you can change the settings of your device as required.

Left navigation bar

Depending on the selected field in the main navigation menu you can access additional functions in the left navigation bar.

Information field

Device configuration will take place in this area. When viewing yield information an additional window will pop up and yield information can be found there.

2.3 Calling up yield data

- 1 Start the web browser and enter "solar-log" in the address line of the browser or select the bookmark in the browser's navigation bar.
→ The homepage is displayed.
- 2 Select **Visualization PC** in the left navigation bar.
→ The output details for the current day are displayed in a new window.

2.3.1 How to navigate within the overviews

Symbol	Meaning
	Arrow keys: used to navigate to the previous or next period of time shown. Magnifying glass symbol: used to update the modified parameters.

Symbol	Meaning
	Information on the inverter that is connected. Hold the cursor over a field to display the specific values.
	Display of additional information on the plant (page 11).

- 1 Click inside the colored area of the connected inverter or the desired yield values.
- 2 Click on the magnifying glass symbol.
 - The overview is updated and the yield information for the inverter or the yield values is shown in the selected overview, as a line.
- 3 Move to the next overview by clicking on the information under the heading.
- 4 Close the yield data window.
 - This allows you to return to the main menu.

2.3.2 What the values in the overviews mean

Description	Unit	Meaning
Power input Pac	W	The current power input P on the AC voltage side
Generator output Pdc	W	The current power input P on the DC voltage side (solar generator)
Inverter efficiency η	%	The current efficiency from the generator output and the power input. The manufacturer's specifications regarding the efficiency of the inverter can be checked here.

Description	Unit	Meaning
Status / Error		Status and error codes for the inverter. The codes shown are dependent on the manufacturer and must be looked up in the manual for the respective inverter. Status messages that are the same are collated.
Yield	kWh	The yield for the period of time shown (day, month, year, total)
Yield, specific	kWh/kWp	The output divided by the plant size. This value is a good reference value with respect to other plants.
Maximum value	W	The maximum output value within the period of time shown.
Target	kWh	The device runs a forecasting statistics function that specifies a certain target value for each time period. If the target value is attained or exceeded the forecast output has been achieved.
Actual	%	The actual value shows the percentage share for the actual yield and the target yield.

2.3.3 Day overview

- ▶ Select **Overview Daily** in the left navigation bar.

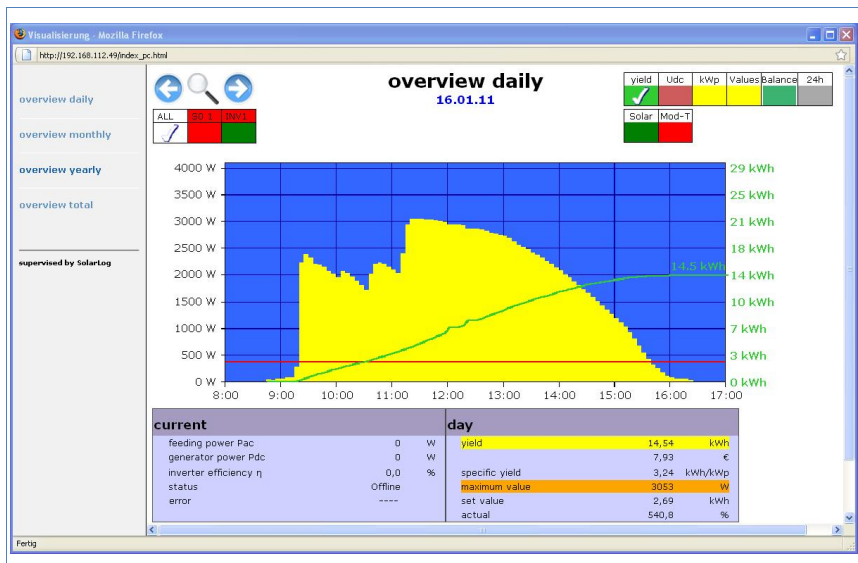

The daily yields are shown in a curve chart. The red line shows the target value for each day.

Buttons for the day overview

- **Yield:** Yield line via which the yield trend can take place. In addition, a red line is displayed as the total daily target.
- **Udc:** Generator voltage. To display voltage of the individual strings only one inverter may be selected.
- **kWp:** Converting the scaling from "Output in watts" to "Output in kWh/kWp". This makes all of the curves comparable in terms of their specific output. This also makes it easier to identify decreased outputs from specific inverters/strings.
- **°C / °F :** Display showing the inverter's internal temperature. This allows you to check that the fans are functioning correctly. **Please note that inverters are designed to have high internal temperatures.**

The temperature display is shown only for inverters that provide the corresponding measured value.

- **24h:** Display showing the output over 24 hours of the day for a complete visualisation of the power consumption over the course of one day.

Additional functions using S0 meter reader

The following displays are also available to you by connecting an S0 meter to the Solar-Log™:

- **S0:** Shows the power consumption for your building as a graph, in watts.
- **Cons.:** Shows the power consumption for your building as a rising line, in kWh.
- **Values:** Shows various values for your inverter in text form.
- **Balance:** Shows you the ratio of your power consumption to your power yield. In the lower left text field the ratio is also shown as a percentage.

Additional functions with the sensor box

- **Solar:** Shows the reference value of an irradiation sensor. The daily output of the plant must be within the measuring range of the sensor.
- **Mod T:** Shows the module temperature. The temperature is detected by the sensor box.

2.3.4 Month overview

- ▶ Select **Overview Monthly** in the left navigation bar.

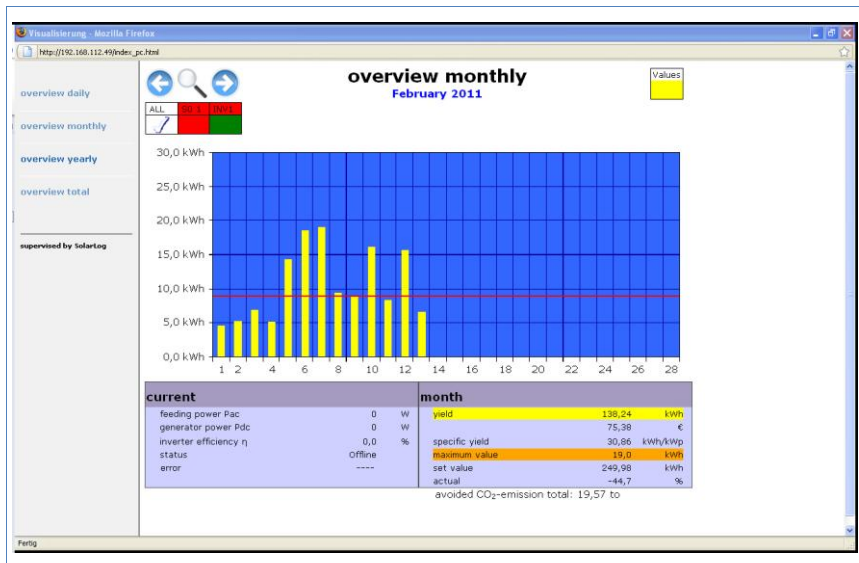

The daily yields for one month are shown as a total in a bar graph. The red line shows the target yield for each month.

- 1 Move the mouse over a day bar.
→ The corresponding day's yield is shown.
- 2 Click on an individual bar to switch to the corresponding day overview.

2.3.5 Year overview

- ▶ Select **Overview Yearly** in the left navigation bar.

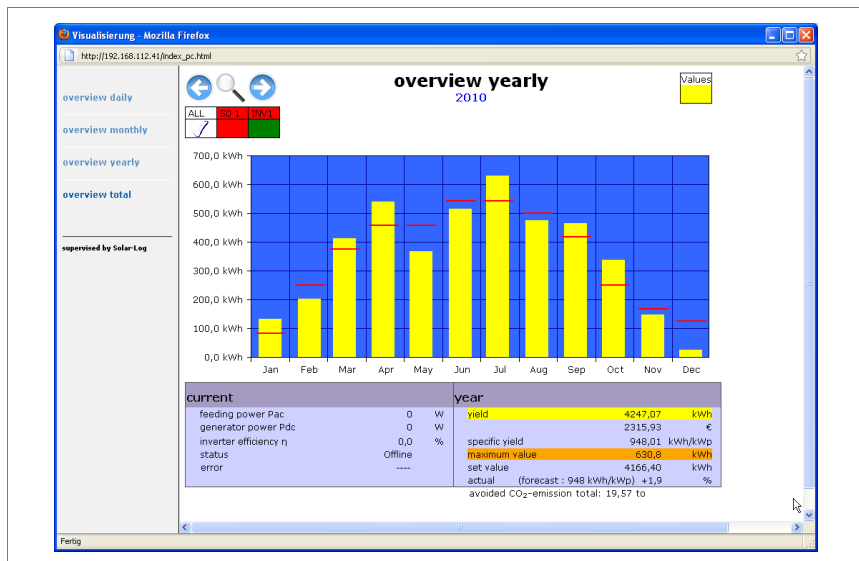

The individual monthly yields are shown as a total in a bar graph. The red line shows the target yield for each month.

The "Forecast" value is calculated using the yields already achieved for the year and is then projected using the target yields for the remaining months of the year.

- 1 Move the mouse over a month bar.
→ The corresponding month's yield is shown.
- 2 Click on an individual bar to switch to the corresponding month overview.

2.3.6 Total overview

- ▶ Select **Overview Total** in the left navigation bar.

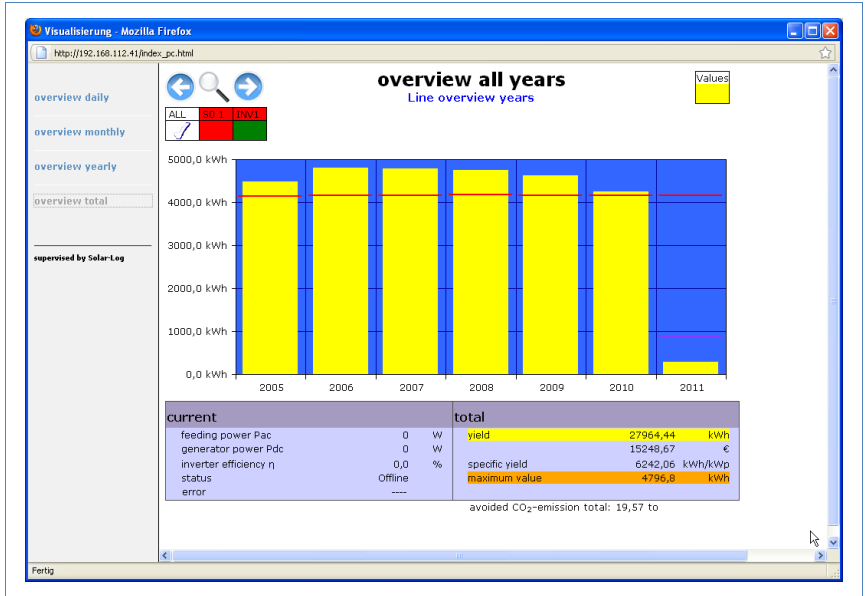

The individual annual yields are shown as a total in a bar graph. The red line shows the total target yield. For the current year two red lines are shown:

- The top line shows the annual target.
 - The bottom line shows the annual target accumulated to the present day.
- 1 Move the mouse over a year bar.
→ The corresponding year's yield is shown.
 - 2 Click on an individual bar to switch to the corresponding year overview.
 - 3 Click on **Line overview, years** to display a line view for the total yield.

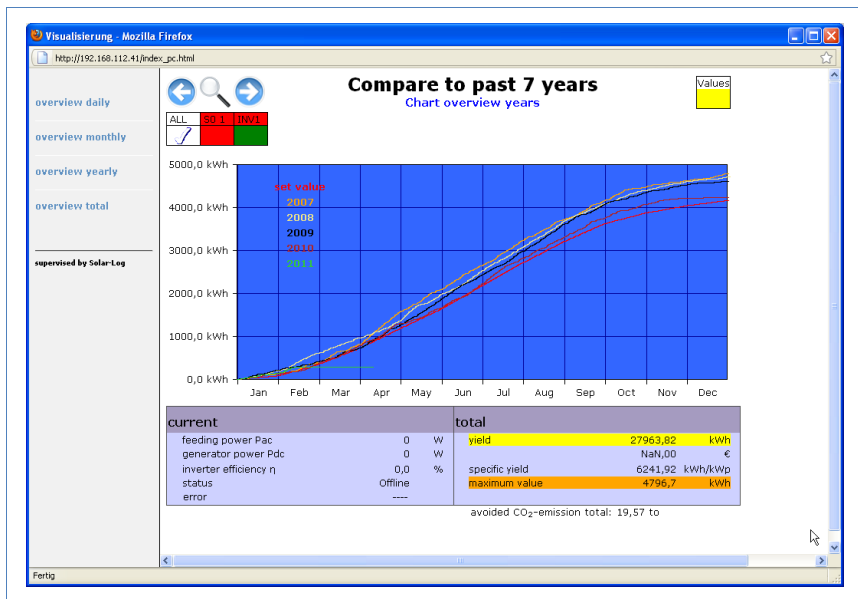

- 4 Click on **Chart overview, years** to display a bar view for the total yield.

2.4 Calling up yield data on a mobile computer

You can also call up the current yield data for your plant via mobile computer (e.g. smart phone). To do this your smart phone logs onto the internet or your local server and calls up your data.



Note

This function is only available in the local network or for plants which run on our "Classic 1 Server".

Please note that additional costs for the internet connection may be charged by your mobile service provider.

- 1 Start the web browser on the mobile computer and enter "solar-log" or the IP address for the Solar-Log™ in the address line of the browser or select the bookmark in the browser's navigation bar.
→ The homepage is displayed.
- 2 Select **PDA/Pocket PC** in the left navigation bar.

2.4.1 Day

- ▶ Select **Day** in the left navigation bar.

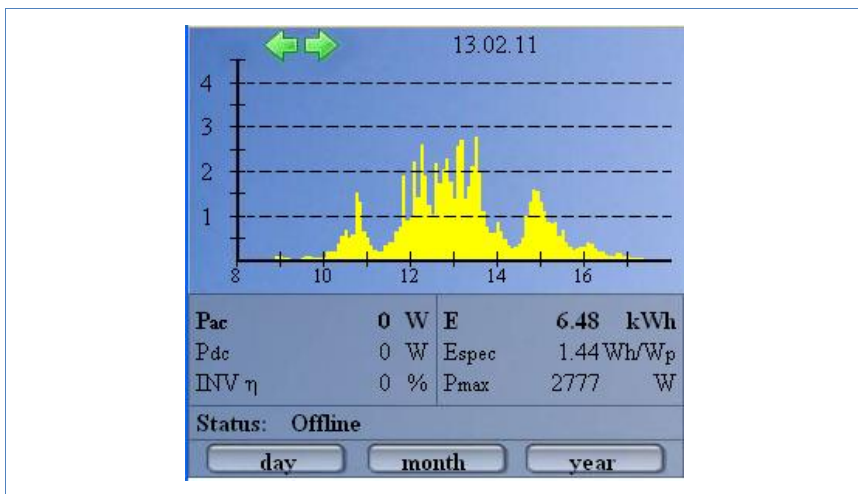

The updated yield data for the day is shown.

2.4.2 Month

- ▶ Select **Month** in the left navigation bar.

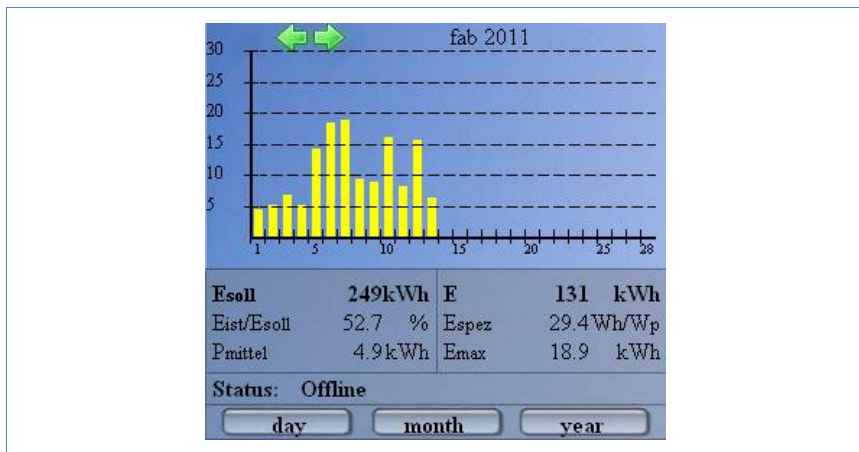

The yield data for the current month is shown.

2.4.3 Year

- ▶ Select **Year** in the left navigation bar.

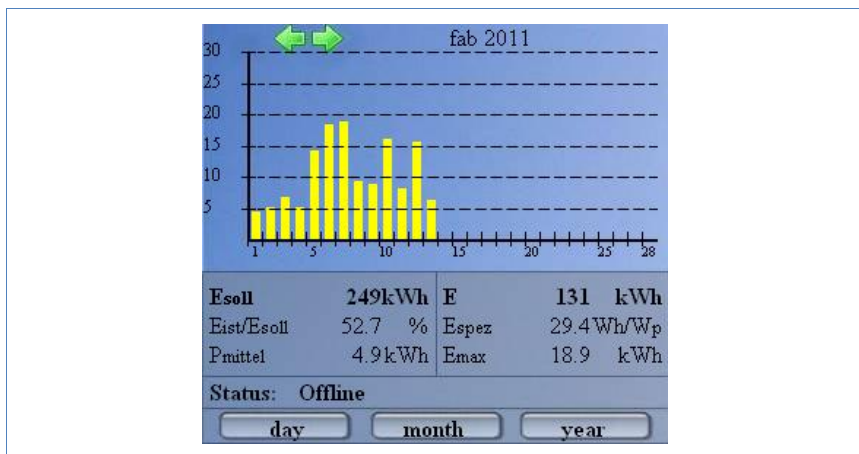

The yield data for the previous year is shown.

2.5 Calling up the diagnosis function

With the diagnosis function you are accessing the device's event log. You can display a total overview of all of the errors, malfunctions and status changes that have occurred for the connected inverters. You can also filter them according to your desired criteria.

Moreover, the diagnosis menu also shows you the decrease in output ("degradation") of your plant.

- 1 Start the web browser and enter "solar-log" in the address line of the browser or select the bookmark in the browser's navigation bar.
→ The homepage is displayed.
- 2 Select **Diagnosis** in the main navigation menu.
→ The event log is shown.

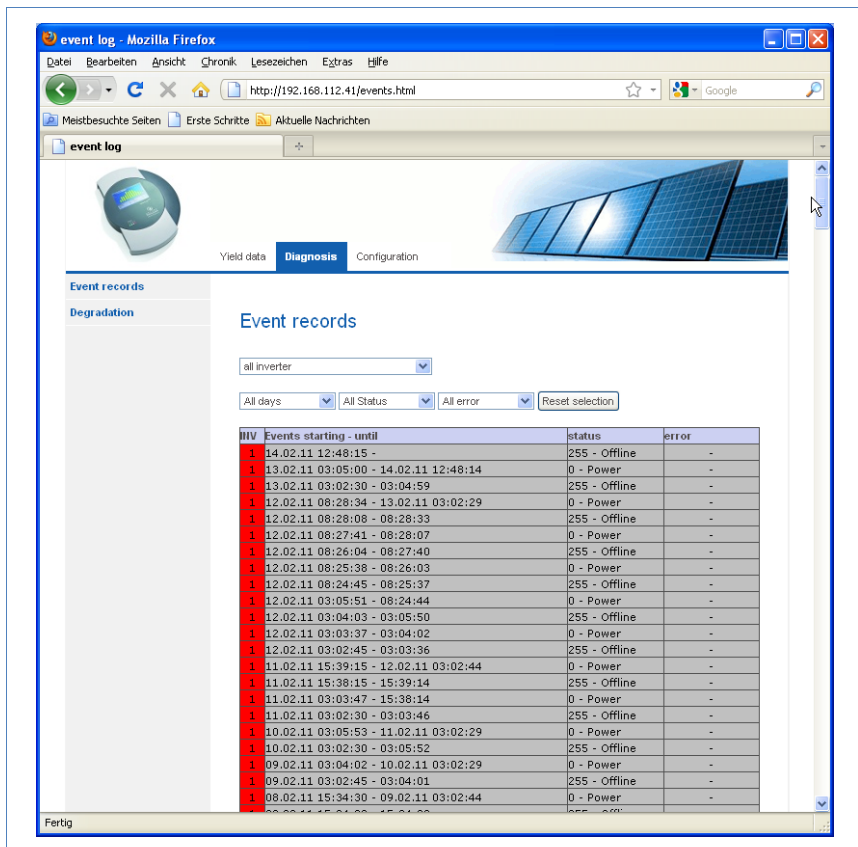

2.5.1 Calling up and filtering the event log

- ▶ Select **Even log** in the left navigation bar.
 - The complete list of all system events is shown.

The screenshot shows the 'event log' web interface. The browser window title is 'event log - Mozilla Firefox'. The address bar shows the URL: `http://192.168.112.41/events.html?inv=1&grp=1&day=100211&stat=1&err=`. The page has a navigation bar with 'Yield data', 'Diagnosis', and 'Configuration'. The 'Diagnosis' section is active, showing 'Event records'. A filter menu is open, showing 'all inverters' selected. Below the filter, a date dropdown is set to '10.02.11'. A table of event records is displayed with columns for 'Inverter', 'Time', 'Status', and 'Error'. The table shows various events for the selected date and inverter, including power, offline, and error states.

Inv - until	status	error
05:53 - 11.02.11 03:02:29	0 - Power	-
02:30 - 03:05:52	255 - Offline	-
04:02 - 10.02.11 03:02:29	0 - Power	-
30:45 - 11.02.11 07:57:32	255 - Offline	-
30:30 - 17:30:44	6 - Riso	-
21:00 - 17:30:29	2 - Netzueb.	-
20:15 - 17:20:59	6 - Riso	-
19:45 - 17:20:14	3 - Warten	-
19:00 - 17:19:44	6 - Riso	-
18:15 - 17:18:59	3 - Warten	-
15:15 - 17:18:14	7 - Mpp	-
14:30 - 17:15:14	2 - Netzueb.	-
14:00 - 17:14:29	6 - Riso	-
13:30 - 17:13:59	3 - Warten	-
13:00 - 17:13:29	7 - Mpp	-
10.02.11 07:54:00 - 07:54:29	2 - Netzueb.	-
10.02.11 07:52:45 - 07:53:59	6 - Riso	-
10.02.11 07:42:45 - 07:52:44	2 - Netzueb.	-
10.02.11 07:42:15 - 07:42:44	6 - Riso	-
10.02.11 07:42:00 - 07:42:14	3 - Warten	-
10.02.11 07:41:30 - 07:41:59	1 - Stop	-
10.02.11 07:41:17 - 07:41:29	0 - Offret	-

To display only certain events or events that occurred on a certain day in the previous 35 days, use the filter function.

- 1 Select the desired inverter in the **All inverters** drop-down menu.
→ Only the events for the selected inverter are shown.
- 2 Narrow down the selection by selecting the desired day in the **All days** drop-down menu.
→ Only the events for the selected day are shown.
- 3 Narrow down the selection further by selecting the desired status in the **All statuses** drop-down menu.
→ The only statuses available are those which occurred within the selected period of time.

- 4 Narrow down the type of error by selecting the desired error in the **All errors** drop-down menu.
→ Only those errors are shown which occurred within the selected period of time.
- 5 Click on **Reset selection** to cancel all of the filter settings.

2.5.2 Displaying the decrease in output for your plant

To obtain an overview of the total output for the previous years and the current performance, the device offers a tabular view.

- 1 Start the web browser and enter "solar-log" in the address line of the browser or select the bookmark in the browser's navigation bar.
→ The homepage is displayed.
- 2 Select **Diagnosis** in the main navigation menu.
- 3 Select **Degradation** in the left navigation bar.
→ Your plant's decrease in performance is shown.

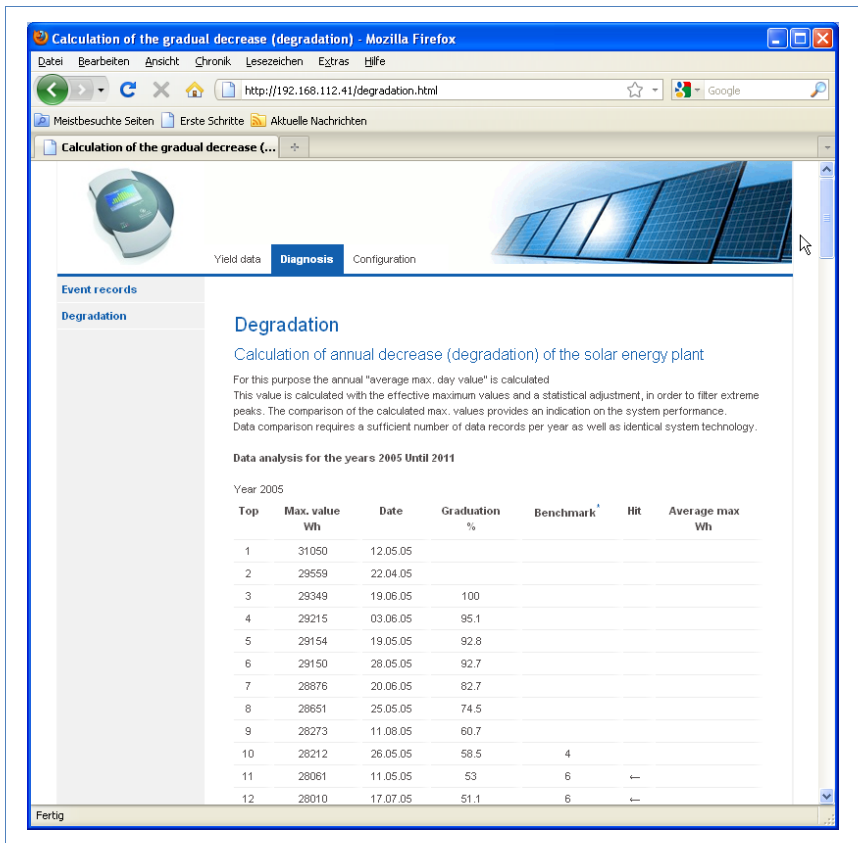

The performance of your modules decreases gradually over the years. Depending on the quality of the modules, this leads to a continuous reduction in the total yield of your plant, so-called "degradation".

To this end the "average maximum day value" is calculated for each year. It is calculated from the actual maximum values and a statistical adjustment to filter out extreme peaks. The comparison of these calculated maximum values allows conclusions to be drawn regarding the performance on the plant.

2.6 Changing settings in the configuration menu

The configuration menu allows you to make changes and adjustments to the device software. The device should have been put into service and fully configured by your solar technician. However, you may like to make changes at a later date, such as changing your password or the network settings (because you want to use a new router, for example), etc.

- ▶ To make changes to the configuration please contact your solar technician.
- ▶ If you would like to make changes yourself, obtain the installation manual that is available for download from our internet site ([↗page 60](#)).

3 Showing performance data on the display

Besides controlling the Solar-Log via the Web browser Solar-Log500 also has a 2 line text display. With this display you can view actual performance values.

Following values are displayed on the device, changing regularly:

Description	Unit	Meaning
Power input Pac	W	The current power input P on the AC voltage side
Generator output Pdc	W	The current power input P on the DC voltage side (solar generator) If only one multi string inverter is selected, all individual strings will be displayed separately
EDay	kWh	Day yield
Espez	Wh/Wp	The energy yield divided by the maximum output. This value is a good reference value with respect to other plants.

4 Using Solar-Log WEB

You can also use Solar-Log™ WEB to call up the yield data and event logs for your plant via the internet, as well as set up a daily email containing the yield and fault reports to be sent out to an email address. To do this you need a Solar-Log™ WEB account.

In addition to this option we also offer further levels of expansion with a corresponding range of service to fulfil every requirement. For further information, contact your solar technician directly or visit the following address

<http://www.solar-log.com/en/products-solutions/solar-log-web.html>

4.1 Register with Solar-Log™ WEB "Classic 2nd Edition"

Registration for the Solar-Log™ WEB "Classic 2nd Edition" takes place quickly and simply online.



Information

It is important to note that the following addresses are for the German "Classic 2nd Edition". To determine which address to visit for your country ask your installer or visit

<http://www.solar-log.com/?L=1> for more information

I ADDED THE ABOVE AS I THOUGHT IT WAS NECESSARY TO MENTION. DELETE THIS COMMENT BEFORE PRINT

- 1 Open the browser and navigate to the Solar-Log™ WEB registration page under

<http://home2.solarlog-web.eu/register.html>

Or open the homepage under

<http://home2.solarlog-web.eu/willkommen.html>

- 2 Select **Registration** in the left navigation bar.
→ The registration form is shown.

- 3 Enter the **Serial number** of your device.
→ The serial number (SN) can be found under the top cover (↗page 59).
- 4 Select whether you would like the data to be **Publicly visible** to the internet.
→ Your plant information is then able to be viewed by other visitors to the site. If you select "No", you must log in using the user data

that you receive from Solare Datensysteme GmbH in the course of the registration process ([page 31](#)).

→ The "publicly visible" setting can be changed at any time afterwards on your website in the "Configuration" area.

- 5 Enter your **Location data** and your **Contact information**.
- 6 Confirm acceptance of the General Terms and Conditions (**AGB**) and the **Privacy Policy** after you have read them.
- 7 Enter the **Code word** shown in the chart in order to ensure that no automated programs (Bots) are performing the registration which could then paralyze the server.
- 8 Confirm your entries by pressing **Register now**.
 - If you have not entered a code word or have entered the code word incorrectly, a new code word is automatically displayed and you do not need to re-enter your data.

On successful completion of your registration you will receive an email sent to your designated email address which you must confirm. After your data has been manually checked your access will be granted.



Note

The activation takes place during normal business hours and can take up to 24 hours.

4.2 Calling up plant data

- ▶ In the browser, open the homepage for Solar-Log™ WEB or enter the URL in the address line of the browser:

http://home2.solarlog-web.de/

→ The homepage is displayed.



Logging in to Solar-Log™ WEB

If you have refused "visibility to all" when registering, you must log in to the Solar-Log™ WEB internet site. If your plant is visible to all, you can skip the log in.

- ▶ In the header enter your **User** and **Password** information and click on **Log On**.

Calling up the plant overview

All of the plants are shown in the overview. The plants are anonymous. You can directly display the plants that are visible to all under the day chart.

Plant data that has been given a password can only be called up by registering.

- ▶ Select **Plants** on the left navigation menu

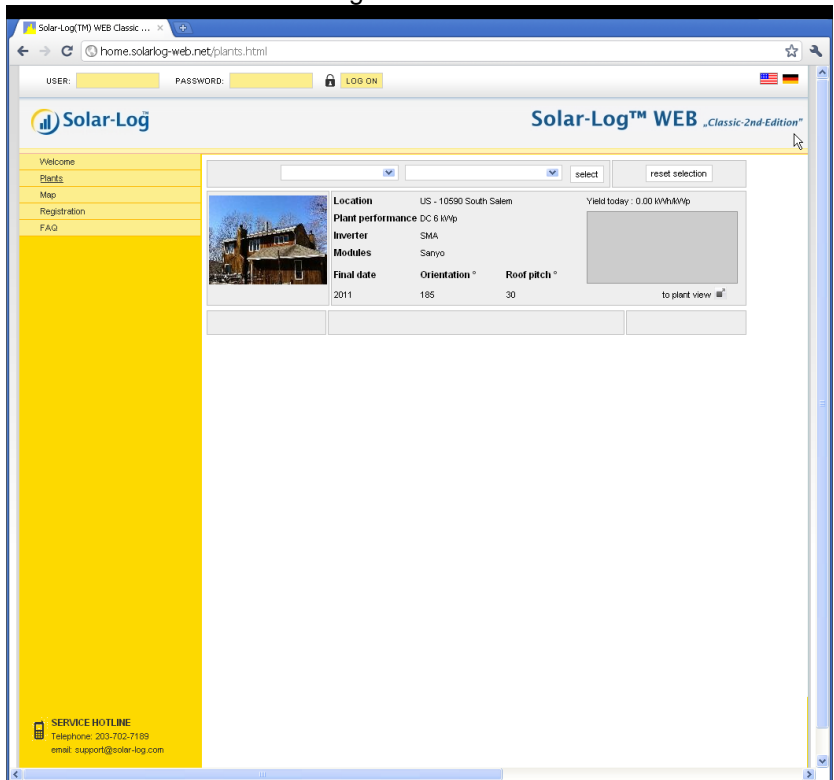

- 1 Select the **Zip Code** of your location, **Inverter** manufacturer, **Final Date** of installation or the manufacturer of the **Modules** in your plant.

- Click on **Select** to filter the list according to the criteria selected or click on **Reset selection** to cancel the selection criteria.
→ A list of plants is shown that correspond with the filter criteria.

The screenshot shows the Solar-Log WEB Classic 2nd Edition interface. The browser address bar displays 'home.solarlog-web.net/plants.html'. The page features a navigation menu on the left with options like 'Welcome', 'Plants', 'Map', 'Registration', and 'FAQ'. The main content area includes a search bar with 'ZIP Code' set to 'US - 10590' and buttons for 'select' and 'reset selection'. Below this, a plant overview is displayed with a photo of a house and the following details:

Location	US - 10590 South Salem		Yield today : 0.00 kWh/kWp
Plant performance	DC & kWp		
Inverter	SMA		
Modules	Sanyo		
Final date	Orientation °	Roof pitch °	to plant view
2011	185	30	

At the bottom left, there is a 'SERVICE HOTLINE' section with the telephone number 303-702-7199.

The overview shows the installed inverters, their output, module manufacturer, year of manufacture, orientation and the roof slope of the plants. If no picture of the plant has been made visible to all, a standard image is shown.

In addition, in the right column you can find an overview of the plants' current yield.

- Click on **to plant view** below the yield diagram.
→ The detailed overview of the plant is shown.

The screenshot displays the Solar-Log WEB Classic 2nd Edition interface. The browser address bar shows 'home.solarlog-web.net/50.html'. The page features a yellow navigation menu on the left with options like 'Welcome', 'Plants', 'Map', 'Zip Code 0*', 'Zip Code 1*', 'Lands, Dates', 'Graphics', 'Events', 'Registration', and 'FAQ'. The main content area includes a large image of a wooden house, a 'present' status box with 'Last data transfer' information, and a 'Plant status' box showing 'Status: 1X Mpp' and 'error: -----'. Below these are tables for 'Plant performance', 'Location', 'Inverter', and 'Modul'.

Plant performance		DC 8 Mpp	Location
Orientation *		185	US - 10590 South Salem
Roof pitch/slope *		30	

Inverter		
Count	Manufacturer	Type
1	SMA	SEK000US

Modul		
Count	Manufacturer	Type
1	Sanyo	195-HT (mono)

SERVICE HOTLINE
 Telephone: 203-702-7189
 email: support@solar-log.com

The detailed overview shows additional technical details about the plant as well as the plant status including any error messages that have occurred.

- 4 To navigate directly to the plant details, place a bookmark in your browser.

4.3 Calling up yield data

4.3.1 How to navigate within the overviews

The navigation on the internet site for the overviews is similar to the navigation on the overview pages in your local network ([↗page 10](#)).

Switching between the overviews

- 1 Move the cursor onto the small triangle on the left next to the display for the period of time.
→ An overview of the time periods is shown.

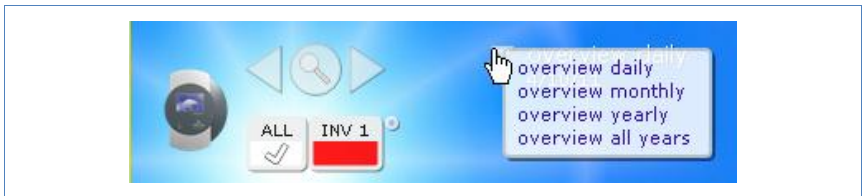

- 2 Click on the desired time period.
→ The overview of the time period is shown.

4.3.2 What the values in the overviews mean

The values provided below the diagrams are similar to the values on the overview pages in your local network ([↗page 11](#)).

Any information regarding revenue is not shown on the internet site for reasons related to privacy.

4.3.3 Day overview

- 1 Open the browser and click on the bookmark for your plant.
→ You may have to log in ([↗page 31](#)).

→ The detailed overview of your plant is shown.

2 Select **Graphics** in the left navigation bar.

→ The day overview of the plant is shown.

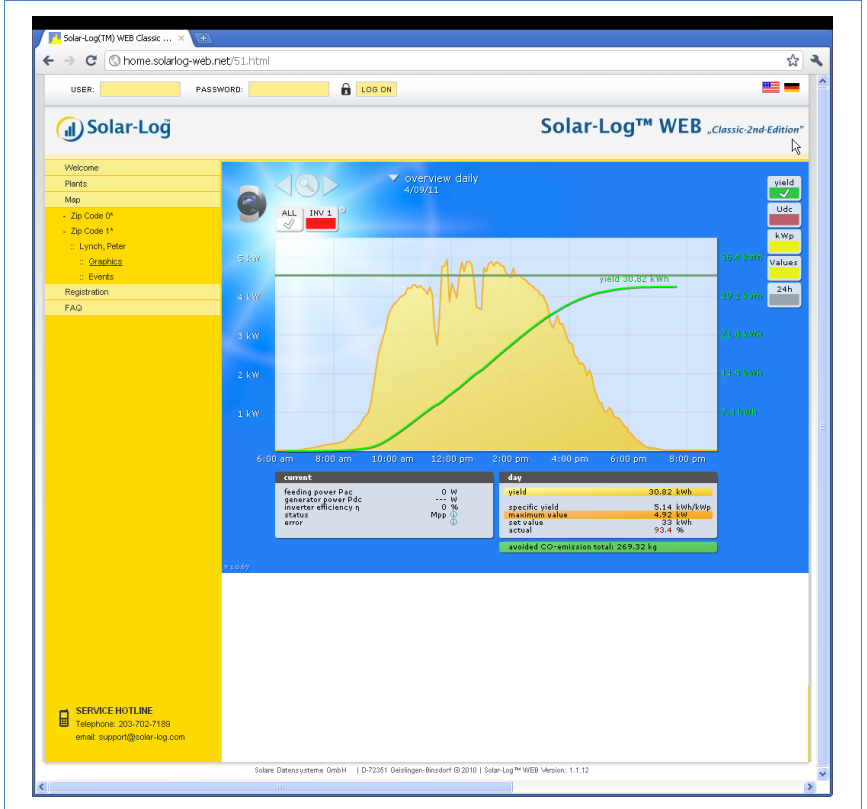

The daily yields are shown in a curve chart. The dark green line shows the target value for the day.

Move the cursor over the curves to display the corresponding values.

Buttons for the day overview

- **Yield:** Yield line via which the yield trend can take place. In addition, a dark green line is displayed as the total daily target.

- **Udc:** Generator voltage. To display voltage of the individual strings only one inverter may be selected.
- **kWp:** Converting the scaling from "Output in watts" to "Output in kWh/kWp". This makes all of the curves comparable in terms of their specific output. This also makes it easier to identify decreased outputs from specific inverters/strings.
- **24h:** Display showing the output over 24 hours of the day for a complete visualisation of the power consumption over the course of one day

Additional functions using S0 meter reader

The following displays are also available to you by connecting an S0 meter reader to the Solar-Log™:

- **S0:** Shows the power consumption for your building as a graph in watts.
- **Cons.:** Shows the power consumption for your building as a rising line in kWh.
- **Values:** Shows various values for your inverter in text form.
- **Balance:** Shows you the ratio of your power consumption to your power yield. In the lower left text field the ratio is also shown as a percentage.

Additional functions with the sensor box

- **Solar:** Shows the reference value of an irradiation sensor. The daily output of the plant must be within the measuring range of the sensor.
 - **Mod T:** Shows the module temperature. The temperature is detected by the sensor box.
- 3 Click on one of the buttons and then on the magnifying glass symbol.
→ The selected curve is shown.

4.3.4 Month overview

- ▶ Select **Overview Monthly** in the navigation menu.

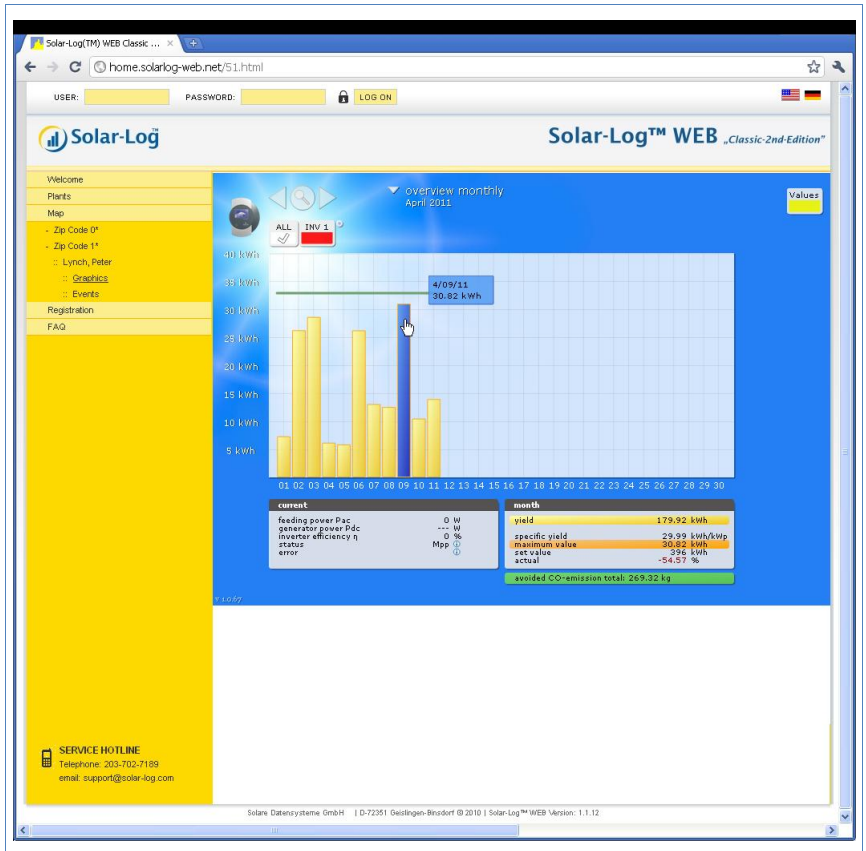

The daily yields for one month are shown as a total in a bar graph. The dark green line shows the target value for the month.

- 1 Move the mouse over a day bar.
→ The corresponding day's yield is shown.
- 2 Click on an individual bar to switch to the corresponding day overview.

4.3.5 Year overview

- ▶ Select **Overview Yearly** in the navigation menu.

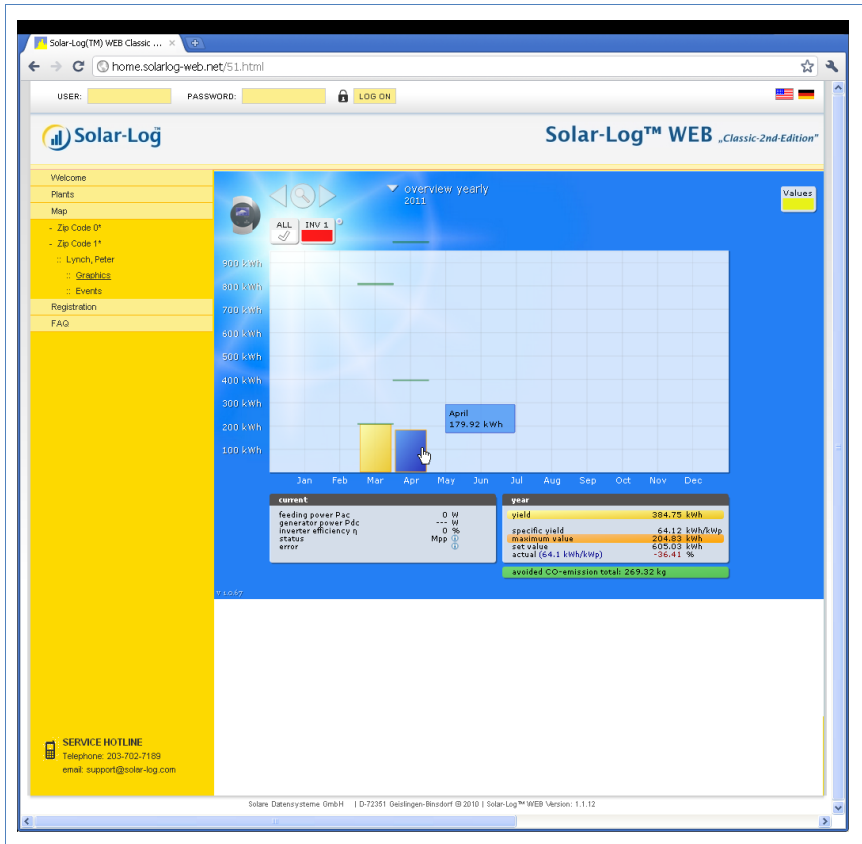

The individual monthly yields are shown as a total in a bar graph. The dark green line shows the target value for the month.

The "Forecast" value is calculated using the yields already achieved for the year and is then projected using the target yields for the remaining months of the year.

- 1 Move the mouse over a month bar.
→ The corresponding month's yield is shown.
- 2 Click on an individual bar to switch to the corresponding month overview.

4.3.6 Overview of all years

- ▶ Select **Overview all years** in the navigation bar.

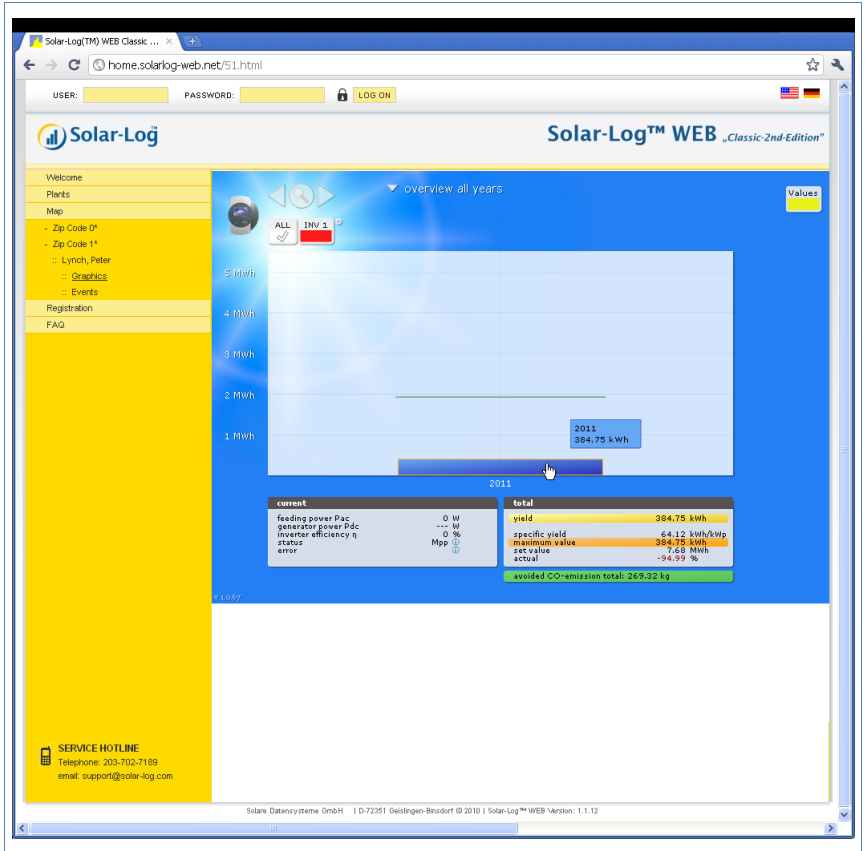

The individual annual yields are shown as a total in a bar graph. The dark green line shows the target value for the year. For the current year two green lines are shown:

- The top line shows the annual target.
 - The bottom line shows the annual target accumulated to the present day.
- 3 Move the mouse over a year bar.

- The corresponding year's yield is shown.
- 4 Click on an individual bar to switch to the corresponding year overview.
- 5 Click on **Line overview, years** to display a line view for the total yield.

4.3.7 Calling up and filtering the event log

- ▶ Select **Events** in the left navigation bar.
- The complete list of all system events is shown.

The screenshot shows the Solar-Log WEB interface. The left navigation bar has 'Events' selected. The main content area displays a table of events for inverter 10 from 02.04.2011 to 12.04.2011. The table has columns for Inverter, Events from - to, Status, and Error. The events are listed as follows:

Inverter	Events from - to	Status	Error
10	11.04.2011 07:44:45 - 07:44:59	6 - Mpp-Search	-
10	11.04.2011 07:34:45 - 07:44:44	7 - Mpp	-
10	11.04.2011 07:34:30 - 07:34:44	6 - Mpp-Search	-
10	11.04.2011 07:24:30 - 07:34:29	7 - Mpp	-
10	11.04.2011 07:24:00 - 07:24:29	6 - Mpp-Search	-
10	11.04.2011 07:14:00 - 07:23:59	7 - Mpp	-
10	11.04.2011 07:13:45 - 07:13:59	6 - Mpp-Search	-
10	11.04.2011 07:13:30 - 07:13:44	2 - Grid monitoring	-
10	11.04.2011 07:13:15 - 07:13:29	3 - Vlling	-
10	11.04.2011 07:12:15 - 07:13:14	7 - Mpp	-
10	11.04.2011 07:12:00 - 07:12:14	6 - Mpp-Search	-
10	11.04.2011 07:11:30 - 07:11:59	2 - Grid monitoring	-
10	11.04.2011 07:11:15 - 07:11:29	6 - Mpp-Search	-
10	11.04.2011 07:10:45 - 07:11:14	2 - Grid monitoring	-
10	11.04.2011 07:10:30 - 07:10:44	7 - Mpp	-
10	11.04.2011 07:10:15 - 07:10:29	6 - Mpp-Search	-
10	11.04.2011 07:10:00 - 07:10:14	2 - Grid monitoring	-
10	11.04.2011 07:09:45 - 07:09:59	3 - Vlling	-
10	11.04.2011 07:09:30 - 07:09:44	6 - Mpp-Search	-

To display only certain events or events that occurred on a certain day in the previous 35 days, use the filter function.

- 1 Select the desired inverter in the **All inverters** drop-down menu.
→ Only the events for the selected inverter are shown.
- 2 Narrow down the selection by selecting the desired day in the **All days** drop-down menu.
→ Only the events for the selected day are shown.

- 3 Narrow down the selection further by selecting the desired status in the **All status** drop-down menu.
 - Only those statuses are available which occurred within the selected period of time.
- 4 Narrow down the type of error by selecting the desired error in the **All errors** drop-down menu.
 - Only those errors are shown which occurred within the selected period of time.
- 5 Click on **Reset selection** to cancel all of the filter settings.

5 Using the Solar-Log™ APP for iPhone

In order to allow you mobile access to your plant data, we offer you a Solar-Log™ APP for iPhone, iPad and iPod Touch. The app can be downloaded free of charge from Apple's app store.

The app shows you current and past yield data in chart form. Using the intuitive operation you can quickly navigate between day, month, year and total overviews.

Requirements

Our Solar-Log™ APP is compatible with all versions of iPod Touch, iPhone and iPad firmwares from system version iOS 3.0 and upwards.

The Solar-Log™ APP works with any server solution from Solare Datensysteme GmbH.

5.1 Installing the app

You can obtain the app free of charge from the app store.

Downloading the app

- 1 Look for "Solar-Log" in the [App store](#).
- 2 Follow the instructions for download and installation on your iPhone, iPad or iPod Touch.

Starting the app



- 3 Start the app on your iPhone, iPad or iPod Touch.
→ The start screen is shown.

5.2 Adding plants

You can use the app to monitor any of up to 10 that are each connected to a Solar-Log™.

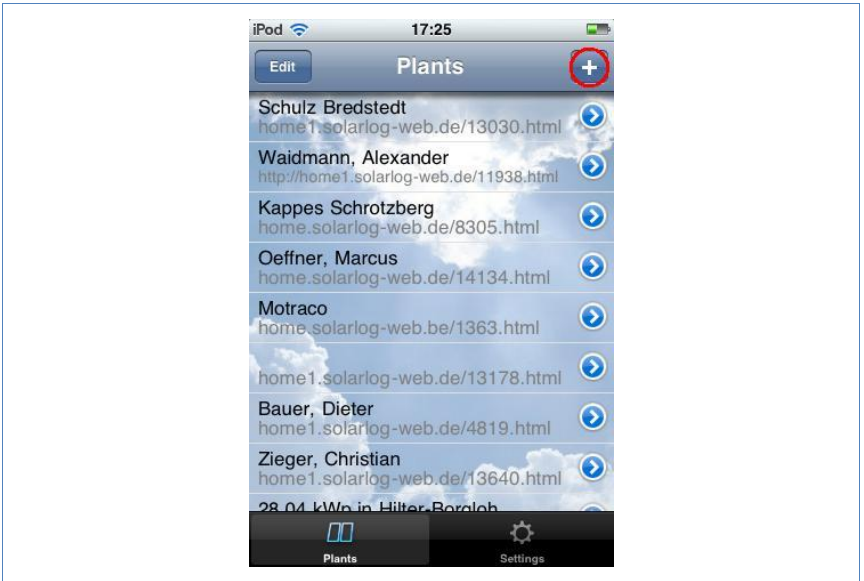

- 1 Click on the + symbol.
→ The **New plant** view is shown.



2 Select the **Service Type** of the server:

- **Home.** Your plant is located on the Classic 1 server.
- **Web.** Your plant is located on the Classic 2 server.
- **Local.** You can call up the data directly from your Solar-Log™ in the local network.

Home

1 Enter the complete **URL** of your Solar-Log™ website, for example

www.solarlog-home.de/myPlant

2 **Save** the entry for the plant.

Web



- 1 Enter the **URL**, **Serial number** and **Password** that you received in the registration email from Solare Datensysteme GmbH.
- 2 **Save** the entry for the plant.

Local



- 1 Enter the IP address of the Solar-Log™ as a **URL**.
- 2 **Save** the entry for the plant.

5.3 Calling up yield data

If your plant has been correctly recognised it is shown in the overview.



Note

Please note that the data is only updated if your iPhone, iPad or iPod Touch has an existing internet connection.

5.3.1 How to navigate within the overviews

Tap on the screen to obtain a menu on the lower edge of the picture in which you can select the desired overviews.



5.3.2 What the values in the overviews mean

The values provided in the diagrams correspond to the values on the overview pages in your local network (➔page 11).

- ▶ In the views tap on **Stats** to show the current values for each view.

5.3.3 Day overview

- 1 Start the app.



- 2 Tap on the blue arrow key next to the name of your plant.
→ The current day overview is shown.

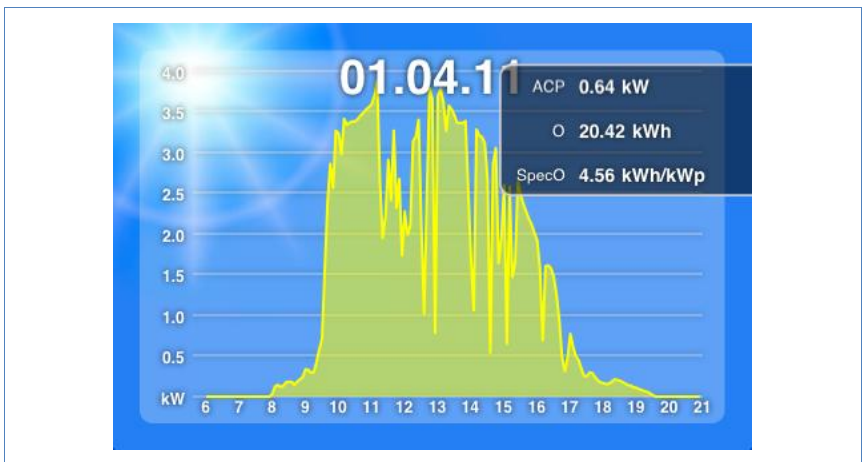

The yields for the selected day are shown as a curve.

- 3 Turn your iPhone, iPad or iPod Touch horizontally to obtain a better view.
- 4 Swipe to the left or right to go to the next or previous overview.

5.3.4 Month overview

- 1 Tap the screen.
→ The overview navigation menu is shown on the lower edge of the screen.
- 2 Select **Month** to go to the month overview.

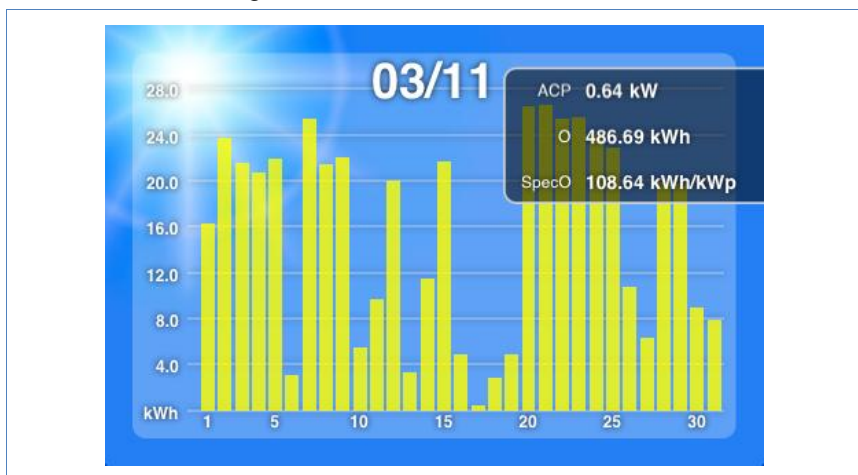

The yields for the selected month are shown as a bar.

- 3 Swipe to the left or right to go to the next or previous overview.

5.3.5 Year overview

- 1 Tap the screen.
→ The overview navigation menu is shown on the lower edge of the screen.
- 2 Select **Year** to go to the year overview.



The monthly yields for the selected year are shown as a bar.

3 Swipe to the left or right to go to the next or previous overview.

5.3.6 Total overview

- 1 Tap the screen.
→ The overview navigation menu is shown on the lower edge of the screen.
- 2 Select **Total** to go to the total overview.



- 3 Swipe to the left or right to go to the next or previous overview.

5.4 Calling up data

- 1 Tap the screen.
→ The overview navigation menu is shown on the lower edge of the screen.
- 2 Select **Data** to go to the data view.

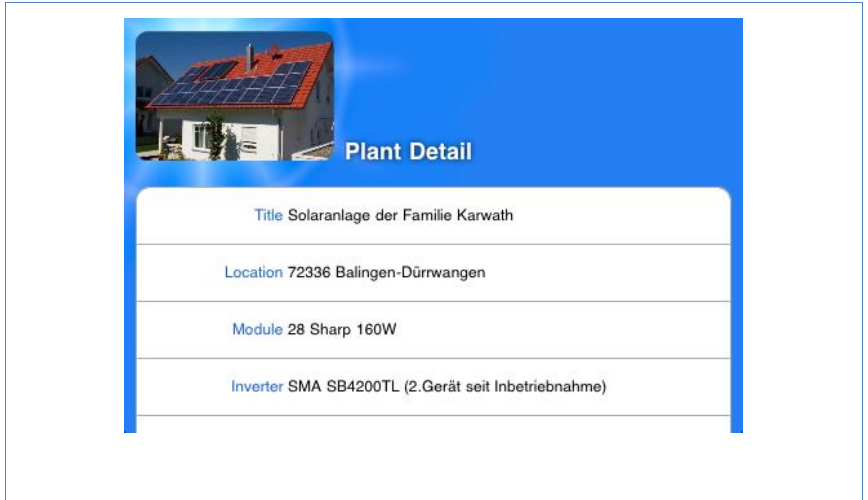

The data view shows you the owners, the location of the plants, the installed modules and inverters as well as output and orientation of the plant and the date of its commissioning entered.

5.5 Calling up CO₂ savings

- 1 Tap the screen.
→ The navigation menu is shown on the lower edge of the screen.
- 2 Select **CO₂**.
→ The total accumulated amount of carbon dioxide emissions that have been prevented by your plant is shown.



The saving shown is calculated using the quantity of carbon dioxide that would have been created in order to generate the same amount of energy using fossil fuels.

5.6 The yield data as a slide show

You can use the slide show function to turn your iPod Touch or your iPad into an "electronic picture frame". This "picture frame" shows in rotation the various overviews contained within the Solar-Log™ app.



Note

You can find suitable holders (cradles) for mounting the devices in specialist stores.

- 1 Tap the screen.
→ The slide show function is shown on the upper edge of the screen.



- 2 Select **Slide show** and place the iPad or iPod Touch in a cradle.
 → Now you are able to read off the updated values at any time.

6 Cleaning and care

6.1 Cleaning tips



Caution

Be sure to unplug the device prior to cleaning it!

- ▶ Clean the device on the outside only with a dry, lint-free cloth.
 - ▶ If very dirty, the device can be cleaned with a slightly damp cloth and a commercially available household cleaner.
-



Caution

When cleaning, ensure that no moisture enters the device!

6.2 Care tips

- ▶ Ensure that the device is not exposed to any moisture at the location where it is kept.
- ▶ Ensure that the device is not exposed to any heat or strong sunlight at the location where it is stored.
Please take note of the Technical Data ([↗](#)page 62).

7 Malfunctions

7.1 Status display for the LEDs

On the front side of the device in the lower left area there are four LEDs that show the operating status of the device.

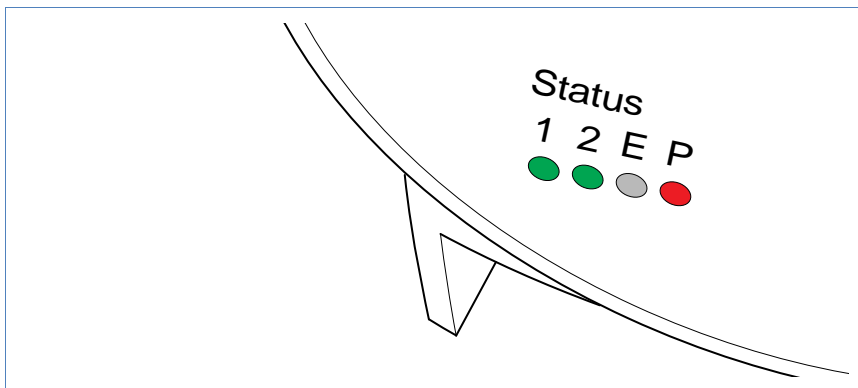

Depending on the operating status, LED 1, LED 2, and LED E can flash quickly or slowly, be permanently illuminated or not be illuminated.

The red LED P indicates the power supply.

The LED E is generally not illuminated during normal fault-free operation. If it is illuminated or flashing, this indicates that a system malfunction has occurred.

Normal operation

Normal operation			
LED 1	LED 2	LED E	Meaning
quickly	quickly	off	Max. 5 min.: Device starts
illuminated	slow	off	Import time via internet
off	quickly	off	Read configuration from inverter

Normal operation			
illuminated	illuminated	off	Normal operation, inverter online
illuminated	off	off	Normal operation, inverter offline

System malfunctions

System malfunctions			
LED 1	LED 2	LED E	Meaning and possible remedy
quickly	quickly	off	For 5 min. during initialization: Error! <ul style="list-style-type: none"> ▶ Unplug power plug and plug in again.
illuminated	slow	slow	Import time via internet failed: <ul style="list-style-type: none"> ▶ Set time manually ▶ Check internet access
off	slow	slow	Configuration invalid or nonreadable: <ul style="list-style-type: none"> ▶ Check interface ▶ Check cable ▶ Perform re-start (7page 60)
		illuminated	Only for Fronius inverters: No data communication! <ul style="list-style-type: none"> ▶ Wait until inverters import ▶ Check wiring
		quickly	Plant has signalled a fault.

7.2 Remediating faults yourself

You can remedy faults yourself by restarting the device. A restart is necessary if the device no longer reacts to entries in the web browser. All of the settings made on the device remain in place, as does the saved yield data.

To restart the device, use the reset button at the top of the device.

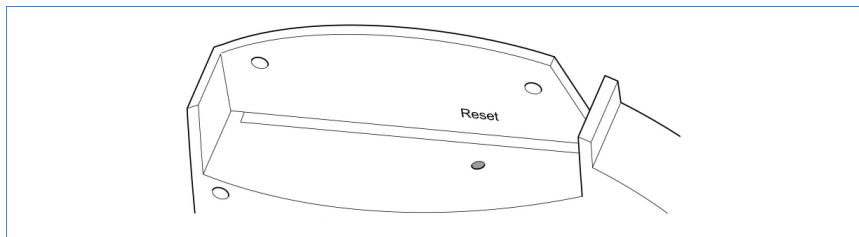

Opening the cover

If the cover is fitted, you must first open the cover of the device.

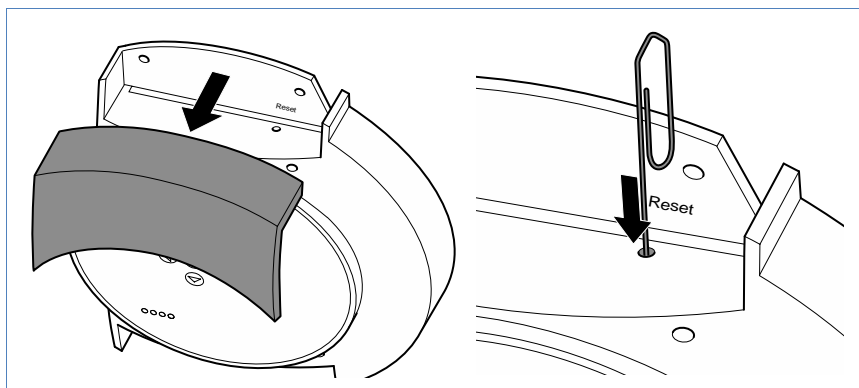

- ▶ Pull the cover frontwards to remove.

Performing a restart

- 1 Press the reset button e.g. with an open paper clip.
→ LED 1 goes out.
- 2 Release the reset button.
→ After approx. 5 seconds LED 1 illuminates again.
→ After approx. 20 seconds LED 1 and LED 2 start to flash, the device restarts with the set values.
- 3 Wait until normal operation has recommenced and then close the cover.



Caution

Do not perform a restart by pulling out the power plug!

7.2.1 Obtaining information from the internet

You can also obtain support for operating the device or the settings on our internet site under the following URL:

<http://www.solar-log.com/en/service-support/technical-support.html>

Here you will also find additional product information and manuals available for download.

7.2.2 Informing a specialist technician

Should problems occur with the Solar-Log⁵⁰⁰ that are not able to be remedied using the measures described, we recommend that you contact your solar technician or our customer service.

The contact addresses for our customer service can be found on the back of the envelope.

8 Disposal



Caution

Your Solar-Log™ contains electronic components that can release highly toxic substances if burned or disposed of via the domestic garbage disposal system.

- ▶ Be sure to dispose of the Solar-Log™ in a recycling center as electronic scrap.

9 Technical data

Supply voltage	12V DC (24V DC max)
Energy consumption	approx. 3 watts
Power supply	External wall power supply 12V DC
Dimensions in cm	22.5 / 28.5 / 4 (W x H x D)
Housing	Plastic housing, passively ventilated
Interfaces	Ethernet RJ45 bushing 10/100MBit RS485/RS422 combined S0 impulse in/output (in accordance with DIN43864 and DIN62056) Reset buttons
Memory capacity	8 MB RAM + 2 GB SD RAM (internal only)
Protection class	IP 20 (exclusively for inside use)
Temperature range	-10°C to 50°C
Display	4 LEDs for status displays
Mounting	Wall mounted
Weight	0.61 kg

Glossary

Term	Meaning
Account	User account on a server into which the user must log with their name and password.
App	Abbreviation for application, programme
Back-up	Data back-up A method of archiving or to ensure against loss of data.
Browser, web browser	Programme used to display internet sites in the worldwide web
Derating	Loss in power of an electronic component depending on the surrounding temperature, e.g. decrease in output delivered in order to protect against overheating.
DHCP	Dynamic Host Control Protocol. Characteristic setting in local networks in which the IP addresses for the connected devices are assigned by the router.
Firmware	Operating system for your device
Gateway	Router that serves as a "gateway" for network access from outside, e.g. via the internet.
iOS	iOS is an operating system from Apple for mobile devices.
IP address	Network address for the device. Each device in the network is identified by its own number. This number consists of four blocks of maximum three figures. The network address is usually assigned by the router.
Local network	Several computers or network-compatible devices that exchange data with one another within a closed area.

Term	Meaning
MPP	The Maximum Power Point (MPP) is the point of maximum output. It is not constant but depends on the irradiation intensity, the temperature and the type of solar cells.
PDA	Personal Digital Assistant, a form of mobile computer
Server	Computer in the local network or internet which provides the available data to authorised users.
SMS	Short Message Service. Transfer of short messages in text form. They can be received by numerous types of mobile phones.

The copyright of these instructions remains with the manufacturer. No part of these instructions may be reproduced in any form or processed, duplicated or distributed using electronic systems without the written consent of Solare Datensysteme GmbH.

Non-compliance resulting in contradiction of the above-mentioned specifications shall result in obligation to provide compensation for damages.

All of the brands mentioned in these instructions are the property of the respective manufacturer and hereby recognised as such.



Solar-LogTM
by Solare Datensysteme GmbH

Solare Datensysteme GmbH
Fuhrmannstrasse 9
72351 Geislingen-Binsdorf
Germany

info@solar-log.com
www.solar-log.com

Version January 2011 – 1.0.0.6